



Encyclopædia
of
Religion and Ethics

Encyclopædia of Religion and Ethics

EDITED BY

JAMES HASTINGS

WITH THE ASSISTANCE OF

JOHN A. SELBIE, M.A., D.D.

PROFESSOR OF OLD TESTAMENT LANGUAGE AND LITERATURE IN THE
UNITED FREE CHURCH COLLEGE, ABERDEEN

AND

LOUIS H. GRAY, M.A., Ph.D.

SOMETIME FELLOW IN INDO-IRANIAN LANGUAGES IN COLUMBIA UNIVERSITY, NEW YORK

VOLUME VI

FICTION—HYKSOS

EDINBURGH: T. & T. CLARK, 38 GEORGE STREET

NEW YORK: CHARLES SCRIBNER'S SONS, 597 FIFTH AVENUE

PRINTED IN GREAT BRITAIN BY
MORRISON AND GIBB LIMITED
FOR
T. & T. CLARK, EDINBURGH
NEW YORK: CHARLES SCRIBNER'S SONS

4527

FIRST IMPRESSION 1913
SECOND IMPRESSION 1937
THIRD IMPRESSION 1955

[The Rights of Translation and of Reproduction are Reserved.]

AUTHORS OF ARTICLES IN THIS VOLUME

- ABRAHAMS (ISRAEL), M.A. (Lond. and Camb.), D.D. (Cincin.).**
 Reader in Talmudic and Rabbinic Literature in the University of Cambridge; formerly Senior Tutor in the Jews' College, London; editor of the *Jewish Quarterly Review*, 1888-1908.
 Heresy (Jewish).
- ALEXANDER (HARTLEY BURR), Ph.D.**
 Professor of Philosophy in the University of Nebraska.
 Good Nature.
- BACHER (WILHELM), Dr.Phil. (Leipzig), Diplom. Rabbiner (Breslau).**
 Professor und Direktor der Landes-Rabbinerschule in Budapest; Ritter des Ordens der Eisernen Krone, III Klasse.
 Genizah.
- BAIKIE (JAMES).**
 Fellow of the Royal Astronomical Society; Minister of the United Free Church at Edinburgh.
 Hyksos.
- BAILLIE (JAMES BLACK), M.A. (Edin. and Camb.), D.Phil. (Edin.).**
 Professor of Moral Philosophy in the University of Aberdeen; author of *Hegel's Logic* (1901), *The Idealistic Construction of Experience* (1906), *Hegel's Phenomenology of Mind* (1910).
 Hegel.
- BALL (JAMES DYER), I.S.O., M.R.A.S., M. Ch. Br. R.A.S.**
 Of the Hongkong Civil Service (retired); author of *Things Chinese, The Chinese at Home*, and other works.
 Hospitality (Chinese), Human Sacrifice (Chinese).
- BARNS (THOMAS), M.A. (Oxon.).**
 Vicar of Hilderstone, Staffordshire.
 Grace at Meals.
- BARTON (GEORGE AARON), A.M., Ph.D.**
 Professor of Biblical Literature and Semitic Languages in Bryn Mawr College; author of *A Sketch of Semitic Origins*, 'Ecclesiastes' in the *International Critical Commentary*, *Commentary on Job, The Origin and Development of Babylonian Writing*.
 Hierodouloi (Semitic and Egyptian).
- BAYNE (RONALD), M.A. (Oxford).**
 Rector of St. Edmund, Lombard Street, London; editor of Book V. of Hooker's *Ecclesiastical Polity, with Prolegomena and Appendices* (Macmillan's English Theological Library).
 Hooker.
- BECELAERE (E. L. VAN), Ph.D., D.D.**
 Sometime Professor of Philosophy, of Holy Scripture and of Theology (Moral) in the Dominican Convent of Studies at Ottawa (Ont.), Canada.
 Grace, Doctrine of (Roman Catholic).
- BLAKENEY (EDWARD HENRY), M.A.**
 Headmaster of the King's School, Ely; author of a *Classical Dictionary* (1910); editor of Euripides' *Alcestes* (1900), *Hercules Furens* (1904).
 Free-Thought (Additional Note).
- BLAKISTON (HERBERT EDWARD DOUGLAS), D.D.**
 President of Trinity College, Oxford.
 Graiai.
- BONET-MAURY (AMY-GASTON), Knight of the Legion of Honour, D.D. (Paris, Glas., Aber.), LL.D. (St. Andrews).**
 Professeur honoraire de l'Université de Paris; Professeur titulaire à la Faculté libre de Théologie protestante de Paris; Membre correspondant de l'Institut de France.
 Hospitality (Christian).
- BRAITHWAITE (WILLIAM CHARLES), B.A., LL.B.**
 President of the Woodbrooke Settlement, Selly Oak, Birmingham; author of *The Beginnings of Quakerism*.
 Friends, Society of.
- BRETT (GEORGE SIDNEY), M.A. (Oxon.).**
 Lecturer in Ancient Philosophy in the University of Toronto, Canada; author of *The Philosophy of Gassendi* (1908), *A History of Psychology (Ancient and Patristic)* (1912).
 Green.
- BURKITT (FRANCIS CRAWFORD), M.A., F.B.A., Hon. D.D. (Edin., Dublin, St. Andrews), D.Theol. h.c. (Breslau).**
 Norrisian Professor of Divinity in the University of Cambridge.
 Gospels.

- BURNS (ISLAY FERRIER), M.A.**
Tutor and Librarian in Westminster College, Cambridge; formerly Snell Exhibitioner at Balliol College, Oxford.
Holiness (Greek).
- BUSSELL (F. W.), Mus. Bac., D.D. (Oxon.)**
Fellow, Chaplain, Tutor, and Vice-Principal of Brasenose College, Oxford; formerly Select Preacher and Bampton Lecturer; Rector of Sizeland, Norfolk; Corresponding Member of the Société Archéologique de France.
Happiness (Greek and Roman).
- CAMPBELL (LEWIS), LL.D.**
Formerly Professor of Greek in the University of St. Andrews; author of *Religion in Greek Literature*, and other works.
God (Greek).
- CAMPBELL (WILLIAM), M.R.A.S., F.R.G.S.**
Of the English Presbyterian Mission, Formosa; Corresponding Member of the Japan Society; Foreign Member of the Koninklijk Instituut voor de Taal-, Land- en Volken-kunde van Nederlandsch-Indië; author of *A Dictionary of the Amoy Vernacular*.
Formosa.
- CAMPBELL-SMITH (MARY), M.A.**
Dundee.
Government.
- CHAMBERLAIN (ALEXANDER FRANCIS), M.A. (Toronto), Ph.D. (Clark)**
Professor of Anthropology in Clark University, Worcester, Mass.; editor of the *Journal of American Folklore* (1900-1908); author of *The Child and Childhood in Folk-Thought*, *The Child: A Study in the Evolution of Man*; co-editor of the *Journal of Religious Psychology*, and of *Current Anthropological Literature*.
Gongs and Bells (American), Haida, Heroes and Hero-Gods (American).
- CHARLES (BENSON BRUSH), Ph.D.**
Instructor in Semitic Languages in the University of Pennsylvania; Member of Cornell Expedition to Asia Minor and the Assyro-Babylonian Orient (1907-1908).
Hittites.
- COATS (ROBERT HAY), M.A., B.D. (Glasg.), B.A. (Oxon.)**
Minister of the Baptist Church at Handsworth, Birmingham; author of *Types of English Piety*.
Holiness (New Testament and Christian).
- COBB (WILLIAM FREDERICK), D.D.**
Rector of the Church of St. Ethelburga the Virgin, London, E.C.
Forgiveness (New Testament and Christian).
- COE (GEORGE ALBERT), Ph.D., LL.D.**
Professor of Religious Education and Psychology in the Union Theological Seminary, New York; author of *The Spiritual Life*, *The Religion of a Mature Mind*, *Education in Religion and Morals*.
Growth (Moral and Religious).
- COLEMAN (ALEXIS IRÉNÉE DU PONT), M.A. (Oxon.)**
Assistant Professor of English Literature, College of the City of New York.
Fiction (Mediæval and Modern).
- CORNABY (WILLIAM ARTHUR)**
Of the Wesleyan Methodist Mission, Wusueh, Hupeh, China; late editor of the *Ta Tung Pao*, Magazine for Chinese Officials and Scholars; author of *China under the Searchlight*, and other works.
God (Chinese).
- CRAWLEY (ALFRED ERNEST), M.A. (Camb.)**
Fellow of the Sociological Society; author of *The Mystic Rose*, *The Tree of Life*, *The Idea of the Soul*, *The Book of the Ball*.
Fire and Fire-gods, Fœticide, Food, Gilds, Hearth and Hearth-gods, Human Sacrifice (Introductory and Primitive).
- CROOKE (WILLIAM), B.A.**
Ex-Scholar of Trinity College, Dublin; Fellow of the Royal Anthropological Institute; President of the Anthropological Section of the British Association, 1910; President of the Folklore Society, 1911-12; late of the Bengal Civil Service.
Food for the Dead, Ganga (Ganges), Gangaikandapur, Gangotri, Garhmuktesar, Gaur, Girnar, Gobardhan, Godavari, Gokarna, Gokul, Gonda, Gosain, Gujar, Gurkha, Gwalior, Halebid, Hardwar, Hasan Abdal, Hastinapur, Heroes and Hero-Gods (Indian), Hinduism, Hinglaj, Hoa.
- CROSS (GEORGE), M.A., Ph.D., D.D.**
Professor of Systematic Theology in the Rochester Theological Seminary, Rochester, N.Y.
Heresy (Christian).
- CRUICKSHANK (WILLIAM), M.A., B.D.**
Minister of the Church of Scotland at Kinneff, Bervie.
Hospitality (Semitic).
- DAVIDS (T. W. RHYS), LL.D., Ph.D., D.Sc., F.B.A.**
Professor of Comparative Religion, Manchester; President of the Pali Text Society; Fellow of the British Academy; author of *Buddhism* (1878), *Questions of King Minda* (1890-94), *American Lectures on Buddhism* (1896), *Buddhist India* (1912), *Early Buddhism* (1908).
Hinayana, Hospitality (Buddhist).
- DAVIDS (MRS. RHYS), M.A.**
Lecturer on Indian Philosophy in the University of Manchester; Fellow of University College, London; author of *Buddhist Psychological Ethics* (1900), *Psalm of the Early Buddhists* (1909, 1913), *Buddhism* (1912).
Happiness (Buddhist).
- DAVIDSON (WILLIAM LESLIE), M.A., LL.D.**
Professor of Logic and Metaphysics in the University of Aberdeen; author of *The Logic of Definition*, *English Words Explained*, *Theism as Grounded in Human Nature*, *Christian Ethics*, *The Stoic Creed*.
Forgetfulness, Gratitude, Hatred.
- DAVIES (HENRY), B.D., Ph.D. (Yale)**
Rector of Christ Church, Easton, Maryland, U.S.A.
Form (Aesthetic).
- DAVISON (WILLIAM THEOPHILUS), M.A., D.D.**
Principal and Professor of Systematic Theology, Richmond College, Surrey.
God (Biblical and Christian).

- DEUBNER (DR. LUDWIG).**
Ordentlicher Professor für Klassische Philologie an der Universität zu Königsberg.
Fleece (Greek and Roman).
- DIELS (HERMANN), Dr. phil., med., theol., LL.D.**
(Aber., Camb., St. Andrews).
Professor of Classics in the University of Berlin; Perpetual Secretary of the Royal Prussian Academy of Sciences; Geheimer Oberregierungsrat.
Heraclitus.
- DILLING (WALTER JAMES), M.B., Ch.B. (Aber.).**
Lecturer in Pharmacology in the University of Aberdeen; formerly First Assistant in Pharmacology in the University of Rostock.
Girdle.
- DORNER (AUGUST), Dr. Theol. und Philos.**
Ordentlicher Professor an der Universität zu Königsberg.
Filial Piety.
- EDWARDS (EDWARD), B.A. (Wales and Cantab.), M.R.A.S.**
Member of the Board of Archæology, and Examiner in Persian to the University of London; Assistant in the Department of Oriental Printed Books and Manuscripts in the British Museum.
God (Iranian), Human Sacrifice (Iranian).
- FALLAIZE (EDWIN NICHOLAS COLLINGFORD), B.A. (Oxon.).**
Late King Charles Exhibitioner, Exeter College, Oxford; Recorder, Section H (Anthropology) of the British Association for the Advancement of Science.
Handicraft, Harvest, Honey, Hunting and Fishing.
- FARNELL (LEWIS RICHARD), M.A., D.Litt. (Oxford), Hon. D.Litt. (Geneva and Dublin), F.R.A.S.**
Rector of Exeter College, Oxford; University Lecturer in Classical Archæology; Hibbert Lecturer and Wilde Lecturer in Natural and Comparative Religion; corresponding Member of the German Imperial Archæological Institute; author of *The Cults of the Greek States* (1896-1909).
Greek Religion.
- FICK (DR. RICHARD).**
Oberbibliothekar an der Königlichen Bibliothek, Berlin.
Gotra.
- FORTESCUE (ADRIAN), Ph.D., D.D. (Innsbruck).**
Roman Catholic Priest at Letchworth; author of *The Orthodox Eastern Church* (1907), *The Mass: A Study of the Roman Liturgy* (1912).
Hermesianism.
- FOUCHER (A.).**
Chargé de Cours à la Faculté des Lettres; Directeur-adjoint à l'École pratique des Hautes-Études, Paris.
Gandhara.
- FOWLER (WILLIAM WARDE), M.A., Hon. D.Litt. (Manchester), Hon. LL.D. (Edin.).**
Fellow and late Subrector of Lincoln College, Oxford; Gifford Lecturer in Edinburgh University (1909-1910).
Fortune (Roman).
- FRITSCH (ADOLF), Dr. Phil.**
Professor an der Gelehrtenschule des Johanneums in Hamburg.
Herodotus.
- GAIT (EDWARD ALBERT), C.S.I., C.I.E.**
Member of the Executive Council, Bihar and Orissa.
Human Sacrifice (Indian).
- GARBE (RICHARD), Ph.D.**
Professor des Sanskrit und der allgemeinen Religionsgeschichte an der Universität zu Tübingen.
Guna.
- GEDEN (ALFRED S.), M.A. (Oxon.), D.D. (Aber.).**
Professor of Old Testament Languages and Literature, and of Comparative Religion, in the Wesleyan College, Richmond, Surrey; author of *Studies in the Religions of the East*, *Outlines of Introduction to the Hebrew Bible*; translator of P. Deussen's *Philosophy of the Upanishads*.
God (Buddhist, Hindu), Hospitality (Hindu).
- GERIG (JOHN LAWRENCE), M.A., Ph.D.**
Associate Professor of Romance Languages and Celtic in Columbia University, New York.
Hospitality (Celtic).
- GODDARD (PLINY EARLE), A.B., M.A., Ph.D.**
Associate Curator in the Anthropological Department of the American Museum of Natural History.
Hupa.
- GOLDZIHNER (IGNAZ), Ph.D., D.Litt., LL.D.**
Professor of Semitic Philology in the University of Budapest; Ord. Member and Class-President of the Hungarian Academy of Sciences; Foreign Member of the British Academy, of the Imperial Academy of Sciences, St. Petersburg, of the Royal Academies of Sciences, Berlin, Amsterdam, Göttingen, Copenhagen, of the Jewish Historical Society of England, of the Société Asiatique, Paris.
Ghair Mahdi.
- GOMME (SIR G. LAURENCE), F.S.A.**
Fellow of the Anthropological Institute; Vice-President of the Folklore Society; Hon. Member of Glasgow Archæological Society
Folklore.
- GRAY (LOUIS HERBERT), Ph.D.**
Sometime Member of the Editorial Staff of the *New International Encyclopædia*, *Orientalische Bibliographie*, etc.; Member of the American and German Oriental Societies, Indogermanische Gesellschaft, etc.; author of *Indo-Iranian Phonology* (1912); translator of *Vāsavadattā, a Sanskrit Romance by Subandhu* (1913).
Fiction (Primitive, Oriental, and Græco-Roman), Fortune (Iranian), Hair and Nails, Heroes and Hero-Gods (Iranian), Hopi, Hospitality (Iranian), Huron.
- GRIERSON (SIR GEORGE ABRAHAM), K.C.I.E., Ph.D. (Halle), D.Litt. (Dublin), I.C.S. (retired).**
Foreign Associate Member of the Société Asiatique de Paris; Corresponding Member of the Königliche Gesellschaft der Wissenschaften zu Göttingen; Vice-President of the Royal Asiatic Society; Superintendent of the Linguistic Society of India.
Ganapatyas, Gaya, Gorakhnath, Harischandis.

- GWYNN (EDWARD JOHN), M.A.**
Fellow of Trinity College, Dublin; Lecturer in Celtic Languages in the University of Dublin; formerly Todd Lecturer in Celtic Languages in the Royal Irish Academy.
Fosterage.
- HADDON (ALFRED CORT), M.A., Sc.D. (Cantab.), F.R.S., F.R.A.I.**
University Lecturer in Ethnology, Cambridge and London; President of the Anthropological Section of the British Association, 1902; Author of *Evolution in Art*.
Heroes and Hero-Gods (General and Primitive).
- HAMILTON-GRIERSON (SIR PHILIP JAMES, Kt.), B.A. (Oxon.)**
Fellow of the Society of Scottish Antiquaries; Fellow of the Royal Anthropological Institute; Solicitor for Scotland to the Board of Inland Revenue.
Gifts (Primitive and Savage).
- HARADA (TASUKU), D.D., LL.D.**
President of Doshisha University, Kyoto.
God (Japanese).
- HARDIE (WILLIAM ROSS), M.A., LL.D.**
Professor of Humanity in the University of Edinburgh; author of *Lectures on Classical Subjects* (1903).
Horace.
- HARRISON (JANE ELLEN), LL.D. (Aber.), D.Litt. (Durham)**
Staff Lecturer and sometime Fellow of Newnham College, Cambridge; author of *The Religion of Ancient Greece* (1905), *Prolegomena to the Study of Greek Religion* (1907), *Themis: A Study of the Social Origins of Greek Religion* (1912).
Gorgon, Harpies.
- HARTLAND (EDWIN SIDNEY), F.S.A.**
President of the Folklore Society, 1899; President of the Anthropological Section of the British Association, 1906; President of Section I (Religions of the Lower Culture) at the Oxford International Congress for the History of Religions, 1908; author of *The Legend of Perseus, Primitive Paternity*, etc.
Foundation and Foundation-Rites, Games, Hottentots.
- HAWKINS (E. L.)**
Author of *A Concise Encyclopedia of Freemasonry* (1908).
Freemasonry.
- HIRSCH (EMIL G.), A.M., D.D., LL.D., Litt.D.**
Rabbi of Sinai Congregation and Professor of Rabbinical Literature and Philosophy in the University of Chicago; author of *Ethical Materialism*; editor of *Reform-Advocate*.
Hillel.
- HOGARTH (DAVID GEORGE), M.A., F.S.A., F.R.G.S.**
Fellow of Magdalen College, Oxford; Fellow of the British Academy; editor of *Authority and Archaeology*.
Hierodouloi (Greco-Roman), Hieroi.
- HOPKINS (EDWARD WASHBURN), Ph.D., LL.D.**
Professor of Sanskrit and Comparative Philology in Yale University; former President of the American Oriental Society; author of *The Religions of India, The Great Epic of India, India Old and New*, etc.
Fire-walking, Fountain of Youth.
- JACOBI (HERMANN), Ph.D.**
Professor des Sanskrit an der Universität zu Bonn; Geheimer Regierungsrat.
Hemachandra, Heroes and Hero-Gods (Indian).
- JOLLY (JULIUS), Ph.D. (Munich), Hon. M.D. (Göttingen), Hon. D.Litt. (Oxford)**
Ord. Professor of Sanskrit and Comparative Philology in the University of Würzburg; formerly Tagore Professor of Law in the University of Calcutta; Geheimer Hofrat.
Food (Hindu), Gifts (Hindu).
- JONES (RUFUS M.), M.A., D.Litt.**
Professor of Philosophy in Haverford College, Haverford, Pennsylvania; author of *Social Law in the Spiritual World* (1904), *Studies in Mystical Religion* (1909).
Flagellants.
- JOSEPH (MORRIS)**
Senior Minister of the West London Synagogue; author of *Judaism as Creed and Life* (1910).
Halevi.
- JOYCE (GILBERT CUNNINGHAM), M.A., D.D.**
Warden of St. Deiniol's Library, Hawarden; author of *The Inspiration of Prophecy* (1910).
Grotius.
- KELSO (JAMES ANDERSON), A.B., D.D., Ph.D.**
Professor of Hebrew and Old Testament Literature, and President of the Western Theological Seminary, Pittsburgh; author of *Die Klagelieder, Der Massorthische Text und die Versionen* (1910).
Fool, Folly (Biblical).
- KLEMENTZ (DEMETRIUS)**
Councillor of State; ex-Director of the Ethnographical Section of the Russian Museum of the Emperor Alexander III.; Member of the Russian Geographical Society, of the Anthropological Society of Moscow, and of the Imperial Archaeological Society.
Gilyaks.
- KROHN (KAARLE LEOPOLD), D.Phil.**
Professor der finnischen und vergleichenden Folk-Lore an der Universität zu Helsingfors.
Finno-Ugrians, Finns (Ancient).
- LANG (ANDREW), M.A., D.Litt., D.C.L., LL.D.**
Author of *Myth, Ritual, and Religion* (1887), *The Making of Religion* (1898), etc.
God (Primitive and Savage).
- LEGER (LOUIS)**
Professeur au Collège de France; Professeur honoraire à l'École des langues orientales; Membre de l'Institut de France.
God (Slavic), Human Sacrifice (Slavic).
- LINDSAY (JAMES), M.A., B.Sc., D.D., F.R.S.L., F.R.S.E., F.G.S., M.R.A.S.**
Author of *Studies in European Philosophy, Recent Advances in Theistic Philosophy of Religion, The Fundamental Problems of Metaphysics*.
First Cause, Goethe.
- MACALISTER (ROBERT ALEXANDER STEWART), M.A., F.S.A.**
Professor of Celtic Archaeology in University College, Dublin; formerly Director of Excavations of the Palestine Exploration Fund; author of *A History of Civilization in Palestine* (1912), *The Excavation of Gezer* (1912).
Human Sacrifice (Semitic).

- MACCULLOCH (JOHN ARNOTT)**, Hon. D.D. (St. Andrews).
Rector of St. Saviour's, Bridge of Allan; Hon. Canon of the Cathedral of the Holy Spirit, Cumbrae; Examiner in Comparative Religion and Philosophy of Religion, Victoria University, Manchester; Bell Lecturer, Edinburgh Theological College; author of *Comparative Theology, Religion: its Origin and Forms, The Childhood of Fiction, The Religion of the Ancient Celts*.
First-born (Introductory and Primitive), Firstfruits (Introductory and Primitive), Hand, Head, Heart, Horns.
- MACFADYEN (DUGALD)**, M.A. (Oxon.), F.R.Hist.S.
Minister of the Congregational Church at Highgate, London; author of *The Life and Letters of Alexander Mackennal, Constructive Congregational Ideals, Truth in Religion, Men of the Spirit, Glasites*.
- MACHAL (JAN)**, D.Ph.
Ord. Professor of Slavic Literatures in the Bohemian University, Prague; ord. Member of the Bohemian Academy; Member of the Royal Bohemian Society of Sciences.
Heroes and Hero-Gods (Slavic).
- MCINTYRE (JAMES LEWIS)**, M.A. (Edin. and Oxon.), D.Sc. (Edin.).
Anderson Lecturer in Comparative Psychology to the University of Aberdeen; Lecturer in Psychology, Logic, and Ethics to the Aberdeen Provincial Committee for the Training of Teachers; formerly Examiner in Philosophy to the University of Edinburgh; author of *Giordano Bruno* (1903).
Horror.
- MACKENZIE (DONALD)**, M.A.
Minister of the United Free Church at Oban; Assistant Professor of Logic and Metaphysics in the University of Aberdeen, 1906-1909.
Free Will.
- MACKINTOSH (HUGH ROSS)**, M.A., D.Phil. (Edin.), D.D. (Edin.).
Professor of Systematic Theology in New College, Edinburgh; author of *The Doctrine of the Person of Jesus Christ* (1912).
Grace.
- MACLAGAN (P. J.)**, M.A., D.Phil.
Of the English Presbyterian Mission, Swatow.
Heroes and Hero-Gods (Chinese).
- MACRITCHIE (DAVID)**, F.S.A. (Scot. and Ireland).
Member of the Royal Anthropological Institute of Great Britain and Ireland; President of the St. Andrew Society, Edinburgh; author of *Ancient and Modern Britons; The Ainos; Fians, Fairies and Picts; Scottish Gypsies under the Stewarts*.
Giants, Gypsies.
- MAIR (ALEXANDER)**, M.A.
Professor of Philosophy in the University of Liverpool.
Hallucination.
- MAIR (ALEXANDER WILLIAM)**, M.A. (Aber. and Camb.), Litt.D. (Aber.).
Fellow of Gonville and Caius College, Cambridge; Professor of Greek in the University of Edinburgh; editor of *Hesiod* (1908).
Hesiod.
- MARGOLIOUTH (DAVID SAMUEL)**, M.A., D.Litt.
Fellow of New College, and Laudian Professor of Arabic in the University of Oxford; author of *Mohammed and the Rise of Islam, Mohammedanism*; editor of many Arabic works.
God (Arabian, pre-Islamic), Harranians, Hospitality (Arabian).
- MARGOLIOUTH (GEORGE)**, M.A. (Cantab.).
Senior Assistant in the Department of Oriental Printed Books and MSS in the British Museum.
Games (Hebrew and Jewish), Heroes and Hero-Gods (Hebrew).
- MENANT (DELPHINE)**.
Membre de la Société Asiatique; Chargée de Mission dans l'Inde par le Ministre de l'Instruction Publique, 1900-1901; Lauréat de l'Académie Française.
Gabars.
- MILNE (JOSEPH GRAFTON)**, M.A. (Oxon.), F.R.N.S.
Hon. Lecturer in Numismatics in the Liverpool Institute of Archaeology; Hon. Treasurer of the Palestine Exploration Fund.
Græco-Egyptian Religion.
- MODI (SHAMS-UL-ULMA JIVANJI JAMSHEDJI)**, B.A., Hon. Ph.D. (Heidelberg).
Fellow of the University of Bombay; Dipl. Litteris et Artibus (Sweden); Officier d'Académie, France; Officier de l'Instruction Publique, France; Vice-President of the Bombay Branch of the Royal Asiatic Society.
Haoma.
- MOGK (EUGEN)**, Dr.Phil.
Professor der nordischen Philologie an der Universität zu Leipzig.
God (Teutonic), Hamadryads, Human Sacrifice (Teutonic).
- MONTET (EDOUARD)**, D.Th., D.Philos.
Professeur d'Hébreu et d'Araméen, d'Exégèse de l'Ancien Testament, de Langue et de Littérature Arabes à l'Université de Genève.
Hasidæans, Hasidism.
- MOSS (RICHARD WADDY)**, D.D.
Professor of Systematic Theology in Didsbury College, Manchester.
Fortune (Biblical and Christian).
- MOULTON (JAMES HOPE)**, M.A. (Cantab.), D.Lit. (Lond.), D.D. (Edin.), D.C.L. (Durham), D.Theol. (Berlin).
Late Fellow of King's College, Cambridge; Greenwood Professor of Hellenistic Greek and Indo-European Philology in the University of Manchester; Tutor in Didsbury Wesleyan College; author of a *Grammar of New Testament Greek* (3rd ed. 1908), *Religion and Religions* (1913).
Fravashi.
- MÜLLER (JOSEPH THEODOR)**, Dr.Theol.
Direktor des Archivs der Evangelischen Brüder-Unität (Unitas Fratrum) in Herrnhut.
Hussites.
- MUMFORD (Mrs. ETHEL WATTS)**.
Member of the American Oriental Society.
Hawaii.
- MURRAY (JOHN CLARK)**, LL.D. (Glas.), F.R.S.C.
Emeritus Professor of Philosophy in McGill University, Montreal.
Goodwill, Habit.

- NICHOLSON (REYNOLD ALLEYNE), M.A., Litt.D., LL.D.**
Lecturer in Persian in the University of Cambridge; sometime Fellow of Trinity College.
Hallaj, Hasan al-Basri.
- NIVEN (WILLIAM DICKIE), M.A.**
Minister of the United Free Church at Blairgowrie; Co-examiner in Mental Philosophy in the University of Aberdeen.
Good and Evil.
- OTTLEY (ROBERT LAURENCE), D.D.**
Regius Professor of Pastoral Theology, and Canon of Christ Church, Oxford; author of *The Doctrine of the Incarnation* (1895), *Aspects of the Old Testament* (1897), *The Religion of Israel* (1905).
Home, Hope (Christian), Humility.
- PATON (JOHN LEWIS), M.A.**
High Master, Manchester Grammar School; Late Fellow of St. John's College, Cambridge; Member of Consultative Committee of the Board of Education.
Gambling.
- PEARSON (A. C.), M.A.**
Late Scholar of Christ's College, Cambridge; editor of *Fragments of Zeno and Cleanthes*, Euripides' *Helena*, *Heraclidae*, and *Phænissæ*.
Gifts (Greek and Roman), Heroes and Hero-Gods (Greek and Roman), Human Sacrifice (Greek).
- PINCHES (THEOPHILUS GOLDRIDGE), LL.D. (Glas.), M.R.A.S.**
Lecturer in Assyrian at University College, London, and at the Institute of Archaeology, Liverpool; Hon. Member of the Société Asiatique.
Heroes and Hero-Gods (Babylonian).
- POPE (ROBERT MARTIN), M.A. (Camb. and Manchester).**
Author of *Cathemerinon of Prudentius*.
Honesty, Honour.
- POWICKE (FREDERICK JAMES), M.A., Ph.D. (Rostock).**
Hatherlow Parsonage, Cheshire; author of *John Norris of Bemerton*; *Henry Barrow, Separatist*; *Robert Browne, Pioneer of Modern Congregationalism*; *Essentials of Congregationalism*; *Life of David Worthington Simon*.
Friends of God.
- PRINCE (JOHN DYNELEY), B.A., Ph.D.**
Professor of Semitic Languages in Columbia University, N.Y.; Member of the New Jersey Legislature; Advisory Commissioner on Crime and Dependency for New Jersey; Speaker of New Jersey House; President of New Jersey Senate; Acting-Governor of New Jersey.
God (Assyro-Babylonian).
- PUNNETT (REGINALD CRUNDALL), M.A., F.R.S.**
Arthur Balfour Professor of Genetics in the University of Cambridge; author of *Mendelism*.
Heredity.
- RANKIN (WILLIAM MIHRLEES), B.D.**
Minister of the United Free Church at Glasgow; author of *The Life of Christ* (1910).
Friendship.
- REID (JAMES SMITH), M.A., LL.D., Litt.D.**
Fellow and late Tutor of Gonville and Caius College, Cambridge; Professor of Ancient History in the University of Cambridge; editor of the *Academica* and other works of Cicero.
Gilds (Greek and Roman), Holiness (Roman).
- REID (JOHN), M.A. (Glas.)**
Minister of the United Free Church at Inverness; author of *Jesus and Nicodemus*, *The First Things of Jesus*, *The Uplifting of Life*.
Gossip, Humour.
- REVON (MICHEL), LL.D., D.Lit.**
Late Professor of Law in the Imperial University of Tokyo and Legal Adviser to the Japanese Government; Professor of History of the Civilization of the Far East in the University of Paris; author of *Le Shinntoisme*.
Heroes and Hero-Gods (Japanese), Hospitality (Japanese and Korean), Human Sacrifice (Japanese and Korean).
- ROBINSON (CHARLES HENRY), M.A. (Camb.), D.D. (Edin.)**
Hon. Canon of Ripon; Editorial Secretary of the Society for the Propagation of the Gospel in Foreign Parts; author of *Hausaland*, *Studies in the Character of Christ*, and other works.
Flowers.
- ROBINSON (GEORGE LIVINGSTONE), Ph.D., D.D., LL.D.**
Professor of Biblical Literature and English Bible in McCormick Theological Seminary, Chicago; Director of the American School of Archaeology in Jerusalem; Explorer of Sinai Peninsula and Kadesh-Barnea; Discoverer of the sixth and seventh walls of Beersheba and the original 'High Place' at Petra.
High Place.
- ROSE (H. A.), I.C.S.**
Superintendent of Ethnography, Panjab, India.
Granth.
- ROSS (JOHN M. E.), M.A.**
Minister of St. Ninian's Presbyterian Church, Golders Green, London; author of *The Self-Portraiture of Jesus*, *The Christian Standpoint*.
Grail, The Holy.
- ROSS (Mrs. MARGARET), B.A. (McGill), London.**
Grail, The Holy.
- ROSSINI (CARLO CONTI), Dr. jur.**
Formerly Director of Civil Service in Erythraea.
Hamites and East Africa.
- ROUSE (WILLIAM HENRY DENHAM), M.A., Litt.D.**
Headmaster of the Perse Grammar School, Cambridge; University Teacher of Sanskrit; President of the Folklore Society, 1904-06.
Firstfruits (Greek).
- SALT (HENRY STEPHENS).**
Hon. Secretary of the Humanitarian League; formerly Assistant Master at Eton College.
Humanitarianism.

- SCHILLER (FERDINAND CANNING SCOTT), M.A., D.Sc. (Oxon.).**
Fellow and Senior Tutor of Corpus Christi College, Oxford; author of *Riddles of the Sphinx* (1891), *Humanism* (1903, new ed. 1912), *Studies in Humanism* (1907, 1912), *Plato or Protagoras?* (1908), *Formal Logic* (1912), etc.
Humanism.
- SCHRADER (OTTO), Dr. phil. et jur. h.c.**
Ordentlicher Professor für vergleichende Sprachforschung an der Universität zu Breslau; author of *Prehistoric Antiquities of the Aryan Peoples*.
Hospitality (Teutonic and Balto-Slavic).
- SCHULHOF (JOHN MAURICE), M.A. (Cantab. et Oxon.).**
Clare College; sometime Scholar of Trinity College, Cambridge; late Fellow of St. Augustine's College, Canterbury.
Hedonism.
- SCOTT (ERNEST FINDLAY), M.A. (Glas.), D.D. (St. Andrews).**
Professor of New Testament Criticism in Queen's Theological College, Kingston, Canada; author of *The Fourth Gospel, The Apologetic of the New Testament*.
Gnosticism.
- SCOTT (WALTER), M.A. (Oxford).**
Formerly Fellow of Merton College, Oxford.
Giants (Greek and Roman).
- SEATON (MARY ETHEL).**
Mediæval and Modern Languages Tripos, Class I., 1909 and 1910; Assistant Lecturer at Girton College, Cambridge.
Heroes and Hero-Gods (Teutonic).
- SELER (EDUARD), Dr. Phil.**
Professor für Amerikanische Sprache, Völker- und Altertumskunde an der Universität zu Berlin; Mitglied der Königl. Preussischen Akademie der Wissenschaften; Abt. Direktor des Königl. Museums für Völkerkunde; Professor onor. Mus.-Nac., Mexico.
Huichols.
- SELL (EDWARD), B.D., D.D., M.R.A.S.**
Fellow of the University of Madras; Hon. Canon of St. George's Cathedral, Madras; Secretary of the Church Missionary Society, Madras; author of *The Faith of Islam, The Historical Development of the Qur'ân*.
God (Muslim).
- SETHE (KURT), Ph.D.**
Professor der Aegyptologie an der Universität zu Göttingen.
Heroes and Hero-Gods (Egyptian).
- SHORRY (PAUL), Ph.D., LL.D., Litt.D.**
Professor and Head of the Department of Greek in the University of Chicago; Roosevelt Professor at the University of Berlin, 1913; Member of the American Institute of Art and Letters.
Hope (Greek and Roman).
- SIKES (EDWARD ERNEST), M.A.**
Fellow, Tutor, and Classical Lecturer of St. John's College, Cambridge; author of *The Anthropology of the Greeks*; editor of *Æschylus' Prometheus Vincetus, the Homeric Hymns*, etc.
Hair and Nails, Hearth and Hearth-Gods (Greek).
- SMITH (HENRY PRESERVED), D.D.**
Librarian of the Union Theological Seminary, New York; formerly Professor of Old Testament Literature and the History of Religion in the Meadville Theological School, Pennsylvania.
Forgiveness (Hebrew).
- SMITH (KIRBY FLOWER), Ph.D. (Johns Hopkins), LL.D. (Vermont).**
Professor of Latin in the Johns Hopkins University, Baltimore.
Hecate's Suppers.
- SÖDERBLOM (NATHAN), D.D. (Paris), Hon. D.D. (Geneva, Christiania, St. Andrews).**
Éleve diplômé de l'École des Hautes Études; Professor in the University of Upsala and in the University of Leipzig; Member of the Chapter of Upsala; Prebendary of Holy Trinity in Upsala.
Holiness (General and Primitive).
- SPEIGHT (HAROLD EDWIN BALME), M.A.**
Junior Minister of Essex Church, Kensington; formerly Assistant Professor of Logic and Metaphysics in the University of Aberdeen; sometime Fellow of Manchester College, Oxford.
Heine, Herder.
- SPOONER (WILLIAM ARCHIBALD), D.D.**
Warden of New College, and Hon. Canon of Christ Church, Oxford; Chaplain to the Bishop of Peterborough.
Golden Rule.
- STOCK (ST. GEORGE), M.A. (Oxford).**
Lecturer on Greek in the University of Birmingham; author of *English Thought for English Thinkers*.
Fortune (Greek), Friendship (Greek and Roman), Hermes Trismegistus, Hospitality (Greek and Roman).
- STOKES (GEORGE J.), M.A. (Trinity College, Dublin).**
Of Lincoln's Inn, Barrister-at-Law; Professor of Philosophy and Jurisprudence in University College, Cork, National University of Ireland.
Forgery.
- STRAHAN (JAMES), M.A.**
Edinburgh; author of *Hebrew Ideals, The Book of Job, The Captivity and Pastoral Epistles*.
First-born (Hebrew), Firstfruits (Hebrew), Flacius, Goodness, Gospel.
- SUFFRIN (AARON EMMANUEL), M.A. (Oxon.).**
Vicar of Waterlooville, Hants.
Fortune (Jewish), God (Jewish).
- SZABO (ALADÁR), Dr. Phil.**
Minister of the Reformed Church in Budapest.
Hungarians.
- TENNANT (FREDERICK ROBERT), D.D., B.Sc.**
Fellow and Lecturer of Trinity College, Cambridge.
Force.
- THOMSON (BASIL HOME), J.P. (London).**
Barrister-at-Law; formerly Acting Native Commissioner in Fiji.
Fiji.

- THOMSON (JAMES ALEXANDER KERR), M.A.**
Assistant Professor of Greek in the University of Aberdeen; late Scholar of Pembroke College, Oxford.
Homer.
- THOMSON (J. ARTHUR), M.A., LL.D.**
Regius Professor of Natural History in the University of Aberdeen; author of *The Study of Animal Life, The Science of Life, Heredity, The Bible of Nature, Darwinism and Human Life, Outlines of Zoology, The Biology of the Seasons, Herbert Spencer, Introduction to Science.*
Growth (Biological).
- THRÄMER (EDUARD), Dr. Phil.**
Professor der Klass. Altertumswissenschaft an der Universität zu Strassburg, emeritiert seit 1908.
Health and Gods of Healing (Greek, Roman).
- THURN (SIR EVERARD IM), K.C.M.G., C.B., M.A.**
(Oxford), LL.D. (Edin.).
Formerly Government Agent in British Guiana; Lt.-Governor of Ceylon; Governor of Fiji and High Commissioner of Western Pacific Guiana.
- THURSTON (HERBERT), B.A., S.J.**
Joint-Editor of the Westminster Library for Priests and Students; author of *Life of St. Hugh of Lincoln, The Holy Year of Jubilee, The Stations of the Cross.*
Güntherianism.
- TROELTSCH (ERNST), Dr. theol., phil. jur.**
Professor der Theologie an der Universität zu Heidelberg; Geheimer Kirchenrat.
Free-Thought, Historiography.
- TROITSKY (SERGËI VICTOROVICH), Master of Theology.**
Instructor in the Alexander-Nevalij Theological College at St. Petersburg; Member of the Imperial Archaeological Institute of St. Petersburg; attached to the Chancery of the Over-Procurator of the Most Holy Synod.
Greek Orthodox Church.
- TURMEL (JOSEPH).**
Prêtre; ancien Professeur de Théologie au Séminaire de Rennes; auteur de *Histoire de la théologie positive, Histoire du dogme de la Papauté des origines à la fin du quatrième siècle.*
Gallicanism.
- TURNER (STANLEY HORSFALL), M.A., D. Litt.**
Fellow of the Royal Economic Society; Deputy Chief Inspector for Scotland to the National Health Insurance Commission; formerly Lecturer in Political Economy in the University of Aberdeen.
Friendly Societies.
- WAGGETT (PHILIP NAPIER), M.A. (Oxford and Camb.).**
Of the Society of St. John the Evangelist; Curate of St. Peter's Church, Cambridge; Select Preacher, Oxford (1902-1904), Cambridge (1903 and 1913); author of *Religion and Science* (1904), *The Scientific Temper in Religion* (1905).
Heredity (Ethics and Religion).
- WALSHE (W. GILBERT), M.A.**
London Secretary of Christian Literature Society for China; 'James Long' Lecturer; author of *Confucius and Confucianism, Ways that are Dark*; editor of *China, Fortune* (Chinese).
- WATSON (DAVID), D.D.**
Minister of the Church of Scotland at Glasgow; Vice-Convener of the Church of Scotland Social Work; author of *Social Advance, Social Problems and the Church's Duty.*
Hooliganism.
- WATT (HUGH), M.A., B.D.**
Minister of the United Free Church at Bearsden, Dumbartonshire.
Humanists.
- WELLS (LEONARD ST. ALBAN), M.A. (Oxford).**
Missioner of St. Andrew Diocese, Salisbury; formerly Chaplain and Lecturer of the Clergy College, Ripon; author of *Choice of the Jews* (1911), *Paul the Apostle* (1912); sub-editor of the Oxford edition of *Apocrypha and Pseudepigrapha.*
Gospels (Apocryphal).
- WHEELER (ADDISON JAMES), M.A.**
Curate of Frensham, Surrey.
Gongs and Bells.
- WHITEHOUSE (OWEN CHARLES), M.A. (Lond. and Camb.), D.D. (Aber.).**
Theological Tutor, Cheshunt College, Cambridge; Examiner in Hebrew in the University of London.
Holiness (Semitic).
- WHITLEY (WILLIAM THOMAS), M.A., LL.D., F.R.Hist.S., P.T.S.**
Secretary of the Baptist Historical Society; formerly Principal of the Baptist College of Victoria, and Secretary of the Victorian Baptist Foreign Mission.
Friends of the Temple, Huguenots, Huntingdon's (Countess of) Connexion, Hutchinsonians.
- WIRDEMAN (Alfred), Dr. Phil. et Litt. h.c. (Louvain); Litt.D. h.c. (Dublin).**
Ordentlicher Honorar-Professor der altorientalischen Geschichte und Aegyptologie an der Universität zu Bonn.
God (Egyptian).
- WILDE (NORMAN), Ph.D.**
Professor of Philosophy and Psychology in the University of Minnesota.
Happiness.
- WISSOWA (GEORG), Dr. jur. et phil.**
Ordentlicher Professor an der Universität zu Halle; Geheimer Regierungsrat.
Hearth and Hearth-Gods (Roman).
- WOODBRIDGE (FREDERICK J. E.), A.M., LL.D.**
Johnsonian Professor of Philosophy, and Dean of the Faculties of Political Science, Philosophy, Pure Science, and Fine Arts, in Columbia University, New York.
Hobbes, Hume.
- WOODHOUSE (WILLIAM J.), M.A.**
Professor of Greek in the University of Sydney, New South Wales.
Horae.
- WÜNSCH (RICHARD), Dr. Phil.**
Ordentlicher Professor der Klassischen Philologie an der Universität zu Münster.
Human Sacrifice (Roman).

CROSS-REFERENCES

—♦—

In addition to the cross-references throughout the volume, the following list of minor references may be useful:

TOPIC.	PROBABLE TITLE OF ARTICLE.	TOPIC.	PROBABLE TITLE OF ARTICLE.
Filioque Controversy .	Greek Orthodox Church, Roman Church.	Goths	Teutons.
Fines	Crimes and Punishments.	Grave	Death and Disposal of the Dead.
Fishing	Hunting and Fishing.	Gregory of Nazianzus .	Cappadocian Theology.
Flags	Banners.	Gregory of Nyssa . . .	Cappadocian Theology.
Fomorians	Celts, Giants.	Grey Friars	Religious Orders.
Fornication	Adultery.	Grihastha	Ásrama.
Fortune-telling	Divination.	Group-marriage	Concubinage.
Foundlings	Fosterage.	Hallowe'en	Festivals and Fasts (Celtic).
Fourierism	Communitistic Societies of America.	Ḥammurabi	Law (Babylonian).
Fowl	Animals.	Hare	Animals.
Fox	Animals.	Harivamsa	Radhavallabhis.
Franciscans	Religious Orders.	Harrowing of Hell . . .	Descent to Hades.
Free Churches	Nonconformity.	Hasanites	Assassins.
Free Love	Agapemone, Agapetæ, Marriage.	Haunting	Death and Disposal of the Dead.
Frog	Animals.	Hawk	Animals.
Funeral Rites	Death and Disposal of the Dead.	Headship of Christ . . .	State.
Future Life	State of the Dead.	Hegira, Hijra	Calendar (Muslim).
Gaddi, Ghosi	Ahir.	Hellenism	Greek Religion, Israel.
Gaels, Gauls, Goidels .	Celts.	Helvetius	Encyclopædists.
Gallas	Abyssinia.	Hereros	Bantu and S. Africa.
Garos	Bodos.	Hermeneutics	Interpretation.
Garuda	Brāhmanism, Vedic Re- ligion.	Hermits	Monasticism.
Gazing	Crystal-gazing.	Hetairism	Concubinage.
Generalization	Concept, Conception.	Hicksites	Friends, Society of.
Genius	Demons and Spirits (Roman).	Hierophant	Mysteries.
Georgian Church	Russian Church.	High Church	Church of England.
Germans	Teutons.	Higher Criticism	Bible in the Church.
Glossolalia	Charismata.	Holbach	Encyclopædists.
Goat	Animals, Azazel.	Hopkinsonians	Edwards and the New England Theology.
Golden Bough	King, Kingship.	Hospitals	Hospitality (Christian).
Goose	Animals.	Huacas	Andeans, Peru.
Gospellers	Sects (Christian).	Humanity	Culture.
Gothic Architecture . . .	Architecture (Christian).	Humanity, Religion of .	Positivism.
		Hyæna	Animals.
		Hydromancy	Divination.

LISTS OF ABBREVIATIONS

I. GENERAL

A.H. = Anno Hijrae (A.D. 622).
 Ak. = Akkadian.
 Alex. = Alexandrian.
 Amer. = American.
 Apoc. = Apocalypse, Apocalyptic.
 Apocr. = Apocrypha.
 Aq. = Aquila.
 Arab. = Arabic.
 Aram. = Aramaic.
 Arm. = Armenian.
 Ary. = Aryan.
 As. = Asiatic.
 Assyr. = Assyrian.
 AT = Altes Testament.
 AV = Authorized Version.
 AVm = Authorized Version margin.
 A.Y. = Anno Yazdagird (A.D. 639).
 Bab. = Babylonian.
 c. = circa, about.
 Can. = Canaanite.
 cf. = compare.
 ct. = contrast.
 D = Deuteronomist.
 E = Elohist.
 edd. = editions or editors.
 Egyp. = Egyptian.
 Eng. = English.
 Eth. = Ethiopic.
 EV = English Version.
 f. = and following verse or page: as Ac 10³⁴.
 ff. = and following verses or pages: as Mt 11²⁸⁷.
 Fr. = French.
 Germ. = German.
 Gr. = Greek.
 H = Law of Holiness.
 Heb. = Hebrew.
 Hel. = Hellenistic.
 Hex. = Hexateuch.
 Himy. = Himyaritic.
 Ir. = Irish.
 Iran. = Iranian.

Isr. = Israelite.
 J = Jahwist.
 J" = Jehovah.
 Jerus. = Jerusalem.
 Jos. = Josephus.
 LXX = Septuagint.
 Min. = Minæan.
 MSS = Manuscripts.
 MT = Massoretic Text.
 n. = note.
 NT = New Testament.
 Onk. = Onkelos.
 OT = Old Testament.
 P = Priestly Narrative.
 Pal. = Palestine, Palestinian.
 Pent. = Pentateuch.
 Pers. = Persian.
 Phil. = Philistine.
 Phœn. = Phœnician.
 Pr. Bk. = Prayer Book.
 R = Redactor.
 Rom. = Roman.
 RV = Revised Version.
 RVm = Revised Version margin.
 Sab. = Sabæan.
 Sam. = Samaritan.
 Sem. = Semitic.
 Sept. = Septuagint.
 Sin. = Sinaitic.
 Skr. = Sanskrit.
 Symm. = Symmachus.
 Syr. = Syriac.
 t. (following a number) = times.
 Talm. = Talmud.
 Targ. = Targum.
 Theod. = Theodotion.
 TR = Textus Receptus.
 tr. = translated or translation.
 VSS = Versions.
 Vulg. = Vulgate.
 WH = Westcott and Hort's text.

II. BOOKS OF THE BIBLE

Old Testament.

Gn = Genesis.	Ca = Canticles.
Ex = Exodus.	Is = Isaiah.
Lv = Leviticus.	Jer = Jeremiah.
Nu = Numbers.	La = Lamentations.
Dt = Deuteronomy.	Ezk = Ezekiel.
Jos = Joshua.	Dn = Daniel.
Jg = Judges.	Hos = Hosea.
Ru = Ruth.	Jl = Joel.
1 S, 2 S = 1 and 2 Samuel.	Am = Amos.
1 K, 2 K = 1 and 2 Kings.	Ob = Obadiah.
1 Ch, 2 Ch = 1 and 2 Chronicles.	Jon = Jonah.
Ezr = Ezra.	Mic = Micah.
Neh = Nehemiah.	Nah = Nahum.
Est = Esther.	Hab = Habakkuk.
Job.	Zeph = Zephaniah.
Ps = Psalms.	Hag = Haggai.
Pr = Proverbs.	Zec = Zechariah.
Ec = Ecclesiastes.	Mal = Malachi.

Apocrypha.

1 Es, 2 Es = 1 and 2 Esdras.	To = Tobit.
	Jth = Judith.

Ad. Est = Additions to Esther.	Sus = Susanna.
Wis = Wisdom.	Bel = Bel and the Dragon.
Sir = Sirach or Ecclesiasticus.	Pr. Man = Prayer of Manasses.
Bar = Baruch.	1 Mac, 2 Mac = 1 and 2 Maccabees.
Three = Song of the Three Children.	

New Testament.

Mt = Matthew.	1 Th, 2 Th = 1 and 2 Thessalonians.
Mk = Mark.	1 Ti, 2 Ti = 1 and 2 Timothy.
Lk = Luke.	Tit = Titus.
Jn = John.	Philem = Philemon.
Ac = Acts.	He = Hebrews.
Ro = Romans.	Ja = James.
1 Co, 2 Co = 1 and 2 Corinthians.	1 P, 2 P = 1 and 2 Peter.
Gal = Galatians.	1 Jn, 2 Jn, 3 Jn = 1, 2, and 3 John.
Eph = Ephesians.	Jude.
Ph = Philippians.	Rev = Revelation.
Col = Colossians.	

III. FOR THE LITERATURE

1. The following authors' names, when unaccompanied by the title of a book, stand for the works in the list below.

- Baethgen = *Beiträge zur sem. Religionsgesch.*, 1888.
 Baldwin = *Dict. of Philosophy and Psychology*, 3 vols. 1901-1905.
 Barth = *Nominalbildung in den sem. Sprachen*, 2 vols. 1889, 1891 (^d1894).
 Benzinger = *Heb. Archäologie*, 1894.
 Brockelmann = *Gesch. d. arab. Litteratur*, 2 vols. 1897-1902.
 Bruns-Sachau = *Syr.-Röm. Rechtsbuch aus dem fünften Jahrhundert*, 1880.
 Budge = *Gods of the Egyptians*, 2 vols. 1903.
 Daremberg-Saglio = *Dict. des ant. grec. et rom.*, 1886-90.
 De la Saussaye = *Lehrbuch der Religionsgesch.*, 1905.
 Denzinger = *Enchiridion Symbolorum*¹¹, Freiburg im Br., 1911.
 Deussen = *Die Philos. d. Upanishads*, 1899 [Eng. tr., 1906].
 Doughty = *Arabia Deserta*, 2 vols. 1888.
 Grimm = *Deutsche Mythologie*⁴, 3 vols. 1875-1878, Eng. tr. *Teutonic Mythology*, 4 vols. 1882-1888.
 Hamburger = *Realencyclopädie für Bibel u. Talmud*, i. 1870 (¹1892), ii. 1883, suppl. 1886, 1901 ff., 1897.
 Holder = *Alteltischer Sprachschatz*, 1891 ff.
 Holtzmann-Zöpfel = *Lexicon f. Theol. u. Kirchenwesen*³, 1895.
 Howitt = *Native Tribes of S. E. Australia*, 1904.
 Jubainville = *Cours de Litt. celtique*, i.-xii., 1883 ff.
 Lagrange = *Études sur les religions sémitiques*², 1904.
 Lane = *An Arabic-English Dictionary*, 1863 ff.
 Lang = *Myth, Ritual and Religion*², 2 vols. 1899.
 Lepsius = *Denkmäler aus Ägypten u. Äthiopien*, 1849-1860.
 Lichtenberger = *Encyc. des sciences religieuses*, 1876.
 Lidzbarski = *Handbuch der nordsem. Epigraphik*, 1898.
 McCurdy = *History, Prophecy, and the Monuments*, 2 vols. 1894-1896.
 Muir = *Sanskrit Texts*, 1858-1872.
 Muss-Arnolt = *A Concise Dict. of the Assyrian Language*, 1894 ff.
 Nowack = *Lehrbuch d. heb. Archäologie*, 2 vols. 1894.
 Pauly-Wissowa = *Realencyc. der classischen Altertumswissenschaft*, 1893-1895.
 Perrot-Chipiez = *Hist. de l'Art dans l'Antiquité*, 1881 ff.
 Preller = *Römische Mythologie*, 1858.
 Réville = *Religion des peuples non-civilisés*, 1883.
 Riehm = *Handwörterbuch d. bibl. Altertums*², 1893-1894.
 Robinson = *Biblical Researches in Palestine*², 1856.
 Roscher = *Lex. d. gr. u. röm. Mythologie*, 1884.
 Schaff-Herzog = *The New Schaff-Herzog Encyclopedia of Reliq. Knowledge*, 1908 ff.
 Schenkel = *Bibel-Lexicon*, 5 vols. 1869-1875.
 Schürer = *GJV*³, 3 vols. 1898-1901 [*HJP*, 5 vols. 1890 ff.].
 Schwally = *Leben nach dem Tode*, 1892.
 Siegfried-Stade = *Heb. Wörterbuch zum AT*, 1893.
 Smend = *Lehrbuch der alttest. Religionsgesch.*², 1899.
 Smith (G. A.) = *Historical Geography of the Holy Land*⁴, 1896.
 Smith (W. R.) = *Religion of the Semites*², 1894.
 Spencer (H.) = *Principles of Sociology*², 1885-1896.
 Spencer-Gillen^a = *Native Tribes of Central Australia*, 1899.
 Spencer-Gillen^b = *Northern Tribes of Central Australia*, 1904.
 Swete = *The OT in Greek*, 3 vols. 1893 ff.
 Tylor (E. B.) = *Primitive Culture*², 1891 [¹1903].
 Ueberweg = *Hist. of Philosophy*, Eng. tr., 2 vols. 1872-1874.
 Weber = *Jüdische Theologie auf Grund des Talmud u. verwandten Schriften*², 1897.
 Wiedemann = *Die Religion der alten Ägypter*, 1890 [Eng. tr., revised, *Religion of the Anc. Egyptians*, 1897].
 Wilkinson = *Manners and Customs of the Ancient Egyptians*, 3 vols. 1875.
 Zuntz = *Die gottdienstlichen Vorträge der Juden*², 1892.

2. Periodicals, Dictionaries, Encyclopedias, and other standard works frequently cited.

- AA = Archiv für Anthropologie.
 AAOJ = American Antiquarian and Oriental Journal.
 ABAW = Abhandlungen d. Berliner Akad. d. Wissenschaften.
 AE = Archiv für Ethnographie.
 AEG = Assyr. and Eng. Glossary (Johns Hopkins University).
 AGU = Abhandlungen d. Göttinger Gesellschaft der Wissenschaften.
 AGPh = Archiv für Geschichte der Philosophie.
 AHR = American Historical Review.
 AHT = Ancient Hebrew Tradition (Hommel).
 AJPh = American Journal of Philosophy.
 AJP = American Journal of Psychology.
 AJRPE = American Journal of Religious Psychology and Education.
 AJSL = American Journal of Semitic Languages and Literature.
 AJTh = American Journal of Theology.
 AMG = Annales du Musée Guimet.
 APES = American Palestine Exploration Society.
 APF = Archiv für Papyrusforschung.
 AR = Anthropological Review.
 ARW = Archiv für Religionswissenschaft.
 AS = Acta Sanctorum (Bollandus).
 ASG = Abhandlungen der Sachsischen Gesellschaft der Wissenschaften.
 ASoc = L'Année Sociologique.
 ASWI = Archaeological Survey of W. India.
 AZ = Allgemeine Zeitung.
 BAG = Beiträge zur alten Geschichte.
 BASS = Beiträge zur Assyriologie u. sem. Sprachwissenschaft (edd. Delitzsch and Haupt).
 BCH = Bulletin de Correspondance Hellénique.
 BE = Bureau of Ethnology.
 BG = Bombay Gazetteer.
 BJ = Bellum Judaicum (Josephus).
 BL = Bampton Lectures.
 BLE = Bulletin de Littérature Ecclésiastique.
 BOR = Bab. and Oriental Record.
 BS = Bibliotheca Sacra.
 BSA = Annual of the British School at Athens.
 BSAA = Bulletin de la Soc. archéologique à Alexandrie.
 BSAL = Bulletin de la Soc. d'Anthropologie de Lyon.
 BSAP = Bulletin de la Soc. d'Anthropologie, etc., Paris.
 BSG = Bulletin de la Soc. de Géographie.
 BTS = Buddhist Text Society.
 BW = Biblical World.
 BZ = Biblische Zeitschrift.

- CAIBL**=Comptes rendus de l'Académie des Inscriptions et Belles-Lettres.
CBTS=Calcutta Buddhist Text Society.
CE=Catholic Encyclopædia.
CF=Childhood of Fiction (MacCulloch).
CGS=Cults of the Greek States (Farnell).
CI=Census of India.
CIA=Corpus Inscip. Atticarum.
CIE=Corpus Inscip. Etruscarum.
CIG=Corpus Inscip. Græcarum.
CIL=Corpus Inscip. Latinarum.
CIS=Corpus Inscip. Semiticarum.
COT=Cuneiform Inscriptions and the OT [Eng. tr. of *KAT*²; see below].
CR=Contemporary Review.
CeR=Celtic Review.
CIR=Classical Review.
CQR=Church Quarterly Review.
CSEL=Corpus Script. Eccles. Latinorum.
DACL=Dict. d'Archéologie chrétienne et de Liturgie (Cabrol).
DB=Dict. of the Bible.
DCA=Dict. of Christian Antiquities (Smith-Cheetham).
DCB=Dict. of Christian Biography (Smith-Wace).
DCG=Dict. of Christ and the Gospels.
DI=Dict. of Islam (Hughes).
DNB=Dict. of National Biography.
DP&P=Dict. of Philosophy and Psychology.
DWA W=Denkschriften der Wiener Akad. der Wissenschaften.
EBi=Encyclopædia Biblica.
EBr=Encyclopædia Britannica.
EEFM=Égypt. Explor. Fund Memoirs.
EI=Encyclopædia of Islâm.
ERE=The present work.
Exp=Expositor.
ExpT=Expository Times.
FHG=Fragmenta Historicorum Græcorum (coll. C. Müller, Paris, 1885).
FL=Folklore.
FLJ=Folklore Journal.
FLR=Folklore Record.
GA=Gazette Archéologique.
GB²=Golden Bough² (Frazer).
GGA=Göttingische Gelehrte Anzeigen.
GGN=Göttingische Gelehrte Nachrichten (Nachrichten der königl. Gesellschaft der Wissenschaften zu Göttingen).
GIAP=Grundriss d. Indo-Arischen Philologie.
GIrP=Grundriss d. Iranischen Philologie.
GJV=Geschichte des Jüdischen Volkes.
GVI=Geschichte des Volkes Israel.
HAI=Handbook of American Indians.
HDB=Hastings' Dict. of the Bible.
HE=Historia Ecclesiastica.
HGHL=Historical Geography of the Holy Land (G. A. Smith).
HI=History of Israel.
HJ=Hibbert Journal.
HJP=History of the Jewish People.
HN=Historia Naturalis (Pliny).
HWB=Handwörterbuch.
IA=Indian Antiquary.
ICC=International Critical Commentary.
ICO=International Congress of Orientalists.
ICR=Indian Census Report (1901).
IG=Inscip. Græcæ (publ. under auspices of Berlin Academy, 1873 ff.).
IGA=Inscip. Græcæ Antiquissimæ.
IGI=Imperial Gazetteer of India² (1885); new edition (1908-1909).
IJE=International Journal of Ethics.
ITL=International Theological Library.
JA=Journal Asiatique.
JAFL=Journal of American Folklore.
JAI=Journal of the Anthropological Institute.
JAOS=Journal of the American Oriental Society.
JASB=Journal of the Anthropological Society of Bombay.
JASBe=Journ. of As. Soc. of Bengal.
JBL=Journal of Biblical Literature.
JBTS=Journal of the Buddhist Text Society.
JD=Journal des Débats.
JDTb=Jahrbücher f. deutsche Theologie.
JE=Jewish Encyclopedia.
JGOS=Journal of the German Oriental Society.
JHC=Johns Hopkins University Circulars.
JHS=Journal of Hellenic Studies.
JLZ=Jenæer Litteraturzeitung.
JPh=Journal of Philology.
JPTb=Jahrbücher f. protest. Theologie.
JPTS=Journal of the Pâli Text Society.
JQR=Jewish Quarterly Review.
JRAI=Journal of the Royal Anthropological Institute.
JRAS=Journal of the Royal Asiatic Society.
JRASBo=Journal of the Royal Asiatic Society, Bombay branch.
JRASC=Journal of the Royal Asiatic Society, Ceylon branch.
JRASK=Journal of the Royal Asiatic Society, Korean branch.
JRGS=Journal of the Royal Geographical Society.
JThSt=Journal of Theological Studies.
KAT¹=Die Keilinschriften und das AT (Schrader), 1883.
KAT²=Zimmern-Winckler's ed. of the preceding [really a totally distinct work], 1903.
KB or KIB=Keilinschriftliche Bibliothek (Schrader), 1889 ff.
KGF=Keilinschriften und die Geschichtsforschung, 1878.
LCBl=Literarisches Centralblatt.
LOPh=Literaturblatt für Oriental. Philologie.
LOT=Introduction to Literature of OT (Driver).
LP=Legend of Perseus (Hartland).
LSSt=Leipziger sem. Studien.
M=Mélusine.
MAIBL=Mémoires de l'Acad. des Inscriptions et Belles-Lettres.
MBAW=Monatsbericht d. Berliner Akad. d. Wissenschaften.
MGH=Monumenta Germaniæ Historica (Pertz).
MGJV=Mittheilungen der Gesellschaft für jüdische Volkskunde.
MGWJ=Monatsschrift f. Geschichte u. Wissenschaft des Judentums.
MI=Origin and Development of the Moral Ideas (Westermarck).
MNDPV=Mittheilungen u. Nachrichten des deutschen Palästina-Vereins.
MR=Methodist Review.
MVG=Mittheilungen der vorderasiatischen Gesellschaft.
MWJ=Magazin für die Wissenschaft des Judentums.
NBAC=Nuovo Bulletino di Archeologia Cristiana.
NC=Nineteenth Century.
NHWB=Neuhebräisches Wörterbuch.
NINQ=North Indian Notes and Queries.
NKZ=Neue kirchliche Zeitschrift.
NQ=Notes and Queries.
NR=Native Races of the Pacific States (Bancroft).
NTZG=Neutestamentliche Zeitgeschichte.
OED=Oxford English Dictionary (Murray).
OLZ=Orientalische Litteraturzeitung.
OS=Onomastica Sacra.
OTJC=Old Testament in the Jewish Church (W. R. Smith).
OTP=Oriental Translation Fund Publications.
PAOS=Proceedings of American Oriental Society.
PASB=Proceedings of the Anthropological Soc. of Bombay.

- PB* = Polychrome Bible (English).
PBE = Publications of the Bureau of Ethnology.
PC = Primitive Culture (Tylor).
PEFM = Palestine Exploration Fund Memoirs.
PEFSt = Palestine Exploration Fund Quarterly Statement.
PG = Patrologia Græca (Migne).
PJB = Preussische Jahrbücher.
PL = Patrologia Latina (Migne).
PNQ = Punjab Notes and Queries.
PR = Popular Religion and Folklore of N. India (Crooke).
PRE^s = Prot. Realencyclopädie (Herzog-Hauck).
PRR = Presbyterian and Reformed Review.
PRS = Proceedings of the Royal Society.
PRSE = Proceedings Royal Soc. of Edinburgh.
PSBA = Proceedings of the Soc. of Biblical Archaeology.
PTS = Pāli Text Society.
RA = Revue Archéologique.
RAnth = Revue d'Anthropologie.
RAS = Royal Asiatic Society.
RAssyr = Revue d'Assyriologie.
RB = Revue Biblique.
RBEW = Reports of the Bureau of Ethnology (Washington).
RC = Revue Critique.
RCel = Revue Celtique.
RCh = Revue Chrétienne.
RDM = Revue des Deux Mondes.
RE = Realencyclopädie.
REG = Revue des Études Grecques.
REg = Revue Égyptologique.
REJ = Revue des Études Juives.
REth = Revue d'Ethnographie.
RHLR = Revue d'Histoire et de Littérature Religieuses.
RHR = Revue de l'Histoire des Religions.
RN = Revue Numismatique.
RP = Records of the Past.
RPh = Revue Philosophique.
RQ = Römische Quartalschrift.
RS = Revue sémitique d'Épigraphie et d'Hist. ancienne.
RSA = Recueil de la Soc. archéologique.
RSI = Reports of the Smithsonian Institution.
RTAP = Recueil de Travaux relatifs à l'Archéologie et à la Philologie.
RTP = Revue des traditions populaires.
RThPh = Revue de Théologie et de Philosophie.
RTr = Recueil de Travaux.
RWB = Realwörterbuch.
SBAW = Sitzungsberichte der Berliner Akad. d. Wissenschaften.
SBB = Sacred Books of the Buddhists.
SBE = Sacred Books of the East.
SBOT = Sacred Books of the OT (Hebrew).
SDB = Single-vol. Dict. of the Bible (Hastings).
SK = Studien u. Kritiken.
SMA = Sitzungsberichte der Münchener Akademie.
SSGW = Sitzungsberichte d. Kgl. Sächs. Gesellsch. d. Wissenschaften.
SWAW = Sitzungsberichte d. Wiener Akad. d. Wissenschaften.
TAPA = Transactions of American Philological Association.
TASJ = Transactions of the Asiatic Soc. of Japan.
TC = Tribes and Castes.
TES = Transactions of Ethnological Society.
ThLZ = Theologische Literaturzeitung.
ThT = Theol. Tijdschrift.
TRHS = Transactions of Royal Historical Society.
TRSE = Transactions of Royal Soc. of Edinburgh.
TS = Texts and Studies.
TSBA = Trans. of the Soc. of Biblical Archaeology.
TU = Texte u. Untersuchungen.
WAI = Western Asiatic Inscriptions.
WZKM = Wiener Zeitschrift f. Kunde des Morgenlandes.
ZA = Zeitschrift für Assyriologie.
ZÄ = Zeitschrift für Ägypt. Sprache u. Altertumswissenschaft.
ZATW = Zeitschrift für die alttest. Wissenschaft.
ZCK = Zeitschrift für christliche Kunst.
ZCP = Zeitschrift für celtische Philologie.
ZDA = Zeitschrift für deutsches Altertum.
ZDMG = Zeitschrift der deutschen morgenländischen Gesellschaft.
ZDPV = Zeitschrift des deutschen Palästina-Vereins.
ZE = Zeitschrift für Ethnologie.
ZKP = Zeitschrift für Keilschriftforschung.
ZKG = Zeitschrift für Kirchengeschichte.
ZKT = Zeitschrift für kathol. Theologie.
ZKWL = Zeitschrift für kirchl. Wissenschaft u. kirchl. Leben.
ZM = Zeitschrift für die Mythologie.
ZNTW = Zeitschrift für die neutest. Wissenschaft.
ZPhP = Zeitschrift für Philosophie und Pädagogik.
ZTK = Zeitschrift für Theologie u. Kirche.
ZVK = Zeitschrift für Volkskunde.
ZVRW = Zeitschrift für vergleichende Rechtswissenschaft.
ZVT = Zeitschrift für wissenschaftliche Theologie.

[A small superior number designates the particular edition of the work referred to, as *KAT*¹, *LOT*², etc.]

ENCYCLOPÆDIA

OF

RELIGION AND ETHICS

F

FICTION (Primitive, Oriental, and Græco-Roman).—By the term 'fiction' in the literary sense we understand any tale or narrative—whatever its length and whether in poetry or prose—told or written for amusement or for instruction. This rough working definition must, however, receive considerable modification, for the fable and the parable (*qq. v.*) are scarcely fiction in the usual acceptation of the term; nor does the definition seem to account for the origin of fiction, but to apply solely to its later forms and developments.

1. Origin.—The origin of fiction is impossible to determine with certainty. In its earliest known form it may be divided, as by MacCulloch, into Sagas and *Märchen*:

'In the saga, incidents are related of supernatural personages, of heroes and heroines, who have definite names and are believed to have once actually existed, while they are also attached to definite places. The saga thus is to a large extent equivalent to the myth. In the *Märchen* all is vague, impersonal, indefinite; for, as M. Dozon says, "the absence of names is one of the characteristics of true popular tales" (*CF*, London, 1905, p. 450).

(a) *The Saga*.—This type, represented most familiarly by the bulk of Old Icelandic literature, and also seen, for example, in the *Iliad* and *Odyssey*, the Arthurian cycle (see ARTHUR, ARTHURIAN CYCLE), the Irish *Táin Bó Cúalnge*, the Pañjābī Rāja Rasālū, the European Charlemagne, the Oriental Alexander the Great cycles, etc., is probably historical in origin. There is here, in other words, doubtless a kernel of real events, about which the mythopoeic tendency common to the entire human race has clustered events which may or may not be historic. In the latter case they may have been performed by others than the characters to whom they are ascribed, and to which—in view of changed beliefs and outlook upon life—motives, assisting and thwarting agencies, and even results may be assigned that are radically different from, or even diametrically opposed to, those which were in the original form of the saga in question. Thus, the saga constitutes the earliest type of history, and it is possible, in great part, to reconstruct a large portion of real history by the excision of material obviously fictitious. Such history can in no case (except where, as in the Alexander cycle, authentic historical materials are elsewhere given) be regarded as other than a more or less close ap-

proximation to the course of events as they actually took place; and the conclusion of the most conscientious investigators will perforce differ widely as regards the historicity of alleged events of prime importance to the credibility of the saga. Conspicuous examples of this type are the Malay *Seyaru Malayu* (tr. Leyden, *Malay Annals*, London, 1821; cf. Waitz-Gerland, *Anthropol. der Naturvölker*, Leipzig, 1860-77, v. i. 109-112) and the Maori epics (Grey, *Polynes. Mythol. and Ancient Traditional Hist. of the New Zealand Race*, London, 1855), where the historical basis is readily discernible, despite the legendary accretions. Indeed, there is practically no people which does not possess at least one saga as to its origin and history. But, being designed primarily to preserve history, the saga cannot properly be classed as fiction.

(b) *The Märchen*.—With the *Märchen* the case is different, although the two are often confused, so that, as MacCulloch says (*loc. cit.*):

'What is told as a saga in one country occurs as a *Märchen* in another place. Possibly *Märchen* are the deteriorated form of sagas; on the other hand, a saga may merely be a *Märchen* to the personages of which definite names have been given. Hence, we can hardly affirm yet which is the earlier of the two; nor is there any good reason for supposing that both forms of the folk-tale may not have been invented separately. But, judging by most collections of savage folk-tales, the earliest stories must have had more or less of the saga form, more especially if we consider saga and myth to be closely related. We have seen how many European folk-tale incidents exist as separate stories among savages, but told of this or the other traditional personage. These are sagas or myths. They may, however, be told occasionally of no one in particular; then they are savage *Märchen*. Moreover, where a more or less elaborate story told by savages can be proved to have reached them by diffusion or borrowing, almost invariably the actors in it have become the well-known heroes or divinities of the tribe. In other words, a story told in Europe as a *Märchen* becomes a saga when it is adopted by savages.'

The *Märchen* is normally shorter than the saga, and it very frequently has a didactic purpose which is foreign to the essence of the saga; we may even say that, in its didactic aspect, the *Märchen* is the parent of the fable, the main difference being that in the latter the 'moral' is clearly indicated, while in the former it may be drawn or not, if present, or may be altogether lacking, or may have different morals in different versions. As an instance we may take a story whose earliest known form is found in the *Pañchatantra* (iii. 4).

Here a Brāhman secures a goat for sacrifice, and is seen by three rogues, who plan to get the animal. Standing at intervals

along his road, the first asks him why he carries a dog, the second a dead child, and the third an ass. The Brâhman, thinking his goat is a demon, throws it down and runs away, while the rogues enjoy a feast. The moral here given is: 'Rogues gifted with much understanding, with good discrimination, and superior in strength, are able to deceive.' In the *Hitopadesa* (iv. 10) the moral is: 'He who, with himself for a standard, judges a knave to speak the truth, is deceived by him'; and in the *Kathâsaritsâgara* (x. vi. 61-68) that: 'Numbers conquer in this world.' In the *Decameron* (ix. 3) the rogues make Calandrino believe that he is with child, and conspire with a physician to extort money from him for an abortion; no moral is given. In the *Gesta Romanorum* (cxxxii.) three physicians so convince their rival that he has leprosy that he contracts the disease, the three physicians being 'the lust of the flesh, the lust of the eyes, and the pride of life,' or the world, the flesh, and the devil, who often corrupt the good physician, i.e. a prelate or confessor, so that he is driven from the Church (for further parallels, see Bentley, *Pantschatantra*, Leipzig, 1850, li. 256-257; *Gesta Romanorum*, ed. Oesterley, p. 783f.).

Many of the *Märchen*, as is clear from MacCulloch's masterly *CP*, are the *detritus* of older sagas; and a still greater number are distinctly ætiological in character, as in our familiar story of how the robin got its red breast, although the latter category more properly comes under the rubrics of myth and folklore (*qq.v.*); and a third class represents primitive religious beliefs, as in Puss in Boots, Beauty and the Beast, Bluebeard, Jack and the Beanstalk, etc. In all these cases—historical, mythical, and survivalistic—the original motive was profoundly serious. Indeed, the present writer is inclined to believe that primitive man did relatively little for mere amusement (cf. above, vol. iv. p. 868).

Yet this statement obviously demands much qualification. Men may be profoundly in earnest, and yet the necessity for relaxation and the capacity for enjoyment of it are innate in primitive man, as in the most highly developed of modern humanity. Just as we may read fiction of the most superficial character for the sake of recreation, or may turn to a psychological or problem novel or to a historical romance for delineation of character or for a reconstruction of bygone times, and derive a true Aristotelian *katharsis* and elevating stimulus and joy from the reading or the hearing of the tale, so it doubtless was with primitive man. And, just as children delight in hearing stories to-day, so early man (and early child) found joy, after the day's work was done, in similar recitals. Only, what to us are fairy stories and palpable fictions were to him very real and entirely possible.

Thus, then, amusement and recreation, if not the prime factors, soon came to be potent agencies in fostering the growth of fiction; nor is there any reason why amusement and recreation should not be combined with history, myth, and folk-belief. Indeed, there must be some element of pleasure if the tale is to survive, this pleasure being of every type, from mere amusement or frank ribaldry to the highest intellectual *katharsis* or minute dissection of character. In the early stage the hero must be the embodiment of all the popular virtues, and must be victorious over every obstacle; later, as in the *Morte d'Arthur*, temporal success is unessential, more stress being laid on nobility of soul; finally, in some types of fiction it becomes possible for the hero not only to meet defeat, but also to be characterized by ignoble qualities, so that the novel becomes a study of degeneration, not of progress, as in Harold Frederic's *Damnation of Theron Ware* (1896; known in Britain under the title of *Illumination*). Yet the last-named type of fiction can scarcely hope to be popular; for the middle classes,

¹ The time at which sagas and *Märchen* are preferably told is at night, as among the Amer. Indians and Micronesians (Walt-Gerland, iii. 284f., v. li. 81), Guiana Indians (Im Thurn, *Among the Indians of Guiana*, London, 1883, p. 216), Africans (Nassau, *Fetichism in W. Africa*, London, 1904, p. 230; Struyt, in *Anthropos*, iii. (1908) 742), Hindus (Steel and Temple, *Wide-awake Stories*, Bombay, 1884, pp. vii, 2-3; Vasavadatta, tr. Gray, New York, 1912, p. 96), Persians (*The Thousand Nights and One Night*, *Introd.*), and Europeans generally (*CP*, 2).

whose mental attitude represents the national standard, are insufficiently developed to appreciate a novel which is wholly 'unpleasant'; although it can scarcely be doubted that such fiction, when seriously undertaken, is perfectly legitimate, and that the horror which it excites arouses an ethical resolve to endeavour to avoid becoming such a person as is portrayed in it.

Whether, at the first, there was 'make-believe' seems questionable, and yet at a very early time there must have arisen a fund of anecdote which formed the genesis of a short form of fiction—of which all traces have long since vanished—precisely as so much of our own fiction is more or less drawn from real types, so that we must say, if it is to meet with approval, *se non è vero, è ben trovato*.

(c) *Diffusion*.—The problem of the diffusion of fiction-incidents is extremely involved. The story-telling instinct is universal, and the widely divergent national types—to which attention will be devoted below—show that various peoples have independently developed their own classes of fiction in accordance with their distinctive modes of thought. It is possible, however, that the question is somewhat more complicated than it seems. Attention has been called by Mrs. Flora Steel and Sir Richard Temple (*Wide-awake Stories*, 387f.) to the fact that, 'since the incidents are more apt to retain their stock forms than the plots, they make up the most important portion of a tale from the investigator's point of view.' In some instances the incident is so unusual that borrowing would be the first thought, were not the difficulties in the way of such an hypothesis so great as practically to forbid it (cf., also, *CP*, 23, 458ff.). Elsewhere the process of borrowing is evident, as in the African story of Brer Rabbit and the Tar-Baby (Harris, *Uncle Remus, his Songs and his Sayings*, New York, 1881, pp. 23-25), which appears, with the substitution of a Frenchman for Brer Fox, in a Biloxi (Louisiana) tale (*47 Bull. BE* [1912], pp. 12-15). While we must recognize that inter-communication was probably more extensive than is commonly believed (cf. Hirt, *Indogermanen*, Straassburg, 1905-07, pp. 317ff., 305ff.), and that in this way there was a very general transmission of folk-tale incidents, it is safest, in our present state of knowledge, to adopt a conservative position, and to hold, unless there is positive evidence or very strong probability to the contrary, that these incidents are derived from similar experiences and from the essentially uniform psychology common to the entire human race.

(d) *Earliest form*.—The ordinary speech of man is in prose, and we may accordingly be certain that the most primitive *Märchen*, as recorded, for instance, among the N. Amer. Indians, were also in prose. The same was probably the case with the saga. Yet, while prose is easier for normal conversation, it is less easy to recollect and repeat accurately than poetry. Accordingly we find that there was a tendency, when the sagas and such *Märchen* as were deemed of greater importance developed to considerable length, to recite them in verse. In other cases, as in Old Irish, or in the Panjabi Raja Rasala cycle, there is a commingling of prose and verse, the *canta-fable*, in which the speeches of the principal characters, quasi-summaries of the tales, or indications of especially important situations are given in verse, the bulk of the narrative being in prose. As a matter of fact, the co-existence of poetic (bardic) and prose (folk-tale) versions of the same theme may be found in N. India to-day, and it is well known that the former type preserves the text much more faithfully than the latter, where the resultant record is usually the form most in vogue. In the case of

commingled prose and verse, the latter is retained faithfully, and may even serve as the nucleus for a new folk-tale. Moreover, there is a tendency for the bardic element to break down into the folk-tale and for the poetry to be turned into prose, to the detriment of faithful transmission, but to the encouragement, it may be suggested, of transfer of incident. The Rāja Rasālū cycle is a case in which these processes may be witnesses in actual operation (Temple, *Legends of the Panjāb*, Bombay, 1884-1900, i. pp. v-vii; Swynnerton, *Romantic Tales from the Panjāb*, Westminster, 1903, p. xxix). The *cante-fable* may be in part a degeneration of the bardic poem, and in part a transition from the primitive prose *Märchen* or saga to the poem, in both cases standing midway between the two; and in the break-down of the bardic poem into the prose folk-tale we may see yet another instance of a course of development forming a complete circle and returning to its starting-point, which, in the special case under consideration, seems to have been prose (cf. *CF*, 480-482).

2. History.—(a) *Primitive*.—A charming picture of the mode of presentation of primitive types of fiction is given by Alice Fletcher and Francis La Flesche, himself an Omaha, in their record of the Omaha Indians (*27 RBEW* [1911], p. 370):

'Story-telling was the delight of every one during the winter evenings. It was then that the old folk drew on their store of memories; and myths, fables, the adventures of the pygmies and of the *gajazhe* (the little people who play about the woods and prairies and lead people astray)—all these and also actual occurrences were recited with varying intonation and illustrative gesture, sometimes interspersed with song, which added to the effect and heightened the spell of the story or myth over the listeners clustered about the blazing fire.'

The Amer. Indian stories cover a wide range, as was noted in 1862 by Waitz-Gerland (iii. 232-235). Since the time of Waitz almost every volume of the annual reports and the bulletins of the Bureau of American Ethnology adds new material.

Where there is such wealth of material, selection is both difficult and invidious, but particularly excellent collections are to be found, among more recent works, in Rand's *Legends of the Micmacs* (ed. Helen Webster, London, 1894); Cushing's *Zufi Folk-Tales* (New York, 1901); Grinnell's *Pawnee Hero Stories and Folk-Tales* (do. 1889); and Rink's *Tales and Traditions of the Eskimo* (London, 1875).

The same general observations apply to the primitive fiction of the Oceanic region, though here there is a richer fantasy than in America. The Polynesians have not merely a large number of elaborate sagas and myths, but are also expert in the telling of *Märchen*, their attainments being thus summarized by Waitz-Gerland (vi. 98 f.):

'Neben diesen ernsten, epischen Erzählungen pflegten und pflegen sie auch sonst sich gern durch Erzählungen zu unterhalten, oft aus dem Stegreif, wo sie dann ernstes, schreckliches, komisches, oft auch nicht sehr dezent, oft aber auch sehr anmutliches vorbringen. Gute Erzähler sind sehr beliebt und daher sehr gesucht (Moerenhout, *Voyages aux Iles du Grand Océan*, Paris, 1837, ii. 81). Erfindend und phantasie reich sind sie in hohem Maasse. In Tonga bilden häufig Besuche in Bulotu und Schilderungen der Götterheimat, oder erdichtete Reisen ins Land der Papalangi, der Europäer, das mit den tollsten Uebertreibungen, aber oft aufs witzigste geschildert wird, den Inhalt dieser Erzählungen (Mariner, *Tonga Islands*, London, 1816, ii. 126, 334). Auch den Europäern erzählten sie, anfangs wohl unbenommen, solche Geschichten, womit sie sich zu unterhalten pflegten; als sie aber sahen, dass jene manches davon für baare Münze nahmen, so reizte sie das immer mehr, da Andere zu necken ihnen grosse Freude macht und sie erzählten immer ausschweifende Dinge.'

For collections of Oceanic sagas and *Märchen*, reference may be made to such works as K. M. Clarke's *Maori Tales and Legends* (London, 1896); Gill's *Myths and Songs from the S. Pacific* (do. 1876); and K. L. Parker's *Australian Legendary Tales* (do. 1896). Similarly Africa, though more distinguished for its beast-fables, possesses many *Märchen*, as is shown by such collections as Bérenger-Féraud's *Contes de la Sénégambie* (Paris, 1885); Callaway's *Nursery Tales, Traditions, and Histories of the Zulus* (London, 1868); Ohatelain's *Folk-Tales of Angola* (Boston, 1894); Ferrand's *Contes populaires malgaches* (Paris, 1894); Jacottet's *Contes populaires des Ba-Soutos* (do. 1895); Steere's *Swahili Tales* (London, 1870); and Schönharl's *Märchen und Fabeln . . . der Ewe-Neger von Togo* (Dresden, 1909).

(b) *Egyptian*.—Turning from the primitive peoples, whose rudimentary fiction is also repre-

ented by such collections as Chamberlain's *Aino Folk-Tales* (London, 1888), to nations possessing a developed literature, the most ancient specimens of fiction are to be found among the Egyptians, whose romances are most conveniently collected by Maspero (*Contes populaires de l'Égypte ancienne*, Paris, 1906). To this category belong the famous *Tale of the Two Brothers* (XIXth dynasty) and the almost equally well-known *Tale of King Khufu and the Magicians* (XVIIIth dynasty)—the latter the earliest instance of the 'box arrangement' of stories within stories, which is later found in the Greek and Sanskrit romances, *The Thousand Nights and One Night*, the *Decameron*, etc. Both these Egyptian romances belong to the *Märchen* type, or to fiction in the real sense, as do the *Story of a Salt-Maker* (XIIIth dynasty), the *Adventures of Sâtni-Khâmois* (Ptolemaic period), and a fragmentary ghost-story (XXth dynasty). The favourite type of Egyptian fiction seems to have been, however, the historical romance, specimens of which survive in the *Adventures of Sinuhit*, *How Thutii took the City of Joppa* (XXth dynasty), *The Daughter of the Prince of Bakhtan*, *The Predestined Prince* (XXth dynasty), *The Story of Rhampsinitos* (Saite period), *The Seizure of the Cuirass*, and *The Story of a Sailor* (Ptolemaic period).

The general type of Egyptian fiction is so simple as to be almost jejune, but for that very reason it bears a stamp of veracity so plausible that only exact knowledge can in some instances distinguish fact from romance; and, as being the earliest example of literary fiction, the Egyptian romance possesses a very deep interest for all students of the subject. Its worst defect, from the modern Occidental point of view, is the monotonous repetition of the speeches placed in the mouths of the characters, so that frequently the framework of the story itself becomes almost negligible.

(c) *Arabic*.—Of all Oriental fiction unquestionably the most familiar to us is the Arabic, thanks to the *Arabian Nights*, more accurately known as *The Thousand Nights and One Night*. Introduced into Europe by Galland in 1704-08, this famous collection, the full history of which has still to be written (cf. Brockelmann, *Gesch. der arab. Lit.*, Weimar, 1898-1902, ii. 58-62; Chauvin, *Bibliog. des ouvrages arabes ou relatifs aux Arabes, publiés dans l'Europe chrét. de 1810 à 1885*, Liège, 1892-1909, iv.-vii.), formed the basis of a series of imitations in France, such as Gueulette's *Mille et un quart d'heure*, *Contes chinoises*, and *Sultanes de Guzaratte*; and Caylus's *Contes orientaux*. Yet *The Thousand and One Nights*, of which countless expurgated translations have appeared (notably by Lane [London, 1841]), besides two masterly complete English versions (by Burton, 13 vols., Benares, 1885-88; and Payne, 12 vols., London, 1882-84; the French version of Mar-drus, 16 vols., Paris, 1899-1904, must be used with caution), is not Arabic, but Indian, in origin, and is derived immediately from a lost Pahlavi version. The very composite character of this collection is well summarized by Huart (*Hist. of Arabic Lit.*, London, 1903, pp. 400-402) as follows:

'To begin with, there is an ancient ground-work, probably of Indian origin, marked by much indulgence in phantasmagoric description, as the tale of the *Fisherman and the Genius*. Then, at Bagdad, we have love stories, and adventures in the bazaars. . . . Into this cycle of popular tales some literary excerpts have slipped, such as the story of the Omeyyad Caliph Umar ibn 'Abdal-'Aziz and the poets. A third and more recent group is formed by the adventures in Cairo, grouped about the characters called Ahmad al-Danaf and Dalila. These are fantastic and supernatural stories, some of which would appear to be a survival from ancient Egyptian days. Others, such as the story of Bulûqiya, inserted into that of Hâsib Karim al-din, . . . are decidedly Jewish in their origin. . . . A further and, as might almost be said, a forcible introduction into this collection of popular tales (necessitated by an adherence to the number of one thousand and one, to which the prologue bound the compilers) is that of certain romances of chivalry, such as the story of Umar al-Nu'mân, and even of a romance of adventure by sea, the story

of Sindbad the Sailor, the origin of which goes back to the palm days of trade in the Persian Gulf and the Indian Ocean, and which was probably composed at Bassora during the tenth century. The book, as we now possess it, must have been drawn up in comparatively recent times, for it contains the stories of Qamar al-Zaman and the jeweller's wife, of Ma'ruf and his wife Fatima, both of them belonging to the sixteenth century, and also the tale of Abû Qir the Dyer and Abû Sir the Barber, the most modern of all.

The great national Arab romance, however, is the *Romance of 'Antar*, which, in its present form, dates from the period of the Crusades. It is in simple style, and is of value for its pictures of the life of the desert Arabs (cf. Caussin de Perceval, *JA* II. xii. [1833] 97-123, xiv. [1834] 317-347; and Lane, *Manners and Customs of the Modern Egyptians*, London, 1871, pp. 103-144, where the Arabic romances are summarized and estimated; partial Eng. tr. by Hamilton, 4 vols., do. 1820). Here must be included also the great cycle of the *Banû Hîlâl* (summary by Huart, 405-407), the *Romance of Saif dhul-Yazan* (Fr. tr. by Ali Bey, Constantinople, 1847), and the *Saif al-Tijân*.

(d) *Syriac, etc.*—In this literature, besides the story of Abiqâr (q.v.), the department of fiction may be regarded as including the romance of *Julian the Apostate* (ed. Hoffmann, Leyden, 1880); the *Cave of Treasures* (ed. and tr. Bezold, Leipzig, 1888); and the cycle of the *Seven Sleepers* (cf. Guidi, *Testi orientali sopra i sette dormienti di Efeso*, Rome, 1885).

In *Babylonian* and *Ethiopic* no works of fiction are recorded, and the instances of *Märchen* in the OT alleged by Gunkel (*Kultur der Gegenwart*, Leipzig, 1906, i. vii. 73)—Am 5¹⁹, Ezk 16, Is 5¹, Jonah—can by no means be assigned unhesitatingly to this class. In the NT some of the parables of our Lord may have been taken by Him from *Märchen* (e.g. Mt 18²¹⁻²⁴ 22¹⁻¹², Lk 15¹¹⁻²⁰); and to the same category may belong a number of the Talmudic and Midrashic parables and illustrative stories (see art. PARABLE). At the same time, it is obvious that the lack of written fiction does not imply that *Märchen* and sagas were not current in great numbers; Armenian literature, for instance, is devoid of the romance, but the folk-tale is very popular (cf. Chalantianz, *Armen. Märchen und Sagen*, Leipzig, n.d.).

(e) *Indian.*—The *Märchen*-literature of India is enormous, and is represented in Sanskrit by such collections as the *Kathâsaritsâgara* (Eng. tr. by Tawney, Calcutta, 1884-87), *Kathâkôsh* (Eng. tr. by Tawney, London, 1895), and *Sukasaptati* (Germ. tr. by Schmidt, Kiel, 1894, Stuttgart, 1898). The oldest formal Indian romance is Dandin's *Dakumâra-charita* (Germ. tr. by Meyer, Leipzig, 1902), a capital romance of roguery, written about the 6th cent. A.D., and the only Sanskrit romance which can lay claim to general interest. Following this, every device of the highly artificial Sanskrit *kavya* style was called into requisition by Subandhu (between A.D. 550 and 600) in his *Vasavadattâ* (Eng. tr. by Gray, New York, 1912); and he was quickly imitated by his avowed rival, Bana, the author of the equally artificial romantic *Kâdambari* (Eng. tr. by C. M. Ridding, London, 1890), and *Harshacharita* (Eng. tr. by Cowell and Thomas, do. 1897). In these three romances matter is everywhere sacrificed to form; learned allusions, elaborate paronomasias, and well-nigh cloying descriptions of scenery and natural phenomena abound; and there is neither analysis of character nor interest in action. The majority of Sanskritists utterly condemn the Indian romance, but the present writer has ventured to find

* true melody in the long, rolling compounds, a sequipedalian majesty which can never be equalled save in Sanskrit; and the alliterations have a lulling music all their own to ears weary of the blatant discords of vaunted modern "progress." There is, on the other hand, a compact brevity in the paronomasias, which are, in most cases, veritable gems of terseness and twofold ap-

propriateness, even though some are manifestly forced and are actually detrimental to the sense of the passages in which they occur. Yet in judging Subandhu for his faults, it must be remembered that he created, at least so far as we now know, a new literary genre in India; and, if this fact be borne in mind, his blemishes appear to be marvellously few. In estimating his literary merits, special stress should be laid on his descriptions. These are, it must be confessed, cloying from their abundance. They form the preponderating part of the entire romance, and the slender framework of the story is well-nigh lost beneath them. Yet, despite this tropical luxuriance, the descriptions are not without beauty and appropriateness, whether they set forth the charms of mountain, forest, and stream, or portray the raja's valour and the loveliness of the heroine herself. The entire romance may, in a sense, be likened to India's own architecture, where the whole structure is so overlaid with minute detail that the eye forgets the outlines of the building in amazement at the delicate traceries which cover it' (*Vasavadattâ*, p. 27).

Another Sanskrit romance of much interest, but as yet untranslated, is the 10th cent. *Yastulaka* of Somadeva (analyzed by Peterson, *Second Report of Operations in Search of Sanskrit Manuscripts in the Bombay Circle*, Bombay, 1884, pp. 33-49). This treats of the conversion of Mâridatta, king of Râjapura, from Brâhmanism to Jainism, and is of value not only to students of the latter sect, but also because of its allusions to other Sanskrit authors.

There are many romances also in the various vernaculars, and in the 19th cent., under Occidental influence, a number of novels of superior merit have been written by the Bengali Bankim Chandra Chatterji, such as his *Kopala Kundala* (Eng. tr. by Phillips, London, 1885), *Bipr Brikka* (Eng. tr., *The Poison Tree*, by Marian Knight, do. 1884), and *Krishna Kanta's Will* (Eng. tr. by Marian Knight, do. 1895; summaries of Chatterji's novels in Frazer, *Literary Hist. of India*, do. 1898, pp. 421-428); while, in S. India, O. Chandu Menon composed in Malayalam his *Induleka* (Eng. tr. by Dumergue, Madras, 1890; summary in Frazer, 435-439). More recently still, the writing of English fiction along Indian lines has been inaugurated by the Anglo-Indian, Bain, in a series of volumes beginning with *The Digit of the Moon* (London, 1899).

It has been held by Peterson (*Kâdambari*, Bombay, 1889, Intro. pp. 101-104), Weber (*SBAW* xxxvii. [1890] 917), and Goblet d'Alviella (*Ce que l'Inde doit à la Grèce*, Paris, 1898, p. 136) that the Indian romance was directly borrowed from the Greek. This is denied by Levi (*Quid de Græcis veterum Indorum monumenta tradiderint*, Paris, 1890, p. 60); and the present writer, after carefully considering all the parallels between the Greek and the Indian romance, is constrained to hold:

* All these parallels, and many more which might be cited, seem to me to prove nothing. In the first place, a large number of them can be considered parallels only by straining the sense of the term; and, in the second place, they are obviously the out-working of independent, though partially similar, processes in the development of Greek and Sanskrit literature respectively, and should be interpreted accordingly. But, even were an essential resemblance granted, it would still be difficult, I think, to prove the dependence of the Sanskrit romance on the Greek, the latter being, of course, the earlier. The romances of the two peoples are totally different both in plan and in spirit, as even a cursory reading will show. The least part of the Sanskrit romance is the thread of the story or the adventures of its characters; all the stress is laid on rhetorical embellishment, minute description of Nature, detailed characterization of exploits and of mental, moral, and physical qualities. In the Greek romance, on the other hand, as in Latin (if we may judge from the *Satiræ* of Petronius), the story is everything. The reader is hurried from adventure to adventure, the wilder and more improbable the better; fine writing is practically disregarded; description and appreciation of Nature are, to all intents and purposes, non-existent. The only Greek romance, it seems to me, that can, by the utmost stretch of imagination, be compared even superficially with the works of Subandhu and Bana is the *Hesperides* of Longos; but even there the sole real similarity is a longing for Nature rather than for feverish adventure, a longing which may be traced back to Theokritos, Dion, and Moschos on the one hand, and to Bhartrhari and his congeners on the other. Even the *Dakumâra-charita*, which, as a picaresque romance, one might be tempted to compare with the works of Achilles Tatios, Heliodoros, and Chariton, has a totally different plan from any Greek romance, tracing its "box arrangement" of stories to the peculiarly Indian scheme which may be seen, for instance, in the *Pañcatantra*, the *Kathâsaritsâgara*, or the *Jâtakas*, and which was later carried

to Persia, where it was incorporated in *The Thousand Nights and One Night*, ultimately appearing in the Occident in the *Decameron* of Boccaccio. The adventures narrated in Daqdin's romance of roguery, moreover, bear no resemblance, either in plot or in episode, to the amorphisms of Eustathios and his fellows. To sum up, the spirit of the Sanskrit and of the Greek romancers is as divergent as the audiences of scholars on the one hand, and of weaklings on the other, for whom they wrote; nor can any real affinity, much less any direct connexion, be traced between the romances of India and of Greece' (*Vāsavadattā*, 36-38).

(f) *Persian*.—To the Pahlavi period, besides the lost version of the *Hazār Afsāna*, the immediate source of *The Thousand Nights and One Night*, belongs the single extant Middle Persian romance, the *Kārnāmāk-i Artaxsīr-i Pāpakān*, dating from about the 6th cent. (Eng. tr. by Darab Peshotan Sanjana, Bombay, 1896; Germ. tr. by Nöldeke in *Bezzenberger's Beiträge zur Kunde der indogerm. Sprachen*, iv. [1879] 22-69).

In modern Persian the romance begins with Firdausi's *Yūsuf ū Zalīzā* (Germ. tr. by Schlecht-Wssehrd, Vienna, 1889), and is continued by such poets as Nizāmī (*Lailā ū Majnūn*, Eng. tr. by Atkinson, London, 1836) and Jāmī (*Lailā ū Majnūn*, Fr. tr. by Chézy, Paris, 1805); while among prose writers may be mentioned Muḥammad Kāzīm (*Qiṣṣa-i Kām rūp*, abridged Eng. tr. by Franklin, London, 1793), the anonymous *Qiṣṣa-i Amir Ḥamzah* (analyzed by van Ronkel, *Roman van Amir Hamza*, Leyden, 1895), and *Qiṣṣa-i Ḥātim Ṭā'i* (Eng. tr. by Forbes, London, 1830). There are a host of other romances, untranslated and even unedited (for a convenient survey, see Ethé, *GIrP* ii. [1904] 239-254, 317-334; and for specimens, see Clouston, *A Group of Eastern Romances and Stories, from the Persian, Tamil, and Urdu*, London, 1889).

Though frequently prolix and repetitions, the Persian romances are filled with lively descriptions and vivid fancy, while the love of Nature gives these works an added charm. They are infinitely more attractive than the Indian romances; they rank, indeed, among the best that the Orient has ever produced. Among the literatures whose romance has been deeply influenced by Persian should be mentioned the Georgian (Fink, in *Kultur der Gegenwart*, i. vii. 306; Wardrop, *Georgian Folk-Tales*, London, 1894).

(g) *Malay*.—The Malay literature is derived mainly from Javanese, Indian, and Arabic, with an admixture of Siamese and Persian elements. The difficulty, already noted, of distinguishing between fact and fiction meets us again in such Malay works as the *Seyaru Malayu* (to which reference has been made above), *Hikāyat Sultān Ibrahīm*, *Isma Yatīm*, *Taju al-Satātin*, and especially the *Hong Tuah* (on this class of works, see especially Hollander, *Handleiding bij de beoefening van der land- en volkenkunde van Nederl. Oost-Indië*, Breda, 1861, i. 154 ff.; Newbold, *Account of the Brit. Settlements in the Straits of Malacca*, London, 1839, ii. 317 ff.).

(h) *Chinese*.—The novel was introduced into China in the Mongol period, although its real origin is unknown.

'It probably came from Central Asia, the paradise of storytellers, in the wake of the Mongol conquest. Three centuries had then to elapse before the highest point of development was reached. Fables, anecdotes, and even short stories had already been familiar to the Chinese for many centuries, but between these and the novel proper there is a wide gulf which so far had not been satisfactorily bridged. Some, indeed, have maintained that the novel was developed from the play, pointing in corroboration of their theory to the *Hsi Hsiang Chi*, or *Story of the Western Pavilion*. . . . The Chinese range their novels under four heads, as dealing (1) with usurpation and plotting, (2) with love and intrigue, (3) with superstition, and (4) with brigandage or lawless characters generally' (Giles, *Hist. of Chinese Lit.*, London, 1901, p. 276).

The first class—historical romance—begins with Lo Kuan-Chung's *San kuo chih yen i*, based on the wars of the Three Kingdoms for supremacy in the

3rd cent. B.C., and includes the *Lieh Kuo Chuan*, covering the period between the 8th cent. B.C. and the union of China under the first Emperor. The romantic novel is represented by the *Yü Chiao Li*, written in the 15th cent. (Fr. tr. by Rémusat, *Les Deux cousines*, Paris, 1826); the *P'ing Shan Lêng Yen* (Fr. tr. by Julien, *Les Deux jeunes filles lettrées*, 2 vols., Paris, 1860); and the 17th cent. *Hung Lou Mêng* (Eng. tr. of bks. i.-ii. by Joly, Hongkong, 1892-93). To the third class belongs the interesting *Hsi Yu Chi*, 'Record of Travels in the West,' based on the Indian travels of Hiuen Tsiang and imitated in a Japanese adaptation by Kiokutei Bakin in 1806; and the fourth, or 'picaresque,' type finds illustration in the *Shui Hu Chuan*, ascribed to the 13th cent. Shih Nai-an; while the 16th or 17th cent. *Erh Tou Mei*, 'Twice Flowering Plum-Trees,' may be described as 'a novel with a purpose, being apparently designed to illustrate the beauty of filial piety, the claims of friendship, and duty to one's neighbour in general' (Giles, p. 324).

There are, moreover, numerous collections of novelettes, such as the *Chin Ku Ch'i Kuan*, 'Marvelous Tales, Ancient and Modern,' and P'u Sung-Lang's *Liao Chai Chih I* (Eng. tr. by Giles, *Strange Stories from a Chinese Studio*, 2 vols., London, 1880). Among other Chinese romances of which translations are accessible, mention may be made of the *May Yu Lang Tou Tchen Hoa Kouei* (Fr. tr. by Schlegel, *Le Vendeur d'huile*, Leyden, 1877), Tsai Tseu's *Hao Kiu Chuen* (Fr. tr. by d'Arcy, *La Femme accomplie*, Paris, 1842), and the *Pe Che Tsing Ki* (Fr. tr. by Julien, *Blanche et Bleue, ou les deux coucuvres-fées*, do. 1834); while Pavie published a *Choix de contes et nouvelles* (do. 1839), and d'Hervey-Saint-Denys, *Trois nouvelles chinoises* (do. 1885). The number of Chinese novels in non-literary style is very large.

Chinese fiction is exceedingly prolix, and has scant regard for probability; and much of it is morally objectionable. It is held in contempt by the cultured, who, however, really read it with avidity, and its value for a knowledge of Chinese life and thought cannot easily be over-estimated (see, further, Candlin, *Chinese Fiction*, Chicago, 1898).

(i) *Japanese*.—Unlike Chinese fiction, the romance in Japan is highly esteemed, here occupying a place analogous to that which it enjoys in India. Japanese fiction begins about the 10th cent. with the Märchen-like *Taketori Monogatari*, 'Story of the Bamboo-Hewer' (Eng. tr. by Dickins, *JRAS*, 1887, pp. 1-58), in which there are many Chinese elements, together with strong Buddhist and Taoist influences. To the same period—probably in part by the same compiler—belongs the similar *Utsubo Monogatari*. The next type of fiction to attract attention in Japan was the realistic novel of popular life, represented by the *Ise Monogatari*, dating from the same period as the two *Monogatari* just considered, and soon imitated in the inferior *Yamato Monogatari*; the *Genji Monogatari*, by a lady known as Murasaki no Shikibu (early 11th cent.), which is one of the works which mark the highest point attained by the literature of Japan (Eng. tr. of the first 17 chs. by Kinchio Suyematsu, London, 1882), and which was imitated in the 11th cent. *Sagoromo Monogatari* of the authoress Daini no Sammi, the 19th cent. *Inaka Genji* of Tanahiko, and the 11th cent. *Torikayebaya Monogatari*; Jippensha Ikku's *Hizakurige* (1802-22); and the 19th cent. *Mume Koyomi* and *Shunshoku Tatsumi no Sono* of Tamenaga Shunsui. The development of the historical novel was very late in Japan,—not until the 19th cent.,—the chief specimens being the *Oka Seidan* and Shunsui's *Iroha Bunko*, a version of the favourite

Japanese cycle of the revenge of the forty-seven Rōnins (Eng. tr. by Saito and Greay², New York, 1884). To the same general category belong imaginary travels, best represented in Japanese by the *Wasōbiōye* (1774; Eng. tr. of the main portion by Chamberlain, *TASJ* vii. [1879]), and by Bakin's *Musōbiōye Koshō Monogatari* (Eng. tr. by Mordwin, Yokohama, 1881). To the earlier period of Japanese fiction belong such collections of *Märchen* as the *Uji Monogatari* of Minamoto no Takakuni (usually known as Uji Dainagon), who died in 1077; and in 1810, Bakin, in his *Shichiya no Kura*, 'Pawnbroker's Store,' gives an interesting 'box arrangement' in which each of the pawnbroker's pledges tells its own story.

In the older fiction of Japan, as in India, the authors were of the higher classes, some of them, such as Murasaki no Shikibu, Daini no Sammi, and Minamoto no Takakuni, belonging to the Court circles, while the *Yamato Monogatari* is ascribed by some authorities to the Mikado Kwazan. But in course of time fiction degenerated, and was eclipsed between the 11th and the 17th century. When fiction was revived, its entire spirit was changed. The audience sought was no longer the higher classes, but the common people; and, as Aston says (*Hist. of Japan. Literature*, London, 1901, p. 267 f.),

'under the Tokugawa régime [1603-1867] the city populations enjoyed great material prosperity. But their moral standards were not high. Naturally quick-witted, and educated up to a point which may fairly be described by our own slang phrase, "the three R's," they had little real culture or refinement. The many-headed beast had, however, learned to read, and demanded an intellectual pabulum suited to its tastes.'

The authors, in like manner, were no longer men of culture, but the off-scourings of the population, such as Ibara Saikaku († 1693), Santō Kiōden (1761-1816), and Jippensha Ikku († 1831). Apart from collections of children's tales, like *The Rat's Wedding*, *The Battle of the Ape and the Crab*, *The Old Man who made Trees to Blossom*, and *The Hare's Revenge* (for the tr. of many of these stories see Mitford, *Tales of Old Japan*, new ed., London, 1890), only too large a portion of the Japanese fiction of this period is pornographic and distinctly immoral in tone, as in the 17th cent. *Mokuzu Monogatari*. The reason for this flood of pornography was, as Aston points out (p. 304), that the social relations of the sexes were very like those of ancient Athens.

'There was no social intercourse to speak of between men and women of the better class. Whenever reasons of economy did not stand in the way, the women lived a very secluded life, seeing no men but their near relations. Their marriages were arranged for them, and romantic attachments were extremely exceptional. The manners and customs of the respectable classes of society were therefore not a promising field for the writer of fiction. He preferred the freer atmosphere of the Kuruwa, to which pretty gardens and handsome buildings, with the showy education and gay costumes of their inmates, lent a superficial appearance of elegance and refinement. The element of romance in the lives of these women was perhaps small, but it existed; and it was far more natural to credit them with romantic adventures and passions than their more immaculate sisters. And if the novelist's description of these places as the home of wit and jollity, and the natural resort of all young men of spirit and fashion, had a tendency to corrupt public morals, it is also to be remembered that the class of readers whom he addressed were not particular in these matters.'

The great contribution to Japanese fiction of the later period was the romantic novel, inaugurated by Kiōden, among whose many works special mention may be made of the *Inadsuma Hideshi* and the *Hōnchō Suibodai*. Kiōden was, however, completely eclipsed by the most famous of all the novelists of Japan, Kiokutei Bakin (1767-1848), the author, among countless other works, of the *Yumibari-tsuki* (1805), the *Okoma* (Fr. tr. by Regamey, Paris, 1883), the *Kuma no tayema amayo no tsuki* (Eng. adaptation by Greay, *A Captive of Love*, Boston, 1886), and the *Hakkenden*, 'Story of the Eight Dogs' (1814-1841).

About 1879, European influence began to make itself felt in the romance, as in the political novels of Sudō Nansui (e.g. *Ladies of the New Style* [1887]). The worst defect of the Japanese romance, apart from its pornographic and immoral tone, is its gross improbability (which it shares with Chinese fiction) and—to Europeans—its inordinate length and repetition.

(j) *Greek*.—The Greek romance begins, properly speaking, with the *Cyropædia* of Xenophon, for in this alleged account of Cyrus the Great the author's real purpose was to set forth the character of the ideal ruler and the nature of the ideal State. This romance is significant as being, in reality, an amplification of the Utopia ideal presented in Plato's concept of Atlantis, the Meropis of Theopompus (4th cent. B.C.), the Hyperboreans of Hecataeus of Abdera (a contemporary of Alexander the Great), the Panchaia of Euhemerus of Messene (3rd cent. B.C.; cf. art. EUHEMERISM), and the mythical travels of Iambulus—a category which was unsparingly ridiculed by Lucian of Samosata in his *True History*. We have, moreover, in this type of Greek fiction the combination of discontent with things as they were with the vague knowledge of foreign lands gained from travellers' and merchants' tales. The element of romantic love is, however, lacking in these works, as it is, indeed,—at least as a main factor,—in older Greek literature as a whole. Yet love was, of course, present in fact; and in course of time the influence of this passion, whether for good or (as in the poets is more usually the case) for evil, was bound to gain public recognition. This recognition became possible largely through the breakdown of the old Greek State and of the aristocratic mode of life, with its rigid exclusion of women from the outer world. Furthermore, the merchant classes became dominant; and there was a resultant demand—very much as was the case in the later period of Japanese fiction—for a type of literature which should appeal to the *bourgeoisie*. It was, indeed, probably the women of the middle classes for whom the Greek novelists primarily wrote, and they very wisely contrived to unite the theme of love with the older romance of travel. At the same time, there was still a considerable amount of seclusion of women; and, as Warren (*Hist. of the Novel previous to the Seventeenth Cent.*, New York, 1895, p. 44 f.) remarks:

'That the novelists were aware of these restrictions is clear from the conventional way in which they first bring their couples together. The meeting takes place generally in a temple, as the only spot where both sexes could properly meet. And when the wanderings begin, it is almost always by violence or accident that the girl is exposed to the adventures she undergoes. . . . But, the proprieties being once satisfied, and the heroine safely embarked on their wanderings, the novelist gives free rein to his fancy and puts their reputation as travellers on the same plane as the fame of his heroes. But these continued peregrinations must have been unnatural except with women of degraded life, and . . . there are many instances in the novels where the heroine is reduced to slavery, or at best to a kind of servitude, and she is held in very light esteem by her captors and persecutors, escaping the common consequences of their contempt only by the display of extraordinary talents, or by the sudden appearance of the hero. So it is quite plausible to suppose that in this reduplication of dangers surmounted by members of the gentler sex, there is a deliberate purpose on the part of the novelist to cater to the prejudices of his public, and that . . . these historians of a lower social caste had in mind the cloistered families of the great merchants, and indulged the secluded readers of their times with the tales of woman's freedom—though in danger—and her reliance on her own talents and energy. . . . The wives of the commercial princes of Syria and Egypt delighted in the freedom which their Scythian adventures granted them in common with their seafaring masters.'

This combination of love and foreign adventure, which is the distinctive characteristic of the Greek novel, finds its earliest formal expression in the *Tá úpér Θούλην άνωτα* of Antonius Diogenes (before the second half of the 2nd cent. A.D.), a novel in 24 books, an outline of which is preserved by Photius

(*Bibl.* clxvi.). To this same period belongs the *Ovos* of Lucian (imitated and expanded by a number of episodes, including the beautiful tale of Cupid and Psyche, by the African Apuleius, in his *Metamorphoses*), in which the transformation of the hero, by magic, into an ass opens the way to a rather indecent romance of roguery.

But, though in the *Ovos* magic plays a part, this is not the key-note of the Greek romance, which, like the Norse romance (see the following art.), is completely overshadowed by the goddess Tyche (see artt. FATE, FORTUNE; and, for the Greek novel, Rohde, *Die griech. Romanen*, Leipzig, 1900, pp. 296-304), so that mankind is but the sport and the puppet of the gods. We must also note that the Greek romance is pre-eminently the work of the Sophists. As Warren says (p. 29 f.):

'All internal evidence goes to show that the teachers of rhetoric, the dialecticians of antiquity, were the makers of the literary form of the [Greek] novel. The themes given out for practice in their schools were on such subjects as are most frequently amplified in the romances, such as descriptions of nature and natural phenomena, verbal reproductions of paintings and statuary, fusions of mythological legends with tales of humble life, dramatic plots, outlines of orations, folk-lore, traditions, and whatever might lend itself to rhetorical ornamentation. . . . Besides the many correspondences of manner and subject already pointed out, there may be cited as proofs of their handiwork the pathos of the harangues, and the elaborate expressions of the letters inserted in the narrative' (cf. also, with full detail, Rohde, 310 ff.).

Before we turn to the ordinary type of the Greek novel, a word should be said of the fragments of the one Hellenic romance of chivalry, a tale of the loves of Ninos and Semiramis (on which see especially Wilcken, *Hermes*, xxviii. [1893] 161-193; Piccolomini, *Rendiconti della r. accad. dei Lincei, Classe di scienze morali*, etc., v. ii. [1893] 313-332; Warren, 24-28). This romance, probably written in the 1st cent. B.C., is knightly in tone, as distinguished from the *bourgeois* novel of the later period, and Warren (p. 27) very plausibly suggests that 'its kind descended from the old epic poetry by the intermediary of prose versions; that in these versions, destined wholly for popular use, the element of love played a constantly increasing part, in accordance with the trend of sentiment among the people; and that, when one day some literary man of talent looked about for a new theme to introduce into literature, he found these traditional narratives awaiting his pleasure. It would be no difficult work to give them a literary finish, to expand certain descriptions in the rhetorical manner of the time, and to add certain details which would make the production more artistic and more vivid. The story of Nimrod would then be an imitation of one of these romances founded on national legends, substituting for them similar traditions of another race. They would, therefore, appeal to the readers of Alexandria and the cities of Syria as an acceptable departure from the time-worn paths of Hellenic story.'

The history of the Greek romance has been so thoroughly discussed by Rohde, in the work already mentioned (cf. also Warren, 21-81), and collected editions of all these writers are so readily accessible (by Hercher, 2 vols., Leipzig, 1858-59, and by Hirschig, Le Bas, Lapaume, and Boissonade [with Lat. tr.], Paris, 1885) that it will be possible to dismiss them very briefly. The earliest of the *bourgeois* romancers was Iamblichus, a Syrian of the second half of the 2nd cent., whose *Babyloniaca* is extant only in the summary given by Photius (*Bibl.* xciv.). He was followed, probably late in the 2nd or early in the 3rd cent., by the Ephesian Xenophon, the author of the *Ephesiaca* (Germ. tr. by Krabinger, Munich, 1831; and by Bürger, *Sämmtliche Werke*, Göttingen, 1844, ii. 436 ff.), recounting the loves of Anthia and Abrocomas. Then came, between the second half of the 3rd and the second half of the 4th cent., Heliodorus (probably a Neo-Pythagorean, rather than the bishop of Tricca with whom he was formerly identified), whose *Æthiopica* (Eng. tr. by R. Smith, *Greek Romances*, London, 1855, pp. 1-260), treating of the loves of Theagenes and Chariclea, was imitated, in the 12th cent., by the Byzantine Theodorus Prodromus in his romance of *Rhodanthe and*

Dosicles, which, later in the same century, was in its turn utilized by Nicetas Eugenianus in his versified *Drosilla and Charicles*. To the second half of the 5th cent. belongs the Alexandrine Achilles Tatius, the author of the romance of *Clitophon and Leucippe* (Eng. tr. by Smith, pp. 349-511), which was imitated, probably early in the period of the Comnenæ, by Eustathius, in his *Loves of Hysmine and Hysminias*. The last of the Greek romancers proper was Chariton, whose home and date are alike unknown, and whose *Chæreas and Callirrhoe* shows the utter decay of the Greek novel.

These novels, filled with wild adventures, and with tedious prolixity, are scarcely to the taste of the modern reader. There is, however, one Greek romance which has justly received admiration. This is, it need scarcely be said, the pastoral romance of *Daphnis and Chloe* of Longos, who flourished after the 2nd cent. (Eng. tr. by Smith, 263-347). With all its defects, such as the insipidity and the incredible innocence of its hero and heroine, the pastoral expresses a love of Nature which still makes appeal to the modern mind.

Some of the Byzantine authors of romances have already been mentioned (for further details, see Krumbacher, *Gesch. der byzant. Lit.*, Munich, 1897, pp. 641-643, 854-872; Rohde, 554 ff.), and we may note that during this period the romances of Western Europe were laid under requisition by Byzantine romancers, thus marking the close of the native novel of Greece.

(k) *Latin*.—The existence of *Märchen* and children's tales—of which all trace has long since vanished—is hinted at by Persius, when he describes the old nurse quieting the fretful child (*Sat.* ii. 35-38):

'Tunc manibus quatit et spem macram supplice voto
Nunc Licini in campos, nunc Crassi mittit in ædes;
Hunc optent generum rex et regina; puellam
Hunc rapiant; quicquid calcaverit hic, rosa fiat.'

We also know that Sisenna (119-67 B.C.) translated the indecent *Milesiaca* of Aristides, apparently a collection of brief anecdotes of low life in Miletus (Rohde, 584-587; the ten scanty fragments ed. Bücheler, *Petronii Satiræ*, Berlin, 1882, p. 237 f.); and attention has already been directed to the *Metamorphoses* of Apuleius (ed. Hildebrand, Leipzig, 1842). By far the most important monument of Latin fiction, however, is found in the *Satiræ* of Petronius (1st cent. A.D.; Eng. tr. by Kelly, London, 1856, and of the episode of Trimalchio's Supper by Peck, New York, 1898). This grossly immoral novel is realistic to the last degree, but only one episode has survived with any completeness—the 'Supper of Trimalchio,' a rich *parvenu*. Apart from its description of low life, the romance is more interesting to the student of folk-Latin than to the historian of fiction. To the decaying period of Latin literature belong a series of historical romances which are either known or suspected to be translations from Greek originals. To the former category belong the *Res gestæ Alexandri Magni* of Julius Valerius (end of the 3rd or first third of the 4th cent.; ed. Kübler, Leipzig, 1888), a version of the Alexander-romance of the pseudo-Callisthenes (on whom see especially Rohde, 197-203; ed. Müller, Paris, 1846), and the 6th cent. *Historia Apollonii regis Tyri* (Rohde, 435-453; ed. Riese, Leipzig, 1871); while the second class includes the legends of the destruction of Troy ascribed to Dictys of Crete (second half of the 4th cent.; ed. Meister, Leipzig, 1872), and Dares the Phrygian (second half of the 5th cent.; ed. Meister, *op. cit.*; on all these authors see Teuffel-Schwabe, *Gesch. der röm. Lit.*, 1890, pp. 86 f., 922 f., 743-748, 1006 f., 1272-1274, 1075-1078, 1209-1211).

In the mediæval period, Latin fiction consists solely of short *Märchen*, frequently collected for the purpose of edification, elaborate morals being very often appended, as in the famous *Gesta Romanorum* (ed. Oesterley, Berlin, 1872; Eng. tr. by Hooper, London, 1894), other collections being the *Disciplina clericalis* of Petrus Alphonsus (ed. Schmidt, Berlin, 1827), the *Historia septem sapientium* (ed. Buchner, Erlangen, 1889), the *Dolopathos* of Johannes de Alta Silva (ed. Oesterley, Strassburg, 1873), the *Exempla* of Jacques de Vitry (ed. Crane, London, 1890), and the *Tractatus de diversis materiis predicabilibus* of Etienne de Bourbon (Lecoy de la Marche, *Anecdotes historiques, légendes et apologues . . . d'Étienne de Bourbon*, Paris, 1877; for a good general collection of specimens of this literature, see Ulrich, *Proben der lat. Novellistik des Mittelalters*, Leipzig, 1906). But to all intents and purposes we pass, with the close of the Greek romance, directly to the fiction of mediæval and modern Europe.

LITERATURE.—This is given in the course of the art. and in the bibliography appended to the following article. Copious extracts from the Chinese and Japanese romances are given by Giles and Aston in the works mentioned above, and exhaustive summaries and analyses of the Greek romance are to be found in Rohde, Dunlop, and—more briefly—Warren.

LOUIS H. GRAY.

FICTION (Mediæval and Modern).—When we pass from the Greek romances to the earliest essays in fiction among the modern nations, or, at least, the earliest which have been preserved to us, we find the great majority of them first sung, and then written, in verse; nor need we, as Dunlop arbitrarily did in the history which has been so often referred to in modern discussions of the novel, exclude metrical narratives from our survey. In the Middle Ages there was no marked dividing line, as to content and spirit, between tales in verse and tales in prose. It was not until the Renaissance had re-discovered the ancient models that the verse-tale developed, formally and artistically, away from prose, with methods and standards of its own.

1. The oldest extant works of fiction which come to us from the Dark Ages belong to the Teutonic races; the Romance languages were slow to develop pure literature in the vernacular, because Latin was still so familiar to those who cared for literary form. The primitive beginnings of fiction among the northern tribes can only be conjectured. We can see how it may have passed from mere boastful recital of the warlike exploits of a tribal hero to half-conscious, emulous exaggeration of them; and then, when the warrior's victory over all human foes had become so much a matter of course as to pall upon the hearers, the story-teller had recourse, in the oldest extant specimen of Teutonic narrative, going back probably to the 6th century—in the *Beowulf*—to the introduction of superhuman foes to be conquered by sheer strength and courage. The plot is scarcely more than a succession of events; of emotional expression there is little, of character-study almost none, except in the episode of Wiglaf (possibly, for that reason, of later date). But the very exclusion of purely magic elements leads in a modern direction; and, far removed as the rude barbarism of the setting is from courtly knight-hood, the description of the old king rejoicing, as he dies, because he has won great treasure not for himself but for his people, already contains the inmost essence of chivalry.

In a number of the northern sagas, and most fully of all, perhaps, in the *Nibelungenlied*, an unconscious advance towards the unity which more civilized standards of art require is the result of the gloomy fatalism of the northern nations. Over all the action broods the shadow of Fate, *Wyrd*, huge and inexorable; the hero is doomed, his destiny is

predetermined (see DOOM, DOOM MYTHS). In the *Nibelungenlied* the tragic end is kept in view with an almost Sophoclean consistency. Here again the singer or singers pushed magic into the background, using it chiefly for omens and unheeded warnings of doom, and told a simple tale of the tragedy of human life, making the characters act (so far as the traditional outline of the story allowed) as men and women would be likely to do.

2. Although the best French scholars, such as Gaston Paris (*Romania*, xiii. [1884] 610) and Léon Gautier (in Petit de Julleville, *Hist. de la langue et de la littérature françaises*, Paris, 1896-99, i. 53), admit that the French epic is of Germanic origin, the French were the acknowledged masters of the metrical romance in its later form. The oldest monument of their fiction, the *Chanson de Roland*, is composed of elements that do not differ very widely from those of the Norse sagas; but the long series of verse-tales, which for two or three centuries delighted courtly audiences, interwove, in a way which must have been highly entertaining at the time, the three great interests of the Middle Ages—battle, love, and religion. Love had scarcely suggested itself to the older 'makers' as offering scope for literary treatment. Fighting and feasting were men's chief employments in those days, and the staple of their songs: even in the 11th cent. *Chanson de Roland* we are told that the hero's betrothed fell dead of grief on hearing of his death, but otherwise she contributes nothing to the story. With the development, however, of an elaborate code of chivalrous behaviour, those who, like Spenser long afterwards, sang 'of knights' and ladies' gentle deeds' had abundant material for their portrayal of the life which was familiar to their audience; for, whether they sang the story of Thebes or the fall of Troy, the exploits of Charlemagne and his peers, or the fortunes of Arthur and the Round Table, all alike visualized their heroes—Greek or Trojan though they might be—as knights of their own day.

3. After the grave, majestic, national epic, with something of the austere aloofness of religion in its spirit, came (about the beginning of the 12th cent.) the light, bright courtly romance, delighting in the description of tourneys and pageants, and full of the passion and the subtlety of love—a school of perfection for women, an inspirer of valour and all chivalrous qualities for men. The whole story of the Grail (*q. v.*)—in the hands, e.g., of Chrétien de Troyes, or as it was worked over by Wolfram von Eschenbach in his German *Parzival*—was full of suggestion of a wistful longing for superhuman holiness and beauty, which made it an excellent example for those who gave it such devout credence. When, in the 16th cent., the purblind Ascham (*Schoolmaster*, bk. i.) could see nothing but 'open mans slaughter and bold bawdrye' in Malory's exquisitely beautiful prose version of the Arthur story (finished about 1467, first printed by Caxton in 1485), it only showed how the Renaissance standards had blinded the eyes of their enthusiastic converts to the simple beauty of mediæval life. The moral sweetness of the best of these romances of native English workmanship, *Sir Gawayne and the Green Knight* (13th cent.), is one of its many special charms.

4. The mediæval habit of vivid personification of virtues and vices as unseen allies and adversaries in the spiritual combat led, in the same century, to the rise of allegory. The most famous and notable type of this is the great *Roman de la Rose* (begun c. 1235 by Guillaume de Lorris, finished c. 1275 by Jean de Meung). Those who cannot appreciate this work need never hope to understand the spirit of the Middle Ages. About the time, a century later, when Chaucer was translating it into English, William Langland was using the same sort of

allegorical machinery to deliver his message to the common people in *Piers Plowman*.

The 13th cent. also saw the rise of a considerable body of prose versions of the same material—besides some admirable specimens, like *Aucassin et Nicolette*, of the short prose tale in which the French were afterwards to hold such high rank. The great *Lancelot* in prose (compiled c. 1220) became the definite type in France of these chivalrous tales, which they followed until, in the 15th cent., printing gave them a new lease of life.

5. Before we pass to the development which the romance of chivalry had in Spain, it will be well to realize that, as happened in that country in the 16th cent., so in France, before the close of the Middle Ages, the common people, wearying of a type of fiction which seemed to touch so little the life and the interests they knew best, created, by their demand for other kinds of tales, a new style of literature. That such people are not necessarily averse from reading about the doings of those above them in the social scale is evident enough from the vogue enjoyed by stories of the type offered in England by the *Family Herald* and in America by the novels of several writers whose public is found exclusively among the humbler classes. But the romances of chivalry were so oblivious of the life of the commons that they could not make any very wide appeal; and so by degrees, especially as the towns grew larger and the *bourgeois* class became more numerous, they asked for a livelier, more humorous treatment of life on its lower levels. Thus grew up many of the large class of stories to which the name of *fabliaux* is applied in its stricter or more modern sense—short tales in verse dealing, for the most part from the comic point of view, with incidents of ordinary life, moving, on the one hand, into moral apologues and, on the other, into sentimental legends. Their usual characteristic of unvarnished realism has been attributed, by those who hold the theory of an Oriental origin for most of them, to the necessity felt by their Western adapters of studying the manners of thought and speech prevalent among their audience. The *fabliaux* are, as a rule, intended to cause laughter, which sprang up easily in the Middle Ages: frequently cynical, sometimes satirical, usually coarse. They are the poetry of the market-place, existing (1150–1350) contemporaneously with the soaring idealism of the kind which offers so complete a contrast, the poetry of the castle.

The people have less time to sit still and listen to a story than the nobles; and therefore, as they begin to have more to say about the making of fiction than before, there is a tendency to desert the interminable length of the romances for a variety of short, pithy tales, of which what we may call the germ appears in the universally popular *Gesta Romanorum*. There is the new love for fables after the manner of Aesop; growing out of them there is the interesting class of animal stories of which *Reinhart Fuchs* and the French *Roman de Renard* are the types, resembling, in their *naïveté* and their shrewd philosophy, rather the stories of 'Brer Fox' and 'Brer Rabbit,' which have delighted a recent generation, than the sophisticated echo of E. Rostand's *Chantecler*; and in Italy especially there is a large number of short stories, then and there called *novelle*, carrying on (much in the spirit of the *fabliaux*) the tradition of Boccaccio and Sacchetti, through Masuccio and Pulci in the 15th cent., to the *novellieri* of the 16th century.

6. It is much less possible in the Middle Ages than later to make a sharp distinction between the literary style of the nascent modern nations, owing to the cosmopolitan or 'universal' character of the education of those who had the development of letters in their hands. But the case is different

when, in our historical survey, we reach *Amadis de Gaula*, the first and best of the great body of *libros de caballerias*, or romances of chivalry, which formed for a century or more the favourite literature of the Spanish people and stood in the direct line of descent towards the modern novel. Whatever its primitive sources—going back certainly to the 13th century—it took its final shape from the hands of Garcia Ordoñez de Montalvo, probably between 1492 and 1504, though it is not known to have appeared in print before 1519. Although this famous story and the class which it heads are not of Spanish origin, and although they inherit their material and take their spirit from the rather universal *chansons de gestes*, through the *romans d'aventures*, yet it was in Spain, and as stamped with a Spanish character, that they acquired their importance in the development of prose fiction. Montalvo's prototype was followed by a long series of successors and another almost equally famous family, that of the Palmerines, the best known of these being the *Palmerin de Inglaterra*, probably written by Luis Hurtado of Toledo. Most of these stories are anonymous or of uncertain authorship; they were really the creation of the age which devoured them so eagerly—almost literally devoured them, for of most only a few worn copies exist to-day.

That, as has been often said by those who take Cervantes' half-humorous boast too seriously, these romances were killed by *Don Quixote* may easily be disproved. It was precisely because their popularity was already waning, and because by the end of the 16th cent. their reproduction of the mediæval attitude was out of harmony with the age, that the brilliant burlesque of Cervantes made such an appeal to the new generation. Montesquieu's jest that Spain had produced only one good book, which was written to prove the absurdity of all the others, is merely a flippant statement of the truth that the one Spanish book which the whole world has taken to itself is *Don Quixote* (1605). That 'rare combination of the permanent with the individual,' to which Coleridge attributes its phenomenal popularity, is important for its bearing on the question of the realism and idealism to be discussed later in this article.

7. But the romances of chivalry were in any case, as has been said, nearing the close of their career. Their place was to be taken by a form of fiction which, however little worthy of respect it may be in the abstract, was destined to have greater influence on the modern world. 'The fate of the *novelas de picares*,' says D. Hannay (*The Later Renaissance*, Edinburgh, 1898, p. 136), 'is one of the most curious in literature. But for them, and their popularity outside of Spain, there could not well have been any *Gil Blas*; and without him the history of modern prose fiction must have been very different.' Like the *fabliaux*, they represent a revolt of the common, ordinary, more or less discontented humanity of the day against the endless iteration of the aristocratic adventures and high-flown sentiment of the 'chivalry way of writing.' By a definite reaction they substitute the poor man for the knight, and low or sordid motives for the high. As monotonous as the kind they replaced, often silly in their farcical fun, and no more true to life as a whole than the heroic tales, they had from the first an immense popularity, both in the land of their birth and in other countries. Discarding tradition and imagination in favour of observation as the source of their material, they gave to realistic fiction both its method and its point of view, substantially as they are at the present day. Only, the Continental followers—Le Sage, Balzac, Tolstoi—saw, like their literary ancestors, chiefly the evil in the world of every day; it was reserved for some happy, healthy Englishmen (Fielding, Thackeray)

to paint the triumphs as well as the trials of the common man.

The first in this epoch-making series of picaresque romances (Span. *pícaro*, 'rogue') was the *Vida de Lazarillo de Tormés* (author uncertain; first known edition 1553). Extending to no more than fifty pages of ordinary print, it was a small thing to produce such marked results; but it soon had a host of imitators. The next was larger, the *Guzman de Alfarache* of Mateo Aleman (1599), which was at once translated into every language of civilized Europe, including Latin. Five years before its publication, Thomas Nash brought out in England a book with a strong similarity to *Lazarillo*—*The Unfortunate Traveller*, which has been called, from another point of view, the first English historical novel. J. J. Jusserand (*The English Novel in the Time of Shakespeare*, p. 347) goes even further, and says that Nash first pointed out the road that was to lead to the true novel, in that he was the first 'to endeavour to relate in prose a long sustained story, having for its chief concern the truth.' The time was scarcely ripe, however, for the picaresque novel in England; and, when Defoe took up this model, it was Le Sage who taught him.

While his French contemporaries were looking towards England, Le Sage, as a loyal subject of Louis XIV., forgot that the Pyrenees existed, and reproduced the Spanish setting so exactly that some critics of that nation have even set up a theory that he was a mere translator. But, though his characters wear the Castilian costume, they have a French wit and vivacity—and the passions of humanity. The master of Defoe and of Fielding, and to no slight extent the inspirer of Dickens, Le Sage shows in *Gil Blas* (1715-24-35) absolute truth to human nature, as distinct from truth to this or that national characteristic; and it is precisely this quality which he brought into novel-writing that constitutes his principal claim to high rank as a contributor to the development of prose fiction.

8. We have now traced one line of descent down to the realist Fielding, and it will be necessary to go back and follow the course of another, parallel in time, though not in direction, since it leads to quite a different conclusion. This is the pastoral romance, which had its origin in Italy, though it, too, attained its most characteristic and influential form in Spain. Two famous Italian works—both mingled prose and verse—stand out prominently among the models: Boccaccio's *L'Amato*, written in 1341 or 1342; and Sannazzaro's *Arcadia* (1504). Although to both the pastoral form was a venerated inheritance through Vergil from Theocritus and the other Greek idyllists, there is a marked difference in the appeal which it makes to each. Boccaccio, writing in 'the first fine careless rapture' of the Renaissance, was as full of hope for the perfection of humanity as was Sir Thomas More in his *Utopia* (whose date, 1515, is not far from corresponding with the effective beginning of the English Renaissance in the same proportion as Boccaccio's with that of the Italian); by the time Sannazzaro wrote, the dawn-flush of hope had died away, and the disillusioned world turned to the simple pastoral life as an escape from unpleasant reality, charmed by the contrast, as were Louis XVI. and Marie Antoinette when they escaped from Versailles to play shepherd and shepherdess at the Trianon. It is in this spirit that Sidney's *Arcadia* (1590; begun 1580, when he was banished from court) is written. In the allegorical pastoralists, from Vergil to Spagnuoli, the note of longing for escape to an ideal life is scarcely heard; in Sannazzaro the desire of freedom from reality is strong.

The most important contribution made by Spain

to the pastoral romance was the *Diana* of Jorge de Montemayor (c. 1560), which not only furnished a model to Sidney and a plot to Shakespeare (*Two Gentlemen of Verona*), but holds a place in the evolution of the modern novel second in importance to that of *Amadis de Gaula* alone. Here the adherence to the circumstances of actual life is closer than in Italy; it is modified to some extent by elements borrowed from the older chivalric tradition; and it leads directly along the road to the fashionable pastoral of France. Of this the most consummate example is Honoré d'Urfé's *Astrée* (1612). Literature still was, in the main, the possession of the privileged classes; and the movement in France towards a greater refinement of speech and manners which, not long after the publication of d'Urfé's romance, centred in the Hôtel de Rambouillet was of a kind to make fashionable throughout the century the high-flown sentiment of such writers as Mme. de Lafayette and Mlle. de Scudéry. The outcome of this succession was slow in making itself apparent.

9. The conventional grace of the pastoral could offer no material to the realistic novel; but, when the tide of sentimentalism at last broke through the restraining barriers—when, after two generations of Cartesianism and scepticism, the emotional soul of Jean Jacques Rousseau was aroused to action by the kindred sentimentality which went out to meet him from the pages of the *Astrée*—the true career of the Spanish pastoral had begun. The melancholy of unrequited love, and the sad complaints of Sireno, are repeated in the longings of Saint-Preux and in the despair of Werther. The sentimentality of *Diana* developed into the sensibility of *La Nouvelle Héloïse*.

The influence of the Puritan middle class in England had a marked effect on the 18th cent. history of fiction there. Imbued with the idea of the paramount importance of saving their souls, and of the difficulty of the task, they thought it at best a sinful waste of time to read tales of amorous or martial adventure for mere diversion; and the greatest English story-teller of the early years of that century, Defoe, was obliged to conform to this prejudice by giving his tales a colour of truth. His success may be judged by the unfriendly criticism of a contemporary who speaks of 'the little art he is so truly master of, of forging a story and imposing it on the world for truth'; and how long this unreasoning prejudice continued may be realized by those who will recall the frequent occurrence in novels of the first half of the 19th cent. of the footnote 'A fact,' which was still supposed to add value to the incident related. Defoe, then, wrote fictitious biography with a lifelike reality never surpassed; the element of plot was at hand in the love-stories drawn from contemporary life which formed the staple of the popular drama; and Addison was already, in the *Spectator*, showing himself a master in the subtle delineation of character. It is not surprising, therefore, that, before the century was half over, Richardson had produced the first English novels in the full or strict sense of the word—perhaps we may say the first novels, dismissing the claims made by the French, with pardonable patriotic pride, for Prévost and Marivaux—*Pamela* (1740), *Clarissa Harlowe* (1749), and *Sir Charles Grandison* (1753).

In his object, which he declared to be 'to promote the cause of religion and virtue,' Richardson was in line with the Puritan tradition; and of his notable achievement, the production for the first time of a work of non-dramatic prose fiction guided throughout its course by a single motive, in which all the incidents serve to bring about a definite result, he does not seem to have been conscious himself. He calls *Clarissa* 'a dramatic narrative';

and, since here, as in the other two books, the entire story is told by means of letters, the characters speaking for themselves as on the stage, we may understand that what he really intended to do was not to create a new genus in literature, but to write what should be practically a 'pocket play.' Hence the presence of a plot, which, from the Renaissance down, the English drama had known how to offer, all the while that the romances were as loose and formless as ever. Fielding, a more conscious artist (he speaks of himself in *Tom Jones* as 'in reality the founder of a new province of writing'), calls the novel a comic epic in prose; as the epic is an enlarged tragedy, so this new form of his is an enlarged comedy. Among the principles he lays down for it are that it is to show real life, in contrast to the old romances at which he jeers, and that it must aim to show people the folly as well as the wickedness of all dishonesty.

The time was now at hand when a more decided place than ever before was to be given to emotion or passion. Emotion had been deliberately suppressed by the Neo-Classic literary leaders; in Horace's vivid phrase (*Ep.* I. x. 24), they had thrown it out with a pitchfork—and the hour was now approaching when, as he predicted, it should return. It is the vindication of the place of emotion which explains the extent of Richardson's fame in his own age—a fame that was not confined to England, but spread to France, where Diderot ranked him with Euripides and Homer, and to Germany, where the greatest writers seized on his design. The reaction from the conventional suppression of feeling swung to the opposite extreme. Sterne, Rousseau, and Goethe unchained sentiment and allowed it to rush into every imaginable excess. *La Nouvelle Héloïse* (1756), *Tristram Shandy* (1760), and *Die Leiden des jungen Werther* (1774) showed this impulse, and carried it further. The *Sentimental Journey* (1768) speaks in its very title of the quest of feeling, not merely the surrender to it; and Goethe's melancholy hero was the idol of an enthusiastic young generation, reproducing himself west of the Rhine in Chateaubriand's morbid *René* (1801).

10. A similar reaction to that which brought about the reign of sentiment accounted for the popularity of the mediæval or Gothic romance in the closing years of the 18th century. The first specimen worth noting was Horace Walpole's *Castle of Otranto* (1765), in which he tried to paint the life and manners of the feudal period, 'as agitated by the action of supernatural machinery such as the superstition of the time might have accepted.' The classical age had thrust out the supernatural too, or at least kept it rigorously in its place; and now it also was revenging itself. Beckford's *Vathek* (1784), Mrs. Radcliffe's *Mysteries of Udolpho* (1794), and Lewis's *Monk* (1795) are the most famous of this class.

11. The last named professed no other purpose than the amusement of their readers; but there was another side of the Romantic Movement which employed the novel for quite other ends. The earliest notable example of what we now call the novel of purpose is *Caleb Williams* (1794), in which the revolutionary philosopher William Godwin set forth his principles of social justice. It was to have a number of greater successors—although, perhaps from the difficulty of giving a definitely didactic purpose to a work of art, the number is not large. But that the kind exists as a recognized class is significant of the immense broadening of the scope of the novel which constitutes the most obvious difference between that of the 18th and that of the 19th century. The greatly increased complexity of life was one reason why the drama could no longer be, as in the Elizabethan age, the

characteristic literary form. Something more flexible was needed, and something which (with the vast growth in the number of those who demanded mental food) could be carried into a million homes remote from cities and theatres. The novelists of the 18th, or even of the early 19th, cent. did not dream of the expansion which their form was to acquire. To realize the extent of the change, it is only necessary to imagine the puzzled amazement with which Sir Walter Scott would read one of Mrs. Humphry Ward's sociological novels, such as *Marcella* or *Sir George Tressady*. This sort of novel has been written principally by English and American authors, and in the last half-century by the Russians; while, in his novels dealing with the Modernist controversy, Fogazzaro in Italy reminds us again of Mrs. Ward's *Robert Elsmere* and its sequel of thirty years later.

12. As *Caleb Williams* was the forerunner of *Uncle Tom's Cabin* and *Oliver Twist*, so the extravagant mystery tales of Walpole and Mrs. Radcliffe developed, with the growth of a more accurate knowledge of the life of the past, into the historical novel. The first successful practitioner in this form (after vain efforts which may be said to cover two thousand years, if we stretch the definition to include Xenophon's *Cyropædia*) was, by common consent, Sir Walter Scott. Avoiding the stiff pedantry of reproducing with antiquarian accuracy the exact speech and manners of the period in which his scene was laid, and the obvious absurdity of using those of his own day, he created, with the instinct of genius, a symbolic medium which should give the flavour of the old times without repelling the ordinary reader by its unfamiliarity. The thing once done, a host of others followed along the same road. In English the height was reached in Thackeray's *Henry Esmond*; in France the splendid achievement of Dumas was, by his own confession, made possible only by the example of Scott. The Germans, represented, for instance, by Georg Ebers, have had a tendency to display too much of that devotion to scientific accuracy which so honourably characterizes their work in other fields, and to allow their facts to be fused too little in the fire of the imagination.

13. Towards the middle of the 19th cent., as a conscious theory first in France, realism came to the front. It was partly nourished on a Romantic inheritance—the love of exact detail learned from Scott in the novel and from the Germans in the drama, and the interest in the humblest humanity taught by Dickens. Balzac—a materialist at heart, for all his authoritarian proclamation of religious principles—studied French life in the spirit of a naturalist, a zoologist; the novel with him became an auxiliary to history instead of a work of imagination and passion. Realism in literature does not always explain itself by the same philosophy; but in the 19th cent. it was the child of sensualism (in the philosophic meaning of the word) of two different kinds—the simple traditional sensualism of Condillac, which served Gautier and Flaubert as a basis for their theory of 'art for art's sake'; and the scientific sensualism established by Comte under the name of Positivism (*q.v.*), which inspired the utilitarian realism of Zola. The art of Flaubert, a development from Balzac, carried realism, if not in *Madame Bovary*, at least in *L'Education sentimentale*, as far as it could well go without ceasing to be art. It was the boast of Zola that he had taken the thing up where Flaubert left it, and that he had carried it to its logical conclusion. The experimental novel (as he chose to call it, taking the name of a book of Claude Bernard, *La Médecine expérimentale*)

'is a consequence of the scientific evolution of the age; it continues and completes the work of the physiologist . . . it is

the literature of our scientific era, as classical and romantic literature corresponded to an age of scholasticism and theology' (*Le Roman expérimental*, p. 22).

But, with all his pride in his theories, Zola did not see what a fatal admission he had made when he said (*Le Naturalisme au théâtre*, 1881, p. 111): 'The realistic novel is a corner of Nature seen through a temperament'—'through a formula' would perhaps more aptly describe the result in his own case. He sees in humanity simply *la bête humaine*—the beast in all its transformations, but only the beast. This rather common characteristic of what is called 'realistic fiction' may, one supposes, be explained by the fact that we are more easily convinced by the verisimilitude of evil than by that of good: if a saint is described from exact observation, the reader will be instinctively inclined to credit the description to the idealistic imagination of the writer.

The term 'realism,' of course, has been used in various senses—now as opposed to conventionalism, now to idealism, now to the imaginative treatment, and again to sentimentalism. Bliss Perry's definition may be quoted: 'Realistic fiction is that which does not shrink from the commonplace or from the unpleasant in the effort to depict things as they are, life as it is' (*A Study of Prose Fiction*, p. 229). If literature is to be a transcript of actual existence, if books are not to be, as the invalid Stevenson said of them in a wistful mood, 'a mighty pale and bloodless substitute for life,' there is much to be said for truthful portraiture; and it cannot be denied that much of the effect of the most famous work of the earliest master of English prose fiction, *Robinson Crusoe*, comes from its wealth of exact and vivid detail.

14. But in the broadest sense of the question, from the ethical standpoint, which rather than the purely technical must of necessity be that of the present article, there seems little doubt that the idealistic treatment, within reasonable limits, is to be preferred. If fiction is read for mere distraction and relief, we see enough of real life, in all its sordid, unpleasant detail, to be glad, when we take up a book, to find our feet set on some pavement pleasanter to tread than even the most faithful reproduction of an exceedingly muddy street. And, now that the old Puritan scruple against spending time in the reading of fiction has almost vanished, and the circle of readers has widened to include those who are most in need of encouragement for their better impulses, it cannot be questioned that the kind of reading which provides them with high examples is the best in its effect. The lady who wrote under the name of 'Ouida' used to be considered eminently unsuitable for admission to Sunday-school libraries; yet there is a very definite sense in which at least the greater part of her many books may be called far less immoral than most of Dickens', in whom a young man might search long before he found proposed to him any example of life so lofty and edifying as the (perhaps unduly handsome and impressive) hero of *Under Two Flags*. So, in the *Waverley Novels* 'life is seen at its bravest and its best; and the young man who takes them as his guide to conduct stands small chance of playing cripple or coward in human affairs.' We may not be fortunate enough to number among our acquaintances so noble a gentleman as Colonel Newcome; but there is none of us who will be the worse for passing an hour or two in his society by the help of Thackeray.

'I have no brain above the eyes,' Thackeray himself modestly said; 'I describe what I see'; and his contemporary Balzac, the author of the modern idea of the novel as a 'human document,' might more truly have said this. But Thackeray

undervalued his own powers—or else his vision was able to penetrate beneath the superficial appearances in a way that the realist seldom does. It is the ability to do this which makes the work of the idealist so much more abiding than that of the opposite school. They who depend (in Coleridge's judicial phrase) on 'the mere manners and modes of the day' will find their popularity waning—as that of Dickens has waned—when people are no longer able to be amused by recognizing the minute veracity of their portraiture. Thus we dismiss an old photograph after a cursory glance, and return to spend hours in gazing at the Sistine Madonna, true to the highest part of human nature after four hundred years. Thus Ben Jonson is read only by professed students of literature, while Shakespeare enters into the daily life of the whole English-speaking race.

15. Yet after the Romantic Movement, itself a reaction, had spent its force, it was only natural that naturalism should set in as a protest against the exaggerated idealism into which the Romantics sometimes ran. Still, in the first quarter of the 19th cent. Jane Austen had begun her career as a novelist by opposing to the extravagant sentiments and impossible situations of the 'Gothic' school her humorously sensible pictures of life as she saw it. And so throughout Europe, from the middle of the century, the French influence has been felt, and many of the best known novelists have been thorough-going naturalists. In Spain, Pereda was the father of the movement; Juan Valera, though not technically a realist, was no less real; Emilia Pardo Bazán (Señora Quiroga) and the later Valdés have followed the same path. In Italy, Fogazzaro, Mathilde Serao, and d'Annunzio have been the most widely known representatives of the modern tendency. In the Scandinavian north, Bjørnson and Strindberg have won their renown under the same banner; while another Swede, Almqvist († 1866), had already anticipated some of the problems and contentions of the realists of the last quarter of the century.

The case of Russia is somewhat different from the others. The first novel in that language was published only in 1799, but a generation later began, with Gogol, the sudden efflorescence which startled and in no small degree influenced the Western world. As a matter of fact, though most of the results we have been considering were of French origin, Gogol had distinctly formulated the theory of the human document before the days of the Goncourts. One reason why Turgenieff and Dostoyefski and Tolstoi have made so deep an impression outside their own country is that the Russian novel is the novel of uncivilized people giving us their impressions of civilization, trying to find out the meaning of life as if no one had ever thought about the matter before; but a reason deeper still is the burning charity for suffering humanity which pervades their books. None of them has purely literary aims—they seek truth and justice: the difference between them and some French realists is the difference between the curious peeping visitor to a hospital and the man who comes aching to bring comfort and healing to the sufferers.

Into Germany, realism came from both sides, from France and from Russia; but the unconquerable idealism innate in the German character made this no thoroughly congenial soil for its growth. Max Kretzer promised to be the leading German realist, but supernaturalism took hold of him. Even Sudermann has not been consistently realistic; and Hauptmann, in spite of some pieces of brutal naturalism, has shown a tendency, which has also appeared in other quarters, to regard phenomena (found unsatis-

fyng in themselves) merely as symbols of deeper spiritual realities which are just as true and even more worthy of study.

16. In any survey of the fiction of the last fifty years, a special note must be made of the way in which some of the greatest writers of fiction have used the deeper, or at least more scientific, study of psychology which marks our modern age, thus giving rise to the psychological novel. It is this which gives to Browning's poetry a part at least of its great value; but a wider use of it has been made by the novelists. George Eliot wrote her novels even more with her psychology than with her ethics, and attained a vividness in portraying the inner life which the novel had not yet seen. But she did not stop with the individual analysis; she strove to make her case typical, and to show the working of the laws of the spiritual world, as immutable as those of the physical. The character-plot has tended to become the favourite form of the serious literary novel. Most of the noted writers of recent years, Turgenieff and Tolstoi and Dostoyefski in Russia, Meredith and Hardy in England, Henry James and Howells in America, Bourget in France, Björnson and Sudermann in the north, Valdés and d'Annunzio in the south, have attained their principal effect by the penetrating subtlety of their character-studies.

17. Yet in the fiction of the last twenty-five years, especially in English, there has been a significant reaction against the attempt to limit the purpose of the novel first to a painstaking study of phenomena and then to a deep analysis of their underlying causes. Suggested itself by Meredith's *Harry Richmond*, exactly a quarter of a century ago Stevenson's *Prince Otto* gave the signal for a new exodus into the 'by-path meadows' of romantic fiction, followed soon by Anthony Hope with his *Zenda* stories, and then by a host of minor romancers. Their number and their popularity, whether they have gone back for their subjects to the days 'when knighthood was in flower' or have laid their scene in some imaginary principality, are sufficient evidence of the existence of a large number of people prepared to welcome an escape from the increasing strenuousness of life into a world of play.

The main body, nevertheless, of the most important modern fiction, has been distinguished by a high seriousness not unbecoming to a branch of literature which is assuming such a predominant place and appears likely to keep it. The novel, from its flexibility best adapted to deal with the complexity of modern life, and as a pre-eminently social form of literature answering to the general tendencies of the age, has become the prevailing and characteristic literary form of our period; making its way against prejudice, and without assistance, it has supplanted the epic and the romance, it has taken precedence over the drama, over lyric poetry, and over the essay. When Dante mirrored the world of the Middle Ages in the *Divina Commedia*, says Arthur Symons (*Studies in Prose and Verse*, London, 1904, p. 5),

'poetry could still represent an age and yet be poetry. But to-day poetry can no longer represent more than the soul of things; it has taken refuge from the terrible improvements of civilization in a divine seclusion, where it sings, disregarding the many voices of the street. Prose comes, offering its infinite capacity for detail; and it is by the infinity of its detail that the novel, as Balzac created it, has become the modern epic.'

The increasing democratization of literature, allowing many a man to write with a slender equipment of education in the French sense, and often with only too little in the English, and giving a thirst for reading to thousands with almost none of either, constitutes a grave danger. The money rewards of the successful novelist allure to the profession not a few men destitute of any sense

of responsibility for the use of their gifts; and the fact that these rewards are often to be won by pandering to the unrefined or actually base tastes of the multitude throws a temptation in their way which some otherwise well-endowed writers have not been able to resist. But in the right hands the novel, by the very fact of its being so closely in touch with actual life, has a magnificent opportunity to take a large share in moulding the thought of the new age. It will do well if it listens to the suggestion of Matthew Arnold's often-quoted definition of poetry, and takes as its mission the offering of a constructive criticism of life.

LITERATURE.—J. C. Dunlop, *Hist. of Fiction*, ed. H. Wilson, 2 vols., London, 1896; Bliss Perry, *A Study of Prose Fiction*, New York, 1902; F. M. Warren, *History of the Novel previous to the Seventeenth Century*, do. 1895; W. L. Cross, *The Development of the English Novel*, do. 1899; F. H. Stoddard, *The Evolution of the English Novel*, do. 1900; C. F. Horne, *The Technique of the Novel*, do. 1908; S. Lanier, *The English Novel and its Development*, do. 1883; W. Besant, *The Art of Fiction*, London, 1884; C. E. Morgan, *The Rise of the Novel of Manners*, New York, 1911; B. W. Wells, *A Century of French Fiction*, do. 1898; F. Brunetière, *Le Roman naturaliste*, Paris, 1897; E. Zola, *Documents littéraires*, do. 1881, *Le Roman expérimental*², do. 1880, *Les Romanciers naturalistes*², do. 1881; Brander Matthews, *Aspects of Fiction*, New York, 1896, *The Historical Novel*, do. 1902, *The Philosophy of the Short Story*, do. 1901; F. Marion Crawford, *The Novel: What it is*, London, 1893; R. Fuerst, *Die Vorläufer der modernen Novelle*, Halle, 1897; Angelo de Gubernatis, *Storia del romanzo*, Milan, 1883; H. Keiter, *Versuch einer Theorie des Romans und der Erzählkunst*, Paderborn, 1876; E. Schmidt, *Richardson, Rousseau, und Goethe*, Jena, 1875; D. G. Thompson, *Philosophy of Fiction in Literature*, New York, 1890; W. W. Greg, *Pastoral Poetry and Drama*, London, 1906; F. W. Chandler, *Romances of Roguery*, New York, 1899; M. P. Conant, *The Oriental Tale in England in the Eighteenth Century*, do. 1908; Ossip-Lourié, *La Psychologie des romanciers russes du XIX^e siècle*, Paris, 1905; A. David-Sauvageot, *Le Réalisme et le naturalisme dans la littérature et dans l'art*, do. 1889; E. M. de Vogüé, *Le Roman russe*, do. 1886; Gaston Paris, *La Litt. française au moyen âge*², do. 1890; Pio Rajna, *Le Origini dell' epopea francese*, Florence, 1884; J. J. Jusserand, *The English Novel in the Time of Shakespeare*, London, 1890. A. I. DU PONT COLEMAN.

FIJI.—I. GEOGRAPHY, ETHNOLOGY, AND HISTORY.—The Archipelago of Fiji is one of the largest in the Pacific Ocean. The group comprises 154 islands lying between the latitudes of 15° and 19° S. and the longitudes of 177 E. and 178 W., of which about 70 are inhabited. Vitilevu, the largest island, is about 80 miles long and 55 wide. It is drained by four rivers, which, owing to the heavy rainfall and the formation of the watersheds, are disproportionately large for the size of the island. The scenery is infinitely varied and beautiful. Some of the islands are volcanic mountain masses clothed with timber to their summits; others are upheaved coral reefs with precipitous cliffs, honeycombed with caverns; others are low-lying, with palms growing to the water's edge. There are streams of limpid water everywhere, and in the larger islands are rolling plains of grass dotted with clumps of timber, as in an English park. The climate is tropical, but in the hottest months the temperature rarely reaches 90°. The soil is very fertile, and to an expert gardener like the Fijian it yields abundance of food for a very small expenditure of labour. There are no dangerous animals, and even the risks of navigation are minimized by the fact that all the larger islands may be coasted in smooth water within the barrier reef.

These facts have had their bearing upon the character of the natives, who are of Melanesian stock, strongly modified by the blood of Polynesian immigrants from Tonga and Samoa. They are a fine, muscular people of a dark-brown colour, inclining in individuals to the light red of the Polynesian. The custom of bleaching the hair with lime and frizzing it out like an enormous wig adds inches to their apparent stature. In heathen times

their abundant leisure from the business of food-planting was occupied in incessant warfare, which led to the formation of powerful confederations under a single chief, the weaker tribes enrolling themselves as his subjects in return for protection. As ancestor-worshippers they deserted their own discredited ancestor-gods in favour of those of their protector, whom they regarded as the incarnation of deities able to protect them from injury. Successful expeditions were always followed by cannibalism; the bodies of the slain were offered to the gods before being eaten, and there appears to have been a religious significance in the practice, which raised it almost to the status of a rite. But, with all their ferocity in war, the Fijians are a courteous and rather timid people, hospitable to visitors, anxious to please, ceremonious in their manners. They have a strong feeling for aristocratic institutions, which even the introduction of Western competition has failed to eradicate.

The islands came somewhat late into the field of colonization. Though they were sighted by Tasman in 1642, it was not until the middle of the 19th cent. that Europeans acquired much influence. By 1874 the majority of the natives had nominally adopted Christianity, either as Wesleyans or as Roman Catholics. In that year the most influential chiefs, acting under the pressure of claims for compensation by the United States, ceded the group to Great Britain, and Fiji became a British Colony. Unfortunately annexation had scarcely been proclaimed when an epidemic of measles swept away 40,000 natives out of a total population of 150,000. Since that date the population has declined year by year to a total of 87,000 in 1911. It now seems to be stationary. The natives are sharing, not altogether to their moral advantage, in the material prosperity of the islands, having leased their superfluous lands to Sugar Companies for a substantial rent. Nevertheless, many of their old superstitions are still cherished in secret, and are certain to influence them if there should ever be dangerous discontent with their alien rulers.

II. RELIGION.—The Fijian deities fall naturally into two great divisions, the *Kalou-Vu*¹ (root or original gods), and the *Kalou-Yalo* (spirit gods, i.e. deified mortals).

1. The *Kalou-Vu*.—There is reason to think that the *Kalou-Vu* were of Polynesian origin, brought to Fiji from the east, and imposed upon conquered Melanesians in addition to their own pantheon of deified mortals. Whether the *Kalou-Vu* ever existed as mortals is uncertain: at any rate, their mortal career was very remote. The Melanesians were ancestor-worshippers, and their religion was so closely interwoven with their social polity that it is impossible to disentangle them. The Melanesian idea was that the spirit of the ancestor was inherent in his descendant, the chief of the tribe, and in the smaller communities the chief was both spiritual and temporal. He was saluted in the same way as the spirit which was present in the temple, and the firstfruits (*q.v.*) were brought to him as representing the god of increase. As the community grew in importance by conquest or intrigue, the wielding of the temporal power became irksome, and the tendency was for the chief to delegate the executive duties of his office, while reserving for himself the dignity and emoluments due to his spiritual rank. Thus, in all the large confederations in Fiji except Kewa there was a spiritual *Roko Tui* and a temporal *Vunivalu*,

¹ The word *kalou* is used as an adjective for anything superlative, either good or bad. Probably the word was originally a root-word implying wonder or esteem. It is sometimes used as an expression of flattery—as 'You are *kalou*,' or 'a *kalou* people,' applied to Europeans either in polite disbelief in some invention or piece of mechanism, or as a disclaimer of any wish to imitate them. On *vu* see Codrington, *Melanesians*, 123, 170.

who were the analogues of the *Mikado* and the *Shogun* of Japan.

Not every chief was deified; the weak and vacillating or lethargic chief might have offerings made to his *manes* for a few months after his burial, but he was soon forgotten. In moments of danger or difficulty men would go and weed the grave of a powerful chief, and deposit offerings upon it because he was remembered by tradition as the protector of his people, and he remained the *Kalou-Yalo* of the tribe until the death of one of his descendants whose reputation overshadowed his.

(1) *Ndengei*, the most important of the *Kalou-Vu*, was an exception to the rule that the *Kalou-Vu* were Polynesian importations. The sagas relating to him prove clearly that he was a Melanesian ancestor, perhaps among the first Melanesian immigrants into the group (see *ERE* i. 443^o). *Ndengei*, in the form of an enormous serpent, was believed to inhabit a cave in the mountains of Vitilevu behind Rakiraki, at a place near Kouvandra. When the earth quaked the people said: 'Ndengei is turning over.' The people of the neighbourhood were severely taxed in offerings to him; every year several hundred hogs and turtles were carried to the mouth of the cavern, which the priests approached on knees and elbows. One of them ventured into the cave to proffer the request. If the prayer were for a good crop, he would reappear with a piece of yam in his hand which the god had given him; if for rain, he would be dripping with water; if for victory, a firebrand would be flung out in token that the enemy would be consumed, or the clashing of clubs would be heard, one for each of the enemy who would be slaughtered. *Ndengei* was not actually worshipped beyond the limit of his own district, but his reputation extended over all parts of the group except the eastern islands. His influence was probably declining before the arrival of the missionaries, for there is a humorous song in which Uto, his descendant, is represented as visiting the public feasts for the god's portion, and returning with the rueful intelligence that nothing but the under-shell of the turtle was allotted to him.

In some versions, *Ndengei* appears as the creator of mankind; but he has no emotions, sensations, or appetites, except that of hunger. Others have it that his son, *Rokomautu*, created the land; he scooped it up from the ocean-bed, and, where his flowing garment trailed across it, there were sandy beaches; where his skirt was looped up, the coast was rocky. It was he who taught men to make fire. The people of Rakiraki thought that the missionaries had come to teach them some variant of their own cult: 'Ndengei,' they said, 'is the true God, and, if Jehovah is also the true God, then Jehovah is another name for Ndengei.' Many years afterwards, during the heathen relapse under *Navosavakandua*, the same argument was used to show that his teaching did not clash with that of the mission, but was merely a newer revelation.

The great saga of *Ndengei* is too long to give within the limits of this article; it recounts how the god, then merely an irascible old man, as no doubt he was in his earthly career, had a tame pigeon which used to awaken him from slumber; how his two grand-nephews, from whom he had taken the bird, killed it with a bow and arrow and defied him to punish them; how they took refuge with *Rokola*, the chief of the Carpenter clan; how there was war in the sacred mountain, and the Carpenter clan were besieged by *Ndengei* in the fortress of Kouvandra; how, after many stratagems, in the end they were flooded out, and how the two young men escaped the deluge in a canoe, and sailed away to the far West. Fijian myth has it that some day they will come again, bring-

ing the millennium with them. When Europeans first arrived in the group, they were said to be the descendants of these two young gods.

This belief in the second coming of Ndengei's grand-nephews may reappear whenever there is political unrest among the Fijians. It was cleverly turned to account in the Tuka heresy in 1885, when Ndungumoi, a native of Nandrauni-ivi, a village very near Nakauvandra, went through the mountain district secretly preaching a religion which was a compound of the Ndengei cult and Christianity. He had with him consecrated water which conferred immortality (*tuka*) upon all who drank of it, and his followers were instructed in exercises which were midway between a native war-dance and European military drill. Recognizing that the Christian missions had too firm a hold upon the natives to be openly defied, he declared that Nathirikaumoli and Nakausambaria, the twins who had made war against Ndengei, were in reality the gods whom the white men called Jehovah and Jesus, being unable to pronounce their native names. There was some controversy about the identity of Ndengei, some holding that he was identical with the Christian God; others that he was Satan, since Satan also assumed a serpent form. Biblical names were given to the places near Nakauvandra. The twin gods were about to revisit Fiji with all the dead ancestors in their train; the white men were to be expelled, and the tribal lands were to be shared out among the faithful. A day was fixed for the arrival of the gods; and there can be no doubt that Europeans living in remote districts would have been massacred if the prophet had not been arrested and deported to Rotuma. In 1892 the heresy broke out afresh under a new prophet who had been Ndungumoi's lieutenant, but the movement was promptly suppressed by the Government.

It was evident from the behaviour of the converts that the heresy satisfied a religious craving for the occult, which is not appeased by the Wesleyan mission. Ndungumoi dealt in miracles; his water of immortality, his power to confer perpetual virginity, his communings with the gods behind a curtain in the temple of Valelembo, and his presages of the early coming of the ancestors and the expulsion of the foreigners kept the people in a simmer of excitement, which was in attractive contrast with the dull round of church-going and tax-paying imposed by the foreigners. This new form of ancestor-worship had much in common with the outbreak of Hauhaism among the Maoris during the Maori war, and it might well have been as dangerous to the safety of Europeans.

(2) Next in order to Ndengei is *Ndauthina* (the torch-bearer), the god of the seafaring and fishing tribes. These tribes own no land, and from the fact that they all worship the same god it may be inferred that they had a common origin. By the nature of their occupation, fishing tribes are prone to scatter widely, and the fact that they are landless seems to show that they are late arrivals, who attached themselves to the chief for protection. Such a people would naturally disseminate the traditions of their gods widely throughout the group. *Ndauthina*, though probably a foreign importation, had temples in various places. He was the fire-god; when he was small, his love of light prompted his mother to bind lighted reeds upon his head, and now he roams the reefs at night, crowned with a flaming brazier. He loves night attacks, and flashes light on the defences as a beacon to the besiegers; in human form he sells fish to the doomed garrison, who, smelling fire, know that *Ndauthina* has been among them, and that they will not see another sun. His pranks are past reckoning; when men are hatching plots against his favourites, a voice cries 'Pooh' through the reed-walls, and he flies off to warn his friends of the impending treachery. He tempts warriors to embark in rotten canoes which he himself buoys up, in order to put them at the mercy of their enemies. He is the god of adulterers, whom he helps by tempting the object of their desires. Only his worshippers, the fishermen, are safe from his tricks.

(3) *Ratu-mai-mbulu* (Lord from Hades), though worshipped as a local divinity in eastern Vitilevu, is also, no doubt, of foreign origin. Through him the earth gives her increase. In December he pours sap into the fruit-trees, and pushes the young shoots through the soil. Throughout that month it is tabu to beat the drum, to blow the conch, to dance, to plant, to fight, or to sing songs at sea, lest the god should be disturbed and quit the earth before his work is finished. At the end

of the month the priest sounds the consecrated conch, the people raise a great shout from village to village, and work and play begin again. *Ratu-mai-mbulu* lies in serpent form in a cavern near Namara, whither food is carried to him once a year. Unlike the other gods, he drinks no *kava*; the noise of the wind and the blast of the conch are meat and drink to him.

(4) *The shark-god*, who is the tutelary divinity of many tribes unrelated to one another, probably had his origin in totemism. Waterhouse gives the following list of names under which he is invoked: 'He-who-is-outside-the-Canoe'; 'Circumnavigator-of-Yandua'; 'Feeder-of-Fishes'; 'Lover-of-Canoe-Spars'; 'Waylayer'; 'Rover-of-the-Mangroves'; 'Expectant-Follower'; 'Ready-for-Action'; 'Sail-Cleaner'; 'Lord-Shark-that-Calls'; 'Tabu-white'; 'Tooth-for-Raw-Flesh.' Tribes that worshipped the shark under the same title had a common origin, but those who knew him by different names acknowledged no such bond. Thus, a tribe that called him 'Outside-the-Canoe' recognized no tie with those who invoked the 'Circumnavigator-of-Yandua.' As in other totemistic systems, the shark-god is beneficent to his worshippers who, in their turn, are forbidden to eat his flesh.

Mana, a native of Soro, capsized in the open sea, called upon 'Outside-the-Canoe' to save him, and a shark rose and towed him safe to land by his back fin. During the invasion of Natewa in 1848, a shark jumped across a war-canoe, turned over to show the tattooing on his belly, and leaped back into the sea to lead his votaries to the attack.

Though the attention paid to the shark-god almost entitles him to rank as a *Kalou-Vu*, he is probably no more than a totem, like the hawk, the eel, the lizard, and the prawn—all recognized as having a tutelary position with certain tribes, who nevertheless had erected temples to ancestor-gods (*Kalou-Yalo*). Totemism in Fiji did not affect the social system in any way; it had no influence on the marriage laws or on the belief in a future state.

2. *The Kalou-Yalo*.—It has been explained that most of the tribes in Fiji admitted a more or less close relationship to a tribe that worshipped the same ancestor-god; the tie was called *tauvu* ('the same root'). (See *ERE* i. 443^b.) It does not follow that the god to whom the tie of *tauvu* was traced had a temple and a priest in both the communities. In most cases, some later chief of strong character had monopolized the religious instincts of his descendants, and much depended upon the priest, for the chief exercised no sacerdotal function himself, but was content to stand aside, and leave this rather menial office to the professional priesthood.

That the origin of the temple was to be found in the tomb was shown in 1895, in the little native revolt at Seankanka, in Vanualevu, where the first act of the insurgents was to weed the grave of the late chief and present *kava* to his spirit, imploring his aid in the revolt; the next was to kill and eat a native Government official, cannibalism having a religious significance. From weeding a grave it was but a step to building a temple for the shelter of the spirit.

3. *Priests and oracles*.—The practical application of the Fijian religion lay in the oracle; there was no ritual except in the presentation of offerings, and everything depended upon the support of the high chiefs. Whether they believed in the inspiration of the priests, or whether the priests believed in their own inspiration, it is not easy to say, but there was certainly an understanding between the two orders; the priest depended for subsistence upon the offerings made to the god, and the priest whose oracles were unfavourable to the chief's policy saw his temple falling into decay and his larder empty. On the other hand, unfavourable oracles, especially in time of war, had so depressing an influence upon the common people that the chief had the best reason for keeping the priest in

good humour; both knew that neither could stand firm without the support of the other.

Williams (in his *Fiji and the Fijians*) relates how the king of Thakaundrove, on the eve of a warlike expedition, allowed one of the gods to be put off with a single pudding, instead of the turtle which the priest had expected in the division of the feast. That night the god visited the priest, and foretold defeat, and, as a consequence, the king decided to abandon the expedition. In another case, however, matters took a different turn. 'Who are you?' asked the chief angrily; 'Who is your god? if you make a stir, I will eat you.'

The priesthood itself was hereditary, though any clever rogue who could simulate inspiration and make a lucky forecast of events might obtain recognition. He had, however, to brave the opposition of the hereditary priests, who looked very coldly upon the amateur. The priests were not always the chief's tools; sometimes they gave expression to popular discontent at some act of tyranny: 'The famine is devouring you, because you gave the great canoe to Tonga instead of to Mbau'; 'This hurricane was sent to punish you because you refused the princess to the king of Rewa.'

The priests ranked according to the importance of the god to whom they ministered; they were generally of humble birth, though in Rewa, a few years before the arrival of the missionaries, the chiefs had found it necessary to disestablish the whole of the priestly caste on account of their arrogance, and to pretend that members of the ruling family had themselves received inspiration. The disestablished priests immediately fell into their proper place, a very humble one.¹

4. Gods of the after-world.—Besides the *Kalou-Vu* and the *Kalou-Yalo*, there was a class of gods who had neither temples nor priests. They haunted well-known spots on the road by which the shades passed to their last resting-place; but, as they left the living unmolested, there was no need for propitiatory offerings (see *ERE* i. 444^a). The following is a translation of a fragment of the poem in which these beliefs are preserved. It is put into the mouth of the shades newly arrived in the presence of the gods at Nakauvandra:

'My Lords, in ill fashion are we buried,
Buried staring up into heaven,
We see the scud flying over the sky,
We are worn out with the feet stamping in the earth,
The rafters of our house [the ribs] are torn asunder,
The eyes with which we gazed on one another are destroyed;
The nose with which we kissed has fallen in;
The breast to which we embraced is ruined;
The thighs with which we clasped have fallen away;
The lips with which we smiled are decayed;
The teeth with which we bit have showered down;
Gone is the hand which threw the *tinka* stick,
Rolled away are the hawks' stones [*testiculi*],
Rolled away are the blunters of razors [the pubes were shaved].

Hark to the lament of the mosquito:

"Well it is that they should die and pass onward,
But alas for my conch-shell [the ear] that they have taken away!"

Hark to the lament of the fly:

"Well it is that they should die and pass onward,
But alas for the eye from which I drank!"

Hark to the lament of the black ant:

"Well it is that they should die and pass onward,
But alas for my whale's tooth [the male organ, the most vulnerable point of attack for that insect when a native sits down] that they have taken away!"

The Fijian's dislike of their own burial custom of stamping the earth into the grave was shown in the case of the chief of Lakemba, who begged the missionaries to give him a wooden coffin to be buried in, that his body might not be trampled on.

With all its crudeness and simplicity, the story of the *Salaniyalo* (the Path of the Shades) is not without beauty and pathos. There is, it may be remarked, a suggestion of Greek myth in the ghostly ferryman and in the Water of Solace, by which the Fijians, whose emotions are transient, excuse the shortness of their mourning for the dead.

¹ For the manner of approaching the gods, see COMMUNION WITH DEITY (Fijian).

When the shade drinks from this spring, he forgets all the sorrows of his life, and ceases to weep; 'all his friends also ceased their weeping, for they forgot their sorrow and were consoled.' There is pathos also in the episode of the shades of little children, hanging like bats from the branches of a tree, waiting for their fathers or their mothers to come along the road, and rejoicing when the shade tells them that the hair of their mother has turned grey, and the smoke of her cooking-fire hangs along the ground, for they know that she will soon be with them.

The poem throws light upon the moral ethics of the Fijians. The most heinous crimes are cowardice and idleness, and their passport to Bulotu is a life of rapine and a violent death. So contemptible was a natural death that the shade was commanded to re-enter the body, and die respectably. Seeing the misfortunes that overtook the spirit in its last journey, it is surprising that the shades do not all obey Taleya when he offers to let them return to life.

Light is also thrown upon the fact, which filled the early missionaries with surprise, that the widows of a dead chief insisted upon being strangled at his funeral, although it was notorious that they did not love him. It was their good name that was at stake; for we read that, when a shade threw his whale's tooth at the pandanus tree and missed his aim, and knew thereby that his wives would not be strangled, he went on his way weeping, for he had now a proof that they had been unfaithful to him in life.¹

5. Witchcraft (*ndraunnikau*, lit. 'leaves').—The practice of witchcraft, which controlled the sanitation and medical treatment of the Fijians, had its root in their religious beliefs. Their reasoning on the subject of disease is common to all primitive races. Health being the normal condition of all except the very aged, they argued that sickness and death must be the work of some malevolent agency, Divine or human. Instead of 'Whom the gods love die young,' primitive man reads: 'An enemy hath done this.' It did not need any special skill to practise as a wizard, although certain persons of both sexes acquired a sinister reputation, and took fees for this kind of murder. All that a professional wizard required was something intimately connected with the person of the victim—a lock of his hair, a scrap of his food, or a garment that he had worn. These things, together with certain herbs, would be stuffed into a hollow bamboo, with or without the uttering of a spell, and hidden in the thatch of the victim's house, or in the grass of his bed-place; in a little while he would begin to refuse his food and to pine and sicken, and, unless something were then done in the shape of counter-spells to reassure him, he would die from sheer fright.

The terror of witchcraft was never absent from the mind of the Fijian. The sceptic who laughed at the pretensions of the priests trembled at the power of the wizard, who was not necessarily a priest. It was a lucrative but a dangerous profession, for the transaction could never be kept quite secret, and the wizard had to brave the resentment of the victim's family. The fear of witchcraft led men to bury or burn offal and refuse, which might give the wizard his opportunity, and consequently it ensured a rough system of sanitation. When it was believed that a sick man had been bewitched, every effort was made to find the magical bamboo; for, if it could be discovered and destroyed, he would recover. Failing this, another wizard was hired to make a counter-spell, which was often effective through the fresh hope which it infused into the sufferer. If the victim died, the wizard would

¹ For *kalou-rere* and *mbaki*, see COMMUNION WITH DEITY (Fijian).

claim his reward by attending the funeral with a blackened face; and bold indeed would be the employer who dared to withhold the promised payment. In some places, any sudden death being ascribed to witchcraft, a professional wizard, though entirely innocent of the black art on this occasion, would appear at the funeral with a sooty face, in the hope that some one who had an interest in the death would pay him the fee he had never earned. In some cases, where the bewitched person obstinately refused to fall ill, secret murder might be done. Many of the European residents believe that poison is used in such cases, but in one notable instance—the murder of the chief of Mbureta in 1884—the wizard had earned his fee by cleaving the chief's skull with an axe from behind.

The Fijians seem to have a definite belief that the bewitched person is possessed by an evil spirit, and some of the old practitioners use the operation of massage to drive this nimble spirit into one of the extremities, from which it can be drawn out by the fingers and flung away.

Besides the wizards who practised the deadly art of witchcraft, there were others who specialized in the detection of crime. When property was stolen, the owner took a present to the seer, and told him of his loss. Bidding the man pronounce the names of all those whom he suspected, the seer fell into deep abstraction, and presently stopped the man at a certain name, announcing that an itching in his side or in one of his fingers or toes proved that the name just uttered was that of the thief. If the seer belonged to the same village, and knew all the people, he would dispense with the names; his body began to twitch convulsively, and he himself would call out the name of the thief. If he was lucky enough to hit upon the right man—and an intimate knowledge of his fellow-tribesmen often set him upon the right track—the offender would confess, for to brazen out a theft against the evidence of a wizard's little finger demanded an impudence which no Fijian could aspire to. The proper course for a person wrongfully accused by a wizard was to pay a fee to a rival seer to 'press down' the fee paid to the other; his great toe would then begin to tingle in his client's favour.

A case of this kind occurred in 1885, when the chief of Yasawa was wrongfully accused of embezzling the district funds, and, upon the evidence of a seer, he prosecuted his slanderers in the provincial court.

An even surer method of detecting crime was by *yalovaki* (soul-stealing). It was the mildest form of trial by ordeal ever devised, but no boiling water or hot ploughshare could have been as effective. The suspected person was summoned to the presence of the chief, who called for a scarf; usually the man confessed at the bare mention of the instrument; but if he did not, the cloth was waved over his head until his *yalo* (spirit) was entangled in it, and the cloth was then folded together and nailed to the prow of the chief's canoe. The man then went mad, for the insane are understood to be those whose souls have been stolen away.

LITERATURE.—P. Dillon, *Voyage in the South Seas*, London, 1829; C. Wilkes, *Narrative of United States Exploring Expedition*, do. 1852; J. E. Erskine, *Journal of a Cruise among the Islands of the Western Pacific*, do. 1853; D. Cargill, *Memoirs of Mrs. Cargill*, do. 1855; B. Seemann, *Viti, An Account of a Government Mission in the Vitian or Fijian Group of Islands*, do. 1861; J. Waterhouse, *The King and People of Fiji*, do. 1866; J. Calvert, *Missionary Labours among the Cannibals*, do. 1858; W. T. Pritchard, *Polynesian Reminiscences*, do. 1866; T. Williams, *Fiji and the Fijians*, do. 1870; B. Thomson, *The Fijians, A Study of the Decay of Custom*, do. 1908; E. Rougier, in *Anthropos*, II. (1907) 68-79, 994-1008; J. de Marzan, *ib.* 400-405, III. (1908) 718-728, and IV. (1909) 87-98.

BASIL H. THOMSON.

FILIAL PIETY.—I. Definition and scope.—Filial piety is distinguished from filial obedience by the fact that it is incumbent even upon those

VOL. VI.—2

who have, according to our ideas, passed beyond the duties of childhood; it differs from family piety, which attaches to all the members of the family; and, again, it differs from piety in its older and more general sense, which may exist in every possible relationship involving authority or dependence. Filial piety is accorded to parents, or to those who take their place, and in a metaphorical sense it may be extended to the Deity, should the latter be thought of as father or mother; here, however, filial piety becomes reverence (*q.v.*). An evidence for this double sense of the term lies in the fact that the family relationship and the religious relationship are found combined in various ways.

2. Among non-Christian peoples.—(1) Amongst many *savage peoples*, filial piety can hardly be said to exist, the aged being simply put to death, or forced to commit suicide, as having survived their usefulness (see artt. ABANDONMENT AND EXPOSURE, OLD AGE). Leaving such barbarity out of account, however, we generally find filial piety allied with ancestor-worship. The dead ancestor is revered as a spirit; and, while the worship of the dead not seldom originates in the fear that the spirit may work harm to the survivors, or in the wish to keep it at a distance, we must, nevertheless, not ignore the other side, viz. belief in the interest and sympathy of the departed, the desire of winning their favour, and the hope of securing their aid. That the ancestral spirit frequently coalesces with the death-god needs no explanation, nor is any needed for the fact that he sometimes becomes the hero who instructed his people in the various useful crafts, such as boat-building, etc., or, again, that he is merged in the Creator, the 'Great Spirit' who takes a fatherly interest in the welfare of the tribe. From this we may infer that filial piety was originally a blending of the religious and moral affections that cluster round the natural fact of a common descent, the descendants not only finding in their reverence for their ancestor a bond of union, but also feeling a certain common dependence, not unmingled with awe, and suffused with a moral element, though, of course, selfish motives might also be present. The object of such piety is the ancestor, who is at once the hero, the death-god, and the Creator-god, but who at the same time is the head of the tribe or family, and is regarded as a higher being, to be treated with all reverence. Here we see a synthesis of religion and piety; and similar conceptions will be found everywhere, even in the highest forms of religious life. The manner in which piety towards ancestors or parents is figured amongst the various peoples is as varied as the character of the peoples themselves. On the lower planes of thought, religious reverence and reverence for the head of the family are not as yet disengaged from each other, and piety at this stage rests upon natural feeling rather than upon distinct conceptions. But, as soon as the idea of a comprehensive order makes itself felt in the religious consciousness, ancestor-worship and family piety are each assigned a place in this order, and are clearly discriminated.

(2) In *Egypt* there existed a widely diffused worship of the dead, which, however, was distinguished from piety towards parents, the latter being strongly emphasized as a duty, both falling under the law promulgated by the priests.

(3) In *China* the law of superordination and subordination is deemed to be the supreme law of heaven, and finds its specific expression in piety. Confucius (*q.v.*), indeed, insists so strongly upon the cardinal importance of piety, more particularly as shown towards parents, that he values ancestor-worship simply as a means of fostering it. This

and may be compelled to recognize their liberty. This view has been extensively adopted throughout the civilized world.

These conclusions become clearer still when we consider the case where piety is based upon the authority of the parents. That there is a legitimate side to this is self-evident. In relation to this view, nevertheless, a peculiar attitude was taken by primitive Christianity, as, on the one hand, it enjoined the obedience of children, even as Jesus was subject to His parents (Lk 2⁵¹); while, on the other, it conferred upon the adult the full liberty of responsible manhood, which Jesus laid claim to in plenary measure, and which Paul concedes to the Christian (1 Co 2¹⁵). When Christianity, however, at length took the form of a religion of authority, freedom disappeared, and the parents' will frequently set itself in opposition to the free development of the child, or was sometimes superseded by the power of the confessional, as specially developed among the Jesuits, who discussed casuistically even the case of the parricide. The fact that the Reformers were well-disposed towards the natural relationships had at first merely the result that parental authority was once more drastically insisted upon, the parents being regarded as representing God. But the liberation of the individual in the interests of his salvation was certain in the end to bring about the recognition of his independence on reaching the stage of maturity. His right to form his own religious belief, to select his profession, to please himself in the choice of a wife, and, in general, to decide for himself in all questions of public or private life—these rights, based upon the implications of personal responsibility, came at length into collision with the older theory which made parental authority supreme, and obedience the child's paramount duty. But the resolution of this antagonism did not bring about the dissolution of piety. For, while every person as such must eventually become fully accountable, and while youth, holding a brief for the future, stands for other views than age, yet, precisely on the ground of a mutual recognition of ethical freedom, a certain mutual toleration is also possible. We must also bear in mind the riper experience of the parents, and all else that gives them a claim to the gratitude of their children. The relation of subjection which belongs to immaturity may thus pass into one of friendship, qualified on the children's part by feelings of gratitude and reverence, and, on the parents', by considerate kindness and loving sympathy with the children's welfare and interests. Should the children feel themselves hampered by their parents, it indicates on their own part some misuse of that perfect freedom which is so sure of itself that it can respect views that would obstruct it, or some deficiency in that necessary breadth of view which can put itself in another's place, or in the will to follow the well-weighed counsel of those whose right and duty it is to give counsel; or else, on the other hand, there is in the parents a lack of that tolerant wisdom which is often infringed by a solicitude, well-meaning and kindly indeed, but defective in its regard for independence. Confidence on either side, and especially on the side of the parents, is the foundation of true piety. Such is the modern view, which welds piety and freedom into unity.

It would appear, accordingly, that from an instinctive attachment and dependence, an inchoate feeling of regard for parents which is still vaguely blended with the religious emotion, there is evolved a filial piety, which, as an unconstrained virtue, transfigures its natural foundation; a virtue which definitely disengages itself from reverence to the

Deity, and yet goes hand in hand with religion; which, precisely because of the substratum of legality which is the bulwark of personal freedom, may itself become all the more noble and free; which maintains personal responsibility in the face of mere authority, yet without violating respect, gratitude, or reverence; and which, the more that is conceded to it, grows ever the more expansive and ever the more intense.

A survey of the historical development of the quality shows us that piety, in the form of obedience, has been regarded as much more incumbent upon women than upon men. This seems to be so far justifiable, as the home is much more the focus of female than of male activities. Goethe has said:

'Nach Freiheit strebt der Mann, das Weib nach Sitte,'

and again:

'Dienen lerne das Weib, durch Dienen kommt sie zum Herrschen.'

Nevertheless, fairly considered, it is impossible to see why women should be deemed less responsible for their conduct than men. The tyranny still inflicted in many homes upon the daughters, who, perhaps from the excellent motive of safeguarding them against evil, are watched over like children, even when they have reached maturity, is a violation of personal responsibility; and, if such a surveillance, which as a rule does more harm than good, should appear necessary, it is a sign that our education of girls is at fault, and that it fails in due and timely consideration of the end involved in womanhood. More and more does the conviction gain ground that with daughters as well as with sons, piety must be harmonized with the status of an independent moral personality.

4. Modern aspects.—Filial piety is a virtue which becomes fully intelligible only when it is placed in the larger economy of moral life as a whole. In more recent times it is being brought under the theory of development. On the one side stands tradition, transmitted custom and transmitted creed, as represented, in the main, by the older generation; and on the other the innovations which are advocated by the ardent spirit of the young. Such antagonism is necessary if mankind is to make progress. There is, on the one hand, the tendency to hold fast what has been won; on the other, the desire to transcend it. A progress which does not build upon what is already attained, but is always breaking fresh ground, is no progress at all, but simply change, while mere constancy to custom issues in torpor. Now, as we cannot dispense with either aspect, the problem can be set in its true light only by reference to the experience of generations. In this way the injunction that demands piety towards parents takes a much wider range: it is now made to cover respect even for the particular views of the parents, or of the older generation, in the most various departments of life, and may thus become a mere encumbrance—the ally of prejudice, preconceived opinion, and rooted tradition, however preposterous. This conservative tendency, in fact, demands adherence not only to family tradition, family property, and custom, but also to the time-honoured laws of State and Church. At this stage the innovator is always regarded as lacking in piety towards the preceding generation. Naturally such a one-sided point of view evokes and intensifies the opposite tendency—that, namely, which urges the necessity of reform, and refuses to be content with the simple development of traditional institutions. The reforming spirit, in fact, insists upon the right to submit all things to a thoroughgoing test as the necessary condition of all real improvement, and the younger generation is often harshly denounced for advocating that right. Quite unjustly, however; for piety does not consist in clinging to

the old, or in reluctance to put existent conditions to the test, but rather in the respect which we accord to the labours of our forefathers, and which really involves criticism thereof. Nothing of a spiritual character can be mechanically appropriated; spiritual things can be assimilated only after they have been personally analyzed and sifted to the bottom, and it is precisely in this conscientious scrutiny that true piety stands revealed, just as parental advice is really respected when it is conscientiously weighed.

Moreover, though every generation has its own task, yet fundamentally one and the same process is common to all. Each generation confronts an older, to which it owes a dutiful regard, and which it must in all reverence criticize; but it likewise begets a younger, from which it *claims* a dutiful regard, and must expect a reverent criticism. That this circumstance is the source of many misunderstandings between old and young may be gathered from the life-stories of nearly all great men. In the dissensions which thus arise, the young sometimes let their piety take the sinister form of humouring the old, of dissembling a little with them, and pensioning them off, so to speak, with a genial show of respect. But a policy of this kind manifestly fails to do justice either to the dignity of age or to the obligation of veracity, and is justifiable only when the old have fallen into the state of incipient torpor, and set themselves, without sympathy or intelligence, against every new movement. It must, nevertheless, always remain the more excellent way to seek, wherever practicable, for a mutual understanding, as there is a much higher degree of genuine piety in a modestly expressed opposition to the opinions of the aged than in ignoring them altogether; while, again, the very endeavour to reach an understanding implies a partial recognition of the older point of view. Every single generation of men is an end in itself, something far more than a stage of transition to its successor. Just as children must not be treated as purely dependent beings, but as responsible personalities, who, as ends in themselves, have a specific right to free self-expression; so too are parents ends in themselves, and fail in their duty when they omit to bring—along with and in their parental love—their own standing as ends in themselves to the notice of their offspring. This prerogative, indeed, must be fully recognized by the younger generation, just in order to conserve their filial piety, even amid diversity of opinion and tendency. To parents is due, not only gratitude for all that they have been and done on the children's behalf, but also respect, as ends in themselves, and as having the same claim to deferential recognition of their standpoint as the children have in regard to theirs. It is precisely the profound sense of the worth of personality that begets the mutual recognition of the right of unfettered judgment, while this again carries with it the true piety; so that the young who possess this quality still recognize, amid all zeal for their own convictions, the equal right of parents to theirs, since, as a matter of fact, had the parents not possessed such convictions, the children could never have won their own, and this recognition, moreover, they naturally combine with sentiments of gratitude and reverence.

In this discussion the individual factor must certainly not be ignored. In the first place, human beings do not all develop at the same rate, and the transition from simple obedience to spontaneous piety does not occur at the same age in all; while, again, men are variously constituted by nature, some having a predilection merely to carry on what has been begun, a congenital bias towards the ancient and the traditional, others being naturally

inclined to criticism, or gifted with creative power. Now, the former class, as compared with the latter, will discharge the duties of piety all but instinctively, simply because they more easily avoid collision with parental authority. Yet it would be radically wrong to regard them as of superior worth. Some natures develop most fully when stimulated by harsh opposition; others reach maturity by a gentle process and without special incitation. All will agree that a judicious training must allow for such inherent differences of temperament. The genuine piety will be the fruit of a right education. Nor must we demand the same outward manifestation of piety from both types of character. The withholding of the requisite liberty or of a large-hearted confidence will be much more keenly felt by some than by others. The more diffident spirit will sink to a state of mere servile submission, while another will avoid a too harsh infringement of piety by resorting to insincerity, or will ruthlessly assert his liberty and become totally estranged. From the moral point of view the right policy in the former case is to intensify the desire for freedom without diminishing his piety, and in the second virtually to emancipate him, so that his candour may be preserved, and that he may see in his parents a corrective influence, disposing him to discretion. The piety of the one will show a proclivity to subordination, that of the other will tend more towards a free recognition of the parents' personal worth. The former must temper his bias towards dependence by his sense of what personal responsibility involves; the latter must qualify his bent towards liberty by keeping his dissentient views apart from his personal relationships, and by habituating himself to yield the same respect for others' opinions as he claims for his own.

A specially trying situation is brought about when the children, with a wider experience of life, grow out of their parents' circle of thought and pass beyond their spiritual horizon. In such a case piety may manifest itself more in the form of gratitude, adjusting itself in word and act to the mental perspective of the parents, so as to yield them all affection, yet without insincerity. Here, if anywhere, a certain indulgent treatment of the old is necessary, such as could not be vindicated were parent and child at the same stage of culture and intelligence.

Again, piety is variously estimated according as the particular family in which it is manifested inclines towards the aristocratic or towards the democratic point of view. In the one case, piety preferably expresses itself as a recognition of family traditions; in the other, it can have no support but freedom, the unforced honouring of one's parents. The aristocratic type of piety tends to find its object in the family and the family bond, while the democratic centres rather in the individual. The former tends towards an exclusive family pride more readily than the latter; it is prone to become egoistic and illiberal, as it ignores the due limit of family interests. For family piety in no sense implies that we shall think less of those who are not our own kith and kin. Such a spurious family pride sometimes asserts itself very unpleasantly in marriage, as, *e.g.*, when one of the parties belongs to a family whose piety has degenerated into mere arrogance. A high appreciation of one's own lineage has an adequate warrant in the ethical obligation under which a man stands to his family, and to his parents in particular, as also in the natural relationship which manifests itself specially in personal attachment; but neither of these provides any justification for the disparagement of other families.

These considerations go to show not only that piety may be modified in various ways in virtue of individual conditions, but also that it has its limits.

4527

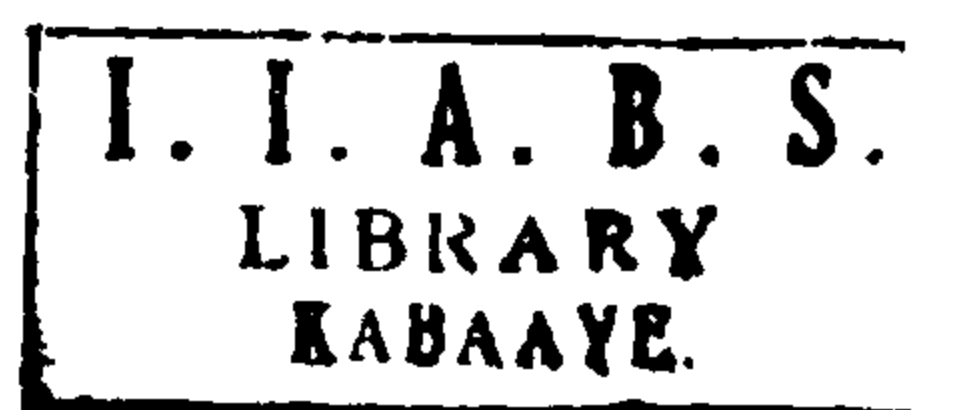

since it must neither violate the freedom of fully responsible individuals, nor detract, through exclusiveness, from the respect due to persons or families not of one's own kindred.

The contrast between the older and the more recent conception of piety may be gauged from the circumstance that, whereas formerly the faith and customs of the fathers formed a kind of rallying-cry, it is now a common practice to describe an objectionable view as 'behind the age.' This changed attitude is largely due to the spread of the evolutionary idea. Nowadays men often lament that piety is on the wane. Such a complaint, however, would be justified only if the personal relation towards parents, or towards superiors generally, were wanting in dutiful regard, or if respect for what has been bequeathed to us by the older generation were becoming extinct; but it is not justified by the mere fact that the younger generation strives to assert its independence, even in a critical spirit. On the contrary, a radical criticism is the condition of all progress. If, nevertheless, owing to the inability of the older generation to sympathize with the innovating tendencies of the day, conflicts cannot always be avoided, piety still demands that the young should temper their behaviour towards their parents with all due reverence and gratitude, and strive so to mitigate the inevitable differences by kindness that a rupture may be avoided, wherever possible, without any sacrifice of conviction.

Lastly, as regards the filial relation to God. Like all metaphors relative to Deity, that of sonship is susceptible of various interpretations. We may conceive of it as implying the dependence of a child who yields a trustful obedience. Divine sonship in this sense will consist in a man's renunciation of his own will, so that in perfect trust he may obey the Divine commandments alone. But the question then arises, Whence do we derive our knowledge of these commandments? If we depend in the last resort upon an infallible revelation, with either the Scriptures or the religious community as the channel thereof, it is obvious that we are not yet of age in spiritual things. It is a commonplace of history that the theory of authority has found acceptance even in Christendom. But, if no such blind acceptance be required, then the sacred book or the community does no more than provide the stimulus towards personal experience and personal thought, and, accordingly, we dare not evade the duty of examining the commandments we are required to obey. In this way the Divine sonship passes into its voluntary form: the man to whom it is vouchsafed is exalted by his knowledge thereof to a position of freedom, nor does the reverence before God which is conjoined with this knowledge collide with his sense of moral freedom, just because the Divine sonship harmonizes with his inmost nature, and because the Spirit of God, far from destroying his personal activity, rather anneals it to the highest issues. Thus is brought about a coalescence of theonomy and autonomy, of the desire to do God's will and the desire to know how we must act, of the knowledge of Divine law and the knowledge of moral obligation. Our freedom reaches its perfection in our sonship; our spirit, apprehended by the Divine Spirit, and in no other way, is raised to a state of complete independence of the world and full self-activity, and in its own worth and responsibility feels itself enlarged to the utmost. One who is animated by this spirit of Divine sonship will also maintain his filial piety towards his parents unimpaired, and without surrender of his independence.

See, further, the artt. on ETHICS AND MORALITY, esp. 'Chinese' and 'Japanese.'

LITERATURE.—H. Höfding, *Ethik*², Leipzig, 1901, pp. 252, 325 f.; Fichte, *System der Sittenlehre (Werke)*, Berlin, 1845-46, iv. 336 f.; Kant, *Pädagogik (Werke)*, ed. Rosenkranz, Leipzig, 1838-40, ix.; J. Köstlin, *Christliche Ethik*, Berlin, 1899, p. 598 f.; J. C. K. von Hofmann, *Theol. Ethik*, Nördlingen, 1878, p. 227 f.; J. Stuart Mill, *Autobiography*, London, 1873.

A. DORNER.

FINNO-UGRIANS.¹—The Finno-Ugrian family of languages is probably of cognate origin with Samoyed, and possibly with Turkish as well, although the linguistic affinities of the so-called Ural-Altaic group cannot yet be regarded as established. The original seat of the Finno-Ugrians seems to have been in the eastern part of Central Russia, between the Volga and the Southern half of the Ural range; and here, if we may judge from a number of loan-words in their languages, they must have lived in proximity to a people of the Indo-European stock. The Finno-Ugrian family of languages has branched out towards east and west, forming the following divisions: (1) the Ugrian group; (2) the Permian group; (3) the Volga group; (4) Lappish, and (5) the language of the Baltic Finns.

1. Of the Ugrians the most southerly ramification, the Magyars, migrated to the lands lying upon the Danube. The Ostiaks and Voguls, on the other hand, were driven towards the north and east, the former crossing the Ural Mountains into Siberia.

2. The Permian group is composed of the Votians in the district adjacent to the upper Kama and the Vyatka, and the Siryans who settled to the north of that region.

3. The Volga group comprises the Cheremisses and the Mordvins.

4. The Lapps are believed to be an Arctic people of unknown origin who adopted a Finno-Ugrian tongue.

5. The Baltic Finns migrated westwards to the vicinity of the Valdai Hills, and thence moved gradually towards the Baltic, which they appear to have reached in the first half of the 1st cent. A.D. In the course of their migration they came into contact with Lithuanian, Teutonic, and Slavic tribes. Of the Baltic-Finnish tribes the Vepses in the southern part of the Government of Olonetz and the northern part of that of Novgorod, the Votes living to the east of the town of Narva, and the Livonians in the northern extremity of Courland now survive in inconsiderable numbers only. The Esthonians inhabit Esthonia and the northern part of Livland. The Finnish population of Finland is descended from two groups of immigrants from different points—one from Esthonia, which crossed the sea into south-western and western Finland, and the other from Ingria, now the Government of St. Petersburg, to Karelia. The great mass of the Karelians migrated in a north-easterly direction into the Governments of Olonetz and Archangel, while a considerable proportion of the Finnish Karelians subsequently found their way to the same districts in the 17th century. The Karelians in the Valdai region and the Government of Tver had their origin in immigrations from Ingria, Finland, and Olonetz, which took place c. 1650.

LITERATURE.—The first sketch of a Finno-Ugrian mythology was given in the masterly lectures on Finnish mythology delivered by M. A. Castrén in 1853, and published in Swedish and German in his *Nordische Reisen und Forschungen*. A work dealing with the heathen worship of the Finno-Ugrian peoples, edited from the posthumous papers of Julius Krohn, and containing supplementary matter by Kaarle Krohn, was published in the Finnish language in 1894; a Hungarian translation, with further additions by A. Bán, appeared in 1908. This work contains a survey of the sources, and four chapters dealing respectively with (1) sacred places, (2) idols, (3) magicians

¹ This article is mainly intended to supply the ethnographic details necessary for the art. following, which will deal with the religion, etc.

and sacrificing priests, and (4) sacrificial rites. In 1895, Matti Waronen published a dissertation in Finnish dealing with the worship of the dead among the ancient Finns and taking cognizance of all the Finno-Ugrian peoples, and three years later this work was augmented by a thorough investigation of the various feast-days observed by the Finns in honour of the dead. In 1913 the firm of Werner Söderström began the publication of a great series (in Finnish) which will deal exhaustively with the mythology of the Finno-Ugrian peoples.

KAARLE KROHN.

FINNS (Ancient). — I. Sources. — Bishop Michael Agricola, the reformer of Finland, in the preface to his Finnish translation of the Psalter (1551), composed in verse a list of the deities worshipped by the Finns in heathen times. This list was modelled upon the catalogues of classical muses and other deities given in the versified grammars of the Middle Ages. The idea of giving an account of the ancient Finnish deities, however, arose independently in Agricola's mind, and had no connexion with the attempt of Johannes Magnus to construct a Scandinavian mythology, as found in his *Historia*, published three years after Agricola's book. In the 17th cent., Agricola's list was translated into Latin, Swedish, and German, and until the middle of the 18th cent. was appealed to—apart from a few meagre notices from mediæval times—as the only source for Finnish mythology.

But a new and singularly copious source was disclosed in H. G. Porthan's *de Poesi Fennica*. On the basis of the epic and, above all, the magic songs of the Finns, Porthan's pupil, Christian Lencqvist, published in 1782, under his master's guidance, a dissertation entitled *de Superstitione veterum Fennorum theoretica et practica*; while in 1789, Christfrid Ganander, Porthan's friend and fellow-worker in this field, issued a *Mythologia Fennica*, dealing with the mythological names in alphabetical order, and this was reprinted and issued in a German edition in 1822 (J. H. Rosenplänter, *Beiträge zur genaueren Kenntniss der estnischen Sprache*, xiv.).

After the publication of the *Kalevala*, compiled by Elias Lönnrot from Finnish folk-songs, in 1835, and of the fuller recension in 1849, this great epic was used as the principal source for Finnish mythology. The names of the gods and other data furnished by Agricola were now set aside as less reliable and to a considerable extent unintelligible. But the recent study of the *Kalevala*, inaugurated by Julius Krohn, has created a revolution in Finnish mythology. From the printed editions of the epic, scholarship has turned to the manuscript drafts of the songs in their manifold variants, and the folk-songs have been critically studied with reference to their geographical distribution. These investigations have made it clear that the epic and magic songs of the Finns are largely of mediæval origin, and that their mythological elements, as in the case of the Edda, are permeated by Christian ideas. A further result is that nearly all the names given by Agricola have received a satisfactory philological explanation, and that the value and trustworthiness of his evidence regarding the actual paganism of Finland—which forms the subject of the present article—have been recognized and appreciated. The poetic mythology of the Finnish songs will be dealt with in the art. KALEVALA.

2. The objects of worship.—(a) *The dead.*—The cult of the dead, which is found among all the Finno-Ugrian peoples, is, as elsewhere in this race, the earliest traceable form of religion also among the Baltic Finns.

The Finnish language has retained words which, according to E. N. Setälä (*Finn.-ugr. Forsch.* xii. 170), go back to Finno-Ugrian terms for the spirits of the dead, as, e.g., Finn. *koljo*, 'evil spirit'; and even to roots common to Finno-Ugrian and Samoyed, such as *kaima*, 'corpse,' 'grave,' 'spirit of the dead,' 'death.' The Finn. *marras* or *marta*, 'a dead person,' was bor-

rowed from some Indo-Iranian language in the Finno-Permian period (Skr. *mṛtas*). In the specifically Finnish epoch the term *kouko*, 'ghost,' was taken over from the Lithuanian (Lith. *kaũkas*, 'one under the earth'). Most of the Finnish names for the dead have been borrowed from Teutonic dialects, as, e.g., *vainaja*, 'one dead' (Goth. *vainaha*, 'wretched'); *peikko*, *peijakas*, or *peijanen*, 'ghost,' 'evil spirit,' and *peijaiset*, 'funeral feast' (O. N. *feigr*, 'fated to die,' Scots 'fey'); *tuoni*, 'a dead person,' and 'death' (cf. Swed. *dana-arf*, 'an inheritance falling to the State'); *kyöpeli* or *kopeeli*, 'ghost' (cf. Germ. *Kobold*), etc.

Agricola refers to the Finnish worship of the dead as follows: 'Food was taken to the tombs of the departed, and there the people mourned, wailed, and cried. Likewise the *Menningäinen* [cf. Germ. *Erdmännchen*] received their oblations when the widows married again.' Until quite recently the Finns in Ingria observed the practice of placing in the tomb a vessel filled with pease, flesh, bread, butter, and the like. Among the Karelians of the Greek Church it is still the custom to take food to the grave on certain anniversaries, and to entreat the dead in mournful songs to partake thereof. After a while the food is distributed among the beggars who happen to be present. In Lutheran—formerly Roman Catholic—Finland, the so-called feast of *Kekri* was held annually on the 1st of November. In the dwelling-house, on the eve of the celebration, a table was spread, as at a funeral feast, in honour of the former master and mistress; the bathing-house was heated and supplied with all requisites for washing. Sometimes a dressed straw doll with a painted mask was set up in the corner where the stove stood. According to Agricola, *Kekri* 'promoted the growth of cattle.' The word *kekri* is also used in the sense of 'ghost,' but it has not yet been explained etymologically. Long before the festival of *Kekri* came to be formally conjoined with All Saints' Day, it was associated with an indefinite period in autumn, as appears from the Finn. name *Marraskuu*, 'month of the dead,' for November, and the Esth. *Hingekuu*, 'month of souls,' for October. Moreover, in keeping with Scandinavian ideas, but more especially in West Finland, visits from the dead were expected also during the Christmas season.

(b) *Household spirits.*—As a further result of Scandinavian influences, the worship of local guardian spirits, which sprang from the cult of the dead, became diffused also among the Finns. The Finn. word *haltija* (from *hallita* [a Teut. loan-word], 'to rule over'), corresponds to the Swed. *rå*, *rådande*, 'to be able.'

The *talonhaltija*, or guardian spirit of the home, usually represents the person who had been the first to kindle a fire, or, by other accounts, the first to die, in the house. The two views are combined in the statement that the first fire was made by the earliest representative of the family; it is often said, indeed, that the *talonhaltija* is the spirit of the first master or mistress of the house. The appearances of this domestic spirit usually precede a death or other misfortune; it is kindly disposed, interested in the welfare of the house, and does not like to be startled.

From the domestic spirit is to be distinguished the capricious *tonttu* (Swed. *tomte*)—who, according to Agricola, controlled the household—although the two are often confused. The *tonttu* must be brought from the churchyard, and a special apartment with a well-provided dining-table must be prepared for him. In the matter of offerings he is very exacting, but he enriches the giver with corn and money. Besides the *tonttu*, Agricola mentions the *kratti* (O. N. *skratti*), who 'took care of property,' and who is recognized more particularly in Esthonia, where he is also called *puuk* (O. N. *puki*), *tulihänd*, 'fiery tail,' 'shooting star,' and *pisuhänd* (cf. Swed. *tomte-bise*). A special type of the domestic spirit among the Finns, and likewise of Scandinavian origin, is the butter-bringing *para* (Swed. *bjära*).

From the household spirit must also be distinguished the earth-spirit, *maanhaltija*. When a house is to be built, the consent of the latter must first of all be obtained by dreams or divination. The people then make an offering to him by planting a tree, with which he thereafter maintains a special connexion.

When the custom of burying the dead in the vicinity of the dwelling-house gave place to interment within and around the church, a tutelary spirit of the church or churchyard was found in the *kirkonhaltija*, or the *kirkkomaanhaltija*, the first person buried there, with his subject spirits, the *kirkonväki*, or 'church-folk.'

Besides the spirits of the dwelling-house there are also guardian spirits of the bathing-house, the granary, the threshing-barn, the stable, and the cattle-shed, some being called *haltija*, and some *tonttu*. The smithy likewise may be provided with protective spirits, the *pajanväki*, 'smithy-folk,' especially by bringing thither a little earth from the churchyard.

(c) *Forest-spirits and water-spirits.*—The guardian spirits and the 'people' of the forest (*metsänhaltija*, *metsänväki*) and of the water (*vedenhaltija*, *vedenväki*) are unmistakably localized spirits of the dead. They have the same form, the same character, attributes, and functions as the latter, and are occasionally even called *manalaiset*, 'those under the earth.'

One of the forest-deities specified by Agricola is *Liekkiö*, 'the flaming one,' who 'presided over plants, roots, and trees'; he was the soul of a child who had been buried in the forest, and appeared as the *ignis fatuus*. *Hiisi*, who 'bestowed victory upon those dwelling in the forest,' is mentioned by Agricola also in the sense of a place, viz. a sacred grove, and the word still bears this meaning in Esthonian. As the sacrificial groves occupied the site of ancient places of habitation and burial, *Hiisi*, as the guardian spirit of the sacrificial grove, can be traced to an origin in manistic ideas. In Western Finland the departed are spoken of as 'Hiisi's folk.' But *Hiisi* is more commonly thought of as a giant of ancient times, and a further designation of this giant given by Agricola is 'the son of *Kaleva*.' *Hiisi* is also identified with the *Vuori-peikko*, the mountain-ghost, and, topographically, with the mountain itself. The 'people' of the mountain, the *vuorenväki* or *kallionväki*, are of the same type as the 'people' of the church, the forest, and the water, and belong to the group of localized spirits of the dead; the idea that mountains were the abode of the dead was taken from the Scandinavians. Finally, under the influence of Christianity, *Hiisi* came to bear an evil repute, being personified as the Devil and localized as Hell. From a diminutive form of his name, viz. *hitto*, is probably derived the word *hittavainen*, signifying the spirit that 'brought hares out of the thicket' (Agricola).

The word *Tapio*, denoting the deity who 'provided prey' for the hunter, was, like *Hiisi*, applied originally to a locality, probably to the hunting-ground; as a spirit, it is invoked, together with the *metsä*, 'forest,' in the magic poems. *Viran-kannos*, who 'guarded the oats,' is akin to *Viran-akka*, the Lappish goddess of hunting, and, as regards his name, is merely a tree-stump (*kanto*) combined with a snare (*virka*). *Nyrkes*, again, who 'supplied squirrels from the wood,' is neither more nor less than St. George (*Jyrki*). The *metsän-neito* of Western Finland is represented as a forest nymph, beautiful in front, but hollow behind, and was adopted from the Swedes in modern times. The bear, on the other hand, the worship of which is closely connected with the worship of the dead, is a very ancient divinity of the forest.

As regards water-spirits, Agricola makes mention

of *Veden emo*, 'the mother of the water,' who 'guided fish into the net,' and *Ahti*, who 'brought fish out of the water.' Probably *Ahti* likewise is not a proper name, but a general term for a guardian spirit, since it may be applied also to the spirits of the forest and the earth (*metsänahti*, *maanahiti*). To the class of water-spirits must also be assigned *Väinämöinen*, who 'fashioned songs.' The word *väinä* signifies the still water at the mouth of a river. The gift of music and poetry is generally assigned to the spirits of the dead, and especially to those who inhabit the water (cf. the Swedish *Näck*, which is well known also among the Finns [*näkki*]).

(d) *The thunder-god and other agricultural deities.*—Of the agricultural deities the most important was the god of thunder, whom the Finns found both among the Litu-Slavs (as *Perkunas*, *Perun*) and among the Scandinavians. The Finnish names *Perkele* and *Piru* now denote the Devil, but in an Esthonian dictionary of 1660 the expression *Perkunool* is given as equivalent to 'thunderbolt.' The Esth. *kõuke*, *kõu*, 'thunder,' must be regarded as cognate with the Lith. *kaūk-spennis*, 'thunderbolt,' and O. Pruss. *cawx*, 'devil.'

The battle-cry of the Esthonians c. 1200 was *Tar-abitha*, 'Tar-help!' which points unmistakably to the Norse Thor. According to Agricola, the god *Turisas*, 'father Tur,' conferred victory in war. As a rule, however, the Finns designate the thunder-god by their equivalents of the Swed. terms *Gogubben*, 'good old one,' and *Gofar*, 'little father,' 'gaffer,' viz. West Finn. *Isänen*, 'little father,' East Finn. *Ukko*, *Ukkonen*, 'old man,' 'grandfather.' The Finn *Aijo*, 'the old one,' likewise was formerly used as the name of the thunderer, as appears from the Esth. *äi*, 'thunderer,' 'devil'—the latter sense being retained also in the Finnish songs.

Of the worship of *Ukko* among the Eastern Finns, Agricola writes as follows:

'*Ukko's* goblet was drunk at the sowing of the spring seed; *Ukko's* chest was also brought, and then maid and wife drank to excess, and, moreover, many shameful things were done there, as was both heard and seen. When *Rauni*, *Ukko's* wife, raved, *Ukko* breathed vehemently from the ground (or, from the North?), and this brought thunder-showers and the year's harvest.'

A still extant petition from peasants in E. Finland, written in Swedish and dating from Agricola's time (1545), mentions the fine exacted for drinking *Thordns gildhe*. A reference to *Ukon vakat*, 'the chests of *Ukko*,' occurs also in the report of an ecclesiastical inspection held in 1670. Vestiges of this sacrificial feast have been noted within modern times. According to one account, the best sheep was selected from the flock, and slaughtered on a given day. Its flesh was boiled, and a little of this and of various other kinds of food was put in chests of birch-bark, and carried to the sacred mountain of *Ukko* (*Ukon vuori*). The victuals, together with a large quantity of beer and spirits, remained on the mountain overnight. Such portions of the food as were found there in the morning—*Ukko* being supposed to have taken a share—were eaten by those who took part in the festival, but a little of the various liquors was poured upon the mountain, to the intent that the summer might not be too dry.

According to another account, the people, when they thought that the drought had lasted too long in spring, placed vessels containing rye or barley on the roof of the dwelling-house of a particular homestead selected by lot. The god was supposed to know why this was done, and caused it to rain, so that the grain might be moistened. This was then made into malt, and beer was brewed therefrom. The day of prayer in June—the time of drought—was celebrated out of doors. All the

men and women of the village, and especially the older people, assembled at the homestead. The people partook of the beer, and of various foods, and prayer was made for the kind of weather required. No one who came to the festival of the *Ukon vakat*, 'the chests of Ukko,' brought provisions for himself, as it was considered an honour to the homestead that the celebration should be held there. Lots were cast at the close to decide where the feast was to be celebrated the following year.

The various acts of exposing to the rain the corn from which Ukko's beer was brewed, of making a libation of beer on Ukko's mountain, and, according to an Ingrian account, of washing the beer-barrels, as also, according to Agricola, of drinking beer to the stage of intoxication, were all designed as magical devices for bringing thunder-showers in the time of drought.

To *Rauni*, the consort of Ukko, whose name occurs in the songs as *Röönnikkä*, corresponds the Finno-Lappish *Raudna*, to whom were consecrated the berries of the mountain-ash. In Swedo-Lappish, in fact, *raudna* denotes the mountain-ash, and, as E. N. Setälä has shown, it is a Scandinavian loan-word (Icel. *reynir*, Swed. *rönn*, cf. Scots 'rowan'). The Finns also regarded the mountain-ash in their courtyards, and especially its berries, as sacred. The idea that Ukko and Rauni were husband and wife finds its explanation in the close relations which both Teutons and Litu-Slavs believed to subsist between the god of thunder and the oak. In all likelihood the worship of the oak pertained properly to the acorns, which in remote times had served as human food.

At the Ingrian festival of Ukko, songs are sung about a deity called *Sämpsä* or *Pellervo*, who is first of all raised up—though to no purpose—by the son of Winter, and then at length brought hither by the son of Summer, so that he may speed the growth of the corn. In Finland this god was represented as being conveyed from an island—sleeping upon a corn-ship, or else riding in a coloured sledge, with his mother as his wife. These ideas emanate from the Scandinavian cult of Frey, which found its way also to the Lapps. The term *Sämpsä* (a Teut. loan-word [Germ. *Simse*, *Semse*, 'bulrush']) signifies a species of fodder-grass (*Scirpus sylvaticus*, the wood club-rush), one of the earliest products of spring, which is gathered for the cattle when the snow melts, and the roots of which are readily eaten by children. In Ingrian songs, *Pellervo* is used as equivalent to *pellava*, 'flax,' although it may possibly be derived from *pelto*, 'field.'

Among the gods of the various kinds of grain, as recorded by Agricola, *Rongoteus*, 'who gave rye,' is to be identified with the *Runkateivas* found in the songs as the god of rye; the name occurs also in the abbreviated form *Rukotivo*. It is a Teut. loan-word (cf. Icel. *rúgr*, 'rye,' and *tívar*, 'gods'). *Pellon Pekko*, 'the Pekko of the field,' who 'furthered the growth of barley,' is still recognized among the Esthonians of the Greek Church. A large wax figure, bearing the name *Peko* and belonging to the village as a community, was kept in a corn-chest and entrusted to the care of a peasant chosen every year, and was invoked at seed-time. The name *Pekko* is to be traced to the same Scandinavian word from which *Beyggvir* or *Byggvir*, the name of Frey's servant, and the Swed. *bygg*, 'barley,' are derived. The etymology of the name *Egres*, denoting the deity 'who created peas, beans, and turnips, and brought forth cabbage, flax, and hemp,' has not yet been ascertained. A deity of turnips called *Agräs* has quite recently come to light among the Greek-Orthodox Finns on the Russian frontier. This name is given to a turnip—latterly also a potato—formed of two that have

grown together. With feigned difficulty such a root is carried on the shoulder to the storage-pit. The bearer falls three (or ten) times to his knees or at full length, saying, 'I cannot carry it, holy *Agräs*; it is too heavy for me.' The prayer to *Agräs* is in these words: 'Holy *Agräs*, provider, cause to grow hundreds and thousands of the same sort; bring us turnips as thou comest to the pit.' According to another account, *Agräs* is entreated to bring the worshipper a certain quantity of turnips from the storage-pits of others.

Still another agricultural deity is mentioned by Agricola, viz. *Köndös*, who made 'reclaimed lands and tilled fields.' According to E. N. Setälä, the name is derived from a Finno-Ugrian word meaning 'seed-corn,' 'grain.'

(e) *Deities of the air and the sky.*—*Ilmarinen* (from *ilma*, 'the air'), who, according to Agricola, 'gave calm weather and bad weather, and furthered travellers,' is to be regarded as a Finno-Ugrian god of the air. The name *Inmar*, applied to the supreme deity of the pagan Votiaks, corresponds phonetically to *Ilmarinen*. But the position assigned to *Inmar* is to some extent due to the influence of the conception of deity current among the neighbouring Christian and Muhammadan peoples. *Ilmarinen*, again, can hardly be without some connexion with the Scandinavian *Njord*, who reappears with Thor and Frey in Lappish mythology. The figure of *Ilmaris*, 'the ruler of the storm and of bad weather,' has been found, together with that of the thunder-god, on the magic drum of a Finnish Lapp.

The Finnish word *Jumala*, which is found in Icelandic literature as early as 1026 (*Jómali*), and is now used by the Finns not only of the Christian God, but for 'god' in general, is supposed by some to mean 'heaven,' being explained either as a Finno-Ugrian root conjoined with the Samoyed *Num*, or as an Indo-Iranian loan-word (cf. Skr. *dyumant*, 'clear'). Others, again, regard it as connected with the Vogul *jomas*, Hung. *jó*, 'good.' *Jumala* would in that case signify the possessor of the good, of happiness, i.e. 'the blessed one' (cf. Slav. *Bog*, 'God,' and *bogatyi*, 'rich'; also Skr. *bhaga*), and, applied originally to the 'blessed' dead, would come to denote deity in general, and at length, under the influence of a higher religion, to serve as the specific designation of the one supreme God.

Agricola refers, finally, to the worship of 'many others—of stones, stumps of trees, the stars, and the moon.' But the statement is made purely for the purposes of his scheme. Among the Finns there is as little evidence for the worship of the heavenly bodies as for fetishism. There is no trace here of the sun-worship which the Lapps adopted from the Scandinavians. Agricola's references to the moon, viz. that *Rahkoi*, 'hoar-frost,' 'makes the moon black in parts,' and that *Kapeet*, 'the animals,' 'ate up the moon,' simply reflect popular notions regarding lunar markings and lunar eclipses.

3. *Sacrifice.*—It has been asserted that the Finns did not practise blood-sacrifice; but this is a false inference from the circumstance that such oblations are not mentioned in the epic and magic poems. There is evidence to show that about the end of the 12th cent. the Esthonians were in the habit of sacrificing oxen, goats, dogs, and even human beings. The Karelians, who were governed from Novgorod, were in 1534 formally accused of sacrificing oxen, sheep, and birds, and even of immolating their children in secret. Until quite lately the Greek-Orthodox Karelians on either side of the Finnish frontier used to perform communal sacrifices of oxen and rams beside their churches, these celebrations having been described and portrayed as recently as 1890. In the most northerly part

of Russian Karelia it is the practice, on the 15th of August (O.S.), to bring a number of votive wethers from a fairly large surrounding area to the village church. In the woodland before the church a fire is kindled early in the morning; a cauldron is scoured, and water poured into it. The slaughterer takes one sheep after another beneath the penthouse, in the flooring of which there is a hole with a lid, and presses the animal's neck upon this hole. Then, calling on an assistant to hold the sheep fast by the feet, he runs his knife into its throat, and lets the blood flow down under the flooring. The animal is next flayed outside the enclosure. The fleece also falls to the church, but the owner of the animal may redeem it for a small sum. The flesh is then cut in pieces and boiled in the cauldron. The head and feet of the sheep thus slaughtered are burned in the fire. The boiled flesh is put into large boxes of birch-bark, and carried outside the enclosure. The broth is made into a gruel with peeled barley collected from the villagers, and into this the fat of the animal is stirred. The people then hold united prayer in the chapel, and the sacrificial feast begins. First of all, the meat, which has been fumigated with incense, is eaten. Every donor of a sheep brings a loaf with him, and the villagers also contribute. Meanwhile the pottage is ready, and is put into similar receptacles of birch-bark. Only the men—with heads uncovered—take part in the ceremony, the women and children being present merely as spectators. Bones and dropped fragments of meat are gathered up and placed in a covered box made of knee-pine chips, and this is bound with a rope to which a stone is attached, and cast into a deep pool near at hand, for nothing must be left to be eaten by the dogs.

4. **Magic.**—Another popular but equally erroneous idea is that the magic of the Finns rests upon a fanciful belief in the power of the 'word.' As a matter of fact, our earliest record of a Chudic magician—in a Russian Chronicle of A.D. 1071—tells how he summoned up spirits while lying dumb, i.e. in the ecstatic state. The sacrificing priest of the Esthonians passed beyond this primitive shamanistic stage, and (c. A.D. 1200) became what the Latin Chronicle of Henry the Lett speaks of as a *hariolus*. The practice of divining by means of a horse—by observing which foot it lifted first, as described by that Chronicler—was adopted by the Esthonians from the Slavs or Lithuanians. The heathen priests of the Karelians are called *arbui* (*arpoja*, 'one who knows the art of casting lots') in the official Russian libel of 1534. A specially popular practice among the Finns, even in recent times, was divination by the sieve, which came to them by way of the Scandinavians and the Russians. Finnish magicians probably uttered prayers at their sacrifices even in heathen times. The sacrificial prayer of an Esthonian priest of the thunder living in 1644, and the Ingrian song of Ukko which tells of Sämpsä, may perhaps date from the heathen period. But it was only under the influence of the mediæval spells of Christian origin current among the Scandinavians that the Finnish magicians composed and elaborated their magic songs.

LITERATURE.—The main sources are indicated in § 1 and in the art. FINNO-UGRIANS. KAARLE KROHN.

FIRE, FIRE-GODS.—The discovery of a method of making fire may be described as the most important step in progress ever made by the human race. To dilate upon the obvious reasons for this description is unnecessary. The history of fire-making alone would fill a volume. Consistent with its cultural importance is the voluminous mythology and ritual concentrated upon fire in early

civilization; the modern anthropological literature of the subject is scarcely less voluminous.

Previously to the scientific development of the 19th cent., the general view was that fire-making, together with all culture, was a quite recent achievement of mankind. Stories of contemporary savage tribes to whom fire was unknown are still discussed as possessing a possible foundation in fact.¹ But recent calculation places the knowledge of fire-making as early as the Second Inter-glacial epoch, approximately more than 400,000 years ago. The Krapina men possessed the knowledge of fire-making, and there is no reason to suppose that the early Palæolithic period failed to evolve the art. In all likelihood the first suggestion came neither, as Peschel thought, from volcanic fire, nor, as others have thought, from forest fires or trees struck by lightning, but from the inevitable sparks produced in the manufacture of flint implements.

1. **Fire-making.**—The chief primitive methods are frictional, percussive, compressive, and optical. The modern is chemical. Among barbarous peoples of to-day the frictional is the most used; the compressive method comes next. The percussive—probably the oldest—lasted the longest. Mechanical inventions making it efficient were responsible for its remaining in use till a century ago. Optical methods have been rare, as is natural; chemical methods are barely a century old.

(a) The simplest frictional method is the *stick-and-groove*. 'A blunt-pointed stick is run along a groove of its own making in a piece of wood lying on the ground.'² It is a method chiefly obtaining among the South Sea natives. The Central Australians employ it as well as the 'fire-drill.' Hard wood is used for the moving component, soft for the stationary. In the Arunta tribe

'two men will sit down opposite to one another, holding a shield steady on the ground between them by means of their feet; then taking one of their spear-throwers they will each of them, holding on to one end, pass it vigorously backwards and forwards with a sawing motion over the shield, the surface of which soon becomes marked by a groove. The fine powder, which is separated off very soon, often in less than a minute, begins to smoulder, and then by careful blowing a flame is soon produced in the dry tinder amongst which it is placed.'

A variation is used by the Warramunga tribe; in a cleft stick of soft wood a hard stick is smartly rubbed.³

The *fire-drill* has a wide range: Australia, Tasmania, Malaysia, Kamchatka, ancient India, Ceylon, Europe, Africa, Central, South, and North America,⁴ show it to be the most generally diffused method, and no doubt it was independently evolved by various peoples. Captain Cook described its simplest form as used by Australians:

'They produce fire with great facility, and spread it in a wonderful manner. To produce it they take two pieces of dry soft wood; one is a stick about 8 or 9 inches long, the other piece is flat: the stick they shape into an obtuse point at one end, and pressing it upon the other, turn it nimbly by holding it between both their hands, as we do a chocolate mill, often shifting their hands up, and then moving them down upon it, to increase the pressure as much as possible. By this method they get fire in less than two minutes, and from the smallest spark they increase it with great speed and dexterity.'⁵

As with the fire-saw, so with the fire-drill, two workers are essential. The latter method is even more laborious⁶ than the former, and its wider prevalence is due chiefly to mechanical improvements. The Australians cut a notch extended to the edge of the stationary wood, to admit the twirled stick and to allow the powder to fall out. Knowing that the twirling must be absolutely continuous, they always employ two men who

¹ E. B. Tylor (*Early Hist. of Mankind*², London, 1870, pp. 231-239) criticizes elaborately these stories, with a conclusion generally unfavourable to their credibility.

² Tylor, 239 f.

³ Spencer-Gillen^b, 619 f.

⁴ Tylor, 240 ff.; Hirt, *Indogermanen*, Strassburg, 1905-07, p. 329.

⁵ *First Voyage*, iii. 234, quoted in Tylor, 240 f.

⁶ Long practice is necessary, for the muscular effort required is enormous.

relieve each other.¹ This familiar 'fire-stick,' twirled between the palms of the hands, is the predominant form of fire mechanism in art and mythology.

The principle of the carpenter's brace is a simple improvement, possible with a bent or elastic stick, and so used by the Gauchos of the Pampas. The operator presses one end of the stick on his breast and 'the other (which is pointed) into a hole in a piece of wood, and then rapidly turns the curved part, like a carpenter's centre-bit.'²

A cord wound round the drill is still used in India. The method is familiar to various peoples from the Eskimos to the Maoris.³ A cross-piece is used to keep the spindle steady and in its bearings; this is held by a second person, or the operator holds it in his teeth.

'To substitute for the mere thong or cord a bow with a loose string, is a still further improvement, for one hand now does the work of two in driving the spindle.'⁴

Ancient and modern Egyptians used this method for drilling holes. The North American Indians employed it for fire-making. A variation is the *pump-drill*, in which the cross-piece moves up and down, winding and re-winding the cord. This is found in Samoa, in a few South Sea Islands, and among the Iroquois.⁵

(b) In Borneo, Sumatra, and parts of Eastern Asia, fire is occasionally made by *striking* together two pieces of split bamboo.⁶ The siliceous coating makes this possible, but it is a precarious method. As for the use of flints, the Fuegians strike sparks with flint upon iron pyrites.⁷ The method is attested for Neolithic Britain.⁸ Eskimos and North American Indians employ it.⁹ Its obvious advantage over friction of wood is that the latter depends very much on the dryness of the atmosphere. 'The flint and steel may have come into use at any time after the beginning of the Iron age.'¹⁰ Employed in ancient Greece, Italy, and China, it became the universal method in Western civilization from the Roman Empire to the 19th century. The invention of fire-arms assisted to perfect the method, the hammer and trigger mechanism of the pistol being very convenient. Modifications of the fire-arm, attached to a candlestick, were in general use throughout Europe for centuries. Chalcedony was often used. For tinder, burnt-linen rag was the staple article. The modern chemical method was indirectly due to this, sulphur-tipped matches being first employed to get a reliable flame from the tinder. The precursors of the modern match were numerous and curious.¹¹

(c) *Compressive* and *optical* methods have never been commonly employed. A tube 'closed at one end, into which a packed piston is sharply forced down, thus igniting a piece of tinder within the tube,' is used in Malaysia and Burma. The use of a lens was known and practised in ancient Greece and Italy; China and Siam to-day are familiar with it.¹² The Spanish accounts of the Peruvian method of lighting the sacred fire by a lens, as also of the virgins of the Sun who guarded the fire, are at least doubtful, owing most of their details, as Tylor has shown, to Plutarch's account of the Vestal Virgins of Rome and the sacred fire of Vesta.¹³

There does not seem to be any regular course of

¹ Spencer-Gillen^b, 620.

² C. Darwin, *Narrative*, London, 1839, iii. 438.

³ Tylor, 243 ff.

⁴ *Ib.* 246.

⁵ *Ib.* 247 ff.

⁶ *Ib.* 240.

⁷ *Ib.* 249.

⁸ *Official Catalogue of Science Section of Anglo-Japanese Exhibition*, London, 1910 (reprint [O. E. Janson and Son], 1912). The flint and pyrites nodule, found in a barrow, are in the British Museum.

⁹ Tylor, 250.

¹⁰ *Ib.*

¹¹ See *Official Catalogue*, p. 113 ff.

¹² Tylor, 249, 251.

¹³ *Ib.* 252 ff.

evolution in fire-making implements. The use of the fire-drill does not necessarily precede or lead up to that of the flint and steel. Nor has the simplest frictional method led to anything of real economic value. The 'fire-saw' and the 'fire-plough' are merely extensions of that method. The cord, centre-bit, and pump-drills are applications to it of simple mechanical expedients. But there is a tendency for drills to predominate in dry, hot climates; flint and steel are limited by the presence or absence of suitable percussive minerals. Savage life shows that fire is rarely made, for it is very easy to secure a permanent supply.

2. **Social regard for fire.**—The myths of the invention of the art are numerous. The process is one to appeal to the imagination. Their chief characteristics are the ascription of the invention to a bird or bird-hero, and the personification of the implements. Thus in China a myth recounts how

'a great sage went to walk beyond the bounds of the moon and the sun; he saw a tree, and on this tree a bird, which pecked at it and made fire come forth. The sage was struck with this, took a branch of the tree and produced fire from it, and thence this great personage was called *Suy-jin*.' *Suy* is the drill or the speculum. *Suy-jin-shu* is the 'first person who procured fire for the use of man.'¹ The Sanskrit name for the *arani*-spindle, *pramantha*, is probably connected with the name of the Greek fire-giver, Prometheus;² the *vápn̄h̄* in which he stored the fire stolen from heaven is repeated in savagery by the stalk or reed whose dry pith forms smouldering tinder.³

A simple form of regard shown in maintaining fire, to avoid the inconvenience of re-making it, is connected, directly or indirectly, with the religious cult of the perpetual fire.⁴

The Tasmanians never let their fires go out.⁵ The house-fire, as in Korea,⁶ is never extinguished. European peasantry, as the South Slavonians and Calabrians, elevate the rule into a ritualistic principle.⁷ The Israelites carried their fire with them on the march.⁸ The Russian peasant carries his fire to his new house, where he deposits it, saying: 'Welcome, grandfather, to the new home.'⁹ The old Norsemen 'marched round the land with fire,' claiming the area they could walk round carrying fire, from six in the morning to six in the evening.¹⁰ Various tabus have been enforced in early culture upon the tending and carrying of fire. These follow the lines of similar regulations.¹¹

Two poles of sentiment are fear of the destructive power, and gratitude for the comfort and usefulness, of the element. An extensive series of myth and metaphor is evolved from these. The general importance of fire in human life is shown by the way it enters into social symbolism and nomenclature. There are Fire phratries and Fire totems.¹² Fire is placed on the grave to warm the dead.¹³ The Calabrians take an oath by nipping a flame between the fingers and swearing 'by the light of God.'¹⁴ Australian boys at initiation receive a fire-stick, ceremonially presented by the mother of the future wife.¹⁵ Fire and sunshine are permanently connected in the social imagination. Both are avoided by persons under tabu, especially girls during their first menstrual period. Impreg-

¹ Tylor, 256, quoting authorities.

² A. Kuhn, *Herabkunft des Feuers*, Gütersloh, 1886, pp. 13, 15, 78; the upper and lower blocks 'may be the upper and lower *arani*, and the spindle the *pramantha* or *cdra*' (Tylor, 258).

³ The Australians use *Banksia* stalks (Frazer, *JPh* xiv. [1885] 168); fire first made by two hawks (Spencer-Gillen^b, 619 f.).

⁴ J. G. Frazer, *Totemism and Exogamy*, London, 1910, ii. 491, iii. 160, 184, 239, iv. 179.

⁵ J. Bonwick, *Daily Life and Origin of the Tasmanians*, London, 1870, p. 20.

⁶ C. Dallet, *Hist. de l'Eglise de Corée*, Paris, 1874, vol. i. p. cxlvii.

⁷ F. S. Krauss, *Sitte u. Brauch der Südslaven*, Vienna, 1885, p. 592; V. Dorsa, *La Tradizione, etc., della Calabria citeriore*, Cosenza, 1884, p. 20.

⁸ Ex 1321.

⁹ W. Ralston, *Songs of the Russian People*, London, 1872, pp. 120, 137 ff.

¹⁰ J. Grimm, *Deutsche Rechtsalterthümer*, Göttingen, 1881, p. 195.

¹¹ Frazer, ii. 604 ff.

¹² Spencer-Gillen^b, 349; Frazer, iii. 118 f.

¹³ Frazer, i. 143.

¹⁴ Dorsa, 21.

¹⁵ Spencer-Gillen^a, 250, b349.

nation by fire is a common notion connected therewith.¹ Circumcision among the Australians is performed by means of a fire-stick.² The newly initiated boy is placed by women on a fire.³ Here we approach the purificatory idea. A connexion with the principles of 'rites of passage' is shown in the formal extinction of fire on a death, and the making of new fire on certain occasions of social crisis and change.⁴ In the Warramunga and Mara tribes of Australia, the co-operative totem system is applied, one moiety making fire and handing it over to the other.⁵ The idea of fire as a purifier is universal.⁶ Connected with this is its power to expel evil or to bar its approach.⁷ Many peoples throw food and drink to the fire before meals.⁸ Fire tends to develop 'sacred' associations.⁹

3. Fire-ritual.—Fire-worship proper will be discussed below in §§ 6 and 7. The ritual of perpetual fire can hardly be regarded as fire-worship. Sacrifice by fire, and various ceremonies in which fire is used, show it as a means and not as an end of the rite. Frazer's theory of the common origin of the Greek *prytaneion* and the Italian temple of Vesta, from a pre-historic custom of the tending of the common fire in the chief's round house by the chief's daughters, involves the general principle of the superposition of religion upon custom.¹⁰ Farnell objects to this theory, and maintains that optical methods were employed at Athens, the primitive fire-sticks being used only at Rome, and that women, in historical times, were excluded from the *prytaneion*.¹¹ He accordingly regards the Roman ritual of Vesta as not secular but religious in origin.

The Damaras of South Africa possessed a ritual of the perpetual fire well developed, though neither magical nor religious. The fire was tended by the daughters of the chief—an anticipation of the Vestal Virgins in appearance if not in evolutionary fact. When the Damaras built a new village, the fire was supplied from that of the old one.¹² The extinction of the sacred fire at Rome was regarded by the superstitious as a national calamity, as the extinction of the village fire in any early community would be regarded as at least an inconvenience.¹³ A perpetual fire, sacred to St. Bridget, is said to have been extant in the 16th cent. at Kildare.¹⁴ The perpetual fires of the Iroquois and Natchez were in all probability little inferior in ritualistic observance to those reported of Mexico and Peru.¹⁵ At Cuzco the daughters of the Inca tended the fire. In the great temple at Mexico there was, it is said, a sacred perpetual fire before each chapel. In all these Central American cases, virgins were the keepers of the fires. Chastity was obligatory; infraction of the rule was punished with death. In Peru the fire was re-kindled by a concave mirror; in cloudy weather by fire-sticks. The Spanish chroniclers certainly have embellished their accounts in order to enhance their claim for the new world to be a second Rome.¹⁶ The theory that the perpetual fire cult was an Indo-European institution similarly demands considerable limitation.¹⁷

The ritual of purification and sacred burning is linked to a sequence of very widely spread and influential ideas. The simplest of these, though

¹ A. E. Crawley, *The Mystic Rose*, London, 1902, p. 197; Frazer, *Totemism*, ii. 258 f., 261 f., *GB*², iii. 210, 224, 305.

² Spencer-Gillen^b, 425. ³ Spencer-Gillen^a, 259.

⁴ Frazer, *Totemism*, ii. 529, iv. 225, 313. The ritual and lore of new fire are fully treated in *GB*² ii. 326, 331, 333, 465, 470, iii. 249 ff., 252 ff., 260, 272, 275 ff., 301 ff.; festivals, ii. 469 ff., iii. 237-307.

⁵ Spencer-Gillen^b, 620. ⁶ Frazer, *GB*² i. 308, *Adonis*, *Attis*, *Osiris*², London, 1907, p. 146.

⁷ J. G. F. Riedel, *De sluik- en kroesharige rassen*, Hague, 1896, p. 303.

⁸ Frazer, *JPh* xiv. 164; J. G. Bourke, *Moquis of Arizona*, London, 1884, p. 255.

⁹ Frazer, *Totemism*, ii. 112. ¹⁰ Frazer, *JPh* xiv. 145-172. ¹¹ *CGS* v. [1909] 345-365.

¹² C. J. Andersson, *Lake Ngami*, London, 1856, p. 223 f. So Greek colonies took with them a share of the sacred fire of the metropolis.

¹³ Dion. Hal. *Ant. Rom.* ii. 67.

¹⁴ W. Camden, *Britannia*, London, 1607, p. 747.

¹⁵ D. G. Brinton, *Myths of the New World*³, Philadelphia, 1896, p. 151; P. F. X. de Charlevoix, *Hist. de la nouvelle France*, Paris, 1744, vi. 173 ff.

¹⁶ As argued by Tylor, 252 ff.

¹⁷ W. E. Hearn, *The Aryan Household*, London and Melbourne, 1879, p. 49 ff.

apparently complex, may be found in savage ceremonies of renewal and removal of old things. The kindling of the new fire follows the expulsion of evils and the putting off of the old life. In the mere instinct for change and renewal we may find the key to many 'rites of passage' in which fire plays a more or less literal rather than a symbolic part. Such rites often include a formula of social reunion.

The *Engwura* of the Central Australian tribes is an elaborate service of regard for society. Its central feature is the Fire Ceremony. Women and men dance round separate fires. There is a Saturnalia of increasing licence, the tabus being relaxed one by one. Huge torches are carried, and a pole, 20 feet high, the *wintari*, is a central object whose function is doubtful but possibly is merely centralization. The principle of the ceremony is well brought out by the way in which it bears upon private relations. Two men who have quarrelled previously now fight it out with flaming sticks, after which the ill-feeling is never resumed. A general *mélée* with torches concludes the ceremonies; part of this is sexual, men and women attacking each other.¹

From such conceptions and realizations it is no long step to the elaborate philosophizing of Iamblichus, who held that fire burns all the mortal parts, leaving the immortal behind, or to the practice of burning the dead, and the connected principles of burnt sacrifice. In ancient theory, burning made its patient divine.² The passing of children through the fire is probably due in part to these ideas, and is paralleled by the Greek stories of burning children to render them immortal.³ The remarkable series of legends of which the figure of Cræsus is the type is a proof how in Asiatic and Semitic religion the idea of burnt sacrifice dominated the imagination of kings and priests. In the 19th cent. offerings to dead Rabbis were still burned at Maron in Galilee.⁴ In the 20th cent. the Catholic Church retains the belief in the purificatory fires of Purgatory, and the eternal fires of Hell. There can be little doubt that the fires of the *auto-da-fé* were kindled in consequence of a theory of purification by fire. They were thus the logical sequence of universal notions which retain their harmless realization in the fire-festivals of European peasants.

4. Fire-gods.—The fire-deity often reported for uncivilized communities is generally a vaguely envisaged *daimon* hardly emerged from fluid animism.⁵ In all cultures the fire-god proper appears to be an exception, and not a regular member of the pantheon. The history of religion practically includes only two genuine fire-gods—Agni of Hinduism, and Atar of Zoroastrianism. Fancy everywhere locates the source of fire in various natural objects, as the sun, or the kangaroo (Australian)⁶, or the oak, or any material from which it may be artificially or naturally produced. The divine person who invents fire-making or reveals its secret to mankind is no fire-god necessarily, but a culture-hero. Such was Prometheus. Nor can even Hestia-Vesta be claimed as a fire-goddess. Farnell has shown reason for regarding her essentially as a hearth-goddess—the personification, not of the fire, but of the hearth-stones.

Fire-worship may be practised without any hard and fast personification of the element. A case in point is the comparatively modern cult of the natural fires at Baku, whither pilgrims resort and make expiation for sin. Similar was the ancient worship of natural fires in Cappadocia.⁷

5. Fire in Hebraism.—Mention of fire and fire-ritual is remarkably rare in the Hebrew books,

¹ Spencer-Gillen^b, 375-392; cf. Spencer-Gillen^a, 271-386.

² Frazer, *Adonis*², 146; Iamblichus, *de Mysteriis*, v. 12.

³ So Isis and Demeter (Frazer, *Adonis*², 147).

⁴ W. M. Thomson, *The Land and the Book*, ed. 1859, p. 280 f.

⁵ Another class is represented by the carved wooden figure above the Maori hearth. This is no fire-god, or even hearth-god (R. Taylor, *Te Ika a Maui*², 1870, p. 501).

⁶ Spencer-Gillen^a, 208. ⁷ Frazer, *Adonis*², 156, 158 ff.

though the principle and practice of burnt-offering are ubiquitous. The man who was 'gathering' (*m'kôshêsh*) sticks¹ probably intended fire-making by friction of wood. A possible reference is the 'two sticks' mentioned in 1 K 17¹². Legend tells that the fire-drill was given and the method explained by Jahweh to Adam and Eve. Flint and steel are mentioned in 2 Mac 10³, and the fire-stone (*hallâmîsh*) was used in historical times.² Fire for domestic use was forbidden on the Sabbath. In common with other early culture, Hebrew economy rarely used fire for the heating of dwellings. There was a Mosaic ordinance forbidding the use in the sanctuary of 'strange fire,' or 'fire of commoners,' explained as newly kindled fire, or that taken from profane hearths.³ Rabbinical lore stated that fire was created on Monday or the Sabbath eve; when Adam was overwhelmed by the first darkness, the Holy One gave him two 'bricks' for the production of fire. These he rubbed together, and fire came forth.⁴ The holy fire of the Hebrews was of Divine origin.⁵ From the fire Jahweh spoke to Moses.⁶

6. Fire in Brâhmanism.—Fire is the first of elements; it was produced from the *Sat* or *Brahman*.⁷ Manu held that it sprang from water; the Vedanta Sûtras from air; the Upanisads say it produces water.⁸ Gold is its first-born.⁹ In union with air it warms the ether. Its subtlest component becomes the speech of men, and man's breath is merged in it at death.¹⁰ The Upanisads speak of the seven tongues of fire.¹¹ Fire resides in the right ear of the goat, the right hand of a Brâhmaṇa, in water, and in *kuśa* grass.¹² The digestive process is identified with the action of fire, *vaiśvânara*.¹³ Philosophy elaborated the cosmic relation of the self to Brahman by means of fire and its symbolism. Sparks and fire, according to the Upanisads, are to one another as individual souls are to Brahman.¹⁴ The self is compared to fire produced by the two *araṇi*-sticks. The process of fire-production with the *samidhs*, kindling-sticks, the 'churning of fire,' is an act of generation; the drill is male.¹⁵ In the theory of the 'three fires' these are the three worlds.¹⁶ A trace of primitive magic is to be seen in the account of the *agnihotra*, 'fire-offerings,' in the *Satapatha Brâhmaṇa*. If these are not offered, the sun will not rise.¹⁷ In the *Jaina Sûtras* there occurs the curious notion of 'fire bodies.'

*Some beings, of various birth and origin, come forth as fire-bodies in the manifold animate or inanimate bodies of movable or immovable creatures.¹⁸

The rules to be observed in connexion with the sacred fire are numerous.¹⁹ Sacred fire was kindled at weddings. At funerals the sacred fire for the burning of the body was carried in the procession to the *śmaśāna*, or 'burning ground.' A heap of fire-wood was piled, and the leader of the ceremony kindled three 'sacred fires.' The spirit of the dead person, 'invested with its incombustible subtle frame, was supposed to rise along with the smoke to heaven.'²⁰ The householder re-kindled his fire when religious rites were performed. The clay hearth was termed *grihyâgni*, 'household fire,' and 'was sufficient for all domestic ceremonies, *smârta*-

1 Nu 1532f. 2 E. G. Hirsch, in *JE*, s.v.
3 Lv 101, Nu 34 2651. 4 Talmud Jer. *Ber.* 12a.
5 Hirsch, *loc. cit.* 6 Qur'an, *SBE* ix. 35; cf. Ex 34.
7 *SBE* i. 93, 100, xxxviii. 20 ff., xlviii. 632 ff.
8 *Ib.* xxv. 399, xxxiv. p. lii, i. 94, 100, 117 f., xxxviii. 22 f.
9 *Ib.* xiv. 134; cf. xlii. 125.
10 *Ib.* i. 117, 96 ff., 101, 108.
11 *Ib.* xv. 31, xxxiii. 14. 12 *Ib.* xiv. 160.
13 *Ib.* vii. 69, viii. 118. 14 *Ib.* xv. 34.
15 *Ib.* xv. 236 f., xii. 275. 16 *Ib.* xlii. 178.
17 *Ib.* xii. 328. For the churning of fire, see *ib.* xii. 275.
18 *Ib.* xiv. 397.
19 *Ib.* ii. 1 f., 201, xxv. 104, 108, xxix. 385 f., xxx. pp. xxvi, 133, xxxviii. 306.
20 Monier-Williams, *Brâhmanism and Hindûism*⁴, London, 1891, pp. 280 f., 282 f.

karman.' A more elaborate arrangement was used in the *homa sâlâ*, or room for fire-ritual. Here fire was kindled in three different receptacles, each fire having a different name, *Ahavanîya*, *Gârhapatya*, *Dakṣiṇa*. Each morning the family assembled round the fire, saying: 'We approach thee, O fire, daily with reverential adoration in our thoughts.' It was then 'fed' with bits of consecrated wood, *samidh*, from the *palâsa*-tree. The smouldering embers of the sacred element were not allowed to be extinguished. If this occurred,

'the whole household fell into confusion. Everything went wrong until an expiatory ceremony, *prâyatçhitta*—sometimes consisting of a solemn fast observed by both husband and wife—had been performed, and the fire was re-kindled.'¹

The daily fire service is the *Homa* ceremony.

The Fire-god Agni.—The god Agni is the most perfect instance of a divinized personification of fire, and perhaps the only genuine instance. The three great Vedic gods—the Fire-god, the Rain-god, the Sun-god—were born respectively from the earth (Agni), the air (Indra), and the sky (Sûrya), one representing each of the three worlds. Agni was 'god on earth,' and more accessible. He took precedence over all others in sacrificial ceremony. His triple form was of terrestrial, celestial (lightning), and solar fire.² Agni

'was manifested by the friction of the two pieces of the sacred fig tree called *Araṇi*, and consequently always to be found at hand. He was visibly present in every household. He was man's domestic friend, the father of the sacrifice, the mediator between men and gods, the bearer of hymns and prayers from every family altar upwards towards heaven.'³

He is sage, priest, king, protector. His origin is threefold—from air, water, and the 'mystic double *Araṇi*.' He is the giver of immortality, and purges from sin. After death he burns away the guilt of the body, and carries the immortal part to heaven, to dwell with the righteous.⁴ Fire is male, and water female.⁵ Agni is lord of the elements, and is all the deities.⁶ He is the god of the house, and of the clan. As priest he superintends his own sacrifice. The focusing of religious sentiment upon Agni is well illustrated in the Vedic hymns:

'Agni *Vaiśvânara*, the other fires are verily thy branches, O Agni. In thee all the immortals enjoy themselves. Thou art the centre of human settlements; like a supporting column thou holdest men. The head of heaven, the navel of earth is Agni; he has become the steward of both worlds. Thee, a god, the gods have engendered, O *Vaiśvânara*, to be a light for the Arya.'⁷

The hymns and the *Satapatha Brâhmaṇa* have the fullest account of Agni. The sun first appeared when Agni was born. He had long remained hidden, till the gods discovered him and revealed him.⁸ Agni is the essence of earth, squeezed from earth. He is produced by attrition by ten young women, the fingers. Firewood is his food. *Ghi* is sacred to him, and his offerings are cakes and butter. The bricks of the fire-altar are his limbs; he has three heads and seven rays (or reins).⁹ He is the object of the daily worship of the fire (*tejas*, or *vyotis*, fire as the element).¹⁰ To poke the fire wounds him, and is sinful. To spit before the fire is a sin.¹¹ Generally he is the protector against evil; he repels the *Rākṣasas*, and wards off evil from both gods and men.¹² He is, further, invoked by lovers, to produce magical intervention in their love. Women belong to him. The menstrual blood of women is Agni.¹³ Men invoke him for virility.¹⁴

1 Monier-Williams, p. 365 ff.
2 *Ib.* 9 f.; on Agni, see especially Macdonell, *Ved. Mythol.*, Strassburg, 1897, pp. 88-101; Hillebrandt, *Ved. Mythol.*, Breslau, 1891-1902, ii. 57-154.
3 Monier-Williams, 9 f. 4 *Ib.* 15. 5 *SBE* xii. 9 f.
6 *Ib.* viii. 276, 346. 7 *Ib.* xvi. 49.
8 *Ib.* xvi. 326, 330, xii. 47, 452, xlii. 3, 270 ff., xvi. 54 f.
9 *Ib.* i. 70, xlv. 75 f., xliii. 189, ii. 202, xii. 118, xvi. 3, xii. 156, xvi. 167 f.
10 *Ib.* ii. 16. 11 *Ib.* xii. 49 f., i. 29.
12 *Ib.* xii. 35 f.
13 *Ib.* xlii. 104, xiv. 133, i. 232, xxxiii. 171; see Crawley, *Mystic Rose*, 197.
14 *SBE* xiii. 32

Sometimes Agni is theriomorphic, identified with the white horse led in front of him.¹ At another extreme he is the object of the Brāhmaṇa's meditations as universal spirit, Brahman.²

7. Fire in Zoroastrianism.—The two chief differences between Indian and Persian fire-worship are (1) the abhorrence in the latter of burning the dead, and (2) the imperfect personification of Ātar as compared with Agni. Some deny that fire is personified at all in Zoroastrianism.³ Whereas the worship of Agni and the ancient ritual have degenerated in Hinduism, one Brāhmaṇa sect alone keeping up any appearance of the cult, the modern Parsis practise a very conservative form of the ancient fire-ritual.

Fire is the earthly form of the heavenly light, the eternal, infinite, divine. The life of all creatures is vital fire.⁴ Fire is the son of Ahura Mazda. The infant Zarathuštra was taken out of fire, like King Arthur. Ahura and his Fire and Mind protect Zarathuštra.⁵ Fire is diffused through the 'six substances.' It is the 'Good Diffuser' in men and animals. It is of five sorts. Ahriman mingled darkness and smoke with it.⁶ Signs from the holy fire are invoked by prayer to Ahura. Ātarō assists Ahura in his conflict with Angra Mainyu. Ātarō also fights against Azi and Angra Mainyu. Again the Fire Vāzist fights the demon Apāōsh. There is also the Fire Frōbā. The Fravashi of fire is worshipped.⁷ The Avesta and the Pahlavi texts reiterate the duty of worship, simpler in details than the Vedic ritual.⁸ The priests are the protectors of the sacred fire, which may not be extinguished. To allow it to be extinguished is a sin. For the sun to shine upon it is a sin.⁹ Before the ashes are removed they must be cold.¹⁰ The Persian horror of the contamination of death, the *Druj*, naturally is very explicit here. If a man or dog died where the holy fire was, the fire had to be removed for nine nights in winter and a month in summer. Death was the penalty for casting a corpse, or even cow-dung, into the fire; even for breathing upon it.¹¹ No offering might be made without looking at the sacred fire. Three times a day the archangels form an assembly in the fire-temple. The prayers and the morning service resemble the Vedic,¹² but throughout the tendency is towards a somewhat impersonal realization—at any rate, a much less anthropomorphic realization than was the case in India.

LITERATURE.—To the authorities cited, add the articles 'Prometheus,' 'Hestia,' in Roscher, and for N. America, W. Hough, 'Fire-making Apparatus in the United States National Museum,' in *Report of the National Museum*, Washington, 1890, pp. 531-587.

A. E. CRAWLEY.

FIRE-WALKING.—This is an ancient as well as a modern rite, and is practised in various parts of the world. It is ostensibly an exhibition of supernatural power, and may be either an act of devotion or an ordeal designed to test the purity of a woman, the truth of a sworn statement, etc. Its earliest application may have been magical, to make the sun-fire shine in spring-time. The Semitic rite of passing children through fire, though sometimes connected with 'fire-walking,'

¹ *SBE* xli. 204, 359, xxvi. 149.

² *Ib.* l. 118, 304.

³ *Ib.* iv. p. lxxvi.

⁴ *Ib.* iv. 60 f., xviii. 42, 172.

⁵ *Ib.* iv. 101, xxxi. 132, 133.

⁶ *Ib.* v. 61 ff., 159, 184 f., 163.

⁷ *Ib.* xxxi. 177, 182, xxiii. 198, v. 229, xxiii. 200.

⁸ *Ib.* xxxi. 196-199, 204-210, 212-220, 222-227, 251, 256 ff., 270-277, 320, 323 ff., 331, 346-348, 351, 353, 358, 374, 381-384, xxiii. 322, 334, v. 298 ff., 375, 393-396, xviii. 163 f., xxxvii. 231, 266, 350 f. For comments on the texts, see *ib.* i. p. xxii, iv. pp. xiii, lxii, lxiv, lxxv ff., lxxix f., v. p. lxi.

⁹ *Ib.* xviii. 353, xxiv. 270 ff., 301, 355 f., xxxvii. 96, 163 f., 188, 190 ff., xxiv. 334.

¹⁰ *Ib.* xxiv. 311 f.

¹¹ *Ib.* iv. 61 f.; Strabo, xv. 3. 14 (p. 732).

¹² *SBE* v. 61, 310, 333, xxiii. 322, 334; see iv. p. lii. On the fire-temple, see v. 310, xviii. 162, 173, 242, xxiv. 28, xxxvii. 119.

is really sacrificial, since the children were offered to Molech; whereas in fire-walking the object is to pass through fire without loss of life. As fire is a natural means of purification¹ and is regarded by most savages as a defence against evil spirits, one of the early forms of fire-walking was probably to ward off and cleanse from evil, such as the evil of drought, imagined to be a spirit. This motive would easily unite with that of aiding the sun to shine. Yet a distinction should be made between the mere kindling of fires and walking through fire or over fiery stones, the former not necessarily implying the rite of coming into bodily contact with fire.

The earliest recorded case of fire-walking is from India; but here the object is to establish the superior holiness of a priest. In the *Tāṇḍya Brāhmaṇa* of the Sāmaveda (c. 800 B.C.) it is said that two priests walked through fire to prove which of the two was 'the better Brāhmaṇa'; and of Vatsa, the successful candidate, it is reported that 'not a hair of his head was burned.' This story, however, is still more ancient, as a brief allusion to it is found in one of the *Saṃhitās* (of the Tāittiriyas, c. 1200 B.C.). The case forms also the basis of the later (c. 300 B.C.) legal enactment that, when the word of a witness is doubted, he shall undergo the same test, or a modification of it, in holding hot iron. Another early case in India is that of Sītā, the wife of Rāma. According to the *Rāmāyana*, after appealing to the fire-god to attest her wifely innocence by not injuring her, Sītā passed through fire and was not burned. A passage sometimes cited from Vedic literature (*Atharvaveda*, ii. 12) as evidence of the fire-ordeal is doubtful; but a hot-iron test is spoken of in *Chhāndogya Upaniṣad*, vi. 16; though neither of these implies walking through fire. The rite of passing through fire is still practised in India, to exhibit 'control of fire.'

In Europe, in classical times, the Hirpi, or 'Wolf clan,' of Mount Soracte walked through fire to propitiate the goddess (of fire or of wild beasts?) called Feronia. The god within the performer is said by Iamblichus, in his statement as to fire-walking (see A. Lang, *Magic and Rel.* p. 293), to guard the walker from harm. Strabo (xii. 2. 7) mentions a case where the ceremony was performed by women.

These instances from antiquity are corroborated by modern practices as found among savages and even civilized peoples, and are illustrated also by the usage of European rustics in leaping over fires as a ceremony. Thus, in the last century, a family in Spain possessed the 'hereditary power' of walking through fire unharmed. The Nistinares of Bulgaria dance in the hot embers of a fire and utter prophecies. Savages of the Pacific islands and elsewhere are wont to walk over red-hot stones to show their power. In India, China, Bulgaria, and some other places, the practice is connected with vernal observances—a circumstance which adds weight to the theory that it may originally have been a rite to induce sunshine. A number of instances of the modern practice have been collected by A. Lang (see Literature below), who has shown that no artificial preparation for the feet of savage fire-walkers is necessary. As practised in Mauritius, Fiji, the Society Islands, etc., the rite consists in walking deliberately and unscathed over an oven of hot stones, to which the feet are exposed,

¹ It is interesting to note in this connexion that, when, according to Parsi eschatology, the earth shall be covered with molten metal, 'all men will pass into that melted metal and will become pure; when one is righteous, then it seems to him just as though he walks continually in warm milk; but when wicked, then it seems to him in such manner as though, in the world, he walks continually in melted metal' (*Bundahišn*, xxx. 20, tr. West, *SBE* v. [1880] 126).

without protection, for about half a minute at the most, or time enough to pass over the glowing stones or embers for a distance of from 12 to 60 feet. In the case of red-hot or white-hot stones, the distance is usually 12 or 15 feet; in the case of hot embers, 60 feet appears to be the greatest recorded distance. The god is sometimes, as in Honolulu, invoked to temper the heat. The Maoris of New Zealand, who still practise the rite, claim that it was performed by their remote ancestors. But the reason for the custom is not made clear by any of the modern performers; nor is it yet understood how the participants escape injury. Civilized performers in Japan have the sophisticated explanation that through the rite a good god shows his power over the evil element of fire. Under native guidance some Europeans have successfully imitated savages in walking unharmed over the hot stones. The rite has been performed in modern times in Japan, China, Southern and Central India, Bulgaria, Spain, Trinidad, the Society Islands, Fiji, the Straits Settlements, Mauritius, New Zealand, etc.; and as a means of purification and of testing virginal innocence it was practised in Central and North America in the form known in ancient India, that is, as a passing through flames rather than a passing over hot stones.

LITERATURE.—J. G. Frazer, *GB* 2, London, 1900, iii. 305 ff.; A. Lang, *Modern Mythology*, do. 1897, and *Magic and Religion*, do. 1901, where will be found full references to the classical authorities and to preceding modern literature, to which may be added S. P. Langley, 'The Fire Walk Ceremony in Tahiti,' in *Nature*, Aug. 22, 1901 (reprinted in *Smithsonian Report*, 1901, pp. 639-644).

E. WASHBURN HOPKINS.

FIRST-BORN (Introductory and primitive).—

1. Special rites at birth of first-born.—Among both savage and civilized races the birth of children is associated with many rites, the main purpose of which is to protect them or to free them from the tabu incident to such a crisis in life as that of birth (see BIRTH). There is some evidence that these rites are more carefully observed in the case of the first pregnancy, the first confinement, the birth of a first child; or that certain ceremonies are peculiar to these events. This is only natural, since anything occurring for the first time is apt to be considered of great importance,¹ and in many quarters a certain sacredness attaches to the first child, the idea of sacredness, however, as so often happens, sometimes taking the form that the child is unlucky either in itself or in its relation to others.

In Motlav (Melanesia) there are special feasts and rites after the birth of the first-born, the women of the village sleeping and feasting at the house for 20 days and decorating themselves differently every day. On the 20th day the father's sister brings the child out of the house, hands it to each woman in turn, and then carries it four times round the circle (Rivers, *FL* xxi. [1910] 48). In Mota a little bow is put in the child's hands, and the mother's brothers shoot at it with blunted arrows. Then the father's sister holds it with arms straightened till they tremble, repeating a verse regarding the future of the child and its wife (*ib.*). Among the Southern Massim (New Guinea) the umbilical cord of a first-born is placed in the sheath of a leaf growing near the base of a banana. The produce of this tree then forms the material of a series of feasts given, only in the case of a first child, by the maternal uncles. In such a case the father remains in the *potuma* for 6 months, and must abstain from certain foods, nor must he touch the child until it is about 8 months old, else it would turn ill. A first-born is called *halafwau* (the others are called *halabeafa*), and certain foods are forbidden to it until it is 2 or 3 years old (Seligmann, *Melanesians of Brit. N. Guinea*, Camb. 1910, p. 486 ff.). Among the Northern Massim the father sleeps in the verandah of the house before and after the birth of the first child, but not in the case of other births (*ib.* 704). A Basuto wife must leave her husband a month before the birth of a first-born, because it must be born in the house of her parents, else it would not live. If it is a boy, there is dismay, a girl being eagerly looked for on account of the dowry which she will bring to the family at marriage. When it is weaned, the child is taken to the grandparents and remains with them; they also receive the dowry in the case of a girl (*FL* xv. [1904] 249 f.). Among the Washambala, at the birth of a first child the happy father presents

a bullock to his wife's father (Steinmetz, *Rechtsverhältnisse von eingeborenen Völkern in Afrika und Ozeanien*, Berlin, 1903, p. 232). Among the Caribs, at a first birth the father was wounded and the child baptized with his blood. He had also to undergo a long and strenuous fast (Müller, *Amer. Urrelig.*, Basel, 1855, pp. 212, 214). Similarly, in India, where the ancient ritual in connexion with impregnation, quickening, and birth is still in vogue, some of it is confined to the birth of a first child, e.g. the *simantonnayana*, or hair-parting rite, performed on the woman (see Monier-Williams, *Rel. Thought and Life in India*, London, 1883, p. 355 f.; *ERE* ii. 650b). In the Panjāb there are great rejoicings at the birth of a first-born male, and in Kāngra there is a pilgrimage to the family-god, a he-goat being let loose in his honour, and another sacrificed; and a feast is given (Rose, *JAI* xxxvii. [1907] 224).

In many instances the marriage is not regarded as complete until the birth of the first-born, this constituting the final ceremony of marriage—a natural belief, since the appearance of the child is at once a certificate of the parents' union and a kind of covenant token between them. Occasionally the husband lives with his wife's people until the child is born, or there is a second ceremony of marriage before the birth (see Rose, *FL* xiii. [1902] 278 f.; Crawley, *Mystic Rose*, London, 1902, p. 432 f.). Among the Zulus the woman is not called 'wife' until she has given birth to a child (Shooter, *Kafirs of Natal*, London, 1857, p. 74). This is akin to the Hindu belief that 'he only is a perfect man who consists of three persons united—his wife, himself, and his offspring (Manu, ix. 45 [*SBE* xxv. 335]), and to the saying that 'immediately on the birth of his first-born a man is (called) the father of a son and is freed from the debt to the manes' (Manu, ix. 106; see below, § 5).

Again, there is a wide-spread custom of the parents calling themselves by the name of the first-born, as among the Malagasy, *Raini Soa*, 'father of Soa,' *Reni Soa*, 'mother of Soa' (Ellis, *Hist. of Madagascar*, 1838, i. 154). This custom is found in many parts of Indonesia, Australia, among the Bechuanas, and elsewhere (see instances in Crawley, 428 f.; Merker, *Die Masai*, Berlin, 1904, p. 59; Van Gennep, 67), and is akin to the Hindu custom just referred to. It probably originated in the natural pride of the parents at the birth of a child in whom they were now content to merge their personality.

2. Superstitions regarding the first-born.—The sacredness attaching to the first-born is seen also in certain superstitious beliefs of which various examples from different parts of the world and different levels of culture may be cited.

Among the Semang of the Malay Peninsula the souls of first-born children are believed to be young birds newly hatched, offspring of the bird which contains the soul of the mother. These birds obtain souls from Kari, the thunder-god (Skeat-Blagden, *Pagan Tribes of the Malay Peninsula*, London, 1906, ii. 4). In the South Sea Islands, where a peculiar sacredness enwraps the first-born, whether male or female, no one must pass through the door by which he or she enters the father's house (Gill, *Myths and Songs from the S. Pacific*, London, 1876, p. 46). In the Panjāb a lock of hair cut from a first-born is taken by barren women to wizards, in order that the principle of life immanent in the first-born may be extracted from it (*FL* xiv. [1903] 102). The first-born is there held to be uncanny, subject to magical influence, and endowed with supernatural power. He can stop hail- or dust-storms, and snakes are torpid before him. When the first-born is a girl, this is particularly ill-omened. Muhammadans in N. India think that a first-born can stop excessive rain by certain rites (Rose, *FL* xiii. 63, 273). In N.W. India it is believed that, if two first-born persons stand together in a thunderstorm, they will be struck by lightning (Crooke, *ib.* 188). Generally in India the first-born is regarded as peculiarly sacred. Among the Negroes of Jamaica it is considered of good omen if a first-born strike his right foot against a stone, but of ill omen if it be the left foot (*FL* xv. 450). Coming nearer home, we find in Devon the belief that the first-born cannot be overlooked by a witch, and in Buckinghamshire that he cannot see ghosts (*FL* xix. [1903] 340, 342). In various parts of England it is considered unlucky if the first-born is a boy, whereas a girl is lucky (*FL* viii. [1897] 195).

3. Killing or sacrifice of the first-born.—Much discussion has taken place regarding the Hebrew Passover rites, the redemption of the first-born, and the instances of the sacrifice of the first-born (2 K 16³ [? first-born, cf. 2 Ch 28³], Jer 19⁵ 32³⁵ [sons

¹ See Van Gennep, *Les Rites de passage*, Paris, 1909, p. 249 f.

and daughters], Ezk 16²⁰, 21 20²⁶, Mic 6⁷). Frazer considers that behind the Passover rite lies an ancient custom of sacrificing the first-born, mitigated by the custom of redemption, but apt to recur sporadically (*GB*² ii. 43 ff.). There is, however, no real evidence that the later instances of sacrifice of the first-born had any connexion with the Passover rite. Rather were they adopted through imitation of similar Canaanite (probably Phœnician) sacrifices in times of danger and under false notions of what was pleasing to Jahweh (cf. König, *Gesch. der alttest. Rel.*, Gütersloh, 1912, p. 325 f.). The Hebrew customs regarding the first-born are the subject of a separate article. Here we discuss the evidence for the sacrifice of the first-born elsewhere, since upon it the theory of the early Hebrew sacrifices is sometimes based. It should be observed, first of all, that in some instances there is no sacrifice, but mere killing, usually for some superstitious reason associated with a first-born.¹

In New South Wales first-born children are said to have been slain and eaten by the tribe as part of a religious ceremony, but the evidence is weak, and in any case there is no sacrifice (Brough Smyth, *Aborigines of Victoria*, Melbourne, 1878, ii. 311). A similar rite of killing and eating the adult eldest son is reported from Khaimuh, China; but no reason is assigned for it, and it is probably mythical (de Groot, *Rel. System of China*, Leyden, 1892 ff., ii. 679). In S.E. Africa, should a man die in battle and his wife marry again, the first child born after the marriage is slain, otherwise accident or death would befall the man and barrenness the woman. It is called 'child of the assegai' (Macdonald, *Light in Africa*², London, 1890, p. 156). Probably it is regarded as the property of the dead father. In Uganda in many cases the birth of a first child to a chief was awaited with anxiety, because the birth of a boy meant that the father would die. Hence, if a male, it was strangled by the midwife, who then announced that it was born dead, thus ensuring the chief's life (Roscoe, *Baganda*, London, 1911, p. 54).

We next turn to cases where a child born to a woman hitherto barren is devoted to a god for life or occasionally sacrificed to the god. In the latter case the reason is that, by the willing sacrifice of what was granted by the god and what is obviously his, the woman will henceforth be fruitful.

Thus, when an Otchi negress has prayed to a fetish for a child, the child is considered the property of the fetish and is called a 'fetish-child' (Ploss, *Das Kind*², Leipzig, 1884, i. 437). Among the Ewe, when a child has been born as a result of prayers to Agbasia, chief of the Earth-gods, it is dedicated to him and called 'slave of the Earth-gods.' If it is a girl, she is married to the priest's son; a boy must serve the priest till his mother has borne a girl (Spieth, *Die Ewe-Stämme*, Berlin, 1906, p. 448 f.). In Uganda, parents who prayed to the god for children promised to devote them to him if he granted their request. If a girl was born, as soon as she was old enough she was brought to the temple enclosure and lived there as a vestal attendant on the god (Roscoe, 276). Many Hindu women propitiate the deity by vowing that the first-born will serve as a water-carrier in the procession of the Tazia until he comes of age or is of a certain age. Such sons wear the green uniform during Muharram till they attain that age, but return to Hindu usages as soon as Muharram is over (Rose, *JAI* xxxvii. 224). In Central India, barren women vow their first-born to Omkār Mandhātā, and this vow is the first knowledge imparted to the child. This is so impressed upon him that 'years before his death he seems like a man haunted by his destiny' (J. Malcolm, *ap. Crooke*, *PR*², 1896, ii. 169). Among the Syrians a first-born child is vowed to a saint or to a mosque, but is redeemed with an offering (Curtiss, *Prim. Semitic Religion To-day*, London, 1902, pp. 157, 167, 201). In some cases the child was sacrificed. In India a childless woman would vow to offer her first-born at Gangā-Sāgar or some such holy place, in confidence that the offering would secure a numerous family to her. But this was spontaneous and confined to the lower orders, and was condemned by Hindu religion (Wilson, *Essays*, London, 1862, ii. 167). A similar custom, however, is met with in folk-story (see *ERE* iii. 541^a). Among the Kutonaqa the mother prays to the sun: 'I am with child. When it is born I shall offer it to you. Have pity upon us' (Boas, *5th Rep. on N.W. Tribes of Canada* [*Brit. Assoc. Report*, 1889], 52). Here, however, the sacrifice is less in gratitude for fulfilment of a vow than for benefit to the family. Not improbably the child, born of a god's intervention, is dedicated or even sacrificed to him because he is supposed to be its father.

¹ Elsie W. C. Parsons (*The Family*, New York, 1906, p. 49) says that it is sometimes customary to kill the first-born child or children born before the mother has reached a certain age or has been married a stated time. This is sometimes done because of the belief that children of very young mothers are weakly.

The custom of sacrificing or dedicating a child to a divinity after a promise made and the removal of barrenness, must have been a usual one, to judge by a *Märchen* cycle, of which there are a large number of variants, European and Asiatic, *Märchen* incidents usually reflecting what had once been customary (see MacCulloch, *CP*, London, 1905, p. 410 ff.). Cf. also an instance in the *Aitareya Brāhmaṇa* where Harischandra prays to Varuṇa for a son, promising to offer him as a sacrifice. When the child is born, he evades the promise for years, and is finally about to sacrifice a starving Brāhman's son instead, when the latter is miraculously set free.

In another group of instances the sacrifice is perhaps made because the first-born, having a certain sacredness, was the most valuable offering which could be made, the end usually aimed at being benefit to his kinsmen or the propitiation of a deity angry with them (cf. Mic 6⁷). In some cases there may even have been the idea of a thank-offering for the gift of life and health to the kinsmen (cf. Baudissin, *Adonis und Esmun*, Leipzig, 1911, p. 60), or for the gift of fecundity to the parents, as in the sacrifices just considered.

The custom occurred sporadically on the American continent. Among the Salish Indians of British Columbia the first-born was sometimes sacrificed to the sun for health and good fortune to the family (Boas, 46). The Indians of Florida sacrificed their first-born children to the sun or to the chief as child of the sun (Strachey, *Hist. of Trav. into Virginia Britannia*, ed. London, 1849, p. 84; Müller, 58). Among the pre-Inca people of Quito, the sacrifice of the first-born was a regular custom until it was abolished by the last royal dynasty (Müller, 335, 377; Velasco, *Hist. du royaume de Quito* [in Ternaux-Compans, *Voyages*, Paris, 1837-41, xix.], i. 106). Among the Senjero, E. Africa, many families must sacrifice their first-born son, because once, when the seasons were mixed up and fruits would not ripen, the soothsayers advised the king in future to pour forth human blood on a certain pillar (Krapf, *Travels . . . in E. Africa*, London, 1860, p. 69 f., reported at second-hand). The Nairs formerly sacrificed a first-born son to Mātū, the smallpox goddess (Sherring, *Hindu Tribes and Castes*, Calcutta, 1872-81, iii. 66).

In India, first-born or only children were sometimes enclosed in walls or foundations to prevent the building from falling (*PR*² ii. 174; *FLR* iv. [1881] 186)—an example of the wall- or foundation-sacrifice like that perhaps adumbrated in 1 K 16²⁴, 'he laid the foundation thereof in Abiram his first-born.' Among older races the heathen Russians are said to have sacrificed their first-born to the god Perun (Mone, in Frazer, *GB*² ii. 52). Of the human sacrifices to Cromm Cruaich in pagan Ireland, elsewhere exaggerated, the *Dindsenchus* relates that they included 'the firstlings of every issue and the chief scions of every clan' (*RCel* xvi. [1895] 35). Certain branches of the Semites sacrificed their children, either as a regular custom or on occasions of great danger,¹ but it is only sporadically that the first-born is expressly stated to have been the victim. The analogy of Mic 6⁷ and Ezk 20²⁶ has, however, suggested that the first-born was the usual victim, being at once the most sacred, the dearest, and perhaps the most difficult to part with, and therefore most calculated to appease an angry god. Among the Phœnicians and their colonists the Carthaginians, child sacrifice was so common as to excite horror in the Greeks. Porphyry says they sacrificed one of their dearest (probably the first-born) to Baal (*de Abst.* ii. 56). Philo of Byblus (frag. ii. 24) relates that the native Phœnician Kronos once in time of danger offered his only-begotten son in sacrifice. Kronos is here euhemerized into a king, but the evidence is none the less valid. Of Meshah, king of Moab, it is said that in face of defeat he offered his eldest son as a burnt-offering on the wall (2 K 3²⁷).

Sayce (*TSBA* iv. [1875] 29, *Rel. of Anc. Egypt and Bab.*, Edinburgh, 1902, p. 467 f.) claims that a certain text proves that the first-born was sacrificed for the life of the father. But his translation has been controverted (Ball, *PSBA* xiv. [1892] 149; R. C. Thompson, *Semitic Magic*, pp. 210, 224), and it does not appear to refer to human sacrifice. There is no certain evidence

¹ See the evidence in *GB*² ii. 43 f.; Münter, *Religion der Karthager*², Copenhagen, 1821, p. 17 ff.; W. R. Smith², 1894, p. 362 f. note; 2 K 17³¹ [Sepharvites], 2 K 3²⁷ [Moab], Lv 18²¹, 24, Dt 12³¹, 189^t, Ps 106³⁸ [Canaanites]; cf. also *ERE* i. 391^a, iii. 187^a.

for human sacrifice (*q.v.*) among the Babylonians and Assyrians. The Sepharvaim of 2 K 17²⁴, 31 is now seen to be not Sippar in Bab., but probably a Syrian town.

While the sacrifice of children is an ominously wide-spread custom, it cannot be said that the first-born were the only victims offered, and it is only occasionally that this is stated to have been the case. Inference may suggest it in other instances, but we can deal only with actual facts.

The sacrifice or slaying of the first-born may, in some instances (certainly not in all), be explained by a prevailing theory that the father is re-born in the son, and presumably therefore should cease to live. He would then slay his first-born to save himself. This re-birth idea is most clearly expressed in Hindu belief: 'The husband, after conception by his wife, becomes an embryo and is born again of her' (Manu, ix. 13 [SBE xxv. 829], cf. SBE xxx. [1892] 211). This resembles the Egyptian belief that the son of a god is his image, and will take his place when he dies. For American Indian and Australian instances, see Powers, 'Tribes of California,' *Contrib. to N. Am. Ethnol.*, Washington, 1877, iii. 299; Howitt, *Nat. Tr. of S.E. Aust.*, London, 1904, p. 255. For a similar ancient Celtic belief embodied in the mythic Óchulainn, 'his rebirth would be of himself,' see E. Hull, *Cuchullin Saga*, London, 1898, p. 60. These beliefs have led to the suggestion that the first-born son might be thought to endanger his father's life, and hence should be put to death (Westermarck, *MI* i. 459; Hartland, *Primitive Paternity*, London 1910, i. 196 f.). This is supported by the fact that in some cases it is thought that, if the father's name were given to the son, the father would die, name and person being identical. The instances from S.E. Africa and Uganda cited above might also support the theory, though a belief in re-incarnation is not connected with them. Other cases seem also to support it: e.g., among the Fulani of Hausaland the first-born lives with his mother's people till his father dies, and is called his 'father's shame' (*kunya*) (Frazer, *Totemism and Exogamy*, 1910, ii. 602). In some parts of India the father, being re-born in his son, is supposed to die at his birth, and funeral rites are performed in the 5th month of the mother's pregnancy (Rose, *FL* xiii. 278 f.).

4. Right of succession of the first-born: primogeniture.—Among peoples with whom descent is counted through females, property is not inherited by the sons, but as a rule by the father's brothers or his sister's sons. Yet even here the natural superiority of the eldest is seen in the frequent practice of making him the sole or principal heir (eldest brother or eldest son of eldest sister) (Ellis, *Tshi-speaking Peoples*, London, 1887, p. 298; M. H. Kingsley, *W. Afr. Studies*, do. 1897, p. 485 f.; Bosman, in Pinkerton, 1808-14, xvi. 421 [Guinea]; Proyard, in Pinkerton, xvi. 591 [Loango]; MacLennan, *Prim. Marriage*, London, 1865, p. 188 [Nairs], *ib.* 293 f. [Tibet]; Steinmetz, *Rechtsverhältnisse*, 413 [Nissan Islands]). But in patriarchal societies there is also a tendency, at all events at lower levels, to recognize the superior position of the eldest son. Frequently, it is true, there is an equal division of the property, yet even here there may be certain domestic religious duties adhering to the eldest son, or the succession to chiefship and the like may be vested in the first-born. There remain a large number of cases in which the first-born receives the whole of the estate or property, or the largest share of it, or the immoveable part of it, or certain things which are regarded as of supreme importance. The following references give examples of the first three cases from the lower culture:

Greenland (Cranz, *Hist. of Greenland*, London, 1820, i. 176); Ossetes of Caucasus (Erckert, *Der Kaukasus*, Leipzig, 1887, p. 116); Kumis (Kohler, *ZVRW* ix. [1890] 336); Kukis (Soppitt, *Short Account of Kuki-Lushai Tribes*, Shillong, 1887, p. 16); Kandhs (Macpherson, *Mem. of Service in India*, London, 1865, p. 62); many tribes in Deccan (Kohler, *ZVRW* viii. [1889] 131); Rajputs (*ib.* 102); Igorrot (Jenks, *Bontoc-Igorot*, Manila, 1905, p. 165); Bataks (Fryer, *Khyeng People of Sandoway Dist.*, Calcutta, 1875, ii. 147); Ogan-Ulu and Komerung-Ulu (Post, *Grundriss der eth. Jurisprudenz*, i. 217); Nias (*ib.* 221); Tonga (Mariner, *Natives of Tonga Islands*, London, 1818, i. 84, 91); Kingsmill Islands (Wilkes, *U.S. Explor. Exped.*, New York, 1851, p. 556); Bogos (Munzinger, *Die Sitten und das Recht der Bogos*, Winterthur, 1859, pp. 69, 73 f.); Masai (Johnston, *Uganda Protect.*, London, 1902, ii. 828; Hollis, *Masai*, Oxford, 1905, p. 809); Nilotic Negroes (Johnston, *ib.* 794); Nandi (Hollis, *Nandi*, Oxford, 1909, p. 78); Gallas (Paulitschke, *Ethnog. Nordost-Afrikas*, Berlin, 1893-6, p. 792); many other African tribes (Post, *Afr. Jurispr.*, Oldenburg, 1887, ii. 12, 13); Wadshagga (Volkens, *Der Kilimandscharo*, Berlin, 1897, p. 253); Bakwiri (Steinmetz, 20); Fida (Bosman, 480); S. African tribes (Mac-

donald, *JAI* xix. [1890] 277; when there is only one wife, the first-born inherits civil and material rights and a proportion of the moveable property); Hottentots (Kolbe, in Walckenaer, *Coll. des relations de voyages*, Paris, 1842, xv. 380; Thunberg, in Pinkerton, xvi. 142).

In a few cases, under polygamy the eldest son of the chief wife is heir, but he need not be the first-born of the children of all the wives. Thus in S. Africa the chief wife's first-born is heir, but the first wife's first-born has a superior claim to sons of subordinate wives (Macdonald, *JAI* xix. 278). But as a rule the first wife is the chief wife in polygamous societies.

Of the fourth method of inheritance, the following are instances. Among the Zuhis the property is equally divided, but the eldest son gets coral, white shell and turquoise necklaces, and ear-rings (23 *RBEW* [1904] 291). In Bengkulen the sons obtain equal parts, but the eldest gets also the house and *pusaka* (Post, i. 220). In Halmahera the plantations are divided among the children, but the eldest son obtains the household furniture (Bastian, *Indonesien*, Berlin, 1884-99, i. 72).

Among higher races, especially in ancient times, an equal share among the sons was generally favoured. This was the case in Egypt, although in noble families the son of the eldest daughter was heir (Wilkinson, *Manners and Customs*, ed. London, 1878, i. 320; Erman, *Life in Anc. Eg.*, Eng. tr., London, 1894, p. 156). In Babylon the Code of Hammurabi shows that the sons shared the estate and the household goods equally (§§ 7, 165), but 'from other evidence it would appear that the eldest brother was entitled to a larger share' (Cook, *Laws of Moses and Code of Hammurabi*, London, 1903, p. 139; Sayce, *Babylonians and Assyrians*, do. 1900, p. 31). Among the Greeks and Romans, though de Coulanges thought he saw traces of primogeniture in earlier times (*La Cité antique*, Paris, 1864), yet in the historic period it did not exist at all, and, in Greece, at least, the sons took an equal share (Petitus, *Leg. Att.*, Lyons, 1738, bk. vi. tit. 6; Maine, *Ancient Law*, London, 1861, p. 227). Primogeniture does not appear to have existed among the Celts of Gaul, and it was unknown in ancient Ireland and Wales (Roget de Belloguet, *Ethnogenie gauloise*, Paris, 1858-75, iii. 398; for the Irish and Welsh systems, see Maine, 240 f.; Cecil, *Primogeniture*, p. 12 f.). Among the Teutons, primogeniture did not exist, except among the Tencteri, with whom the eldest son inherited all but the warhorse, which went to the bravest (*Tac. Germ.* 32).¹ But there was an approach to it in the fact that in the case of the *allod* or *terra salica* (the household property as apart from the communal property), which was the joint-property of the father and sons, the eldest son succeeded to it when his father died, but the brothers might build dwellings upon it, forming a house community. The *allod* was thus not divided as a rule (Maine, 228; Laveleye, *De la Propriété*, Paris, 1874, p. 95). In India, the great object of a man being to have a son who may perform the due funeral rites, the first-born has always been regarded as peculiarly sacred; and after his father's death he was the natural head of the family, while even before it he was manager of the whole patrimony (Manu, ix. 105 [SBE xxv. 346]; cf. FAMILY [Hindu]). The earlier law-books announce that the property should be divided equally—a method insisted on in *Apastamba*, ii. 6, 14 ff. (SBE ii. [1897] 133 ff.)²—or that the whole should go to the first-born, while he should support the rest as a father (*Gautama*, xxviii. 1 ff. [SBE ii. 302 ff.]; Manu, ix. 104 f. [*ib.* xxv. 345 f.]). 'The primogeniture of the ancient Hindus was much more a headship than an ownership' (West and Bühler, *Hindu Law of Inheritance*, Bombay, 1884, pp. 69, 737). At the present time there is an equal division in the case of estates held in severalty, but property which is in its nature impartible descends usually by

¹ It has been inferred from this passage that primogeniture obtained among other tribes also (Hearn, *Aryan Household*, London, 1879, p. 80; Schrader, *Reallex. der indogerm. Altertumskunde*, Strassburg, 1901, p. 193). The inference is doubtful.

² Cf. *Gautama*, xxviii. 1 ff. (SBE ii. 302 ff.), 'In partition there is an increase of spiritual merit.'

strict primogeniture (Mayne, *Hindu Law and Usage*¹, Madras, 1906, pp. 731, 733). Maine points out that, 'wherever public office or political power devolves at the decease of the last Incumbent, the succession is nearly universally according to the rules of Primogeniture' (*Anc. Law*, 233). In Muhammadanism all sons inherit equally, but in the case of chiefships the eldest usually succeeds, if he is fit (Hughes, *DI*, London, 1895, p. 129; cf. *LAW* [Muhammadan]). In China, property is divisible among the sons, the eldest becoming trustee of the sacred, inalienable portion. But frequently brothers give him their share for the glory of the house. He also receives the furnace, cooking range, and cooking utensils (Doolittle, *Social Life of the Chinese*, London, 1866, ii. 224; Simon, *La Cité chinoise*², Paris, 1891, p. 39; see below, § 5).

Since neither Greeks, Romans, Teutons, nor Celts had a system of primogeniture in the sense of the eldest son succeeding to property, it is a curious problem why, on the break up of the Roman Empire, this system should have appeared and have spread so rapidly. Maine has traced it to the system of 'benefices' or grants of Roman land given to the invading chiefs on condition of military service. These gradually became hereditary, the rules of succession being various, but ultimately regarding only the eldest son. The reason of this was that, though property had not descended to the eldest son, the administration of family government did, or had recently done so. 'The lord with his vassals, during the ninth and tenth centuries, may be considered as a patriarchal household, recruited, not as in the primitive times, by Adoption, but by Infeudation; and to such a confederacy, succession by Primogeniture was a source of strength and durability.' Meanwhile the lord invested with the inheritance had no advantage over his brethren and kinsfolk in occupations, interests, or indulgences (Maine, 236). But Roman jurisprudence 'looked upon uncontrolled power over property as equivalent to ownership.' Thus the eldest son ultimately became legal proprietor. Probably the sacredness attaching to the eldest son, his position as head of the family who took the father's place in looking after the others, the one who performed the ancestral worship, also all had their place in establishing this new rule of succession, as they had in savage societies where primogeniture ruled. Under feudalism, also, it was better that one person should succeed to the rights and duties of the tenancy (see Pollock and Maitland, *Hist. of English Law*³, Camb. 1898, ii. 274).

The custom of the youngest son inheriting all or some important part (e.g. the homestead) exists as a fossil usage where primogeniture is well established, e.g. in Kent ('Borough-English'), in Armorican Brittany, and Picardy (*Juveigneurie, Mainete*), in Flanders, Alsace, Switzerland, Württemberg, Westphalia, Finland, Esthonia, Livonia, etc., and it is the custom with some savage peoples—Scythians (Herod. iv. 5, 10), N. Chuds, Nāgās of N.E. India, Hos, Mrus of Arawak, Kukis, Khyngs, and some Eskimos. Many explanations of the custom have been offered. Possibly it dates from the time when the matriarchate was giving way to the patriarchate, the youngest son in nomadic societies being chosen as heir because he was nearer his father in time, especially if the elder sons had already swarmed off.¹ In more settled societies the eldest would have the natural pre-eminence. This is suggested by instances where eldest and youngest obtain more than intermediate brothers (Singhpos, Bataks, Hill tribes of Arakan). The custom has given rise to a multitude of *Märchen* in which the youngest son is the hero (see Ernout, 'Du Droit de juveigneurie,' *La France judiciaire*, vii. [1882-3] i. 313; Elton, *Origins of English History*, London, 1882, p. 195 f.; Letourneau, *Property, its Origin and Development*, 313, 325; MacCulloch, *CF*, ch. 13, 'The Clever Youngest Son').

5. Privileges of the first-born.—As soon as the patriarchal form of the family is well established,

¹ Cf. the Zulu belief that the first- and second-born sons should not inherit because 'they are sons of the womb' (Arbousset and Daumas, *Exploratory Tour*, Eng. tr., Capetown, 1846, p. 149).

the natural pre-eminence of the first-born becomes an accepted fact, whether he is made sole or principal heir or not. Hence certain privileges become his. Even among the Arunta, on the death of a parent the eldest son takes charge of the ancestral *churinga*, which must descend in a certain line (Spencer-Gillen^b, 616). Among the Veddas the eldest child takes the leading part in the distribution of the father's property (Seligmann, *The Veddas*, Cambridge, 1911, p. 118). In Polynesia, where the first-born was sacred, no one else was allowed to enter by the door through which he or she entered the paternal dwelling (Gill, *Myths and Songs*, p. 46). Among the Navahos the eldest son comes next to the father in authority and succeeds him as head (Matthews, *JAFI* xii. [1899] 9). The Aleuts hold that the eldest brother should be respected as a father when the latter is dead (Petroff, *Tenth Census of U.S.*, Washington, 1884, p. 155). In China the eldest son has a distinct place apart. The younger sons are expected to obey the elder, and the *Li Ki* refers approvingly to this submission (xxi. 16 [*SBE* xxviii. (1885) 230]). The eldest son of the chief wife, if he predeceased his father, was to be mourned by him as the eldest would mourn the father (de Groot, ii. 509). As worship of the dead father is customary, the eldest son has a leading place in the long funeral ceremonies, and it is he who invites the soul of the father to enter the tablet which will henceforth represent him. This tablet he receives, preserves, and worships, and he also erects tablets in memory of both parents and worships them. None of the younger sons may do this (de Groot, i. 94-212; Doolittle, ii. 224). In India, where the cult of ancestors was a sacred duty, the place of the first-born was one of honour. At his birth the father discharged one of the three debts due to the ancestors, and he obtained immortality when he saw the face of a living son. In him he was born again, and the birth of other sons was of no account (Manu, ix. 106 f. [*SBE* xxv. 346]; *Inst. of Viṣṇu*, xv. 45 [*SBE* vii. (1900) 65]; *Apastamba*, ii. 9. 24 [*ib.* ii. 159 ff.]). At the father's death the first-born pronounced the funeral prayer as a right, because he had come into the world first; he was also domestic priest. Real independence belonged to him alone, and he was to be respected as equal to a father (*Nārada*, i. 31 [*SBE* xxxiii. (1889) 50]; Manu, iv. 184, ix. 108 [*ib.* xxv. 158, 346]). The younger sons must not marry before him, or begin the performance of the *agnihotra* or offer a *śrauta* sacrifice before him. Any precedence of a younger over an elder brother must be expiated in due form (Manu, iii. 154, 171-2, xi. 61 [*SBE* xxv. 104, 108, 442]; *Atharvaveda*, vi. 112 [*ib.* xlii. (1897) 164 f.]; *Baudhāyana*, iv. 6. 7 [*ib.* xiv. (1882) 329]). The Hindu right of primogeniture has already been noticed. In the Mandæan sacred writings it is similarly said that the elder brothers are to be honoured like the father (Brandt, *Mand. Schriften*, Göttingen, 1893, p. 64).

6. Thus in most parts of the world there is evidence of the superiority and sacredness ascribed to the first-born, whether this results in honours, privileges, or actual primogeniture, while it has hedged him about with a variety of curious customs, and has even led, on occasion, to his being sacrificed as the nearest and dearest on behalf of his family or of a yet unborn progeny. See also INHERITANCE.

LITERATURE.—E. Cecil, *Primogeniture*, London, 1895; J. G. Frazer, *GB*, do. 1900, ii. 43 ff.; E. Gans, *Das Erbrecht in weltgeschichtl. Entwicklung*, Berlin, 1824-35; C. Letourneau, *Property, its Origin and Development*, Eng. tr., London, 1892; H. Maine, *Ancient Law*, do. 1861 [⁶1876]; A. H. Post, *Grundriss der ethnol. Jurisprudenz*, Oldenburg and Leipzig, 1894; W. R. Smith, *Rel. Sem.*², London, 1894; R. Campbell Thompson, *Semitic Magic*, do. 1908, ch. 5; E. Westermarck, *MI*, do. 1906-08. See also the other authorities cited throughout the article

J. A. MACCULLOCH.

FIRST-BORN (Hebrew).—The term *b'khôr* (בְּכוֹרִי), which is applied to the first-born of men and the firstlings of cattle, is from the same root as *bikkûrîm* (בִּכּוּרִים), 'firstfruits' (*g.v.*), and *bikkûrâh* (בִּכּוּרָה), 'the early fig.' The technical phrase *kol pēter rehem* (כָּל פֶּטֶר רֶחֶם), 'all that opens the womb,' is also applied to man and beast (Ex 13^{12, 15} 34¹⁹, Nu 18¹⁵, Ezk 20²⁶), standing sometimes in opposition to *בְּכוֹר* (Ex 13², Nu 3¹²). *Ršhîth* (רִשְׁוֹנָה), the first and best (LXX ἀπαρχή), is commonly limited to fruit and grain, but occasionally used of the first-born male (Gn 49³, Dt 21¹⁷). The *b'khôrâh*, or right of the first-born, entitled the eldest son to privileges of which he was not to be dispossessed. He received a double portion of the patrimony (Dt 21¹⁷). It was, indeed, always in the father's power to take the birthright from the first-born and bestow it upon a younger son (Gn 49⁴, 1 Ch 5¹, 1 K 11¹⁻¹³), but custom did not approve of the passing by of the eldest son, and the Deuteronomist seeks to guard against the abuse of the paternal prerogative, enjoining that the first-born of a 'hated' wife is not to be disinherited in the interests of the later-born son of a favourite (Dt 21¹⁵⁻¹⁷). To despise and barter one's birthright, as Esau did (Gn 25²⁹⁻³⁴), or to be deprived of it for misconduct, like Reuben (1 Ch 5¹), was a deep disgrace. 'First-born' became an honourable title conferred upon Israel (Ex 4²²) and Ephraim (Jer 31⁹). The Jews interpreted 'first-born' in Ps 89²⁷ as a designation of the Messiah, and *πρωτότοκος*, the LXX equivalent of *בְּכוֹרִי*, is applied to Christ in Ro 8²⁹, Col 1¹⁵, He 1⁶. See, further, art. INHERITANCE (Heb.), and cf. the preceding article.

The law regarding the dedication of the first-born of men and animals to Jahweh varies greatly in successive ages. (i.) The Jahwist and Elohist preserve the primitive usage. While the shepherd Abel brings an offering 'of the firstlings of his flock, namely of their fat-pieces' (Gn 4⁴ [J]), Cain's gift is analogous to the firstfruits of Hebrew ritual. The greater acceptability of the former offering probably reflects the view prevalent in the early days of the settlement of Israel in Canaan, when the animal sacrifices of the nomadic religion were still regarded as superior to the vegetable offerings to the Canaanite *ba'als* (Skinner, 'Genesis,' ICC, 1910, p. 106). In Ex 13¹² and 34^{19c} (both J), it is enacted that the first-born males are to be Jahweh's. The first-born among men are to be redeemed: the redemption price is not fixed, and probably it varied with the position and circumstances of the individual. The firstling of an ass, as an unclean animal (originally tabu), is either to be redeemed with a lamb or else to have its neck broken, *i.e.* to be killed without the shedding of blood. The other firstlings are to be sacrificed. The *Book of the Covenant* provides that the firstling of a cow or sheep is to be offered to Jahweh on the eighth day after birth (Ex 22³⁰ [E]). The law implies that an altar was everywhere near at hand at which the sacrifice could be made. It would have been wholly impracticable to undertake a journey to a distant central sanctuary every time a firstling was born. (ii.) According to Dt 15^{19c}, all first-born males of the herd and the flock, if free from blemish, are sacred to Jahweh. The command not to do any work with the firstling of cattle or to shear the firstling of the flock (*v. 19b*) indicates that the animal need not be offered (as in JE) on the eighth day. It is set apart for a sacrificial meal at the central place of worship, which is now the only legitimate shrine. The flesh of the firstlings is to be eaten by the owner and his household, the priest, of course, receiving his usual share. The dedication is still an offering in the strict sense, not the mere payment of a tribute to the priest. (iii.) In the *Priestly*

Code there is an entirely different disposition of the firstlings (Nu 18¹⁵⁻¹⁸, Lv 27²⁷). The redemption price of first-born sons is now definitely fixed at five shekels a head. The flesh of the animal victim no longer belongs to the owner and his family, but is a perquisite of the priest. Offerings have been transmuted into taxes. While Ezekiel demands for the priest 'the first of all the firstlings of everything' (44³⁰), P claims not merely a portion but the whole of the firstlings of all clean beasts; and the firstling of an unclean animal, if it is not sold for the benefit of the sanctuary, is to be valued, and redeemed at a fifth more than its valuation (Lv 27²⁷). These laws evidently regulate the procedure of a later period.

The origin of the practice of dedicating the first-born can only be conjectured, and the significance of the rite naturally changed with the changing conceptions of the Deity. Benzinger (*EBi*, 3594) thinks it 'probable that the custom of offering the firstlings was only a secondary extension of the practice of offering the fruits of the field,' in which case the custom did not exist before the immigration of Israel into Palestine. But it was probably more primitive. Among the ancient Semites, according to the theory of W. R. Smith (*Rel. Sem.*, 1894, pp. 463-5), while all domestic animals had a certain intrinsic holiness, the first-born were holy in an intensified degree. Their supernatural qualities or associations made it unsafe to use them for common purposes. There was originally no thought of offering a gift or tribute to the Deity; the firstlings were sacrificed, and eaten for the purpose of strengthening the bond of kinship between Him and His commensals (see SACRIFICE). Similarly it is surmised that 'all the prerogatives of the firstborn among Semitic peoples are prerogatives of sanctity; the sacred blood of the kin flows purest and strongest in him' (W. R. Smith, *ib.*).

After the settlement in Canaan, when Jahweh came to be regarded as the *ba'al*, or lord of the land, and the old idea of holiness as a tabu became unintelligible, the firstlings of animals were offered as 'the expression of thankfulness to the Deity for fruitful flocks and herds' (Wellhausen, *Hist. of Israel*, Eng. tr., Edinb. 1885, p. 88), perhaps with the added idea of sanctifying all subsequent births from the same animal (Dillmann, *Ex. und Lev.*, Leipzig, 1897, p. 139). Philo describes the firstlings offered to God as 'thank-offerings for fruitfulness whether already enjoyed or expected' (*de Præmiis Sacerd.* [Mangey, ii. 233]).

The claim of the first-born sons for Jahweh (Ex 13¹³ 22²⁹ 34²⁰) has a history which is somewhat difficult to trace. Wellhausen (*Hist.* 88) regards it as 'merely a later generalisation which, after all, resolves itself merely into a substitution of an animal offering and an extension of the original sacrifice.' It may, however, go farther back, and be rooted in the primitive conception of the sacredness of all animals. It is difficult to believe that the law, 'the first-born of thy sons shalt thou give unto me' (Ex 22^{29b}), is unrelated to the ancient Semitic practice. It is certain, on the one hand, that human sacrifice was always repugnant to Jahwism, the distinctive religion of Israel, and that the prophets were right in denouncing it as a mere heathenish horror. But, on the other hand, it is unquestionably the custom among many uncivilized peoples to sacrifice and eat the first-born (Frazer, *GB*², 1900, ii. 51 ff.); the practice not improbably existed among the Hebrews before their separation from the common Semitic stock;¹ the numerous skeletons of jar-buried infants

¹ This does not imply that at one time the Hebrews sacrificed all their first-born sons, but only that, if sacrifice was to be made, the first-born were 'the best and fittest, because the holiest, victims' (*Rel. Sem.*² 465).

recently found in Palestine indicate that the old Canaanites were in the habit of sacrificing their children, perhaps their first-born (Driver, *Schweich Lectures*, London, 1909, p. 68; Marti, *Rel. of the OT*, London, 1907, p. 84); and in the last days of the Hebrew monarchy, when ordinary means seemed too weak to appease the Divine wrath, recourse was had to the sacrifice of first-born sons (Mic 6⁷). In the injunction, 'thou shalt set apart unto Jahweh all that openeth the womb' (Ex 13¹²), the verb (קָדַשׁ) is the term regularly used of devoting (*causing to pass over*) children by fire (2 K 16⁸ 17¹⁷ 21⁶ 23¹⁰ *et al.*), and in reference to human sacrifice Ezekiel (20²⁶) uses the words 'in that they caused to pass over (EV 'caused to pass through the fire') all that openeth the womb.' The Hebrew law, based on prophetic teaching, thus seems to stand in pointed contrast with the old Semitic practice, to which the nation, in imitation of the Phœnician or Canaanitish ritual, was faithlessly reverting. The same antithesis is skilfully embodied in the story of the offering of Isaac, where an animal sacrifice is accepted in lieu of a human. 'As often happens in the history of religion, there is a "substitute" for an old practice which has now become impossible, while in theory the old still remains valid' (Gunkel, *Genesis*, 1901, p. 220). While the Israelites devoted their first-born as truly as any of their heathen neighbours (*e.g.* Mesha, king of Moab, 2 K 3²⁷), how much more reasonable and spiritual their service ultimately became! When the historical origin of the practice was forgotten, or seemed no longer credible, 'a theological explanation' (Driver, *Exodus*, Camb. 1911, p. liv) was found in the thought that it was because Jahweh slew all the first-born of the land of Egypt (Ex 13¹⁵ [J]). In the *Priestly Code* this theory is complicated by another pragmatic section, to the effect that the Levites were taken by God in lieu of the first-born of all the tribes (Nu 3¹¹⁻¹³). It was the view of later Judaism (Targ. on Ex 24⁵; Mish. *Zebah*. xiv. 4) that the dedication was for the Temple-service, but this was a wide divergence from the ancient idea.

LITERATURE.—In addition to the authorities cited in the text, see artt. 'Familie u. Ehe bei den Hebräern' (by Benzinger) in *PRE³* v. 738; 'Erstgeburt,' in Winer, Schenkel, and Riehm; W. Nowack and I. Benzinger, *Heb. Archäologie*, Freiburg i. B., 1894.

JAMES STRAHAN.

FIRST CAUSE.—Every real entity is a cause, and every entity—the First Cause alone excepted—is also an effect. It is with the conception of *efficient* cause that we are here concerned, and that conception implies an Agent which is the possessor or the vehicle of force, activity, or power. The efficient cause is outside of the effect, while it really contributes to its production. Indeed, to make a thing or effect *actual* is the very end and function of an efficient cause. Philosophically to define *cause* is a matter of proverbial difficulty, but the best idea is probably that of *producing*, wherein something real passes from the efficient cause into the entity of the effect. Indeed, the cause passes into the effect, which stands over against it; this, in virtue of the causal relation being one in which the same fact appears, now as cause, and now as effect. The existence of the causal link is a fact we perceive, and yet it does not admit of demonstration. Therein lies the trouble; it is seen by reflexion rather than established by argument. To ask for proof of a first principle is absurd. Minds so different as those of Kant and Herbert Spencer have taken causality to be such a principle. The causal concept becomes doubly difficult when the efficient causality has relation to spiritual beings, the First Cause being thus the supremely difficult instance. Active power or force is presupposed in the cause, so that

the cause is independent of the effect, and, *qua* cause, is prior to it in respect of nature. It does not follow from this that causality need be successive in *time*, for cause and effect may be synchronous. The cause is but the logical *prius* of the effect. To describe the precise nature of the causal influx is quite another thing from affirming the evident fact. The effects of causation are continually present in our own experience, and the need spontaneously arises to postulate some adequate Source or Ground of ourselves and the world. We are dealing with the metaphysical idea of cause, not with the scientific tendency to treat causes as mere antecedents. All science is based on the belief in invariable and orderly sequence. Real causes are unknown to science, which, in reality, deals only with *occasions*; causations are to science only transformations. It is, however, no impeachment of the causal principle that it has thus no place in the scientific realm, for efficiency preserves its validity and worth in its own proper, non-phenomenal sphere. In the phenomenal sphere, a First Cause would be inconceivable, no interruption of the sequence of equivalent changes being admissible. Scientific method, then, excludes all notion of a First Cause. If the intuition of causation seems to demand the postulation of a First Cause, the exigencies of science can meet this demand only by breaking away from its own method, which is confined to changes caused by forms of energy previously existent. With the scientific centres of such forms of force and energy, lying open to observation and experience, we have here nothing to do, save only in that important respect whereby the cosmical result to which they unitedly give rise is one which demands another and deeper kind of cause than any known to strict scientific method. That truer—and, indeed, only real—conception of cause is will. That deeper cause, as the cause of all inferior or secondary causes, is the First Cause, to which, by the need for self-subsistent being or principle, we are ultimately, but nowise arbitrarily, driven. God, as the First Cause, is the Ground and Cause of all secondary beings or causes, without whom these could not subsist or be. God is the First Cause, all things craving His immediate causality. The quest for such First Cause is, we have seen, but an application to the world *in toto*, as a unity, of the law of causation. But the cause of the universe, as actually existing, can, *qua* cause, by no possibility exceed or transcend the effect—the universe itself. Because the effect so measures the cause, the universe as an effect cannot, in its finitude, yield us the First Cause. Hence the chief defect in the presentation of the First Cause argument, especially in the hands of British and American philosophers and theologians, has been the frequent and persistent tendency to rest in what could be inferred from the law of causation as applied to the phenomena of the universe, and the failure to pass from the dependent or contingent character of these phenomena to the postulation of an Absolute Ground. The argument is really drawn, as Leibniz properly divined, from the contingency of the world, which reveals, in its dependence, a Primal Power, or Cause, on which it so depends. If the First Cause were finite, there would then be an Infinite Uncaused beyond it. Belief in a First Cause rests on no foundation of authority, but is a necessity of thought, in view of the world's contingency.

It is an inaccurate mode of speaking to say that God is the cause of Himself. God is His own sufficient reason, and all that we can say is that He is self-existent.

The First Cause argument is, properly, not an

inference from effect to cause—since this would never take us beyond the really finite—but from effect to ground. But, in the favourite form of seeking a First Cause, the argument has taken a Deistic character, with the need of showing that the world had a beginning, and the result of leaving the Divine relation one of pure transcendence. The issue for Theism could be only very partial and incomplete. The attempt in this connexion to think an absolute beginning, or First Cause of all things, was a futile or impossible one, and was strangely unperceived to be so. In the long chain or process of cause and effect, the First Cause was antecedent to the process, without its being perceived that thus it really stood outside the process, and that the leap to it was illegitimate. In other forms of the argument, such as from the contingent to the necessary, or from the finite to the infinite, we do not escape the necessity of a leap at last, for the conclusion is infinite, which the data never can be. But the appeal may here be deeper—to the necessities of thought or reason.

There must be a sufficient reason for every existing thing, and for the universe as a whole. Such reason our argument seeks. Everything is, in its turn, conditioned by something else, and is made what it is by its relations to other things. The number of its relations is indefinite, and the complete rationality of such relations, as a system, is past finding out. While an underlying *nexus* of force makes everything also causal in its turn, yet there is no trace of existence, independent and non-conditioned. We know limitation as surely as we know being. Parts of existential phenomena, everywhere throughout the universe, depend upon other parts not less dependent in their turn. Not a single causal agency known to science bears the stamp or mark of self-subsistence, and the same thing is true of our personal and finite existences. No aggregation of such finite agencies and existences can possibly make an independent and unconditioned universe. Clearly, a universe so finite and dependent must have its Cause or Ground beyond itself. As a whole, it must have an independent, self-existent Cause, as the necessary correlate of its finitude. Even by those who take the creation of matter to be eternal, such a World-Ground is felt to be necessary. For even then—and the same holds true if the world be but one of an endless series of universes—an eternal and unitary Ground and Cause is needful as explanation of the vast successions of phenomenal changes and dynamic activities that make up the universe. Yes, needful as explanation of their persistence, no less than of their production. Clearly, an adequate cause is required for the world's being eternal rather than of time. The eternity of the world is not synonymous with its necessity. Matter may very well be the eternal effect of an eternally producing Cause. Even if matter be taken as eternal, the question still remains whether it has in itself—or from without—the principle of its existence. The Cause or Ground is, in such a case, related to no past creative activity, but is claimed as the centre and soul of present cosmic reality. What, however, does exclude anything of the nature of real effective causation is a merely pantheistic evolution. What theistic philosophy does postulate is that, in respect of all causational effects whatsoever, the First Cause was free in His self-action; that His activity in the use of causal power had no need to be eternal, however the power of such causative action might be eternal.

The more assured conclusions and better established theories of science alike point to the finitude and dependence of the universe. But, if we assumed no First Cause as the Source of trans-

forming causal energy to the world, science itself would be reduced to illusion. For no link in the infinite chain of secondary causes would then originate but only transmit causality, and yet there would—the First Cause being wanting—be no causality to transmit. To deny a First Cause would be to deny all secondary causes and the reign of causation within the sphere of experience. The need for a First Cause, in the sense of a self-moved Mover, has been felt from Plato to Hegel and Martineau, and may, for all practical purposes, be taken as universally admitted. But the need is even more pressing for a First Cause which is the present Ground and Cause of the whole concatenation of causes now at work in the ordered universe. Underlying all that has been advanced is the principle that what does not exist as of absolute necessity is merely contingent, else there would be a violation of the principle of causality, and we should have existence without cause. The same violation would likewise result if the cause were not adequate or proportionate. It may be here observed that the argument, taken in the customary form as being from effect to cause, can infer existence of the First Cause only in so far as it is a cause; for the world, as an effect finite and conditioned, could never give a cause infinite and absolute. An efficient cause may conceivably exist, as being or entity, without any effect. It would not then, of course, be the First Efficient Cause, since nothing had been caused or created, but would be the absolutely necessary Being. The weakness of the argument to a First Cause, in the customary form of inferring it from effect to cause, is lack of some clear and valid explication of the sense in which an extra-mundane Power can be a cause. For the usual presentation makes the world, as created by the First Cause, something separate from, and outside of, the Creator. But, if outside of Him, then He is finite. And, if the First Cause and the caused world be not so separated, then there is pantheism. We are not, therefore, driven, as Royce and others, to make the Creator or First Cause 'identical with His products.' Why this inability to grasp the really inspiring truth that Deity transcends His own works—as we transcend ours—while He immanently lives in them? The weakness in the whole case is escaped only by allowing the principle of causation, in its quest for an ultimate, to rest in an Absolute World-Ground. Otherwise, the principle of causation, taken strictly as such, can never conduct us from the world to God. For the argument therefrom is clearly one from the world as the physical effect to a cause as the physical correlative. But the whole force and value of the argument to a First Cause lie in another direction—in an ascent from the swift successions and changeable phenomena of Nature *in toto* to an ultimate and self-existent Ground and Cause, in which these all find possibility, reality, and permanent base or support. Strictly taken, our principle—that of Causality—does not undertake any categorical affirmation as to existence, either of its subject or of its predicate. It is content to affirm, conditionally, that, if contingent being exists, its Efficient Cause must exist. But, inasmuch as the world is taken to exist as contingent being, it proceeds to set forth its argument for the world's necessary and sufficient First Cause. So doing, it seeks not a mere foundation of Being in the abstract, but a real, actually existing, primitive Ground (*Urgrund*) of all reality. It could not possibly find satisfaction in any form of First Cause whose relations to the world should be mainly antecedent to the world, or, for the most part, separate from it. It seeks, through all sequence and dependence of phenomena, some

continuous and persistent dialectical core of being, and rests not till it finds it in the *ens realissimum*—the Absolute Life.

No attempt will be made within the limits of the present article to deal with the subject in its historic developments. It must suffice to point out that modern metaphysical thought has moved far from the position of being content with any First Cause conceptions that treated God as a mere supernumerary spectator of the world-machine's operations, instead of the present and ultimate Ground of all things.

The all-destroying Kant is chiefly responsible for the depreciatory views of the First Cause conception. For he gave men to understand that the causal principle could not carry us beyond the sphere of sensuous experience, and that a First Cause was reached only by a final and unwarrantable leap from the last link in the infinite chain of intermediate causes. It ought to have grown much more evident than it has done how weak the Kantian procedure is, for the essential point in the argument to a First Cause is that the whole chain of causes, and every single link in the chain, are contingent, and depend on self-existent Being or Cause without and beyond them—this, though the First Cause is immanent, while thus transcendent. The creative process is not only conditioned by God, but is in Him; yet He, as the Absolute, Unconditioned Reality and Ultimate Cause of all things, is more than the universe, and for ever transcends it. For transcendence in Deity is just what the First Cause argument, in its true form, gives: it is a recognition that Deity, on whom the world depends, is more and greater than the universe. Absolute as may be the Deity's knowledge of the world He has called into being, what good reason can be suggested why He should not yet distinguish Himself from the world He so perfectly knows? The transition from the world as, *in toto*, a known effect to a World-Ground as its First Cause is a rational and necessary one. This persistent demand of rational thought for an adequate Cause of the world's phenomena has not been at all invalidated by Kant's criticism, which was sharp but not deep. The mind's quest for Primary and Ultimate Cause is satisfied only by the postulation of God as the First Cause, or present and perpetual Ground, of all things finite, in their dependence and contingency. Of course, the postulation of such a Ground or Cause depends on the compelling power or assent of Reason, but what we necessarily think we cannot but accept as true. It is this necessitated thought, or inherent necessity of reason, that gives the argument its cogency, carrying actuality in its bosom, Kant notwithstanding. By such necessary truths—truths of reason—do we live: originating, as they do, in the subject and not in the object of experience, the objects of experience must conform to them, or existence is no longer rational, and the universe no more determined by universal reason. Such truths of reason are part of our nature, axioms that cannot be resisted; they are such grounds and supports of our thought as make them the criterion of truth. Of course, a necessity of thought does not mean a necessity of existence, but the refusal of such a necessity of thought as we have here remains absolute and irrational scepticism. Such a causal judgment carries for us, necessarily, objective validity because of the inconceivability of the opposite; wherefore the judgment is affirmed because we can do no other in the interests of what we feel to be the truth. Even Kant himself does not pretend to find a full explanation of phenomena in natural causality: he says: 'Phenomena must have their grounds in that which is not a phenomenon' (*Kritik d. reinen Vernunft*, ed. Harten-

stein, Leipzig, 1853, p. 400). Precisely; but Kant falters and fails to take that further step towards Reality or Ground beyond experience; the Reality is there, but he thinks it not theoretically knowable by us. 'The causality of the necessary cause of the changes, and *therefore also the Cause itself* [italics ours], must belong to time, and to phenomena in time' (*ib.* 348). So says Kant, and beyond this craving for a positive explanation he does not rise. Such an application, however, of the idea of causality, in reference to the Supreme Cause or Primal Ground, as we have ourselves now made may be taken as *a priori* inherent in mind, and the conviction arising from what is a necessity of our rational nature is one which, it may be remarked, becomes greatly heightened when the essential element of the ontological argument is allowed to mingle and fuse with the cosmological principle. In this way the stock objection—to which Goethe gave classic utterance—as to the First Cause acting upon the world as on a thing external loses point and relevancy.

More recently, the positions of Mansel and Hamilton, and, still more, the attitude of Herbert Spencer, as to the Unknowable, have tended to the same depreciatory result. It is pertinent to observe that Spencer's treatment of the Absolute Force, as the 'Unknown Cause' of all phenomenal manifestations, has deepened the impression that a First Cause cannot be reached or known. But the First Cause is not a product yielded by those causal antecedents which are all the Spencerian philosophy can give us; it is the deeper product arising from the intuition of cause in the mind. The concepts of cause and effect by no means arise, in Humian fashion, by way of mere empirical observation, even though it be in experience that, through the data of perception, we come to fashion the concept of cause; they much more arise, like other fundamental concepts, through abstraction of the understanding, which abstracts from the sensuous. The *a priori* character of the causal principle is not doubtful. If we compare the concepts cause and effect, in our thought, we conclude that every effect presupposes a cause; and the very analysis of these concepts conducts us to the principle of causality. This, recognized as an *a priori* analytic principle, is objectively real, like other *a priori* principles, and is fitly conditioned in its rise by experience, in connexion with the abstracting power of thought. The inner *nexus* between cause and effect is not something which our subjectivity transfers to them, but is something objectively existent before our thought and independently of it. Hence the causal connexion early came to be taken as a dynamic one, even though human knowledge does not yet understand the working of the forces involved. This reality of cause, as of force and every other form of power, Spencer explicitly affirms, but not in any real objective sense, only as subjective affection in its ultimate expression. That is to say, there *is* cause, but as to what it is we are completely in the dark. States of consciousness, produced by the inscrutable cause, are all we know. There is still room for what is true and needful in the principle enforced by Hume and Kant, namely, that the real connexion between cause and effect is determinable only through experience, that is, in empiric and synthetic fashion by means of the events of uniform sequence; but a truer and larger place must be found, in connexion therewith, for the working of thought, which, though not independent of the perceptive elements, yields to experience a necessary connexion of effect with cause which experience could not itself offer. In regarding this necessary connexion of cause and effect as an essential feature of their relation—that is, in recognizing the relation as one of real depend-

ence—Kant and Schopenhauer must be allowed to have shown deeper insight than Hume and Mill. Spencer is himself obliged to admit that our conception of the 'Unknown Power' is fashioned after that of our own mind's causal activity. The efficient power presupposed in the Cause of all phenomena becomes intelligible only as so conceived, and absoluteness can be rationally attributed only to a First Cause which is absolute *existence*, not, Spencer-wise, to unknown *force*. Spencer's position in relation to the First Cause is far from self-consistent; for, admitting causation in Nature, he yet assumes absolute power or force for which there is no antecedent cause, although he has himself said that to admit anything uncaused is to take away the need to assume a cause for anything. In speaking of the Absolute Force as unknowable, Spencer fails to perceive that an existent cannot even be thought as unknowable, unless it is either known or continuous with the known. Thus the existent, being something for knowledge, cannot be unknowable existence. The nature of knowledge saves real existence from being unknowable. Spencer's First Cause is an 'Incomprehensible Power,' of which he will not allow us to know anything; but, if such Power must be taken as the First Efficient Cause, it can be no other than a Supreme Mind or Intelligence, since that of which it is the First Cause is a cosmos—not blind and brute chaos. Mind in experience always goes before matter or mechanism, building up our knowledge of the latter. It is unthinkable that anything save Supreme Mind should, as First Cause, precede the world's vast and interminable mechanism.

Certain of the more extreme forms of Idealism expressly disown the idea of First Cause. Because first causes in the world of experience seem to them an illusive quest, God is dispensed from being the First Cause of the world of appearances in any real sense, and the mind is turned from seeking any First Cause of the causes and phenomena of experience. God is, to such forms of Neo-Hegelianism, the only metaphysical principle or cause, and anything like real or distinct causality is denied to individual men. Causation is for such forms of thought, according to Royce, 'a very subordinate idea in philosophy'; and this, apparently, despite all it has been for the history of philosophy (J. Royce, *The Religious Aspect of Philosophy*, Boston, 1885, p. 477). Now, one may very well be idealist enough to maintain the world to be, in the end, a mental construction, but it is quite another thing 'when causal explanation is dropped,' and we are not allowed to hold the world of reality to be such an active and honest world as is involved in its causal determination of our discriminating and constructive consciousness. To divest the Divine mind of all causality, and to throw it, in Royce's fashion, merely upon perfect correspondence of its consciousness with things as they are, is to exhibit it as a monstrosity of reason, and a paralytic in will. The finite is, in Neo-Hegelian thought, taken up organically into the Infinite, and finds, in this undifferentiated unity, not a cause in time, but a ground of all that happens, or is supposed to be 'given.' The real objects of Nature are, on this view, resolved into mere modes of our conscious thinking, and the element of causality or dynamic energy disappears from things and selves. But this whole assertion of identity is so arbitrary and fictitious as to form no solution of the world-problem, the world being a real and concrete system, with mighty causal energies whose efficiency rests at last upon the sole originating or Uncaused Cause. This applies to much that J. H. Stirling wrote of identity as the solution of causality—a too facile, over-confident, and not very satisfactory solution, since it is certainly desirable that we recognize the Cause as

a fact, and a determining fact; that we recognize the effect as a fact—a fact determined; for only mischievous error can be the result of the denial of causes, or of their identification with effects. It must be remembered that the identity principle is not confined to Neo-Hegelian philosophers. But it is an idle postulation, of purely mechanical and abstractionist character, wherever found. An external world is presented to thought for interpretation of its relation to a transcendent First Cause, so far as revealed to, and in, experience. The abstract necessities of reason, as presented in forms of idealism to which thought is the sole reality, can be no substitute for the causal realities of experience in time. Thus, while the inadequacy of the conception of God as the Cause, in the usual form of presentation, is to be acknowledged or maintained, we have still to do with God as the Ground of the world of space and time, within which He is, in this sense, still and always operative.

Certain *scientific* influences also have depreciated the First Cause conception. Scientific monism of a pantheistic and materialistic type thinks to dispense with a First or transcendent Cause, the Absolute being to it identical with the universe. There is, in Haeckel, no lack of acknowledgment of the causal principle, but it is 'mechanical causation' which for him controls the universe. But such mechanical or scientific causation is never the simple and ultimate thing which it is often taken to be. Haeckel himself recognizes the world to be a unified whole, but does not apprehend the need for ultimate or metaphysical explanation of such a world-whole, as something non-phenomenal which underlies the whole field of scientific causation, with its mere antecedence and sequence. Haeckel, however, fancies he has found a sufficient cause for the universe in the law of causality, taken in conjunction with the supreme law of substance. From the monistic side, it is asked why the first principle of movement cannot be found in matter, since matter appears an inexhaustible reservoir of energies. But modern metaphysics has replied that matter not only supplies, but *is*, energy and force; and that such conception of force or energy can be construed only in terms of Will. In the final quest of physics even, an unchanging substantive cause, amid the changes wrought of force, is sought as a real, though unconscious, result of a metaphysical craving. The very place and purpose of the First Cause argument is to combat the position of monistic theories of a purely mechanical sort, and this it does by bringing out the essentially limited, conditioned, and dependent character of the universe as we know it. It is this conditioned character of the universe that makes it an effect. If there is one thing which the most thorough science of the time does, it is to reduce the category of cause to the universal law of conditions, whereby all phenomena are joined together in an order of dependence. It appears to the present writer no longer possible for theology to ignore, as it has so persistently done, those dynamical explanations of the world which, with their increasing tendency to drop the causal element, have found so much favour in the recent history of science. This dynamical account of the universe is still a quasi-metaphysical one, with which the view of First Cause, as here presented, is believed best to agree. What, of course, is most immediately given us in experience is the changeableness of the world and its unsatisfying character, but inferentially we soon reach far beyond this. If it be said that the universe cannot be taken as an effect unless it can be proved to have had a beginning, it is then to be remembered that causal agency can be inferred without the need of being observed, and that a Ground of existence, not a mere *prius* in time, is our real need and quest. The

universe may wear the character of an effect, and, indeed, the increasing knowledge of it by science makes it always more certainly known as an effect. Even its ordered character implies its dependence. Everywhere the forces of the universe seem to make for change, as geology and astronomy remind us. The whole world is seen to be in a state of change; in the world of appearance a mechanical connexion is everywhere observable; the self-sufficiency of the world is only apparent, and the cosmos is surely advancing towards a state in which its energy will be transformed into heat, and its life and movement will cease: thought necessarily concludes to a single ultimate Cause, which grounds and regulates the whole world-connexion, imparting to it order, law, and coherence. For there is a law of dynamic continuity running through the whole world of modern science, in virtue of which we see the change from cause to effect to be one of form rather than of substance. No rational foundation for a philosophy of Nature seems possible save with the Being of the Absolute as a primal datum. Not even Spencer got beyond the need of a First Cause as a datum of consciousness, and no scientific hypothesis, however ultimate—whether primal energy or ether—can take us to a beginning of things that is really self-explanatory. There is, in reality, nothing arbitrary in our postulation, for such a First Cause can never properly be reckoned a term among causes that began to be. Indeed, the principle of causality is wrongfully applied only when it is sought to foist it upon a Being which never began to be. This uneffected Cause accounts for all else, is sufficient in itself, and is without relation of effect to anything else.

But one may still ask, as to the ultimate elements whereof things are composed, whether they may not have in themselves sufficient reason for their being and for the law of their combinations. Clearly, thought has no right to overlook that the contingency of the world may very well be—and has been—denied on its noumenal side, not in its phenomenal aspect. Certainly, we are bound to grant force to the agnostic contention that our knowledge of the world is still superficial, and confined to the phenomenal, rather than the noumenal, aspect of things. The insufficient character of the reasons adduced for the contingency of the world may very well be set down to the insufficiency of human knowledge. However matter or the ultimate elements may elude us in their noumenal or substantial aspects, we yet feel drawn, as by a necessity of thought, to postulate a Ground or Cause, of whose existence they are dependent manifestations, that Cause being to us the Ground of the possibility of all things. But, when the contingent and dependent character of the world is taken to be most established, there springs out of that very fact a weakness which, strangely enough, is often overlooked. It is that the stable conclusion to God, as the Absolute Cause, is based upon the unstable or contingent character of the world, which might conceivably be a wholly unreal foundation. The trouble is that thought may sometimes be in danger of finding it easier to conclude, from the world's imperfect character, to the world as unreal and illusory, than to rise to an Absolute Reality that shall be perfect and complete. Yet such an absolutely perfect Reality is the goal of all our thinking—thought's imperious demand—difficult as it may be to harmonize with the facts of our imperfect moral experience.

And, if the world be taken as real, a type of pantheistic thought is possible which may professedly disclaim the need to go beyond the world itself, as its own Evolving Cause. But no such self-evolving world is to be thought of save as the result of Will and Reason, immanent in the evolu-

tionary process, and creative of its unity. Mind must, then, fall back, in a way dependent on the energy of thought and its necessities, on the need to postulate absolute and necessary Being, which, in the presence of the world, with its inert matter and blind energy, must be set in causal relations to it.

Science is finding the unity of Nature suggested by the unities everywhere perceived—unities of process and development, and unities of organization and expression. Do such unities—do evolutionary and molecular theories—suggest nothing of the nature of an effect, nothing of the presupposed Ground and Cause of the whole? Does the sum of scientific knowledge—the observed, and inferred, unity of Nature—not suggest a First Cause, on whose transcendent causal energy the world depends, and by whose power it lives? If such World-Ground or First Cause be God, the effects of His causal power cannot conceivably continue without Him; His presence is after no quantitative mode, but is that of essential causality. It is, of course, not consonant with the ideal of science to seek an extra-mundane Cause, or with the method of science to seek anything save equivalent antecedent phenomena in terms of law. But it is perfectly rational to find the sum of scientific knowledge, with its explanation of the world for ever incomplete, suggest or point to some deeper cause—present to, and in, creation—than any open to the ways and instruments of science. The root difficulty of an evolution, which is simply a conditioned series in time, clearly lies in our claiming any right to attribute absoluteness—absolute initiative—to any particular term in the causal series; and hence rational insight finds itself driven, as we maintain, to ground the causal series in relation to an absolute or transcendent Ground. Without such a single ultimate Cause, which eternally grounds the whole evolutionary process, the entire train or chain of the developmental series must clearly appear as no better than a play of accidents. Thus we leave behind the old difficulty as to Deity working upon a Nature external to Himself—a conception that made the Infinite power finite, both because there was something outside of it, and because its working on the external must be conceived as subject to law or conditions.

On Efficient Cause, science does, and must, remain soundly agnostic. When, to the considerations already offered, is added the fact that science has no manner of solution, from powers or qualities of matter known to it, for free self-conscious beings, a new demand arises for a First Cause that shall be free, intelligent, and self-conscious. For, between the effect and its cause there must be neither inadequacy nor disproportion. So, though the effect not only may, but must, be different from the cause—else there were no causation—yet the Primal Cause must be such as can produce the total universe. Hence we see why the First Principle of all things cannot be, as the monists wish, impersonal. No impersonal cosmic processes can possibly furnish a World-Ground for such a being as man. The First Cause must be at least personal as we are, however much more He may be. This is an inexorable demand of our thought, which absolutely refuses to be content with anything less, as First Cause, than a Being endowed with plenitude of ethical life, intellect, and will. For God is not the First Cause in the ordinary sense of cause, whose relation to effect is properly physical, not ethical, and necessary, not free. In this strict sense, the world is *not* an effect; and no cause, in this sense, can form the *rationale* of the world. More than its First Cause, in this aspect, is God: causality is an element in His relation to the world, but *cause* cannot be the principle of thought respecting One who is its free

Originator, the self-determined action of whose Will is really the ultimate principle of the cosmos. The laws of Reason and of Morality, found in the world, must be accounted for, since neither the universe nor the human mind can be their cause. These laws are of a character so absolute and unconditional that they cannot be conceived otherwise than as true and existing, were there neither universe nor human mind; hence an argument for a First Cause has sometimes been founded on these necessary truths alone. Their cause can be nothing either irrational or non-moral, and so there arises a call for a Rational and Moral Intelligence, distinct from the world and man's mind, in whom they are grounded. The First Cause is First Cause of an ordered and intelligible world, with harmony in its causes in relation to their effects, and that First Cause must be not only the Supreme Intelligence—Universal Mind—but equally the Ground of all things in virtue of its ethical moment. This the best metaphysical thought now fully realizes. The First Cause or Ultimate Ground of all reality must be uncaused, and such Cause or Ground can only be One Eternal Mind or Spirit, by whose will all things are. To such unity of the First Cause we are led by the principle of Parsimony, which would make more than one unphilosophical, and by the unities which mark alike the laws of the universe and the necessary laws of reason. Thus is met the demand of those who, speaking from the scientific side, insist that

'the character of the First Cause cannot be judged from the mode of action of any secondary agencies. One mode of action is as mysterious as another, so far as any relations to a First Cause are concerned. The intelligence of the First Cause can only be judged from the result' (J. P. Cooke, *The Credentials of Science the Warrant of Faith*, London, 1893, p. 252).

While the scientific view must restrict itself to the actual universe, it is yet a thought suggestive and worthy of consideration that the causal principle in the human mind presses on, by inherent impulse, from actual being to that which is possible and conceivable. Thus it has been attempted to found an argument for the First Cause on this aspect alone. In our treatment, however, the stress has been laid upon the contingency of the actual universe. An absolute and intensive infinity is here maintained for Deity, in face of the difficulties felt by certain philosophic writers who have not been able to shed quantitative notions in this sphere of thought. The absolute and self-existent Ground and Cause of all things is, that is to say, as the Absolute Being, really infinite—One in our conceptions of whom we have got clear away from thinking of infinite extension in space, and existence in infinite time. The very end of our study of the positive relations, which God sustains to the empirical world of space and time, is just to raise us at last beyond itself to the spaceless and timeless Causality of the Deity who forms its Ultimate Ground and Cause.

Our conclusion as to the First Cause argument, customarily presented as an inference from effect to cause, is that it is invalid. As an argument, however, from the contingent character of the world to the necessity for a World-Ground, it retains validity and worth. Such self-existent and eternal World-Ground or First Cause is, by an inexorable law of thought, the necessary correlate of its finitude. Though we must reason to Him from data of sense, yet the view so gained may be regarded as our first and most fundamental philosophical conception of God, as involving an Absolute Being necessarily existing. God and the world are not to be conceived as cause and effect, for modern metaphysics can by no possibility regard such an expression of the connexion between the world of experience and the Ground of all possible experience (no mere *ens extra-*

mundanum) as anything like adequate. The true abiding First Cause is God, taken as the ultimate and absolute Ground of the possibility of everything that is—the self-existent Cause of the ever-present world and its phenomena. Should this form of the argument appear to carry infinity only in implicit mode, God, it should be remembered, is, in its presentation of Him as the Absolute Being, taken as full intensive infinitude—infinite plenitude of existence. By such infinity is meant no mere absence of limitation, but the positive conception of pure actuality, limitless existence—an infinity incommensurable with all that is limited. Or, should it be asked whether, in this way, we have not found a Being who is *ens primum* (first Being) rather than *causa prima* (First Cause), our answer clearly is that a Ground so related to the actual world is *causa prima* as well as *ens primum*—is for us *ens primum* precisely that He may be *causa prima*. The First Cause must be just such absolutely necessary Being or *ens a se*, else it were contingent, which the First Efficient Cause could not conceivably be. Such a Deity, as *causa sui*, creatively bringing forth the world out of His own potences, cannot be allowed to be an arbitrary resting-place, but is a truly rational ground, of thought. For the ontologic basis supplied in the *ens primum* or Absolute Being is not taken as something standing by itself and indeterminate, but something whose objective activities, as the true First Cause, world-phenomena are, and whose nature they bespeak or expound. Thus we preserve and maintain the First Cause argument in deeper form than the old Aristotelic mode, in which the search for a Prime Mover had relation only to the contingency of motion in matter; our argument goes deeper, being concerned with the contingency of being or matter itself. Neither motion nor matter carries necessity in itself; both are grounded in the necessary, ultimate, and self-existent Cause of all things.

LITERATURE.—J. Lindsay, *The Fundamental Problems of Metaphysics* (contains a very full Bibliography, both historical and systematic), Edin. 1910; *Studies in European Philosophy*, do. 1909; *Recent Advances in Theistic Philosophy of Religion*, do. 1897; J. Martineau, *A Study of Religion*, 2 vols., Oxford, 1889; A. Dorner, *Religionsphilosophie*, Leipzig, 1903; G. T. Ladd, *Philosophy of Religion*, 2 vols., Lond. 1906; A. Caldecott, *Philosophy of Religion in England*, do. 1901; R. Flint, *Theism*, new ed., Edin. 1902; A. C. Fraser, *Philosophy of Theism*, do. 1899; B. P. Bowne, *Studies in Theism*, New York, 1902; W. L. Davidson, *Theism*, London, 1898; J. H. Stirling, *Philosophy and Theology*, Edin. 1890.

JAMES LINDSAY.

FIRSTFRUITS (Introductory and primitive).—Although a purely practical purpose was perhaps primarily involved in the use of firstfruits (see § 4), it may be taken as an axiom of primitive thought that all which is new is sacred, tabu, and hence not to be touched by man until certain ceremonies are performed by which the tabu is taken off and the whole is set free. This is analogous to the doing of anything for the first time, or the first occasion of any series of events, or the entering upon a new state of life, e.g. manhood or womanhood, marriage, entrance into a mystery association. These states are sacred, dangerous, and involve a tabu condition, primarily because they are new states.¹ For this reason they are accompanied by rites which serve to remove the tabu and to carry off the danger with which the persons concerned are charged. We can thus understand why it is that the new crops, the new vintage, the first catch of the season, the first-born of domestic animals and even of man, are regarded as tabu or sacred. The crops, etc., must not be cut or gathered or dug up or used until certain rites have been performed. The nature of these rites reveals another axiom of primitive thought—that the whole may be fully represented by the part, so that, by setting aside a part, the whole is

¹ See Van Gennep, *Les Rites de passage*, Paris, 1909, p. 249 ff.

set free. In the case of the crops or the vintage, that part is known as the firstfruits. Similarly in the case of the chase or fishing, the first animal or fish caught is also set apart in some specific way, thus giving liberty for the hunter or fisher to continue his pursuit in safety. And the first-born of domestic animals is often sacrificed or set free, because it is invested with a peculiar sanctity, and by this act the future progeny is, as it were, made usable (see FIRST-BORN).

The rites by which the corn or the vintage is set free for ordinary use are of different kinds. Thus the firstfruits may be sacrificed to a god or spirit, or to the dead. They are sometimes eaten in a solemn manner and, so to speak, sacramentally; or there may be a combination of sacrifice and ritual eating. Again, they are made over to king, chief, or priest, who sometimes performs upon them or with them certain ceremonies. Firstfruits are sometimes part of the crop which has been sown specially for this purpose. Frequently the first-fruit ceremonies are very elaborate and lengthy. They often terminate with a feast, or are the occasion of a kind of saturnalia; or they form a kind of festival of beginnings, a New Year, when also new fire is kindled and distributed to the community. And, where the new food is eaten solemnly, it is sometimes prepared for by fasting or by swallowing emetics, in order to make the body ready for the reception of the sacred food (see FASTING, § 4). It is unnecessary to give examples of these rites from all parts of the world. It will be sufficient to cite a few typical ones with references to similar customs in other localities.

1. Sacrifice of firstfruits.—(a) Offerings to gods.—In Tahiti the firstfruits of orchards and gardens, with pigs, fowls, etc., were offered to the gods, and it was death to the owner if they were not thus acknowledged (Ellis, *Polynes. Researches*, London, 1831, i. 350). Firstfruits were offered to the god Tani in the Society Islands, with the words, 'Here, Tani, I have brought you something to eat' (Tyerman and Bennet, *Journ. of Voyages and Travels*, London, 1831, i. 284). Such offerings were general throughout Polynesia. The Baganda offered firstfruits from a new garden to a divinity, asking his blessing on the future crops (Roscoe, *Baganda*, London, 1911, p. 428). The Basutos do not touch their corn after threshing, before boiling some, casting it upon the rest, and saying, 'Thank you, gods; give us bread again to-morrow.' The bulk is now pure and fit to be eaten (Casalis, *Les Bassoutos*, Paris, 1859, p. 265). The Ewe tribes offer some of the new yams or maize to divinities. In the case of the yams, some have been specially planted for the goddess to whom they are offered. The offerer says, 'When I dig mine, grant that I may have plenty,' and then proceeds to dig (Spieth, *Die Ewe-Stämme*, Berlin, 1906, pp. 344, 795). In ancient India the *āgrayaneṣṭi*, or offering of firstfruits, took place in early summer (barley) and in autumn (rice). Cakes were made of these, or the grain was boiled, for Indra and Agni, for the *Viśve Devās*, and for heaven and earth. Thus the plants were rendered wholesome and faultless, for myth told how the gods had first offered this sacrifice to free the plants from the poison of the Asuras (*SBE* vii. [1900] 191, xii. [1882] 369 ff., cf. xxx. [1892] 93, 124, 289). Among many of the present-day tribes the first of the crops, of wine, and of oil is made over to gods or spirits; and, as in the N.W. provinces, this is done that the god may preserve the crop from insects and rats (Cooke, *PR* 2, 1896, i. 105 ff.; *Roman-Urdu Journal*, Lahore, iii. [1880] 11; Moorcroft and Trebeck, *Trav. in Himalayan Provinces, 1819-25*, London, 1841, i. 317 f.; Atkinson, *Himal. Districts*, Allahabad, 1884, ii. 825; Shaw, *Asiatic Res.* iv. [1807] 56 f.). In Borneo, when the rice

is ripe, bunches of it are placed round an altar. A two days' feast takes place with dancing. At the conclusion the crops may be gathered (St. John, *Forests of Far East* 2, London, 1863, i. 191). Examples like these from the lower culture might be multiplied indefinitely.

In the Semitic area the principle that the gods, or some of them, were lords of the cultivated land was well recognized. To them, therefore—in return for seasonable rain and sunshine, growth, increase, and fruitfulness—a share of the produce was given. Thus, in Babylonia the harvest festival was a well-established custom, and to the gods were presented firstfruits of all produce, since the latter was really their property (Sayce, *Rel. of Ancient Egypt and Bab.*, Edinburgh, 1902, pp. 466 f., 473; Jastrow, *Aspects of Rel. Belief and Practice in Bab. and Assyria*, New York, 1911, p. 343). This was also true of the Canaanites. The *b'ālm* caused the fruits of the earth to increase, and men presented to them the firstfruits. An inscription mentions a seven days' festival marked by an offering of firstfruits (de la Saussaye, *Manuel d'hist. des religions*, Paris, 1904, p. 184; for Hebrew firstfruits, see next article). In Egypt, Min was the god of the generative power in Nature. To him harvest festivals were dedicated in thankfulness. Firstfruits were presented to him, or to his servants, or to the local divinity. The new king also celebrated a festival to Min, offering sacrifice, and cutting a sheaf of new corn which he strewed before the bull sacred to the god. This was a symbolic offering of the firstfruits of his reign (Wiedemann, *Rel. of Anc. Eg.*, London, 1897, p. 127; Erman, *Life in Anc. Eg.*, do. 1894, pp. 66, 245, 272).

The ancient Teutons also recognized the principle of the offering of firstfruits of the grain harvested; and Snorri speaks of three annual sacrifices, one of which was in connexion with harvest (Grimm, *Teut. Myth.*, London, 1880-8, pp. 39, 42; de la Saussaye, 693). The ancient Roman husbandmen offered a sacrifice of firstfruits of all the various crops to those divinities who were chiefly associated with their welfare: the first ears to Ceres, the first vintage to Liber. Pliny says that neither new corn nor new wine was tasted until the priests had offered the *primitiæ* (*HN* xviii. 2; Festus, s.v. 'Sacrima'; Wissowa, *Rel. und Kultus der Römer*, Munich, 1902, p. 345). In the festivals of the State religion traces of these offerings survive. From May 7 to 14 the Vestals prepared the *mola salsa* made from the first ears of the standing corn, and offered these at the Vestalia in June. At the Vinalia in August or April the *flamen Dialis* plucked the first grapes (*auspicatio vindemiæ*) and offered prayer and sacrifice for the preservation of the whole vintage (Varro, *de Ling. Lat.* vi. 16). Warde Fowler has connected the custom of offering tithes (*decumæ*) of various things at the yearly rites of the *ara maxima* with an earlier offering of firstfruits, these suggesting or even developing sporadically into tithes (W. R. Smith 2, 245 f.; see § 6 below; W. Warde Fowler, *Roman Festivals*, London, 1899, p. 195; cf. also his remarks on pp. 207, 212; see also FIRSTFRUITS [Greek]).

In China the *Lī Kī* describes how the husbandman presented the firstfruits of wheat and millet in the first and second months of summer respectively, and the son of Heaven consumed them with other meats, first solemnly offering a portion of them (*SBE* xxvii. [1885] 271, 274). In both ancient Mexico and Peru, firstfruits were also sacrificed to the gods (Müller, *Amer. Urrelig.*, Basel, 1855, pp. 374, 626).

(b) Offerings to the dead.—In many instances firstfruits are offered to ancestral ghosts, who are believed to have power over the growth of the crops. This is common among many African tribes, e.g.

in the south, where no one might gather the millet till the chief had offered some to his ancestors (Theal, *Records of S.E. Africa*, vii. [London, 1901] 397). Generally the spirits are thanked for their services, invited to partake of the food, and, as with the A-Kamba, their permission is asked for the people to eat the crop (Hobley, *Ethnol. of A-Kamba*, Camb. 1910, p. 85 f.; cf. also Hetherwick, *JAI* xxxii. [1902] 94 f. [Yaos]; Tönjes, *Ovamboland*, Berlin, 1911, p. 195; Mockler-Ferryman, *Up the Niger*, London, 1892, p. 141 f. [Igbiras]). In Fiji the firstfruits of yams are presented to ancestral spirits in the *nanga*, or sacred enclosure, and none may eat until this is done, under risk of madness (Fison, *JAI* xiv. [1885] 27). In the Solomon Islands the first yams and canarium nuts are presented to the ghosts for their consumption, and until then none may eat or gather them (Woodford, *Naturalist among the Headhunters*, London, 1890, p. 26 f.; Codrington, *Melanesians*, Oxford, 1891, p. 132 f.). In Tanna, dead chiefs are offered firstfruits to eat, and are requested to be kind to the people (Turner, *Nineteen Years in Polynesia*, London, 1861, p. 88; see also Mariner, *Tonga Islands*², do. 1818, ii. 196 f.; Neuhaus, *Deutsch Neu-Guinea*, Berlin, 1911, iii. 434 f. [Bukaua: reward to the ghosts for watching the crops, petition for further favours]). Some tribes of India also offer firstfruits to ancestors, e.g. the Oraons of Bengal, who ask them to 'come and rejoice with us' (Dehon, *Rel. and Customs of the Oraons*, Calcutta, 1906, p. 137), and similar offerings to the dead are common among the Kochs of Assam, in Ceram, and in Tenimber and Timor-laut Islands. Cf. art. FOOD FOR THE DEAD.

(c) *Wild food-stuffs*.—It should be observed that even the produce of uncultivated plants may not be eaten until some has been made over to the spirits presiding over Nature. This is done by some of the wilder Indian tribes in British Columbia, none daring to gather or eat berries or roots in their season till some have been offered to these spirits (Hill-Tout, *JRAI* xli. [1911] 132; J. Teit, *Thompson Indians of Brit. Col.*, New York, 1900, p. 345). Similarly in the Shortland's group, Solomon Islands, when the Pleiades appear at the nutting season, houses are decorated with branches of nuts as an offering to the spirits and to prevent accidents while they are being collected. If the nuts are ripe before the Pleiades appear, no one will eat of them until this takes place (Brown, *Melanesians and Polynesians*, London, 1910, p. 210 f.). This shows that Divine ownership in all that earth produces—not only that which is cultivated by man—is recognized at low levels.

The sacrifice recognizes the Divine ownership of the whole crop, and is analogous to the custom of offering the first spoils of war, the first ore or metal from a mine, or part of a meal or drink. Here it touches the custom of offering to a god only a part of a sacrificial animal, the offerers eating the rest. The principle underlying the sacrifice of firstfruits is that the whole is sacred because it is the possession of a god. Therefore there must be a recognition of that ownership by what has been called a *sacrifice de désacralisation*. The sacrifice sets free the bulk for common use by concentrating upon it the sacredness of the whole (Hubert and Mauss, *Mélanges d'hist. des rel.*, Paris, 1909, p. 79).

2. Ritual eating of firstfruits.—(a) In many parts of the world the bulk of the crops may not be touched until part has been eaten with certain prescribed ceremonies. Thus at Kiriwina, New Guinea, the chief, after fasting for some days, makes the whole crop of yams tabu. Feasts follow, at which spirits, including those of the yams, are present to partake (Brown, 413 f.). In the Reef Islands (Melanesia) there is a 'holy eating' of the new fruits, with thanksgiving to the spirit presiding over all food-stuffs (O'Ferrall, *JAI* xxxiv. [1904] 230). In Buru each clan meets to eat a meal of new rice, contributed to by each member of the clan. This is called 'eating the soul of the rice'

(Wilken, in Frazer, *GB*³, pt. v. vol. ii. p. 54). With the Kayans of Borneo, who believe also in the soul of the rice, each person is ceremonially touched by the priestess, and then eats a few grains, after which the feast begins (Nieuwenhuis, *In Centraal-Borneo*, Leyden, 1900, i. 156). This ritual eating is also found in India. In Bihar, when the crops are cut, some of the new grain is taken home and eaten with certain ceremonies (Grierson, *Bihar Peasant Life*, Calcutta, 1885, p. 398). Among the Coorgs the reaper of the first rice is chosen by an astrologer. Each one takes a hot bath and then repairs to the rice-field, where this reaper cuts some rice. Of this a cake is made by him, together with other ingredients, of which every one receives a piece (Gover, *Folk-songs of S. India*, London, 1872, p. 105 ff.). Old men among the Ainu eat the new millet ceremonially before the people can eat. At the same time they worship the living spirit of the millet or the 'cereal deity' (see *ERE* i. 248^b). Ceremonial eating of new fruits, yams, etc., is found among many African tribes. Among the Kaffirs the king himself placed the new food in the mouth of each one, and death would have been the punishment of any one who had eaten before this rite (Grout, *Zulu-land*, Philadelphia, 1864, p. 161; Speckmann, *Die Hermannsbürger Mission in Afrika*, Hermannsburg, 1876, p. 150 f.). The king first partook of new fruits among the Matabele. Many oxen were sacrificed, and, on the fourth day, the new crops were distributed among the people by a medicine-man. No one might eat until all these ceremonies were over, under pain of death (Decle, *Three Years in Savage Africa*, London, 1898, p. 157 f.). Among the Onitsha the medicine-man places part of the new yam on the lips of the person, who then eats the remainder, offering thanks for being permitted to eat the new yam (Crowther and Taylor, *Gospel on the Banks of the Niger*, London, 1859, p. 287 f.). Among the Baganda, when beans are ripe, the mother causes her son to eat some of the first cooked. Neglect of this would cause the anger of the gods. Her husband then jumps over her, after which the beans may be eaten by all (Roscoe, 428). Many American Indian tribes ate the new corn ceremonially, usually after fasting or drinking an emetic (MacCauley, *5 RBEW* [1887], p. 522 f. [Seminoles]; Speck, *Eth. of Yuchi Indians*, Philadelphia, 1909, p. 86 f.). Among the Natchez the 'feast of grain' consisted in a ceremonial eating of new corn which had been specially sown with a certain ritual. The chief or 'great Sun' appointed a day for the rite, new fire was made, and, after the grain had been cooked, the command was given to eat it (*Bull. 43 BE*, Washington, 1911, p. 113 f.). For survivals of such customs among the peasantry of Europe, see Frazer, *GB*³, pt. v. vol. ii. p. 50 f.

(b) Sometimes the chief or king alone eats the new fruits. This was a common custom among West and South African tribes, no one being allowed to touch the food until the chief had eaten, while the occasion of the W. African yam 'customs' was marked by human sacrifices and wild saturnalia (Ellis, *Tshi-speaking Peoples*, London, 1887, p. 229 [people fast before eating]; Ramseyer and Kühne, *Four Years in Ashantee*, London, 1875, p. 147 f.; Werner, *Brit. Cent. Africa*, do. 1906, p. 271 [Bantu chief tastes ceremonially before the people can eat]; Macdonald, *JAI* xix. [1890] 277; *FL* xx. [1909] 436 [Pondos and other Bantu tribes]). In Burma some of the *pangati* fruits were taken to the king, who ate of them. No one might eat before this (Bastian, *Die Völker des östlichen Asien*, Leipzig, 1866, ii. 105). In other cases, as in Samoa, firstfruits must be offered to the chief, else calamities will follow (Turner, *Nineteen Years in Polynesia*, p. 327). Or, as among the Betsileo (Mada-

gascar), firstfruits form a part of the royal revenue (Shaw, in *GB*³, pt. v. vol. ii. p. 116).

(c) Here also it should be observed that wild food-stuffs are eaten ritually before the bulk can be touched. Some Indian tribes of British Columbia eat the shoots of the wild raspberry. When they are ready, the chief's wife or daughter is sent to pick a bunch. These are cooked, and the chief begs the spirit of the plant to grant them a good supply. Then the food is distributed to all present. A similar ceremony is performed when the berries are ripe. The ceremonies were intended to propitiate the spirit of the plant, in order that a plentiful supply might be vouchsafed; and, if not properly carried out, there was a danger of offending the spirit (Hill-Tout, *JAI* xxxiv. [1904] 330 f.).

3. Sacrifice combined with ritual eating.—Among the Nandi the women of the family place a basketful of the new corn to dry. Some drops through upon the fire; and, if it explodes, this is a sign that it is accepted by the spirits of the dead. A few days later, porridge is made from this grain. Some is daubed on walls and roof, and some placed in the mouth by all present and then spat out towards the east. The head of the family holds some in his hand and prays for health and for milk, etc. (Hollis, *Nandi*, Oxford, 1909, p. 46 f.). The Ewes have elaborate ceremonies, in which new yams are offered to the gods and a meal follows (Spieth, *Die Ewe-Stämme*, p. 304 f.). The tribes of the lower Congo throw part of the first crop of maize, peanuts, and beans towards the rising sun and eat some, saying, 'We are eating them for ever' (Weeks, *FL* xx. [1909] 311). The Musquakie Indians at the 'Green Corn Dance' make a burnt-offering of the corn to Geechee Manitou for the increase of fertility. Thereafter corn is cooked and a ceremonial feast follows (Owen, *Folk-lore of Musquakie Indians*, London, 1902, p. 52 f.). Similarly the great 'Busk' festival of the Creeks, so often described, with its fastings and emetics, consists of a sacrifice of firstfruits and a ritual eating (Adair, *Hist. of the Amer. Ind.*, London, 1775, p. 96 ff.). In New Caledonia, the first yams are carried before the ancestral images, cooked in pots reserved for that purpose, with prayer for a good annual crop, and eaten (Glaumont, *L'Anthropologie*, viii. [1897] 43 f.). The Badagas of the Nilgiri Hills make the grain of the first sheaf into cakes which are offered and then eaten by the family (Harkness, *Description of a Singular Abor. Race*, London, 1832, p. 56 f.). The central rite of the great Pongol festival of S. India consists in cooking new rice, some of which is offered to Ganesa, the remainder being eaten by the family (Gover, *JRAS*, new ser., v. [1871] 91 f.; Wilson, *Essays*, London, 1862, ii. 169 f.). In N.W. India firstfruits are offered to the family gods, and then part of the offering, mixed with milk and sugar, is tasted seven times by each member of the family (Elliot, *Hist. of N.W. Provinces*, London, 1869, i. 197). Among the Chams, firstfruits gathered from a sacred field are offered to Po-Nagar, goddess of agriculture, and afterwards eaten. Not till then may the remainder of this field as well as the ordinary fields be reaped (Aymonier, *RHR* xxiv. [1891] 272 ff.).¹

4. Origin of firstfruits.—In some of the instances cited it has been seen that the food-stuff is believed to be tenanted by a spirit, or to be divine. For this reason Frazer has claimed that in all cases where firstfruits are eaten ritually there is 'a sacrament or communion with a deity, or at all events with a powerful spirit,' and he emphasizes the facts of preparation, purification, and the use of special vessels for the firstfruits as also pointing in this direction (*GB*³, pt. v. vol. ii. p. 82 ff.). He

¹ For curious combinations of old pagan customs with Christian rites in Armenia and Syria, see *FL* xv. [1904] 430, 439, 443.

thinks that 'in course of time the sacrifice of firstfruits tends to throw the sacrament into the shade, if not to supersede it' (p. 88). But it may be asked whether there is not a more primitive stage in the history of firstfruits, prior to ritual eating or sacrifice. In most known instances the crops are tabu until the ritual eating or sacrifice is performed, and frequently it is by the act of chief or medicine-man that the tabu is removed. The study of tabu shows that it is very easy for a tabu imposed for purely practical purposes to be hedged about with supernatural sanctions. At an early stage in his history man must have come to see the value of a 'close time.' The fruits of the earth, and animals useful for food, should not be gathered or slain until they were quite ready. This would be emphasized by the community, and insisted on by the old men, or by the chief or medicine-man, and, until these gave the signal, probably consisting of a verbal permission or of some simple rite, nothing could be gathered, or slain, or eaten.

This is illustrated by the totemic customs of many Central Australian tribes. Men of a totem perform *intichiuma* ceremonies to multiply their totem species, expressly for the benefit of non-members of the totem group. When the totem now becomes plentiful, the non-members go out and bring in a large supply of the animal or plant. But not till the men of the totem have eaten a little or performed a simple rite, e.g. rubbing with the animal's fat, and given verbal permission, can the others indulge themselves freely (Spencer-Gillen², 169 ff., 283 ff.).¹ It should also be observed that, elaborate as are the yam 'customs' of W. Africa (§ 2 (b)), they are primarily based on a sanitary fact, viz. that the yam is dangerous before a certain time; the 'customs' take place only when it is fit for use (de Cardi, App. to M. H. Kingsley, *W. Afr. Studies*, London, 1899, p. 450, cf. 174). Again, among certain groups of S. African people, one branch, the Bahurutsi, have the prerogative of first eating the firstfruits of the year. None of the other tribes may do so till they have received permission from them (Stow, *Nat. Races of S. Africa*, London, 1905, p. 520, cf. 413). In the Australian instances, and probably here also, there is no apparent belief in a sacramental eating and no sacrificial rite, but merely a removal of tabu on a food supply by those who have a right to remove it.

The primitive prohibition would be supported by various sanctions, and would be analogous to similar food tabus in time of scarcity or those imposed by men upon women or youths. But it would be an easy matter for various magical or religious rites to attach themselves to whatever ceremony was used to raise the tabu—eating the food, etc. The growing feeling that some mystery or sacredness or danger was connected with first things or actions or processes would aid in the application of such rites. When the food-stuff came to be regarded as animated by a spirit, the act of eating would become sacramental (W. African, Ainu instances), and might extend to others besides old men or chiefs. All had then to eat ritually before it was safe to eat the bulk. Or, when it was thought that food-stuffs were produced by spirits or gods, their ownership would be recognized by dedicating a part to them with thanksgiving. Thus they would be propitiated, would continue their goodness, and would now allow men to eat safely and freely of their bounties.² Or both ritual eating and sacrifice might be combined (cf. Lang, *Magic and Religion*, p. 267 f.). Where there is a meal or a feast, spirits or gods are believed to eat with the worshippers.

The view here taken (following Lang) is further supported by the prominent place which the old man, the chief, or medicine-

¹ It is interesting to observe that among the Igorrot, before gathering rice, the harvesters sit round a tiny fire; and the owner of the field says, 'Palay, when we carry you to the granary, increase greatly so that you will fill it.' He then gathers a handful, after which cutting begins (Jenks, *Bontoc Igorot*, Manila, 1905, p. 103). Some of the instances cited above connect firstfruit rites with the increase of the crops or animals, or there is prayer for a blessing or for a good annual crop (Baganda, Basutos, Ewe, tribes of N.W. India, § 1; tribes of Br. Columbia, § 2; Musquakie Indians, § 3).

² Cf. W. R. Smith², 459: 'The agricultural tribute of firstfruits and tithes is a charge on the produce of the land, paid to the gods as Baalim or landlords.' For the application of a supernatural sanction to tabued foods, see art. FALL [Ethnic], vol. v. p. 707^b

man often has in the ceremony of firstfruits (cf. an instance from Rājmahāl [India], where the chief fines any one who eats the new Indian corn before the public thanksgiving for the crops [Shaw, *Asiatic Researches*, iv. [1807] 56 f.]; while among the Matabele any one who ate new fruits before the king did so was put to death). Further, in Elema and Waima we see this more primitive custom in action. The chiefs and old men proclaim a tabu, and certain masked men, called *kaiwakuku* or *harihu*, impose it and punish transgressors. The tabu is imposed after planting and fencing yams, and takes the form of 'forbidding any one to dig or remove anything from the garden until such time as the *harihu* decide that the crop is fit for gathering.' At that time they inform the chief, who then gives permission (Seligmann, *Mel. of B.N. Guinea*, Cambridge, 1910, p. 299 f.; cf. Brown, 126). In many parts of Melanesia the season of yam harvest is regulated by the appearance of the Pleiades (Codrington, 348; Guppy, *Solomon Islands*, London, 1887, p. 55; cf. § 1 above). In Victoria an old chief of the Spring Creek tribe taught the young people the relation of the stars and planets to the seasons; e.g. the appearance of Canopus was a signal for the approach of the emu egg time (Dawson, *Aust. Abor.*, Melbourne, 1881, p. 75). Presumably before such a time no one might touch the crop, and until the appearance of these stars it was recognized to be tabu. In some instances, also, there is neither sacrifice nor ritual eating, but merely the performance of certain acts before which the crop is absolutely tabu, and any infringement is fraught with danger (see, e.g., Roscoe, 428; Grierson, 398).

5. Firstlings.—Similar rites applied to the first animal taken in the season's chase or fishing and to firstlings of flock or herd, and it is not impossible that here it was the analogy of the firstfruits of uncultivated products which gave rise to those rites, first of all in the case of animals caught, later aided by the general belief in the sacredness of the first-born, in the case of the firstlings of flock or herd, just as the tabu on uncultivated plants must have preceded that on the cultivated crops. The rites are of various kinds, but in the case of sacrifice of the firstlings of flock and herd it is hardly likely that all the first-born in a season were sacrificed. Probably only one first-born, the first of the year, was sacrificed as representative of all the others (see, however, Ex 22⁵⁰, where every first-born seems intended).

In Tahiti the first fish caught in the season was offered on the altar (Ellis, i. 350). In Florida (Melanesia), the first flying-fish of the season was sacrificed to ghosts, some of whom were represented by images, as sharks. Others had no images. The fish was therefore offered before the image or simply cast into the water to the ghost (Codrington, 138). In Peru, firstlings of animals were sacrificed (Müller, 375). Among the ancient Arabs the sacrifice of firstlings (*sara'*) was recognized, probably in connexion with the annual sacrifices of *Rajab* (=the Hebrew Passover month). But it is not certain whether *sara'* means the first-born absolutely or the first birth of the year (W. R. Smith², 228, 462; Lagrange, *Études sur les rel. sémitiques*², Paris, 1905, pp. 255, 298). In North Africa the native still sacrifices the first-born of the flock as well as the firstfruits at a shrine, in order to expel evil from the flock or the harvest (Doutté, *Magie et rel. dans l'Afrique du nord*, Algiers, 1910, p. 491).¹ Many instances have shown how the offering of firstfruits is accompanied by prayers for the safety of the crop. In Babylonia there was a yearly sacrifice of firstlings of the flocks (de la Saussaye, 155), and also among the ancient Teutons (Grimm, 42).

An example of the ritual eating of the first catch is found among the Indians of British Columbia. When the sock-eye salmon run began, the first caught was brought to the chief, who called the people together and prayed. The fish was then cooked and a small portion given to each present, to propitiate the spirit of the fish and to ensure a plentiful catch (Hill-Tout, *JAI* xxxiv. 330). In other cases a different procedure is adopted. Among the natives of the upper Congo the first fish caught by a lad is given to his parents, or, among the Bangala, to his mother, or, if she is dead, to her next of kin, else he would fall under a curse. And, generally, the first fish caught in the season is given to the first person who greets the owner when he steps ashore, else he will have no further luck. This is analogous to the native practice of giving away the firstfruits of a man's skill in manufacturing, farming, hunting, etc., and to that of a girl's giving the firstfruits of a farm to her mother or her aunt (Weeks, *JRAI* xxxix. [1909] 425; *FL* xii. [1901] 186). Of the practice in N. India of presenting the first piece of sugar from the cane or the first bowl of extracted juice to servants or to a friend or a beggar (*FL* xxi. [1910] 217; Crooke, *PR*² ii. 307). At the rite of firstfruits in ancient India, a first-born calf was presented to the priest as his fee (*Satapatha Brāhmana* [SBE] xii. [1882] 369). See also FIRST-BORN.

6. Firstfruits in the Christian Church.—The Jewish custom of giving firstfruits and tithes for¹ Of the Carib idea that the offering of firstfruits preserved from diseases (Müller, 211), and the Hindu belief that, if the firstfruits of the rice boil well, there will be good luck in the coming year (Hopkins, *Rel. of India*, Boston, 1896, p. 440 f.).

the support of the priesthood passed over into Christian usage. The first reference to firstfruits is in the *Didache*, § 13. Every true prophet is to receive the firstfruits of the wine-press and threshing-floor, of oxen, and sheep, of baking of bread, the first of each fresh jar of wine or oil, and the first of money, clothing, and every possession. Failing a prophet, these were to be given to the poor. Irenæus taught that Christ enjoined firstfruits when He took bread and wine at the Last Supper (*Hær.* iv. 17). Origen thinks that our righteousness cannot exceed that of the scribes and Pharisees if we misuse the fruits of the earth so that the Priest and Levite know nothing of them (hom. xi. in *Num.*). The custom was general but voluntary, though several of the Fathers insist upon the duty of giving firstfruits and tithes (Origen, c. *Cels.* viii. 33, 34; Jerome, in *Ezek.* 44, in *Mal.* 3; Greg. Naz. *Ep.* 80, *Or.* 15). The *Apostolic Constitutions*, like the *Didache*, define the things out of which firstfruits are to be paid—wine, corn, bread, honey, sheep, and oxen for the clergy, clothing and money for the poor (vii. 30). These are apportioned by the bishop (ii. 25). The Council of Tours in 567 and of Mâcon in 585 ordered payment of tithes, and about two centuries later the practice of charging lands with tithe became usual and was enforced by the State during the Carolingian period (see TITHES). This obligatory tithe for the most part replaced firstfruits, though not wholly. A Council at Bordeaux in 1255 fixed their amount at a thirtieth to a fortieth; another at Tours in 1282 made it a sixtieth; and they were still paid in France in the 18th century.

Bishops had frequently claimed the firstfruits of vacant benefices (theoretically a year's income), this probably originating in the fees paid by incumbents. The Popes began to make a similar claim. Thus Clement v. forbade bishops to take firstfruits, but in England he had done so only to claim them for himself. Even before this the Popes had regarded firstfruits (*primitiæ*) of benefices as at their disposal. John XXII. appointed a collection of firstfruits in Scotland and England in 1316, and he soon extended his claim over the whole Church. Bishops, abbots, prebends, rectors, and vicars were generally included in this tax, though John exempted bishops and abbots. The *communia servitia* or *annates* paid by bishops and abbots grew out of sums paid to the Papal See by candidates for vacancies. In France the payments of firstfruits went on till the Revolution. The Council of Basel (1431-43) had wished to abolish them, but the Concordat of Vienna confirmed earlier decisions. In England, where large sums had been taken out of the country and much dissatisfaction caused, payment to the Papal See was made to cease at the Reformation, but Henry VIII. still laid claim to firstfruits. Eventually the resultant revenues were transferred in 1703 to 'Queen Anne's Bounty,' a fund administered for the poorer clergy in the Church of England.

LITERATURE.—The fullest account of firstfruits is in J. G. Frazer, *GB*³, pt. v., 'Spirits of the Corn and the Wild,' 1912, vol. ii. pp. 48 ff., 109 ff. See also Ersch-Gruber, *Encyc.*, Leipzig, 1818-84, s.v. 'Erstlings'; A. Lang, *Magic and Religion*, London, 1901, ch. 14, 'First-fruits and Taboos.' For firstfruits in the Christian Church, see J. Bingham, *Antiquities of the Christian Church*, do. 1829, i. 482 ff.; W. M. Brady, *Episcopal Succession*, do. 1876; H. W. Cripps, *Treatise on the Laws relating to the Church and Clergy*⁵, do. 1869; J. C. L. Gieseler, *Ecclesiastical History*, Eng. tr., Edinburgh, 1853, iv. 86 f., 102 f.; Wetzer-Welte, *Dict. encyc. de la théologie catholique*, Paris, 1868 ff., s.v. 'Dime,' 'Prémices.' See also the authorities cited throughout the article. J. A. MACCULLOCH.

FIRSTFRUITS (Greek).—It is a natural thing for those who believe that the gods meddle in all human affairs to dedicate parts of that which they

enjoy. Whether this be due to fear or to gratitude does not always appear; but the practice is widespread (see FIRSTFRUITS [Introductory and Primitive]). Amongst the Greeks it is closely connected with the tithe (see TITHES [Gr.]); the present article will be confined to those cases where the word 'tithe' is not used. The offering of the firstfruits was necessary before it was lawful to enjoy the fruits of the earth.¹

The Greek proper terms are ἀπαρχή, ἀπαργματα, ἀπαρχεσθαι, varied by ἐπαρχή, ἐπαρχεσθαι, or even by ἀργματα, ἀρχεσθαι locally and before the terms become fixed. Homer uses ἀργματα,² which also occurs in very old Attic inscriptions,³ and ἀρχεσθαι, ἀπαρχεσθαι, or καταρχεσθαι.⁴ The active ἀπαρχω occurs in an old Tanagran dedication.⁵ 'Firstfruit' is ἀπαρχή in Herodotus (i. 92), but ἀπαργματα in early inscriptions.⁶ Other inscriptions have ἐπαργματα,⁷ ἐπαρχή,⁸ καταρχή.⁹ The meaning of the noun is ἀπαρχαὶ τῶν ἐνιαυσίων καρπῶν,¹⁰ ἐπαργματα ὧν αἱ ὄραι φέρουσι;¹¹ ἀκροθίνια really bears the same meaning, the θίνες being σωροὶ τῶν πυρῶν καὶ κριθῶν.¹²

The original sense is firstfruits in kind, which were offered by the farmer, fisher, or hunter from the earliest times;¹³ and the words were applied both to war and to the profits of industry. We have instances of the firstfruits of oil,¹⁴ corn,¹⁵ fish and house-property,¹⁶ tribute-money,¹⁷ and man;¹⁸ the men became temple slaves, and sometimes were sent out as colonists.¹⁹

The Athenians sent the firstfruits to Delos in their sacred ship,²⁰ and other States sent firstfruits regularly to Delos²¹ and Delphi;²² while the shrine at Eleusis was supported by firstfruits sent thither from all parts, on the command of the Delphic oracle.²³ The firstfruit or tithe was sometimes symbolized by a permanent offering, a model in metal of the object tithed. We find golden ears of corn dedicated (θήρη χρυσᾶ),²⁴ golden olive,²⁵ vine,²⁶ perhaps silphium;²⁷ Pliny mentions a golden radish, a silver beet, and a lead turnip.²⁸ The same meaning may be given to the numerous figures of game or domestic animals, especially those in characteristic attitudes: as hare, deer, stag, duck, cock, sheep, cow, bull, mare, stallion.²⁹ Specimens of the groups are a brood mare suckling a foal,³⁰ a man milking a cow,³¹ a stag brought down by hounds.³² A model of a ram dedicated at Athens is inscribed τὴν ὀκείαν (=ὀκείαν) με τάθηναλαι ἀνέθηκεν.³³

From the practice also develop the organized agricultural feasts; but the customs of the country folk, which doubtless kept their old simplicity throughout the history of the Greek race, and still survive in some form, may be seen from the descriptions in the novel of Daphnis and Chloe.³⁴

Firstfruits are often offered to a hero; the Athen-

¹ Schol. on Aristoph. *Plutus*, 680.

² *Od.* xiv. 446. ³ *CIA* i. 347.

⁴ *Il.* xix. 254, *Od.* iii. 445, xiv. 422, 428.

⁵ *BCH* xix. 242.

⁶ *CIA* i. 347; *Ditt. Syll.* 2, Leipzig, 1898, no. 630 (Thera).

⁷ *IG (Ins.)* iii. 436¹⁴ (Thera).

⁸ *Ditt. Syll.* 2 587¹⁸¹, etc. (Athens), 589²⁰ (Oropus).

⁹ *CIA* ii. 632.

¹⁰ *Suid.*, *Hesych.*; cf. *Collitz, Sammlung d. griech. Dialekt-inschriften*, Göttingen, 1884 ff., ii. 2561, D 49.

¹¹ *IG (Ins.)* iii. 436¹⁴ (Thera).

¹² *Suid.*, *Hesych.*; cf. *Collitz*, ii. 2561, D 49.

¹³ *Cl. II.* ix. 534. ¹⁴ *CIA* iv. 1, 27 B.

¹⁵ *CIG* 484.

¹⁶ Quoted in *Daremberg-Saglio*, s.v. 'Donarium,' p. 366⁴⁷.

¹⁷ *CIA* i. 226, etc. ¹⁸ *Ib.* i. 210; *Plut. Quæst. Gr.* 35.

¹⁹ See *ref.* in *Pauly-Wissowa*, i. 2667.

²⁰ *CIA* ii. 934, 985; *Mommsen, Feste der Stadt Ath.*, Leipzig, 1898, p. 451.

²¹ *BCH* vi. 41¹⁴, xiv. 406, xxvii. 90⁴⁸ etc.

²² *Ib.* xviii. 103, xx. 695 f.

²³ *CIA* iv. 1, 27^b; *Ditt. Syll.* 2 587 note, 177.

²⁴ *Plut. de Pyth. Or.* 16 (Myrrhina, Apollonia); *Strabo*, vi. 264 (Metapontium); *CIA* i. 161⁹, *Ἀθίων περίχρυσον στάχυες ΔΙ* (Athens).

²⁵ *Oropus (IG [Sept.] i. 3496⁸¹)*. ²⁶ *Delos (BCH* xiv. 406).

²⁷ *Schol.* on *Aristoph. Plutus*, 925.

²⁸ *HN* xix. 86.

²⁹ *Hesych.* s.v. Βάρα κάρας; *IGA* 385; *Rouse, Greek Votive Offerings*, p. 67 ff.

³⁰ *Cat. Acrop. Mus. Bronzes*, 480, 481.

³¹ *Mus. Ital.* ii. 727, from Crete.

³² *Bronzen von Olympia*, xiv, 219, 220.

³³ *Cat. Acrop. Mus. Bronzes*, 527.

³⁴ See *Rouse, op. cit.* 43 ff.

ians offered them to the *Μαραθωνομάχοι*;¹ we find the custom quite late, as in the case of Drimakos, leader of the Chian slave-revolt, who was heroized after his death.² No doubt this custom also is primitive, as firstfruits are offered now in many places to the ghosts of dead ancestors;³ or they might be offered to any deity who should have helped the worshipper, as Demeter;⁴ but the favourite deities of the countryside were Artemis for the hunter, Pan and the Nymphs for the farmer or breeder. The hunter hung up head and horns (if any) or skin upon a tree,⁵ or even dedicated these at a shrine of Artemis (as at Lusi in Arcadia),⁶ who was angry if she did not receive her due.⁷ Pan and the Nymphs were worshipped in caves—itself a sign of primitive worship. Homer speaks of these;⁸ and we have a record of the same thing about 500 B.C. in the case of Vari (τόνδε ταῖς Νύ(μ)φαισιν ὁ Σκύρωνος αἰπόλος),⁹ besides mention of many others. In bk. vi. of the *Anthology*, Pan receives 34 dedications—more than any other deity. Other deities who get firstfruits are the Mothers in Sicily,¹⁰ Cybele,¹¹ Hermes,¹² Aphrodite,¹³ Priapus,¹⁴ Bacchus and the Satyrs.¹⁵ Fishers dedicate the first tunny of a catch to Poseidon;¹⁶ they also dedicate firstfruits to other gods, as to 'the gods' in general,¹⁷ to Pan,¹⁸ to the Nymphs,¹⁹ to Artemis.²⁰

Firstfruits of work (ἔργων, τέχνης) are mentioned;²¹ and are recognized by Isæus (vi. 42) as of regular occurrence. Occasionally we seem to get the craftsman dedicating his first work or 'masterpiece'; Lycinus states this of himself: *Λυκίνος ἀνέθηκεν τῇ Ἀθηνάαι τὸ πρῶτον ἡργάσατο*;²² and a pot found on the Acropolis is called 'firstfruit of work.'²³ We cannot tell if this was a common thing; but there are many records of artists dedicating some of their own works.²⁴ Literary men might dedicate their books, as Heraclitus did at Ephesus,²⁵ and Hanno his logbook at Carthage.²⁶

LITERATURE.—W. H. D. Rouse, *Greek Votive Offerings*, Cambridge, 1902, ch. ii.; *Daremberg-Saglio*, s.v. 'Donarium'; *Pauly-Wissowa*, s.v. ἀπαρχαί. W. H. D. ROUSE.

FIRSTFRUITS (Hebrew).—The term *bikkûrîm* (בִּכְוֹרִים), which is cognate with *b'khor* (בְּכוֹר), 'first-born' (q.v.), 'firstling,' sometimes denotes first-ripe fruits (including cereals) in general (as in *Nah* 3¹² fig trees with *bikkûrîm*), oftener a small but choice portion of the first-ripe fruits which is offered to God (*Ex* 23¹⁶ etc.). *Rêshîth* (רֵאשִׁית) denotes the *first* of fruits (*Ex* 23¹⁹ etc.), of harvest (*Lv* 23¹⁰), of grain (*Dt* 18⁴), of dough (*Nu* 15²⁰¹), of wool (*Dt* 18⁴), of all one's increase (*Pr* 3⁹).

Many savage peoples (see FIRSTFRUITS [Introductory and Primitive]) have the custom of eating new corn, rice, and other products of the field sacramentally, for the purpose of partaking of the Divine life which is supposed to animate the fruits of the earth (*W. R. Smith, Rel. Sem.* 2, 1894, p. 242; *Frazer, GB* 2, 1900, ii. 318 ff.). It can scarcely be

¹ *Thuc.* iii. 58.

² *Nymphodorus*, in *Athenæus*, vi. 266 D; cf. *Philostratus, Heroica*, 286.

³ *Frazer, GB* 2, 1900, ii. 463 ff.

⁴ *IG (Sept.)* i. 1670; cf. *Theocr.* vii. 154 ff.; *Anth. Pal.* vi. 36, 258.

⁵ *Diod.* iv. 22; *Anth. Pal.* vi. 96, 255.

⁶ *Jahreshefte*, iv. 37, 58.

⁷ *Il.* ix. 534.

⁸ *Od.* xvii. 210.

⁹ *Amer. Journ. of Arch.* n.s. vii. 263 ff.; *CIA* i. 423 ff.

¹⁰ *Diod.* iv. 80.

¹¹ *Ditt. Syll.* 2 630.

¹² *Corp. Parioepiogr.* i. 157.

¹³ *Anth. Pal.* vi. 119.

¹⁴ *Ib.* vi. 22.

¹⁵ *Ib.* 44.

¹⁶ *Antigonos*, in *Athen.* vii. 297 D.

¹⁷ *Agatharchides*, in *Athen.* vii. 297 D.

¹⁸ *Anth. Pal.* vi. 196.

¹⁹ *Ib.* 224.

²⁰ *Ib.* 105.

²¹ *CIA* i. 345, iv. 1, 105, 213, 373, etc.; *BCH* xiii. 160; *IG (Sept.)* iii. 131.

²² *BCH* ii. 522, 547.

²³ *CIA* iv. 373¹² b, c.

²⁴ *IGA* 36a, pp. 170, 412; *Ath. Mith.* xvi. 154; *BCH* xii. 464; *Simon*, in *Xen. Hippik.* 1.

²⁵ *Diog. Laert.* ix. 6.

²⁶ *Bosworth Smith, Carthage*, London, 1897, p. 13.

said that any distinct trace of this primitive conception is to be found in the Hebrew peasant religion, though Eerdmans ingeniously suggests that the spring festival was observed by eating unleavened cakes in order to preserve the 'soul' of the corn for the seed of the year to come (*Expositor*, Nov. 1909, p. 459 f.). What is certain is that in the mind of the Hebrews, who borrowed their conception from the Canaanites among whom they settled, an intrinsic sacredness attached to all firstfruits. Just as the whole produce of a new orchard during the first three years was 'uncircumcised,' and not eaten, while all the fourth year's fruit was consecrated to Jahweh (Lv 19²³⁻²⁵), so the firstfruits of every year belonged to Him and had to be brought to His altar. Till He had received His share it was unlawful and unsafe to eat the new fruit. It is a question whether the offering was supposed to make the Israelite's whole harvest, and all the bread which he ate during the year, pure and hallowed. This is the view of Benzinger (*EBi*, 4911), who notes that one of the punishments with which Hosea threatened Israel in exile was that they would have only 'bread of mourners' (Hos 9⁴), i.e. unclean bread, to eat, because no portion of it could be brought into the house of God. W. R. Smith, on the contrary, thinks that the prophet here refers only to animal food. His own view is that the offering of firstfruits

'makes the whole crop lawful food, but it does not make it holy food; nothing is consecrated except the small portion offered at the altar, and of the remaining store clean persons and unclean eat alike throughout the year. This, therefore, is quite a different thing from the consecration of animal sacrifices, for in the latter case the whole flesh is holy, and only those who are clean can eat of it' (*op. cit.* 241).

Marti (*Rel. of the OT*, London, 1907, p. 115) finds in the firstfruits a trace of primitive Semitic polydæmonism. He supposes that they originally belonged to the spirits of the field, for whom it was also the custom to leave the outermost border of a field that was being reaped, or to forget a sheaf in a corner (Lv 19⁹, Dt 24¹⁹, where the poor now get the benefit of what was once meant for the spirits). When Animism faded in the strong light of Jahwism, the destination of the firstfruits was, of course, completely changed.

The law regarding firstfruits is not the same in any two successive codes. (i.) The *Book of the Covenant* contains the archaic enactment, 'Thou shalt not delay thy fullness and thy trickling' (Ex 22²⁹ [E]), where the LXX paraphrases the substantives by *ἀλωνος καὶ ληνοῦ* and RV by 'the abundance of thy fruits, and of thy liquors.' The parallel reference to firstlings in the next clause makes this interpretation plausible. 'Thy trickling' (צקק, 'thy tear,' RVm) seems to denote the newly expressed juice of the grape, perhaps also of the olive. The two other forms of the enactment, couched in more ordinary language, are found in Ex 23¹⁶⁻¹⁹. 'The firstfruits of thy labours' (v. 16), which stands in apposition to 'the feast of harvest,' commonly called the 'feast of weeks,' seems to be less comprehensive than 'the firstfruits of thy ground' (v. 19), which probably includes the later grape and olive harvest. The provision in v. 19 would thus be exactly parallel to that in 22²⁹; and Driver (*Exodus*, Camb. 1911, p. 246) suggests that the two laws, having originally belonged to two distinct collections, were preserved on account of the difference of their form. 'The first (נְשֵׂאֵי) of the firstfruits' (Ex 23¹⁹ 34²⁶, cf. Ezk 44³⁰) denotes either the earliest (Gesenius) or the choicest (Knobel) of them; the rendering, 'the best, (even) the first ripe fruits,' which is favoured by Benzinger and others, is less natural. In all these primitive laws the amount to be offered remains indefinite, being a detail evidently left to the free will of the individual. There is as yet no thought

of dues in the strict sense of the word, but only of offerings determined by custom.

(ii.) In Dt 26¹⁻¹¹ the Israelite is directed to take a basket of firstfruits to the central sanctuary and present it at the altar, making use of a liturgical form expressive of gratitude for deliverance from Egyptian bondage and possession of a fruitful land. A joyful feast then follows, in which the offerer and his household are joined by the Levite and the stranger (*gēr*). The relation of the Deuteronomic firstfruits to the tithe (12¹⁷ 14²² etc.) is a question of great difficulty. Wellhausen (*Hist.*, Eng. tr., Edinb. 1885, p. 157) and Benzinger (*EBi*, 4911) hold that the two are identical, the firstfruits having been gradually fixed at the proportion of a tenth. This amount is not paid into the sanctuary as a due, and it is maintained that the directions for the use of the tithe (14^{23, 26, 27}) and of the firstfruits (26¹²) evidently refer to one and the same domestic feast. W. R. Smith (p. 244 ff.) thinks, on the other hand, that the tithe and the firstfruits were quite distinct, the former being a fixed tribute, comparatively modern in origin, and used to provide for the public banquets at the royal shrines (see TITHES [Heb.]). The question is further complicated by the ordinance in 18⁴ that the firstfruits are to be given to the priest, which seems so inconsistent with their destination in 26¹² that it is generally regarded as a later insertion, though Driver ('Deuteronomy,' *ICC*, 1895, p. 290) suggests alternative ways of reconciling the two passages.

(iii.) Ezekiel demands for the priests the first of all the firstfruits of everything, and also the first of the dough (44³⁰).

(iv.) In the *Law of Holiness* (H) it is ordained that a sheaf of the firstfruits of the harvest is to be waved before Jahweh; and, until this is done, no bread, parched corn, or fresh ears are to be eaten (Lv 23¹⁰⁻¹⁴). Seven weeks later two leavened wave-loaves are to be offered as firstfruits (vv. 15-17).

(v.) In the *Priestly Code* it is enacted that 'all the best of the oil, and all the best of the vintage, and of the corn, the firstfruits (*rēshith*) of them' are to be given to the priests, as also 'the first ripe fruits (*bikkūrim*) of all that is in their land' (Nu 18¹⁸). The *rēshith* is apparently the raw fruits, while the *bikkūrim* are the prepared corn, wine, and oil (cf. Neh 10^{36, 37} 12⁴⁴). A meal-offering of firstfruits consisted of parched corn in the ear with oil and frankincense, part of the corn and oil and all the frankincense being burned (Lv 2¹⁴⁻¹⁶).

(vi.) A distinction was finally drawn between *bikkūrim* and *t'rumōth* (תרומות, 'oblations'), and two tracts of the Mishna, bearing these names, are devoted to the subject. The *bikkūrim* were drawn from the 'seven kinds,' i.e. the seven products mentioned in Dt 8⁸—wheat, barley, vines, fig-trees, pomegranates, olives, and honey. Those who lived near Jerusalem offered fresh fruits, while those who came from a distance brought them dried. Philo and the Mishna describe the picturesque ceremonial which accompanied the presentation (Schürer, *HJP*, 1885, II. i. 237 f.). The *t'rumāh* was a payment in kind for the support of the priesthood, an impost levied upon every species of fruit, whether of the ground or of trees. The amount to be given was not fixed, but the person who gave $\frac{1}{2}$ was counted liberal, while he who gave $\frac{1}{3}$ was thought somewhat stingy (*ib.* 238 f.).

LITERATURE.—Philo, *de Festo Cophini* and *de Præmiis Sacerdotum*; W. Nowack, *Heb. Arch.*, Freiburg i. B., 1894, II. 255-257; art. 'Firstfruits,' in *HDB* (Peake); V. Ryssel, 'Erstlinge und Erstlingsopfer,' in *PRE³* v. [1898] 482-484; W. Nowack and E. G. Hirsch, 'First-Fruits,' in *JE* v. [1903] 398-400; and the authorities cited in the article.

J. STRAHAN.

FISH, FISH-GODS.—See ANIMALS.

FLACIUS.—Matthias Flacius (a Latinization of Vlaciĥ) is conspicuous among the German Reformers of the second generation. As a Churchman, he was the ablest and most uncompromising of the ultra-Lutherans who opposed Melanchthon's later mediating doctrines and practices. As a scholar he was not only the author (with collaborators) of the first, and for long the unexcelled, Protestant Church History, but also the pioneer of modern Biblical exegesis. As a theologian he was the unfortunate propounder of a doctrine of original sin which was rejected by friend and foe alike as a revival of Manichæism, and which made the latter part of his life tragical.

Born 3rd Mar. 1520 at Albona in Istria (hence surnamed 'Illyricus'), Flacius lost his father in childhood. In early youth he was able to profit by the instructions of the humanist Baptista Egnatius, in Venice, but, being still a devout Roman Catholic, he resolved, in his 17th year, to enter a monastery in order to pursue sacred learning. He therefore begged his uncle, Baldo Lupetino, provincial of the Franciscans, to receive him into his Order, promising him in return the half of his paternal estate. This pious and learned man, however, being in sympathy with the Reformation, diverted him from his purpose by directing his attention to the work of Luther, and counselling him to seek an academic career in Germany. The advice proved to be the determining factor in Flacius' life. After studying for some time at Basel and Tübingen, he finally turned his face (in 1541) to Wittenberg, the metropolis of the Protestant faith, where he was welcomed by Melanchthon, and came under the decisive influence of Luther. From the time when he entered Germany, humanistic studies failed to satisfy his awakened conscience, and he spent three years in spiritual darkness, often verging on despair, from which, however, he was at last delivered, chiefly through the wise instruction and tender sympathy of Bugenhagen and Luther. The personal experience which he thus had of the truth of the Evangelical doctrine of justification by faith alone became at once the basis of his theological reflexion and the impelling motive of his life-long contentions, always sincere if not always dispassionate, on behalf of the Lutheran Church and the purity of its faith.

In 1544, Flacius was appointed Professor of Hebrew in the University of Wittenberg; in the following year his marriage was graced by the presence of Luther, whose own life was now nearing its close; and a happy career seemed to await the brilliant young scholar. But he was soon drawn into the whirlpool of ecclesiastical politics. In May 1548, Charles v. launched upon the Empire the Augsburg *Interim*, a doctrinal and ceremonial compromise which was to be imposed until religious controversies should be settled by an Ecumenical Council. This formulary was essentially Roman Catholic, conceding to the Protestants merely the marriage of priests and the cup of the laity. It soon led to another compromise, the Leipzig *Interim*, enacted (December 1548) by the Elector Maurice, with the help of Melanchthon and other leading Lutheran divines, for his Protestant dominions, where it was impossible to put the Augsburg *Interim* into operation. This second document conserved the essentials of the Protestant creed, but it

'required conformity to the Romish ritual, including confirmation, episcopal ordination, extreme unction, and even the greater part of the canon of the mass, and such ceremonies as fasts, processions, and the use of images in churches' (P. Schaff, *Hist. of the Creeds of Christendom*, London, 1877, p. 299).

From the disposition of Melanchthon and his friends to treat these ordinances as indifferent or

non-essential (*ἀδιάφορα*), his party came to be known as the 'Adiaphorists' (see *ERE* i. 93). Flacius, finding himself obliged to assume the leadership of the strict Lutherans, at once began to write under various names against the treacherous compromise. In order not to witness the introduction of the Leipzig *Interim* into Saxony, he resigned his professorship, accepting poverty for conscience' sake. Betaking himself to Magdeburg, where the press was still free, and gathering around him a strong party of rigid Protestants, he opened a destructive literary fire upon the timid and overpliant Adiaphorists. Pamphlets poured from the press, and the scathing criticism of the *Interim* raised such a storm of opposition in Saxony that the obnoxious enactment was withdrawn, while the Elector Maurice felt emboldened to assume hostilities against the Emperor. At a critical time Flacius thus rendered an imperishable service to the Protestant cause. It is generally admitted that he 'saved the Reformation' (*EBr* II, art. 'Melanchthon,' p. 89^a note). The 'Flacianists' conquered the 'Philippists'; and Melanchthon, who in the beginning of the controversy had regarded his young opponent as a renegade—'aluimus in sinu serpentem'—wrote to him in September, 1556, offering, for the sake of unity, to confess that he was in the wrong:

'Fateor etiam in hac re a me peccatum esse, et a Deo veniam peto, quod non procul fugi insidiosas illas deliberationes' (O. Hardwick, *Hist. of the Christian Church during the Reformation*, London, 1894, p. 64).

Victory, however, failed to soften the heart of Flacius towards his venerable teacher; and, though their feud was in a manner patched up, the two men were temperamentally too different for any real reconciliation ever to be effected between them. The 'Philippists' and the 'Flacianists' long continued to represent different shades of Lutheranism, the former predominating in Wittenberg, the latter in Jena.

Flacius played an active part in all the other controversies of that era of theological strife, and always as a defender of what he believed to be true Lutheran doctrine. He strenuously opposed the mystical theory of Osiander, the Nuremberg reformer, who, assailing the forensic conception of justification, taught that the sinner is *made* just by an infusion of the Divine nature of Christ, who is our righteousness. In maintaining the doctrine of imputation, Flacius was in agreement with Melanchthon, Amsdorf, Chemnitz, and almost all the other divines of the time. In the Synergistic controversy, which was stimulated in 1555 by the *De libero arbitrio* of Pfeffinger, Professor in Leipzig, he fought for the doctrine of Luther's *De servo arbitrio*, denying the freedom of the will anterior to the reception of the supernatural gift of faith, affirming that God converts the sinner against and in spite of his perverse will, as the potter moulds the clay and the sculptor carves the statue of wood or stone. Here Flacius was in disagreement with Melanchthon, who, though he had originally sided with Luther in his debate with Erasmus as to human freedom, at length (after 1535) openly renounced Determinism as a Stoic and Manichæan error, and taught a certain limited co-operation of the human will in the work of conversion. Flacius was also involved in the Majoristic controversy which raged from 1552 to 1580, the year in which the 'Form of Concord' was framed. Georg Major, a pupil of Melanchthon, and from 1539 Professor at Wittenberg, declared at Eisleben (in 1552) that good works are necessary to salvation, and anathematized every one who taught otherwise. Flacius had recourse, as usual, to tracts for the times, in which he

'denounced Major's view as popish, godless, and most dangerous, because it destroyed the sinner's comfort on the death-bed

and the gallows, made the salvation of children impossible, confounded the gospel with the law, and weakened the power of Christ's death' (Schaff, *op. cit.* 276). Major himself ultimately recanted.

The doctrine with which the name of Flacius is specially associated arose out of the Synergistic controversy. Having been appointed Professor of NT Theology at Jena in 1557, he soon found himself sharply disputing with his colleague Victorinus Strigel on the question of the operation of the will in conversion. Having a profound conviction of man's corruption and consequent inability to do any good of himself, he went so far as to affirm that original sin is not an accident of human nature, but is involved in its very substance—'quidam substantiale in homine'—man having ceased at the Fall to be in any sense the image of God, and having become the image of the devil. He was warned in vain that by the use of such language he would provoke a charge of Manichæism, and, as he proceeded, with characteristic tenacity, to develop rather than to modify his doctrine, many of his former friends fell away from him, some of them even joining the ranks of his bitterest enemies. While he had no difficulty in quoting strong passages from Luther which seemed to favour his extreme view, it was instinctively felt that there was a wide difference between the reformer's vehement utterances and the theologian's deliberate dogmatism. The tide of opinion rose swiftly against Flacius, who (10th Dec. 1561) was deposed and exiled with 47 adherents. For him and his numerous family—he had 12 children by his first marriage and further issue by a second—there was henceforth only a life of wandering and poverty. Scarcely any place would shelter the lonely and persecuted heretic. His scheme of founding an academy at Regensburg came to nothing. Strassburg tolerated him for a few years, but cast him out in 1573. He found a last asylum in the convent of White Ladies at Frankfort, where he fell ill in the end of 1574. The City Council gave him notice to quit on Mayday 1575, but by that time, in the spring of the year (11th March), death had released him.

Some of Flacius' most important services to Protestantism still remain to be mentioned. Though too much of his energy was spent in controversy, he was essentially a scholar, and his literary output was as remarkable for its value as for its extent. In 1556 he published a *Catalogus Testium Veritatis*, in which he repels the charge of novelty which the Roman Church constantly brought against the Protestant, and proves that every Christian age had its 'witnesses' who combated the Papacy and its errors. To this book John Foxe was largely indebted for materials in compiling his *Actes and Monumentes of Christian Martyrs*, of which the first edition is dated 1565. Flacius next conceived the idea of writing a Church History,

'in which it should be set forth, in certain order and sequence of time, how the true Church and its religion gradually fell away from its original Apostolic purity and simplicity, and this partly from the negligence and ignorance of its teachers, partly from the wickedness of the ungodly; in which it should also be shown how the Church was ever and anon restored by some genuinely pious men, and how the light of truth now shone more clearly, and was again more or less obscured by the increasing darkness of ungodliness.'

In order to carry out his scheme on a grand and worthy scale, he formed (in 1553) a society which had its head-quarters in Magdeburg, but he himself remained the soul of the enterprise. Thus there appeared in 13 folios (1559-74) the *Magdeburg Centuries*, each volume comprising the events of a century, a *magnum opus* to which all later Church Historians were consciously or unconsciously indebted (see Baur, *Die Epochen der kirchlichen Geschichtschreibung*, Tübingen, 1852). To this Flacius added a similar epoch-making work

in the department of Biblical exegesis. In Regensburg he began his *Clavis Scripturæ Sacræ*, which was published in 1567.

'Through this work, which consists of a Bible Dictionary, with Essays in which the principles of exposition are laid down, Flacius became the father of Biblical Hermeneutics' (Plitt, *PRE*² iii. 567).

These principles he applied in his *Glossa Compendiaria in NT* (1570); that to the OT was left unfinished.

For centuries the name and fame of Flacius, the opponent of Melancthon, and the Manichæan heretic, remained under a cloud. Twisten (in 1844) was the first to do him justice. His honour was finally vindicated and his work appraised at its true value in W. Preger's masterly biography, *Matth. Flacius Illyricus und seine Zeit*, 2 vols., Erlangen, 1859-61. He had the faults of his qualities, and it is sometimes difficult to distinguish his zeal from fanaticism, his firmness from intolerance. It may therefore be admitted that 'his hard fate was not wholly unmerited' (Plitt, *op. cit.* 566). Yet Kling (*PRE*¹ iv. 415) is scarcely wrong in numbering him 'among that cloud of witnesses of which the world was not worthy.'

LITERATURE.—In addition to the authorities cited in the text, cf. J. J. I. Döllinger, *Die Reformation*, Regensburg, 1846-48, vol. iii.; F. H. R. von Frank, *Die Theologie der Concordienformel*, Erlangen, 1858-65, vol. i.; G. W. Frank, *de Matthiæ Flacii Illyrici in libros sacros meritis*, Leipzig, 1859; J. C. L. Gieseler, *Church History*, Eng. tr., New York, 1862, vol. iv.; I. A. Dorner, *Gesch. der prot. Theologie*, Munich, 1867 (Eng. tr., *Hist. of Prot. Theol.*, 2 vols., Edinburgh, 1871); art. 'Flacius' (by G. Kawerau), in *PRE*³ vi. [1899] 82-92.

JAMES STRAHAN.

FLAGELLANTS.—The great outbreak of penitential scourging which produced the brotherhood of *Flagellants* occurred in the middle of the 14th century; but this was only an abnormal intensification of a practice which had existed in Christian circles for centuries, and at least one previous epidemic of self-scourging had swept over Europe a century earlier.

Voluntary flagellation as a form of penance is as old as history and almost as wide-spread as religion itself. It does not appear to have been practised in the early Christian period or even in the early days of monasticism, though scourging, inflicted by superiors, was often used in monasteries as a means of correction. But, as the spiritual value of asceticism became impressed on the consciousness of Christians in the 10th and 11th centuries, men who burned with a passion for holiness of life resorted to flagellation as a means of subduing 'the soul's evil yoke-fellow,' the body. It came into especial prominence in the 11th century, through the practices of the monk Dominicus Loricatus († 1060) and of Peter Damian, Cardinal of Ostia († 1072). The latter advocated the substitution of self-flagellation for the reading of penitential Psalms, and even drew up a scale of values, making a thousand strokes of the lash equal to ten Psalms. The penitential scourgings which St. Dominic (1170-1221) practised upon himself, the passionate flagellation of the early Franciscans, and the introduction of collective flagellation into the monasteries, helped to form the mental attitude which was responsible for the first serious outbreak of public flagellation, which began in Italy just after the middle of the 13th century.

It was a time of mental tension. There was an inner circle of 'Spirituals' who were highly wrought with expectation that 1260 was to be the year of the new age of 'the Eternal Gospel,' prophesied by Joachim of Fiore; the people generally were brought almost to the limit of endurance by the woes of the party strife between the Guelphs and Ghibellines; and withal a powerful epidemic of the Plague came in 1259.

Suddenly, in this same year, 1259, without any organized propaganda, the city of Perugia was

seized with a contagion of penitence which showed itself in the form of flagellation. It spread with great rapidity through Northern Italy, along the Rhine, and to the East as far as Bohemia. It affected all walks of life and all orders of society. A contemporary Chronicle (*Monachi Patavini Chronicon*) records that even little children of five years, entirely naked, joined these processions. All the flagellants carried scourges made of leather thongs, and lashed themselves until the blood ran down their bodies. All sorts of sins were confessed, enemies were reconciled, vanities and follies were renounced, and men prepared themselves as for a new spiritual stage of life. Salimbene (1221-88) writes in his *Chronicle*:

'The Flagellants came through the whole world (!). All men, both small and great, noble knights and men of the people, scourged themselves naked, in procession through the cities, with the Bishops and men of religion at their head; and peace was made in many places, and men restored what they had unlawfully taken away; and they confessed their sins so earnestly that the priests had scarce leisure to eat. In their mouths sounded words of God and not of man, and their voice was as the voice of a multitude' (in *Mon. Hist.* iii. 238 ff.).

The still more famous gregarious outbreak of the contagion of penitential scourging, which led to the formation of the Brotherhood of the Flagellants (often called the Brotherhood of the Cross), came in the year 1349, Germany being the country where the movement showed its greatest power. It has generally been supposed that the outbreak was occasioned by the fearful devastation of the Black Death, but the investigations of Höniger (*Der schwarze Tod in Deutschland*) show that, in the incipency of the movement, the Flagellants preceded the appearance of the Black Death. As rumours came of the approach of the Plague from the East, bands of penitents formed, in the hope that God would spare Europe if there were a sufficient measure of repentance. These bands of Flagellants began to form in Hungary, and the movement travelled rapidly westwards, gathering volume and power until all Christian lands were touched by it; and incidentally it appears to have assisted in spreading the very plague which its organizers were striving to avert.

In its early stages the movement, though penetrated with enthusiasm, was well organized under the control of leaders. Whoever joined the brotherhood was bound to promise obedience to a captain, who was assisted by two lieutenants; to have money enough to furnish at least four pfennigs a day for his expenses; to have the sanction of his wife, if he was a married man; and to give assurance that he was reconciled with all men. The members of the brotherhood were forbidden to converse with persons of the other sex, to enter any house without invitation, or to beg for anything, though they were free to accept lodging and meals—but not for more than two days in any one town—if the hospitality were offered. Twice in the day, stripping to the waist, they lashed themselves with scourges, sometimes knotted, and sometimes supplied with iron points which embedded themselves in the flesh. They believed that their blood would mingle with the shed blood of their Saviour, and that this practice of painful, penitential flagellation, continued for thirty-three days and a half, would wash the soul free of all taint of sin. As these ideas came to clearer consciousness in the minds of the Flagellants, they began to feel that the means of salvation were in their own hands, and that the mediation of the Church and its priesthood could be dispensed with.

As the fervour of the movement increased, the influence of hymn-singing assumed a very important rôle, as it had probably also done in the earlier movement of 1260, and vast processions marched through the cities and the country dis-

tricts as well, singing hymns which aroused popular enthusiasm, stirred feelings of penitence, glorified the sufferings of Christ and the Mater Dolorosa, and gave the movement a great marching power. These Flagellation-hymns appear to have had a permanent influence on religious singing in the Christian Church (see Closener, *Strassburger Chronik*; Bartsch, *Germania*, xxv. [1880] 40 ff.; Bäumker, *Kathol. deutsches Kirchenlied*, ii. 201).

Under the mental tension of the times, the bodily pain inflicted by flagellation, and the general social upheaval, it is not at all strange that considerable hysteria, in a variety of forms, appeared. Some of the Flagellants, in their consciousness of spiritual power, undertook to cure diseases, to cast out devils, and even to raise the dead. One of the most curious signs of hysteria was the appearance within the group of a letter of Christ which an angel was said to have brought from heaven, promising that all who should scourge themselves for thirty-three and a half days should be partakers of the Divine grace. This letter was read in many places by the leaders of the procession of Flagellants as a genuine celestial document, and produced a profound impression among the highly-wrought populace.

The Church authorities were not slow in discovering that the movement contained many seeds of danger. In its first bursts of contagious power, when thousands in a single city were swept into it, little could be done to withstand its spread among the enthusiastic people; but, the moment the strange emotion began to spend itself and show signs of waning, the Church set to work to suppress it and to deal severely with all who taught or implied that men could cleanse themselves of sin by self-prescribed and self-inflicted penance, without the mediation of the Church; and in defence of social order the secular authorities joined in the work of checking organized flagellation. Pope Clement VI. and Emperor Charles IV., as well as the Sorbonne at Paris, united their efforts to prohibit, throughout Christendom, the continuance of flagellation-pilgrimages, while many subordinate representatives of the Church and many heads of countries and of cities resorted to extreme measures to destroy what now seemed to them a dangerous fanaticism. The popular mania for flagellation was soon checked; indeed, it waned of itself, as all such contagions do, as soon as the *suggestive-idea* loses its fascination and its hypnotic spell, and an emotional rebound sets in.

It was, however, not easy to manage the inner group of persons who through the movement had arrived at the radical view that self-inflicted penance was sufficient for salvation, and that the mediation of the Church was unnecessary. Those who arrived at this view gradually formed a sect, and stubbornly maintained their heretical way of salvation. The subject became of such importance that in 1417 it was dealt with in the Council of Constance, and Chancellor Gerson wrote a tractate against the sect of Flagellants, against their contempt of sacramental penance within the Church, and their glorification of their own self-prescribed form of penance. For many years later the sect persisted in Thuringia and other regions, allying itself with chiliastic expectations and joining with many sporadic types of heresy. In fact, the after-effects of the great movement of Flagellation did not wholly pass away before the Reformation.

LITERATURE.—E. G. Förstemann, *Die christl. Geisslergesellschaften*, Halle, 1828; W. M. Cooper, *Flagellation and the Flagellants*, ed. London, 1908; J. F. C. Hecker, *Epidemics of the Middle Ages*, London, 1844; Sebastian Franck, *Germaniae Chronicon*, Frankfurt, 1534; Jacob von Königshoven, *Elsass. und Strassburg. Chronik*, Leipzig, 1870-71; H. C. Lea, *Hist. of the Inquisition of the Middle Ages*, New York, 1888; C. Schmidt, 'Lied und Predigt der Geissler von 1349,' in *SK*, 1837, p. 889 ff.; *Historia Flagellantium*, written by Jacques

Boileau, published anonymously, Paris, 1700; 'Monachi Patavini Chronicon' (in Muratori, *Ant. Ital.* viii. 661; 'The Chronicle of Salimbene' (in *Monumenta historica ad provincias Parmensem et Placentinam pertinentia*, iii. (Parma, 1857)); R. Höniger, *Der schwarze Tod in Deutschland*, Berlin, 1882; F. Closener, *Strassburger Chronik*, Leipzig, 1870; C. Bartsch, *Germania*, xxv. (1880); W. Bäumker, *Kathol. deutsches Kirchenlied*, Freiburg, 1888, vol. ii.; H. Haupt, 'Geisselung, Kirchliche,' in *PRR* vi. (1899) 432-444.

RUFUS M. JONES.

FLEECE (Greek and Roman).¹—At a primitive stage of culture, fleeces were used as raiment or covering. In antiquity we find frequent traces of this use (Paus. iv. 11. 3, viii. 1. 5, x. 38. 3; M. Besnier, in Daremberg-Saglio, *s.v.* 'Pelles,' iv. 371 ff.). The Libyans were known to make their coverings, garments, and shoes out of goat's hide only (Hippokr. *repl. iphs. vourou*, in Wilamowitz-Möllendorff, *Griech. Lesebuch*, ii. [1908 ff.] 271. 30 ff.). Hides could also be used for bedding (Theocr. xxvii. 53), or they were placed on a hard seat as a kind of cushion; cf. *e.g.* the panther's hide of the Belvedere torso (W. Amelung, *Die Sculpturen des vaticanischen Museums*, ii. [Berlin, 1908] 9 ff., pl. 2), or the lion's hide on the fragment of a relief from Pergamon (*Ath. Mitt.* xxxv. [1910] 517, pl. 27. 3). The *Lares* were represented as protectors of the fields by being accompanied by a dog and dressed in dogs' skins (W. W. Fowler, *Rom. Fest.*, London, 1899, p. 101; G. Wissowa, *Rel. u. Kult. d. Römer*, Munich, 1902, p. 151. 3). In Mamurius' fur-clad appearance we must also, in the present writer's opinion, see a purposed archaism. (H. Pringsheim, *Arch. Beitr. z. Gesch. d. eleus. Kults*, Munich, 1905, p. 27 f., and Pley, *op. cit. infra*, p. 24, hold a different opinion.) In none of these cases has the fleece a religious meaning any more than when the hunter hangs the hide of a killed lion on a fir-tree as an offering to Pan, the god of hunters (*Anth. Pal.* vi. 37. 3; cf. also G. Kaibel, *Epigr. gr.*, Berlin, 1878, no. 811), or when the hide of the sacrificed animal is, as usual, the priest's share (Schoemann-Lipsius, *Griech. Altert.* ii. [Berlin, 1902] 447 f.; F. Puttkammer, *Quomodo Græci in sacrificiis carnes distribuerint*, Königsberg, 1912, p. 7 ff.; sometimes the god is named as the recipient of the fleeces; cf. Dittenberger, *Syll.*², Leipzig, 1898-1901, nos. 566. 14; 633. 10).

On the other hand, a magic meaning attaches to the goat's hide which women wear in the Dionysiac orgies, in order to become similar to the goat-like god (Hesychius, *s.v.* *τραγῆφοροι*; cf. also Paus. ii. 23. 1), and in the same manner the *nebris*-garment of the Sabazios mystics will have to be interpreted (P. Stengel, *Die griech. Kultusaltert.*², Munich, 1898, p. 146. 14; Arnob. v. 39, p. 209. 3, ed. Reifferscheid). We may not, however, as Robertson Smith (*Rel. Sem.*, 1889, p. 454 f.) suggests, read an analogous meaning into the passage of Lydus (*de Mens.* iv. 65, p. 119. 19 f., ed. Wünsch) by altering the text, which is quite correct.

The qualities of an animal could likewise be transferred to the wearer of its fleece. Pliny (*HN* viii. 258) tells us that children were rendered fearless by being covered with the hide of a fearless ass. Herakles renders the young Aias invulnerable by wrapping him in his own lion's skin (Berthold, 'Unverwundbarkeit in Sage und Aberglauben der Griechen,' *Rel. Vers. u. Vorarb.* xi. i. [Giessen, 1911] 8 ff.).

The belief in the magic power of fleeces goes yet further (Riess, in Pauly-Wissowa, *s.v.* 'Aberglauben,' pp. 73, 79, 82, and *passim*; Daremberg-Saglio, *s.v.* 'Pelles,' iv. 373. 27-33; W. Kroll, *Antiker Aberglaube*, Hamburg, 1897, p. 27; L. Deubner, *de Incubatione*, Leipzig, 1900, p. 27 f.; Abt, in Schiele's *Religion*, i. [1909], *s.v.* 'Amulette,' p. 452; F. Tambornino, 'De antiquorum daemonismo,' *Rel. Vers. u. Vorarb.* vii. iii. [1909] 88;

¹ For a more general treatment, see art. Wool.

Pley, 100, 102 ff.). Not only are fleeces a help against all sorts of diseases (Pliny, xxix. 38), but in many cases they also have apotropæic power. On the one hand, the hide is endued with the same forces that are ascribed to the animal (Fehrlie, *Alemannia*, 3rd ser., iv. 16, 19); on the other hand, the hide as such seems to have been credited with special influences, independent of the animal it belonged to. It is difficult to state, in each case, how far the belief in the magic power of a sacrificed animal's skin must here be taken into account (*ARW* xiii. [1910] 491 f.; Kroll, *ib.* viii. [1905], *Usenerheft*, p. 40). Often the healing power of a hide was a perfectly natural one, as when fresh sheep-hides were laid upon bruises (Pliny, xxx. 118), in which case the warmth of the hide had a soothing effect. It is difficult to draw the line between rational and magic uses; they appear side by side, as is customary in popular medicine. The hide is used in many ways: a stag's hide is slept upon to quell the fear of snakes (Pliny, xxviii. 150); a sleeve made of wolf's hide is worn to prevent one's being poisoned or bewitched (Pliny, xxviii. 157); shoes made of beaver- or seal-skin are potent against gout (*ib.* xxxii. 110; Alex. Trall. ii. 581, Puschmann); the extremities are rubbed with fur, to relieve a terror or nose-bleeding (*ib.* xxviii. 61); amulets are wrapped in pieces of fur and worn (cf. Tambornino, *l.c.*); vines are cut with a scythe which has been wiped with the skin of a beaver, to prevent the grapes from being eaten by caterpillars (Pliny, xvii. 265); the vessel in which the seed-corn was kept was wrapped in the skin of a hyæna, to ensure good germination (*Geopon.* ii. 18. 8; Colum. ii. 9. 9; Pallad. x. 3. 1); a vineyard is protected from all sorts of evil if the skin of a seal or a strap made of sealskin is hung among the vines (*Geopon.* i. 14. 3; Pallad. i. 35. 15). In order to protect a farm from hail, one must carry the hide of a hyæna, crocodile, or seal round its precincts, and then hang it up before the front-door (*Geopon.* i. 14. 5; cf. Pallad. i. 35. 14; Orph. *Argon.* 762 f.). A piece of the seal's skin, which protects against lightning, is always worn (Suet. *Aug.* 90); during a thunderstorm one repairs to a tent made of seal-skin (Pliny, ii. 146) and hangs sealskins on the masts of ships (Lydus, *de Mens.* p. 181. 19 ff., ed. Wünsch). Magic texts are written on hyæna-hides (Wessely, 'Neue gr. Zauberpap.,' *Denkschriften d. Wiener Akad.*, 1893, p. 26. 201. 203. 206). Ashes of a burnt ram's hide are used (Marc. Emp. 33. 56, p. 346, ed. Helmreich). Perhaps the strange record of Juppiter having reached heaven with the help of the golden fleece has something to do with the magic power of fleeces (*Mythogr. Vat.* i. 24, where the text of the Vaticanus, according to O. Rossbach's kind information, is as follows: '[pellem auream] in qua iovis in celum ascendit'); and it is not impossible that this golden fleece of the Argonaut legend has its origin in the same belief. That the possession of a golden fleece should ensure the knightly power and dominion over the sun's course (R. Eisler, *Weltenmantel*, Munich, 1910, p. 566. 6) is not corroborated by the Schol. on *Il.* ii. 106, ed. Bekker (cf., however, Eur. *El.* 718 ff.). The Pythagoreans altogether forbade the use of hides as coverings; they allowed only linen for that purpose (Iamblichus, *Vita Pyth.* 100).

Not only in magic, but also in cult, the supernatural properties of fleeces become clearly evident. And here, too, they are not specific properties, but the very multiplicity of uses bears evidence of the magic character in general (cf. Harrison, *Prolegom.*², Camb. 1908, p. 27). Thus, when, in the cult of Zeus Akraios, fleeces from Pelion were used to attract rain (Nilsson, *Griech. Feste*, Leipzig, 1906, p. 5 f.), we need not conclude that the fleece was chosen

as a simile for the clouded sky (Eisler, 80 ff.). The other testimonies which Pley (p. 21 ff.) adduces for the use of fleeces in rain-magic do not belong to the present category, or are very doubtful. The ægis of Zeus, however, may be interpreted as a mythical parallel of the 'weather-fleece,' which, when shaken by the god, had the power of producing rain and storm (*Il.* xvii. 593 ff.; O. Gruppe, *Griech. Myth.*, Munich, 1906, p. 823). This is not the only marvellous property of the ægis. It is above all a *φόβητρον*, a magic terror, that puts foes to flight (Schol. on *Il.* xv. 29). In this connexion Athene has taken it over. That the ægis-'shield' is only a later stage of development (M. Mayer, *Arch. Jahrb.* vii. [1892] 198), and that the ægis is originally a genuine fleece, is proved by the fact that occasionally the goddess wraps herself in the ægis (*Il.* xviii. 204), and that the Roman Juno Sospita, who is clad in a goat's hide (Wissowa, 117; *JHS* xxi. [1901] 227), is probably descended from an old Ionian type of Athene (Petersen, *Röm. Mitt.* ix. [1894] 296 f.).

The magic fleece is used in agrarian rites under the name of *δίων κώδιον*, which has nothing to do with Zeus (Harrison, 23 ff.). In the last third of the month Maimakterion there was a procession in honour of the chthonic Meilichios (Eust. ad *Od.* xxii. 481, p. 1935 *initio*; E. Pfuhl, *de Athen. pompis sacris*, Berlin, 1900, p. 62; Nilsson, *Ath. Mitt.* xxxiii. [1908] 285), who later on was identified with Zeus. In this procession the *δίων κώδιον* mentioned by Eust. (*l.c.*) was most probably carried round. Since for the same period a sacrifice to Zeus Georgos, a kindred god to Zeus Meilichios, is recorded (Prott, *Fasti sacri*, Leipzig, 1896, pp. 7, 10 f.), and in the month Maimakterion fields were ploughed and corn sown (Preller-Robert, *Gr. Myth.* i. [Berlin, 1894] 131. 2; G. Thiele, *Antike Himmelsbilder*, Berlin, 1898, p. 58), the *δίων κώδιον* was probably borne round the tilled land, in order to protect the seed within this magic circle against all evil (cf. also Preller, *Polemon. fragm.*, Leipzig, 1838, p. 141, and the above-mentioned magic rite for protecting the farm against hail). Zeus Maimaktes and the Maimakteria (Preller-Robert, *l.c.*) have nothing to do with this festival (cf. Pfuhl, *l.c.*, whose reasoning, however, is not satisfactory). On the other hand, the festival Skirophoria, in which a sacred ploughing and sowing—evidently enacted in analogy to the profane ploughing and sowing at that season—was performed (Plut. *Coniug. præc.* 42, p. 144*), belongs to this sphere. Here, too, the *δίων κώδιον* was used (Suid. *s.v.* *δίων κώδιον*), in the same manner, no doubt, as at the feast of Meilichios. The cathartic properties of the *δίων κώδιον* seem to have developed later out of its agrarian functions. Not only was the magic fleece able to ward off evil, but any one brought into touch with it was freed from all uncleanness and evil influences. Therefore, those in need of ritual cleansing placed themselves or their left foot (Hesych. *s.v.* *Διὸς κώδιον*; cf. Amelung, *Atti della Pontif. Acc.*, 1905, p. 128 ff.) on such a fleece (Pley, 11; Phryn. *Præp. soph.* p. 9. 14 f., ed. Borries; the 'fleece' on the scene representing the 'cleansing of Theseus' [*Gaz. arch.* ix. (1884) 352 f.; Gruppe, p. 892. 1] is more than doubtful), and those who were submitted to the various cleansing ceremonies of initiation (Schoemann-Lipsius, 414, 417) had to sit or stand on a fleece (Suid. *l.c.*; Hauser, *Röm. Mitt.* xxv. [1910] 287 f.; to a different category must be assigned Aristoph. *Nub.* 730, cf. A. Dieterich, *Kl. Schr.*, Leipzig, 1911, p. 117 ff.). The purpose of the fleece on a 'Thracian rider' relief (*ARW* xv. [1912] 157, pl. 1, no. 4) is not clear. Not a ram's hide (Pley, 31), but the customary net of *infulæ* that covers the Delphic omphalos, is figured in the scene in Müller-Wieseler (*Denkmäler*, ii. [Göttingen, 1881], fig. 137, cf. p. 95). It is

not impossible that the hide of the Calydonian boar shown in the temple of Athene Alea in Tegea (Pfister, 'Reliquienkult,' *Rel. Vers. u. Vorarb.* v. i. [1909] 324 f.) may once have been used in a rite, but it is not very probable.

It has been indicated above that the magic powers of fleeces were probably in part due to the fact that hides of sacrificed animals were used. The *δίων κώδιον* originated from the skin of an animal offered as sacrifice (Pley, 11). This signification of sacrificial animals' hides can be clearly recognized in several cases. The *lepai γυναῖκες* of the Andanian mysteries were allowed to wear only soles of felt or of the skin of sacrificed animals (Dittenberg, *Syll.*² no. 653. 23; Prott-Ziehen, *Leges Græc. Sacrae*, II. i. [Leipzig, 1906], p. 183, § 4). The *albogalerus*, which the *flamen Dialis* wore on his head, likewise had to be made of the hide of a sacrificed animal (Pley, 38; incorrectly explained in E. Samter, *Familienfeste d. Griechen u. Römer*, Berlin, 1901, p. 37). Apron and straps of the *luperci* were cut out of the hide of the goat which had been sacrificed to Faunus (*ARW* xiii. [1910] 490 ff.). The special importance of wool in religious rites probably finds its explanation in the significance of the sacrificial hide.

From a similar point of view we must interpret the custom of *confarreatio*, where bride and bridegroom sat on a seat covered with the fleece of a sacrificed sheep (Serv. ad *Aen.* iv. 374). But the special purport of this ceremony lies in the fact that the sitting side by side on the same fleece was to render the nuptial bond inviolable. The present writer considers it very improbable that there is any closer connexion between this ceremony and the *pellis lanata*, on which in Rome the young wife sat down as soon as she had entered the house of her husband (A. Rossbach, *Röm. Ehe*, Stuttgart, 1853, p. 324 f.). As this custom is found also among other tribes (Samter, 101 f.), it must have an independent meaning. Probably it was a magic rite to promote fruitfulness, as the Indian parallel (Oldenberg, *Veda*, Berlin, 1894, p. 463) shows; in this case again the fleece exerts its magic powers. We do not know the special reason why the young married couple, in Attica, were visited by the priestess of Athene, bearing the ægis (Suid. *s.v.* *alyts*); but here, too, a magic rite may be supposed, for the purpose of fruitfulness.

In some dream-oracles it was the custom that he who interrogated the god lay down to sleep on the hide of a sacrificed animal (Deubner, *de Incub.* 27; Eust. ad *Il.* ii. 233, p. 1057, 64; for the oracle of Faunus, cf. R. Heinze, *Virgils ep. Technik*, Leipzig, 1903, p. 172. 2). The god was understood to be moved by the fleece of the animal that had been consecrated to him to give the desired enlightenment.

LITERATURE.—The leading sources and authorities have been noted in the article. An attempt to treat the significance of the fleece in ancient cult is offered by J. Pley, 'De lanae in antiquorum ritibus usu,' in *Rel. Vers. u. Vorarb.* xi. ii. [Giessen, 1911] 1 ff. Though this does not exhaust the subject, the author's leading idea of close relationship between fleece and wool is correct and important.
L. DEUBNER.

FLIES.—See ANIMALS, BAALZEBUB.

FLOOD.—See DELUGE.

FLOWERS.—The purpose of the present article is to discuss briefly the growth of an appreciation of flowers amongst civilized peoples in ancient and modern times.¹

1. Jewish.—An examination of the references to flowers in the OT yields almost entirely negative results. The country in which the Jews lived was carpeted with flowers, especially in the early spring; and their variety and beauty elicit the

¹ For other aspects of the subject, see art. TREES AND PLANTS.

admiration of travellers to-day. The flowers in Palestine which specially attract the traveller's attention are the tulip, poppy, hyacinth, cyclamen, asphodel, Star of Bethlehem, crocus, mallow, and scarlet anemone. So little thought did the Jews give to their flowers that, as far as we know, they did not bestow distinctive names upon all of them. Thus the Heb. word *shûshân*, which is now applied by the inhabitants of Palestine to anemones, tulips, and ranunculi, is rendered in the LXX by *κρίνον*, and in English by 'lily.' Its use in Ca 5¹³ ('his lips are [as] lilies') suggests that both here and in the NT *κρίνον* should be rendered by 'scarlet anemone'—one of the commonest and most beautiful flowers in Palestine (cf., however, Löw, *JE* viii. 88 f.). The representation of pomegranates on the pillars of the Temple (1 K 7^{18, 20}) and on the priestly ephod (Ex 28³³) was probably borrowed from Egypt. According to Flinders Petrie (*HDB* i. 269), the design of bells and pomegranates is the old Egyptian lotus-and-bud border.

If by the appreciation of flowers be meant the appreciation either of their natural beauty or of their mystic significance, apart from a recognition of their ornamental use, it would be hard to quote any passage from the OT which would suggest such appreciation. The Jew, who inhabited a country which was more or less surrounded by deserts, had a vivid appreciation of the fertility of his own land. Thus, one of the Psalmists says: 'The valleys also are covered over with corn; they shout for joy, they also sing' (Ps 65¹³). Its fertility was often used as a symbol of spiritual blessings, both in the Psalms and in the latter part of Isaiah, where the prophet calls upon the trees and mountains to rejoice with him in view of what God had accomplished: 'Break forth into singing, ye mountains, O forest, and every tree therein' (Is 44²³); and, again: 'The mountains and the hills shall break forth before you into singing, and all the trees of the field shall clap their hands' (55¹²). The words which immediately follow, 'Instead of the thorn shall come up the fir-tree, and instead of the brier shall come up the myrtle tree,' seem to show that the predominant thought in the mind of the writer was that of the glorious fertility which the blessing of Jahweh should bring to His land.

The New Jerusalem, the description of which in the Apocalypse is largely based upon the Jewish imagery of the OT, is like a gorgeous palace blazing with metal and jewels, but it has no flowers. The 'never fading flowers' are a Christian addition to the Jewish conception of Paradise.

2. Græco-Roman.—When we turn from Hebrew to Greek and Roman literature, we find the appreciation of flowers hardly more developed. In Greek and Latin writers we find proofs of careful observation of natural scenes, but few or no traces of a sympathetic contemplation of flowers. They were constantly used as ornaments or decorations, and the prettiness of their form and colour was recognized; but, if we may judge from the literature which has survived, there was no appreciation of their glory and significance such as could inspire Wordsworth to write:

'To me the meanest flower that blows can give
Thoughts that do often lie too deep for tears.'

Theocritus and Meleager contain frequent references to flowers, but even they did not look upon them as beautiful in themselves. The only approach in Greek art to such an appreciation is in the acanthus leaves carved on the Corinthian columns; but this is conventionalized and reduced to a geometrical formula.

3. Christian.—It would be impossible to find in classical or in Jewish pre-Christian literature any parallel to the saying of Christ, 'Consider the

lilies of the field, how they grow' (Mt 6²⁸). This, and the further statement that not all the wealth of the world, or the gorgeous raiment which wealth might provide, could make a man as beautiful as a flower of the field, constituted a new revelation. It must have been startling, indeed, to His audience to hear one of their commonest flowers compared with the greatest of their kings, and to his disadvantage. How little the Jews and those to whom the words of Christ afterwards came were prepared to appreciate this teaching may be inferred from the fact that, although practically every other saying of Christ is commented on by early Christian writers, there is apparently no reference to these words for a thousand years after they were uttered. Many centuries were to pass before His followers could claim that they had obeyed this teaching of their Master.

In the 15th cent., when landscape painting was for the first time practised in Europe, flowers began to be introduced not merely as ornamental accessories, but as an integral part of the painting.

Although there is something artificial and unnatural in the conception of a flower garden, which is an attempt to idealize Nature, nevertheless the development of a taste for flower gardens may be regarded as a rough index of the development of an appreciation of the beauty of flowers. Bacon, in his essay 'on Gardens,' supplies a list of flowers which should be in bloom during each successive month of the year, and urges that the garden should be so ordered that 'things of beauty' should be always 'in season.' He recognizes that the love of gardening represents a higher ideal than the love of architecture. Thus he writes:

'God Almighty first planted a garden, and indeed it is the purest of human pleasures; it is the greatest refreshment to the spirits of man, without which buildings and palaces are but gross handiworks: and a man shall ever see that, when ages grow to civility and elegancy, men come to build stately sooner than to garden finely, as if gardening were the greater perfection.'

The artificiality which, after Bacon's time, characterized English and still more French gardens, was not unknown in his own time, for he writes: 'I for my part do not like images cut out in juniper.'

The modern appreciation of the beauty of flowers, which found expression in Goethe and Wordsworth, was an outcome of the general movement towards the appreciation of Nature and of natural scenery which dates from the Renaissance. The influence of Augustine and those who adopted him as their master had led men to associate evil with every form of matter, and made it difficult for them to regard it as a vehicle whereby the unwritten thoughts of the Creator might be expressed. One of the first English writers to express the latter idea was Thomson (1700-1748), who wrote:

There lives and works
A soul in all things, and that soul is God.
. . . not a flower
But shows some touch, in freckle, streak, or stain,
Of His unrivall'd pencil.'

Half a century later Wordsworth wrote:

'One impulse from a vernal wood
May teach you more of man,
Of moral evil and of good,
Than all the sages can.'

The mystic consciousness of the Divine message which plants and flowers have to give to those who can receive it, which Wordsworth possessed, has been shared by many who have written since his time.

4. Japanese.—Of non-Christian nations, whether in ancient or modern time, the Japanese possess by far the most striking appreciation of the beauty of flowers. Baron Hübner, contrasting the development of an appreciation of the beauty of flowers and of natural scenery in Europe with that found in Japan, writes:

'The Japanese are wonderful lovers of nature. In Europe a feeling for beauty has to be developed by education. Our peasants will talk to you of the fertility of the soil, of the abundance of water so useful for their mills, of the value of their woods, but not of the picturesque charms of the country. They are not perhaps entirely insensible to them, but if they do feel them, it is in a vague, undefined sort of way, for which they would be puzzled to account. It is not so with the Japanese labourer. With him the sense of beauty is innate.'

In the 9th cent. A.D. the Japanese Emperor Saga held garden parties during the flowering of the cherry blossoms, at which the literati of the day composed verses in honour of flowers.

At the present day some of the most important festivals observed in Japan are those connected with the blossoming of certain flowers. The cherry-blossom festival is preceded by that of the plum, and followed in succession by those of the peony, wistaria, iris, chrysanthemum, and maple. Every Japanese is familiar with the ode written by the poet Motoori in the 17th cent., of which a translation given by a Japanese is:

'Should any one ask me what the spirit of Japan is like, I should point to the blossoms of the wild cherry-tree bathing in the beams of the morning sun.'

The lotus is the flower specially associated with Buddhism and the spirit world, and the figure of Buddha is often represented as seated on a lotus flower. Lotus flowers made of gold or silver paper are carried at funerals, and tombs are decorated with them at the Festival of the Dead. Lotus leaves are also used to wrap the food offerings for the spirits of the dead.

The Japanese treatment of flowers proceeds on conventional lines. In every school a very large amount of time is devoted to the instruction of the scholars in the art of arranging flowers according to traditional rule. The standard by which they judge of the beauty of flowers is wholly different from that accepted in Europe, and seems to many Europeans highly artificial. The mass of blossoms present in a European bouquet would not convey any pleasing impression to a Japanese. They study the growth and habits of the plant which produces the flower, and pay great regard to stem, leaf, and bud, and to their balance and linear distribution. The art of flower arrangement is said to have been introduced into Japan in the 6th cent. A.D., and several Chinese priests are referred to in early Japanese works as teachers and exponents of this art in connexion with various religious ceremonies. The present style of flower arrangement was developed later, and was specially encouraged by a Japanese *shōgun* who lived in the 17th century. There is a good deal of symbolism involved in the choice and arrangement of flowers, and many weird superstitions, derived from Chinese philosophy and connected with good and bad luck, are associated with the arrangement and subsequent disposition of the flowers.

Although the Japanese are the most painstaking gardeners to be found anywhere in the world, flower gardens such as are common in Europe can hardly be said to exist. The Japanese garden is a landscape garden. For nearly five centuries Japanese artists have been studying and elaborating the rules for the formation of landscape gardens laid down by their predecessors, and with fascinating results. By a careful process of selection and cultivation, forest trees have been reduced to a fiftieth part of their normal size, so that their size may harmonize with the tiny garden in which they are to be planted. The object of these gardens is to reproduce the effect created in the mind of the spectator by an extensive landscape. The older landscape gardeners who are credited with introducing this art into Japan were Buddhists, and they endeavoured by their art to express in symbolic form ideas such as content, calm, and piety.

5. Chinese.—The Chinese cultivate market

gardens with laborious care, and are fond of constructing flower gardens in which bare rocks and ponds are the principal features. These do not, as a rule, contain any flower beds, but flowering plants are arranged in pots of various designs. Flowers grow throughout China in prodigal profusion, and the Chinese are specially fond of those which have sweet scents. They also use flowers and their artificial substitutes as ornaments to put in their hair, but they generally have little appreciation of flowers apart from their regard for them as ornaments or as providing sweet scents.

6. Hindu, etc.—In India, flower gardens are rare, though flowers are extensively used for making garlands to be worn on festive occasions or to show honour to strangers. As artificial flowers, however, are extensively manufactured and used for similar purposes, it can hardly be maintained that their use in this way by the peoples of India denotes any real appreciation of their beauty. The Rigveda consists of hymns addressed to Nature-gods; and in the Atharva, flowers are mentioned only in magic charms. In later Indian literature, however, lyric and dramatic poetry, as well as elegant prose literature, contains many allusions to flowers which evince a real love of them, just as in later Jewish literature there are repeated references to the beauty of the floral world (cf. the references in Blau's index to Böhtlingk's *Ind. Sprüche*, St. Petersburg, 1870-73; Löw's art. 'Plants,' in *JE*, and various artt. on individual flowers, e.g. 'Lily' and 'Rose,' in the same work). In Muhammadan Persia, flowers receive equal consideration throughout literature (cf. Philipp, *Beiträge zur Darstellung des pers. Lebens nach Mušlih-uddin Sa'di*, Halle, 1901, p. 5 f.), while even Pahlavi literature made each flower sacred to a godling (*Bund.* xxvii. 24 [*SBE* v. (1880) 103 f.]). Amongst the pagan races of Africa the traveller who stops to pick wild flowers, or who expresses any admiration for them, is in danger of being mistaken for a lunatic. In Micronesia and Polynesia, the attitude is different, for there flowers and garlands form an important addition to the toilet, and their beauty and perfume receive recognition (Waitz-Gerland, *Anthropologie der Naturvölker*, Leipzig, 1860-72, v. ii. 63, vi. 45, and authorities there cited).

LITERATURE.—Besides the literature mentioned in the art., see A. Biese, *Development of Feeling for Nature*, London, 1905.

CHARLES H. ROBINSON.

FETICIDE.—Destruction of the human embryo has not among any people become a social habit, as general infanticide has done among some modern primitive communities and among the ancient Greeks and Italians. Throughout history its prevalence has been sporadic. One section of a race may practise it, while another, though conterminous, may forbid it, and yet another may be stated to be ignorant of its possibility.¹ Its practice does not involve any high degree of knowledge, for the crudest methods of manipulation, coinciding at times with those accidents which produce natural abortion or miscarriage, are found among the lower races.² Nor does it, at any stage of culture, necessarily imply a depraved condition of sexual morality. As often as not—for instance, among the ancient Italians in many cases, and among many modern savage tribes—the sole reason is poverty. The crime thus is parallel in one aspect with infanticide and prevention of conception.

'The same considerations,' says Westermarck, 'as induce savages to kill their new-born infants also induce them to destroy the fetus before it has proceeded into the world from the mother's body.'³

¹ So in the East Indian Archipelago (J. G. F. Riedel, *De sluik-en kroesharige Rassen*, Hague, 1886, pp. 24 [Buru], 302 [Tenimber and Timorlaut]).

² *Ib.* 353.

³ *III* i. 413.

Besides the hardships of wild life and the intense struggle for existence in modern civilization, there are secondary reasons for the practice. A perverted diathesis may induce the mother to forgo the trouble of pregnancy, birth, and rearing.¹ More often it is in order to conceal illicit intercourse.² The length of the period of suckling, which may drive the husband to form other ties, is also a contributory factor. And the same reason applies when the mother has already a child at the breast.³

Whatever be the reasons operating to induce the destruction of a new life, the crime, as already noted, has nowhere and at no time been a social habit. The progressive evolution of culture involves the displacement of infanticide proper by fœticide, and in the last half century fœticide itself has been largely displaced by the artificial prevention of conception.

The social attitude towards the crime has followed a similar evolution. Rude indifference to child-murder has given place in advancing culture to abhorrence, while destruction of the unborn child was regarded as venial in comparison. The whole question of ethical valuation was complicated by the speculations of early animistic philosophy, which from the Greek period were applied to the elucidation of biological facts. Both the sentiment and the legislation, ecclesiastical and civil, of Western civilization have been largely influenced by the incidence of these ideas. A broad line, lastly, can be drawn between barbarian, classical, and Oriental ethics on the one hand and Christian on the other, with regard to the value attached to the unborn life and the rights of the individual over it.

Among the lower and the higher races alike the moral objection to the crime varies directly as the social consciousness of the duty of augmenting the birth-rate. Hence it may be laid down that infanticide and fœticide tend to decrease with the passage from a natural to an artificial method of subsistence. Where agricultural and pastoral culture are established, the importance of numbers is realized. In a secondary degree the objection varies inversely as the sexual morality, dependent upon the matrimonial system of any given people. Cases of mere luxury, as in pagan Greece and Rome, are of little significance. An example of the direct variation may be found in the early Hebrews; and of its modern form in the modern European peoples, including the Jews. Examples of the inverse variation may be seen in the Hindus and Muhammadans, where the results of the matrimonial system have overlaid the primary objection to fœticide.

Among semi-civilized peoples it is just possible to connect the existence of the moral objection with upward progress from the natural and precarious mode of subsistence. In Samoa, for instance, artificial abortion was very prevalent. Here there is possibly an indirect influence of sexual morality.⁴ The Dakotas did not regard it as a crime, though the generality of Indian tribes did so regard it.⁵ A good example is the case of the Kafirs:

'The procuring of abortion, although universally practised by all classes of females in Kafir society, is nevertheless a crime of considerable magnitude in the eye of the law; and when brought to the knowledge of the chief, a fine of four or five head of cattle is inflicted. The accomplices are equally guilty with the female herself.'⁶

As distinguished from infanticide, destruction

¹ *MI* i. 399, 413; Ploss-Bartels, *Das Weib*, Leipzig, 1902, i. 851 f.

² *Ib.*

³ Spencer-Gillen^a, 51, 264; ^b 608.

⁴ G. Turner, *Samoa*, London, 1884, pp. 79, 260.

⁵ H. Schoolcraft, *Indian Tribes*, Philad. 1853-57, iii. 243; Ploss-Bartels, i. 848.

⁶ Warner, in Maclean, *Compendium of Kafir Laws and Customs*. Mt. Coke, 1858, p. 62.

of the embryo involves no conflict with the instinct of maternal or parental love.

'Considering,' as Westermarck observes, 'that the same degree of sympathy cannot be felt with regard to a child not yet born as with regard to an infant, it is not surprising to find that fœticide is practised without objection even by some peoples who never commit infanticide.' He instances Samoa and the Mitchell Islands.¹

Fœticide is not referred to in the Mosaic law. The omission is one indication, among many, of the intense regard felt by the Jewish people for parenthood and the future of their race. Hinduism and Islām show an inconsistency between theory and practice.

'In a country like India . . . where six-sevenths of the widows, whatever their age or position in life may be, are absolutely debarred from re-marriage, and are compelled to rely upon the uncertain support of their relatives, it is scarcely surprising that great crimes should be frequently practised to conceal the results of immorality, and that the procuring of criminal abortion should, especially, be an act of almost daily commission, and should have become a trade among certain of the lower midwives.'²

Yet the old laws forbade it and classed it as murder, placing it in the same category as homicide, neglect of the Vedas, incest, and the drinking of spirituous liquor.³ It is one of the three acts which make women outcastes, the others being the murder of a husband or of a Brāhman.⁴ The myth of 'the wiping off' of sins' in the Atharvaveda denounces the abortionist, the *bhrūnahan*, whose name and crime end the lists: 'beyond him who has committed an abortion the sin does not pass.'⁵ Buddhism naturally included it in its denunciation of the destruction of any form or degree of life. The *bhikkhu* 'who intentionally kills a human being, down to procuring abortion, is no Samāna, and no follower of the Sakyaputta.'⁶

In Persia, according to Polak, abortion is regularly practised to prevent illegitimate births; and legislation ignores the crime.⁷ In Turkey there is the same indifference, and the practice is not uncommon.⁸

The Avesta theorizes on the date at which the embryo becomes animate, and its condemnation of fœticide is detailed.

'"That man does not follow the way of the Law, O Zarathushtra, who commits the Baodhōvaršta crime with a damsel and an old woman," said Zarathushtra.'⁹ Describing the crime, the *Vendidād* (xv. 13 ff.) says that, if a maid who is with child unlawfully tells her lover, 'I have conceived by thee,' and he replies, 'Go then to the old woman and apply to her for one of her drugs, that she may procure thee miscarriage,' and the old woman brings some *banga* or *shaeta*, that kills in the womb or expels the fetus, and the man says, 'Cause thy fruit to perish,' 'the sin is on the head of all three.'

The penalty was that for wilful murder. When a woman has been pregnant for four months and ten days, the child is formed and a soul added to its body.¹⁰ The uttering of a charm is also frequently a factor, for ideas of magic naturally intrude even in such practices as this. Similarly the Greenlanders supposed that an abortion was transformed into an evil spirit, *angiaq*, which avenged the crime.¹¹

In his eugenic proposals, Plato recommends that no child be suffered to come to the birth when the parents have passed the age assigned for procreation.¹² Aristotle, carrying on the Hellenic traditional objection to the existence of imperfect or deformed children, recommends abortion before the fetus is animate, in cases where the mother has

¹ *MI* i. 413 f.

² Chevers, *Report on Medical Jurisprudence in the Bengal Presidency*, Calcutta, 1854, p. 712.

³ *Sacred Laws of the Aryas* (*SBE* ii. [1897] 74, 281).

⁴ *Ib.* (*SBE* xiv. [1882] 183); see *Laws of Manu* (*SBE* xxv. [1886]), v. 90.

⁵ *Hymns of the Atharvaveda* (*SBE* xlii. [1897] 165, 521).

⁶ *Vinaya Texts* (*SBE* xlii. [1881] 235).

⁷ Polak, *Die Persien*, Leipzig, 1865, i. 217.

⁸ Ploss-Bartels, i. 846.

⁹ *SBE* xlii. [1883] 335.

¹⁰ *SBE* iv. [1895] 177 ff.

¹¹ Rink, *Tales and Traditions of the Eskimo*, Edinburgh, 1875, pp. 45, 439 f.

¹² Plato, *Rep.* v. 460 f.

already given birth to the number of children enjoined by the State.¹ Under the Roman Empire the practice of foeticide was carried on for reasons of poverty, sensuality, or luxury. Seneca speaks of it as practised by fashionable women in order to preserve their beauty.² Lecky concludes:

'It was probably regarded by the average Romans of the later days of Paganism much as Englishmen in the last century regarded convivial excesses, as certainly wrong, but so venial as scarcely to deserve censure.'³

An attempt was made by the Antonines to prevent the loss of children consequent upon the practice.⁴

Greeks and Romans made a commencement of speculation as to the biological value of the embryonic life. Distinguishing sharply between foeticide and infanticide, they put it that the unborn child was not *homo*, not even *infans*, but merely a *spes animantis*. It was regarded, not incorrectly, as merely a part of the mother, as the fruit is a part of the tree until it falls.⁵

Christian philosophy, and consequently Christian legislation, applied from the first 'the healthy sense of the value and sanctity of infant life which so broadly distinguishes Christian from pagan societies'⁶ to this more subtle form of infanticide.

'Prevention of birth,' asserts Tertullian, 'is a precipitation of murder; nor does it matter whether one take away a life when formed, or drive it away while forming. He also is a man who is about to be one. Even every fruit already exists in its seed.'⁷

Empirical knowledge was combined with Aristotle's doctrine to establish a theory of embryonic animation. This, of course, is to be distinguished from 'quickening,' which may commence some hundred days after conception. Aristotle held that the soul of the zygote at conception was the vegetative only, that after a few days it was informed by the animal soul, and later by the rational. His followers distinguished between the male and female embryo in the date of animation. The male was regarded as being animated forty days after conception, the female eighty days. Later the moment of animation was fixed for both sexes at the fortieth day. The Roman jurists adopted the latter view.⁸ The general distinction between the animate and the inanimate foetus was clearly held by Canon and Roman Law alike, and lasted to modern times. It was applied in practice by Augustine thus:

The body is created before the soul. The embryo before it is endowed with a soul is *informatus*, and its destruction by human agency is to be punished with a fine. The *embryo formatus* is endowed with a soul; it is an animate being; its destruction is murder, and is to be punished with death.⁹

Throughout the Middle Ages women guilty of the crime, which, however, was of rare occurrence, were condemned on the capital charge, as the Sixth Ecumenical Council had ordained.¹⁰

There was to the theory a natural corollary that the *embryo formatus* required to be baptized if it would be saved. Augustine held that the embryo might share in the resurrection.¹¹ Fulgentius argues:

'It is to be believed beyond doubt that not only men who are come to the use of reason, but infants, whether they die in their mother's womb or after they are born, without baptism in the name of the Father, Son, and Holy Ghost, are punished with everlasting punishment in eternal fire, because, though they have no actual sin of their own, yet they carry along with them the condemnation of original sin from their first conception and birth.'¹²

¹ Pol. vii. 16. 1335.

² Digesta, xxv. 3, 4; Seneca, *ad Helviam*, 16.

³ Lecky, *Hist. of European Morals*, London, 1890, ii. 21 f.

⁴ Digesta, xlvii. 11-14.

⁵ Spangenberg, in *Neues Archiv des Criminalrechts*, ii. 22 f.

⁶ Lecky, ii. 23.

⁷ *Apol.* 9.

⁸ O. Coppens, *Cath. Encyc.*, 1907 ff., art. 'Abortion'; Spangenberg, ii. 37 ff.

⁹ *Quæst. in Ez.* 80; *Quæst. Vet. et Nov. Test.* 23.

¹⁰ Spangenberg, ii. 16; Coppens, *loc. cit.*

¹¹ *De Civ. Dei*, xxii. 13.

¹² *De Fide*, 27.

Aquinas, however, was of opinion that infants dying before birth might perhaps be saved.¹ Meanwhile some Councils made no distinction between the periods of gestation, and condemned all foeticide as murder.²

Interesting variations of opinion are found as to the right of abortion. Plato and Aristotle held that the mother possessed the right. The Stoics held that the foetus was merely the fruit of the womb, and that the soul was not acquired until birth. The Roman theory and practice were in many points far from clear, but the view prevailed that the father alone had the right to order abortion.³

As early as the 4th cent., Gregory of Nyssa had evolved a theory anticipatory of Neo-Vitalism. He held that one and the same principle of life quickened the new organism from the first moment of its individual existence, and that, instead of the organism developing the life, the vital principle built up the organism.⁴

Modern biology holds that the zygote is a new individual from the moment, not of 'conception' in the vague and popular sense, but of penetration of the ovum by the spermatozoon. Modern legislation holds much the same view, but is less severe upon foeticide than upon infanticide. Popular sentiment has always tended to regard the life of the embryo as less sacred than the life of the infant. Modern Papal Bulls condemn criminal abortion as unlawful, and punish it with excommunication.⁵ Ecclesiastical influence had, until the 18th cent., been predominant in exacting extreme penalties against the practice. The humanitarian movement succeeded in abolishing the penalty of death.⁶ Apart from the Papal tribunal, modern legislation punishes the crime with imprisonment. Medical practice

occupies a position midway between that of the classic lawyers and that of the later Christian ecclesiastics. It is on the whole in favour of sacrificing the foetus whenever the interests of the mother demand such a sacrifice. General medical opinion is not, however, prepared at present to go further, and is distinctly disinclined to aid the parents in exerting an unqualified control over the foetus in the womb, nor is it yet disposed to practise abortion on eugenic grounds. . . . Society itself must assume the responsibility of protecting the race.⁷

In medical circles there has recently been considerable discussion, which Ellis has analyzed in a valuable summary,⁸ on the ethics of the question. One aspect of this is a return to the Greek view that the right of deciding upon the operation rests with the mother. Thus, though

'alike on the side of practice and of theory, a great change has taken place in the attitude towards abortion, it must, however, clearly be recognized that, unlike the control of procreation by methods for preventing conception, facultative abortion has not yet been embodied in our current social morality.'⁹

The practice is said to be 'extremely common' in England, France, Germany, and the United States.¹⁰ Perhaps this estimate is too high. In France, at least, there is a tendency on the part of the law towards leniency, only professional abortionists, as a rule, being punished.

As for the eugenic aspect of the question, it can hardly be separated from the social.

'Whenever,' says Balestrini, 'abortion becomes a social custom, it is the external manifestation of a people's decadence, and far too deeply rooted to be cured by the mere attempt to suppress the external manifestation.'¹¹

Ellen Key argues that a civilization which permits the slaughter of its carefully selected adults in war has not yet won the right to destroy deliberately even its most inferior vital

¹ Quoted by Lecky, *Hist. of Rationalism*, London, 1865, l. 360, n. 2.

² Coppens, *loc. cit.*

³ R. Balestrini, *Aborto*, etc., Turin, 1888, p. 30 f.

⁴ Quoted by Coppens, *loc. cit.*

⁵ Coppens, *loc. cit.*; H. von Fabrice, *Die Lehre von der Kind-abtreibung und vom Kindsmord*, Erlangen, 1868, pp. 199, 206 ff.; Spangenberg, ii. 178 ff.

⁶ H. Ellis, *Studies in the Psychology of Sex*, vi. [1910] 606.

⁷ H. Ellis, *loc. cit.*

⁸ *Ib.* 605-612.

⁹ Ellis, 610.

¹⁰ *Ib.* 602 ff.

¹¹ *Op. cit.* 191.

products in the womb. . . . The blind and aimless anxiety to cherish the most hopeless and degraded forms of life, even of unborn life, may well be a weakness, and, since it often leads to incalculable suffering, even a crime. But . . . before we are entitled to take life deliberately for the sake of purifying life, we must learn how to preserve it by abolishing such destructive influences, war, disease, bad industrial conditions, as are easily within our social power as civilized nations.¹

Ellis well observes that 'the necessity for abortion is precisely one of those results of reckless action which civilization tends to diminish.'² The observation includes the abortion which is necessary for the saving of a mother's life, and the various applications of the practice by the licentious and depraved.

LITERATURE.—There is an extensive modern literature, periodical and polemical, but the works cited in the article fully refer to it.
A. E. CRAWLEY.

FOLKLORE.³—1. Definition and scope.—Folklore⁴ consists of customs, rites, and beliefs belonging to individuals among the people, to groups of people, to inhabitants of districts or places; and belonging to them apart from and oftentimes in definite antagonism to the accepted customs, rites, and beliefs of the State or the nation to which the people and the groups of people belong. These customs, rites, and beliefs are mostly kept alive by tradition, that almost universal desire to carry on without alteration what one's parents or predecessors performed or professed. They owe their preservation partly to the fact that great masses of the people do not belong to the civilization which towers over them and which is never of their own creation; partly to certain of the people being isolated from centres of thought and culture. Some beliefs, but no customs or rites, are due to those persons or generations of persons who, being peculiarly stunted in their mental equipment, are unable to understand the phenomena of nature or the results of civilization. We may classify these two distinct branches of folklore as *traditional* and *psychological*.

2. Materials.—The tradition-founded customs, rites, and beliefs constitute by far the larger mass of the folklore which has been collected and published in almost every country in Europe. Psychological beliefs are much rarer. Unfortunately, the two groups have never been kept separate from each other even by students of folklore, and arguments based upon a belief which is wholly of psychological origin may be entirely fallacious and misleading unless it is used strictly in accord with its position in folklore classification.

It is obvious that tradition may carry us very far back into the past, and indeed it is one of the facts of traditional folklore, which is the most generally claimed and understood, that almost invariably research leads the investigator to the very earliest phases of racial and social life. Psychological folklore, on the contrary, relates only to the present, or rather to the period contemporary with the existence of the belief. This contrast is fundamental, but it does not entirely separate the two classes. The investigator is met with a phenomenon of peculiar significance, namely, that research into psychological folklore leads not only to the genesis of each particular belief which comes under that head, but thence by analogy to the best explanation of the genesis of all belief. The unity of folklore exists in its origins. The

¹ *Century of the Child*, New York, 1900, ch. I., summarized by Ellis, 610.

² *Op. cit.* 611.

³ The purpose of the present article is to fix the definition and scope of folklore, and to indicate generally the materials for study, their historical value, and their scientific treatment. Details will be found in the various articles on peoples and religions.

⁴ The word 'folklore' was coined by William John Thoms (a well-known antiquary and the founder of *Notes and Queries*) in a letter which appeared in the *Athenæum*, 22nd Aug. 1846.

differences exist in the results which are derived from it.

Always bearing in mind these two wholly distinct branches into which folklore is naturally divided, the next consideration must be given to a fair understanding of the constituent elements of each branch—custom, rite, and belief in the traditional branch; belief in the psychological branch.

(1) *Custom* in folklore occupies a very large space. It embraces all those observances, local and personal, which are carried on by the sanction solely of continued observance—untouched by a rite, unconnected with a belief, simply and solely customs, personal, family, local, racial in their attachment. Examples of custom thus defined will best explain the distinctions. Of personal customs one of the most interesting is the mother's custom at Carrickfergus, where, when giving her child the breast for the last time, she put an egg into its hand and sat on the threshold of the outer door with a leg on each side. Here is pure custom performed according to the demands of traditional usage and with no traditional reasons for its performance. Of family customs the best examples in this country come from the North, where the influence of certain families is still very strong, as, for instance, in the island of Argadia off Argyllshire, where we have the record of the people swearing by the hand of Callum More. A custom belonging to the family of Holt of Aston-juxta-Birmingham is worth quoting in detail. It took place on the 24th December in each year:

'On this day, as soon as supper is over, a table is set in the hall; on it is set a brown loaf, with twenty silver threepences stuck on the top of it, a tankard of ale, with pipes and tobacco; and the two oldest servants have chairs behind it, to sit in as judges if they please. The steward brings the servants, both men and women, by one at a time, covered with a winnow-sheet, and lays their right hand on the loaf, exposing no other part of the body. The oldest of the two judges guesses at the person, by naming a name; then the younger judge, and, lastly, the oldest again. If they hit upon the right name, the steward leads the person back again; but, if they do not, he takes off the winnow-sheet, and the person receives a threepence, makes low obeisance to the judges, but speaks not a word. When the second servant was brought, the younger judge guessed first and third; and this they did alternately till all the money was given away. Whatever servant had not slept in the house the previous night forfeited his right to the money. No account is given of the origin of this strange custom, but it has been practised ever since the family lived there. When the money is gone, the servants have full liberty to drink, dance, sing, and go to bed when they please' (*Gentleman's Magazine*, 1795 (1), 110).

Elsewhere family customs are chiefly connected with land, manorial tenures, and semi-legal cases, many of which belong to the oldest periods of our history and deserve very careful examination from the folklore point of view. Thus, when the rector of Ruan Minor in Cornwall claims his right, by ancient usage and prescription, of sending a horse into a certain field in the parish of Landewednack whenever it is cropped with corn and taking away as many sheaves as the horse can carry on its back, he is performing a custom which certainly comes from times when lands were held in common and not in severalty. Of local customs the best examples are municipal. The Lord Mayor's show in London is carried on as a traditional custom. It is never questioned, and people would oppose its abolition; nevertheless, it represents features in the history of the great city which are older than English history. And so with the Godiva ceremony at Coventry, the Shrewsbury ceremonies, and many other places which have their own special customs. Racial custom is a much more difficult question to describe or to illustrate. Yet it exists. The roaming habits of the gypsies afford the most obvious example. These people stretch across the whole area from India to Western Europe, always preserving their custom of living in tents and not sleeping in a fixed habitat, and

always observing their own code of life. Besides these curious people every country has its local race-types differing from the dominant race. Thus in our own country, the people of Tacumshane in Ireland could not speak Irish, but had a language of their own which was Chaucerian English; they intermarried amongst themselves, dressed in their own colours, brown and yellow, and never departed from their own customs. Connaught has always had local racial groups in its mountain ranges. The Highlands of Scotland present the same characteristics, and the Borderland was long known as the occupation ground of people whose law was the custom of their ancestors, not the legislation of the State. In Wales down to 1852 there are records of a curious red-haired race called Cochion, who lived by rules of their own and did not intermarry with the surrounding folk. In Cornwall there is the well-known example of the Gubbin people, of whom there exist notes dating from the 17th century. These examples are special cases of race survival; but all over the country, when for amusement or from inherited custom we admit to our house a first foot on New Year's morn, who can be only a dark man or only a fair man, as the case may be, but never a woman, we are reverting to a racial custom.

(2) Passing from custom to *rite*, there appears for the first time the touch of a religious sanction. The farmer who rescues his cattle from disease by burying a dead calf at the entrance of the cattle-shed is performing a personal rite of religious significance. The Manx cottager who looks for traces of a foot in the ashes of his fire-grate for the purpose of seeing in what direction the toes point—if to the door, signifying a death; if to the fire-place, a birth—is performing a family rite of religious significance. The 'oblations to the white bull' of Bury St. Edmunds was a local rite of religious significance. The rites of witchcraft are racial rites of religious significance.

(3) Finally, in the division of *belief*, there are the same main features. Over and over again in traditional belief individuals will retain in memory and in form beliefs which they personally entertain, and which may not be generally accepted. So, too, there are family beliefs some of which are of such special character as to contain many of the characteristics of totemism; for example, the famous case of the Irish clan Coneely, who believe in their descent from a seal, will not kill a seal, and are named from the seal. In local beliefs there is the significant feature of differentiation in the objects of belief in closely contiguous places.

But the section of belief has an important branch of folklore belonging to it which does not belong to the other sections, namely, the *Märchen*, the folk-tale or the nursery tale, which, found all over Europe and in India, has led to much discussion as to origin and significance. Folk-tales are the myths of the race. Myths are the accounts which the science of pre-scientific ages gave of phenomena which could not be understood except by such accounts as early knowledge and observation would allow. If myths accounted for the origin of mankind, of the sun, moon, and stars, of the earth and trees, they accounted for them as creations of higher powers than man. The story into which the myth is woven is not a story to those who believe in the truth of the myth. It assumes the personal shape because the personal is the only form in which the early thought of mankind can be expressed. It lived on by tradition, because of its original sacred character, and the impossibility of altering a once firmly established myth. All research into myth confirms this view of its origin among primitive peoples. Among the higher

barbaric peoples the same process of explaining phenomena which were not understood went on, and Greek myth has come to us as the Greek explanation of temple-rites and ancient worships which did not command the reverence of the Greeks but which demanded explanation. In their hands all religious conception developed, and the gods of Greece became the gods of moral principle, the gods of law and order, the gods of political and social progress—mythic gods all through, but gods very real to the Greek in the earliest stages of his development.

3. Historical value.—If this survey of the materials of folklore suffices to explain in general terms what the subject-matter is with which the folklorist has to deal, it will also have indicated to the student that tradition, being the sanction of folklore, carries a weight of evidence for the past which is scarcely second in value to the historical record. History never has pretended to contain every human fact occurring at a place, on an occasion, in connexion with a personage or a people. And very often, where the historical record is faulty, the traditional record may be relied on to fill up the vacuum. Myths are not created out of nothing. A 'mere' myth, which is an expression often used by those who are not folklorists, does not exist, if by that expression is meant a story or account invented out of nothing, a mere fantasy or fiction. Myth is definitely and distinctly not fiction. It is always the covering, the shell, to a kernel of truth contained inside. It may be difficult, or impossible, to get at the truth. One authority will argue for one explanation, and others for quite different explanations; but, because modern scholarship is out of touch with primitive science or with religious accounts of forgotten ritual, it does not do to relegate the whole subject to the waste-paper basket. Scholars should frankly confess an inability to explain, and leave the subject there, perhaps for more successful efforts by future generations.

4. Scientific treatment.—The custom, rite, and belief, which are properly called folklore, are to be found embedded in civilization—they are, as we have seen, the unrecorded factors of that civilization at its earlier stages. For this reason they are capable of comparison, first, with parallel customs, rites, and beliefs embedded in civilization of practically the same standard (as when we compare British folklore with the folklore of France, Germany, Italy, Scandinavia, the Slav countries, and the Hindus), or of a wholly different standard (as when we make the comparison with Chinese or Mongolian folklore). Secondly, they are comparable with parallel custom, rite, and belief which are alive at this day as the ordinary custom, rite, and belief of a tribe or race of barbaric or savage peoples. Savage custom, rite, and belief are sometimes classed as folklore simply because they are capable of such close comparison with folklore, but this is obviously wrong, and only raises inconvenient issues as to the regions respectively occupied by folklore and anthropology.

The question of comparative folklore raises very difficult problems. It is not scientific to lift a custom, rite, or belief, a myth, or a *Märchen* from its civilized surroundings and compare it with the living custom, rite, or belief of savages, without first of all understanding what the elements of comparison are. A belief found among the peasantry of modern Europe may well be compared with a belief recorded of the classical countries, or of the Hindus or Persians. There is solid groundwork to start from in the common origin of the religious institutions of these peoples. But there is no such groundwork when the comparison is with modern savage people. It may mean that

the traditional belief discovered in folklore belongs to a stage of culture as low as that of the savage with which it compares, and that this stage of culture survives in modern civilization together with the physical types of a people to whom it belongs. Beddoe insists that types of Palæolithic and Neolithic folk survive in Britain, and European ethnologists advance the same evidence in respect of other countries. These folk could have brought their culture along with them; their descendants could have carried it on and could have passed it on to other individuals. Different degrees of ethnic evolution must be considered in the work of comparison, and it is useless to go on piling up examples of parallel beliefs, rites, and customs without examining the direction in which such parallelisms are leading the inquirer.

The work of the folklorist is and must be arduous for years to come. Those who collect, as the older antiquaries collected, without comment or with such comment as needs no corrective, are supplying the bricks for the edifice which will one day assuredly be erected. The work of analysis, classification, and comparison must follow, not precede, the life-history of each item of folklore. Just as in philology the life-history of each word can alone be the basis of the science of language, so in folklore the life-history of each item of folklore can alone be the true basis of the science of tradition. The work is being gradually accomplished under both heads, and it will lead to a consideration of early national history which has not yet been attempted.

Custom, rite, and belief—these elements of folklore constitute a very recognizable phase in the religious and social life of the people of the country where they are found. It is, however, a non-Christian religion and a non-political society to which this folklore belongs, and the conclusion is inevitable that it must also be pre-Christian and pre-political. This brings us to a period, if not to a date, for the originals from which folklore has survived. It must never be forgotten that survivals are not the originals. Bits of the originals will have been broken off, sometimes to perish altogether, sometimes to exist as an independent item. Originals will have become timeworn, will, in their encounter with the State religion and the State polity, have become altered in form, if not in *motif*, will perhaps have attached themselves to a new phase of the people's life; and the wear and tear, the alterations, the new attachments, will prevent the true interest of the survival from being discovered. All these matters the folklorist has to study and prepare for, but it is for a great historical purpose. All the custom, all the rite, all the belief surviving in the folklore of a people, make up a considerable chapter in the pre-history of that people, are indeed the only material which exists for the pre-history outside the geological and the archaeological record. Later periods in the historical range are no doubt reflected in folklore. The post-Roman Celtic period in Britain is the strongest case. The Arthur cycle has gathered to itself whole volumes of myth. It is strange that the greatest of all English kings, Alfred the Great, should have been able to attach so little of myth to his life—perhaps it is because that life was so very great. It is not strange that Hereward the Saxon chieftain should have gained a place in English myth. But these heroes of historic times do not create new myths. They have transferred to them ancient myths, myths formerly belonging to ancient gods or ancient heroes. And so we come back to the proposition that folklore is the traditional fact of pre-historic life in contradistinction to history, which is the recorded fact of State or national life. This is a great claim on

behalf of folklore, but it is a claim which must assuredly find its way into the scientific study of nations and peoples.

LITERATURE.—I. COLLECTIONS.—J. Brand, *Popular Antiquities*, ed. Hazlitt, London, 1870; W. Henderson, *Folklore of Northern Counties of England*, do. 1879; W. Gregor, *Folklore of North-East of Scotland*, do. 1881; C. S. Burne, *Shropshire Folklore*, do. 1883-86; J. F. Campbell, *Popular Tales of the West Highlands*, Edinburgh, 1860-62; A. B. Gomme, *Traditional Games*, London, 1894; F. A. Steel and R. C. Temple, *Wideawake Stories*, Bombay, 1884; M. S. H. Stokes, *Indian Fairy Tales*, London, 1880; M. Frere, *Old Deccan Days*, do. 1881; the publications of the Folklore Society (1878 to present time).

II. SCIENTIFIC WORKS.—W. Grimm, *Deutsche Mythologie* (Eng. tr. *Teutonic Mythology*, London, 1880-88); J. Rhys, *Celtic Heathendom*, do. 1888, and *Celtic Folklore*, Oxford, 1901; A. Nutt, *Legend of the Grail*, London, 1888; E. S. Hartland, *Legend of Perseus*, do. 1894, and *Science of Fairy Tales*, do. 1891; W. R. S. Ralston, *Songs of the Russian People*, do. 1872; G. L. Gomme, *Folklore as an Historical Science*, do. 1908; A. Lang, *Custom and Myth*, do. 1884; E. Clodd, *Myths and Dreams*, do. 1885, and *Tom Tit Tot*, do. 1898.

G. L. GOMME.

FOOD.—Not only from the physiological but also from the sociological point of view, food, the food-quest, the food-supply, constitute the permanent basis of human action. Food, as Thorold Rogers observes, is 'the raw material of labour'; it is also the raw material of the social system itself. 'Even in the highest stages of civilisation, all wealth can be ultimately resolved into the elementary form of food.' 'The provision of food is the primitive form of labour; its accumulation is the primitive form of wealth.'¹

In religion and morality this relation is, of course, more or less indirect; but, more than any factor of life, man's meat even here is largely realized in direct relation. The beginnings of the moral law are based on food-tabus; religion culminates in a divine meal.

The best distinction between uncivilized and civilized society is that drawn by Payne. It consists in 'the substitution of an artificial for a natural basis of subsistence.'²

'Man adopts the practice . . . of saving for future consumption a portion of certain periodically recurring food-supplies; and from providing for that portion of the year during which the food-supply ceases he advances to providing for years of scarcity. Food thus accumulated obviously enables its possessor to employ his own labour and that of others, in some other way than food-provision. The food-surplus, therefore, is the foundation of all non-food-producing labour; and advancement is always marked by a progressive increase in the quantity of non-food-producing labour, and by the multiplication of the forms which labour of this description assumes. . . . But the method of procuring food from natural sources alone is toilsome and extremely uncertain.'

The next step, the provision of food by artificial means, is

'effected by the simple expedient of not only abstaining from some portion of the food-surplus, but converting the portion abstained from into a fresh source of increase. Instead of being merely stored, seeds or roots are allowed to fructify in the earth, and the captured young of animals are allowed to grow to maturity and become the progenitors of others.'³ But, 'while all artificial production is favourable to advancement, the animal and vegetable species to which it is applied are favourable to it in unequal degrees. Their value in this respect appears to be measurable by two different standards, by the recompense which they return to labour, and the stimulus which they give to ingenuity. When this principle is broadly applied to the two divisions of food-animals and food-plants, the result appears to be that, while the domestication of animals yields the greatest immediate return, the culture of the food-plants gives ingenuity the greatest stimulus.'⁴ The full effect on progress is found only when cereal cultivation is combined with animal breeding. 'When this takes place, progress is accelerated, as it were, in a compound ratio.'⁵

I. Food-stuffs.—The division of economic progress into the hunting, pastoral, and agricultural stages is untenable. But certain backward peoples are chiefly fruit-eating or pastoral or hunting. As for animal food-stuffs, apart from fish and game (the natural supply), the distribution of animals capable of artificial propagation varies. The

¹ E. J. Payne, *Hist. of the New World called America*, Oxford, 1892, I. 280.

² *Ib.* 276 ff.

³ *Ib.* 284.

⁴ *Ib.* 280 ff.

⁵ *Ib.*

largest number is possessed by the Old World; America, before introducing supplies, had but few, Australia none. The ox, horse, ass, sheep, camel, goat, and pig are the most important. The reindeer, llama, and paco are exceptional cases.

All vegetable food-species are capable of artificial increase. Their three main divisions are fruits, roots, and cereals. Payne¹ notes that fruits take the lowest, roots the intermediate, and cereals the highest position, in reference to the order of adoption, to the amount of labour involved, both for fitting them for consumption and for converting them from a natural to an artificial basis, to their value relatively to bulk, and to the degree in which their culture assists progress. For example, 'fruit-eating savages surfeit themselves in the fruit season and are near starvation for the rest of the year.'²

Though man naturally seems to prefer flesh-meat to all other forms of sustenance, owing to its stimulating properties,³ the slight use of it in hot countries is probably not a primitive habit, but one enforced (like abstention from alcohol) by a long process of adaptation to climate; yet a composite diet alone has formed the foundation of the greatest advance.⁴ In particular, as Payne observes,

'nothing worthy the name of civilisation has ever been founded on any other agricultural basis than the cereals. This appears to be largely due to the fact that the seeds of the cereal grasses are, as compared with fruits and roots, extremely rich in albumen and albuminoids, the great nourishers of the muscular and nervous systems.'⁵

2. Food-preparation.—Methods of cooking are naturally even more numerous than the substances employed for human food. But the principles of cookery reduce themselves to roasting and boiling. Direct exposure to fire is universally employed; gradually it gives place to the oven. But many backward peoples use a simple form of oven, such as a hole in the ground banked with hot stones. The method of *boucan* or *barbecue*, by which food is smoked for preservation, is common in barbarism.⁶ Tylor has argued that stone-boiling generally preceded pot-boiling. Red-hot stones are placed in a vessel of water until it is hot enough to cook the meat. 'So instantly,' however, 'is the art of stone-boiling supplanted by the kettles of the white trader, that, unless perhaps in the northwest, it might be hard to find it in existence now.'⁷ Goguet's theory of the origin of the art of pottery is connected with this development.

Three types of the evolution of the processes of food-preparation, which are not necessarily continuous, may be selected—the savage, the Hindu, and the modern French. The last is æsthetic, the second is religious, but each has reactions upon the social consciousness, just as each is an expression of it.

¹ *Hist. of the New World*, 302. *Ib.* 303.

² Flesh, according to the *Satapatha Brāhmaṇa*, is the best of foods (*SBE* xlv. [1900] 119).

³ Among the central Australians 'everything which is edible is used for food' (Spencer-Gillen^a, 21); roots are eaten raw or roasted in ashes; flesh is cooked in pits. The seeds of various plants, especially of wild legumes, the witchetty and other grubs, are only some of the many foods (*ib.* 22 f.). The men chiefly occupy themselves in hunting game, wallabies, and various small animals; the women search for grub and seed-food (*ib.* 32). In North-West Central Queensland seed-food is *pap-pa*; it is eaten either raw or roasted in damper form. The edible roots, yams, are eaten roasted or raw. Any fruits are eaten. Honey or 'sugar bag' is a favourite article. Insects and grubs, ants and caterpillars are eaten, raw, or dried, or roasted. Frogs, lizards, and snakes, fish, and particularly mussels, form a large item. Emus, pigeons, bandicoots, opossums, and kangaroos are caught by the men. Roasting in ashes and baking with hot stones are the two chief methods of cooking (W. E. Roth, *North-West-Central Queensland Aborigines*, Brisbane, 1897, pp. 92-104).

⁴ *I.* 319.

⁵ E. B. Tylor, *Early History of Mankind*², 1870, p. 263 f.

⁷ *Ib.* 266.

As a culmination of social feeling in the alimentary sphere, applied in everyday life, as distinguished from occasions of critical sacredness, the ritual of the Hindu kitchen and of Hindu meals is significant.

'The kitchen should always be on the south side and should run the whole width of the building. This is the most sacred part of the whole house, and persons of a lower caste than the household are never allowed to enter it. . . . The kitchen is partly a cooking place, partly chapel, and partly dining room.'¹ 'The mere glance of a man of inferior caste makes the greatest delicacies uneatable, and if such a glance happens to fall on the family supplies during the cooking operations, . . . the whole repast has to be thrown away as if poisoned.'² Cf. also art. Food (Hindu).

The preparation of cereal food calls for some description. Payne distinguishes seven stages, viz. green corn torrefied; ripe corn pounded into a paste; corn steeped and boiled—the usual method with rice; meal boiled in water (this porridge is the 'favourite food of advanced barbarism'); paste in thin cakes grilled—the *tortilla* of Mexico, griddle-cakes; paste in thin cakes baked (this is the unleavened bread 'universal in early civilisation'); finally, leavened bread.³

Numerous folk-customs cluster round the care of food and its preparation. Food, according to Zoroastrian teaching, must not be thrown away to the north at night.⁴ European peasants still regard with horror the throwing of bread into the fire. The ancient Hindu theory was that the remains of food are impure.⁵

3. Food-law and tabu.—The physiological dependence of life upon nutrition is recognized throughout the entire history of human law and custom. Food is the first form of human property. The restrictions placed upon the younger and weaker members of a society in this respect no doubt may be regarded as the first of all human laws.

Among the Australians the younger members of a tribe are subject to a variety of food-restrictions, from which they are gradually released with age.⁶ In the Euahlayi tribe the *wunnarl*, or food-tabu, was taken off a different kind of food at each *Boorah*, until the youth was at last old enough to eat what he pleased.⁷ In the Warramunga tribe a man is usually well on in middle age before he is allowed to eat wild turkey, bandicoot, and emu.⁸ There is little doubt that the ultimate object of these restrictions is partly to reserve the best foods for the older members,⁹ and partly to prevent shortage.

An early type of economic co-operation may be illustrated from the Australian natives. Each individual, until a certain age, is forbidden to eat, though not to kill, a list of animals tabued to each of the four marriage-classes. The husband, for example, lives on articles different from those eaten by his wife; both of them eat foods which their children are forbidden to touch. Thus, as Roth points out, a proper distribution of the total quantity of food available for a community is secured; and, whereas in Europe the more children there are to feed, the less goes to the parents, here the number of children makes no difference in minimizing the parents' supply.¹⁰ In Central Australia it is the function of the men of a parti-

¹ J. E. Padfield, *The Hindu at Home*, Madras, 1896, p. 18.

² M. Monier-Williams, *Brahmanism and Hindūism*⁴, London, 1891, p. 128.

³ Payne, *I.* 302 f.

⁴ *SBE* v. [1880] 318.

⁵ *Ib.* i. [1900] 18, xlv. 446.

⁶ Westermarck, *MI* ii. 319, quoting authorities.

⁷ K. L. Parker, *The Euahlayi Tribe*, London, 1905, p. 23. Here, as elsewhere, the tabu is removed by bringing the youth and the food into forcible contact. His father made him lie on the first emu he killed, before it was cooked. Then the fat was rubbed on the boy's joints, and a piece of the flesh was placed in his mouth (*ib.* 24).

⁸ Spencer-Gillen^b, 612.

⁹ As Spencer and Gillen hold (^a 470 f., ^b 613).

¹⁰ Roth, 57, 70.

cular totem to perform *intichiuma* ceremonials, the object of which is to secure or increase the supply of the animal or plant which is their totem. Meanwhile the principle is that the food-species of a totem belongs to members of another totem. Magic and co-operation are here in perfect alliance.¹

Though all wealth is ultimately reducible to terms of food, it is an interesting fact that civilized altruism tends to minimize and partially condone offences against property in this form.

'No Chinese magistrate would be found to pass sentence upon a man who stole food under stress of hunger.'² Similar tendencies are seen in Islām, Hinduism, Hebraism, and Christianity. The Canon Law says: *necessitas legem non habet*. Even of lower stages the same is sometimes true, as among the Fjort of West Africa, the Tahitians, the Mexicans, and the Masai. Yet in Danger Island any one caught in the act of stealing food, 'the most valuable property they know of,' was put to death.³

Food-tabus, though materially identical in being restrictions upon diet, and extremely numerous and widely spread, are of diverse origin. One form, probably the earliest of economic legislations, has been noted—the restrictions placed upon the young. Another familiar form is the general tabu *ad hoc*, imposed, as, for instance, by the chiefs in Tonga and the Marquesas, when a particular food was scarce. So, on occasion, the bread-fruit was tabued.⁴ A large body of customs are cases of fasting (*q.v.*), though the primitive notions of pollution by means of food are commonly present.⁵

The individual food-tabu is a curious expression generally of a form of self-regard akin to totemic ideas. In the Andaman Islands each person 'is prohibited all through life from eating some one (or more) fish or animal: in most cases the forbidden dainty is one which in childhood was observed (or imagined) by the mother to occasion some functional derangement; when of an age to understand it the circumstance is explained, and, cause and effect being clearly demonstrated, the individual in question thenceforth considers that particular meat his *yāt-tūb*, and avoids it carefully. In cases where no evil consequences have resulted from partaking of any kind of food, the fortunate person is privileged to select his own *yāt-tūb*, and is of course shrewd enough to decide upon some fish, such as shark or skate, which is little relished, and to abstain from which consequently entails no exercise of self-denial.'⁶

Similar observances are recorded of the Samoans, the Omahas, and the West Africans.⁷ Such restrictions are most familiar in the case of totemism, where they are group-restrictions.

There are numerous cases in which a whole society refrains by custom from eating some particular food. The Navahos never touch fish or wild turkey.⁸ Such abstention from fish is frequent.⁹ Abstention from pork is a custom shared by the Hebrews with the Navahos, the Yakuts, the Lapps, the Guiana Indians, and the ancient Egyptians and Semites.¹⁰ The feelings of disgust and of reverence are variously called in to account for this restriction.

Particular influences of certain meats upon the human system are given as reasons for similar restrictions. Besides various sicknesses supposed to result, special properties of the food in question are believed to pass into the eater. The Zaparo Indians

'will, unless from necessity, in most cases not eat any heavy meats, such as tapir and peccary, but confine themselves to birds, monkeys, deer, fish, etc., principally because they argue that the heavier meats make them unwieldy, like the animals who supply the flesh, impeding their agility, and unfitting them for the chase.'¹¹

The American Indians studied by Adair 'seldom ate of any animal of gross quality, or heavy motion of body, fancying it conveyed a dullness through the whole system, and disabled them from exerting themselves with proper vigour in their martial, civil, and religious duties.'¹

The Namaquas and Kafirs avoid eating hares, giving as a reason the danger of contracting the timidity of the animal.² Such examples might be multiplied indefinitely.

Westermarck has described the tendency to refrain from eating animals with which men have established intimacy.³ The Yuruna of Brazil will not eat any animal they have bred themselves, and they censured von den Steinen for eating the eggs of fowls.⁴ Such feeling may be connected with the prohibition of beef among the Hindus.

Frazer observes that the food-tabus upon priests and kings are *a fortiori* more numerous and stringent than those upon ordinary persons. Thus, the fetish-priests of Loango, the *flamen Dialis*, the Egyptian kings, and some Indian chiefs are reported to have abstained from various foods.⁵

If any rationalist motive is sought for, that which possibly will satisfy most of the cases is a pre-scientific principle of dietetics. But, as Frazer points out,

'to explain the ultimate reason why any particular food is prohibited to a whole tribe or to certain of its members would commonly require a far more intimate knowledge of the history and beliefs of the tribe than we possess.'⁶

Westermarck traces several sources for the avoidance of particular foods:

'Disagreeable taste; disgust caused, in the case of animal food, either by the external appearance of the animal, or by its unclean habits, or by sympathy, or by associations of some kind or another, or even by the mere fact that it is commonly abstained from; the disinclination to kill an animal for food, or, generally, to reduce the supply of a certain kind of victuals; the idea, whether correct or false, that the food would injure him who partook of it.'⁷

One or two forms of restriction are particularly important in their religious or racial aspects. The Hindu avoidance of flesh-meat has been motivated by various religious principles, but at the back of it is a gradual unconscious process of adaptation to climate; in hot countries a flesh-diet is more or less deleterious. Beef is never eaten by modern Hindus; it is the flesh of the earthly representative of the divine *Bhagavatī*.⁸ 'At the present day all the higher classes abstain from animal food in every form and are rigid vegetarians.'⁹ But *Sūdras* use animal food; 'indeed, some of the lowest classes of that infinitely divided and subdivided caste eat almost anything and everything that comes in their way.'¹⁰ In ancient times beef and other flesh were eaten both ordinarily and in connexion with religious festivals. Thus, *Manu*, while observing that the eating of flesh (*māmsa*) and of fish (*matsya*) by twice-born men is prohibited, directs that flesh-meat be eaten at certain *Śrāddhas*; he also says:

'No sin is committed by him who, having honoured the deities and the *manes*, eats flesh-meat which he has bought, or which he has himself acquired, or which has been given him by another.'¹¹

The Vedas enjoin a sacrifice of cattle for the purpose of entertaining a guest.¹² The *Charaka Samhitā*, of the 1st cent. A.D., ordains that 'the flesh of cows, buffaloes, and hogs should not be eaten daily,' but that pregnant women may eat beef, with a view to strengthening the unborn child.¹³ In early sacrificial rites the worshippers ate of the flesh.¹⁴ The blood was thrown away to the *Rākṣasas*.¹⁵ In the relatively modern religion

¹ Spencer-Gillen^a, *passim*.

² H. A. Giles, *Strange Stories from a Chinese Studio*, London, 1890, ii. 217.

³ Westermarck, *MI* i. 286 f., ii. 14 f.

⁴ M. Radiguet, *Les Derniers sauvages*, Paris, 1882, p. 229 f.; W. Mariner, *Tonga Islands*, London, 1817, ii. 233.

⁵ Westermarck, *MI* ii. ch. xxxvii.

⁶ E. H. Man, in *JAI* xii. [1883] 354.

⁷ Westermarck, *MI* ii. 323.

⁸ Stephen, in *Amer. Anthropologist*, vi. [1893] 357.

⁹ Westermarck, *MI* ii. 324 f. ¹⁰ *Ib.* 326 ff.

¹¹ A. Simson, *Travels in Ecuador*, London, 1887, p. 168; see Frazer, *GB* ii. 363 ff.

¹ J. Adair, *American Indians*, London, 1775, p. 130 f.

² T. Hahn, *Tsuni-Goam*, London, 1881, p. 106.

³ Westermarck, *MI* ii. 329.

⁴ K. von den Steinen, *Durch Central-Brasilien*, Leipzig, 1886, p. 262.

⁵ *GB* i. 391.

⁶ *Ib.* 392.

⁷ *MI* ii. 334 f.

⁸ Rājendralāla Mitra, *Indo-Aryans*, Calcutta, 1881, i. 365.

⁹ Padfield, 167.

¹⁰ *Ib.* 165.

¹¹ *Manu*, v. 32; cf. v. 41 f., iv. 131.

¹² Rājendralāla Mitra, i. 355.

¹³ *Ib.* 380.

¹⁴ *Ib.* 361 ff., 365 f.

¹⁵ *Ib.* 375.

of the *Tantras* a reaction against the normal tendency of Hinduism is the keynote of theory and ritual. One of the five 'acts' of the Śākta-worship is the eating of flesh-meat (*māṃsa*); another is the eating of fish (*matsya*). As Monier-Williams notes, they 'have good ground for asserting that, in drinking wine and eating meat, they are merely reverting to the practice of their ancestors.'¹

The view held by most Hindus, however, is comparable with that of Europeans on the subject of cannibalism.² Westermarck thinks that Hindu vegetarianism is the 'natural outcome of a system which enjoins regard for life in general and kindness towards all living beings.'³ In *Manu* there certainly is the germ of this system, as there is that of its contradictory, Śāktism.

'Meat can never be obtained without injury to living creatures, and injury to sentient beings is detrimental to the attainment of heavenly bliss.' 'There is no greater sinner than that man who, though not worshipping the gods or the *manes*, seeks to increase the bulk of his own flesh by the flesh of other beings.'⁴

A connexion certainly may be assumed between the prohibition of killing animals and that of eating them.⁵ The former prohibition is still more stringent in Buddhism and Jainism. It is also important in Taoism.⁶ But Buddhism allows pure flesh to be eaten, if, that is, it has not been procured for the purpose, or if the eater has not supposed so.⁷ The sin is upon the slayer. Ancient Egypt and Greece knew the religious form of vegetarianism, and their myths, like the earliest Hebrew, represented man as having been originally a fruit-eating creature.⁸ The Qur'an prohibits the eating of 'what is dead, and blood, and flesh of swine, and whatsoever has been consecrated to other than God.'⁹ The Jews and early Christians avoided the eating of blood.¹⁰ The Jews also avoided the eating of the intestinal fat,¹¹ and of the 'sinew of the thigh.'¹² Still important in relation to the carefully observed rules in the preparation of 'koshered' food, is the avoidance of meat that is either *n'bhēlāh* or *ṭrēphāh*. The former is that of animals dying a natural death, the latter of those 'torn by beasts.'¹³

4. Ideas and rituals.—The ideas which centre in food and its properties in early culture are multitudinous; but, since they have had considerable influence in the formation of social habits, they must be briefly classified and described. The natives of Queensland burned all food left over from meals, to prevent 'sorcerers' from getting hold of it and injuring them thereby. The Victorian tribes 'believe that, if an enemy gets possession of . . . bones of animals they have eaten, . . . he can employ it as a charm to produce illness.' The Narrinyeri call such persons 'disease-makers.'¹⁴ In Tanna of the New Hebrides

¹ *Brāhmanism and Hindūism*⁴, 192, 196.

² P. Percival, *Land of the Veda*, London, 1854, p. 272.

³ Westermarck, *MI* ii. 337. ⁴ *Manu*, v. 48, 49, 52.

⁵ Westermarck, *loc. cit.* ⁶ *Ib.* 336.

⁷ H. Kern, *Manual of Ind. Buddhism*, Strassburg, 1896, p. 71.

⁸ See Westermarck, *ii.* 338.

⁹ *ii.* 168; Qur'an, in *SBE* vi. [1900] 23 f., 58, 94, 97, 106, 109 ff., 184 f., 262 f.

¹⁰ *Lv.* 317 726 ff. 1710 f. 1926, *Dt* 1216. 23 1523, *Ac* 1520. 29 2125.

¹¹ *Lv.* 338. 722 ff.

¹² W. R. Smith, *Rel. Sem.*², London, 1894, p. 380; *Gn* 3233.

¹³ *Ex* 2231, *Dt* 1421; see A. R. S. Kennedy in *EBi*, s.v. 'Food.' For Hebrew 'clean' and 'unclean' meats in *Lv* 11, *Dt* 14, see W. R. Smith, 238, 466; for Chinese lawful and unlawful foods, *SBE* xxvii. [1885] 287, 462; for ancient India, *ib.* ii. 59-71, 74 f., 265-70, 274, vii. [1900] 33, 39, 136, 187, viii. [1898] 279, x. [1892] pt. 2, 40 f., xiv. [1882] 33 f., 44, 69-75, 104 f., 115, 121, 130 f., 154, 171-3, 184 f., 222, 224, 237, 239, 250 f., 263, 287, 298, 310, 313, 317, 319, 329, xxv. lxxviii f., xciv, 161-4, 168, 170-7, 441, 443, 497, xxxviii. [1896] 311 f. The whole cycle of the ideas of cleanness and uncleanness applies emphatically to the history of food.

¹⁴ C. Lumholtz, *Among Cannibals*, London, 1889, p. 298; J. Dawson, *Australian Aborigines*, Melbourne, 1881, p. 54; J. D. Woods, *Native Tribes of South Australia*, Adelaide, 1879, p. 24 ff.

the disease-makers injure a man by burning his *narak*, i.e. the refuse of his food. All the Tannese carry small baskets about with them, into which they put banana skins, coco-nut husk, or any refuse from that which they may have been eating, in order to avoid its discovery by an enemy, until reaching and crossing a stream of running water, which alone has the power of annulling the danger.¹ Similar ideas and customs prevail throughout the Pacific, East Indies, and South Africa.²

Before eating the new corn the Creeks and Seminoles took a purgative in order to prevent the sacred food from being polluted by common food.³ Here is the tendency to avoid mixing different sorts of food, which plays a considerable part in Jewish sacred dietetics. The young Masai warrior is obliged to eat nothing but beef for so many days; he may not pass to another diet until he has taken a purgative and emetic.⁴ The Eskimo may not eat venison on the same day with whale, seal, or walrus-flesh, nor may two such sorts of meat even lie together on the floor of the hut. Before changing from one food to another they wash themselves.⁵

Properties and qualities, beneficial or deleterious, are naturally believed to be inherent in, or transmissible to, food. Here we have the beginnings both of artistic cookery and of scientific dietetics. One great demand in all ages is for 'pure' food. The meaning of the term in barbarism and in civilization is different according to the atmosphere of the society, whether superstitious or rationalistic. In early thought 'pure' food is unmixed food, but the mixture is avoided as causing ceremonial pollution either to the food or to the eater. The eating of pure food in ancient India was more important than all other means of purity: 'he who eats pure food only, is truly pure, not he who is only purified with earth and water.'⁶ Food itself, as such, may cause pollution; thus, among the Maoris,

'no food is permitted to touch the head or hair of a chief, which is sacred; and, if food is mentioned in connexion with anything sacred or tapu, it is considered as an insult and revenged as such.'⁷

A Maori chief never allowed any food to touch his head. He would not even enter a cooking-house or any building where food was hung from the ceiling, lest his head should be under it for a moment. The Maori theory was 'that anything, if placed in contact with a sacred object, acquired the sacred nature of that object.' And the most marked peculiarities in their customs may be traced to the principle 'that food which has once touched a sacred object becomes itself sacred, and therefore must not be eaten except by the sacred object.'⁸

Similarly the North American Indians held

'that nature is possessed of such a property as to transmute into men and animals the qualities, either of the food they use, or of those objects that are presented to their senses; he who feeds on venison is, according to their physical system, swifter and more sagacious than the man who lives on the flesh of the clumsy bear, or helpless dunghill fowls, the slowfooted tame cattle or the heavy wallowing swine.'⁹

This theory is of world-wide distribution.¹⁰

Among strong or magical foods the most potent is human flesh. The transmission of human char-

¹ G. Turner, *Nineteen Years in Polynesia*, London, 1861, p. 89; B. T. Somerville, in *JAI* xxiii. [1894] 19 f.

² See A. E. Crawley, *The Mystic Rose*, London, 1902, pp. 126-132.

³ Frazer, *GB*² ii. 335 f.

⁴ J. Thomson, *Through Masai Land*, London, 1887, p. 430; P. Reichard, *Deutsch-Ostafrika*, Leipzig, 1892, p. 288.

⁵ F. Boas, *RBEW*, 1888, p. 595.

⁶ *SBE* vii. 97. See citations *supra*. Forbidden food becomes pure by having earth scattered upon it ('Laws of the Aryas,' in *SBE* ii. 292).

⁷ G. F. Angas, *Polynesia*, London, 1866, p. 149.

⁸ E. Shortland, *Southern Districts of New Zealand*, London, 1851, pp. 30, 292, 294.

⁹ J. Adair, 133.

¹⁰ See *GB*² ii. 353-361.

acter by this means is at the root of religious cannibalism (*q.v.*).

The contagion of death is supposed to enter food.¹ Murderers, among the American Indians, were not allowed to cook for themselves or others. They could not drink out of any other dish than their own.² In Samoa those attending to a dead person were careful not to handle any food, and for days were fed by others.³ The Moorish custom of *l'ar* seems to depend on the theory of the transmission of curses by food. 'The food will repay' is an explanatory phrase. The food eaten in such compacts contains a conditional curse; the persons eating together take it upon themselves in the event of breaking their word⁴ (see CURSING AND BLESSING, vol. iv. p. 372 f.).

The ceremonies of eating together are world-wide, and bring into relief the social sacredness attaching to food. Eating together is a mode of forming an alliance between two peoples, as between two individuals.⁵ Following the tabu often observed which prevents the two sexes, in particular two affianced persons, from sharing meals, is the marriage ceremony of eating together. There is here the acceptance of mutual gifts, as well as the responsibility of eating food which is representative and which renders the persons 'of one flesh.'⁶

5. Food of the gods.—The conception that the gods are superior members of the community involves the view that sacrifice is largely developed from the social ideas of food and its assimilation. The notions of offering and of covenant supervene. Food is rendered sacred by various critical circumstances. In particular the food of chiefs and of sacred persons acquires a sanctity which helps to explain the value of sacrificial meat. The supply of food to the gods, Payne observes, multiplies man's energy. 'Food and drink are the materials of sacrifice. Health, so far as this is an attribute of the gods, is secured by the continuance and abundance of the sacrifices.'⁷ Moreover, the choicest foods are reserved for the gods.⁸ The gods of Peru, for instance, had their own herds of llamas whose flesh was consumed on their altars.⁹ Flesh also was placed in the idol's mouth.¹⁰

On similar lines is developed the ritual of offering food to the dead¹¹ (see FOOD FOR THE DEAD).

¹ In some cases the custom of fasting before the performance of a sacrifice may be due to the idea that it is dangerous or improper for the worshipper to partake of food before the god has had his share.¹²

Into this principle the idea of purity in the worshipper naturally intrudes. Conversely the 'sacredness' of tabu states, such as mourning, is particularly liable to be communicated to food. Hence a multitude of precautions in the feeding of persons in such states.¹³

Particular examples of divine foods are the shewbread (*q.v.*) of the Hebrew ritual, and the Christian Eucharist (*q.v.*). In these and similar cases the ideas of sacred food, of offering, and of eat-

¹ W. Gregor, *Folklore of the North-East of Scotland*, London, 1881, p. 206.

² S. Hearne, *Journey to the Northern Ocean*, London, 1795, p. 204 f.

³ G. Turner, *Samoa*, London, 1884, p. 145; for rules of caution followed in handling food see *GB*² i. 319, 322, 326, 332, 339, 373, iii. 207.

⁴ Westermarck, *MI* i. 586 f., ii. 623 f.

⁵ J. G. F. Riedel, *De sluk- en kroesharige Rassen*, Hague, 1886, pp. 379, 279, 128 f.; see Crawley, *Mystic Rose*, 244-252, 375 ff.

⁶ Examples in Crawley, *Mystic Rose*, 378-384. For the tabu against eating together see *ib.* 163-178.

⁷ Payne, i. 437, 434. ⁸ *ib.* 435.

⁹ *ib.* 437. Parallel with libations before a meal is the rather rare custom of throwing morsels of food on the ground; cf. Bancroft, *Native Races*, New York, 1875-8, ii. 285.

¹⁰ Cf. Bancroft, ii. 307. In many religions—e.g. Central American, Greek, and Roman—dough miniatures of animals were offered to the gods instead of the animals themselves.

¹¹ See Payne, i. 489. ¹² Westermarck, *MI* ii. 296 f.

¹³ *ib.* ii. 296-310.

ing the god himself are usually combined. The early ritual of eating ceremonially the firstfruits of a crop, and of assimilating the 'soul' thereof, is of a similar character.¹ Since in Greek and Roman theological theory all flesh-meat was sacrificial, the early Christians found here a practical difficulty.²

6. Food in symbol and metaphor.—The contrasted views of Roman Catholics and Protestants as to whether the Eucharistic bread is changed in substance or is a symbol of the flesh of Christ, supply a crucial case of the mystical valuation of food.

To obtain the favour of a deity by self-affliction the Central Americans would eat earth or grass.³ Conversely, the twice-born Hindu is exhorted to 'worship his food and eat it without contempt; when he sees it let him rejoice, show a pleased face, and pray that he may always obtain it. . . . Food that is always worshipped gives strength and manly vigour, but eaten irreverently it destroys them both.'⁴

A Mexican exhortation says:

'There is no man in the world but what eats, for each one has a stomach and intestines. . . . By the sustenance of the body life is upheld, by it the world is peopled.'⁵

In the Upanisads it is written:

'From food are born all creatures that live on earth; afterwards they live on food, and in the end (when they die) they return to it.' Food is 'the root of the body.'⁶

The *Satapatha Brāhmana* has it that food, when enclosed in the body, becomes the body itself.⁷ Food, according to the same, is linked to the body by means of the vital airs.⁸ The essence of food is invisible. Food is the highest of all things that can be swallowed.⁹ The *Satapatha Brāhmana* identifies food and breath, as the *Ārya Laws* identify food and life.¹⁰ Food and breath are both gods, the 'two gods.'¹¹ Food is the deity of the *pratihāra* hymns, for all live when they partake of it.¹²

Payne suggests that, in the development of language,

'not long after emotional exclamations and demonstrative names came primitive adjectives signifying "good" and "evil," applied to animal and vegetable species with reference to the purpose of food, in the sense in which the African guide divides all plants into "bush" and "good for nyam" (the latter including the eatable ones, the former the residue). . . . The Bible (*Gn* 2^{19c}) represents the naming of food-animals as the first effort of speech; and the quest and choice of food is of the substance of all its early incidents (*Gn* 3 and 4) (cf. Herodotus, *Euterpe*, ii.). Though the Tupi can only count up to 3, Von Martius gives 1224 Tupi words for animals and their parts.'¹³

Celestial food, 'bread from heaven,' combines metaphor and ideas of transubstantiation.¹⁴ Bread as a type of Christ is an idea worked out elaborately in *Jn* 6 and *1 Co* 10. Food the material becomes food the spiritual.¹⁵

See also art. FEASTING.

LITERATURE.—This is fully given in the article.

A. E. CRAWLEY.

FOOD (Hindu).¹⁶—The question of food is considered highly important from a religious point of view in India, and is elaborately discussed in the canonical books of all religions. Indeed, the various and manifold rules of caste in India hinge in the first place on food, its preparation, and the persons with whom it may be eaten. Thus eating the numerous kinds of prohibited food, or eating for a considerable period with persons of low caste or with Muhammadans, is among the most ordinary causes of expulsion from caste, one of the most

¹ *GB*² ii. 321, 327. ² 'Food offered to idols' (*Ac* 15²⁹, *Ro* 14, *1 Co* 8). The gods, in most cults, civilized and uncivilized, are supposed to eat the 'essence' of the offered food.

³ Bancroft, iii. 424, 438. ⁴ *Manu*, ii. 54 f.

⁵ Bancroft, ii. 250.

⁶ *SBE* xv. [1900] 315, i. [1900] 99.

⁷ *ib.* xliii. [1897] 341. ⁸ *ib.* xi¹. [1894] 270.

⁹ *ib.* xliiii. 95, viii. [1898] 853.

¹⁰ *ib.* xii. [1882] 304, xiv. 245.

¹¹ *ib.* xv. 142. ¹² *ib.* i. 20 f. ¹³ Payne, i. 279 f.

¹⁴ *Ps* 78²⁵. ¹⁵ *Jn* 6²⁷ 432, 34.

¹⁶ Cf. also preceding art., *passim*.

dreaded punishments in India, which involves in the first place an interdict against eating with the fellow-members of the caste. Though many educated Hindus eat and drink in the European fashion nowadays, there are still Brāhmins and other high-caste natives of India to be found who would rather starve than allow food prepared by a man of inferior caste to pass their lips. Thus in 1864, Sir W. W. Hunter saw a Brāhmin felon try to starve himself to death, and submit to a flogging rather than eat his food, on account of scruples as to whether the birthplace of the N.W. Brāhmin who had cooked it was equal in sanctity to his own native district. Food prepared by a person of inferior caste causes defilement, and a member of the higher castes therefore always employs a Brāhmin cook. Leather causes defilement, therefore no one should cook with his shoes on. Food cooked on board a ship causes defilement, therefore native passengers travelling in a boat will sometimes interrupt their journey to cook their food on shore. The kitchen should be the most retired room in the house, so that no Sūdras may look in and thus defile the earthen vessels. It is also considered highly improper to look at any one who is eating. The women, after preparing the dishes, wait on the men, and eat what is left by them; they never sit down to eat with the men. The orthodox fashion is to eat with the fingers, the use of spoons, forks, or knives being forbidden. Nothing must ever be touched with the left hand, which is used in the meanest offices, and therefore considered unclean. Before eating certain kinds of food, a person must wash his hands and feet, and remove part of his clothing. The rice and other dishes are served on a banana leaf or in small earthen vessels. Hindus take two meals a day, in the morning and evening; but widows, penitents, and ascetics must not eat anything in the evening. The remains of food are thrown to the crows and the dogs. The gods and the evil spirits are also to be given their share of each meal, with certain attendant ceremonies. The Brāhmin, his meal being over, washes his hands, rinses his mouth, and gargles his throat. Many of these rules are nowadays neglected, but social estimation can still be gauged by the degree to which the food and water touched by the various castes will be accepted by others. Thus the Commissioner for the Census of 1901 circulated for consideration a fivefold division of castes, resting largely on a distinction between those from whom Brāhmins can take water and those from whom they cannot. Water and *pakka* food, i.e. food prepared with *ghī* (clarified butter), generally go together, so that a man can take water or *pakka* food touched by a member of any sub-caste of his own caste, but he can eat *kachchha* food, i.e. food prepared without *ghī*, only when prepared by a member of the same endogamous subdivision or sub-caste as that to which he belongs. Most castes will take *kachchha* food prepared by Brāhmins, and many castes can take *pakka* food or water which has been touched by other castes; a Brāhmin, on the other hand, would drink water carried in a *lotā* by a low-caste man, if the *lotā* belonged to the Brāhmin, but would refuse to drink from the low-caste man's *lotā*. Difference of residence also operates as a bar to eating together, as in a recent case of two orderlies belonging to the same sub-caste, both of whom declined to eat even *pakka* food prepared by the other, because their homes were 50 miles apart. Brāhmins on the Bombay side will, as a rule, not take water from any but other Brāhmins, generally only from the members of the sub-caste to which they belong.

As regards the dietary, Brāhmins are not allowed to taste meat, fish, or eggs, the killing of animals, especially oxen, for food being considered an im-

pious act. This abstinence has gained ground among the inferior strata of society also, and the members of the Śākta sect, who sacrifice certain animals and eat their flesh afterwards, are held in low estimation. It is true that a Śākta cook is sometimes provided for those male members of a family who may feel disposed to eat mutton. The Bengal Rājputs, a landholding caste of high standing, eat the flesh of the goat, the deer, the hare, the pigeon, quail, and ortolan. But these animals, if not killed in hunting, must be slaughtered in a particular way by cutting the head off at a single stroke. Fish is also considered lawful food among the Rājputs, and among many richer families generally. Beef is greatly abhorred, and the flesh of the buffalo, pig, horse, camel, and other large animals is also viewed with disgust. In States ruled by Hindu princes it used to be on no account permitted to kill a cow; and even now the Society for the Protection of Cows is trying to prevent the slaughter of cows for food. The Muhammadan and European practice of killing oxen and cows has been the cause of many quarrels in India. Only the lowest castes, such as the filthy Chamārs (tanners) of N. India, eat beef, as well as pork and fowls, and all manner of unclean food; nor, like the gipsies of Europe, have they repugnance to cooking the flesh of animals which have died a natural death. The touch of these castes pollutes, and no Brāhmin barber or washerman will work for them. Vegetables and sweetmeats, which form the principal food of Brāhmins and Brāhminized castes, are also subject to exceptions. Thus they reject garlic, onions, mushrooms, and other vegetables whose root or stem grows in the shape of a head. Turmeric, pepper, cummin, coriander, mustard seeds, and other spices are used, and impart a strong flavour to the preparation. Alcoholic drinks are forbidden, and, as a rule, a respectable Hindu will not touch spirits such as toddy or arrack, or any other intoxicating drink, at least in public. Drunken habits would lead to prompt and ignominious expulsion from caste, and it is generally in privacy only that high-caste natives of India break the law of temperance. The drunken orgies of the Śāktas are confined to a particular set, and to particular days. Water is the ordinary beverage of Hindus; curdled milk diluted with water, butter-milk, and milk are also favourite drinks. Tobacco is considered objectionable, but chewing betel after dinner, according to ancient custom, is believed to be wholesome and is generally practised.

Most of these rules are ancient, and may be traced in the sacred books and historical records of the principal religions of India. The prohibition of animal food and the sanctity of animal life are particularly insisted upon in Buddhism and Jainism. Thus king Aśoka, who in early life had entertained no scruple about the killing of thousands of living creatures on the occasion of a royal banquet, stopped this regular slaughter as he became gradually imbued with the spirit of Buddhist teaching. He ruled that only two peacocks and one deer were to be killed each day, and afterwards prohibited even this limited slaughter; he abolished the royal hunt; and he published (in 243 B.C.) a stringent code of regulations applicable to all classes of the population regarding the slaying of animals for food in his empire. With Jain ascetics, the oath not to hurt is the first of the five great oaths which they are required to take; and this oath includes not merely the intentional killing or hurting of living beings or plants; it requires also a watchfulness over all functions of the body by which anything living might be injured. The Code of Manu is less severe, and its provisions on the subject of animal food were therefore attacked in

Jain writings. Though not approving generally of animal food, Manu allows a Brāhman to eat meat if hallowed by sacred texts and used in sacrificing to the gods or *manes*, or in showing honour to a guest (Manu, v. 31ff.). Again, in spite of the general prohibition to eat flesh or fish, certain kinds of fish and birds are declared to be lawful food; likewise, the porcupine, the hedgehog, the iguana, the rhinoceros, the tortoise, and the hare (Manu, v. 11-18). Animal-sacrifice was a recognized institution in ancient Brāhmanism, just as it is with the Śāktas of the present day. Under more recent Brāhmanical texts of law, however, the slaughter of animals at a sacrifice or at the reception of guests is forbidden in the present age of the world. In medical works, the Rohita fish (*Cyprinus Rohita*) is specially recommended to be eaten, as a remedy in various diseases. Of plants and vegetables, garlics, mushrooms, onions, and leeks are forbidden by Manu (v. 19). One of the ancient medical texts preserved in the Bower MS contains a legend, according to which Brāhmans are not permitted to eat garlic, because it was generated from the drops of ambrosia which trickled from the demon Rāhu's head after it was cut off. The drinking of spirituous liquor is included among the five great sins, which are punishable by a penance ending in death (Manu, xi. 91 f.). Hermits in the wood and ascetics are subject to special restrictions with regard to their diet (Manu, vi. 13 ff.), and analogous rules exist for Buddhist monks. Thus a Buddhistic canonical book mentions as delicacies which a monk must never taste unless sick: *ghī*, butter, oil, honey, sugar, fish, meat, milk, curds. The Brāhmanical lawbooks further show that a Brāhman took his food twice a day, eating moderately, taking nothing between meals, and offering part of his food to the gods and to his guests first of all. Some remnants of food were always to be left, and offered to dogs, crows, and low-caste persons. After a meal a little water had to be sipped. It was forbidden to eat in a ship, or sitting in the same row with unworthy people, or together with one's wife. It was considered the height of immodesty in a woman to eat before her husband; she had to be content with the remains of his meal. Long lists are given of those persons from whom a Brāhman must accept no food, as, e.g., from a madman, a spy, a eunuch, an unfaithful wife, etc. Special penances are ordained for eating the food of persons whose food may not be eaten, or forbidden food, or food blemished by the contact with impure men or things. The eating or chewing of betel-leaf (*tāmbūlabhakṣanam*) is recommended.

LITERATURE.—*Reports on the Census of India*, 1901; J. A. Dubois, *Hindu Manners, Customs, and Ceremonies*, tr. Beauchamp, Oxf. 1899; S. C. Bose, *The Hindoos as they are*, Lond. 1881; *IGI*, new ed., Lond. 1908; M. Williams, *Indian Wisdom*, do. 1876; 'Sacred Laws of the Aryas,' tr. G. Bühler, in *SBE*, vols. ii. xiv.; 'Manu,' tr. G. Bühler, *ib.* vol. xxv.; 'Minor Lawbooks,' tr. J. Jolly, *ib.* vol. xxxiii.; H. Kern, *Manual of Indian Buddhism*, Strassburg, 1896 (in Bühler's *Encyclopedia of Indo-Aryan Research*); A. F. R. Hoernle, *The Bower Manuscript*, Calcutta, 1893; G. Bühler, *On the Indian Sect of the Jainas*, tr. Burgess, Lond. 1903; V. A. Smith, *Early History of India*, Oxf. 1908.

J. JOLLY.

FOOD FOR THE DEAD.—The custom of providing food for the dead, which appears in all ages and in most parts of the world, is based upon the animistic conception of the soul, which, on its departure from the body, is often regarded as a tiny, feeble entity, conscious of the same wants as those which it felt in life, and dependent, at least until it attains its final rest, upon the pious care of the survivors. The same belief appears in the provision of clothes, weapons, and even companions, for the spirit in the next world. The last usage is illustrated by the rite of *satī* (*q.v.*), and by the

massacre of slaves and dependents, whose spirits are believed to accompany the spirit of their master.

1. Objects of the rite.—The common explanation of such rites is that they are intended to make the departed soul so comfortable in death-land that it may have no inducement to return and annoy the survivors. But this is not the only reason that has been suggested for this and the kindred custom of burying his goods with the dead man. Crawley (*Mystic Rose*, London, 1902, p. 98) argues that the practice is generally based on the dread of contact with articles belonging to the dead, which have become infected with the tabu of the corpse; and that the idea of providing for the wants of the spirit, though often combined with the dread of tabu, is probably later in origin. Other explanations, less satisfactory, have been suggested. Thus the presence of flint implements in cinerary urns at the Romano-British cemetery of Seaford has been accounted for by some symbolic meaning attached to them; some suppose the sharp flints to be the knives with which the survivors lacerated themselves as a sign of grief; others believe that the intention was to lay the ghost of the dead, flints and other stones from which it is possible to extract fire being said to be efficacious in preventing the ghost from 'walking' (*JAI* vi. 308, quoting Douce, *Illustrations of Shakespere*, London, 1807, ii. 224; *Arch. Journ.* xxii. 117; *Archaeologia*, xlii. 428, xliii. 422). It is, however, impossible to dissociate flint weapons from the other arms and implements laid with the dead to enable them to provide for their wants in the other world.

Jevons (*Introd. to Hist. of Rel.* p. 194 f.) endeavours to establish a gradation in this class of custom. Comparing food offerings to the dead with those of hair and blood, he remarks:

'Originally, the dead were supposed to suffer from hunger and thirst as the living do, and to require food—for which they were dependent on the living. Eventually, the funeral feasts were interpreted on the analogy of those at which the gods feasted with their worshippers. . . . The food-offering is, however, more interesting in one way than the offerings of blood or hair: it enables us to date ancestor-worship relatively. It was not until agricultural times that the sacrificial rite became the cheerful feast at which the bonds of fellowship were renewed between the god and his worshippers. It could not therefore have been until agricultural times that the funeral feast came to be interpreted on the analogy of the sacrificial feast.'

This he believes to be corroborated by the fact that ancestor-worship dates from the rise of the family, 'a comparatively late institution in the history of society.'

It may be true that Palaeolithic man in Europe had no conception of the existence of the spirit after death, and was, therefore, not under the necessity of preparing for its wants in the other world; but even so primitive a race as the Tasmanians, who had reached the Palaeolithic stage of culture, though there is no evidence that they provided food for the dead, used to place a spear in the grave, 'to fight with when he is asleep' (Ling Roth, *Aborigines of Tasmania*, Halifax, 1899, p. 119).

2. Prevalence of the custom.—Practices of this kind can be traced to a remote antiquity.

(1) *Ancient Britain, etc.*—Thus, pottery in the shape of what are known as 'food-vessels' has been found, in association with both burnt and unburnt bodies, in the round and long British barrows and in pre-historic Swedish interments (Windle, *Remains of Prehistoric Age*, London, 1904, p. 150 f.; Montelius, *Civilisation of Sweden*, Eng. tr. 1888, p. 35; cf. above, vol. i. p. 571^b). Details of articles of this kind found in British interments are described in *Brit. Mus. Guide to the Antiquities of the Early Iron Age*, 1905, p. 107 ff.

(2) *Greece.*—In the *Nekuia* of Homer, when Odysseus visits death-land, the spirits of the dead are too feeble to hold converse with him until they

are refreshed with a draught of blood. He digs a pit (*ββθπος*)

'as it were a cubit in length and breadth, and about it poured a drink-offering to all the dead, first with mead and thereafter with sweet wine, and for a third time with water; and I sprinkled white mead thereon, and entreated with many prayers the strengthless heads of the dead. . . . But when I had besought the tribes of the dead with vows and prayers, I took the sheep and cut their throats over the trench, and lo! the spirits of the dead that be departed gathered them from out of Erebus' (*Od.* xi. 23 ff.).

Hence arose among the early Greeks the practice of providing the grave with a funnel, down which blood and other drink-offerings might be poured for the refreshment of the spirit (cf. above, vol. i. p. 334^b). At Mycenæ the round altar, which stood exactly over the fourth grave, was used for sacrifices of animals or human beings; and down its funnel the blood was poured into the grave (Ridgeway, *Early Age of Greece*, Cambridge, 1901, i. 7). At the Dipylon cemetery at Athens, the corpse is found laid in the grave, which is then covered with wood, and the shaft filled nearly to the top, a small space being left unfilled; in this space the tomb monument, usually a large painted vase, is set. The space round the vase thus served as a sort of trench, communicating by means of the shaft direct with the dead body. Further, many of the vases have a hole in the bottom, to allow the food and drink placed within them to reach the shade below (*FL* iii. 536 ff.). In the archaic cemetery at Thera, the offerings to the dead include oxen, swine, sheep, goats, and rabbits, the last being found only in the poorest graves (*JHS* xxii. 393). In later times we find a change in Greek sentiment, as is shown by the lines: 'in the cold shadows underground the ghost will not be comforted by ointments and garlands lavished on the tomb; the dead man will not drink' (*Anthol. Pal.* xi. 8). The custom, however, of consulting the wishes of the departed in the provision made for his wants appears in the Greek Hero-cultus (Frazer, *Pausanias*, London, 1898, iv. 24); and the drain as an adjunct to the tomb still survives in the ghost-houses of Tunis (*Man*, iii. 57). In the Greek islands the practice of feeding the dead survives to the present day. Cakes (*κόλλυβα*) of wheat adorned with sugar-plums, honey, sesame, and basil are presented to the dead.

'Sometimes they call these *μακάρια*, or blessed cakes, out of euphony, no doubt; these *κόλλυβα* are put on the tombs on stated days after the decease, with additional lamentations, and remind one forcibly of the ancient feasts for the dead which were likewise offered on stated days' (*JAI* xv. 396).

(3) *Rome*.—The Romans observed the rite of feeding the dead at the *dies parentales* in February, when

'the family would go in procession to the grave, not only to see that all was well with him who abode there, but to present him with offerings of water, wine, milk, honey, oil, and the blood of black victims; to deck the tomb with flowers, to utter once more the solemn greeting and farewell (*Salve, sancte parens*), to partake of a meal with the dead' (Fowler, *Roman Festivals*, London, 1899, p. 308; and see J. E. Harrison, *Proleg.*, Cambridge, 1903, p. 49 ff.).

As among the Greeks, a funnel for libations, connecting the surface of the ground with the grave below, has been observed in Roman graves (Mau, *Pompeii*, Eng. tr., 1899, pp. 421, 427). The placing of food on the bier before cremation is attested by Catullus (lix. 'vidistis ipso rapere de rogo coenam').

(4) *Babylon and Assyria*.—The frequent presence of shells in Babylonian interments (unless they were intended as amulets or as a substitute for food in the form of fish) is still unexplained; but instances of deposits of food are common (Jastrow, *Rel. of Bab. and Ass.*, Boston, 1898, p. 598). In such graves the dead man is provided with clay jars and dishes containing food—his favourite wine, dates, fish, fowl, game, or a boar's head, and even stone representations of provisions which were lasting substitutes for the reality; he was supplied with weapons to protect his food-store (Maspero, *Dawn*

of Civ., London, 1896, p. 686). Vases, spoons, and ornaments are found in Assyrian tombs (Layard, *Nineveh and its Remains*, London, 1849, ii. 18).

(5) *Egypt*.—In Egypt, Flinders Petrie (*Man*, vii. 113) describes the evolution of the custom from the earliest times. From the pre-historic age to that of the Vth dynasty a mat was laid on the grave, with a pan of food upon it. Afterwards this offering was carved in stone as a table of offerings, to give permanent satisfaction to the soul. By the time of the Xth dynasty the stone table was copied as a pottery tray of offerings. To the tray was next added a shelter, copied from the Bedawi tent; then came a shelter on columns, on which in later times a hut was placed; then followed chambers with wind-openings, roof, courts, and a verandah on the roof. Next we find complete two-storey houses. Finally, these are furnished with models of a couch, chair, stool, water-jars, and the figure of a woman making bread for the departed. Food and drink were placed for the *ka* on the table of offerings in the tomb, 'for otherwise he might suffer hunger and thirst, or even, so the Egyptians thought, be obliged to feed on his own excreta' (Erman, *Life in Ancient Egypt*, London, 1894, p. 307). Such offerings were painted on the walls of the tomb, in order to provide the dead with this shadowy food, and the reciter-priest was required to repeat certain magical formulæ, conjuring each visitor to the tomb, by what he held most sacred—by his children, his office, his king, and by the god of his house—to say 'thousands of bread, beer, oxen, and geese,' on behalf of the deceased (*ib.* 308). In the remarkable temple recently excavated at Thebes, on one of the sarcophagi

'offerings are being made to the priestess, while an attendant dresses her hair and occasionally inserts a hairpin into her coiffure. A priest milks a cow for her, and afterwards brings her the cup, saying: "This is for thee, drink what I give." On another a priest brings a bowl of beer, saying: "Beer for thy ghost!"' (*The Times*, 22nd June, 1905; and cf. above, vol. i. p. 342).

(6) *Modern Africa*.—The people of Dahomey plant a flat-topped iron on the grave, over which water, rum, or blood is poured as a libation to the deceased (Ellis, *Ewe-speaking Peoples*, London, 1890, p. 159). The Yoruba tribes place food, rum, and cowrie-shells in the grave, and sprinkle the corpse with the blood of a he-goat (Ellis, *Yoruba-speaking Peoples*, London, 1894, p. 158). The people of Ashanti sacrifice animals on the grave, and, in the case of a man of rank, place there food and palm-wine for some months; the spirits of the sacrificed animals accompany the soul to Shramanadzi or death-land (*Tshi-speaking Peoples*, London, 1887, p. 240 f.). M. H. Kingsley (*Travels*, London, 1897, p. 494) describes offerings of food and spirituous liquor made in the W. African death-huts. The Wakonde people in British Central Africa place on the burial-mound little baskets of meal or pots of native beer (H. Johnston, *British Central Africa*, London, 1897, p. 445; A. Werner, *Natives of Brit. Central Africa*, London, 1906, p. 52).

(7) *Scythians*.—According to Herodotus (iv. 73), 'when any one dies, his nearest of kin lay him upon a wagon, and take him round to all his friends in succession: each receives them in turn, and entertains them with a banquet, whereat the dead man is served with a portion of all that is set before the others' (Rawlinson's tr.).

(8) *China*.—In no other part of the world, perhaps, has the rite of feeding the dead been so carefully prescribed as in China. The ancient books describe how the mourners observed a rigid fast, 'all the food in the house having to be sacrificed to the deceased' (de Groot, *Rel. Syst. of China*, Leyden, 1892 ff., i. 27). The custom of filling the mouth of the corpse with morsels has now well-nigh fallen into disuse at Amoy; but, 'before taking their usual breakfast, the deceased's wife and children arrange a bowl of cooked rice, and in many cases also a dish of vegetables, bean-curd, or the like, on a table at the right

hand side of the bed. They carefully add a pair of chopsticks' (*ib.* i. 29). In former times, when the bodies of grandees were stored in the dwelling for a considerable time, between the structure which concealed the coffin and the coffin itself, the friends placed baskets filled with parched grain and dried fish and meat, which were intended as food for the dead (*ib.* i. 99). 'During the first seven weeks of mourning, especially before the morning and evening meal, obeisance is done to the spirit, accompanied with loud lamentations. A portion of food is on these occasions presented to the deceased' (Gray, *China*, London, 1878, i. 285).

(9) *Malays*.—At the grave of a Semang, Skeat observed coco-nuts used for holding small quantities of rice, and one containing water, placed near the corpse; the Sakai offer betel-nut and tobacco to the corpse as it is lowered into the grave, and place rice and cakes upon it; the Jakun lay boiled rice at the foot and middle of the mound, the former for the spirit of the deceased, the latter for those of dead parents and relatives who come to visit the deceased; the Orang Laut give the corpse betel-nut and areca-nut, warning it not to call the survivors or require anything from them in future (*Pagan Races*, London, 1906, ii. 92, 99, 105, 109, 116). The Siamese carry food to the tombs of their dead parents, 'which the beasts do eat' (de la Loubère, *Hist. Rel. of the Kingdom of Siam*, Eng. tr. 1693, p. 125).

(10) *Borneo and Melanesia*.—Among the Kayans, at the lying in state of the dead, the corpse is dressed in his best clothes, with a cigar fixed in his mouth, and seated with his betel-box at his side, as if he were alive; the Dayaks collect boiled rice and other delicacies, which are 'thrown through the opening at the back of the house, and the wailer is fetched to effect their transmission to Hades. She comes again to the house of mourning . . . to call upon the adjutant bird . . . to do her bidding in conveying the articles of the *pana* to the other world.' Sometimes the presence of the dead at the funeral feast is secured by the aid of the wailer, who flings behind the house for their conveyance a piece of bamboo in which rice has been boiled; this serves as a boat.

'The dead are believed to build houses, make paddy farms, and go through all the drudgery of a labouring life, and to be subject to the same inequalities of condition and of fortune as the living are here. And as men helped each other in life, so death, they think, need not cut asunder the bond of mutual interchanges of kindly service; they can assist the dead with food and other necessities: and the dead can be equally generous in bestowing upon them medicines of magical virtue, amulets and talismans of all kinds to help them in the work of life' (Roth, *Natives of Sarawak*, London, 1896, i. 143, 206, 208, 213).

In Melanesia a small portion of food is thrown to the dead.

'It is hardly thought that this becomes in fact the food of the departed, but somehow it is to their advantage, at any rate it pleases them' (Codrington, *The Melanesians*, Oxford, 1891, p. 128).

At a sacrifice the invocation to the dead runs thus: 'Chief in war! we sacrifice to you with this pig, that you may help us to smite that place; and whatsoever we shall carry away shall be your property, and we also will be yours' (*ib.* 129).

The death meals, according to the same writer, are

'distinctly commemorative, but are not altogether devoid of the purpose of benefiting the dead; it is thought that the ghost is gratified by the remembrance shown of him, and honoured by the handsome performance of the duty; the living also solace themselves in their grief, and satisfy something of their sense of loss by affectionate commemoration' (*ib.* 271).

In Samoa, when the dead body was laid in the grave, a pig was taken to the place, and its head chopped off and thrown into the grave to be buried with the body; this was supposed to prevent the disease spreading to other members of the family, apparently because the angry spirit was believed to be pacified by the offering (Turner, *Samoa*, London, 1884, p. 335). In Fiji, when a child of rank died,

'the body was placed in a box, and hung from the tie-beam of the chief temple, and for some months the best of food was taken to it daily, the bearer approaching with the greatest respect, and after having waited as long as a person would be in taking a meal, clapping their hands as when a chief has done eating, and then retiring' (Williams, *Fiji and the Fijians*, London, 1858, i. 191 f.).

(11) *Australia and New Zealand*.—The Arunta tribe do not seem to practise this rite; their spirits 'kill and eat all manner of game, but always uncooked, for they are not supposed to have any fires, and not seldom they steal game which has been wounded, but not killed on the spot, by men' (Spencer-Gillen*, p. 516 f.). Some of the S.E. tribes believe that the spirit warms itself at fires left burning in the bush, and eats scraps of food left at such places (Howitt, p. 438). Among the Dieri, if the deceased was a person of influence, food is placed for many days at the grave, and in winter a fire is lighted so that the spirit may warm itself; if the food at the grave is not touched, it is supposed that the ghost is not hungry (*ib.* 448). The Kukata lay a drinking vessel on the grave, and a yam-stick is left with the corpse of a woman, in order that she may procure her own food; on the Herbert River food and water are often placed on the grave (*ib.* 450, 470, 474). In Queensland, tobacco, matches, food, a pipe, and other things are left each night at the grave, and the gift is announced to the spirit (Roth, *Ethnological Studies among the North-West-Central Queensland Aborigines*, Brisbane, 1897, p. 165). Among the Maoris of New Zealand,

'when a person died, food was placed by his side, and some also with him in the grave, as it was supposed the spirit of the deceased fed on the spirit of the food' (Taylor, *Te Ika a Maui*, London, 1855, 1870, p. 220).

(12) *India*.—Some examples of this practice have been given in vol. i. p. 450 f. At the cremation of a Toda, food, including grain, rice, jaggery, limes, and honey, is placed in the folds of the cloak in which the corpse is wrapped, and in a metal bowl (Rivers, *The Todas*, London, 1906, pp. 361, 380, 394). The Khāsis of Assam hang over the corpse a 'basket containing pieces of the sacrificed animals. A dish containing eatables, and betel-nut, and a jar of water are placed near the head of the corpse by way of offering refreshment to the spirit of the departed'; money is laid near it for the purchase of food on the way; pieces of the yolk of an egg, loaves of bread, the leg of a fowl, and the lower jaws of the animals which have been sacrificed are put inside the cairn before it is closed; similar offerings are made after the removal of the bones to the tribal ossuary (Gurdon, *The Khāsis*, London, 1907, pp. 133, 135, 137, 141; and cf. Stack, *The Mikirs*, London, 1908, p. 29; Lewin, *Wild Races of S.E. India*, London, 1870, p. 214). The feeding of the dead is inconsistent with the beliefs of orthodox Buddhists, Jains, and Lingāyats. But among the degraded Mahāyāna Buddhists of Tibet, at the noontide meal in the monasteries,

'lay servants bring to the cells a meal consisting of tea, meat, and *pāk* (a cake of wheat or *tsam-pa*). Of this food, some must be left as a gift to the hungry *manes*, Hariti and her sons. The fragments for this purpose are carefully collected by the servants and thrown outside the temple buildings, where they are consumed by dogs and birds' (L. A. Waddell, *Buddhism of Tibet*, London, 1895, p. 219).

(13) *America*.—The wild tribes of Central America, when a corpse was embalmed, used to bring food, wine, and the weapons of the dead man, place them in a canoe, and carry them in procession round his house; these things were burned, 'the people believing that the fumes and smoke ascended to the soul of the dead and was pleasing and acceptable to him' (Bancroft, *NR*, 1875, i. 783). In W. America, among the Californians, money is placed in the mouth of the dead. The New Mexicans place in the grave several kinds of food, and the utensils and implements with which the dead man earned his living, while on the lips of dead infants milk is dropped from the mother's breast. The Corahs of Mexico, if the deceased possessed cattle, placed meat upon sticks in the field, lest the spirit might claim the herds he formerly owned. The Central Americans place food with the dead

to support them on their long journey. Among the Mosquitos, a hut stored with food, drink, and other articles is erected over the grave; the water which disappears from the porous jars is supposed to have been drunk by the spirit, and it is a good sign if birds eat the food (*ib.* i. 359, 590, 641, 709, 744). The Carajas of Brazil lay with the corpse an ample store of bananas and other food, which is renewed from time to time (D. G. Brinton, *The American Race*, New York, 1891, p. 261).

(14) *Modern Europe*.—The custom prevails even in England. Some years ago, while a grave was being dug in Bucklebury churchyard, an old grave was disturbed, and two bottles of beer were unearthed.

'They had been buried according to a custom with the body of a person who was given to drink, and in order to give him a fair start in the land to which he had journeyed' (*FL* x. 253).

In India, brandy and cigars have been deposited on the tomb of a European who was addicted to the use of such luxuries in his lifetime (Crooke, *PR*², 1896, ii. 199; Thurston, *Ethnographic Notes in S. India*, Madras, 1906, p. 296 f.). In Brittany at the present day the hollow of the tombstone is filled with holy water, and milk libations are poured upon it.

'On that night the supper is left spread in every household, and the fire burning, so that the souls of the dead may come from the graveyard to feed and to warm themselves' (M. R. Cox, *Introd. to Folk-lore*, London, 1895, p. 55).

3. The funeral feast.—An extension of the practice of feeding the dead is found in the custom of the funeral feast, at which, to mark the solidarity of the clan, the kinsmen enjoy a solemn meal in the presence of the dead. Jevons (*op. cit.* 47) suggests as one motive for the custom that

'in the feast which is spread with the dead man's favourite delicacies, to tempt his soul to return, we may have the origin of the funeral feasts and wakes, which are universal.'

Hartland (*LP* ii. 278 ff.) shows reasons to believe that the

'most archaic form, if barbarity be a test of archaism, in which it is known to us, is where the meat is nothing less than the corpse of the departed kinsman.'

This savage rite, he suggests, sometimes undergoes a natural transformation into eating with the dead; but wherever a special food, such as beans, is used, it may be suspected to represent the flesh of the dead man. This is illustrated by the remarkable custom, prevailing in Sicily and Perugia, when, at the festival of All Souls (2nd November), sweetmeats impressed with images of skulls, bones, skeletons, souls in Purgatory, and the like, are eaten. This is called 'eating the dead' (*ib.* ii. 288 n.). This funeral feast undergoes a further development when, as with the Hindus, it becomes periodical; or when, as at the Hallow-e'en rites performed in various parts of Europe, food is prepared in the house, the doors are thrown open, and the dead are invited to enter and feast (*ib.* ii. 312; cf. also *ERE* i. 26 f.).

4. Modes by which food is supplied to the dead.

—The modes by which food is supplied to the dead are varied. Sometimes, as among the Lingāyats of S. India, death is anticipated by placing food in the mouth of the dying person (*BG* xxi. 150). Others place food in the mouth of the dead, as in some cases recorded in this article. In Malabar, when the corpse is laid on the pyre, rice is scattered over the face and mouth, and pieces of gold are placed over the nine openings of the body (Logan, *Manual of the District of Malabar*, Madras, 1887-91, i. 129). The Todas drop milk into the mouth of the dead; the Gulguliās of Bengal pour spirits on his lips and kill a cock to feed the spirit (Rivers, *op. cit.* 343; Risley, *TC* i. 303). It is a very common practice to lay food on the grave, on the theory that the souls of the dead reside permanently here, the belief in a separate realm of souls growing up under advancing culture and displacing the earlier tradition. The Yoruba of W. Africa,

after the funeral feast, carry to the grave the bones of the fowls and sheep which were sacrificed. 'All the articles which the deceased had in daily use, such as his pipe, the mat on which he slept, the plate or vessel from which he ate, his calabashes, and other things of small value, are carried out into the bush and burned' (Ellis, *Yoruba-speaking Peoples*, 159). The Dayaks hang necessaries for the dead on branches of special trees, or lay them near the grave (Roth, *Natives of Sarawak*, i. 149). The Roman *silicernium* seems to have been a funeral feast held on the day of the funeral, and by the grave (Smith, *Dict. Ant.*², London, 1890, i. 893; Bekker, *Gallus*², London, 1880, p. 520). Sometimes the food is stored in little huts for the use of the dead. The Bahima of Uganda believe that the ghosts of the common folk have no special abode, but wander about near the kraals; they have little huts in which food, drink, and clothing are stored (*JAI* xxxvii. 102). The Karenni of Upper Burma build a small structure on four posts over the grave, and in this are placed various kinds of corn (*Gazetteer Upper Burma*, i. i. 528). It is the custom of many races to spread sand or dust near the place where the food for the dead is laid, and next morning any marks found in it are examined to ascertain into which animal, bird, insect, etc., the soul of the deceased has migrated. Sometimes, again, the spirit is supposed to haunt the house, and here food is provided. At the funeral feast of the Nagas of Assam each member of his sept in perfect silence throws a piece of liver outside the house for the wandering ghost (*JAI* xxvi. 197). Or the offering is made on the road by which the corpse or bones have been carried. The Khāsis of Assam, who dread the attack of spirits, when bringing the bones of the dead for storage in the ossuary, lay out grains of rice, especially on river banks, and, in the case of a specially malignant spirit, let a fowl loose in the jungle as an offering (*JAI* i. 132). Or, in the belief that the food is conveyed to the spirit by the agency of water, the Khyoungtha of Burma lay the food aside for a short time, and then fling it into a river (*Burma Gazetteer*, ii. 687). On the same principle the Kanowit of Borneo use what are called 'soul-boats,' in which necessaries for the use of the dead are floated out to sea, with a strong ebb tide flowing, to meet the spirit (Roth, *Natives of Sarawak*, i. 145). Sometimes the feeding of the dead takes a vicarious form, as when, in India, Brāhmins are entertained, in the belief that they will pass on the food for the use of the spirit. In this class may perhaps be placed the feeding of the so-called 'sin-eater,' of which numerous instances are given by Hartland (*LP* ii. 219 ff.). But the accounts of the custom are not free from difficulty, and the facts have been much disputed. Lastly comes the rite, common in India and elsewhere, of offering food to something representing the dead man—a reed fixed near the place where the obsequies were performed; a stone known as the 'life-stone,' which is believed to be the refuge of the spirit; or, finally, an image of the deceased which is placed among the representations of the family ancestors, to whom periodical offerings are made.

LITERATURE.—In addition to the other authorities cited in the article, cf. esp. Tylor, *Primitive Culture*⁴, 1903, xi; J. G. Frazer, *JAI* xv. 64 ff.; Hartland, *Legend of Perseus*, 1894, ch. xiii.; Robertson Smith, *Rel. Sem.*², 1894, p. 213 ff.; Jevons, *Introd. to the Hist. of Religion*, 1896, p. 45 ff.

W. CROOKE.

FOOL, FOLLY (Biblical).¹—I. In EV of the OT these two terms are the renderings of several groups of Heb. words. The most frequent in occurrence and the most important of them are

¹ For anything belonging to these terms in their ordinary sense, see such artt. as DEGENERATION, DEVELOPMENT (Mental), INSANITY. See also WISDOM.

אָרְל, אָנְלָה, אָנְלָה, אָנְלָה, אָנְלָה. In addition to these הוֹלְלִים ('arrogant') in three passages of the Psalter (5⁶ 73³ 75³), אָנְלָה, אָנְלָה (chiefly in Ec.), אָנְלָה (La 2¹⁴, cf. אָנְלָה, Job 1²³) are to be noted as belonging to the same class of terms. Viewed from the standpoint of Biblical theology, אָנְלָה ('simple'), אָנְלָה ('brutishness'), אָנְלָה ('scoffer'), ought to be grouped with these words. Not one of these Hebrew words rendered 'fool' and 'folly' denotes mental aberration or incapacity. They are a part of the technical terminology of the Hebrew *Hokhmah*, although they are not exclusively found in the books of the Wisdom Literature. They constitute the contribution which this side of Hebrew genius made to the OT conception of sin. Folly is the antithesis of wisdom, and, consequently, this terminology depicts sin in opposition to, and in contrast with, Divine wisdom. In the later books of the *Hokhmah* Literature the Divine attribute of wisdom is personified, and it is certainly hypostatized in those that are extra-canonical. Wisdom thus conceived is God's agent in creation, who has ordained the laws governing nature and the lives of men. Human wisdom is, as it were, a reflex of the Divine, and consists in the capacity to learn the Divine laws controlling men, and in the ability to conform human life and action to them. Whoever lacks this insight and power is styled a fool, and his conduct folly. As wisdom, so also is folly an ethico-religious concept. This is succinctly expressed: 'The fear of Jehovah is the beginning of wisdom: but the foolish despise wisdom and instruction' (Pr 1⁷, cf. 9¹⁰). The attempt has been made to distinguish between the conception of folly without the Wisdom books and that within. Historically it would be more accurate to regard the fully developed and sharply defined conceptions of Proverbs and the Apocryphal books as the crystallization of ideas long held in solution by the Hebrew mind, for 'folly' occurs very early in OT Literature (Gn 34⁷ [J]).

The strongest and most widely distributed term is *nābāl*. Adultery, incest, and rape are termed *nēbālāh*; Achan's sin, the advice of Job's wife and the theories of his friends, practical atheism (Ps 14¹), the hostility of a heathen nation (Ps 74¹⁸), all come under this category. 'Fool' and 'folly' scarcely give the force of the original; 'senseless' would be a more adequate rendering (Driver, *Deut.* p. 256). These terms would then indicate the moral and religious insensibility of the human soul to the ethical demands of God. The fullest definition of a fool in the sense of *nābāl* is found in Is 32⁶: 'For a fool (*nābāl*) speaketh folly (*nēbālāh*), and his heart worketh iniquity.' Then follow two exegetical clauses, 'to practise profaneness and to utter error against Jehovah.' Thus the fool is blasphemous and godless, while his utter disregard for his fellow-men appears in his purpose, 'to make empty the soul of the hungry and to cause the drink of the thirsty to fail.'

In the Book of Proverbs אָנְלָה and אָנְלָה are the standing designations for the same class of men. Etymologically they signify the dullard and the stupid, who have a 'mind made thick, darkened, become like crude matter.' The stupidity of such men renders them incapable of recognizing the laws which God's wisdom has ordained for the regulation of human life and conduct. They are incapable of making ethical distinctions, because their understanding is too darkened for the vision of Divine wisdom and her laws. The fool's stupidity is manifested in many qualities; he is inattentive, obtuse, inapt in expression, fond of folly, improvident, indiscreet, shameless, untrustworthy, unalterable, disgusting, and dangerous. All these qualities are conceived in the ethico-religious spirit.

2. The same terminology is found in the Wisdom-

books of the Apocrypha, Sirach, and the Wisdom of Solomon. In describing the sinner Sirach uses the following terms: *μωρός, ἀφρων, ἀσύνετος, ἀνόητος, ἀπαίδευτος, ἀκαρδίας* (LXX renderings of the Heb. words discussed above). In this section of the Apocrypha the fool and the ungodly man are identical (Sir 22¹², Wis 3¹² *et al.*), while wisdom and piety are synonyms (Wis 4⁹).

3. In the NT 'fool' and 'folly' represent several Greek words, and in most of the passages they have no tinge of the Hebraic meaning, but distinct traces of this technical terminology of the *Hokhmah* Literature are discernible in the Gospels and Epistles. When Jesus said, 'Whosoever shall say, Thou fool (*μωρόν*), shall be in danger of hell fire' (Mt 5²²), when He denounced the Pharisees as 'fools' (*μωροί*, Mt 23^{17, 19}), and in the parable of the Rich Fool (*ἀφρων*, Lk 12²⁰), He unquestionably used these terms with a strong ethico-religious force such as they had in the OT. St. Paul gives evidence of similar OT influence in his use of the phrase 'senseless (*ἀσύνετος*) heart' in Ro 1²¹.

4. In Rabbinical Hebrew the terms אָנְלָה, אָנְלָה, אָנְלָה are used with the ethico-religious meaning of the *Hokhmah*, while מוֹרָא, מוֹרָא with a similar force occur frequently in the Mishna.

LITERATURE.—T. K. Cheyne, *Job and Solomon*, London, 1887; H. Cremer, *Wörterb. der NT Gräzität*, Gotha, 1902, s.v. *ἀσύνετος, σοφός, σοφία*; F. Delitzsch, *Proverbs*, Eng. tr., Edinburgh, 1875; Fey, *Die sittlichen Anschauungen des salomonischen Spruchbuches*, Halle, 1886; W. Frankenberg *Sprüche*, Göttingen, 1898, *passim*; J. Kennedy, *Hebrew Synonyms*, London, 1898; C. F. Kent, *The Wise Men of Ancient Israel and their Proverbs*, Boston, 1899; W. Nowack *Die Sprüche Salomo's*, Munich, 1883; G. F. Oehler, *Theol. of OT*, Eng. tr., Edinburgh, 1875, pt. 3; H. Schultz, *Alltest. Theol.*, Göttingen, 1896, p. 523 f.; C. Siegfried, *Philo von Alexandria*, Jena, 1872; R. Smend, *Alltest. Religionsgesch.*, Freiburg, 1899, pp. 483-493; C. H. Toy, *Proverbs*, Edinburgh, 1899, *passim*; H. Wace, *Apocrypha*, London, 1888 (Speaker's Com.).

JAMES A. KELSO.

FOOTPRINT.—See ADAM'S PEAK.

FORCE.—I. Definition.—The term 'force' is, unfortunately, used in many senses: some professedly figurative, some intended to be scientific, but often entirely incorrect. No mischief arises from the common use of phrases such as 'force of mind,' 'force of habit,' 'force of example,' 'economic force,' etc. Nor is there any harm in perpetuating the language which spoke of heat, light, or electricity as 'forces of Nature,' and of their 'correlation.' Such things are so far removed from what is now meant by 'force' in its technical sense that no confusion arises from this kind of figurative speech. But 'force' has sometimes been used, even by those who ought to have known better, for the muscular sense of resistance, and for each of the quantities which physicists call respectively 'energy' and 'momentum.' The word is made to bear each of these senses, in turn, in one context, by Herbert Spencer (*First Princ.*, 1884, p. 432 f.), to the hopeless confusion of his argument. 'Persistence of Force' is an incorrect synonym for 'Conservation of Energy'; but the erroneous identification of 'force' and 'energy' (*q.v.*) is of long standing, and the confusion is traceable back to Leibniz (1646-1716).

Apart from figurative application and incorrect usage, the term 'force' has held various significations in the history of science, and has stood for quantities or conceptions of varying degrees of abstractness. Hence the obscurity which attaches to the word. In mediæval thought, 'force' was abstracted from 'matter,' and hypostatized as an independent reality. Occult forces were postulated as residing in bodies, and were but a name for latent capacities of various sorts. With the dawn of modern science, however, 'force' began to be reserved to denote the *vera causa* of an observed change, such as a change in motion.

The history of the scientific usage may best commence with Newton's (1642-1727) laws of motion. Newton speaks of a *vis insita*, or inherent force, which he defines as a power of resisting, a power in virtue of which every body persists in its state of rest or of uniform motion in a straight line. This force does not differ from the inertia of the body, so that *vis inertiae* is a 'most significant name for *vis insita*.'

Such inherent force, assumed by Newton, is a universal property of matter, essential to its occupation of space; and, inasmuch as inertia is force, there is no such thing, for Newton, as inert or inactive matter. This *vis inertiae*, however, acts only when an external force (*vis impressa*) is brought into relation with the body in which it resides. The exertion of *vis insita* then becomes *vis impressa*. Thus Newton's three kinds of force are partly the same thing regarded in different ways. From the conception of *vis insita* the metaphysician may set out for his examination and analysis of the nature of matter; while the scientific investigator, who is rather concerned with the observed behaviour of portions of matter, i.e. the operations or phenomenal changes of material bodies, has scarcely any need to deal with *vis insita*, but takes his start from the concept of *vis impressa*. This aspect of 'force' is therefore the one which, since Newton's time, has almost exclusively been adopted by physics.

2. Force as '*vis insita*.'—When we analyze the conception of matter, as used in the most general sense, without reference to its discrete or continuous structure, the rest or motion of its parts, it seems necessarily to involve the concept of force. Force, in fact, is its coherence and occupation of space. The absolute hardness of the ultimate particles of matter, assumed by Newton in his *Opticks*, was increasingly found to be a difficult hypothesis, and the configuration and resistance of material bodies came to be explained solely by 'forces.' Boscovich (1711-87) resolved these atoms into mere mass-points or centres of force, without extension, so necessary is the idea of force to the conception of matter. Thus matter and force imply one another; they cannot be looked upon as separate entities capable of independent existence. Force is simply the activity of matter, or matter conceived as 'doing'; it is the 'efficiency' which constitutes the 'course' of Nature. Like 'feeling,' 'force' cannot be defined; it is similarly an ultimate and unanalyzable element. Considered in itself, it is but an abstraction. Or again, as with matter, we can describe its specific modes, but not itself. From this point of view, force cannot be looked upon as the 'cause of motion,' in the sense of being prior to motion. Motion is a state or accident of matter—a less abstract conception than force (*vis insita*); and there is nothing to suggest or to authorize the assumption that primordially matter existed in a state of rest, and that its motion was produced after its own genesis.

Newton conceived all 'action' of matter on matter to be mechanical, i.e. to be contact-action, of the nature of pulling or pushing. He had a horror of the notion of what is called 'action at a distance,' which seemed to some of his followers to be nevertheless involved in his theory of gravitation. And since his day the idea of action at a distance has been scouted by physicists as a heresy. This kind of action would, indeed, be difficult for us to 'explain'; but it may be asked whether discontinuity or absence of contact must not occur, in infinitesimal degree, even if we take the material world to consist of particles or elements immersed in an ethereal medium. In that case the difference between contact-action and action at a distance would be only in degree. Incongruity with pre-

conceived notions is not necessarily a proof of impossibility; moreover, the prepossession is in this case probably due to the accident that our sense of touch happens to be the most highly developed, and impact the most familiar form of action.

3. Force as '*vis impressa*.'—Newton's three laws of motion are as follows:

1. Every body persists in its state of rest or of uniform motion in a straight line, unless it is compelled by impressed forces to change that state.
2. Change of motion (i.e. momentum, here) is proportional to the impressed force, and takes place in the direction in which the force is impressed.
3. Action and reaction are equal and opposite.

Impressed force, or force which is not merely the tendency to motion, but which 'acts,' is seen from these laws always to involve more than one body or portion of matter. Force, then, in this aspect (i.e. as 'impressed' or external) is always a reciprocal action, a *stress*. From the first law is deduced the definition of force which has till lately been universally adopted in the text-books of physics: 'force is that which produces, or tends to produce, motion, or change of motion'—change, i.e., either in direction or in velocity. Of course, this definition is metaphysical in so far as it makes force an efficient cause which 'produces' change of motion. Physical science, however, knows nothing of efficient causes (see CAUSE, CAUSALITY); and, showing itself anxious to disentangle itself from metaphysical implications, has recently sought to remove such terms as 'force' from its vocabulary. So the idea of impressed force is being abandoned as anthropomorphic. The modern movement seems largely to have been determined by the following passage in Kirchhoff's *Vorles. üb. math. Physik.*, Leipzig, 1876, 'Vorrede':

'It is usual to define mechanics as the science of forces, and forces as the causes which produce, or tend to produce, motion. This definition has certainly been of the greatest use in the development of mechanics, and still is so to students of the science, if it is explained by examples of forces taken from the experience of ordinary life. But there attaches to it the obscurity from which the concepts of cause and tendency cannot be freed. . . . On these grounds I propose as the task of mechanics that of describing the motions which take place in Nature, and the description of them in the completest and simplest way. I mean, therefore, that we should concern ourselves only with stating what the phenomena which take place are, not with assigning their causes.'

This advice has been followed by many leading physicists. The tendency is rather a return to the intentions of earlier science—that of Copernicus, Galileo, Descartes, and Newton—than a new step. It is, however, likely to prove rich in consequences, in that it involves the confession, on behalf of science, that it has nothing to do with ultimate explanation, but that its rôle is mere description in terms of 'conceptual shorthand.' It removes from 'naturalism' the usurped right to speak in the name of science.

The definition of force which thus seems destined to become obsolete in science is, accordingly, being replaced by others, which use the term merely as denoting a relation, a mathematical quantity. Newton's second law furnishes a quantitative definition of force, or a method of measuring the relative magnitude of forces. The law may be expressed by the equation $P = mf$, where P = the force, m = the 'mass' of the body acted upon, and f = the acceleration produced in it. For f we may substitute $\frac{v}{t}$, where v = velocity acquired, in the interval of time t , by a body moving with a uniform acceleration of f units. Hence our equation becomes $P = \frac{mv}{t}$, or force is represented as 'rate of change of momentum.' Thus is force coming exclusively to be used in physics. And, indeed, this is all that empirical science is entitled to denote by the term. For experience only yields us changes

in the motion of bodies; it does not bring us face to face with 'forces' in the older sense. At the same time, science, in thus becoming purely dynamical, abstract, and descriptive, only ignores causation and efficiency; it leaves 'forces,' in the metaphysical sense, to metaphysics, which is concerned to see in them the imperceivable relations of dependence between events which uniformly follow one another. See also ENERGY, MATTER.

LITERATURE.—Newton, *Principia*, 1726 (ed. Thomson-Blackburn, Glasgow, 1871); J. Clerk-Maxwell, *Matter and Motion*, London, 1876; Shadworth Hodgson, *Metaph. of Experience*, London, 1893, esp. vol. ii.; P. G. Tait, *Recent Advances in Physical Science*, London, 1876, Lect. xiv.; F. R. Tennant, *JThSt* i. [1899] 347. F. R. TENNANT.

FOREIGNERS.—See STRANGERS AND FOREIGNERS.

FOREKNOWLEDGE. — See PREDESTINATION, PRESCIENCE.

FORGERY.—The *crimen falsi* of Roman law (which, however, included also making and uttering of false coin, perjury, and corrupting of witnesses) is defined by Blackstone: 'the fraudulent making or alteration of a writing to the prejudice of another man's right' (*Comm.* iv. 247). This is a definition of the offence as it existed at common law; but there was formerly, if there is not still, an important difference of opinion as to the kind of writing to which the common law offence extended. It was agreed that the counterfeiting of a matter of record, authentic matter of a public nature, a deed or a will, is forgery; but there were strong opinions that counterfeiting of any writing of an inferior nature is not forgery at common law, at any rate unless some one actually receives a prejudice from it (see Hawkins, as cited in Bacon's *Abridgement*, iii. 747); and more recently it has been stated that 'it is not possible to say precisely what are the documents the false making of which is forgery at common law' (quoted in Stephen's *New Commentaries*, iv. 147). In an important decision in 1725 it was, however, held that forgery extends to instruments of every sort; and the law is so stated by Bacon (iii. 748)—a view which is confirmed and extended by Stephen (*Dig. Crim. Law*⁵, 350).

A great variety of statutes, reaching from 1562, in the reign of Elizabeth, to late in the reign of Victoria, have multiplied cases of the offence, as well as varied the punishment. Forgery at common law was only a misdemeanour, punishable by fine, imprisonment, or pillory. In the statute of Elizabeth, while a severer punishment was instituted, only a second offence was felony without benefit of clergy. In the Acts passed during the 18th cent., a far greater degree of severity was reached. Forgery was generally treated as a capital offence—a punishment which was inflicted in the well-known case of Dr. Dodd in 1777. The extreme penalty of the law was abolished by Acts passed in the reigns of William IV. and Victoria, and punishment varying between transportation for life and imprisonment for one year substituted.

In this recurring statutory addition of particular cases, the English law of forgery runs through a development somewhat parallel with the similar Roman law. The *lex Cornelia de falsis*, called also *testamentaria*, was passed under the dictatorship of Sulla (81 B.C.). The *Institutes* (iv. 18. 7) say this law 'inflicts punishment on any one who shall have written, sealed, read, or substituted a false testament, or any other instrument, or shall have made, cut, or impressed a false seal, knowingly and with felonious intent.' The punishment, in the case of a slave, was the extreme penalty of

the law; in the case of freemen, deportation. By other legislative enactments the penalties of forgery were extended to the fabrication of written instruments other than wills (see *Dig.* xviii. 10).

Although in Blackstone's time the number of cases in which severe punishment was inflicted had been so multiplied 'as almost to become general,' and although in 1861 a statute was passed consolidating and amending the law relating to forgery, still no general definition is given in these or any subsequent statute. Cases are strung together empirically, just as they arose, and are described with a surplusage of legal verbiage, the precise effect of which it is often difficult to estimate and generalize.

The legal meaning of forgery is by no means confined to counterfeiting a name, or writing, or seal.

'The notion of forgery,' says Matthew Bacon, 'doth not so much consist in the counterfeiting of a man's hand and seal, which may often be done innocently, but in the endeavouring to give an appearance of truth to a mere deceit and falsity; and either to impose that on the world as the solemn act of another, which he is in no way privy to, or at least to make a man's own act appear to have been done at a time when it was not done, and by force of such a falsity to give it an operation, which in truth and justice it ought not to have.'

With regard to the act of forgery, it is to be observed that the offence is complete by the making with fraudulent intent, and that a person may commit forgery by making a false deed in his own name, as by antedating a deed so as to make it appear prior to a conveyance previously executed by him; by signing the name of a fictitious person, or his own name, if represented to be distinct from that of the person signing; by introducing into a document, without authority, whilst being drawn up, what may alter its effect; and, in certain cases, even by omitting, without authority, that which by its omission may alter the effect of other parts.

As regards the instrument, it must be a document which, if genuine, would have apparent validity, though it is immaterial whether it would have actual validity or not. The falsity must lie in the instrument itself—in its not being what it purports to be, not in its merely containing a false statement. It must be a document or writing. Counterfeiting an artist's signature on a painting is not forgery. The fabrication may either be of the whole or of a part, as filling in, without authority, a cheque signed in blank; or an alteration, if material, may constitute a forgery.

As regards intent, it is unnecessary that there should be a special intent to defraud any particular person. A general intent is sufficient, whether there is or is not any person actually defrauded or liable to be defrauded. Mere intention to deceive, as distinct from intention to defraud, is not in general sufficient to constitute forgery. The same is true of forgery of a letter as a practical joke. It is also not forgery to induce another by fraud to execute a document.

LITERATURE.—*Corpus Juris Civilis*, esp. *Dig.* xviii. 10, *Inst.* iv. 18. 7, Sandars' 7th ed., London, 1883, Moyle's 4th ed., Oxford, 1903; W. Blackstone, *Commentaries*, Christian's ed., London, 1830, vol. iv.; H. J. Stephen, *New Commentaries*⁸, London, 1880; M. Bacon, *New Abridgement of the Law*⁷, London, 1832, vol. iii.; S. F. Harris, *Principles of the Criminal Law*⁹, London, 1899; J. F. Stephen, *Digest of the Criminal Law*⁵, London, 1894; A. W. Renton, *Encyc. of the Laws of England*, London, 1897-98, vol. v.; H. Roscoe, *Digest of the Law of Evidence and the Practice in Criminal Cases*¹³, London, 1908; A. H. Post, *Grundriss der ethnolog. Jurisprudenz*, Oldenburg and Leipzig, 1894-95, ii. 409. GEORGE J. STOKES.

FORGETFULNESS.—I. Nature.—'A good memorie,' says Roger Ascham (*The Scholemaster*, bk. i.), 'is well known by three properties: that is, if it be quicke in receyving, sure in keping, and redie in delivering forthe againe'—in other words, it depends on the clearness and distinctness of the original impression, on its power of retention, and on its power of reproduction or resuscitation.

These properties are clearly conditioned by the state of the mind, and of the body as well, at the moment when the impression is made, as also by frequency of repetition, and, further, by the working of association through similarity and contiguity. Great, however, as the tenacity of memory may be—in some people, 'even to a miracle'—the best memories forget; there is a limit to the retentive and reproductive powers of the mind. This arises partly from the enormous mass of materials that the matured mind has to deal with, and partly also from the fact that, in memory, we never resuscitate the whole of a past experience, but only selected portions of it (only what we have *interest* in and what we have *use* for); the remaining parts, through want of being occasionally brought back, drop out of our power of recall. Hence Hobbes, in a very felicitous phrase, designated imagination, and, therefore, memory, 'the decaying sense'; and Locke has a touching passage on the decay of memory:

'The memory of some men, it is true, is very tenacious, even to a miracle. But yet there seems to be a constant decay of all our ideas, even of those which are struck deepest, and in minds the most retentive; so that if they be not sometimes renewed, by repeated exercise of the senses, or reflection on those kinds of objects which at first occasioned them, the print wears out, and at last there remains nothing to be seen. Thus the ideas, as well as children, of our youth, often die before us: and our minds represent to us those tombs to which we are approaching; where, though the brass and marble remain, yet the inscriptions are effaced by time, and the imagery moulders away. The pictures drawn in our minds are laid in fading colours; and if not sometimes refreshed, vanish and disappear' (*Essay Concerning Human Understanding*, bk. ii. ch. x. § 5).

Whether, however, any impression once received ever absolutely vanishes and disappears—so as not to be within the power of recall under any circumstances whatever—is a doubtful point. Without pushing to the extreme the testimony of people who have been nearly drowned that, in this experience, the whole of their past lives came vividly before them in an instant, it may yet be questioned whether, under certain conceivable circumstances, any experience may not be recallable to the mind. But forgetfulness, in the practical if not in the ideally theoretical sense, is a fact; and what we have now to do is to look at the causes and the law of it.

2. Causes.—(1) One cause is *faintness in the original impression*. This may arise from lack of intensity in the impressing object, or from lack of vigour in the organism at the moment when the impression was made. In either case, the intellectual discrimination is poor, and interest sufficient for effective retention has not been created, and so there has been no motive to repeat or reproduce the primary experience. But, even when interest has been aroused and a certain amount of repetition secured, the impression may be transient. A case in point is what is known in education as 'cramming.' Getting up knowledge for an occasion is quite different from studying from the love of knowledge. Only the latter gives what abides: remembering for a definite, temporary purpose naturally ceases when the purpose has been served.

(2) Another cause is *enfeeblement or injury of the bodily organism*—as seen in old age, or in disease of the brain. The case of old age is significant, since forgetfulness here follows a definite order. As old age creeps on, recent impressions are forgotten first; earlier impressions remain. The meaning of this is that recent impressions made in old age, even though vivid at the moment, have not been registered and conserved by repetition, and so are lacking in points of association, whereas the impressions of earlier years have become stable through repetition and have formed many points of attachment with other parts of the memory series. Moreover, the earlier impressions were made when nutrition and circulation of the

blood were vigorous, when the physical system was strong and active, whereas the impressions made in old age appeal to enfeebled nutrition and circulation and to a decaying physical system. In this way, we see why it is that old people forget recent events, but retain a memory, often wonderfully full and exact, of what happened in their childhood and youth. 'What first seizes sticks,' as Berkeley puts it: the vigour of the organism secures that, in part; and, for the remainder, the result is produced by association and repetition; and necessarily, when the more recent goes from the memory, the earlier remains in full possession. Still more, earlier experiences are associated with the pleasure that old age has in dwelling in the past, seeing that length of time has mellowed the recollection of bygone days and thrown a halo of glory round them; for it is a notable fact that the mind is not retentive of pain, and so is disinclined to revive painful incidents or experiences, but clings to the thought of pleasure, and its natural tendency is to idealize the past—the Golden Age seems ever behind us. It has further to be observed that, when loss of memory in aged persons begins, it shows itself usually in a tendency to forget people's names. This is in accordance with the nature and working of contiguous association. The identity of the people themselves is quite well recognized; only their names are forgotten. This means that, although we do associate a person with his name during all the time we have known him, nevertheless what specially interests us about him, and what, therefore, impresses us most, is not his name but himself—the concrete individual, living somewhere in space under definite circumstances, pursuing a particular calling, and making a certain mark in life. The image of him, consequently, remains when his name has gone from us.

(3) A peculiar case of forgetfulness arises from *the power of a direct experience of actuality to obliterate or annihilate a previously formed idea of the actuality*. Suppose, for instance, that we try to realize from the description given by another the idea of a place that we have never ourselves visited. Our mental picture is sure to be in many respects erroneous, however full and however powerful the description may be. We naturally picture the unvisited place on the basis of some place or places well known to us, which we suppose to be similar, and the analogy will in many points deceive us. But suppose, now, that we *actually visit* the place which we have as yet only imagined. The result is that, when we come to have experience of the actuality, the vividness of the impression (its warmth and fullness) lays hold upon us so as to exclude all the erroneous parts of the previously formed picture from the mind—the reality and the previous idea will not combine; until, after a time, it becomes altogether impossible for us to call up the original erroneous picture, or possible to call it up only in the vaguest fashion. The reasons are obvious. Partly, we lose interest in bringing back erroneous ideas, after we have obtained accurate impressions of the reality; and, partly, these ideas drop away, because the reality refuses to combine with them. This last fact explains to us how it is that we so readily, as a rule, forget our dreams. However vivid a dream may be, it has not the power upon us of waking experience; and so, when we awake, and are brought under the influence of the objective world, our dream-images necessarily flee. They cannot, in the first place, compete with the vivid insistence of reality; but, in the second place, they do not fit into the ordered train of our waking experiences—they are not on the line of our continuous wakeful existence.

(4) Lastly, forgetfulness may be due to *excite-*

ment. In a moment of excitement, when the nerves are agitated, the memory becomes, partially or wholly, a blank. Many a person, on rising for the first time to speak in a public assembly, has felt this; and, in a less marked case, any one may, through having a question put to him suddenly or abruptly, be unable to make an immediate reply. Although the question may be one that he could quite well answer in a calm mood, the abruptness of the inquiry has disturbed his equilibrium, and the answer has fled. No better example of the power of excitement to produce forgetfulness could be adduced than the case of Cassim, and his futile efforts through excitement to recover the mystic and all-potent word 'Open Sesame,' in *Ali Baba and the Forty Thieves*. The workings of the human mind were obviously the same in the days of Harun al-Rashid as they are to-day.

3. Law.—The great law of forgetfulness is that, under normal circumstances, we forget a thing only by occupying the mind with something else, i.e. by losing interest in it through acquiring interest in something else. We cannot simply will to forget and the thing is done. If we push something out of the mind, we must fill the vacancy somehow. Extrusive power belongs to a new interest. This may be exemplified by the injunction, so often given to us when we are injured, 'Forgive and forget.' This, on the face of it, seems an injunction to do what is impossible; for, when an injury, deliberate and designed, is inflicted on us, it is only human nature (so we phrase it) to resent it, and, consequently, to harbour ill-will towards the perpetrator of the wrong. But, though we cannot forget an injury when the perpetrator does not seek and obtain forgiveness, it is altogether different when he does. For it is the nature of forgiveness not only to pass by the offence, but also to take the offender into favour again and to identify oneself with him and with his penitent attitude. A new and absorbing interest now takes possession of us, and, the more we identify ourselves with the penitent, the less are we disposed to remember his offence: both he and we have entered on a new course together, and the attainment of the new end occupies our attention, as it fills our hearts, and forgetfulness naturally ensues when there is no motive and no purpose in life to keep up the memory. In this, obviously, we have the key to the meaning of Scripture when it speaks of God as forgiving and forgetting men's sins: 'I will forgive their iniquity, and their sin will I remember no more' (Jer 31³⁴; cf. He 10¹⁷). Without forgiveness, that could not be; but with forgiveness, if the analogy of human procedure is to hold with the Deity at all, it is inevitable.

Cf. also artt. DEVELOPMENT (Mental) and MEMORY.

LITERATURE.—Plato, *Philebus* and *Theætetus* (on the one hand, the simile of the soul or mind as a book, in which memory as a 'scribe' [γραμματεὺς] writes, and imagination as a 'painter' [ζωγράφος] paints 'images' [εἰκόνες] of what is perceived; and, on the other hand, the similes of the soul as a wax tablet [κνήρινον ἔκμαγειον] and as a columbarium or 'dovecot' [περιστερῶν]); Aristotle, *de Memoria* (tr. by J. I. Beare, Oxford, 1908); J. Locke, *An Essay Concerning Human Understanding*, bk. ii. ch. x. (ed. A. Campbell Fraser, do. 1894); works of the Scottish Philosophers, e.g., Thomas Reid, James Beattie, Dugald Stewart, Sir William Hamilton (esp. Hamilton's *Lectures on Metaphysics*, London, 1859-60, ii. 205-258, and his Note D** in his ed. of *Reid's Works*, Edinburgh, 1863); James Mill, *Analysis of the Phenomena of the Human Mind*, ed. J. S. Mill, London, 1869, vol. i. ch. x.; Herbert Spencer, *Principles of Psychology*², do. 1870, i. 444-452; A. Bain, *The Senses and the Intellect*⁴, do. 1894, chs. ii.-iv. under 'Intellect'; J. Sully, *Outlines of Psychology*, do. 1884, pp. 275-300; H. Höfding, *Outlines of Psychology*, do. 1891, ch. v.; W. James, *Principles of Psychology*, do. 1891, i. 643-689; James Ward, art. 'Psychology,' in *EBr*⁹, vol. xx. (Edin. 1936); G. F. Stout, *Manual of Psychology*, London and New York, 1890, p. 435, etc.; H. J. Watt, *Economy and Training of Memory*, London, 1909.

WILLIAM L. DAVIDSON.

FORGIVENESS (Hebrew).—I. DIVINE.—In the view of all the Hebrew writers the God of Israel entered into personal relations with His people. His will was ethical also, and the problem of sin and forgiveness must have a prominent place where the ethical will comes into contact with another will. For the most part the mind of Jahweh towards His people was a gracious one. All that Israel possessed was His gift—the goodly land of Canaan, rain from heaven, success against the enemy. When disaster or misfortune came, it was clear that His anger had been aroused. The conscience of the nation was then quickened, and inquiry was made as to the occasion of the wrath. In all this He was supposed to be moved as a man might be moved; one might 'find grace' in His sight as one might 'find grace' in the sight of a fellow-man, or one might offend Him and placate Him, as happened in the relations of men to each other.

1. In the earliest times.—In early society, rights and claims are based on tribal custom or on a covenant between the parties. Among the Hebrews the earliest conception of sin seems to have been that it was a violation of the covenant rights of Jahweh. The earliest Decalogue (Ex 34¹⁰⁻²⁶) defines His dues. He was to receive the first-born males; He was to be honoured by the observance of the three great festivals, and by cessation of work on the Sabbath. Besides this, certain practices which were uncongenial to Him were to be avoided—the worship of other gods, the use of leavened bread at the sacrifices, the boiling of a kid in its mother's milk. The withholding of any of these dues would rouse His wrath, and the solidarity of the nation was such that it would suffer as a whole. The earliest conception of forgiveness was that, on the removal of the cause of offence, Jahweh would turn again to His people and be gracious. When Achan committed sacrilege (Jos 7), the whole people suffered defeat; when Achan and his family were executed, the people were restored to favour. When Saul violated the oath taken by Israel, the land was visited by famine; the impaling of Saul's sons brought back the rains (2 S 21). If forgiveness be the free restoration of the offender to the favour he has forfeited, there is no forgiveness here. But, if it be the change of mind of the offended party on satisfaction rendered, it is granted in these cases.

It is not necessary, even in the earliest view, that the satisfaction be an act of punishment. The Philistines, when they felt the wrath of Jahweh, made their acknowledgment in the form of golden offerings (1 S 6²⁰); and, when the people had provoked wrath by their conduct in the wilderness, the intercession of Moses was effectual (Ex 32³⁰). In the latter case, however, we should note that the punishment of the actual offenders, or at least some of them, went along with the intercession. In view of this we shall understand the declaration of an early author that Jahweh is a God merciful and gracious, patient and abundant in kindness, who takes away (that is, forgives) guilt and transgression and sin, yet does not leave unpunished, but visits the guilt of fathers on children and descendants of the third and fourth generation (Ex 34^{6f}).

It is a distinct advance on this view when Jahweh is seen to be the protector of the rights of members of the community. A step in this direction is taken when He is made a party to the obligations taken by the community. The case of the Gibeonites already alluded to is in point. By the violation of the oath taken by the Israelites, Jahweh was made angry. This was a national matter—an affair with another tribe. What we

now have in view is within the nation itself. Jahweh takes the part of the client, the widow, and the fatherless—of those who have no other protector. Sin against a brother man now becomes sin against Jahweh. The cry of the oppressed comes into His ears: 'If he cry to me, I will surely hear his cry, and my anger shall burn, and I will slay you with the sword, so that your wives shall be widows and your children shall be orphans' (Ex 22²³). The question of forgiveness became more complicated as this class of sins occupied the thoughts of reflecting men.

2. In the earlier prophets.—These men were fully convinced that the nation as a whole was the unit with which God dealt. They were at the same time thoroughly persuaded that the oppression of the poor by the rich had roused the wrath of their Protector. The conclusion was easy to draw—the nation must be punished. Jahweh is a God of justice; His love of His people could not induce Him to spare the guilty. The very fact that He had been so gracious to them in the past was a reason why He should hold them to a stricter account now. The confidence of the people at large, that He will not permanently estrange Himself from His own, is seen by these men to be only one more sign of the incurable levity and blindness of the nation. It is not to be wondered at that they have little to say of forgiveness. Their emphasis is laid on the certainty of punishment. The greater moral earnestness of their point of view is obvious. The mass of the people thought that forgiveness might be purchased by sacrifices or by professions of repentance. The prophets declared the sacrifices to have no value, and compared the repentance to the morning mist which early vanishes away (Hos 6⁴).

Abstractly there always existed a possibility of forgiveness. We cannot otherwise understand the preaching of the prophets at all. Some slight hope that the doom might yet be turned away must have animated them. And in fact they declare that, if the people turn to Jahweh, He will turn to them. 'Let justice roll on as waters, and righteousness as a mighty stream,' says Amos (5²⁴). The implication is that in that case Jahweh will again receive them. Similar statements by Hosea, Micah, and Isaiah show that they all held the conviction of Jahweh's willingness to forgive. No other condition would be imposed than that of ceasing to do evil and learning to do well (Is 1¹⁶). But the sadness of the situation arose from the fact that Israel had sinned away the day of grace. Twice, as Amos sees in vision, Jahweh of His mere good pleasure has turned away the impending calamity. This cannot be expected to go on for ever. This third time the plumb-line is set to the wall, and further respite is not to be expected. Hosea is equally severe, though he has a more adequate idea of the tenderness of Jahweh. In spite of the yearning which cries 'How can I give thee up?' He will meet the recreant people with the fury of a bear robbed of her whelps.¹

3. In Isaiah.—The impression that Isaiah is distinctly a prophet of forgiveness cannot be verified from his genuine prophecies. The words usually interpreted in this sense should be rendered: 'Though your sins be as scarlet, let them become white as snow; though they be red like crimson, let them become like wool' (1¹⁸). They are an exhortation to the people to amend their ways and their doings. (For other interpretations, see Duhm or G. B. Gray, *ad loc.*) The wrath of Jahweh rests upon the land in the view of Isaiah, just as it does in the view of Amos. One passage which

¹ Hos 13⁸; cf. 11⁸, Am 4¹². The words of encouragement with which the books of Amos and Hosea now conclude are later additions.

implies the abstract possibility of forgiveness is intended only to deny its actuality: 'This guilt shall not be expiated for you till you die' (22¹⁴). The very purpose of the prophetic mission, according to the prophet, is to harden the people in their evil courses and blind them so that they cannot see their true interest (6⁹). The prophet himself, indeed, is purified for his work by a special act of Divine grace (v. 7). But this is the exception which proves the rule; one who is called to Jahweh's work must be made fit for that work. The doctrine of the remnant, which some find to be Isaiah's leading thought, does not imply forgiveness of the guilty but their punishment; the remnant which survives is made up of the righteous (5²⁵ 6¹³; cf. Mic 2⁷).

4. In Jeremiah.—Of Jeremiah we may say that the pessimism grows more intense as the catastrophe approaches. Like the others, he believes that Jahweh is ready to receive those who do well, but he knows the sin of Judah to be too deeply engraved to be obliterated. When a nation has done evil, and Jahweh determines to destroy, 'if that nation turns from its evil then I will repent of the evil which I had determined to do to it' (18⁸). One of the prophet's messages is motivated by the possibility of repentance and forgiveness: 'Perchance they will listen and turn each from his evil way, and then I will repent of the evil I have determined to do them because of their evil deeds' (26³). But these possibilities are never, in Jeremiah's mind, more than possibilities. If there could have been found *a man* in Jerusalem—one that did justice and sought truth—then Jahweh could have forgiven (5¹). But the search was vain (8⁶). When the heart of the prophet moves him to pray for his people, he is told that, though Moses and Samuel were to unite with him, the result would not be different (15¹).

5. In Deuteronomy.—The Book of Deuteronomy seeks to enforce the ideas of the prophets and at the same time to make them practicable. To this end it adopts a certain measure of priestly and legal tradition. Its conception of sin is that of the prophetic party in general, and on the subject of forgiveness it marks no distinct advance. In its severer moods it tolerates no compromise with evil, and carries out to its logical conclusion the faith, first formulated (as appears) by Elijah, that Jahweh is a jealous God. With an earnestness which might almost be called ferocity, it insists on the destruction of idolatrous sanctuaries and the extirpation of all seducers to the worship of another god (ch. 7). Yet the idea of the authors is that this jealousy is only the reverse side of love, and that the command to love Jahweh is based on His love for His people. The historical sketch with which the book now begins recounts the manifold mercies of the past, and presents Jahweh as a forgiving God. The ingratitude which can despise such love, however, it is intimated, cannot hope for indulgence. 'The wrath of Jahweh will burn against thee and destroy thee' (7⁴). The interest of the writer is more in the punishment of the evil-doer than in his repentance, for only by purging out the evil can the nation be kept in the right attitude towards its God (11¹⁶; cf. 31¹⁷).

6. During the Exile.—The fall of Jerusalem brought into cruel relief the threats of the prophets and of Deuteronomy, and made the problem of forgiveness acute. The exiles were weighed down by the thought that the sins of the fathers rested upon the children and that there was no hope. Their judgment on the past is sufficiently evident in the editorial passages of the books of Kings. Although, for instance, Josiah had done right with all his heart, so that he surpassed all the kings who had preceded him, 'yet Jahweh turned not from the

heat with which his anger burned against Judah on account of all the provocations with which they provoked him' (2 K 23²⁶). At the same time, it would be too much to say that the past gave absolutely no ground for hope. There were many instances in the history which showed Jahweh to be a God willing to hear and help His people. The prayer of Solomon at the dedication of the Temple was now made to express the longing of the people that the God of their fathers would hear and forgive those who cried to Him from the places whither they had been carried by their enemies.¹

7. In Ezekiel.—It was the work of Ezekiel to combat the lethargy caused by the sense of rejection. This prophet, like the older ones, was fully of the opinion that Judah's sin was the cause of her calamity, and his specifications are in substance the same as theirs. Oppression of the client, the widow, and the orphan, bloodshed, adultery, the taking of bribes—these are the things with which the wicked Jerusalem is reproached. But Ezekiel regards these things from the priestly point of view. They are sins to be sure, violation of the righteous will of Jahweh, but they are also repugnant to His 'holiness.' It must be borne in mind that the earlier religion had drawn a sharp line of distinction between sacred and profane. Jahweh was separate from common things, and what approached His presence must be separated from the sphere of common things. Whatever had been in contact with another divinity was abhorrent to Him. To come into His presence with the contagion of uncleanness was to rouse His wrath. It was because the sins of Judah had made her ritually unfit for the presence of her God that He had deserted His Temple. Such was Ezekiel's thought.

As to individual men, Ezekiel held a theory of retribution more rigorous than we find anywhere else in the OT. To counteract the despair of the people, who felt that they were weighed down by the load of accumulated guilt, he was obliged to emphasize individual responsibility. The sinner suffers strictly for his own sins—not the son for the father, or the father for the son. When a man turns from his evil way, then he will be received and dealt with according to his new course of life; and, when the righteous man forsakes the good way, he will be dealt with as a sinner (ch. 18). The difficulty of adjusting the facts to so mechanical a theory of the Divine justice must be obvious. The prophet himself seems to have realized something of this, but his main interest was elsewhere. After the fall of Jerusalem it was his task to show how the nation as a whole might be revived. This he did on the ground of the priestly ideals already considered. For the encouraging thing about the difference between sacred and profane was that Jahweh Himself graciously provided a way in which He might be approached. There were rites of purification which fitted a man for the Presence. These rites were matters of priestly tradition, and it is probable that Ezekiel took them simply from tradition without reflecting on their rational basis. Of their efficacy he had no doubt, and this efficacy was of God's free grace. Now it was certain that the nation was to be restored. This followed from the power of Jahweh. It was not possible to suppose that He would rest under the reproach of the Gentiles, who saw Him delivering over His own people to destruction, and who scoffed at His weakness. If the nation was to be restored, it would be by an act of God's free grace, purifying her from the uncleanness which rested upon her.

¹ Not for your sakes am I about to act, house of Israel, but for my sacred name which you have profaned among the nations. And I will show that my name is sacred, and the

¹ 1 K 8. For the theory of the Deuteronomistic editor of the Book of Judges, see Jg 21⁴ 3⁸ 10¹⁰.

nations shall know that I am Jahweh, when by my treatment of you I show before their eyes that I am God. And I will take you from the nations and bring you to your land, and I will sprinkle clean water upon you, and you shall be clean from all your pollutions; and I will give you a new mind and will put my Spirit within you, and will cause you to walk in my statutes' (Ezk 36²²⁻²⁷, considerably abbreviated).

This is the programme for the good time coming; Jahweh will restore His people and will make them fit for His service. The fitness will be partly external and Levitical. The most elaborate precautions will be taken not to offend the exclusiveness of the sanctuary. The Temple, its servants, its surroundings, will be all that the most rigid ritualist can desire. But along with this there will be an internal change in the people themselves; they will have a mind to obey the statutes of Jahweh, and that these statutes are ethical in their nature we have already seen. Forgiveness for past offences is to be granted, but the main thing is not forgiveness but regeneration. Yet the taking back of the adulteress, the renewal of the covenant with her, and the cleansing of her from all she has done imply a forgiving mind on the part of her God (Ezk 16⁵³, where the RV introduces the word 'forgive' for *kipper*).

8. In the post-exilic prophets.—There can be no doubt that from Ezekiel's time onwards two tendencies manifested themselves in Judaism. On one side, the free grace of God was looked for to forgive past offences; on the other, the utmost care was taken to secure ritual purity. The keen sense of the wrath of God expressed, for example, in the Book of Lamentations drove men to pray for forgiveness without the intervention of priest or altar. The post-exilic prophets encourage the people with specific promises of forgiveness: 'Return unto me, and I will return unto you, saith Jahweh' (Zec 1³, Mal 3⁷). 'As I determined to do you evil when your fathers provoked me to anger, so now have I determined to do you good' (Zec 8¹⁴). Interwoven in the Book of Jeremiah, as we now read it, are several passages which represent this post-exilic view and give specific promises of forgiveness. A celebrated example is the promise of the new covenant which ends thus: 'For I will forgive their guilt, and their sins will I remember no more.' Even more striking is the following: 'In that time the guilt of Israel shall be sought, but it no longer exists, and the sins of Judah, but they shall not be found, for I will forgive those whom I preserve.'¹ But the most delightful and consistent exponent of the forgiving love of God is the great prophet whose words are preserved in the second half of the Book of Isaiah. The words of comfort with which he begins his preaching are accompanied by the assurance that Zion has been forgiven, that she has received the full measure of punishment, and that restoration is at hand (40¹⁷). The glowing promises that follow are based upon the firm conviction of the love of Jahweh for His own: 'Fear not, for I have redeemed thee; I have called thee by name; mine thou art. . . . Because thou art precious in mine eyes, art honoured and I love thee, I will give mankind instead of thee, and nations for thy life' (43¹⁷). The sorrowful experiences of the past could not be ignored, but they were only a momentary ebullition of wrath and would be forgotten in the infinite kindness that is to follow. Zion, though now desolated and afflicted, is assured of the affection of her Husband who keeps her walls ever before Him. 'I am the one who blots out thy transgressions for my own sake, and thy sins I will not remember' (43²⁵; cf. 44²²). Nor is this love a national matter alone. The individual has part in it; even the sinner may count on it: 'Let the wicked forsake his way and the unrighteous man

¹ Jer 31³¹⁻³⁴ 50²⁰ 33⁸. A similar promise is found in Mic 7¹⁸. The exilic or post-exilic origin of all these passages needs no demonstration.

his thoughts; let him turn to Jahweh that he may have mercy upon him, and to our God for he will abundantly pardon' (55⁷). It is unnecessary to multiply quotations, for this part of the OT is familiar to every Bible reader.

9. In the Priestly Code.—The ritual ideas of Ezekiel were taken up by the priestly compilers, whose work is now embodied in the middle books of the Pentateuch. The tradition is here collected and recorded with the idea of avoiding everything that could offend the sacred service, or, if the contagion could not be avoided, with the purpose of purging it away as soon and as effectively as possible. So far as sin comes under the head of ritual defilement, it may be removed by these rites. There is a sin, indeed, that cannot be so removed. Whoever breaks the commandments of God with full knowledge and with deliberate purpose must be cut off from the congregation (Nu 15^{30f.}). But for all other offences there is purification. Certain classes of sacrifices called 'sin-offerings' and 'guilt-offerings' play a conspicuous part in the ritual, but the cleansing efficacy is ascribed as well to other sacrifices, and even to unbloody offerings. How far the removal of such contamination as was treated in this way was forgiveness, in the sense in which we use the word, is extremely difficult to make out, partly because the authors of these directions believed in the efficacy of the traditional rites, and did not concern themselves to explain them, partly because ideas of expiation were imported into the rites from non-Jewish sources. The theory doubtless was that by these rites the impurity was removed, call it forgiveness or call it purgation. See, further, EXPIATION AND ATONEMENT (Hebrew).

10. In the Psalms.—The Book of Psalms has preserved the experiences of believing Israelites in times of suffering and depression. Their temptation was to ascribe temporal misfortune, sickness, or privation to the retributive visitation of God. It is only natural that they should cry out in pain at His turning His face from them. Their settled conviction is that their sins have brought the affliction, though they are often unconscious of sinful motive. Yet in their perplexity they hold fast to the faith that God is merciful and loving. In many cases they are sure of forgiveness, and they are content to endure what He has sent, if only they may have the final revelation of His face. A well-known Psalm recounts the experience of one who had confessed his sin and received the assurance of pardon (32¹⁻⁵; cf. 78³⁸, 65³ *et al.*). Where the history of the nation is reviewed, it is to show the forgiving love and patience of God in the past. And, where the authors prostrate themselves before Him in prayer, the most frequent petition is for forgiveness. It is clear that they do not think of any ritual requirement on which forgiveness is conditioned. On the contrary, they take pains to assure us that God does not ask sacrifice. His requirements are met by repentance and humility.

11. With the Book of Psalms we reach the highest development of OT teaching on this subject. The only thing to add is the declaration of the Book of Jonah that Jahweh forgives even the heathen when they cry to Him. The Book of Joel implies, rather than asserts, that Israel will be forgiven in the Messianic time, but for the Gentiles it has only the severe judgment of God. The Wisdom literature occupies itself with other problems.

II. HUMAN.—Forgiveness of man by man occupied small space in the mind of the Hebrews, if we may judge by the evidence at our disposal. This may be due in part to the nature of the documents, which are interested more distinctly in Divine than in human forgiveness. But in part the social organization of the people accounts for the fact we

have noted. In the early stages of her history, Israel was a group of clans; and the clan recognized no obligations towards those outside the social group. In the later period, religious motives tended to emphasize opposition to foreigners. As between Israelites and Gentiles, therefore, there was no thought of forgiveness. All the cases of actual forgiveness which are narrated in the OT refer to members of the same group. Against the foreigner the nomad boasts that his own right hand is able to avenge a wrong even seventy-seven fold (Gn 4²⁴). Against the foreigner also deceit is allowable, as is illustrated by the conduct of Abraham (12^{10f.}, 20^{1f.}), Isaac (26^{7f.}), and Jacob (30^{25f.}), as well as by David's relations with Achish (1 S 27^{3f.}).

1. In relation to fellow-Israelites.—Within the clan all are brothers, and there is opportunity for forgiveness. Custom, however, sanctioned the *talio*; and, in case of gross wrong, excommunication was visited on the offender. The possibility of forgiveness, however, is indicated by the story of Jacob's reconciliation with Esau (Gn 33^{1f.}). Jacob's offence is notorious and he has reason to fear his brother's wrath, all the more in that Esau is at the head of a predatory band, whilst Jacob is a shepherd and comparatively defenceless. Jacob's gift may be interpreted as an acknowledgment of his guilt, though all that he says is that he will thereby soften his brother's anger (32²⁰). Esau generously attempts to refuse the gift but finally accepts it. The completeness of the reconciliation is indicated in the words: 'Esau ran to meet him and fell on his neck and kissed him' (33⁴).

Since the reconciliation just mentioned takes place before the actual acceptance of the gift, this seems to be a case of real forgiveness. Where a money payment is made in compensation for the injury, it is a question whether the Hebrew writer thought of forgiveness. The story of Joseph, however, speaks of forgiveness in the strict sense of the word. Joseph's brothers, conscious of the wrong they have done him, fear his wrath. And after their father's death they feign a message from him praying that the wrong may be forgiven. The words used are: 'Take away the transgression and sin of thy brothers' (Gn 50¹⁷). Joseph's response implies that vengeance is a matter for God. As for himself, he forgives on the ground that the Divine purpose of good had been accomplished. As all this takes place strictly within the family, it is not probable that the author thought of such a thing as possible between men who were not of the same blood.

In the case of Abraham's prevarication there is wrong on both sides. Abraham deceives Abimelech, and Abimelech (unwittingly) takes Abraham's wife (Gn 20). The reconciliation is effected by a money payment, in return for which Abraham intercedes for Abimelech. The author of the account does not think of either party as forgiving the other. His interest is wholly absorbed in the Divine protection accorded to Abraham. In like manner the reconciliation of Jacob and Laban is narrated with no reference to forgiveness on either side (31^{44f.}).

In a few cases where the Divine forgiveness is alluded to, we may suppose human forgiveness implied. Pharaoh asks Moses to forgive his sin (Ex 10^{16f.}). What he really desires is the Divine forgiveness mediated by Moses, for the sin is really against Jahweh. Where Moses himself implores forgiveness for the people (Ex 32³², Nu 14^{18f.}) we may suppose that the prayer is motivated by his own forgiving spirit, but the narrator does not seem to reflect upon this aspect of the matter. In the quarrel, however, in which Aaron and Miriam took sides against Moses we may suppose Moses

to have forgiven his sister, for he consents to intercede for her. Aaron's request is: 'O my lord, lay not upon us this sin in which we have done foolishly' (Nu 12¹¹).

The life of David affords some examples that should be considered here. Two instances are recorded in which he has his enemy in his power and spares him (1 S 24 and 26). Saul's words imply that this generosity is without parallel. David, however, reveals that he was not moved altogether by generosity. He would not lay his hand on Jahweh's anointed (24⁷ 26⁹). To slay a consecrated person was sacrilege. Even the mutilation of the king's robe is dangerously near that crime, as we see from David's self-reproach (24⁶). There seems to have been a mixture of motives in this case. In the case of Nabal, however, where David forgoes the vengeance which he had sworn to take, no such mixture occurs. Abigail takes Nabal's guilt upon herself and prays David to forgive it. 'Take away the transgression of thy maid' (1 S 25²⁸). The generous gift she has brought reinforces her petition, and David 'accepts her face' (v. 35). The sequel intimates that his conscience had not been clear from the start, for, after all, Nabal was a fellow-Israelite (cf. v. 39).

Jonathan's intercession for David is followed by a temporary reconciliation on the part of Saul, but nothing is said of forgiveness of any real or fancied wrong (1 S 19⁴⁻⁷), and David's generosity towards Meribaal (Mephibosheth) is repayment of Jonathan's kindness rather than generosity towards the house of Saul (2 S 9⁷⁻¹³). Absalom's crime, however, is forgiven, though somewhat reluctantly, by the king; and the woman of Tekoa, who brought about the reconciliation, pleads for forgiveness on the ground that strict justice often works injury (2 S 14¹⁻²⁴). We can hardly doubt that forgiveness would have been granted to Absalom a second time had there been opportunity. David gives us a further example in the case of Shimei, whose grossly insulting conduct was pardoned on his own request (19¹⁷⁻²³). Yet the king did not go so far as to forget the injury, and his resentment made itself felt at the close of his life (1 K 2⁸).¹ In like manner Solomon's forgiveness of Adonijah was not whole-hearted, and an occasion was found for nullifying it (1⁶³ 2²³⁻²⁵).

The above, which seem to be the only specific cases of forgiveness in the Hebrew Scriptures, show us how imperfect was the apprehension of this grace. Exhortations to kindness towards one's fellow-man are frequent, but there seems to be little or no reflexion on the exigency which arises when one has been wronged by his neighbour and seeks forgiveness. The law of *talio* is strictly enjoined, and the Deuteronomist warns against weak compassion on offenders: 'Thine eye shall not pity' (Dt 13⁸ 19²¹ 25¹²).

2. In relation to non-Israelites.—The bitter conflict waged by the prophetic party against foreign religion naturally sharpened opposition to foreigners. Ancient Semitic usage sanctioned extermination of enemies, and the carrying out of this 'devotion' was regarded as a religious duty. Samuel rejects Saul because he shows weakness in this regard (1 S 15), and at a later time a member of the prophetic order denounces Ahab for making a treaty with Benhadad (1 K 20³¹⁻⁴³). The Deuteronomist's stern command to exterminate the Canaanites is the consistent expression of this opposition to foreign custom. There is evidently no room for forgiveness here. Even so genuinely religious a character as Jeremiah has no idea of forgiving his persecutors (Jer 7¹⁶ 11²⁰ 15¹⁵ 17¹⁸ 18¹⁹⁻²³).

The Jewish community in the post-exilic period

¹ If 1 K 21-12 is historical.

is equally uncompromising in its attitude towards foreigners, and the conflict of parties within the community itself embittered the pious minority against the Hellenizers, who had the government on their side. Nehemiah's attitude towards Sanballat is typical (Neh 2²⁰ 4⁴. [Heb. 3³⁶] 10²⁸⁻³¹). The ritual motive came in to reinforce patriotism. The Jews, the sacred people, necessarily regarded all men except themselves as unclean. The prayers for vengeance which recur in the Book of Psalms are in effect prayers for the annihilation of everything contrary to the will of Jahweh (Ps 3⁸ 5¹¹ 11⁶ etc.¹). Hatred of enemies is regarded as a duty, and the faithful hope for a time when with a two-edged sword in their hand they will 'execute vengeance on the Gentiles and punishment on the peoples, binding their kings with chains and their nobles with fetters of iron' (149⁶⁻⁸). This implacable temper inspired the Book of Esther, and the story of Midian's extermination (Nu 31).

But voices of protest were not wanting. The Book of Jonah satirizes the pious people who hope for the indiscriminate slaughter of the Gentiles, and there was always the possibility that the foreigner might become a member of the Jewish community. Rahab and Ruth are examples. Yet neither the narratives which tell us of these cases, nor the abundant exhortations to kindness and compassion which we find in the prophets specifically enjoin the duty of forgiveness. It is not mentioned in the Decalogue, or in Job's list of virtues (Job 31), or in the ethical Psalms (Pss 15, 26, and 101). Only one of the commands of the Priestly Code seems to have it in mind. Here we read:

'Thou shalt not hate thy brother in thine heart; thou shalt surely rebuke thy neighbour and not bear sin because of him; thou shalt take no vengeance, nor shalt thou bear a grudge against the children of thy people, but thou shalt love thy neighbour as thyself: I am Jahweh' (Lv 19¹⁷).

The duty here enjoined is to be exercised towards the fellow-Israelite; but later in the same chapter (v. 33¹) we read:

'And when a client sojourns in your land, you shall not oppress him; like one of your own blood shall be the client that sojourns among you; and thou shalt love him as thyself, for you were clients in the land of Egypt: I am Jahweh your God.'

This passage recognizes the client (the proselyte, we may in fact say) as having equal rights with the native. The AV errs in this and other passages by translating the word (*gēr*) 'stranger.'

Whatever duty of forgiveness is implied in such passages has reference only to born Israelites or to those foreigners who have come into definite relations of clientage with the community. Some passages in the Book of Proverbs have a more definite bearing on our subject than any yet considered. The desirability of forgiveness was certainly in the mind of him who wrote: 'A brother offended is harder to be won than a strong city' (Pr 18¹⁹) and who also said: 'The discretion of a man makes him slow to anger, and it is his glory to pass over a transgression' (19¹¹). In the same book we find the well-known passage: 'If thine enemy hunger, feed him' (25²¹); and an exhortation not to rejoice when our enemy falls (24¹⁷). Unfortunately the somewhat cold morality of this book leaves us in doubt whether genuine forgiveness is in the mind of the wise man, or whether he is taking the position that a slight is beneath the notice of a gentleman. The general sentiment is perhaps expressed by a late writer who thinks that only by the judgments of God will the wicked learn anything, and that leniency will only confirm them in their evil ways (Is 26¹⁰). In the new age, when the wolf shall dwell with the lamb (Is 11⁶), there will, of course, be complete harmony among members of the kingdom; there

¹ Citations according to the Hebrew text.

will be no offences committed, and consequently no need of forgiveness.

LITERATURE.—I. The subject of the Divine forgiveness is discussed in the various treatises on OT Theology, usually in connexion with Atonement and Expiation. The student may consult G. F. Oehler, *Theol. des AT*, Tübingen, 1873-4, § 204 (Eng. tr., Edinburgh, 1874-5); H. Schultz, *Alttest. Theol.*, Göttingen, 1889, ch. xxvi. (Eng. tr., Edinburgh, 1892, vol. ii. ch. vi.); A. Dillmann, *Handbuch der alttest. Theol.*, Leipzig, 1895, § 56; R. Smend, *Alttest. Religionsgesch.*, Freiburg, 1893, §§ 21 and 22; A. B. Davidson, *Theol. of the OT*, Edinburgh, 1904, ch. x.; B. Stade, *Bibl. Theol. des AT*, Tübingen, 1905, §§ 101 and 102. The Biblical material is treated by A. Ritschl in vol. ii. of his *Rechtfertigung und Versöhnung*, Bonn, 1900 (Eng. tr., Edinburgh, 1900). Ritschl's first ed., published in 1874, gave occasion for a fresh discussion of the OT view of Reconciliation and Atonement, and was followed by the monograph of E. C. A. Riehm, *Der Begriff der Sühne im AT*, Gotha, 1877. Riehm was not able to attain a truly historical view of the subject because of his theory of the order of the documents. His essay and that of Ritschl were examined and criticized by Schmoller in an art. entitled 'Das Wesen der Sühne in der alttest. Opfertora' (SK, 1891). His discussion, as indicated in the title, limited itself to the Priestly documents. The most thorough discussion since Ritschl is that of J. Köberle, *Sünde und Gnade im religiösen Leben des Volkes Israel bis auf Christum*, Munich, 1905. The same author has an article, 'Die Sündenvergebung in der alttest. Frömmigkeit,' in *NKZ* for 1905. Less satisfactory is F. Benezewitz, *Die Sünde im alten Israel*, Leipzig, 1907. See also the essay of J. Herrmann, *Die Idee der Sühne im AT*, Leipzig, 1905; one by W. Staerk, *Sünde und Gnade nach der Vorstellung des älteren Judentums*, Tübingen, 1905; and an art. by Kirchner, 'Subjekt und Wesen der Sündenvergebung besonders auf den frühesten Religionsstufen Israels' (SK, 1905). The Hebrew view is treated along with the Babylonian by J. Hehn, *Sünde und Erlösung nach bibl. und bab. Anschauung*, Leipzig, 1903. The theory of the later Jewish documents and their influence on early Christian doctrine are discussed by H. Windisch, *Taufe und Sünde im ältesten Christentum*, Tübingen, 1908. Cf. also artt. 'Atonement' and 'Forgiveness,' in Hastings' *DB* and 'Rechtfertigung' and 'Sündenvergebung' in *PRE³*.

II. On the subject of human forgiveness (Hebrew) there is no special monograph. The attitude of Israelites towards foreigners is dealt with by A. Bertholet in his *Stellung d. Israeliten u. d. Juden zu den Fremden*, Freiburg i. B., 1896.

HENRY PRESERVED SMITH.

FORGIVENESS (NT and Christian).—I. *DIVINE*.—I. In the NT.—The difference between forgiveness as the subject of OT and ethnic religion, on the one hand, and of NT and Christian, on the other, is not so much a difference of terminology, or of accent, or of emotional intensity, or of its end, as of ethical and spiritual purity. In all alike the same or similar formulæ or ceremonial acts may be used; and the same end—that of the establishment or restoration of union with God—may be aimed at, and yet the underlying conception of sin and holiness and, therefore, of forgiveness may differ widely, while at the same time the difference may be felt rather than stated.

The discussion of the mode in which sin is removed in its cause, its guilt, and its consequences has been conducted on the Christian ground under the name not of forgiveness but of redemption, reconciliation, atonement, or justification. The reason for this procedure is that theologians have been more concerned with sin than with sins, with discovering and establishing, on both Scriptural and empirical grounds, a theory of the process by which God and mankind may come to be at one, rather than with showing how the individual as an individual may find grace with God.

Of the words referred to, 'redemption' or 'salvation' has the widest scope and embraces the whole benefit which man receives through Christ; 'reconciliation' or 'atonement' seeks to make clear how one special quality of sin in general, viz. guilt, is abolished; while 'justification,' so far as it differs from the others, may be said to be a forensic way of stating the position of the man who has been redeemed, or whose guilt has been blotted out. We are concerned here, therefore, not with the more general theories of redemption, or atonement, but with a transaction which has an individual interest, and, therefore, an interest which is at once more limited and more intimate. The question it asks is not how humanity as a

whole may remove an evil affecting the race, but how the individual when becoming a Christian gets rid of the incubus of his sins; and then how, after becoming a Christian, he can annul the sins which still easily beset him.

In the NT the words used for 'forgiveness' are analogous to the words used in the OT, and come to it through the LXX. The commonest word is *ἀφεσις*, which as noun or verb is used 61 times, of which 45 are in the Synoptic Gospels (18 in Luke), 2 in 1 John (1⁹ and 2¹³), 1 in James (5¹⁵), 6 in Acts (2³⁸ 5³¹ 8²² 10⁴³ 13³⁸ 26¹⁸), 2 in John (20²³), 1 in Romans (4⁷), 1 in Ephesians (1⁷), 1 in Colossians (1¹⁴), and 2 in Hebrews (9²² 10¹⁸). In RV the Greek word is rendered indifferently 'forgiveness' (50 times) and 'remission' (11 times). What is said to be forgiven is 'sins,' 'debts,' 'iniquities,' or 'trespasses'—a variety which reflects the richness of the Hebrew in expressions for wrong-doing.

In the Epp. another word, *χαρίζεσθαι*, occurs 11 times (2 Co 2⁷ 10¹⁰ 12¹³, Eph 4³² 6¹⁸, Col 2¹³ 3¹³ 6¹⁸), in Luke twice (7⁴² 4³). Luke uses also *ἀπολύω*, twice in 6³⁷. Also *καλύπτω*, 'to cover,' is used in Ro 4⁷, Ja 5²⁰, 1 P 4⁸; and *πάρεσις*, 'passing-by,' in Ro 3²⁵. In the Apocalypse the idea of forgiveness is expressed as a *loosing* or *cleansing* by the blood (1⁵ 7¹⁴ etc.).

Another term which bulks largely in the NT, especially in Romans, Galatians, and Hebrews, has been referred to already, viz. 'justification'—a word which always means 'being declared righteous.' This justification is sometimes treated as the genus, of which forgiveness is a species, or the two are sometimes identified (as by Luther). It is more in accordance with the facts to say that forgiveness (like atonement) is the condition precedent to justification, or that a man is first forgiven, i.e. made righteous through the implanting of faith, and then declared to be in a normal relation to God.¹

But a mere enumeration of the terms used, or of their filiation, is of little service in determining the specific difference between the forgiveness offered and received in Christ and that established elsewhere. It is hardly possible to express such a religious experience except in forensic, or commercial, or other terms of daily life. But nowhere does the maxim 'cum duo faciunt idem, non est idem' apply more forcibly than here. We must interpret such terms by their whole context of Christian experience, refusing to limit them by their etymological or current significance, before we can feel sure that we have seized their vital values.

Of critical importance in this context are the Parables of the Great Debtor and of the Prodigal Son, especially the latter. In the former (Mt 18²³⁻³⁵) the implicit is that man's normal relation to man is analogous to man's normal relation to God, and that, after any disturbance of that relation, the mode of restoration is the same. Any difference there may be is quantitative rather than qualitative—the debt is a debt in both cases, though one may amount to ten thousand talents and the other to a hundred pence. This parity of relationship, moreover, assumes a community of nature, even though this community be compatible with a difference in degree, or authority, or power. In other words, it is made clear out of the ground of condemnation of the unmerciful servant that the evil of unforgiveness is to be found in the fact that its object is a brother (Mt 18²¹), and, conversely, that, because God is our Father, whose love for His children is inexhaustible, therefore

¹ Aquinas, of course, regarding justification as 'a mode of motion from one state to its contrary state,' defines it as 'remission of sins accompanied by acquisition of righteousness' (*Summa*, i. ii. qu. cxiii. 1; cf. Harnack, *Hist. of Dogma*, Eng. tr., 1894-9, vi. 238-292).

He forgives us fully and freely on the ground that we are made partakers of the Divine nature. Like as a father has love for his children, so has Jahweh love for them that fear Him (Ps 103¹³). This great truth of community of nature which was compressed by Jesus into the title *Father* is critical for any adequate explanation of Christian forgiveness.

The same parable, however, makes it clear that some effective recognition of this vital relationship must be found on the part of the offender before he can be restored to favour. For the very reason why the unmerciful servant was handed over to the tormentors was that he had in act broken down the homologous relationship of God to man and man to man. God's relation to man as His child is regulative of man's relation to his brother, or, in other words, the brotherhood of man rests only on the common fatherhood of God. He, therefore, who flouts that brotherhood is not so much punished or tormented as relegated by himself to a condition in which he is incapable of experiencing forgiveness, that is, of being restored to a normal relation to God. It is not by an arbitrary sentence but by a natural consequence that he remains in the land of outer darkness far from the home of light and love.

The Parable of the Prodigal Son sets out with equal clearness, and even more attractiveness, the same two master-truths. The father's love is always a potential energy waiting for the spring to be touched which shall release it in action, and that spring is touched by the desire of the prodigal for his home, joined to its expression in his changed life and return. The elder brother is the analogue of the unmerciful servant, in so far as his self-centred habit of soul prevents him automatically from sharing in that selfless love which does not weigh merit or demerit, but gives itself freely where there is willingness to receive it.

The full force, however, of the NT teaching on forgiveness is not given due expression until it is correlated with another law of the Christian life. Nothing is more familiar to readers of the NT than an antithesis which occurs constantly, though in varied forms. The Publicans are set over against the Pharisees; the 'elect' against the 'called'; the spirit against the flesh; the son against the slave; grace against the law; heaven against earth; faith against sight, and so on. But what has not been sufficiently observed is that these different antitheses are expressions for one and the same opposition between two states of the soul. One of these is described as carnal (*e.g.* in 1 Co 3³); or as psychical (*e.g.* in 1 Co 2¹⁴); or as walking by sight (2 Co 5⁷); or as the lust of the flesh (Gal 5¹⁶); or as being under law (Gal 5¹⁸); or as being a slave (Gal 4⁷); or in darkness (Lk 1⁷⁹, Jn 1⁵, Ac 26¹⁸ etc.); or in outer darkness (Mt 22¹³). The other is described as the Kingdom of God (Lk 17²¹, Ro 14¹⁷); as light (1 Jn 1⁷); as life (Ro 8¹⁰); salvation (Lk 3⁶); faith (Gal 3²); liberty (Ro 8²¹). The very richness and variety of the terms used to describe the two states are an indication, on the one hand, that as living processes they do not lend themselves to definition, and, on the other, that they express something which has the mark of reality.

Moreover, other passages indicate a transition from one state to the other. Christians have passed from death into life (1 Jn 3¹⁴, Jn 5²⁴); from darkness to light (Ac 26¹⁸); the whole creation is to pass from bondage to liberty (Ro 8²¹); the disciples have ceased to be servants of sin and have become servants of righteousness (Ro 6¹⁸); those that were slaves have become sons (Gal 4⁵); the saints have been translated into the Kingdom of God's Son (Col 1¹²); they were raised with Christ (Col 3¹).

The moment which marks the transition is defined as being born again (Jn 3³), as regeneration (Tit 3⁵), as conversion (Mt 18³, Lk 22³², Ac 3¹⁹), as an opening of the eyes (Ac 26¹⁸, Jn 9¹⁴, Lk 24³¹), or of the heavens (Jn 1⁵¹, Mt 3¹⁶, Ac 7⁵⁶ 10¹¹, Rev 4¹), or of the understanding (Lk 24⁴⁶). The subjective factor in the transaction is called ordinarily repentance (Mt 3² 4¹⁷, Lk 13³, Ac 2³⁸ 3¹⁹ 17³⁰ 26²⁰), or repentance joined with faith (Ac 20²¹).

The precise character of the process which leads to forgiveness must be duly emphasized before any clear conception can be gained of the nature of Christian forgiveness. From the above it is clear that two psychological conditions are sharply contrasted, viz. the psychical and the spiritual, the former of which is characterized by want of freedom, and the latter by the possession of it. The one revolves round the lower self, and the other round God, and hence one is the realm of disorder and the other of order, in much the same way as a geocentric centre of the universe leaves confused what a heliocentric reduces to order. The act which 'translates' the soul is not man's but God's, though man has his work to do in preparing himself for the re-creative act of God—faith is the human face of grace. When the cup of the soul is emptied of self and purified from the dregs of earth, the wine of heaven is poured into it from above, and the man is born into a new order, the spiritual, out of the old order, the psychical, and he is a new creature, for the old things are past and gone, and all things have become new (2 Co 5¹⁷). The annulment of the old is called in the technical language of religion 'forgiveness.' The nature of this forgiveness will be best understood by considering for a moment an aspect of the change of condition which plays so large a part in the homiletics of St. Paul.

Man, as a religious animal, passes, according to St. Paul, through three stages, the choic or earthy (1 Co 15⁴⁷. 48. 49), the psychical (v. 48), and the pneumatic (*ib.*). (a) The characteristic of the first is animalism unchecked by any practical knowledge of law (Ro 7⁷), and, therefore, a man in that stage commits, strictly speaking, no sin (v. 8); not till a law forbids lust does the animal-man discover what lust is, or learn that it is wrong (3²⁰). When he does this, however, he is ready to pass into the second, or psychical stage.

(b) The characteristic note of the second stage is law, i.e. commands of an external and superior authority, enforced by sanctions. This power of law acts as a check on the natural impulses of its object; and, as he is ordinarily a man not yet wholly freed from the passions of his choic, or earthy, state, he spends his life in a sort of intermittent warfare with the Law. He learns, however, slowly, by means of the pains and penalties inflicted by law for disobedience, that it pays him better in the long run to obey than to disobey, and thus a habit of obedience slowly grows out of suffering, or the fear of suffering. The psychical man learns to obey through fear of pain or hope of comfort, and hence he is sometimes described as a hireling or mercenary, to distinguish him from the choic man who is a slave, or from the spiritual man who is a son.

It is important for our present purpose to note here that forgiveness has no place at all while man is merely earthy, and a limited and lower place only while he remains on the second, or psychical, level—none in the first stage, because forgiveness implies some sense of moral responsibility; and a lower in the second, because that sense is as yet imperfect. In the psychical stage the man is as yet concerned with his own good, whether higher or lower, and hence forgiveness can only mean the remission of some penalty, the non-exaction of some pain or loss which would otherwise fall to him on

account of breach of law. It is obvious that forgiveness in this sense has little to do with the forgiveness which figures in a religion which is built on spiritual reality.

(c) But the Christianity of the NT is avowedly and obviously a religion of the spiritual, or third, degree. Its worship is in spirit and in truth; i.e. its proper sphere is that of spirit, and its proper object the Great Reality. Its characteristic is love, and love is a super-personal force directly connecting person with person. Its sanctions are not external, its motive is not fear or gain, and its driving-power is in the 'unspeakable gift' which has been committed to the soul. Negatively, it may be said that the hall-mark of this religion is freedom from law; and, as a matter of fact, it is this very freedom from law which forms the subject-matter of the polemic contained in the Epp. to the Romans and Galatians. If we bear this in mind, we shall see quite easily that the forgiveness which stands in the heart of the 'Christian spirit' is synonymous with liberation from law and its consequences as such. 'The law of the Spirit of life in Christ Jesus made me free from the law of sin and of death' (Ro 8²). And 'if ye are led by the Spirit, ye are not under law' (Gal 5¹⁸).

It is necessary, moreover, if we are to appreciate the central position occupied by *forgiveness* in the NT, that we should notice that it is no specific law, Jewish or otherwise, that is the enemy of the Spirit, but law as law, and especially that law embracing all lower laws, viz. the law of cause and effect, by means of which the human mind constructs a coherent whole out of the scattered members of our empirical life, and in so doing robs man himself of his own freedom. The laws of Space and Time added to the law of Causality form the trinity of forces evolved by man out of his inner consciousness by a Divine necessity, for the purpose of first fettering him that he may afterwards be led to seek and find liberation. When by asceticism, self-surrender, obedience, endeavour, prayer, or contemplation he breaks through the boundaries set by the law and attains direct communion with the Great Reality, he experiences what is called 'forgiveness.' It is not so much that he escapes from the penalties of broken law, such as disease, agony, death, or hell; the boon is different and greater. He is set free from law altogether as law, and acts as the Spirit within him (with which he is now one) impels him to act; and, even though the consequences of past breaches of law still persist (for he still in soul and body is a member of the phenomenal world), yet they do not persist as penalties, but have 'suffered a sea-change' into instruments of the Divine alchemy which is transmuting the dross of earth into the gold of heaven. Hence, in the fullest sense he is set free from law in the whole range of its jurisdiction. He has been 'forgiven,' that is, set free from the kingdom of Law by being admitted and naturalized in the kingdom of Spirit.

2. In the Christian Church.—The history of the conception of forgiveness in days after those of the NT is a history of the struggle of the two forces of Life and Form to establish an equipoise. It might be contended with some plausibility that the equipoise was seldom, if ever, actualized, and that at the best any approximation to it was due to a more or less bitter and persistent hostility between different Churches, or different sections in the same Church. Nor is it difficult to see why this should be the case, for the 'mystic' nature of forgiveness as portrayed in the NT was too lofty for human nature's daily food, and hence it might be predicted that some means would be devised to give the inner process known as 'forgiveness' some concrete form or statement which might be intel-

ligible to the ordinary Churchman. This was effected as part of that development of the life of the Church which came to be known as Catholicism, and was carried out with growing decision and thoroughness from the date of the 'peace of the Church' (A.D. 313). The dominant form it finally took was that of the 'sacrament of penance.'

But the forces which substituted the 'sacrament of penance' for the originally dynamic and unformulated act of forgiveness were active from the first. The community of Christians was at the first a company of saints, membership in which gave and maintained forgiveness of sins. Sins previously committed were due to ignorance—they were *delicta pristinae cæcitatæ* (Tert. *de Bapt.* 1)—but, being recognized for what they were, repentance ensued, forgiveness followed repentance, and was conferred or ratified by baptism: 'Cessatio delicti radix est veniæ, ut venia sit poenitentia fructus' is Tertullian's pithy statement of the process (*de Pud.* 10). In some obscure way the forgiveness of sins was related to the Cross; Ignatius speaks of 'the flesh of Jesus Christ which suffered for our sins' (*Smyr.* vii. 1); and, similarly, Hermas (*Sim.* v. 6. 2) refers to the many labours and sufferings by which the Son purged the sins of the people entrusted to Him.

It still remains uncertain whether forgiveness of sins was from the first regarded as the pre-condition of baptism, or as its principal consequence, whether, that is to say, baptism effected or merely proclaimed forgiveness. But what is clear is that the inner act known as forgiveness was very soon embodied in a sacred ordinance; that this sacred ordinance of baptism was regarded as washing away all previous guilt; and that it admitted its recipient into a holy society, in which subsequent sins were an abnormality requiring special treatment. The original Christian teaching had been that none but God could forgive sins, even though He might act mediately; but this mediate action quickly crystallized into the assertion that the right of forgiving post-baptismal sins was in the bishop as the successor of the Apostles. This claim, made by Pope Calixtus against the so-called Novatian heretics, marked unconsciously the parting of the ways, for it defined the process which changed the Church as a 'sure communion of salvation and of saints, which rested on the forgiveness of sins mediated by baptism, and excluded everything unholy' into a body not inherently holy but 'a holy institution in virtue of the gifts with which she is endowed.' The primitive conception that God alone could forgive sins was changed into the proposition that the bishops alone had jurisdiction in the matter—'per episcopos solos peccata posse dimitti.' The way was now clear for the further materialization of the authority into the coherent system of the theory and practice of the 'sacrament of penance.' The efficient cause no doubt of the establishment of this sacrament was to be found in that secularization of the Church which was produced by its recognition by the Empire and the consequent crowding into it of men and women of all grades of piety. The majority, especially after the conversion of the barbarians, were but children in religion, and demanded elementary methods of discipline and training. These were found in the authority which came to be vested in the leaders of the Church, by which they were enabled to exclude from the community certain classes of sinners for varying periods, especially those guilty of murder, idolatry, and adultery. On repentance, however, the excommunicated person might after public confession and promise of amendment be reinstated. Out of this salutary custom of forgiving on terms those who had confessed and expiated their sins *against the Church* there grew gradually

a custom of another kind and of more searching activity, viz. the forgiveness after confession of sins *against God*, in which was involved also the substitution of the priest for the Church as the absolving authority.

The machinery thus established lay with a heavy weight on the mediæval world. Eugenius IV. instructed the Armenians that the sacraments of the new Law were seven, of which the fourth was Penance; that the matter of this sacrament consisted in the three acts of contrition, confession, and satisfaction; that the words of absolution were its form, a duly authorized priest its minister, and its effect the forgiveness of sins. Martin V. condemned those who maintained that all exterior confession was superfluous and useless where the sinner was duly contrite; and he also directed that all Hussites should be interrogated whether they believed that besides contrition it was necessary to salvation to confess to a priest only and not to a layman, however good and devout he might be. Sixtus IV. condemned the proposition that there was no obligation to confess evil thoughts, since they were blotted out by aversion to them without recourse to the Keys; he condemned also the proposition that confession should be secret, i.e. of secret sins and not of open sins.

To the sacrament of penance as an instrument of forgiveness there was added later a system of indulgences (*q.v.*) under which the Church dispensed from the temporal pains of Purgatory not merely canonical or notorious sinners, but all, whether living or departed, who either themselves or vicariously performed certain prescribed ecclesiastical exercises, such as saying given prayers, attending given offices, or paying fixed sums of money. This form of forgiveness of sins, however justified theoretically, can hardly be recognized as akin to the forgiveness of sins described in the NT.

Accordingly, in the 16th cent. the whole of the existing ecclesiastical doctrine and practice in the matter of the forgiveness of sins was challenged in the name of the NT. It was no accident which led Luther to direct his attack on indulgences, but a true insight into the fact that these were the logical outcome of a long historical process which was a corruption rather than a development. According to Luther, the liberty of every Christian man was destroyed by the priesthood; the Church Catholic had banished or buried the Church of Christ; ecclesiastical law had taken over the rôle of that condemned by St. Paul; the transaction of ceremonies had overlaid the piety of the heart; and a mechanical and external forgiveness of sins had ousted forgiveness as dynamic and proper to the individual.

The battle thus begun raged round the word 'justification,' which hence bore an extended connotation, being made to cover the fundamental difference of *Lebensanschauung* which marked the Reformers from the Romans, and was crystallized by the decrees of the Council of Trent on the one side and by numerous Confessions of Faith and Articles of Religion on the other. Unfortunately, it was a hard necessity laid on the Reformers that they were compelled to attempt to solve a religious problem by logic and by means which St. Paul called 'carnal.' Forgiveness, as we have seen above, is of a spiritual nature, that is, it belongs to a sphere where reason is not so much contradicted as transcended, but it was pulled down by the new learning into the world of reason and sought to be defended by proof-texts, historical precedents, philosophical speculations, and similar instruments of controversy. The result was, and is, that the true, essential nature of forgiveness has been left obscure in the Evangelical Churches by a process which meant only that one kind of

scholasticism was substituted for another. The scholasticism of a Calvin differs in form, but not in method or spirit, from that of an Anselm or an Aquinas.

II. *HUMAN*.—It is the prerogative of religion to impose on its subjects, as regulative of their relations one to the other, the relation to them all of the God they worship. Christianity, accordingly, teaches that the forgiveness accorded to men by God is the pattern of the forgiveness which men are to extend to each other. This is set out clearly in the Parable of the Great Debtor, and in the fifth petition of the Lord's Prayer, for in the former the sin of the unmerciful servant is just this, that he did not do what his lord (= God) had done, and in the latter the statement that we forgive our debtors is not cited as the pre-condition of a contract, but as affirming that the forgiveness given to man by man is an organic factor in the forgiveness given to men by God. The Christian prays for forgiveness, and adds as a plea in justification of his prayer that he is in the habit of forgiving his debtor (Lk 11⁴), but he does not imply that his appeal is to anything but the lovingkindness of God (Nu 14¹⁸, Jon 4²); on the contrary, he appeals to God for forgiveness on the ground that His nature and property is ever to have mercy and to forgive, and adds by way of proof of his being aware of the greatness of the boon he is seeking that he already practises what he seeks. This petition, therefore, is an expansion of Mt 5²³.

It may be urged that the capacity for extending forgiveness to others is acquired only as the direct consequence of being first made conscious of the forgiveness given by God, while Jesus seems to imply, if not to assert, that before being forgiven by God we must have forgiven others. The reply is that the objection is similar to that raised by the scholastic distinctions between prevenient, co-operant, and subsequent grace, viz. that the difference is formal only and not substantial. He who forgives another is in that very act forgiven by God, and he whom God forgives in the very receipt of forgiveness forgives all his enemies. Reason, and the expression of spiritual transactions in prayer or praise, may necessitate the bringing of the spiritual act under the category of time, but forgiveness, whether of man by man or of man by God, is one and undivided in the sense that where the one is the other is involved. Life remains a unity, though thought and action split it up into duality.

This identity of forgiveness on the Divine and human levels makes it unnecessary to do more than tabulate the moments of forgiveness as between man and man, for they are but the miniature copies of the moments of the forgiveness which God gives to man. (a) In the Christian sense of forgiveness the remission of the consequences of wrong-doing has no independent place at all; for, though it is true that man can so far intervene in the operation of the law of cause and effect as to affect its incidence on his own personal volitions, yet he cannot define its working on Nature or on the volitions of others. For example, an employer may refuse to commit to prison a servant who has robbed him; a man who has been assaulted may abstain from a counter-attack or from prosecuting his assailant; a father may pay his son's debts, or he may forbid him his house. In all these cases human volition counts for something in the course of events, and yet may have no connexion at all with forgiveness, for this may be as consistent with the exaction of penalty as with its remission. (b) Forgiveness regards the higher welfare only of the offender. If we say, for example, that the punishment of the liar is not so much that others do not believe him as that he

does not believe himself, forgiveness will aim at the transformation of the liar into the truth-teller, and the course of action adopted for this end will be determined by what sanctified common-sense dictates as being most serviceable. As God sends before Him His two angels of fear and love, so the son of God will use sometimes one, sometimes the other. (c) Forgiveness excludes all reference to the feelings or interests of the injured person, and concentrates itself on the good of the person who has done the wrong. This may be said to constitute the negative side of forgiveness. (d) Forgiveness, however, is not consistent with a contemptuous, or supercilious, or merely negative attitude towards the offender; the Christian does not treat his wrong-doer as unworthy of notice, or declare that his own peace of mind is too valuable to be disturbed by him, or wait calmly and passively until forgiveness is begged for. On the contrary, the spirit of forgiveness, because it is one expression of the spirit of Divine love, pursues the offender until it has accomplished his conversion. (e) In this process of trying to save his brother's soul a follower of Christ will probably find his warrant in the verdict of Jesus given in the first Word from the Cross, that wrong-doing is the product of ignorance. For, as no one injures his brother who knows that in so doing he is doing more injury to himself (both because he is limiting his own spiritual capacity and because he and his brother are at bottom one), so the man whose eyes are open will bear in mind that tolerance and magnanimity are called for rather than vindictiveness, or hatred in general. In a very true sense all injustice is due to ignorance, and ignorance calls for the tender care of a physician rather than the ferocity of an executioner. (f) Lastly, it follows from the above that forgiveness, when complete, is a single relation between two persons, to which each contributes his quota. On the part of the injured person there is required the spirit of forgiveness; on the part of the wrong-doer a whole-hearted recognition of his offence against his brother, joined to such acknowledgment of it in word and deed as may be meet; then the union of these two in the inner world of the spirit, *i.e.* of Reality, brings about that restoration of personal friendship and brotherly good-feeling in actual life which goes by the name of forgiveness.

See also EXPIATION AND ATONEMENT, GRACE, JUSTIFICATION, SACRIFICE, SIN.

LITERATURE.—E. A. Abbott, *The Spirit on the Waters*, London, 1897, pp. 322-381; *PRE* xx. 552, art. 'Versöhnung,' with bibliography; I. A. Dorner, *System of Chr. Doctrine*, Eng. tr., Edinburgh, 1882, iv. 194-238; J. Müller, *The Christian Doctrine of Sin*, Eng. tr., Edinburgh, 1852-53; J. H. Newman, *Lectures on Justification*, London, 1840; J. Perrone, *Prælectiones Theol.*, Rome, 1840-44, vi. 238-306; Tertullian, in 'Library of the Fathers,' 1842, pp. 369-408; Aquinas, *Summa*, iii. qu. 84-90, and Supp. 1-28.

W. F. COBB.

FORM (Æsthetic).—I. Meanings of the word.—'Form,' in its literal significance, means any objective representation of an image or mental idea, whether in matter, language, or sound. This may be the work either of Nature or of Art. In both cases it is the product of an arrangement of the different, but related, parts of a complete thing, or image of a thing. The psychological impulse whence this process arises is that of expression, which belongs to the nature of mind. In the *æsthetic* sense this general conception is narrowed by the special effort to add beauty to the representation, to construct forms in accordance with the canons of good taste and perfect ideals. *Æsthetic* form is thus defined as the representation of choice images or ideas in forms that approach the perfection of Nature or Art.

Thus the evolution of art becomes the evolution of forms. Two features of this evolution should

be noted. On the one hand, the forms of art have changed with the growth of man in intelligence, sympathy, and insight, *i.e.* as culture and social life have changed, though a uniform tendency towards the universal truth of life has always inspired and guided the process. On the other hand, as the various stages of culture and civilization have reached their zenith, those forms of art have crystallized in which are expressed its highest and noblest insights. Form and content, in short, have always mutually influenced each other. It is this obvious feature of *æsthetic* evolution that underlies and explains the apparently irrepressible conflict between the forms of so-called classical and romantic art. The fixity of any form of expression is called its classical phase; but this is seen to be purely relative. The adoption and imitation, for any length of time, of any form as the highest form suitable for the expression of *æsthetic* ideas necessarily lead to its becoming stereotyped and conventionalized; and thus a form becomes 'classical,' *i.e.* representative or typical of the highest insight of the times that gave it vogue. But, as soon as the inadequacy of these forms to express *new* ideas is perceived, or a change in beliefs, ethical standards, or emotional interest takes place, the classical conventions are threatened and superseded; a new spirit, often of revolt, is generated, which proceeds to invent new and, to the classical ear, barbarous fashions, leading to our romantic reactions. But these, in turn, become set, conventional, imitative; and so the cycle is gone through again. The essential fact which this conflict of forms brings out is that there is a real progress in the invention of forms to express the ever-widening meaning of life, the good of each epoch filling its rôle as guide and inspirer of its later products.

Form, in the *technical* sense, refers to the various *methods* by means of which the artist seeks to give perfect embodiment to his ideas. With these we need not concern ourselves here, belonging, as they do, to special disciplines. One remark may, however, be made: the methods have grown more elaborate and perfect for their purpose as the resources of ideas and of mechanical invention have been perfected. The form, in the instrumental sense, cannot be said to have reached its limit, unless we can say that the limit of ideas and of the means of expressing them has been reached.

2. No definite rules can be laid down for the classification of the various expressive forms of art. For the most part these follow the line of interest or inspiration, by which the artist's sense of beauty is controlled. According to his point of view, he may be either an impressionist, a realist, or an idealist, just as he lays stress upon the part sensuous feeling, imagination, observation, or the sense of beauty plays, or may play, in art. His forms will vary accordingly. In the case of the sculptor, the painter, or the poet, a large part of the images or ideas will be imitated from the forms of Nature, through which, by the subtle alchemy of feeling, imagination, and beauty, they will seek to express either their sensuous feeling, or their elementary sense of the veracious, or the higher sense of ideal beauty or perfection. Value may be conferred on the forms of art in any of these ways; but it is the last alone that reaches the highest spiritual standard.

3. Form and content.—Form may vary in accordance with the kind of ideas which the artist seeks to express. No poet would employ the lyrical form to express an epic or tragical meaning. Hence what we call beauty of representation means only our sense of pleasure in the manifest *fitness* of the outward form to express the inward state of mind. Where the balance between form

and content is maintained we shall find both adequate and beautiful, and therefore satisfying.

In some forms of art, however, especially of literary art, like fiction, *belles lettres*, and the essay, beauty of form is often deliberately sacrificed to intensity of impression and conviction; the subjective factor is allowed to overbalance the formal beauty of the work; temperament is allowed freer play, and even truth may be of less importance than fancy or imagination. Under these conditions the formal element of art does not necessarily become less perfect, but it is obscured in the stronger tides of passion. Art becomes descriptive and declamatory, as in much of Carlyle's writing, while interpretation becomes relatively unimportant.

Realistic art for this reason has always been deficient in the formal beauty of its representations: it tends to become documentary, evidential, not universal. This is the case with much of the art of the present day; and, since form cannot long be valued for its own sake, and since a return to classical form seems impossible, it must be judged as, on the whole, a healthy tendency, though obviously temporary, judged as art, and looking towards a higher synthesis of form and content, of the real and the ideal, which may follow.

On the other hand, form may be emphasized and deemed of *more* value than matter. This was the case with much of the literature of the 18th century. In the more objective arts, like architecture, sculpture, and painting, it is obvious that form cannot be sacrificed, if verisimilitude is to be secured; but even in these arts the formal element may overlay and obscure the living truth. Greek sculpture, while it is developed with wonderful beauty, spontaneity, and finality of form, lacks the spiritual note. On its formal side it is unexcelled, but as a revelation of the soul it has been often excelled. Rodin has expressed ideas in marble which the Greeks never approached or thought of expressing. So also has Michelangelo. In literature, too, form may overtop matter, as in Pope. The same is true of music and the other arts. Throughout this entire process, the æsthetic judgment seeks, in the work of art, the adequate relation of form and content, poetical thought finding equally poetical formal expression. Where this is the case, form is perceived to be the indispensable medium of the total spiritual ideal which the work was designed to produce.

4. The law of form.—This is the law of unity in diversity. Unity, *e.g.*, is an obvious demand of all formal representations which claim to have artistic value. This is clear enough in poetry and music, which cannot stir our appreciative sense of their beauty by merely stringing together a continuous stream of sounds, however harmonious, in the absence of unifying ideas, endowed, *ab initio*, with power to move the emotions. In lyrical poetry this seems specially obvious; but it is no less so in the epic or the tragedy, which lead to a certain inevitable catastrophe, impressive in itself, and purging the spectator's emotions by fear and pity. And, making due allowances for the different mediums in which the sculptor, the painter, and the architect work, the same is true of their arts as well.

Unity, however, depends, in turn, upon the related elements, diverse in kind and number, which enter into and help to compose it. The unifying of the detail of a work of art into a thing of beauty requires great skill and judgment to avoid excess. Emotion, which enters so largely into this activity, is an unstable medium to work in; and its extreme licence, as in Whitman, often vitiates the value of a representation otherwise extremely nobly con-

ceived. Restraint is one of the best guides of form. In addition to this, it is clear that the human mind takes pleasure in the congruity of the various parts of a work of art; and, where this is sacrificed to power, energy, or force, we feel that something essential is lacking. In these matters the judgment will be guided as much by the sense of fitness between the detail and the central and unifying idea as by emotion. Few have manifested the law of form more perfectly than Shakespeare, who nearly always produces in us a feeling or judgment in which we repose in a disclosed unity amid a wealth of plot and incident.

5. Ethical implications.—Behind all these technical considerations, governing the evolution and control of the formal element in art, lies the fundamental truth that form is always subject to the influence of moral ideals, to the ethical quality in the personality of the artist, and to the acknowledgment accorded by humanity to the Supreme Good. In particular must moral character in the artist be a powerful influence in the form of his art. As Ruskin said, a bad man is not likely to produce art of the highest kind. The precise ways in which the ethical factor affects the forms of expression in art cannot be reduced to strict classification; but it is safe to say that it will impart to all works of art, where its influence is allowed to work, a sincerity and earnestness, as well as a certain chastity and exaltation, not otherwise attainable. After all, the highest art culminates in the supreme revelation of Nature, the perfect man, who unites the ideal in the real, in whom God and man are reconciled. Thus, even on the formal side, art and religion are seen to seek the same end. However this may be, it is certain that we can never permanently approve, either æsthetically or morally, an art, however beautiful or correct in its mere form, which lacks the qualities of greatness, imparted to it first by the artist himself, and next by the ideas to which he, by means of its forms, gives a local habitation and a name. If he be a man of high ideals, the form of his art is likely to reflect the quality of those ideals.

LITERATURE.—H. R. Marshall, *Æsthetic Principles*, New York, 1895; C. T. Winchester, *Some Principles of Literary Criticism*, do. 1899, ch. vi.; T. B. Macaulay, *Essays on 'Milton,' 'Boswell's Johnson,' and 'History of England'*, chs. vi., vii., x.; Addison, *Spectator*, no. 409; G. L. Raymond, *The Representative Significance of Form*, New York, 1900; Matthew Arnold, *Lecture on 'Emerson'*; J. H. Newman, 'The Danger of Accomplishments,' in *Parochial and Plain Sermons*, new ed., London, 1868; A. Alison, *Essay on the Sublimity and Beauty of the Material World*, London, 1790, chs. iv.-vi.; William Wallace, *The Threshold of Music*, New York, 1908, ch. xi.

H. DAVIES.

FORMALISM, FORMS.—See WORSHIP.

FORMOSA.—I. Geography and ethnology.—The Formosa of this article is a continental island, extending from 20° 56' to 25° 15' N. latitude, and from 120° to 122° E. longitude. Its southern end lies 386 miles due east from the British crown colony of Hong-Kong, and its northern end some 140 miles E.S.E. of Fuchau, the capital city of the Fokien Province of China. It has a length of 225 miles, and a breadth of 80 miles across the widest or middle part; while the coast-line encloses about 13,500 square miles of territory—an area considerably larger than Holland, or about half the size of Scotland. Thickly wooded hills cover the whole eastern side of the island, the ranges culminating in Mount Morrison, which is more than three times the height of Ben Nevis, and was so designated by Richard Collinson, after the name of his 'dear friend' who began missionary work in China fully one hundred years ago (*Proc. of Roy. Geog. Soc.* viii. [1864] 25). For the most part, the inhabitants of Formosa are found in the towns and

villages scattered over the broad, level, western seaboard, and may be classified as follows: (1) the Malayan aboriginal tribes, made up of (a) about 180,000 Pepohoan, who live in the more accessible valleys, and who have become almost entirely Sinicized in their dress, language, and general style of living, and (b) about 122,000 semi-nude savages, who occupy the higher mountain ranges, differ from the Pepohoan in speaking their own Polynesian dialects, and spend their time in hunting for game or for the heads of people with whom they have no tribal relationship; (2) the descendants of immigrants from the mainland of China, consisting of (a) about 80,000 from the Kwantung Province, who speak the Hakka form of the Chinese language, and (b) about 2,776,855 from the opposite province of Fokien, who use what is known as the Amoy vernacular; and (3) about 83,330 Japanese, who began to arrive when the island was ceded to Japan in 1895.

2. Religious and other beliefs; manners and customs.—With regard to the religious beliefs and practices of the people of Formosa, it is not necessary to enter into details here about the civilized Pepohoan and the Chinese settlers, because these two classes may be looked upon as one so far as superstitious worship is concerned, while other articles in this Encyclopædia will deal in an exhaustive way with the religions of China and Japan. The first thing to notice in making any statement about the savages of Formosa is the extreme paucity of the information which is available. No European or English-speaking scholar of recent times has acquired any of their dialects, or lived amongst them more than two or three days at a time. It should be remembered, however, that, for thirty-seven years during the first half of the 17th cent., the Dutch were in possession of Formosa—at a time, too, when the ancestors of the present-day hill tribes swarmed all over the western side of the island. Devoted pastors from Holland then laboured for the conversion of this people, and they have left on record many notices of the native customs which are still to be met with. In the absence of anything more circumstantial belonging to this period, the present writer may here transcribe from his *Formosa under the Dutch* (1903, p. 75, and *passim*) the following account, compiled from the writings of Candidius, Junius, and others:

'Although no books or writings have ever been found in the Island of Formosa to give us information concerning the religion of the people, it is nevertheless certain that the people there have a religion which cannot be otherwise designated than as heathenish and superstitious, inasmuch as it agrees very much with those other heathen religions which have been handed down from one generation to another. The Formosans imagine that there are several gods, each having his own work and abode; but of one Supreme Creator they know nothing, affirming that the world has existed from all eternity and shall eternally so remain. Nevertheless, they believe that there are certain rewards for the good, and severe punishments for the wicked; the former having to cross over a very difficult gulf before they can become partakers of great joy and every variety of pleasure, while the latter will never be able to cross this gulf, but must roll about there for ever by way of punishment for their sins; a doctrine which would seem to involve belief in One Divine Being, since there must be a Supreme Ruler of the universe if all men are to be judged according to their deeds. The ridiculous part of their religion is that the people find sin in things which are really not sinful. For instance, it is considered an evil thing for any one to build a house on some so-called forbidden day; or to gather wood or food without taking due notice of the singing of birds, or for any pregnant woman to keep alive her children before the thirty-seventh year of her age—a custom which is surely abominable and in itself deserving punishment. On the other hand, they see no sin in actions which are extremely sinful; so much so that crimes like adultery, fornication, murder, and theft do not trouble them in the least, but rather cause boastfulness, under the belief that their gods find pleasure in them; from which it may be inferred that this people must have a very degrading opinion of their deities.

The Formosans have several gods whom they worship, and to whom they sacrifice in time of need, two of them especially being regarded as excelling in power and riches. The one—

who is a male and lives in the south—is called *Tamagisangkal*, and is supposed to beautify man; the other—who is a goddess and lives in the east—is named *Tekarpada*. It is said of her that thunder is heard when she scolds her husband for not sending sufficient rain on the earth; which, however, he immediately does on hearing her voice. Both these gods are worshipped most zealously, and oftenest by the women of Formosa. There is another god, who lives in the north, and whom they look upon as extremely wicked, called *Sarisano*. They try to propitiate him, seeing that he has the power of making people ugly, and of causing them to take chicken-pox and other kinds of disease. They are greatly afraid of these evils, and seek to ward them off with all their power, affirming that when they serve this *Sarisano* there is not the slightest need for fear. Besides these there are yet two other gods, *Tapatiap* and *Takafutta*, the gods of war; who are more especially worshipped by the men when they go out to battle, no scruple being made about propitiating them by sacrificing even on the streets. Temples are everywhere to be met with, there being one for every sixteen houses; and, while all other nations have priests to perform religious ceremonies, this is done here by priestesses called *inibs*. These *inibs* sacrifice the heads of pigs and deer, which they are accustomed first to boil somewhat, and then to place before their gods with some rice, strong drink, or *brom*, and *pinang*. Thereupon, two of the priestesses rise and call upon their gods with a horrible shouting and screaming, so furious that their eyes stand out of their heads as they foam at the mouth, causing them to look as if they were either demon-possessed or suffering from madness. Their gods are then said to appear in such terrible form that the priestesses begin to shake and tremble violently—as one actually sees them do—before they fall to the ground as if dead; the bystanders meanwhile showing signs of deep grief, by giving themselves up to continuous weeping and howling. On recovering, the two priestesses climb to the roof of the temple and stand, one at each end, calling upon their gods with violent gesticulations. Every article of clothing is now laid aside, and they appear stark naked before their idols, to honour them and move them to answer prayers by the exhibition of, and continual tabering upon, their female parts. They then wash their bodies in clean water, and remain naked before the people, who are mostly women on such occasions—the men being not very religious—and who have all the while been making themselves as drunk as possible. The *inibs* also busy themselves in expelling demons and warding off all sorts of evil. Nor do they simply foretell good and bad weather, for, by cutting the air with a naked sword, and performing various frantic gestures in public, they profess to drive away the devil who causes the bad weather, so that he is not able to stand the hacking with the sword, but takes refuge in the water and is drowned. These and a hundred other such outrageous stories they tell the common people, who are largely dependent on them, and who wonder greatly at their doings.

Besides these ceremonies performed by the priestesses, every Formosan has a kind of private religion which he practises in his own house, where each one honours his gods in the way that pleases him best. The people also celebrate several feasts, during which they solemnly worship their gods in the temples, with the addition of feasting, dancing, and singing. When any Formosan becomes sick, a rope is first tied round him. He is then suspended from the end of a *spring-branch*, and suddenly let fall from above, so as to shorten his sufferings by breaking his neck and bones. As soon as he is dead, the fact is proclaimed by the beating of drums, whereupon the women gather together, each one bringing a pot of native wine, or *brom*, in which they always indulge very freely. The corpse is likewise treated in a most wonderful way, by placing it near the fire while a funeral feast is going on and the friends are exhausting themselves by dancing to the sound of a drum. These ceremonies are kept up for nine days, during which a most horrible stench is caused by the gradual drying and roasting of the corpse. After this period of mourning, the body is washed nine times, wrapped up in a mat or something of that kind, and placed on a high scaffolding, which is draped round with hangings till it looks like a bedstead or field-tent. Here it is left for three years, till it has become thoroughly dry; whereupon they bury it in their houses, giving their friends at this time another funeral feast according to their means. From all these doings, it is apparent that the Formosans are a stupid, blind, and ridiculous heathen people; and yet it has pleased God—as we shall hereafter see—to bring many of them to a knowledge of the Truth.'

With regard to the foregoing account, it need only be said that, as Chinese immigration to Formosa increased, the bulk of the aborigines had steadily to retire into those fastnesses from which they have ever since been making head-hunting raids upon their invaders and those associated with them, the result being that this has placed the hill tribes in a position of almost complete isolation; for no outsider dares to travel through that high mountain region unless he is convoyed along from tribe to tribe as an accredited guest. Only very occasional visits by Europeans have been paid to it in recent years, and about some of these a few notes may now be given.

(1) In June 1857 R. Swinhoe spent two or three days among the *Kweiying* and *Tylokok* tribes of North Formosa, and found them to be a dark-coloured race, whose features, speech, and customs suggested a decidedly Malayo-Polynesian origin. The tatu marks on their faces first attracted notice, the males having three series of short lines arranged in compact groups on their foreheads, the upper and lower consisting of eight horizontal lines each, and the middle one of six. The tatuing of youths begins when they are sixteen years of age; but, when further on in their teens, and when they have qualified for marriage by capturing the head of some enemy, they are tattooed under the lower lip with a square of short horizontal lines. The faces of the married women have tatu marks from ear to ear; first three simple lines; then two rows of signs like x between two lines lower down; and, below all, four more simple lines. These people usually wear very little clothing, but on holiday or festival occasions gaudy dresses are worn; and, on celebrating a marriage, they all turn out in fine attire, and assemble at the house of the bride's father, when the skull won in that combat which entitles the bridegroom to take up his position is brought forward and presented to the bride, who prepares a draught in it by mixing spirits with the brains, and then offers it as a loving cup to all the guests, commencing with the chief of the tribe and ending with the bridegroom. The huts of the *Kweiying* are made of bark and rough planks held together with rattan, and thatched with palm leaves. The women and old men do most of the hard work in cultivating the fields for dry rice, sweet potatoes, millet, and tobacco. When on the hunt for game or human heads, the *Kweiying* and the *Tylokok* are much guided by a certain small species of bird, the notes of which are taken either as an encouragement or as a warning. If thought to be propitious, they follow the flight of the bird, and lie in ambush where it comes down, to watch for their prey. The people of these tribes could not be induced to make any reference to their superstitious practices. They dress their dead in a plaid or wrapper, and bury them in the ground without burning incense or raising any kind of monument, only a few trees which are planted at the time being left to mark the spot.

(2) During May 1878 the present writer visited the savage *Bu-hoan* and *Kale* tribes in the high mountain region of Central Formosa. The people of the first-named tribe were found to be a fine, tall, muscular race, and not by any means so degraded as one might have expected them to be. According to the testimony of the few Chinese who barter with them, they are truthful, chaste, and honest in their dealings with each other. The pursuit of head-hunting is their one serious crime against society. This degrading practice appears to be carried on in much the same way and for the same reasons as it is in Borneo, and it has come to be so largely mixed up with the beliefs and customs of the Formosan tribes that, apart from all quarrelling, heads must be brought in to keep up the traditional stand against Chinese invasion, to show the continued possession of bravery, and to furnish an occasion for excitement, for jubilation, and for the inordinate consumption of native whisky. On the visit referred to, rows of human heads and bleaching skulls were seen, fastened up at the end of the chief's house. All the other houses were similarly provided, there being thirty-nine in one collection, thirty-two in another, twenty-one in a third, and so on. They were the terrible outcome of clan-fights, and of many a fatal meeting with straggling little companies along the base of the mountains outside. Intellectually, the

Bu-hoan seemed to be mere children. For example, any party hunting for game or on the war-path would separate into two companies and arrange to meet again 'after one hand'—that is, in five days. When they were questioned through an interpreter who understood the Chinese dialect used in Formosa, one tribesman pointed skyward and referred to the Great Father of all men as *A-pa*; and on the writer entering a ruined house-steading where some bodies had been buried, the villagers peremptorily called him back, and caused some drops of water to be sprinkled over him as an old priestess uttered some sort of incantation. Another little incident may be mentioned. Chief *Arek* and several others had been so benefited by the doses of quinine served out that they invited the donor to go with them and inspect the water-spring of the village—a proposal which the interpreter said was an unmistakable mark of confidence. It seemed that the clear abundant water of the spring was then supposed to be under an influence which was causing numerous deaths among the people, and that they wished to exhibit their practice of firing into it in the hope that the bullets from their long guns might dislodge the unseen enemy. After all the yelling was over, the writer drank from the well before them, and said they need have no fear now, but begin again to use the water from this Well of *Tur-u-wan*. The dampness of the houses or cabins in which they slept was sufficient to account for the prevalent sickness. They commence the erection of these structures by digging a large oblong pit about four feet deep. The earth forming the floor of this pit is then firmly beaten down, and the sides are built round with large stones. The wall is afterwards carried three feet above the level of the ground, a bamboo frame-work is thrown over from wall to wall so as to form eaves about two feet from the ground on either side, and above this thick slates are placed to complete the structure. When any one of the tribe dies, his friends do not convey the body to the outside of the village for burial, but the log fire which always smoulders at one end of the apartment is immediately cleared away, and a deep hole is dug, into which the body is placed in a sitting posture. Pipes and tobacco, with other articles used by the deceased while living, are placed beside the body; some simple ceremony of mourning is gone through, a couple of the nearest relatives fill up the grave, and everything then goes on as usual.

There is not much to remark about the *Kale* clans of Formosa. They were found to be a finely-formed healthy-looking race, their faces free from tatu marks, and all of them wearing a reasonable amount of clothing; not a few, indeed, being rather prettily arrayed in bright-coloured dresses, and ornamented with ear-rings, bangles, and necklaces of cornelian stone. The chief of the village of *Ka-piang* was a stately-looking dame, who received the respectful service of her people as a matter of course. The few presents offered by the writer for her acceptance at the close of the introductory ceremony included about twelve yards of a highly-coloured cotton print which at once stirred the hearts of all the beholders. It was a piece of the flimsiest Manchester stuff, with great staring flowers on a frightful pattern of scroll-work; and yet that bit of cloth made a remarkable impression on the minds of this people. All formality was now banished. The writer and his party were looked upon as having had some share in the manufacture of this wonderful production; the word was passed that a first-class medicine-man was now standing amongst them; and their pent-up feelings found relief in an order to have supper prepared forthwith. Very few

traces were met with of any belief in the unseen. Ghosts are known to exist, and various simple expedients are resorted to for propitiating them; while at harvest time, offerings of thanksgiving take the form of laying out little quantities of grain and cooked meat, that the good spirits may partake of the essence, before the people feast themselves on what is left. The Kale also indulge in the practice of head-hunting; for one morning when the writer pointed with strong disapprobation to a number of freshly cloven-in skulls, the Kapiangers immediately shouted out with great emphasis, 'Lang-wah! Lang-wah!' meaning that all their customs in connexion with head-hunting were not only blameless, but greatly to be commended.

(3) A two days' journey south-east from Kapiang brings one to the country of the *Amia*, the largest tribe in this part of the island. Our fullest knowledge of the *Amia* comes from George Taylor, Chief Lighthouse Keeper at South Cape, from whose notes mainly the following account has been compiled. The *Amia* trace their descent from the occupants of a long catamaran which was washed ashore at Pilam many years ago from a distant island of the Pacific; the place of debarkation is still pointed out and made the scene of an annual religious offering to the spirits of those early castaways. They have also the tradition of a 'first man and woman,' believing that, long ago, some great unknown Being planted his staff in the ground, which first became a bamboo and then gave birth to a man and a woman, the impression of whose feet on a large stone is still shown to privileged persons, at a place called Arapani. The *Pilamites* also believe in one Supreme Deity named *Marahtoo*, who is supposed to live 'above and beyond the earth,' and whose assistance is implored on all occasions of danger. The ceremony of adoration or intercession is performed by priestesses or witches, and consists of prayers, accompanied by throwing handfuls of small glass beads in the air, together with small pieces of pork. Among the villagers living near South Cape, however, the belief in a special Supreme Deity is unknown, although spirit-worship prevails, with belief in witchcraft, and in prophetic powers as displayed by certain individuals. Beads and small slips of bamboo blackened on one side constitute the ritual implements used when interviewing the spirits; and the priestesses or witches profess to interpret, by the odd or the even number of beads, or by the position of the bamboo slips as they fall, what the spirits wish to make known. Thus ghosts or spirits of the dead are generally believed in, and thought to be visible to the priestesses; indeed, if they appear to others than those authorized to interview or observe them, it is considered necessary for such unlucky beholders to plead for the immediate intercession of the priestesses, lest death should ensue.

Spirits are supposed to dwell in caves, cliffs, and high places, and to be the cause of echoes; and accordingly such localities are held sacred and reserved for superstitious ceremonies and incantations, these being gone through when the tribe is going on the war-path, when sickness prevails, or on other important occasions. The village elders alone may be spectators of what goes on there, and the chief sight brought before them is that of the priestesses contorting themselves and getting worked up into a kind of ecstasy, till they swoon away or pretend to do so. In this last condition they are left till they enter the village next day to make known the will of the spirits. Those priestesses have a reputation all over the island for superiority in knowledge and power, and they are frequently consulted by the people of other

tribes. The *Amia* believe in an after-state, where good and bad actions performed in this life meet with corresponding rewards and punishments. They have no special code of moral law, but are very much guided by use and wont, and by what they suppose will benefit each other and the community generally. Their creed requires belief in a future heaven, a hell, and a purgatory. Every one, of course, hopes he will go to heaven after death, and hell seems to be reserved as the possible *terminus ad quem* for one's neighbours. They say, however, that, since no one ever comes back to complain, the future world must be better than the one they now live in. Heaven is supposed to be far away to the north, and hell equally far in a southerly direction. Purgatory is in the air, and its inhabitants are ghosts or evil spirits. As to the special delights of heaven or what the punishments inflicted in hell may be, they profess complete ignorance, but hold that the latter cannot be so very severe, for otherwise the spirits would not remain. On this whole subject, their general idea seems to be that each soul will hereafter follow its own tastes and inclinations, the good associating with the good, and the bad with the bad.

There is not much courtship or observance of nuptial ceremonies among the *Amia*. Young people fall in love with each other, and proclaim their intention; should no objection be raised, there is the usual gathering of friends with its necessary feast. Cohabitation takes place immediately after. The *Amia* have only one wife at a time, but divorces are very frequent, and arise from infidelity, or some trifling dispute, or incompatibility of temper. Vicious young men get their wives divorced every two years or so, and wives also desert their husbands on the slightest provocation. Nor do such occurrences give rise to much scandal or comment, as the married state with them can scarcely be called a permanent institution until the males are about forty years of age, when they seem to acquire discretion and a fixed wife simultaneously; for after that, divorces are practically unknown. In cases of divorce, where both the husband and wife were possessed of considerable wealth before marriage, an equitable division of the property and the children is made by the village chief, whose decision is accepted as supreme and final. Sometimes the offspring of divorced persons consult their own inclination as to which parent shall retain custody of them, though in deciding this point the grandparents have an influential voice. No stigma is attached to the children, and, in so far as they can, they strive to take up residence in whichever home is the more comfortable. A curious custom is for all the young unmarried men to live and sleep together in a large dormitory, where storytelling and drinking bouts take place. The idea is to keep the minds of the young women and children from being debased—an end that is served by causing them to come in contact only with staid and elderly people.

Before going to hunt, the *Amia* splits open a betel-nut in which he places a red bead (one of any other colour is unsuitable), and, laying it in the palm of his hand, waves it in the face of heaven, invoking protection and success in the chase. When any one is sick, a sorcerer is called, who waves the leaf of a banana tree over the patient, then sucks the painful part, and, whether the person recovers or dies, the only reward to which the sorcerer is entitled is one of these red beads. Also, when an enemy has been killed, a few drops of his blood are sprinkled on the ground as an expiatory offering to the departed spirit. The staple food of the *Amia* includes beef, pork, and all kinds of fish, with rice and vegetables; but they never partake

of chicken, believing that fowls are the abode of good, gentle spirits, and should, therefore, not be used as food. When hungry and far from home, they find relief by tightening their girdles and chewing betel-nut, of which they always carry an ample supply. They suppose that earthquakes are brought about by a huge pig scratching itself against an iron bar stuck into the earth; rain and wind, by spirits in some way or other; and that thunder and lightning arise from quarrelling between the male and female deities named *Kakring* and *Kalapiat*, the former causing thunder by knocking about the household effects in his anger, and the latter producing lightning by uncovering herself in her displeasure—this being a favourite method which *Amia* females adopt for showing their temper against others. The people of this tribe further believe that the sun, moon, and stars were made by two spirits named respectively *Dgagha* and *Bartsing*; and that the sun revolves every day round the flat world, going under the earth at night. During warm weather, both men and women go about stark naked in their own villages; but, when travelling or hunting outside, the men wear waist-cloths and the women jackets and petticoats. The *Amia* may be put down as numbering about 12,000.

Since the cession of Formosa to Japan in 1895, various successful attempts have been made by Japanese travellers and scholars to obtain fuller information regarding the ethnography, language, customs, and folklore of the native tribes, but their accounts are found only in ephemeral periodicals which are unknown to the outside world, or in reports which were prepared for the local Administration, and they are all in the Japanese language. Y. Ino especially made good use of the opportunity given him for collecting a large amount of useful data in every district of Eastern Formosa; and, from the ethnological and linguistic material obtained, he has divided all the aborigines into the following eight groups, proceeding from the north downwards: (1) *Atayal*, (2) *Vonum*, (3) *Tsou*, (4) *Tsalisen*, (5) *Paiwan*, (6) *Puyuma*, (7) *Ami*, (8) *Pepo*. Only a brief summary can be given here of Ino's remarks on the superstitions of some of these tribes. Among the *Atayal*, ancestor-worship is the main religious observance. The people suspend cakes or boiled rice or millet from trees, on the day before full-moon at seed-time and harvest, and hold a general feast next day, at which there is much drunkenness, and any amount of riotous, licentious dancing by the young women and girls of the village. The *Vonum* also meet for ancestor-worship twice a year. Their distinctive ceremony consists in the fixing in their houses of bundles of green grass, and sprinkling native whisky on the ground in front—such spots being looked upon as sacred that day—and, while fire from the striking of steel on flint serves for everyday use, it must be obtained by the rubbing of two sticks on ceremonial occasions like this. People of the *Tsou* tribe have a tree near the entrance to their villages which is thought to have a peculiar sanctity attached to it, and once a year they sprinkle whisky on the ground under its branches, and worship the spirits of their ancestors. They also regard a certain kind of orchid as sacred, and carefully cultivate it near the holy tree just now referred to, as their

forefathers are supposed to have carried this flower into battle and thereby to have gained their victories. The *Tsalisen* occasionally observe a ceremony which takes the form of arranging on the ground dishes containing rice, millet, fruit, and native wine, and mumbling over them certain prayers or incantations, the spirits thus invoked being supposed to come down and preside so long as the ceremony lasts. Severe penalties are inflicted on any one who breaks the rules of this ceremony, or who offends by stepping within the charmed circle. A tradition is current among the *Tsalisen* that their ancestors came down from heaven with twelve earthen jars; and another tradition is that the moon gave birth to them, for which reasons an old earthenware jar and an ancient circular piece of white stone are still preserved and treasured as being of peculiar sanctity. Many of the *Paiwan* think that the spirits of their ancestors dwell in a thick wood; others that they are enshrined in swords handed down from generation to generation. They worship them when about to plant their fields and at harvest-time, and once every five years, on one of these festival days, they join in a game called *Mavayaiya*. This takes the form of the players trying to catch a bundle of woodbark on the point of their bamboo lances, the one who impales it being considered the victor. According to current tradition, this practice is the survival of an ancient game in which a human head was tossed about and then offered as a sacrifice to the spirits. On a certain festival day among the *Puyuma*, a monkey is captured and tied to a tree in front of the boys' public dormitory, where it is killed by the arrows which are thrown at it. The village chief afterwards steps forward and throws a little wine three times skyward, and a little more three times to the ground. All present thereupon spit on the dead monkey, and cast its body away, before joining hands in the hilarious dance which follows. Tradition explains that during early times, when the *Puyuma* were all-powerful, a member of some subjugated tribe was always sacrificed on such occasions, but that, in their present weakened condition, they have to be satisfied with the oblation of a monkey.

LITERATURE.—R. Swinhoe, 'Notes on the Ethnology of Formosa,' in *Rep. of the Brit. Assoc.*, 1863; M. Guérin, 'Les Aborigènes de l'île de Formose,' in *Bull. de la Soc. de Géogr.*, 1858, p. 542; E. C. Taintor, 'The Aborigines of Formosa,' in *JRAS, N. China Branch*, x. (1874) 53-88; T. L. Bullock, 'Formosa Dialects and their Connection with Malay,' in *China Review*, iii. (1875) 88-46; J. Dodd, 'On the probable Origin of the Hill Tribes of Formosa,' in *JRAS, Straits Branch*, ix. (1878) 68-84, x. (1879) 195-212, and 'On the Manners and Customs of the Hill Tribes of Formosa,' *ib.* xv. (1885) 69-78; G. de Rialle, 'Formose et ses habitants,' in *RAnth* viii. (1855) 58-78, 247-281; G. Taylor, 'Savage Priestesses in Formosa,' in *China Review*, xiv. (1886) 14-16, 'The Aborigines of Formosa,' *ib.* pp. 121-126, 194-198, 285-290, 'Spiritualism in Formosa,' *ib.* 304-305, 'Folklore of Aboriginal Formosa,' in *FLJ* v. (1887) 139-153, and 'Characteristic Traits of the Aboriginal Inhabitants of Formosa,' in *Proc. Roy. Geogr. Soc.*, April 1889, pp. 224-239; T. de Lacouperie, 'Note on nine MSS from Formosa,' in *JRAS* xix. (1887) 413-494; W. Campbell, *The Gospel of St. Matthew in Sinhang-Formosa, Dutch, and English* (from Gravius' ed. of 1661), London, 1888, *The Articles of Christian Instruction in Favorlang-Formosan, Dutch, and English* (ed. from Vertrecht's MS. of 1650, with Psalmanazar's *Dialogue between a Japanese and a Formosan*, and Happart's *Favorlang Vocabulary*), do. 1896, and *Formosa under the Dutch, with Explanatory Notes and a Bibliography of the Island*, do. 1903; Adolf Fischer, *Streifzüge durch Formosa*, Berlin, 1889; J. W. Davidson, *The Island of Formosa, Past and Present*, London, 1903.

W. CAMPBELL.

FORTUNE.

Biblical and Christian (R. W. MOSS), p. 88.

Celtic.—See COMMUNION WITH DEITY (Celtic), DIVINATION (Celtic), and especially FATE (Celtic).

Chinese (W. G. WALSHE), p. 91.

Greek (ST. GEORGE STOCK), p. 93.

Iranian (L. H. GRAY), p. 96.

Jewish (A. E. SUFFRIN), p. 96.

Roman (W. WARDE FOWLER), p. 98.

FORTUNE (Biblical and Christian).—Two inconsistent conceptions of fortune are found in association with Heb. thought. The one recognizes it as a superhuman force acting alike upon gods and men, and gradually deifies it as a person to be invoked and appeased. The other keeps its apportionment strictly within the functions of Jahweh, without any betrayal of the monotheistic position; and this conception eventually established itself as a norm of thought and devotion in Christendom.

I. There are several indications that Fortune was known to the early Semites under the name of *Gad*, and amongst them must be placed the ancient tradition in Gn 30¹¹. If the text be read according to the direction of the Massorettes (גַּד גַּד; so also the Targum), Leah is represented as first exclaiming, 'Good fortune is come,' and then selecting the term as the name of her handmaid's son. The tribal name may have been current before this explanation of its origin was given; but the vivid human interest of the narrative points on the whole to the opposite conclusion. The Aram. lady was so delighted at the success of her device and the close of her disappointments that she gratefully recognized the action of the power which she had already learnt to be superior to any local god, and chose for the child a name that would be a memorial of her gratitude and a pledge of his future prosperity. At the time of the narrator this power had probably itself been invested with personality and exalted to the rank of a god. At the more ancient period, in which the traditional story is placed, an earlier stage in the development of the thought is represented. The power is conceived as impersonal, with a certain degree of uncertainty attaching to it, which could not be entirely removed by any kind of appeasement. The endeavour to devise means of ensuring the favourable action of this force must have been an important factor both in hastening the process of personification and in grouping the gods into a hierarchy.

1. **Origin of the term.**—Etymologically the radical idea in the word *Gad* is that of cutting or penetrating into something—cutting the flesh as a religious observance (1 K 18²⁸), or making attacks upon the life of the righteous (Ps 94²¹). 'Cutting off' so as to make detachments or bands is a later meaning (see *Oxf. Heb. Lex. s.v.*). Hence fortune is conceived primarily as an external influence, hostile, or at least likely to be mischievous, breaking in upon a man's hope or scheme, and not to be averted by the ordinary worship of the local god. It was an easy step, in accordance with principles traceable in almost all the early stages of primitive religion, to invest this influence with neutral qualities and make it a source of good as well as evil. That is evidently the stage corresponding with the presuppositions of the narrative of Leah; and the full personification of Fortune as superior to the local gods and altogether outside their control was a natural corollary.

2. **Early range of the conception in Israel.**—It was almost certainly from the Canaanites that Israel learnt this conception of Fortune, and also borrowed the nomenclature. Several place-names might be quoted in evidence. On the northern limit of

Joshua's conquest was the town of Baal-gad (Jos 11¹⁷ 12⁷ 13⁵), possibly identical with the Baal-hermon of 1 Ch 5²³ (but see Curtis, *ICC* [1910], *in loc.*) and Jg 3³. The boundary was variously designated, topographically by the conspicuous landmark of the famous mountain, or, more reverently, by the village on its slopes with the significant name 'The Lord of Good Fortune,' or 'Good Fortune is our Lord.' To interpret the place-name as denoting that Baal brings good fortune to those who reside there is to ascribe to the people an impossible degree of idolatry even in those polytheistic days, unless the name was current among the earlier Can. population. In that case it is easy to understand why the Israelites sometimes preferred to call the place by a less suggestive name. Migdal-gad (Jos 15³⁷), again, in the territory of Judah, is 'the tower of Gad,' and is commemorative of the ancient worship there. Apparently it dates back to a time when Fortune had already become personified in the locality.

A similar feature can be traced in personal names, two of which at least are very ancient. Gaddi (Nu 13¹¹), 'my fortune,' was one of the twelve spies; and Gaddiel (Nu 13¹⁰), 'God is my fortune,' was another. Neither of these involves the conclusion that Fortune was already regarded as an independent deity. Endearment or devoutness is a sufficient explanation. The former recurs again centuries later under the form of Gaddis (1 Mac 2²), the eldest brother of Judas Maccabæus. For Gadi (2 K 15¹⁴ 17), the father of Menahem, there are Nabatæan and Palmyrene parallels; and a fond name of such a kind would naturally be popular with mothers. Azgad (אֶזְגָד) is the name of one of the signatories of the covenant in Neh 10¹⁵. A number of the family or clan had returned with Ezra (2¹²; but cf. Neh 7¹⁷, 1 Es 5¹³ 8³⁸, RVm). The clan was evidently a large one, and the original detachment was followed by a second. Its name has been identified with the Aram. אֶזְגָד or אֶזְגָר (*Targ. Is* 18²), a 'runner' or 'messenger'; but no early instances of its use in this sense can be found. 'Gad is mighty' (Gray, *Heb. Prop. Names*, London, 1896, p. 145) is the meaning; and the thought is not a general complaint of the hardness of fate, but the ascription of power to a god Fortune conceived as personal. It is not probable that this family learnt this special form of idolatry in Babylon, for so far that district has yielded few, if any, traces of the prevalence within it of the worship of Fortune. The family became familiar with the worship in their earlier Canaanitish home, and brought it with them to Babylon, where, in the misery and disappointment of the times, it may well have spread among their countrymen, though not attracting the native Babylonians. That large numbers of this family should join the return from the Exile would be due partly to a reaction in favour of the worship of Jahweh, and partly to an adventurous and unstable type of character.

The only explicit reference in the OT to the worship of Fortune is in Is 65¹¹, where also the kindred deity Destiny (Meni) appears. The passage may be dated before the reforms of Nehemiah (Box, *Isaiah*, 338), or even before the return from the Exile, in which case it may help to account for the large representation of the B'nê 'Azgad among

the exiles. It shows that the worship of Gad was well organized with a full ritual, and with attractions that appealed strongly to certain types of mind and conflicted with the claims of Jahweh. The group of rites was an adaptation of the primitive *lectisternium*, in which the images of the gods were placed on couches before tables covered with viands (cf. Jer 7¹⁸). Fortune and Destiny would be treated thus in association (cf. Jerome, *in loc.*), there being, indeed, traces that the two were thought of as a pair, different in gender but complementary in function. This 'preparing a table' does not carry the idea of indulgence and debauchery, as in Ezk 23⁴¹. The thought was that the worshipper would ingratiate himself with the gods, averting ills which Destiny had prepared and securing the beneficence of Fortune; and the simple motive of courting the favour of a god was both original and permanent (cf. Jer 44¹⁷, Bel¹¹⁵).

3. Range outside Israel.—It is not easy to relate the worship of Fortune in Israel with that in kindred races. Aramæan, Arabic, and Syrian parallels are available; and there are possible connexions with Bab. beliefs, though there is no distinct mention of the god. Lenormant writes (*Chald. Magic*, Eng. tr., London, 1877, p. 120) of a 'Manu the great, who presided over fate'; and Sayce states (*Hibb. Lect.*, 1891, pp. 460, 476, 489) that Merodach was worshipped with a view to ensure prosperity. Hence Gad and Meni have been identified with Merodach and Istar; and this has been strengthened by the Oriental practice of worshipping Jupiter and Venus as the Larger and the Lesser Luck. Yet the result may be only an illustration of the tendency to invest the gods with real influence upon the life of man, or, under other circumstances, to identify them with the planets. For, in the Isaianic passages, Fortune and Destiny are antithetical rather than graded powers; and Meni is the god of a hostile fate, not of a lower degree of good fortune (cf. Skinner, *in loc.*). Similarly the LXX renders Gad by *δαίμωνιον* and Meni by *τύχη*, though the reverse order is supported by evidence of value, both MS and Patristic. But the significant thing is that the translators selected equivalents that are in antithesis. The one denotes a goddess, conceived as benignant; the other a supernatural force, awful, arbitrary, and only with difficulty persuaded to assume an attitude even of neutrality. The Bab. conception was different. It invested its higher deities with a power of affecting man in his enterprise and ways; but, as far as available information goes, it did not personify this power, or even separate in thought the power from the gods so far as to reach the Greek conception of a natural force playing upon gods and men alike. Hence neither the origin of the name Gad nor the responsibility for his worship can be claimed for Babylon. In Persian religious thought there is a closer parallel, possibly dependent in part upon Heb. influences and itself in turn influencing the development of the conception in Israel. An Old Persian word for 'god' is *baga* (Av. *bagha*; Skr. *bhaga*, 'fortune'; an implication of divinity accompanying the Av. term). *Βαγαιός* as a Phrygian name for Zeus, and the identification of Gad with Jupiter, may be of a later date.

At a comparatively early period signs of personification appeared in the principal Sem. dialects. A transition is found in the Syr. phrase quoted by Baethgen, 'I swear by the Fortune (ⲁⲛⲓ) of the king,' with which may be compared the practice of swearing by the *τύχη* of the Seleucids. To places also the name was applied, at first adjectively in the sense of lucky or unlucky, and then with the implication that the place was the abode of a genius or god, kindly or ill-disposed. Both the Isaianic passage and the non-Jewish evidence

point back to an indeterminate period, during which the process of deification had been going on. For, just as an inscription of the 4th cent. B.C., dealing with the financial administration of Lycurgus, refers to the cost of the sacrifices *τῆ Ἀγαθῆ Τύχῃ* (Roberts and Gardner, *Introd. to Gr. Epigraphy*, Cambridge, 1905, 100 Aa 12), and conveys the impression that the worship was longstanding, there are Phœnician, Nabatæan, and Palmyrene inscriptions of a contemporaneous or little later date, which refer to the worship of Gad as though its origin were lost in antiquity and its prevalence were known to all. A Punic inscription of 254 B.C. (Cooke, *North Sem. Inscr.* Oxford, 1903, p. 27) carries back the line of descent of one of the royal *καθηφόροι* to an ancestor who is described as *גד גורע*. Baethgen reads the name as 'The Fortune of Athe,' Athe being probably identical with the Phrygian Attis or Adonis, whose cult was popular in the district (see, however, Nöldeke, *ZDMG* xlii. 471); and in any case a Phœnician deification of Gad at an early date must be allowed. A later inscription was discovered at Maktar in 1892, and records that a local council vowed to *גד היס*—a close parallel to the 'Fortunæ Cœlestis sacrum' of *CIL* viii. 6943. 'Lovers of Gad' is the title given on an altar in a village in Hauran to the family at whose expense the altar was built. The Palmyrene inscriptions are later, but again are evidence of a well-established practice. One of them links the worship of Bel with that of *גד היס = Τύχη Θαιμείος*, i.e. Gad, the patron deity of the clan *י'ח*. Another protects a sepulchre with the imprecation that the breaker-in may 'have no seed or fortune for ever,' and thereby shows how the original conception of fortune as not itself a god, but simply a good gift administered by a god, lingered side by side with the later impersonation. Altogether it is certain that the tendency to deify Fortune was not specific to Israel, but common to the different races among which Israel grew up. It found expression in the roots of their language; it took definite shape in the attempt to analyze and group the apparently superhuman activities that were traceable in human life; and in the struggle with monotheism it was at length worsted, surviving in the form only of a private superstition.

In pre-Islamite Arabia, again, Manât is one of the three chief deities (cf. Qur'an, liii. 20; Wellhausen, *Reste arab. Heid.*, Berlin, 1897, p. 25; Lyall, *Anc. Arab. Poetry*, London, 1885, p. xxix), and is identified by the astrologers with Venus, the goddess of Lesser Luck (Siegfried, *JPh*, 1875, p. 356 ff.). Gad would consequently be the god of the Greater Luck, and equivalent in popular thought to Jupiter, to whom that title was given. These, however, are comparatively late identifications, and cannot have exercised any influence on the growth of the conception in Israel. What is wanted is a common source for beliefs that prevailed among the principal Sem. races, and cannot at present be traced in Bab. literature. The Assyr. Manu rabu (*WAI* iii. 66) has been suggested as the origin of Meni (Lenormant, 120), with Kibi-dunki as that of Gad. The latter god is described as a dispenser of favours; but the linguistic affinities are too remote to allow a confident assertion of dependence. It is more likely that the starting-point is to be found in a primitive human instinct, or rather in one of the earliest differentiations of the religious instinct, and that the development itself in Israel, checked at times of religious revival, recovered under the influence of the indigenous and neighbouring peoples.

4. In the NT.—There are no distinct indications in the NT of the personification of Fortune or of his particular worship. The nearest passage is

1 Co 10²¹; but 'the table of demons' need not even be the formal *lectisternium* in the precincts of the altar or anything more than the feast that was customary after certain sacrifices. It shows that the Christians at Corinth were in danger of becoming entangled in the idolatrous usages of their city, but not that they had yielded to the seductions of the worship of Fortune. Nor may such an inference be drawn from the allusions to sorcery and other magical arts in such passages as Ac 8⁹ 13⁶, Gal 5²⁰, Rev 9²¹ 21⁸ 22¹⁵ *et al.* (see DIVINATION). For, though it was undoubtedly believed that in such ways the weather and the crops, and the health and conditions of men, might be affected for weal or woe, the power assumed to be under the control of the sorcerer was rarely viewed as concentrated in a single person of Divine rank. A close connexion with idolatry is evident, especially in the cities of Asia; but not many in the Christian communities went further than to suspect or suppose that the arts of the sorcerer might elicit supernatural influences or even stir demonic agencies into action. Of the recognition of Fortune as a distinct deity there are no clear traces.

II. While the worship of Fortune was a form of idolatry that marked certain groups in Israel and occasionally became a national danger, views consistent with monotheism appeared at an early time, survived temporary and partial eclipses, gradually gathered force, and in the Christian era may be said to have held the field without any real rival. Of these views, common to both Jews and Christians, it is possible to distinguish several constituent elements.

1. The fundamental belief is that man's earthly fortune, with all its changes, is in the hands of God. To that belief frequent and varied expression is given in Scripture. Pleas for gratitude because of God's gift of good fortune are abundant (as in Dt 6^{10a}); and the Song of Moses is a tribute to God as the dispenser of earthly favour, and a call upon Israel for worship because in that respect there is none like Him (Dt 33²⁶). It was an ancient proverb that 'the lot is cast into the lap; but the whole disposing thereof is of the Lord' (Pr 16³³); and in the early Christian practice the object was to provide a means by which an intimation of the Divine will might be given (Ac 1²⁴ 2⁸). Ps 31¹⁵ sets each of the godly remnant singing 'My times are in thy hand,' much as in Is 33⁶ 'stability in thy times' is made the principal result of the fear of the Lord. All useful gifts, writes St. James (1⁷), are 'from above, coming down from the Father of lights'; similarly Jesus Christ in Mt 7¹¹ and 6³², where He even expostulates with men for supposing that their physical needs are forgotten. On the other hand, God dispenses evil fortune, according to the OT, where evil spirits and even Satan (Job 1⁶) are His ministers, by means of whom He brings adversity and disaster upon men. In the NT these beings become antagonistic to Him, and themselves independent sources of evil; but they are still subject to His restraints, and countervailing aids are provided (2 Co 12⁷ 9). Everywhere God is the Lord of life; and the degree of earthly weal or woe is portioned out by Him.

2. As to God's aim in determining the changing conditions of life, there is a difference, at least in emphasis, between the teaching of the OT and that of the NT. Briefly the difference is that in the latter case moral considerations outweigh material good fortune, and secular blessedness falls into the background. The promises of the inheritance of the land (Ps 37²⁹, Is 57¹³ *et al.*) were taken literally in the one case, but in the other (Mt 5⁵) are inextricably involved with moral advantage. Even Ps 23, with its marvellous history in the records

of devotion, is concerned primarily with earthly fortune; and the still waters, green pastures, and spread table are at least as prominent as the guidance in the paths of righteousness and the confidence of the conscious presence of God. Between Job's estimate of life's relative values and that of St. Paul, there is a striking contrast. Job loses everything; and, when his mind is chastened, he gains more than he had originally possessed (Job 42^{11c}). Paul, too, lost most of the good fortune that men prize; but the effect was to make him exult in the fellowship of Christ's sufferings (Ph 3¹⁰), and count all things only refuse, if he could but 'gain Christ and be found in him' (3^{8c}). Earthly comfort in its varied forms is the principal and most prominent, though not by any means the only, pursuit of the good man in the OT; whereas against such comfort, either in itself or in its natural influence on human character, the NT with the strenuous and lowly life of Jesus in its centre is a protest. From Mt 5⁴⁵ alone it might be inferred that God is indifferent to the morals of men in His gift of fortune; but the real meaning is that He affords the supreme example of fatherly love by showering kindnesses upon His children, though erring (2 P 3⁹). His aim is conceived as no longer chiefly or only earthly good, but as the moral perfecting of men. 'Rains and fruitful seasons' are sent not merely to fill the floors with wheat and the vats with wine and oil (Jl 2^{23c}), but as witnesses to Himself (Ac 14¹⁷); and the fortunes of men are so arranged as to become opportunities for or incitements to repentance (Ac 11¹⁸). As He works in men in the prosecution of His benevolent purpose (Ph 2¹³), so He works around them, shaping their lives with a view to their spiritual triumph.

3. The methods He uses sometimes seem arbitrary; nor have the difficulties been entirely removed either by the teaching of Scripture or by later Christian thinking. In His administration of fortune, God sends or permits to come to men pain, sorrow, loss, at times the most poignant and intolerable; and the numerous instances where there is no manifest balance between a man's real deserts and his fortunes carry God's methods as the Lord of human lives beyond the reach of intelligence, and invest them with mystery and apparent self-will. Partial relief may be found, as the Christian poets have been quick to see, in the educative value of pain and adversity, the opportunities for growth by exercise presented to the active and passive virtues alike. And the residue of unintelligibility is no necessary proof of arbitrariness. It may be regarded as unavoidable, or even as an indication of correct thinking, when a finite mind attempts to interpret the ways of the Infinite, and as involved in the great principle of every religion worthy the name that 'we walk by faith, not by appearance' (2 Co 5⁷ marg.).

4. Obscure as God's methods may be, the uniform representation of Scripture is that they are wise and gracious, and, subject to the right action of man's will, effective. The fundamental principle according to which His gifts are bestowed is indicated in the parable of the Talents—'to each according to his several ability' (Mt 25¹⁵), which throws light upon the 'dividing to each one severally even as he will' of 1 Co 12¹¹. The distribution of fortune, as of natural gifts and of function, is in the hand of God, from whom no one is entitled to ask an explanation; yet He does not act without reason, but assigns to each man a lot in life and a series of experiences, such as each is best able to turn to purposes of moral advancement. The co-operation of man's will is indispensable, and neglect or rebellion on his part may make it necessary for God to arrange for him a new set of experiences (Jer 18⁴ 7-10), as His own design to enable a man to

make the best of himself is unchanging. No course could be wiser or kinder than to adapt the conditions of life in the interest of moral training and to the needs of mutual service. How God's particular gifts in detail conduce to that end is often a bitter and insoluble problem; but that such is the principle on which He acts is the implication of Scripture and the treasured conviction of Christendom.

5. Of this belief in the obscure but ethical disposal of human fortunes by God the Incarnation in some of its aspects is an illustration and pledge. On the one hand, as devised by God, it is such a modification of earthly conditions as is designed to bring redemption nigh. The cosmic relations are altered by the introduction of a new and mightier force; and upon the individual play influences from the incarnate Person and Life, which strengthen the tendencies to right and make the passage easier. Good fortune smiles upon him in his upward struggle, and supplies him with encouragement and aid. Further, in that God spared not His own Son (Ro 8³²), the transcendent gift is a proof that His bounty will provide everything necessary for salvation, and order and re-adjust the changing fortunes of man accordingly. On the other hand, the varied incidence of fortune in the life of the Incarnate Himself brought opportunities for His growth in wisdom and in favour with God and man (Lk 2⁵²). Though he was Son, yet He learned obedience by the things which He suffered (He 5⁸), the tragedies of His life becoming a discipline in which there was no spirit of disobedience to be overcome, but a self-surrender to be kept complete at every stage by a deepening insight into the Father's will. Thus 'through sufferings' He was made perfect (He 2¹⁰); His humanity in its absolute dependence upon God became complete in moral dignity and power—a qualification for sympathy with man in every state of fortune, and an eternal proof that God's intention in regulating the good and ill of life is to lead men on without coercion to obedience and perfecting.

LITERATURE.—Commentaries on Gn 30¹¹, especially Dillmann⁶ (1892), Delitzsch⁵ (1887), Gunkel² (1902), Driver (1904), Skinner (1910); and on Is 65¹¹, especially G. A. Smith⁴ (1889), Delitzsch⁴ (1889), Duhm² (1902), and Box (1908). Siegfried's essay in *JPTA* (1875) 356 ff., is especially valuable. Add F. Baethgen, *Beiträge z. sem. Relig.*, Berlin, 1888; J. Wellhausen, *Skizzen u. Vorarbeiten*², Berlin, 1899; Nöldeke, in *ZDMG* xlii. (1888) 479 ff.; and Baudissin, 'Gad,' in *PRE*³ vi. (1899) 328-336.
R. W. MOSS.

FORTUNE (Chinese).—Popular ideas of what constitutes Fortune among the Chinese are variously classified.

1. We have, for instance, the 'Three Auspicious Stars,' an almost universal compendium, viz. Happiness, Emolument, and Longevity. A brief examination of each of these will help to elucidate the meaning which they convey to the Chinese mind.

Happiness is represented by the character *Fu*, and is frequently symbolized by the figure of a bat, the words for 'happiness' and 'bat' being similar in sound. *Fu* consists of a combination of two characters, signifying 'worship' and 'full,' and is explained to mean 'the felicity which attends Divine protection.' The character is found in every possible connexion: on the gables of houses, on the outside of funeral vaults, on written or painted scrolls; and is constantly heard from the lips of mendicants, and in all forms of congratulatory speech. It may be said to include every variety of earthly desiderata, and to correspond to our notion of 'blessedness.'

Emolument (Luh) is equivalent to the receipt of official stipend, or the material happiness which is conferred by the Imperial favour; and suggests the fact that in China, one of the great objects of

ambition, and one avenue to greatness which is open, practically, to all classes of people, is the attaining of a position in the service of Government. The 'upper classes' in China consist, almost exclusively, of officials or their relatives, and the 'landed gentry' are represented, to a large extent, by retired officers or their descendants. To the Chinese, therefore, the 'happiness' of official emolument is an endowment of a much more tangible character, and much more capable of realization, than its equivalent in Europe. The word *Luh* is pronounced in the same way as that which stands for 'deer,' and hence 'office' or 'emolument' is often suggested, symbolically, by the picture of one of these animals.

Longevity (Shou)—compounded of the characters for 'old' and 'speak,' indicating the prerogative of age to speak with authority—is frequently represented by a crane or a tortoise, creatures regarded as enjoying an extraordinarily long term of life; and, in Taoist circles, by the peach, with which is connected the gift of immortality.

'May the Three Stars [*i.e.* Happiness, Emolument, and Longevity] shine on you!' is a familiar inscription on complimentary scrolls, etc.

It must not be supposed that every one possesses an equally unlimited capacity for enjoying these various benefits. Like the operations of Fate, they are strictly measured by the receptivity of those who would seek to partake of them. The portion of happiness which is allotted to a man may be early exhausted by too large drafts upon it; the conditions may be present, but not the power to assimilate the blessings proffered. Happiness, in measure, is within the reach of all, but great endowments are the lot of the few. Similarly, with regard to preferment, though it is asserted that 'God never sends a man into the world without providing him with a place and a vocation,' it is also admitted that he may be unable to maintain the dignity of the office which Heaven has assigned him. Longevity depends upon the Decree (see FATE [Chinese]), but it rests to a large extent with the object of that foreordination whether he attains to the full measure of his allotted span or not. The possession of these gifts, in any large proportion, is recognized as depending on Heaven's apportionment—as the proverb says, 'Complete happiness comes from Heaven'; whilst a lesser degree may be cultivated by the virtuous—'Great virtue carries happiness along with it'; 'To dwell in peace is happiness.'

2. A somewhat more comprehensive category is that of the 'Five Blessings,' viz. Longevity, Wealth, Tranquillity, Love of Virtue, and a Fulfilled Destiny.

Wealth.—The character *Fu*, which differs in tone from that which stands for 'happiness,' though both are spelt alike in the Roman system, is explained as signifying a well-filled shelter; and, no doubt, to the vast majority of the Chinese this best represents the gifts of Fortune. The god of wealth is found in a conspicuous place in almost every house of business, and is daily propitiated with offerings and genuflexions; for, though economy and finesse are recognized as having an important bearing on the acquisition of wealth, it is believed that 'riches and honour depend upon Heaven.' In this connexion also it is understood that only to a minor extent can man attain to Fortune by his own efforts—as the proverb says, 'Great wealth is from Heaven, little wealth comes from diligence.' The mind which is wholly concentrated on amassing a fortune is likely to be disappointed, since 'Longing for wealth destroys happiness,' 'Man dies in the pursuit of wealth.'

Tranquillity includes health of body as well as peace of mind.

The Love of Virtue is regarded as one of the most certain means to Fortune—as the proverb says, 'To those who do good deeds in secret, Heaven sends happiness in return'; 'Those who rely on virtue prosper'; 'By a single day's practice of virtue, though happiness be not attained, yet misery may be kept at a distance'; 'Perfect virtue acquires nothing, therefore it obtains everything'; 'Perfect virtue does nothing, but there is nothing which it does not do.'

A *Fulfilled Destiny*, or to 'attain to the end of the Decree,' is equivalent to completing the span of life which is allotted; or, in other words, to die a natural death.

3. Another summary is described as the 'Three Abundances,' i.e. Abundance of Good Fortune (*Fu*), Abundance of Years (*Shou*), and Abundance of Male Offspring (*Nan*); but these are recognized as comprehended in the above, and as being synonymous with Wealth, Honour, and Tranquillity. With regard to the last item there is a proverb which says: 'If your sons and grandsons are good, what (other) wealth do you want? If they are bad, what use is wealth to you?'

4. There are other terms applied to Fortune, such as the 'revolution' or 'wheel of fortune,' and the Creator is sometimes referred to in language which seems to represent Him as 'Fortune,' in accordance with the idea that what is brought about for men by a higher power is to be attributed to Fortune.

5. Methods adopted for the attainment of Fortune.—The pursuit of Virtue was, in the early days, regarded as the best, if not the only, means by which the gifts of Fortune might be attained, such gifts being then comprehended under the heads of 'riches and honour'; and in the Classics there are very few references to any arbitrary methods for the acquisition of those gifts. The following of the *Tao*, or living in conformity with Nature, was regarded as the surest way of attaining happiness; but in later ages—possibly as a result of the introduction of Buddhism, with its material objects of worship—a host of divinities was gradually invented, including the 'happy gods,' or gods of Fortune (the Chinese equivalent of the Lares and Penates), who are worshipped with a view to the dispensation of the gifts of Fortune. Thus the *god of wealth* is represented as supporting in one hand a 'shoe' of silver, and holding up a number of fingers of the other to indicate, as is popularly supposed, the amount of percentage he guarantees his votaries. The *god of the hearth*, commonly described as the 'kitchen god,' usually takes the form of a rough print, which is pasted on the wall of the large oven which serves for cooking purposes in Chinese kitchens. The spirit is supposed to preside over the affairs of the household, and is periodically 'invited,' or presented with offerings of food (in some families twice a month); and on the occasion when the 'god' is timed to ascend, in a chariot of fire, to Heaven, i.e. by being burnt in a bonfire, a special oblation of flesh is presented, so as to secure his goodwill as he mounts aloft to report the doings of the household during the year just closing. *Kwanyin*, generally denominated the 'goddess of mercy,' is worshipped by women who are desirous of obtaining male offspring, her name in Chinese being most commonly known as the 'Giver of sons.' The figure of the goddess is in some cases an almost exact replica of the Madonna and Infant—a resemblance which, there is good reason for believing, is the result of a definite historical connexion, rather than a mere accidental coincidence. The varieties of means for warding off evil influences and inducing prosperity are almost incalculable, including the wearing of charms of every description, the

writing of felicitous inscriptions on doors and walls, the scattering of a special powder in the four corners of apartments, the avoidance of ill-omened expressions on festival and other special occasions, and the careful study of the calendar with a view to the discovery of lucky and unlucky days.

6. Fortune-telling.—In the case of those who are in doubt, recourse to various classes of fortune-tellers is usual. These 'calculators of destiny' are generally divided into six classes: (1) those who profess to foretell the future by combining the eight cyclical characters which denote the year, month, day, and hour of birth; (2) those who study the physiognomy, the fingers, etc., of their clients, and attempt to delineate character, etc., thereby; (3) those who employ a number of slips of paper—generally 64 pieces—on which special symbols are written, and a specially-trained bird, which picks out two of these at a signal from its master; the two characters thus selected are interpreted as applying to the circumstances of the inquirer; (4) those who dissect the two written characters which are drawn at random by the applicant from a number submitted to him, and thus profess to trace his fortunes; (5) those who use a tortoise-shell and three ancient coins, or other contrivances, after the manner of throwing dice; (6) professors of *Feng-shui*, or geomancers, who examine the configuration of the countryside for lucky sites for buildings, tombs, etc. Cf., further, *ERE* iii. 731^b.

7. *Feng-shui*, 'wind and water,' is fully treated in a separate article, vol. v. p. 833.

8. Popular scepticism.—Whilst recognizing the fact of the traditions which appear to find almost universal acceptance, it is well to remember that there is another aspect of the question, represented by the common proverbs which seem to cast doubt upon the orthodox beliefs. To refer to the several departments of happiness which are represented as ideal, it may be said that, though the traditional means for the attainment of these desired ends are plainly exhibited and generally adopted, painful experience and doubt-provoking disappointment have suggested that the nominal high roads do not always lead to the destination indicated, as the following quotations may serve to show.

Happiness.—'Success (*Fu*) is the lurking-place of failure.' 'He who possesses a liberal mind will have great happiness.' 'The happy man finds a happy grave without the aid of the geomancer.' 'The fortune-teller dies in the prime of life, the *Feng-shui* philosopher has no burying-place.' 'The geomancer, whilst pointing south, north, west, and east, mumbles unmeaning words; if among the hills there are places which ensure nobility to later generations, why do they not seek such a place and bury their own ancestors there?' 'Misfortune and prosperity have no door, they are evoked by men themselves.'

Emolument.—'Riches and honour are but a dream, office and emolument like bubbles on the water.' 'Wealth is the store-house of resentment.' 'Honesty never gets rich.' 'To him who does not covet money it comes of itself.' 'Promote happiness by being content, promote health by keeping an easy stomach, promote wealth by cutting down expenses.'

Longevity.—'For cultivating long life there is nothing like moral goodness.' 'The benevolent are long-lived.' 'Virtue is a sure means of longevity.'

Similar expressions are applied to Fortune generally, as, e.g., 'If heart and luck both are bad, you will be poor all your life long.' 'Lucky people need never be in a hurry.' 'The unlucky may do anything.'

Thus, though belief in the efficacy of charms of various kinds may appear to be universal, and fortune-telling, in its several departments, has proved to be a most profitable business, it is nevertheless a fact that, even amongst those who constantly resort to these methods, there is a deep underlying suspicion as to their effectiveness. It may well be that, as the drowning man clutches at a straw, so the Chinese people, taking counsel of despair, find some consolation in the thought that by so doing they are omitting no precaution; and that, even if no good may result, no harm is done in thus maintaining the traditional observances.

The very complexity of the methods may itself account for the growth of sceptical opinions; the number of lucky days, as set forth in the Imperial calendar, and the innumerable cross-currents of good and evil fortune which must be considered in the selection of a date for any enterprise, have resulted in the feeling expressed by the paradox that one is as little likely to go astray by neglecting to consult the calendar as he is in attempting to unravel the complications which attend the selection of a lucky day, according to the arbitrary methods therein set forth. Superstition in China has, therefore, overreached itself, and the future of the Chinese people may serve to show that the chains of traditional custom are not so inexorably fixed as has been generally supposed by their Western critics.

LITERATURE.—See under FATE (Chinese) and FENG-SHUI.
W. GILBERT WALSHE.

FORTUNE (Greek).—The word *τύχη* contains the stem of the verb *τυγχάνειν*, which meant originally *to hit the mark*, as *ἀμαρτάνειν* meant *to miss the mark*. Hence *τύχη* had about it, to begin with, the idea of success. The conception of Fortune is absent from the early religion of the Greeks. Macrobius (*Sat.* v. 16) has pointed out that the word *τύχη* never occurs in Homer. By the father of poets everything is assigned to *μοῖρα*. On the other hand, Macrobius remarks that the later poet Vergil even ascribes omnipotence to Fortune. Fortune is a goddess who grows up before our eyes within historical times. There is no mythological history attaching to her. She is more like the simple allegorizations of Roman religion than the complex deities of Olympus, endowed with a family history, personality, and adventures by the prolific fancy of the Greeks. She is not, as some have supposed, an importation from Asia, like Cybele; nor is it necessary to connect her with the mysterious *Cabeiri*. Fortune is rather a home-growth of the Greek intellect. The connexion between the nymph Tyche and the goddess Tyche, which has been so charmingly traced by F. Allègre, seems to be devoid of solid foundation. We read in the *Theogony* of Hesiod (line 360) that one of the daughters of Oceanus and Tethys bore this name:

Εὐδώρη τε, Τύχη τε, καὶ Ἀμφιρῶ, Ὀκυρόη τε.

And again in the 'Homeric' *Hymn to Demeter* (line 420) one of the maidens who was playing with Persephone, when she was carried off by Pluto, was called by the same name:

Μηλόβοσις τε, Τύχη τε καὶ Ὀκυρόη καλυκῶπις.

The juxtaposition of the two names *Τύχη* and *Ὀκυρόη*, as well as a comparison of the two passages generally, makes one feel certain that the author of the hymn was borrowing from the *Theogony*. But that this humble nymph, lost among the crowd of her three thousand sisters (*Theog.* 364), grew into the tremendous power which at last scaled Olympus and ousted the gods from their thrones—this is more than we are required to believe, at least until some proof is forthcoming.¹ All that can really be gathered from Hesiod's mention of the nymph *Τύχη* is that the word *τύχη* was in the Greek language in his time, whereas we cannot be sure that it was so in Homer's. The names of all the other Oceanides being significant, we may justly infer that Tyche's was so also.

1. The poets.—The earliest surviving use of the word, otherwise than as a proper name, is in the 'Homeric' *Hymn to Athene* (xi. 5):

Χαῖρε, θεά· ὄδς δ' ἄμμι τύχην, εὐδαιμονίην τε.

Here *τύχη* is not a person, but a thing. The next is in a fragment of Archilochus (no. cxxxi. Gaisf.):

Πάντα τύχη καὶ μοῖρα, Περικλέες, ἀνδρὶ δίδωσιν.

The thing is here on its way to being a person. It gives and no longer is given. Half a century later,

¹ Pausanias (iv. 30. § 3) is responsible for the identification.

Alcman finds a very respectable pedigree for this new personage. According to him, Fortune—presumably the fortune of a State—is the sister of Loyalty and Persuasion, and her mother's name is Forethought (*Plut. de Fort. Rom.* 4, p. 318 A). Solon, whose archonship was in 594 B.C., reduces the person again to a thing. In the Introduction to his Laws he invokes Zeus to grant them success and honour (fr. xxiv. Gaisf.):

Πρῶτα μὲν εὐχόμεσθα Διὶ Κρονίδῃ βασιλῆϊ,
θεσμοῖς τοῖσδε τύχην ἀγαθὴν καὶ κῦδος ὀπάσσαι.

According to Theognis (c. 544 B.C.), it is not virtue or wealth which is the one thing needful for life, but simply luck (129 f.):

Μῆτ' ἀρετὴν εὐχου, Πολυπαῖδῃ, ἔφοχος εἶναι,
μῆτ' ἄφενος· μόνον δ' ἀνδρὶ γένοιτο τύχη.

In other words, 'Nothing succeeds like success.' Pindar (c. 490 B.C.) is full of references to *τύχη*, sometimes associating it with Divine agency, as *τύχα μὲν δαίμονος* (*Ol.* viii. 67), *τύχα θεῶν* (*Pyth.* viii. 53), *σὺν Χαρίτων τύχα* (*Nem.* iv. 7). He appears to have composed an Ode to Fortune, in which he declared her to be a Fate, and rather more powerful than her sisters (*Paus.* vii. 26. § 3). To this Ode is assigned the fragment which is preserved by Aristides (ii. 256),

ἐν ἔργμασι δὲ νικᾷ τύχα,
οὐ σθένος,

in which the sentiment is the same as in *Ec* 9¹¹—'The race is not to the swift, nor the battle to the strong.' *Ol.* xii., which is said to have been recited in the temple of Fortune at Himera in Sicily, consists mainly of an address to the goddess herself, though its professed object is to celebrate the achievements of a runner named Ergoteles. This ode may be considered as the first formal appearance of Fortune on the stage of Greek literature. Under the title of 'Saving Fortune' (*Σώτειρα Τύχα*) she is hailed as the daughter of Zeus Eleutherius, and is invoked to protect Himera, seeing that ships at sea, battles by land, the counsels of the Agora, and the hopes and fears of men are all swayed by her power. It was under the same aspect, as the protectress of cities, that Pindar bestowed upon Fortune the epithet of *φερέπολις* (*Paus.* iv. 30. § 4).

2. The tragedians.—In Æschylus, a junior contemporary of Pindar, *τύχη* is rather a form of Divine agency than itself a Divine agent. With this highly religious poet all is *αἶσα* or *νέμεσις* or *μοῖρα*, with Zeus as chief ruler. *Τύχη* hardly appears as a power of any consequence to mankind. In the *Choëphori* (783-5), 'Zeus, the father of the Olympian gods,' is invoked to bestow good luck (*ὄδς τύχας*; cf. *Sept.* 422). In *Sept.* (625) we have an express denial of the reality of chance:

θεοῦ δὲ δῶρόν ἐστιν εὐτυχεῖν βροτῶν.

If we find in *Agam.* 664

τύχη δὲ σωτῆρ ναυστολοῦσ' ἐφέζετο,

it is only as an alternative for

θεός τις, οὐκ ἄνθρωπος, οἶακος θιγῶν.

The only passage in which Fortune figures as an independent power is *Sept.* 426,

πύργοις δ' ἀπειλεῖ δαίην', ἃ μὴ κραινοὶ τύχη,

which may be let pass as only a way of speaking,¹ which does not represent the true mind of the poet. Neither does Fortune bulk largely in the mental field of Sophocles. We have mention of *τύχη σωτῆρ* (*Ed. Tyr.* 80), but it is only in a passing phrase. The unhappy Iocasta, who proclaims the reign of Fortune and denies Providence (*id.* 977 ff.)—

τί δ' ἂν φοβοῖτ' ἄνθρωπος ὧ τὰ τῆς τύχης
κρατεῖ, πρόνοια δ' ἐστὶν οὐδενὸς σαφῆς;
εἰκὴ κράτιστον ζῆν, ὅπως δύναιτό τις—

is soon convinced of her error; the noose seals her confession that Fate is more than Fortune, and that some intelligent, but inexorable, power rules

¹ For other allusions to *τύχη* by Æschylus, see *Agam.* 333; *Prom. Vinc.* 375; *Pers.* 602; *Supp.* 380, 523.

the lives of men. Œdipus, flushed with his unparalleled successes, proclaims himself the son of Fortune, the giver of good, and is therefore prepared to face with equanimity the possible revelation of a low origin (ib. 1080 f.):

ἐγὼ δ' ἔμαυτὸν παῖδα τῆς Τύχης νέμων
τῆς ἐδ' διδοῦσης οὐκ ἀτιμασθήσομαι.

But the actual revelation is such as to render the light unendurable to him, and it makes the chorus moralize on how man's prosperity 'never continueth in one stay.' This might be taken as illustrating the power of Fortune; yet it is not Fortune but Fate, since it has all been foretold. With Sophocles, as with Æschylus, the religious view prevails, and fortune is nothing but the mode of action of the gods (*Philoct.* 1316):

ἀνθρώποισι τὰς μὲν ἐκ θεῶν
τύχας δοθείσας ἐστ' ἀναγκαῖον φέρειν.¹

It is not till we come to Euripides, 'the rationalist,' that Fortune appears as a rival power to that of the gods. Euripides was a man of a religious cast of mind, but he was unable to accept the contradictions of the established theology, and he gave voice to the new science and the new philosophy of the Periclean age, as Tennyson did to that of the 19th century. The antithesis between Zeus and Fortune is strongly brought out in a passage of the *Hecuba* (488-91), where Talthybius, finding the ex-queen of Troy lying in the dust, exclaims:

ὦ Ζεῦ, τί λέξω; πότερά σ' ἀνθρώπους ὄραν,
ἢ δόξαν ἄλλως τήνδε κερτῆσθαι μάτην,
ψευδῆ, δοκοῦντας δαιμόνων εἶναι γένος,
τύχην δὲ πάντα τὰν βροτοῖς ἐπισκοπεῖν;

Talthybius does not decide the point, neither does the poet himself,—he was not an atheist, but a sceptic,—but his language is loaded with a triple tautology, as if to emphasize the apparent falseness of the notion that there is an over-ruling Divine will discernible in the course of human affairs. Chance, it is suggested, is the true bishop of the diocese of man.²

With the elder dramatists we found that there was a tendency to resolve chance into Divine agency; with Euripides the tendency is to resolve Divine agency into chance.³ If the gods do preside over the cauldron of human destiny, they throw in confusion, 'in order that in our ignorance we may worship them' (*Hec.* 960). In Euripides, too, we become aware of a change in the conception of *τύχη*. With Sophocles, as with his predecessors, *τύχη*, so far as it was a power at all, was a benign power, and meant definitely 'good fortune,' so that there was no need to add the epithet *ἀγαθή*. But with the lachrymose Euripides, *τύχη* became the personification of Ill Fortune. 'Alas!' says Agamemnon (*Hec.* 785), 'What woman was ever so unfortunate?' 'There is none,' replies Hecuba, 'unless you were to speak of Tyche herself.' Also, apart from personification, the word *τύχη* is used by Euripides in a bad sense (*Herac.* 714):

ἦν δ' οὖν, ὃ μὴ γένοιτο, χρήσονται τύχη;

With later writers this was usual only when the word was employed in the plural. *Τύχαι* properly means no more than 'turns of chance.' But man looks upon good fortune as his right, and so attends more to the changes for the worse.⁴ The successors of Euripides went further than he did himself. Chæremon, a tragic poet who flourished about 380 B.C., answers the question asked by Talthybius

¹ For passing mentions of *τύχη* by Sophocles, see *Aj.* 485, 803; *Œd. Tyr.* 773, 776; *Ant.* 996, 1158, 1182; *Trach.* 724; *Phil.* 546, 1096.

² Cf. a passage quoted by Stobæus, *Ecl.* i. 196:

Ἡ τὰ θνητῶν καὶ τὰ θεῶν πάντ' ἐπισκοποῦσα [μὲν]
καὶ νέμονσ' ἡμῶν ἐκάστω τὴν κατ' ἀξίαν τύχην
μερίδα.

By throwing in the words κατ' ἀξίαν, the writer, unless he is speaking ironically, makes chance into Providence.

³ See especially *Hel.* 711-715, 1137-1143; *Hec.* 956-60.

⁴ Other passages in Euripides bearing on fortune are *Alc.* 785; *Herac.* 866.

in a sense unfavourable to Zeus and his coadjutors (*Stob. Ecl.* i. 202):

Πάντων τύραννος ἡ τύχη ὅστι τῶν θεῶν,
τὰ δ' ἄλλ' ὀνόματα ταῦτα πρόσκειται μάτην,
μόνη διοικεῖν οὖν ἅπαντα βούλεται.

To the same effect speaks the comic poet Menander, who exhibited his first play in 321 B.C., the year which followed the death of Demosthenes and of Aristotle. The words of Menander seem to be intentionally directed against the philosophical doctrine of Providence (*Stob. Ecl.* i. 194):

Τύχη κυβερνᾷ πάντα, ταύτην καὶ φρένας
δεῖ καὶ πρόνοιαν τὴν θεὸν καλεῖν μόνην,
εἰ μὴ τις ἄλλως ὀνόμασιν χαιρεῖ κενοῖς.

The conviction that Chance is the real arbiter of the life of man reappears long afterwards in Lucian. In his Council of the Gods, Momus is made to lay a complaint before Zeus with regard to the way in which Heaven is becoming peopled by aliens, such, for instance, as Mithras the Mede. But the most absurd part of it all, adds Momus in conclusion, is that certain empty names of things which have no substantial existence, such as Virtue, Nature, Destiny (*Εἰμαρμένη*), and Chance, are being set up as deities. Though these are mere figments of philosophers, yet they succeed in withdrawing their worshippers from the gods; for men are convinced that, though they were to sacrifice a thousand hecatombs, yet Chance will perform the part of Fate (*τὰ μεμοιραμένα*) and give to each what was spun to him from the beginning.

3. The historians. — Among the historians, Herodotus is too much occupied with the religious view of life to leave any real efficacy to Fortune. He sees everywhere the hand of God in history. Sometimes this action is moral, as in the story of how Glaucus, who had entertained the thought of appropriating a deposit, had not a single descendant left to perpetuate his name in Sparta (vi. 86). Sometimes it is merely capricious. There is a jealous God, who will not allow even big beasts to 'fancy themselves' (*φαντάζεσθαι*), but has a thunderbolt ready to hurl at them. This God acts on the same principle as was enjoined by Thrasybulus upon Periander, and docks every head that overtops the rest (vii. 10). It has been well remarked by F. Allègre that Tyche is in part a protest against the malevolence of the Olympian deities. It was something to have a power which was purely non-moral, and which, if it rewarded without merit, was at least free from malignity when it caused disaster. With Herodotus, Fortune is a sign of the present favour of the Immortals,¹ but,

'When haughty power mounts high,
The watcher's axe is nigh.'

A rigorous consistency must not, indeed, be demanded from the chatty and charming Ionian. He gives us views of all sorts. The same Artabanus, who is made to dilate on the jealousy of God, also offers the following highly sensible remarks—that good counsel is the best thing; for, even if it be worsted by Fortune, its goodness is not impaired, whereas he who has counselled ill, even if Fortune attend upon him, has only made a find (*εὕρημα εὕρηκε*).

Although Thucydides came into the world only 13 years later than Herodotus,² yet in turning from the one to the other we are passing at one bound from the theological to the positive stage of thought. Thucydides makes Pericles say, or appear to say (for the passage admits of different interpretations), that there may be a real unintelligibility in the march of events, as there is in the processes of human thought,³ 'wherefore we are accustomed to ascribe to chance whatever takes

¹ i. 124: ὃ παῖ Καμβύσῳ, σὲ γὰρ θεοὶ ἐπορέωσι· οὐ γὰρ ἂν κοτε εἰς τοσοῦτον τύχης ἀπείκεν.

² Herodotus was born in 484 B.C.; Thucydides, in 471.

³ i. 140. § 3: ἐνδέχεται γὰρ τὰς ξυμφορὰς τῶν πραγμάτων οὐχ ἴσσαν ἀμαθῶς χωρῆσαι ἢ καὶ τὰς διανοίας τοῦ ἀνθρώπου.

place contrary to reason.' If anything can be shown to have a definite cause, then it does not come under the domain of chance. That name is reserved for those events for which we are unable to assign a cause. Chance constitutes the irrational, or at all events inscrutable, element in things, which is not under the control of human forethought. Τύχη is now no longer a person, but a statement of fact. There are certain events for which no cause can be assigned. These it is convenient to throw together under the head of τύχη. This meaning of the term was facilitated by the use of τυγχάνειν as a mere auxiliary verb—τυγχάνω περιπατῶν, 'I am walking,' ἐτύχχανον περιπατῶν, 'I was walking,' and so on. So generally τύχη meant what *was*, without question raised as to how it came to be. If one had insisted on raising this question and getting an answer from Thucydides, he might perhaps have referred one to Divine agency. At least he makes the Melians declare that they rested their trust not to be defeated τῇ μὲν τύχῃ ἐκ τοῦ θεοῦ (v. 104), seeing that their cause was just.

4. The orators.—In the orators we may expect to get nearer to the heart of the people than in a scientific thinker like Thucydides. For the orator, who has to play upon the feelings of the multitude, must share those feelings himself, or at least seem to do so. Let us take the greatest of them—Demosthenes. He is full of passages on the power of Fortune,¹ as well he might be, seeing that his own 'best-laid schemes' went 'aft agley.' It was the touch of truth in the reproach brought against him by his rival Æschines, that he was an unlucky statesman, which gave it its sting. Æschines (in *Ctes.* § 157, p. 76) warned the Athenians against the 'evil genius and ill fortune which ever dogged the footsteps of the man.' Demosthenes himself displayed a secret distrust in his own luck, when he got his friends to put their names to his decrees, instead of signing them with his own.² But in his public speeches he put a bold face on the matter. He had done all that in him lay; if fortune thwarted him, he was not to blame (*de Cor.* § 303). But it was absurd to attribute the disasters of the State to his personal fortune. Nor was the fortune of the State itself really bad. For the Athenian State had the advantage over other States of having played the nobler part, and yet being better off than they. But Athens had to take her share in the general blast of ill-fortune which was then blowing over mankind—with the exception, we must suppose, of Philip (*de Cor.* §§ 253, 254, p. 311). This curious conception of a hierarchy of 'fortunes'—that of individuals, of States, and of mankind in general—is in accordance with the genius of polytheism, and throws light on the manifold worship of Fortune public and private, which became more prevalent as time went on.

5. The philosophers.—Anaximenes (544 B.C.) made a very shrewd remark when he said: 'We are wont to apply the term "fortune" to the element in life which is incalculable to man. For, if we always went right in our judgments, the name of Fortune would never have been heard of' (*Stob. Ecl.* ii. 346). We get a very slighting estimate of the power of Fortune in what may perhaps be deemed an unexpected quarter. Democritus (430 B.C.) is quoted as saying (*Stob. Ecl.* ii. 344):

'Men have framed for themselves an image of Fortune by way

¹ *Olynth.* ii. § 22, p. 24: μεγάλη γὰρ ῥοπή, μάλλον δὲ τὸ ὅλον ἢ τύχη παρὰ πάντ' ἐστὶ τὰ τῶν ἀνθρώπων πράγματα; *de Pace*, § 11, p. 59: δι' εὐτυχίαν, ἢν συμπάσης ἐγὼ τῆς ἐν ἀνθρώποις οὐσης δεινότητος καὶ σοφίας ὄρω κρατοῦσαν.

² *Plut. Vit. Dem.* 21: τοῖς δὲ ψηφίσμασιν οὐχ ἑαυτὸν, ἀλλ' ἐν μέρει τῶν φίλων ἕκαστον ἐπέγραφεν, ἐξοικωσιζόμενος τὸν ἴδιον δαίμονα καὶ τὴν τύχην.

of apology for their own ill counsel. For Fortune does not oppose wisdom much, but the quick-witted and clear-sighted man guides most things in life aright.'

With regard to the power of Fortune, Epicurus speaks as contemptuously as his predecessor, in language which seems to be modelled on his.¹ In the fourth book of the *Laws*, Plato's Athenian stranger is on the point of saying that 'pretty nearly all human affairs are a matter of chance.' He corrects himself, however, and substitutes the formula that 'God, indeed, governs all things; but, under God, chance and opportunity (τύχη καὶ καιρός) are the pilots in all that relates to man,' this again being amended by the addition of 'art' to 'chance and opportunity,' as being more polite (ἡμερώτερον). But, when we reach the tenth book, which is Plato's great and final pronouncement on matters theological, we find a very different value assigned to art (τέχνη). He starts from the view held by some people that 'all things which come into being, or have come, or yet shall come,' are due to three causes, Nature, Chance, and Art—the more important, such as the four elements and the constitution of the universe, being ascribed to the first two, Nature and Chance, and the less important to the last, namely Art. He then goes on to show that the soul is the only thing that moves itself, and must therefore be the cause of all becoming. Now, soul is either good or evil, wise or devoid of wisdom. It is impiety to say that the orderly movements of the universe are caused by an evil and unwise soul; we are therefore compelled to conclude that they are produced by one or more souls possessed of perfect virtue (898 C). But, if soul be prior to body, then the things of the soul are prior to those of the body. And, as art is one of the things of the soul, we are thus brought to a Divine artificer more exact and painstaking than any human workman, and one therefore who will not neglect small matters any more than great. In this cosmos of the beneficent soul (896 E), what room is left for chance? Plainly there is none. Chance then—Plato does not say this, but we may say it for him—must lurk in the chaos which precedes the cosmos, where dwells the evil soul of disorder.

If we turn now to Aristotle, we shall find, as usual, the same thing said, only in less theological language. After giving us in the *Physics* (ii. 3) his famous fourfold division of causes, into Material, Formal, Efficient, and Final, he goes on to say that Chance also and Spontaneity (ii. 4: καὶ ἡ τύχη καὶ τὸ ἀπρόματον) are reckoned among causes. How then do they come in, and are they synonymous, or are they not? First, let it be observed that a thing is due to chance, not if it have not an efficient, but if it have not a final, cause—in other words, if it be not intended. A man who is not in the habit of going to market goes thither on a particular occasion, and meets another man who takes the opportunity of paying him a debt. This, we say, is due to chance. It is the kind of thing that might have been done on purpose, only in this case it was not. Each of the two persons has his own particular cause for going to market, and the payment of the debt results from the conjunction of the two, as a kind of by-product. Thus Chance (τύχη) is something within the sphere of mind or human agency which is not due to that agency. And, as Chance is to Man, so is Spontaneity to Nature. When some effect which might be produced by Nature is not produced by Nature, then we say that it took place spontaneously. It is not necessary here to discuss the question of Spontaneity. But, with regard to Chance, let it be observed that Aristotle finds the source of it in undesigned collocations.

¹ See *Stob.* ii. 354, which may be emended from *Cic. de Fin.* i. § 63.

LITERATURE.—Stobæus, *Eclog. Phys. et Eth.* lib. 1. cap. 6, *περί τύχης ἢ ταιριμάτων*; F. Allègre, *Étude sur la déesse grecque Tyche*, Paris, 1892—an admirable and exhaustive monograph; L. Preller, *Gr. Mythologie*, ed. Carl Robert, Leipzig, 1894, pp. 539-544; O. Gruppe, *Gr. Mythol. u. Religionsgesch.*, Munich, 1906, Index, s.v. 'Tyche.'

ST. GEORGE STOCK.

FORTUNE (Iranian).—The concept of fortune in the sense of chance or good luck finds little place in the Avesta and Pahlavi texts. A happy wife is termed 'fortunate' (*hubagha*) in *Vīsp.* ii. 7, but neither this nor the frequent word *ustā*, 'weal,' 'good fortune' (lit. 'according to wish'), can be regarded as referring to good luck in the common acceptance of the term (cf. the passages listed by Bartholomæ, *Altiran. Wörterb.*, Strassburg, 1904, col. 417 f.). Nevertheless, there are a few passages which seem relevant in this connexion. Success and fortune (*apemča bagemča*) are objects of reverential honour (*Yast* xv. 1), as is also the everlasting and boundless progress of events according to one's wish (*vīspāyūm . . . ustatātem akarānem*), which it is the torture of the wicked not to enjoy (*Vīsp.* xviii. 2). Supplication is offered to the Fravashis (*q.v.*) for all boons (*ayaptanām vīspanām* [*Yast* xiii. 135]), who grant them when prayed for (*ib.* 24), as do Ardvī Sūra Anāhita (*ib.* v. *passim*), Tištrya (*ib.* viii. 49), Drvāspa (*ib.* ix. *passim*), Mithra (*ib.* x. 33), Vayu (*ib.* xv. *passim*), Aši (*ib.* xvii. *passim*), and Xsathra Vairya (*Vend.* xx. 3). Boons are invoked upon Vištāspa by Zoroaster (*Yast* xxiv. 46), while Atar (the Fire) prays (*ib.* 38) on behalf of the same monarch: 'May the Apportioner and Distributor bring to thee a boon' (*upabarāt āyaptem baxtača nivaxtača*), the allusion probably being to Ahura Mazda. According to the 9th cent. *Sikand-Gūmānik Vijār*, iv. 8, 29 (tr. West, *SBE* xxiv. 128, 130), heaven (*spihār*) is the place of the Divinities (*baghān*), who are 'the distributors of happiness (*nēvakīh baxtārān*), from which they always justly bestow their distribution of every happiness.' In conformity with this, Haoma granted his four first worshippers the heroic sons Yima, Thraētaona, Urvāxsaya and Keresāspa, and Zarathuštra (*Yasna* ix. 4, 7, 10, 13); and the obtaining of boons is the direct reward for pious observance of religious duties (*Yast* xxiv. 25).

Among the people it would seem that fortune played a larger rôle than in the official religion, for *baxta*, 'fortune' (also 'fate'; see FATE [Iranian]), occurs as a component of a number of proper names (Justi, *Iran. Namenbuch*, Marburg, 1895, pp. 61 f., 487 f.):

Baxtāfrīt ('blessed by fortune'), *Baxtāvar* ('fortunate'), *Baxtiyār* ('possessing fortune'), *Baxtūšāh* ('fortunate king'), *Azādbaxt* ('possessed of the fortune of the free-born'), *Bidārbaxt* ('possessed of watchful fortune'), *Dārābaxt* ('having the fortune of Darius'), *Juvānbaxt* ('possessed of young [i.e. sturdy] fortune'), *Hūbaxt* ('having good fortune'), *Xurrāmbaxt* ('possessed of joyous fortune'), *Naubaxt* ('having fortune [ever] new'), *Nēkbaxt* ('possessed of fair fortune'), *Sādbaxt* ('to whom fortune is friendly'), *Siguftāhbaxt* ('he whose fortune has bloomed'), *Sulṭānbaxt* ('possessed of the fortune of a sultān'), *Vadbaxt* ('possessed of evil fortune'), and *Zādbaxt* ('fortunate through the birth [of a son]').

Yet it must be confessed that the concept neither of Fortune nor of Fate (*q.v.*) was encouraged by Zoroastrianism. In the ceaseless conflict of good with evil, which human and super-human beings alike must wage, there was little room for mere chance. Such fortune as the Iranian might crave—and all that he might have—was such as his own efforts could win; and the most besides that he might hope for were those boons which Ahura Mazda and his minor Divinities might vouchsafe their pious worshipper and fellow-combatant against Ahriman and his forces of evil.

Side by side with fortune went misfortune, not alone for the wicked who merited it, but even for the good. Why the wicked so often flourish in this world while the righteous suffer woe is answered

by ascription of both good and evil fortune to Fate by the *Dīnā-ī Māinōg-ī Xrašt* (li., tr. West, *SBE* xxiv. 93 f.). A more orthodox answer, and one more in accord with the Zoroastrian spirit, though not without a fatalistic touch, is given in the *Dātistān-ī Dīnik* (vi., tr. West, *SBE* xviii. 23-25), which first states that this state of affairs is more apparent than real, for

'not at every time and every place, and not to all the good, does evil happen more—for the spiritual welfare of the good is certainly more—but in the world it is very much more manifest' (§ 2).

The treatise then goes on to say that

'the labour and trouble of the good are much more in the world, and their reward and recompense are more certain in the spiritual existence; and the comfort and pleasure of the vile are more in the world, and their pain and punishment in the spiritual existence are more severe. And this, too, is the case, that the good, through fear of the pain and punishment of hell, should forsake the comfort and ease in the world, and should not think, speak, or do anything improper whatever. And through hope for the comfort and pleasure in heaven they should accept willingly, for the neck [i.e. as a yoke], much trouble and fear in the practice of virtue in thought, word, and deed. The vile, through provision with temporary enjoyment—even that enjoyment of improprieties for which eventually there is hell—then enjoy themselves therein temporarily, and lustfully on account of selfishness; those various actions also, through which there would be a way to heaven, they do not trouble themselves with. And in this way, in the world, the comfort and pleasure of the vile are more, and the anxiety, vexation, despondency, and distress of the good have become more; the reason is revealed by the stars.'

LOUIS H. GRAY.

FORTUNE (Jewish).—God's free interference in human affairs is one of the cardinal doctrines of the OT. To His causation as rewarding or punishing are ascribed all the happy and unhappy experiences in human life. There is therefore no Hebrew equivalent for Fortuna. Leah's exclamation, בּוֹר, Gn 30¹¹, rendered in LXX *ἐν τύχῃ*, should be translated 'by the help of Gad' (cf. בּוֹר, v. 13, and *HDB*, art. 'Gad'), a divinity of fortune supposed to have been worshipped in Laban's household (see FORTUNE [Biblical and Christian]). Post-exilic Judaism further developed the doctrine of Divine compensation. Ezekiel was the first to teach its application to individual no less than to national life. The fundamental doctrine of the Wisdom literature is that piety is remunerated in this life.

The gist of the book of Tobit is that all ends well, and better than before, because a righteous man is rewarded for his merit. The Mishna *Pe'a*, i. l., which is repeated in the daily Morning Prayer, sees in the observance of certain commandments a profitable investment, 'the interest of which a man enjoys in this world, while the capital remains intact in the world to come.' In *Ḳid.* 39b we read: 'Whoever keeps one commandment is rewarded (in this world), his days are prolonged, and he will inherit the earth.' Cf. *Pirke Ab.* iv. 11: 'Whoever keeps the Law in the midst of poverty shall eventually keep it in the midst of wealth.'

Likewise, a state of adversity is not a mere sport of fickle fortune, but an exercise of מִדַּת הַרִּיב, the attribute of Divine judgment. God deals with man in a judicial manner, מִדַּת הַרִּיב, 'measure for measure.' To every transgression of the law an appropriate penalty is attached: 'With what measure one measures it shall be measured unto him' (*Soṭa*, 8b). 'There is no death and no suffering without sin' (*Shab.* 55a). Frequently the correspondence between each manifestation of misfortune (so-called) and the particular sin which caused it is not evident; but it exists, and resignation is demanded of the sufferer. The Burial Service is called צְרוּק הַרִּיב, the acknowledgment of the justice of the Divine judgment.¹ Some instances of misfortune are viewed as evident manifestations of Divine retribution. Thus bereavement is the penalty for broken vows, for neglect of the study of the Law and of certain ceremonies; domestic strife, premature birth, and death of children in infancy, for enmity without cause. For with-

¹ This is an ancient forensic term 'to plead guilty' (*Ber.* 19a, *Ta'an.* 11a). The Mish. *Sanh.* vi. 6 directs that after an execution the relatives and friends of the criminal should call on the judges and witnesses and acknowledge the justice of the decree.

holding tithes and other priestly dues comes failure of crops. Violence is punished by swarms of locusts and famine; perversion of justice by wars and pestilence; false swearing, blasphemy, and Sabbath-breaking by visitation of wild beasts, depopulation, and devastation; incest, idolatry, and neglect of duly observing the Sabbatical and Jubile years by exile; fornication by wounds, bruises, and the bite of serpents, etc. Dropsy is a token of immorality, jaundice of hatred without cause, poverty of pride and overbearing, croup of slander (*Shab. 32b ff.*). Bloodshed was the cause of the destruction of the Temple and driving the Shekhina away (*ib.*). Jerusalem was destroyed for neglect of Sabbath observance and of daily recitation of the *Shema*, for impudence, for despising school-children, for levelling classes, for not reproving each other for sin, for slighting the learned (*Shab. 119b*).

The manifold experiences of life, however, did not square with this doctrine of judicial retribution; and a problem was created which already tried OT saints (*e.g.* Ps 73). In the age of Koheleth, 'because sentence against an evil work was not executed speedily' or the righteous rewarded, evil was on the increase (*Ec 8¹¹*). The author himself did not know what to make of life. The problem must have been more trying during the religious persecution under Antiochus. A modification of the OT doctrine of retribution became necessary. A man's worth was not to be estimated by his fortunes and misfortunes. The true compensation was in another world. This faith supported the martyrs under persecution. It did not, however, entirely solve the problem to the legalist.

R. Yannai said: 'It is not in our power to explain the prosperity of the wicked and the suffering of the pious' (*Pirke Ab. iv. 15*). When Moses was on Mount Sinai to receive the Law, God revealed to him the greatness and martyrdom of R. Akiba. 'What, said Moses, such knowledge of the Law and such a reward! Hush, God replied, I have thus decreed it' (*Menach. 29b*).

To account for the inequalities of life with regard to nations and individuals, the Rabbis devised a theory which is a combination of OT views and that which relegates retribution to another world, according to which the prosperity of the wicked is a reward in this world for some merit, the punishment being reserved for the next world; the suffering of the righteous is to be regarded either as chastisement for some imperfections, or as a trial of their faith and constancy, or even as an atonement for others. For references to the Rab. literature on the subject, see Weber's *Jüd. Theol.*², Leipzig, 1897, ch. xx.

The spread of astrology all over the Roman Empire, its universal acceptance as an exact science, and its hold on the popular mind affected also Jewish folklore and introduced into the Judaism of the Talmudic period an attraction for the pagan doctrine of fortune. The term used for it is מזל, *mazzal*, Aram. מזל, *mazzala*, standing also for constellations of the zodiac and for planet. Since there is no record in the post-exilic age of a relapse into star-worship, the re-introduction of the term into the Jewish vocabulary should be traced back not to Babylonianism, but to contact with the 'Chaldeans,' astrologers and charlatans of the early Roman Empire. *Mazzal*, then, is not a divinity like Fortuna, but is either a 'station of the planet' at the time of a nativity or of some other event, or it signifies, in the late Magian sense, a *fravashi* (*q.v.*), the genius, guardian angel, 'external soul' of an individual. Another term is גזל, *gad*. Sometimes both are used, *e.g.* גזל וקלל (bish *gadda utmia' mazzala*), 'thou of ill fortune and obscure planet' (*Koh. R. vii. 32*). But the use of the word was discouraged by the Rabbis because of its association with the god Gad of Is 65¹¹ (see RV).

VOL. VI.—7

Thus *Shab. 67b* forbids the repetition of the magic formula, גזל וקלל, *gad gaddi v'kinuk la* = 'grant me fortune, O my Fortune, and relax not.' A place Gaddia ('fortunes') was kakophonized into Gallia ('dunghills'). *Mazzal* remained a Jewish word, and *mazzal tob* ('good luck') is still used as a formula of congratulation at births, weddings, the blessing of the new moon, and other occasions.

Mankind, then, has a mysterious connexion with the planets (*Targ. Ec 7¹³*). 'All depends on that connexion (*Mazzal*)' (*ib. 9²*).

Life, children, sustenance depend not on a man's merits, but on his *Mazzal*' (*Mo'ed Kat. 28a*). Every individual has a *Mazzal*. 'In the case of a sudden fright, if one does not see the cause of it, his *Mazzal* sees it' (*Meg. 3a*). 'The *Mazzal* makes wise; the *Mazzal* makes rich' (*Shab. 156a*). 'Every plant has a *Mazzal* in heaven, which influences it and bids it grow' (*Gen. R. 10*). 'Even the copy of the Law in the Synagogue chest is subject to the influence of *Mazzal*' (*Zohar Naso, 134*). 'Animals, on the other hand, have no *Mazzal*' (*Shab. 53b*). 'The *Mazzal* sees neither what is before it, nor what is above it, but what is below it, like a man descending from a ladder with his face turned backwards' (*Num. R. 12*). 'The propitious hour recedes if pursued' (*Ber. 64a*). The *Mazzal* of two is stronger than that of one (*B. Meg. 105b*).

Celestial phenomena came to be regarded as harbingers of good or of evil.

Thus an eclipse of the sun forebodes evil to the Gentiles and of the moon to the Jews, because the former reckon time by the sun, the latter by the moon. If the eclipse is in the east or west, it concerns the inhabitants of the respective places; but, if in mid-heaven, the portent refers to the whole world. A red sun is an omen of war, and a grey one of famine. If the eclipse is at sunset, the forthcoming evil will be delayed; if at sunrise, it is near at hand (*Suk. 29a*).

Some days were considered more fortunate for transacting business than others (*Sanh. 65b*). The corn of the year before a Jubile was supposed to be of finer quality (*ib.*). There were lucky and unlucky months.

'If an Israelite has a lawsuit with a Gentile, let him withdraw in the month of Ab because his *Mazzal* is weak, but let him present himself in the month of Adar when his *Mazzal* is strong' (*Ta'an. 29a*). Merit is imputed on a meritorious day, and guilt on a guilty day (*ib. 28b*). It is unlucky to submit to the operation of bleeding on a Tuesday, because on that day Mars reigns in the heavens. Mondays and Thursdays, too, are dangerous, but may be risked by those who have ancestral merits to shelter them. Friday should also be an unlucky day, but, since the multitude are accustomed to that day, 'the Lord preserveth the simple' (*Ps 116⁶*). Wednesdays on the 4th, 14th, and 24th of the (lunar) month should be avoided. Likewise the new moon, the third of the month, and the eve of festivals are dangerous (*Shab. 129b*). The day of the new moon was regarded as unlucky for the transaction of business (*Sanh. 65; Sifra, 171*); so also Fridays. The *Shulch. Aruch Yore de'a, 179*, directs that one should not embark on a new venture on Mondays and Wednesdays. See also *Zohar* on Pin'ehas. Tuesday is a lucky day, because on the first Tuesday the words 'that it was good' (*Gn 1¹⁰*) were repeated (*Pesach. 2*). Virgins marry on (the eve of) Wednesdays, and widows on Thursdays (*Kelh. i. 1*). On the night of the Great Hosannah it is possible to ascertain whether one will survive the year by observing one's shadow on the wall. The shadow of the man destined to die will appear headless (current Jewish tradition). Nachmanides on Nu 14⁹ sees Scriptural allusion for this tradition, the words 'Their shadow is removed from over them' (see RVm) being equivalent to 'doomed.'

The gifts and denials of fortune were considered beyond control. The fortunate was one 'on whom the hour was smiling' (*Ber. 7a*). He could risk being in dangerous situations. 'Thou art in luck,' said Abaye to his colleague R. Papa, 'the Demon (Keteb Meriri, who was then raging) could do thee no harm' (*Pesach. 115b*). The following pretty story deserves mention:

R. Joseph Mokir Shabbi (=Sabbath-respecter) is foretold by a 'Chaldean' that he will eventually obtain the enormous property of his rich neighbour. The latter sells his property and purchases a pearl of great price, which he keeps fastened in his turban. In a shipwreck he loses his turban. It is swallowed by a fish. After some time, at a fish market R. Joseph happens to be the only purchaser of fish in honour of the Sabbath, and comes into possession of the identical fish and the precious pearl (*Shab. 119a*).

Similarly the unlucky man regarded himself as hopeless. A brother of Raba in the agony of his last moments objected to prayers on his behalf as useless 'because he was delivered to his *Mazzal*' (*Mo'ed K. 28a*).

A change of circumstance may effect a change of fortune. A common saying among the Jews is מ'שנה מקום מ'שנה מזל (מ'שנה מ'שנה מקום מ'שנה). In case of extreme illness the custom, based

on *R. Hash.* 17a, still prevails of changing the patient's name, generally into *Chaim*, signifying 'life,' or *Alter*, 'another.' In the formula said on the occasion (see p. 149 of the *Book of Life*, ed. B. H. Asher, London, 1863) occurs: 'And thus may his *Mazzal* be changed from evil to good,' etc. Many Rabbis asserted that Israel is not influenced by *Mazzal* (*Shab.* 156), but the belief in astrology was already common.

In the Middle Ages, Maimonides was perhaps the only one who wrote against a belief in fortune (*Yad Ab. Cochab.* xi. 8). On the other hand, that most talented Rabbi, Ibn Ezra, was the most superstitious. In the poem on his Evil Star he maintains that if he dealt in candles the sun would not set in his lifetime, and if in shrouds no one would die. Although this was written in jest, he lived up to the conviction of his ill fortune. He was himself the author of several works on Astrology.

LITERATURE.—See literature at the end of art. FATE (Jewish).

A. E. SUFFRIN.

FORTUNE (Roman).—It is not possible to follow out the history of the ideas which the Romans attached to this word with the same accuracy as in the case of Greece; for (1) the Romans have left us no literature earlier than the second half of the 3rd cent. B.C.; and (2) when Roman literature begins, it consists chiefly of translations or paraphrases from the Greek, and in it such Roman words as *fortuna* are apt to become modified in a Greek sense. We have no Italian Homer of whom we can say that the word for 'chance' is not to be found in him; we can only infer, and somewhat doubtfully, that, as the idea of a capricious force interfering in human affairs is a late growth in Hellas, so it may have been in Italy. Our treatment of the subject must begin with the *cult of Fortuna* at Rome and in Latium—about which we know something, though without any certainty of detail.

1. *Fortuna* is formed adjectivally from *fors*, as *Portunus* from *portus*, *Neptunus* from some word unknown to us; and *fors*, so far as we can guess from later literature, must have signified what we call luck, whether good or bad, *i.e.* the incalculable element in Nature and in human life. Not a capricious force, such as was expressed in later times by the word *temeritas* (Pacuvius *ap. Auct. ad. Herennium*, ii. 23), and in the literature of the Empire sometimes by *fortuna* (this is a semi-philosophical idea of which the early Romans could have known nothing), but the idea of luck or accident which is common to the minds and language of all peoples at all times without any reflexion or reasoning on the mysteries of human life. As *Portunus* was the spirit or deity presiding over doors and gates, so *Fortuna* must have been, for the early Latins, the deity presiding over the incalculable element in human life, not a mere personification of Chance itself. This distinction survived, more or less faintly, to a late period of Roman history. When Nonius, in the 3rd cent. A.D., wished to distinguish *fortuna* and *fors*, he wrote: 'Fortuna et fors hoc distant; fors est casus temporalis, fortuna dea est ipsa' (Nonius, v. 15). The examples which he quotes from Accius' *Tragedies* do not show the distinction clearly, and are doubtless affected by the Greek original; but from the 13th book of Lucilius' *Satires* he cites the line 'Aut forte omnino aut Fortuna vincere bello,' where it is plain that *Fortuna* is conceived as something beyond and above mere chance. So in the famous passage of Pacuvius already quoted (to which we shall return), the last five lines contrast *Fortuna* with *temeritas*, blind chance:

'Sunt etiam alii philosophi qui contra Fortunam negant ullam extare, temeritate enim autumant esse omnia: id magis verisimile esse usus reapse experiundo docet. velut Orestes modo fuit rex, factus mendicis modo naufragio: nempe ergo id fluctu, haut forte fortuna optigit.'

And the author who quotes the lines (Cornificius, as the Germans call him) adds: 'nam hic Pacuvius infirma ratione utitur, quom ait verius esse temeritate quam Fortuna res regi,' etc. *Fortuna* perhaps never wholly lost the meaning of a power presiding over luck, which might be propitiated by human beings, or assisted by them in her operations: thus Cæsar, after his defeat at Dyrrhachium, told his soldiers that 'fortunam esse industria sublevandam' (*de Bell. Civ.* iii. 73).

This point will be more fully illustrated below, so far as it appears in Roman literature. But it is also strongly suggested by the earliest worship of *Fortuna* in Latium. Experts are all agreed that at Rome *Fortuna* was not an indigenous deity; she did not belong to what has been called 'the religion of Numa,' *i.e.* the earliest form of the organized religion of the State as indicated in the religious calendar (see art. ROMAN RELIGION, Introd.); universal tradition ascribed her introduction to Servius Tullius, a king of foreign extraction, and the traditional representative of the plebeian element as distinguished from the old patrician *gentes* and their religious worships; and her earliest temples were outside the *pomerium*—a sure sign of extra-Roman origin (see Wissowa, *Rel. und Kultus der Römer*², p. 256). The most ancient seats of her worship in Latium were at Præneste and Antium; and here such facts as we know point clearly to a deity who has a controlling power over men's fortunes, rather than one who simply represents luck good or bad. In each of these sites there was an *oraculum Fortunae*; and oracles, however simple and primitive, are never associated with the idea of blind chance, but are the result of human experience, which marks special sites with special Divine inhabitants as suited to resolve the uncertainty which besets human life at every turn. That uncertain element the Latins expressed by the word *fors*; *Fortuna*, as has already been said, was the deity presiding over *fors*, and therefore capable of foretelling the future. This is the true meaning, then, of the Latin *Fortuna*; it is not till the time of Servius that we hear of a *Fors Fortuna*,—a combination quite in keeping with Roman religious usage, but probably indicating a degenerate offshoot from the original Latin stock.

That stock, if we examine it as it appears at Præneste, where we have some little knowledge of it, may have been touched by Greek influences at a very early period, but the Latin conception of *Fortuna* can hardly have been seriously affected. The cult-title of the goddess here was *Primigenia*, which must mean 'first-born'; and that she was or came to be regarded as the first-born daughter of Jupiter is made certain by an inscription of great antiquity, first published in 1882 (*CIL* xiv. 2863): 'Orceria Numeri nationu cratia Fortuna Divo filei primocenia donom dedi' (see Fowler, *Roman Festivals*, p. 223 ff.). Here a woman presents an offering to *Fortuna*, the first-born daughter of Jupiter, for help in childbirth (*nationu cratia*); she had no doubt consulted the oracle, which here, as elsewhere in Italy, foretold the future by means of lots (*sortes*) mixed together by a boy before he drew one. Now, it is true that this anthropomorphic conception of the deity as daughter of Jupiter is foreign to old Italian ideas, and, as Præneste was undoubtedly exposed to the invasion of foreign cults at a very early period, it is highly probable that *Fortuna* had here taken on some of the characteristics of the Greek *Tyche* or *Nemesis*; but this could not well have been the case if the nature of the original Latin deity had not been of such a kind as to suggest or allow a connexion with Jupiter. But Jupiter is of all Italian deities the one who can least be associated with anything in the nature of blind chance; and we

are justified in conjecturing that this Fortuna was a Power believed to govern the destinies of women in childbirth, perhaps also of the children to be born. Fortuna was at all times more especially a woman's deity, as her many cult-titles clearly show; and adjoining her great temple at Præneste, as Cicero tells us (*de Div.* ii. 85), was another also dedicated to her, which was especially frequented by matrons; here there was a statue of her with two children in her lap, popularly (but no doubt wrongly) believed to be Jupiter and Juno (see Wissowa, *op. cit.* p. 259; Fowler, *op. cit.* p. 224 ff.).

So far, then, as we have any evidence on the question, it would seem that the name Fortuna did not suggest to the primitive Latin any idea of blind chance as a ruling factor in the world. Like all Latin *numina*, she was a power to whom, among the changes and chances of this mortal life, appeal might be made for help, especially by women. Not, of course, every change or chance; there never was, as Wissowa says (p. 261), at any rate during the Republican period, a Fortuna who was a general deity of luck; but in course of time, specialized and localized under various cult-titles, she came to express the hopes of Roman men and women in relation to particular activities or critical moments. It is probable that the cult of Fors Fortuna, already mentioned, was connected with the work of harvest; the dedication-day of the temple, which was beyond the Tiber, was 24th June, when that work would be largely completed; and we have the evidence of Columella (x. 316) that after a successful harvest the praises of this deity were sung. The other temple attributed to Servius, in the Forum Boarium, was certainly that of a woman's deity, who seems to have been identical with Mater Matuta, and also with the Pudicitia of Livy, x. 23 (Wissowa, 257). *Fortuna muliebris*, connected traditionally with the story of Coriolanus and the persuasive power of Roman matrons, might be worshipped only by women once married (Dion. Hal. viii. 56), and may therefore have been the spirit believed to guarantee good luck in legitimate wedlock. *Fortuna virilis* was also a woman's deity, more especially of the lower orders, and was supposed to bring good luck in connubial relations (Fowler, *op. cit.* p. 68). At the end of the Hannibalic war, the great deity of Præneste was transplanted to Rome, probably after successful recourse to her oracle, which so far the Roman State had declined to use; but transplanted cults seldom retain exactly their original characters, and here we find the beginning of the *Fortuna publica populi Romani*, of which we hear so much in later times. Fortuna tends in the later Republic to become a kind of good genius of particular acts and times: *Fortuna hujusce diei* is the unknown *numen* in whose charge are the events of a particular day; *Fortuna equestris* is the good luck of the Roman cavalry, and so on. The idea became popular; innumerable Fortunæ came into existence (see a list in Plutarch, *de Fortuna Romanorum*, 10); and, as the Greek conception of *τύχη* became more familiar to the educated Roman mind, Fortuna lost in purity and dignity what she gained in popular favour.

There is thus in the early history of the worship of Fortuna nothing to suggest that the virile and persistent Roman ever believed himself or his State to be at the mercy of chance. Such an idea would, indeed, have been utterly inconsistent both with his character and with his conception of his relation to the gods, who in his view, so far from being capricious, were always open to supplication, and practically bound to yield to it if approached in precisely the right way. The only right way was known to the religious authorities of the

State, and in placing himself entirely in their hands the Roman believed himself to be perfectly safe in all matters which lay outside the sphere of his own will and his own activity. But assuredly he never minimized the importance of that will and activity—*virtus*, as he called it. The *fortuna Romanorum* is a late idea, not to be traced further back than Polybius, and in him, as we shall see, by no means definitely conceived; it was by *virtus* and *pietas*, strenuous endeavour and a sense of duty, that the Romans of later days believed their forefathers to have conquered the world.

2. In the scanty remains of the earliest Roman literature, offspring though it was of a sceptical Greek age, we find nothing to suggest that the Tyche of Euripides and his successors had gained a footing in Italy. *Fortuna*, it is true, as well as *fors*, has come to mean the incalculable in human affairs, and in this sense was used throughout all later Roman literature; but we have distinct traces of the true Roman feeling that 'fortunam esse industria sublevandam.' One of the *sententiae* of Appius Claudius Cæcus (c. 300 B.C.) is the famous saying, 'Est unusquisque faber ipse suae fortunae' (here *fortuna* has partly the sense, which never left it, of prosperous condition, wealth); and in the *Annals* of Ennius (i. 172 [Baehrens]) we find the perennial proverb, 'fortibus est fortuna viris data.' So again, old Cato, in his *Origines* (quoted by Gellius, iii. 7), wrote that the gods give a soldier 'fortunam ex virtute.' Such sayings fairly neutralize commonplaces like—

' Multa dies in bello conficit unus
Et rursus multae fortunae forte recumbunt:
Haudquaquam quemquam semper fortuna secuta est'
(Ennius, *Ann.* i. 195).

In Plautus and Terence the use of *fortuna* and its compounds in the ordinary sense of luck or chance is constant, but not even the influence of the Greek original ever suggests the elimination of human endeavour, unless where, as in *Captivi*, II. ii. 54, or *Pseudolus*, II. iii. 14, the chances of war as bringing captivity and slavery are reflected from the unhealthy conditions of Greek life in the post-Alexandrian period. In Cato's book *de Agricultura*, the only complete prose work we possess of the period following the Hannibalic war, *fortuna* is not once alluded to. Disintegrating as the consequences of that war were to the old Roman character, they could not all at once obliterate the sense of the need of strenuous human endeavour, and they may have added to it the first intuition of the idea of the destiny of Rome, her mission to rule the world, which remains immortalized in the *Aeneid*. In spite of an attempt to introduce Epicureanism early in the century, the better minds at Rome kept clear of any degrading doctrine of chance, with its corollaries of individual selfishness and *laissez faire*.

3. This better tendency was upheld and confirmed by the presence and influence at Rome of two Greeks of great ability, personal friends of Scipio the younger, sympathetic admirers of the Roman spirit—*Panætius* the Stoic philosopher, and *Polybius* the philosophic historian. It is hardly possible to exaggerate the importance of these two men, and especially of Panætius, as guides to the Roman mind in beginning to reason on the facts of life; and their opinions of the power of Fortune must here be briefly explained. Greeks as they were, they form an integral part of the history of Roman thought.

Both of these men belonged to the Stoic school, but their Stoic doctrines were curiously tempered so as to harmonize with the Roman character, and they were no doubt directly influenced by their knowledge of that character and of the extra-

ordinary progress of the Roman State in the last two centuries. In each we find the freedom of man's will fully acknowledged, and his dependence on his own active endeavour emphasized. Cicero, in his *de Officiis* (ii. 6 ff.), has reproduced the view of Panætius on this point. The passage is an emphatic assertion of the power of man to work out his own fortune by his own reason and will. Not that chance is wholly excluded; 'magnam vim esse in fortuna in utramque partem, vel secundas ad res, vel adversas, quis ignorat?' (ii. 6. 19). Accidents will happen which could by no human means have been avoided; but these are comparatively rare, and by far the greater part of the good or bad fortune that may happen to a man, in spite of the element of chance that is always present, is mainly dependent on 'hominum opes et studia.' So far from sitting down passively to take what fortune brings him, the duty of man is here declared to be the free use of his reason and will in modifying for his own advantage and that of his fellow-men the conditions under which he lives (see Schmekel, *Phil. der mittl. Stoa*, p. 194). It was in accordance with this common-sense view of life that Panætius rejected all divination, thus breaking with the older Stoic view, and also with the traditional Roman practice—a fact which was of great importance for the Romans of the last cent. B.C. The more the philosopher exalts the position of man in Nature, the less need will he ascribe to him of such methods for securing himself in the future.

Polybius was not a professed philosopher, but his mind was a philosophic one, and in his treatment of history it is extremely interesting to note his view of Fortune. He works out his own ideas of historical causation independently, and from the practical standpoint of a statesman and a historian, and we cannot expect him to be always precise or consistent. But it is quite clear that he uses the word *τύχη* mainly in two senses: (1) *in modum vulgi*, where he is ignorant of the cause of a phenomenon (e.g. ii. 70. 2, ii. 38. 5, viii. 22. 10, xv. 6. 8, and many other passages); when he knows the cause he never uses the word, and, as he is always seeking out the facts of causation, his attitude is strictly scientific. We may be sure that he did not really believe in capricious Divine interference, in Nemesis, or in blind chance. (2) *τύχη* expresses an agent or power working to a definite end, as in i. 4, of the force which has brought about the growth of Roman dominion. Here he certainly does not mean chance;¹ no caprice is suggested in the work of this force; it comes near the *φύσις* of bk. vi. (iv. 11. 9. x. 57. 1), which he invokes, when in a more strictly scientific mood, to explain the regular and natural succession of political constitutions. And this 'Nature' of bk. vi. is not far removed from the Stoic idea of Fate, Destiny (*ἡ εἰμαρμένη*); but as used by a historian it must not be pressed to a philosophical dogma. He uses it much as the modern historian is apt to use the word 'evolution,' to express the natural course of events, without perhaps meaning anything very definite by it. One thing is certain, that both the *τύχη* and the *φύσις* of Polybius can include human agency; the human will is free for him as for Panætius, and, though man is subject to Nature, Destiny, or whatever it be called, yet he is a part of this himself, and can use his reason to shape his course. A good example is in bk. x. 5, §§ 7 and 9, where historians are blamed for attributing the successes of the great Scipio to Fortune, instead of to his own character and genius; cf. i. 35, iii. 31 *ad fin.*, and a very interesting passage in xxxvii. 9. (See the writer's article on this subject in *CLR*

¹ For the Stoic *τύχη* (*αἰτία ἀθλος ἀνθρωπίνῃ λογισμῷ*) see Reid on Cic. *Acad.* i. 7. 29.

xvii. [1903] 445 ff., from which a few sentences have here been quoted.)

Assuredly there was nothing in the writings of these two remarkable men to undermine the Roman sense of *virtus*, or to lead to that popular idea of the caprice of Fortune which we shall meet with soon, and which was due far more to the strange incalculable events of the last cent. B.C., and to the growing feeling of the uncertainty of human life and the hopelessness of the social and political situation, than to any serious reflexion or philosophical reasoning. The general tendency of the best Roman minds in that century was towards Stoicism of the more common-sense type which Panætius had introduced, which admitted no capricious cosmic agency, and exalted the power of human endeavour; and for some time at least the Scipionic circle, as it has been called—the group of disciples of Panætius and Polybius—continued to combine the reasoning of their teachers with strenuous human action. To this school, in some sense at least, belonged the two Gracchi, and also the satirist Lucilius, in whose fragments, more than 900 in number, the word *fortuna* occurs only twice. One of these passages (333 [Baehrens]) has been alluded to above:

'Aut forte omnino aut Fortuna vincere bello;
Si forte ac temere omnino, quid rursum ad honorem?'

Here *fors* seems to be mere chance, and the word *temere* reminds us of the passage of Pacuvius quoted already; *fortuna* seems to be rather a guiding force, like the *τύχη* of Polybius in i. 4; and the general meaning suggested is that *fortuna* and human endeavour aid each other in the field of battle.

4. We may now pass to the two great intellects of the last age of the Republic, Cicero and Cæsar; of the great poet who was their contemporary a brief word will be said directly.

Taking Cicero first—it is by no means easy to gain a clear impression of his idea of Fortuna; he wrote in many different moods, reflected or translated the views of many schools of philosophy, and was not himself a man of strong conviction on religious or philosophical questions, following the principles of the New Academy, which denied that absolute truth was attainable, and sought for probability in the opinions of various schools. In his later years Cicero was drawn strongly towards Stoicism, and in the passage from his *de Officiis* already quoted (written in 44 B.C.) he clearly approves the views of Panætius that Fortuna is a power working for good and evil on mankind, but that man himself can counteract it by his own will in most matters of real importance. He was, in fact, the direct intellectual descendant of the Scipionic circle, and inherited their belief in Panætius and the Roman type of Stoicism which he introduced. But there can hardly be a doubt that Cicero, under the influence of his age, and the chaotic uncertainty of its social and political life, felt the reality of Fortuna, good and bad, more keenly than would have been approved by Panætius. It is in his writings that we first find (with the exception of the passage in Pacuvius) Fortuna spoken of in terms, not of the old Latin goddess, but of the later Greek Tyche; she is *volubilis*, *inconstans*, *caeca*, etc., and sometimes appears with the external attributes of the Greek deity. All this is, indeed, little more than literary language, and expresses no very definite conviction; but it is of value for our present purpose, because it reflects beyond doubt the popular ideas of the time. But for Cicero's more serious view of the matter we may turn with advantage to his work *de Divinatione*, composed almost at the end of a life chequered by many turns of Fortune's wheel (44 B.C.). In the first book of this treatise he puts into

the mouth of his brother Quintus the Stoic view of divination as represented in his lifetime by Posidonius of Rhodes, who differed from his master Panætius in maintaining that human skill and observation can to some extent unravel the mystery of the future, of fate, the 'ex omni aeternitate fluens veritas sempiterna' of the Stoics. In the second book Cicero argues against this view (though himself an augur), and here we seem to find his own personal view of Fortuna. He declares that divination, whether of predetermined fate or of matters accidental, is altogether impossible.

'Quomodo ergo id quod temere fit caeco casu et volubilitate fortunae, praesentiri et praedici potest?' (§ 15 *ad fin.*). 'Nihil enim est tam contrarium rationi et constantiae quam fortuna; ut mihi ne in deum quidem cadere videatur, ut sciat quid casu et fortuito futurum sit. Si enim scit, certe illud eveniet. Sin certe eveniet, nulla fortuna est. Est autem fortuna. Rerum igitur fortuitarum nulla praesensio est' (§ 18).

No doubt this is the view of Carneades and the Academic school generally; Cicero tells us as much (§ 9); but a perusal of the whole book will produce a strong impression that he adopts it *in toto* and with conviction, and in the incomplete *de Fato*, written shortly afterwards, we find much the same view, here also in the course of a criticism of Posidonius. Fate, he says, is the product of the brain of philosophers; common sense and experience teach us that Nature exists and Chance exists, but not Fate. Where is the need to foist in fate (*inculcare fatum*), 'cum sine fato ratio omnium rerum ad naturam fortunamque referatur?' (§ 6). Such arguments are scarcely convincing, and we feel that Cicero is not very clear as to the meaning he attaches to the words *fatum*, *natura*, *fortuna*; but there seems no doubt that he genuinely disliked the idea of a chain of causation—*ἡ εἰμαρμένη*, as the Stoics called it; he has too lively a consciousness of his own free will, and of the sport of chance in the history of his own time, to accept such a theory. His intense humanity forbade it; he lived too much in the world, enjoyed too thoroughly the exercise of his own individuality. Lastly, the reader may do well to turn to an interesting passage in the *de Natura Deorum* (iii. 88), in which, after insisting that the gods do not give us virtue, and that we do not thank them for it, but for riches, *externae commoditates*, and such like, he sums up in these words: 'judicium hoc omnium mortalium est, fortunam a deo petendam, a se ipso sumendam esse sapientiam.' Here, as in the passage from this book quoted above, Cicero is plainly uttering the opinion that suits his own mind best.

Of *Cæsar* it has often been said, not only that he believed in Fortuna, but that he believed in her as his own peculiar patroness, as Sulla had done before him. But an examination of his extant writings by no means confirms this opinion. As has been shown in the *CLR* (xvii. 153), the passages usually relied on, when read carefully by the light of their context, fail to prove that *Cæsar* had any particular belief in his own good luck (*e.g.*, the letter enclosed in *Cic. ad Att.* x. 8 B., *de Bell. Gall.* iv. 26, vi. 35, *de Bell. Civ.* iii. 10), and tend to show that, as regards Fortuna in general, he simply believed in good and bad luck, as we all do, particularly in military operations. In describing his defeat at Dyrrhachium he begins by saying that 'fortuna, quae plurimum potest cum in reliquis rebus tum praecipue in bello, parvis momentis magnas rerum commutationes efficit; ut tum accidit'; but after the battle, in addressing his soldiers, he tells them that 'fortunam esse industria sublevandam.' As far as we can judge from his own writings, he seems as rational as Lucretius on this point; and, if it be true that he held Epicurean doctrines (which is, however, by no means certain), it may be that he looked on

Fortuna much as the poet did—as the mechanical force of Nature acting in ways which we cannot foresee or understand. Lucretius wrote (v. 77):

'Praeterea solis cursus lunaeque meatus
Expeditam qua vi flectat natura gubernans,'

and what his *natura gubernans* is appears in line 107, 'quod procul a nobis flectat Fortuna gubernans.' On these lines Munro notes that the Epicurean Nature is at one and the same time blind chance and inexorable necessity, and compares vi. 31, 'seu casu seu vi, quod sic Natura parasset.'

5. But, if *Cæsar* himself steers clear of any degrading view of Fortuna, and never in reality personifies her, this is not so with his younger contemporaries. The experience of the last century of the Republic might well create a belief in the blind or wilful dominion of chance in human affairs; society and politics seemed to be governed by no benevolent destiny, or rational law of development. Cicero himself had spoken of Fortuna in this sense when pleading for *Marcellus* before *Cæsar* in 46 B.C. (*pro Marcello*, § 7). *Sallust* in more than one passage writes of her in a way which we have never as yet met with: 'Sed profecto Fortuna in omni re dominatur; ea res cunctas, ex libidine magis quam ex vero, celebrat obscuratque' (*Catil.* 8); and in the tenth chapter of the same work, while he looks on the history of Roman conquest down to the destruction of Carthage as the result of *labor* and *justitia*, he declares that after that terrible event 'saevire Fortuna ac miscere omnia coepit.' The author of the *Cæsarean* book on the Alexandrian war (possibly *Asinius Pollio*) speaks of Fortuna (ch. 25) in terms of the Greek Nemesis, as reserving those on whom she has heaped benefits for a harder fate. And *Cornelius Nepos* (*Dion.* 6) in the same way says that the fickleness of Fortuna began to sink the hero whom she had just before exalted.

It is true, indeed, that neither of the two finest spirits of the Augustan age ever uses the word in this way. They were both natives of Cisalpine Gaul, then the best strain in the population of Italy. Both were of the same type of character—mild, serious, intensely human, right-minded—with a profound conviction of the duty and destiny of the Roman State. For *Virgil*, when Rome or *Aeneas* or even *Evander* his predecessor and ally is in question, Fortuna is the same thing as Fate, or Providence, or the will of Jupiter representing the Divine government of the world, or the Destiny of the Stoics. 'She is not so much a deity, as Reason and Providence conceived and expressed as the benevolent will of a deity' (*Heinze, Virgils epische Technik*, p. 287).

'Me pulsum patria pelagique extrema sequentem
Fortuna omnipotens et ineluctabile Fatum
His posuere locis.'

So says *Evander* to *Aeneas* (*Æn.* viii. 333 ff.). To follow her guidance was the duty of *Aeneas* and his Trojans, and therefore also of the Romans. At the beginning of *Æn.* v. she turns the course of the fleet towards Sicily by threatening a storm: 'Superat quoniam Fortuna, sequamur,' says *Palinurus* to *Aeneas*, 'Quoque vocat, vertamus iter' (22 f.). In v. 709 ff., after the burning of the ships, when *Aeneas* is minded to stay in Sicily, crushed by the blow, old *Nautes* says:

'Nate dea, quo Fata trahunt retrahuntque sequamur:
Quicquid erit, superanda omnis Fortuna ferendo est.'

Here, if the whole passage be read, it becomes clear that *fortuna* is the will of the gods, against which a man can fight if he will, but submission to which is really victory. So in x. 49 *Venus* urges *Jupiter* to let her save the boy *Ascanius*, *i.e.* snatch him from the fate which she imagines to be decreed for him; but

'Aeneas sane ignotis jactetur in undis
Et quacumque viam dederit Fortuna sequatur.'

Once more, a curious passage in x. 107 ff. must be here noticed, because it shows that Virgil could conceive Destiny as working independently of Jupiter, and in contrary directions for different peoples: in response to the pleading of Venus on one side and Juno on the other, Jupiter declines to interfere:

'Sua cuique exorsa laborem
Fortunamque ferent. Rex Jupiter omnibus idem;
Fata viam inveniunt.'

Thus Fortune is in Virgil, at any rate in the *Aeneid*, a moral conception, to which the leader of men, and indeed all men and States, have to respond by obedience and faith, inspired by that sense of duty to god and man which the Romans called *pietas*. When the poet is not speaking of *pious* Aeneas, or of any one who has this sense of duty, he may use *fortuna* in the ordinary sense of chance. In the speech of Turnus (*Æn.* xi. 378 ff.), which is introduced by the words 'Talibus exarsit verbis violentia Turni,' and is therefore the speech of one uncontrolled by a sense of duty, we find quite a different Fortune:

'Multa dies varique labor mutabilis aevi
Retulit in melius, multos alterna revisens
Lusit, et in solido rursus Fortuna locavit.'

For Fortune in *Livy* the reader must be referred to the valuable summary in the introduction to Weissenborn's edition, p. xix ff.; the general results of an independent inquiry can alone be stated here. Whoever reads *Livy's* noble Preface to his work cannot fail to be struck by the absence of any attribution to Fortune or Fate of the growth of Roman power, or the decline of the virtues which brought it about: *Livy* is here clearly writing from conviction, arrived at independently of the fashionable views of his day. He attributes all to man himself—to the *virtus* and *pietas* of the old Romans, to the decline of morality and manliness in later periods of their history. It is true that in the course of his vast work he speaks of the *Fortuna Populi Romani* (an idea now coming into vogue), e.g. in vi. 30, i. 46, ii. 40, vii. 34. 6. But in almost all these and other passages this Fortune does but come to the aid of energetic human endeavour, or human endeavour finishes the work of Fortune. 'Quicquid superfuit Fortunae P. R., id militum etiam sine rectore stabilis virtus tutata est' (vi. 30). It is true, also, that he occasionally uses the word *fortuna* in the ordinary sense of chance, and once or twice he personifies her in the Greek fashion as capricious, e.g. v. 37. 1 ('adeo occaecat animos fortuna, ubi vim suam ingruentem refringi non vult'); but this seems to be a casual and momentary reflexion—the exception to the general rule. 'Fortes fortuna juvat' (viii. 29) expresses far better his personal conviction.

6. After the Augustan age, and for the first two centuries of the Empire, the history of Fortune becomes difficult to follow; and it may be convenient to treat of it under four different heads or aspects of the idea, viz. (1) the *Fortuna Populi Romani*, which we have just found expressed in different ways in Virgil and *Livy*, and which is also to be found in Propertius; (2) Fortune as Fate, or closely related to it, affecting human life in general; (3) Fortune in the vulgar sense of Chance, an unaccountable factor in human life; (4) Fortune as a deity, especially connected with the worship of the Emperors, but showing herself in other ways also. It may be added here that the word is often used in this period in the sense of high position and dignity, as over and over again in Pliny's panegyric on Trajan, and elsewhere in literature; but this is outside the general scope of this article.

(1) *Fortuna Populi Romani* has what we may call a downward tendency, in this period, to become a goddess; so far it is not easy to prove that

the idea of the destiny of Rome had been so regarded, for the *Fortuna Publica Pop. Rom. Quiritium in colle Quirinali* of the calendar of Cære (*Eph. Epigr.* iii. 7) cannot be dated earlier than 194 B.C. That idea may possibly have begun with Ennius, though it is not found in any of his surviving fragments; it is obvious in Polybius from the Greek *quasi*-philosophical point of view, as has been shown; it is expressed, without distinct association with a divinity, in Virgil and *Livy*. The nearest approach to this Fortune as a goddess in the Republican period is found in the coins of the gens *Sicinia* and the gens *Arria*, which bear a female head (see Roscher, *Lex. der Myth.* i. 1515) with the inscription 'Fort. P.R.,' but without any other sign of a cult. But, when the State came to be represented by the individual Cæsar, and its greatness associated with his welfare, the growing tendency to pray to Fortune for his safety brought the deity, in various forms and cults, very close to the idea. This is well shown in the famous ode of Horace (i. 35), where the Fortune of Antium,¹ pictured in a curious and puzzling manner, is entreated to preserve Augustus in his proposed expedition to Britain (cf. also Augustus in *Mon. Ancyrae* ii. 29; and see below, p. 103). But the older abstract form of *F. Populi Romani* survives alongside of this tendency; e.g. in Vell. Paterc. ii. 86 and 103; Tac. *Hist.* iii. 46, 'adfuit ut sæpe alias Fortuna Pop. Rom.,' i.e. by bringing Mucianus and the Syrian legions to the Danube. In this context the short work of Plutarch, or of Plutarch's school, must be mentioned, *de Fortuna Romanorum*. Here, however, Fortune is rather Chance (*τὸ αἰρόμαρον*) than the grander conception of *Livy* or Virgil; the question raised is whether the greatness of Rome was due more to Fortune or to Virtus, and the author concludes that it is due to both, but chiefly to Fortune. 'She came to Rome to stay, and laid down her wings.' There is not much to our purpose in this work, but it serves to show how much people were thinking about Fortune at the time, and chiefly in relation to Roman history.

(2) *Fortuna as Fate*, or a guiding power of some more or less definite kind. It was said at the beginning of this article that Fortune, as distinguished from *Fors*, never wholly lost the meaning of a superior and intelligent power. In the Empire, among educated people at least, this still holds good, in spite of the fact that Fortune becomes more and more conceived on the one hand as a deity, on the other as luck and ill-luck in human life, which is the sport of chance. Thus Seneca (*de Beneficiis*, iv. 8. 3) writes: 'nunc naturam voca fatum fortunam, omnia ejusdem dei nomina sunt varie utentis potentia sua'—an interesting passage, because the universal providence of Stoicism is here a nameless deity, neither Jupiter nor another, the God whom Seneca urges his disciples to love as well as worship, in language hardly distinguishable from that of St. Paul (see Zeller, *Stoics, Epicureans, and Sceptics*, p. 322 ff.; Boissier, *Religion rom.* ii. 71 ff.). But, as a rule, Seneca uses the word in the current sense, as a power not to be worshipped or submitted to, but to be overcome by the human will and wisdom; e.g. in *de Constantia Sapientis*, 15. 3 (and, indeed, *passim*), 'vincit nos fortuna nisi tota vincitur'; *Epist.* 98, 'valentior omni fortuna animus est.' Evidently there is no clear distinction between Fortune and Fate, yet the former is not so much pure luck or chance as something whose action we are not able to understand (*Aug. de Civ. Dei*, v. 9), or the executor of the decrees of Providence (*Macrob. Sat.* v. 16. 8).

¹ There were two Fortunes at Antium, but Horace speaks of one only, which may perhaps indicate that he did not know much about the cult.

This old Stoic notion we have already noticed as illustrated in Polybius. The great historian of the Empire is occasionally puzzled by conflicting ideas of Fortune and Fate, though, as a rule, he uses the word in the vulgar sense, e.g. *Hist.* iv. 47, 'magna documenta instabilis fortunae summa et ima miscentis.' In a famous passage in the *Annals* (vi. 22, where see Furneaux's notes, and some excellent remarks in the Introduction to his first vol. p. 21) Tacitus tells us that he cannot make up his mind whether human affairs 'fatone et necessitate immutabili an forte volvantur' (cf. iv. 20), where *fors* is identical with *fortuna* as popularly used. It would seem that, as Furneaux says (p. 22), Tacitus was inclined to accept the idea that our destiny is fixed from the moment of our birth, and could be foretold from our horoscope if we were sure of our interpreter; it is only now and then that he has doubts, as, when writing (*Ann.* iv. 20) of the excellent Manius Lepidus who did good work in enviable quiet under Tiberius, he doubtfully raises the question whether favour or dislike of princes is the work of Fate and our 'sors nascendi,' 'an sit aliquid in nostris consiliis,' etc. This is no real philosophic reflexion, but merely the passing doubt of an acute mind which has watched the tyranny of Domitian. Is the human will free to shape its course bravely and with happy result?

(3) *Fortuna in the vulgar sense of pure Chance.*—There is no need to illustrate this further than by quoting the famous passage of the elder Pliny (*HN* ii. 22), in which the universality of the ascription to Fortuna of all good and evil in human life is most emphatically stated.

'Toto quippe mundo et omnibus locis omnibusque horis omnium vocibus Fortuna sola invocatur et nominatur, una accusatur, una agitur rea, una cogitatur, sola laudatur, sola arguitur. Et cum conviciis collitur, volubilis, et plerisque vero et caeca existimata, vaga, inconstans, incerta, varia, indignorumque faulrix. Huic omnia expensa, huic omnia feruntur accepta, et in tota ratione mortalium sola utramque paginam facit (i.e. in the debit and credit of human accounts—adversity and prosperity—everything is set down to her), adeoque obnoxiae sumus sortis, ut sors ipsa pro deo sit, qua deus probatur incertus.'

This last sentence should not lead us to imagine that Pliny is here thinking of Fortuna only as a goddess with a cult: what he is really thinking of, as the context shows, is the dismal superstition which attributed all the changes and accidents of life to Chance, whether vaguely conceived and invoked as a deity or regarded as an unintelligible something about which no one had the inclination to reason—a superstition which excludes human endeavour, and indeed human sense of duty generally, and which may be, far more than we should guess without this remarkable passage, accountable for the want of 'grit' and vitality in all classes under the Roman Empire. It may perhaps be connected with the popularity of a coarse Epicureanism in the last period of the Republic, of which Cicero speaks (*Tusc. Disp.* iv. 6 and 7); for, in spite of its noble presentation by Lucretius, or by Cicero in *de Finibus*, bk. i., the disciples of this school undoubtedly learnt that the gods care for none of us, and that good and bad luck come to good and bad men by blind chance only. We have seen how after the period of Cicero and Cæsar the idea of Fortune as treacherous and capricious began to gain ground, but was checked among men of education and reflexion by the *Aeneid* of Virgil and the *History* of Livy; but we may conjecture that among the uneducated or half-educated, in a period in which the outward forms of religion were revived, without the inward conviction of man's shortcomings or of his dependence on a Deity for help towards right conduct, this poisonous notion of Chance was weakening the fibre of the Roman. It is probable that the constant use of Fortuna in the literature of the period, and even by serious

authors like Seneca, Juvenal, and Tacitus, is a reflexion of this condition of the popular mind. But we find it in its rawest form in writers who took life less seriously, such as Ovid (e.g. *Metam.* iii. 141), or Petronius (*Sat.* 120, 121), or in the work of a soldier like Velleius Paterculus (e.g. ii. 57, 75, 110 *ad init.*), who was not really a man apt and able to reason about such questions.

(4) *Fortuna as a deity*, in common belief and in connexion with the Imperial family. When Juvenal writes, at the end of his tenth satire,

'Nullum numen abest, si sit prudentia; nos te
Nos facimus, Fortuna, Deam, coeloque locamus,'

he is no doubt thinking of his own time, of the growing tendency to turn the vulgar idea of Chance, illustrated under the last head, into a goddess Fortuna worshipped in iconic form.

Two curious stories of this 1st cent. A.D. may illustrate the tendency. Suetonius tells us of the Emperor Galba (writing only a generation later) that he dreamt one night that Fortuna told him that she was standing wearied outside his door, and that if he did not speedily welcome her she would be the prey of any passer-by. He went and opened the door, and found a bronze image of the goddess at the threshold; this he took with him to his Tusculan villa, where he made a shrine for her and set up an elaborate cult. The rest of the story will be found in *Suet. Galba*, 18. Another story was that Sejanus had a statue of Fortuna which turned its back on him just before his fall, as he was sacrificing to it (*Dio. Cass.* lviii. 7. 2). There seems no doubt that he had a statue, and an ancient one, of a deity belonging to his native Etruscan town Volsinii (see Fowler, *op. cit.* p. 171), which may have been an Etruscan representative of Fortuna; but the instructive point of the story is the way in which this statue was seized upon as one of Fortuna by the common belief of the age.

There was, indeed, a tendency to identify other deities with the one now becoming so popular in all parts of the Empire; among the innumerable votive inscriptions to Fortuna to be found in every volume of the *CIL* are many which seem to show that Tutela, Nemesis, perhaps Victoria, come very close to her (specimens of this tendency may be found in Dessau, *Inscr. Lat. Selectæ*, ii. 1. 93 ff.); at the same time it may be noted that the typical figure of Fortuna, with cornucopiæ and patera, or rudder, wheel, or ship's prow, remains essentially the same, as found on coins and statuettes in great numbers in all parts of the Empire (see art. by R. Peter on 'Fortuna' in Roscher's *Lex.* i. 1503 ff.; Mau, *Pompeii*, p. 336 of the Eng. tr.). In this form Fortuna found a place among the Penates of the household.

In two cases, however, under the influence of the syncretizing tendency of the age, Fortuna puts on, in addition to her own, the attributes of other deities: (1) of the mysterious Panthea, by which she seems to become exalted into a position in which she unites the attributes of all other deities (see Roscher, i. 1534 ff.); (2) of Isis (*ib.* 1530 ff.), possibly as a consequence of an old connexion with sea-faring, which was common to both. The latter identification is the most curious development of Fortuna under the Empire.

We can see the process of assimilation in a charming passage of the romance of Apuleius (xi. 15), where the young Lucius is initiated by the priest of Isis into the mysteries of the goddess. Lucius is told that he has passed out of the capricious power of the blind and reckless Fortuna, into the loving care of a Fortuna who is not blind, and who even illuminates the other gods by her own light. 'Behold, freed from his former troubles, rejoicing in the provident care of great Isis, Lucius triumphs over his own Fortune.'

The worship of Fortuna in connexion with the person of the Cæsar may be called an adjunct of the official cult of the Emperor (see art. ROMAN RELIGION, Period IV. § 1). It began in 19 B.C. with the return of Augustus from a course of travel in Greece and the East, when, as we learn from his own record (*Mon. Ancyra. Lat.* ii. 29, Gr. 6. 7), an altar was dedicated on Dec. 15 to Fortuna Redux, and a permanent cult instituted. In the year A.D. 14, i.e. in the first year of Tiberius' reign, games were celebrated to Divus Augustus and Fortuna Redux, which henceforward were held

annually in the beginning of October under the name of *Augustalia*, and appear in the religious calendars (Tac. *Ann.* i. 15: *Fasti Amiterni* and *Antiates*, and *Feriale Cumanum*). From this time onward Fortuna Redux, with the title *Augusta* often added, became specially a deity of the Imperial family. We find her invoked, with the sacrifice of a cow, in the ritual of the Arval Brotherhood, 'ob diem quo urbem ingressus est Vespasianus,' 'pro salute et reditu Domitiani,' and on other occasions of the same kind down to the beginning of the 3rd cent. (Henzen, *Act. Frat. Arv.* pp. 86, 122). For full information on this worship, and the kindred one of Fortuna Dux, see R. Peter, in Roscher, i. 1525 ff.

How far Fortuna was conceived by Augustus and his immediate successors as a really efficient *numen* must remain doubtful; but later on there can be no doubt that she, or rather her image, became little better than a fetish. The story of Galba and the image has already been told; the *Scriptores Historiae Augustae* tell us of Antoninus Pius, and even of Marcus Aurelius, that they kept a golden image of her (*Fortuna aurea* or *regia*) in their bed-chambers, and carried it with them wherever they went (see, e.g., Jul. Capitolinus, *Ant. Pius*, 12: Spartianus, *Severus*, 23). But after the spread and final recognition of Christianity this came to an end, as did the official worship; for Fortuna, whether thought of as a goddess of chance or as a protecting deity, was equally irreconcilable with Christian convictions.

Summary.—We may now sum up in a very few words the long story that has been told above. Fortuna begins as a deity, not of mere chance, but of helpful power in relation to certain events of human life, especially childbirth and seafaring, and then develops under many forms and cult titles which, however, gradually lose their original force and meaning, like so many other of the early Roman worships (see ROMAN RELIGION, Period IV. § 1). Meanwhile the influence of the later sceptical Greek idea of *τύχη* introduces the Roman mind to the conception of blind chance, best shown in the fragment of Pacuvius (above, p. 98); but this is neutralized among the better educated by the later or Roman School of Stoicism, beginning with Panætius and in a historical form with Polybius, and having a tendency to associate the conception of Fortune with the Destiny of Rome and the *Fortuna Populi Romani*, as we see it in Virgil and Livy. In the confusion of the last age of the Republic, and perhaps under the influence of popular Epicureanism, the more degraded idea of Fortuna gains ground, and appears in writers of a less earnest moral type in the 1st cent. of the Empire, and also in the thought and worship of the less educated classes. Lastly, we return to an official or state cult of Fortuna in connexion with the cult of the Cæsars, and with the settled order of the Empire; and finally, under the benign influence of Christianity the lower aspects of the idea and the cult alike tend to disappear.

See also FATE (Greek and Roman).

LITERATURE.—R. Peter, in Roscher, *Lex. der gr. und röm. Myth.* i. 1503; G. Boissier, *La Religion romaine*², Paris, 1891; H. Dessau, *Inscriptiones latinae selectae*, ii., Berlin, 1902; W. Warde Fowler, *The Roman Festivals of the Period of the Republic*, London, 1899; R. Heinze, *Virgils epische Technik*, Leipzig, 1903; G. Henzen, *Acta fratrum arvalium quae supersunt*, Berlin, 1874; A. Mau, *Pompeii, its Life and Art*, Eng. tr., New York, 1899; A. Schmekel, *Philosophie der mittleren Stoa*, Berlin, 1892; G. Wissowa, *Religion und Kultus der Römer*, Munich, 1902; E. Zeller, *The Stoics, Epicureans, and Sceptics*, Eng. tr., London, 1880.

W. WARDE FOWLER.

FOSTERAGE.—By this term is meant the practice of receiving into a family the child of another household, to keep and nurture for a certain period. The custom differs from adoption

(*q.v.*) in that the foster-child does not become a permanent member of the family by which it is received. Language does not originally distinguish between nurse and foster-mother, and fosterage may be considered as a natural development of nursing, arising when considerations of health or other special circumstances render it desirable to separate the child for a time from its parents. Such cases will occur in any community, however primitive, and the natural tie of affection between nurse and nursling may be expected to subsist between foster-parents and their charge. Among certain peoples this feeling attains exceptional strength, and the relationship develops into an important institution. This happens especially in a tribal condition of society, when family relationships are still the main social nexus, before the growth of political association.

I. ORIENTAL RACES.—1. Arabs.—Although it is among European nations that the custom reaches its highest development, it has its importance for certain Oriental peoples also. It must have prevailed from early times in Arabia. Muhammad was put out to nurse with a woman of the Beni Sad, who reared him among her own tribe until he was five years old, and anecdotes are told of the attachment which he displayed in later years towards his foster-mother and her daughter (Muir, *Life of Mahomet*³, London, 1894, pp. 5-7). When he came to legislate for his followers, he laid down a law against the intermarriage of persons connected by the tie of milk-kinship. The principle of the law is stated in the words: 'Whatever is prohibited by consanguinity is also prohibited by fosterage': that is to say, the tie of milk is as much a bar to marriage as the tie of blood, and the kin of foster-parents come within the forbidden degrees in just the same way as the kin of actual parents (*Hedaya*, tr. Hamilton and Grady, London, 1870, p. 67). This enactment must be regarded, not as an arbitrary decree of the Prophet, but as giving legal form and sanction to the traditional usage among the Arabs (Robertson-Smith, *Kinship and Marriage in Early Arabia*², London, 1903, pp. 175 f., 195 f.). Muhammad's principle was worked out in the *Hidāya*, and a metaphysical theory was supplied by later legists. The prohibitions thus established remain in force to the present day, and are incorporated into the Anglo-Muham. law of India (R. K. Wilson, *Anglo-Muham. Law of India*³, London and Calcutta, 1908, p. 113).

2. India.—On this point there is a sharp distinction between the Muhammadans of India and the Hindus. Among the latter fosterage is not unknown, but it has no particular significance and is practically unrecognized by Hindu law (H. Maine, *Early Institutions*⁷, 243), whereas adoption holds an important place in this code. A foster-child enjoys no legal status unless the ceremony of adoption has been performed (J. D. Mayne, *Hindu Law*⁴, Madras and London, 1888, § 167). The pure-blooded inhabitants of Rajputana, however, with their more primitive type of community, give much more prominence to foster-kinship.

⁴ Although the foster-family of a Chief is never of the Rajput clan, but belongs almost always to some particular family of a well-known pastoral tribe, yet the foster-brothers often attain much influence and position at his court, and the family has a recognized hereditary status of "kinship by the milk" (Lyall, *Asiatic Studies*, London, 1882, p. 221).

In the same way the Rajas of Bundelkhand have their children fostered by women of the Ahir caste of cowherds; in speaking to a man of this caste, *dawa*, 'foster-father,' is a respectful mode of address [information from H. Spencer, I.C.S.]. The same habit of choosing the foster-parents of chieftains among a particular subordinate tribe will meet us again in Ireland.

3. Turco-Tatars.—That foster-kinship was more

than a legal fiction among the Muhammadans of India may be seen in the case of Akbar, the Mughal Emperor of Delhi.

Akbar had much to suffer on account of the favours which he lavished on his foster-mother, Maham Anka, and her family. She was for many years the most influential person at his court, and her son, Adham Khan Koka, was one of his generals. When this man actually stabbed the Emperor's minister, Muhammad Khan Atka, it is remarked by the Muslim historian that Akbar's wrath caused him to forget the *nisbat* ('connexion') which bound him to the assassin's mother, and to order his summary execution. The murdered minister and his son, Aziz, were related to Akbar through another foster-mother. Aziz succeeded his father in power, but proved troublesome and contumacious; the Emperor, however, refused to inflict any but the lightest punishment on him, saying: 'Between me and Aziz there is a stream of milk which I cannot cross' (Malleison, *Akbar*, Oxford, 1890, p. 177).

The titles *anka*, *atka*, *koka*, here used to designate the foster-mother, her husband, and their son, are Turkish words in use among the nomadic tribes from whom the Mughal Emperors drew their origin; and the sentiment which Akbar acknowledged cannot be ascribed to the influence of the Muham. faith which he and his people had embraced (he was far from being a devout Muslim), but marks the prevalence of the custom of fosterage among the Turco-Tatar nomads of Central Asia. The custom and the associated sentiment no doubt grew up among them under conditions of life broadly similar to those which obtained over most of Arabia. Among these tribes, as among the Arabs, the tie of milk seems to have been from immemorial times equivalent to blood-relationship. The Osman Turks allow to a foster-brother free access to the *harim*, which is otherwise permitted only to near kinsmen (A. Vambéry, *Das Türkenvolk*, Leipzig, 1885, p. 216). A chieftain's foster-brothers are found among his closest adherents, on whom he relies in the hour of need (Elias and Ross, *Ta'rih-i Rashidi*, London, 1898, p. 459, note). The same trait will be noted in the case of the Irish and Scottish tribesmen.

4. Circassians.—The Oriental peoples agree, as a rule, in regarding the act of nursing at the breast as the essence of the foster-kinship, which therefore centres in the person of the foster-mother: it is only as related to her that the rest of the foster-kindred come into account. With the Circassians, however, the foster-father seems to be of more importance.

'The son of a Circassian chief is taken from home and consigned to the charge of a tutor or foster-father, called an *attalik*; and, until he attain the age when his education is supposed to be complete, it is considered as an unpardonable weakness in the real father to desire to see his child. Boys are regarded rather as the property of the tribe than of the parents; and, should the latter have neglected to choose an *attalik* for their son, any one who feels disposed may offer to undertake the charge. There are even instances of an enthusiastic educator carrying off a pupil by force; and this is not by Circassian law a punishable offence' (L. Moser, *Caucasus*, London, 1850, p. 32). The rôle of the *attalik* is here very similar to that of the *aite* in Ireland or the *fóstri* in Scandinavia (see below).

II. EUROPEANS.—1. Slavs.—The European peoples do not, as a rule, lay the same stress as the Orientals on the function of the foster-mother, nor is milk-relationship generally regarded as a bar to marriage. An exception must, however, be made in regard to the Slavs of southern and eastern Europe, who, influenced perhaps by their Muham. neighbours, consider the union of foster-kindred as unlawful. Foster-children (and also adopted children) are regarded in the same light as the natural offspring, and the foster-child bears the name of the foster-father so long as it remains in his house (Maine, *Early Law and Custom*, London, 1891, p. 257; F. S. Krauss, *Sitte und Brauch der Südslaven*, Vienna, 1885, pp. 10, 14, 602).

2. Greeks and Romans.—The two European nations which were the first to reach a high level of civilization are those among whom the relationship is of least importance. Neither Greek nor Latin has any special term to denote foster-kinship, nor is it recognized by Greek or Roman Law. Isolated

cases no doubt are to be found, and there are indications that under the later Roman Empire (as in the Parisian world of the 18th cent.) fashionable women sometimes got rid of domestic burdens by putting their children out to nurse in the country. An edict of the Emperors Honorius and Theodosius (dated A.D. 409 and incorporated in the *Theodosian Code*) forbids parents to entrust their offspring in this way to the care of shepherds, a class that was held in very ill esteem:

'Nemo curialium plebeiorum possessorumve filios suos nutriendos pastoribus tradat. Aliis vero rusticis, ut fieri solet, nutriendos dari non vetamus' (*Cod. Theodos.*, ed. G. Hänel, Bonn, 1842, p. 909).

Foundlings.—A different type of fosterage receives special treatment in Roman Law. This arose from the custom of exposing new-born infants which the parents did not desire to rear. It sometimes happened that the unfortunate babe was rescued and brought up by strangers from motives of compassion or convenience. The story of Oedipus and the plots of many Greek comedies afford examples. In Rome, the codes of the later Empire define the rights of the fosterer (*nutritor*) in such cases. The *Codex Theodosianus*, adopting the principle of an edict of Constantine, lays down (lib. v. tit. 8) that any one who rears an infant thus exposed acquires full rights over it, and may treat the foundling as his son or his slave, at pleasure. If the actual father desires to recover his child, he must give in exchange a slave of equal value, or pay an equivalent sum. Similar provisions are found in the semi-Roman codes of various barbarian peoples who were in contact with the Empire, and among whom the exposing of children was a common practice. The statute just quoted was incorporated in the *Lex Romana Rætica* of the 8th century (see *Capitulum Regum Francorum*, cxliv., in Canciani, *Barbarorum Leges Antiquæ*, Venice, 1781, iii. 274). A further development is added in the Laws of the Visigoths (c. A.D. 654), where the actual parents, if identified, are laid under a formal obligation to redeem the child; if they fail to do so, they are to suffer exile for life, and the *judex territorii* is directed to pay the redemption price out of the father's property; or, if the father has nothing, he is to become a slave in place of his son, who is to go free. It is further laid down that, if parents entrust a child to another person, the fosterer is to be paid annually a shilling (*solidum*) for each year of the child's age, up to the age of ten, after which his service is to be taken as equivalent to his keep. It is, of course, impossible to say whether such enactments were really operative among the rude nations for whom they were framed.

The attempt to enforce the performance of parental duties was no doubt due to the growing influence of the Church, to which the practice of exposing children was naturally repugnant. The *Formulae Sirmondi*, which probably represent the practice of the *tractus Turonensis* (Touraine), speak of a class of officials called *matricularii*, whose special duty it was to take charge of foundlings. These infants were usually left at the church-door by stealth; the *matricularii* had to take care of them and induce charitable persons to receive them into their families. The Synods of Vaison (A.D. 442) and Arles (A.D. 443?) laid down canons dealing with this question.

Cf. Hebele, *Hist. of the Councils*, Eng. tr., Edinb. 1883, iii. 166, 171; *Formulae Sirmondi*, in Canciani, iii. 419, 438; see also Regino, *de Eccl. Discipl.*, Paris, 1671, lib. ii. §§ 60-72.

The methods adopted by the mediæval Church are still in force in the Balkan States (F. S. Krauss, 587). In the more progressive countries the care of waifs and destitute children is generally recognized as a public duty, and is entrusted either to Foundling Hospitals and similar institutions, or

to foster-parents, who are paid for their trouble either by the State or by local authorities (*EBr*¹¹, art. 'Foundling Hospitals').

3. Anglo-Saxons.—After the introduction of Christianity into England, these duties were discharged by pious women (*sacræ virgines* [Augustine, *Ep. ad Bonifac.* 23]). The laws of King Ine provide an allowance for any one who takes charge of a foundling; and other early laws define the rights of foster-parents on lines similar to those laid down by the *Codex Theodosianus*. Fosterage by desire of the parents seems to have been prevalent among the Anglo-Saxons. Augustine, in the *Epistle* just referred to, complains that mothers are apt to delegate to others the duty of nursing their children; and the early Church set its face against the practice, but it was too deeply rooted to be easily suppressed. Thorpe asserts that the custom of fosterage was as prevalent among the Anglo-Saxons as among the Scandinavian nations (*Ancient Laws and Institutes of England*, London, 1840, Glossary, s.v. 'Foster'). It should be observed, however, that the words *fóstre* and its derivatives, on which he seems to rely, are used of nursing in general, whether in the home of the parents or elsewhere (cf. T. Wright, *Womankind in Western Europe*, London, 1869, p. 55). But there is other evidence to show that the custom was very general: e.g., the efforts made both by ecclesiastical authorities and by kings to check the abuses, and even crimes, which occasionally arose from the carelessness or treachery of foster-parents.

Thus, Kenelm, son of Kenwulf, king of Mercia, was murdered in infancy by his fosterer in order to clear the way to the throne for his aunt Quendreda (for other examples, see J. Thrupp, *The Anglo-Saxon Home*, London, 1862, p. 83f.).

Such instances might suggest that the relationship did not possess the same sanctity among the Anglo-Saxons as in Scandinavia or in Ireland. But it is natural to suppose that, as a rule, a strong affection did subsist between foster-parents and their charges.

Both King Edgar and King Athelstan showed their gratitude to their foster-mothers by bestowing on them substantial grants of land (Sharon Turner, *Hist. of the Anglo-Saxons*, London, 1852, iii. 5-7).

4. Scandinavians.—In Scandinavia the custom attains a much higher development, and it is to be noted that the word *fóstr*, with its derivatives, belongs originally to the Scandinavian branch of the Germanic languages, whence it was early borrowed by the Northern dialect of English. In primitive Norway, as elsewhere in the ruder stages of society, it sometimes happened that children exposed at birth were reared by strangers, and that this charitable office produced a mutual affection of great strength (Dasent, *Burnt Njál*, London, 1861, preface, xxv). But, as a rule, fosterage was undertaken by the wish of the parents; examples are to be met with on every page of the Norse and Icelandic Sagas, and the native codes legislate specially for this kind of relationship.

(1) *Characteristic features*.—The maternal office performed by the foster-mother is not here, as in the East, the essential point; it is rather the foster-father (*fóstri*) who plays the leading part. The charge of the child does not always begin from infancy, and it is usually continued to the verge of manhood. According to the Icelandic code of law known as the *Grágás* (tit. xxi.), the age of sixteen is the normal limit of the period; but in the Sagas it often lasts to eighteen or even later (*Hervertar Saga*, ed. P. F. de Suhm, Copenhagen, 1875, p. 81). The fosterer does not merely rear the child; he undertakes its whole education.

In the *Völsunga Saga*, Sigurd's foster-father instructs him in *idrottir*, chess and runes, and teaches him to speak foreign tongues (du Chaillu, *Viking Age*, London, 1889, ii. 45). So, in the *Droplaugar-sona Saga*, Bessi the Wise, in offering to foster the son of Droplauga, promises expressly to teach him his own wisdom (*Sagan af Gunnlaugi Ormstungu ok Skallá-Raffni*,

Copenhagen, 1775, p. 48, note). Often the boy's education is completed by his being taken as a comrade on expeditions of adventure and piracy (Dasent, *Orkneyinga Saga*, Rolls Series, 1894, p. 220). A knowledge of law being an important branch of knowledge, Njál teaches it to Thorhall, so that he becomes the greatest lawyer in Iceland (Dasent, *Burnt Njál*, i. 82). The crafty Thronð teaches Sigmund 'how to bring all kinds of law-suits, and how to get his own rights and those of others' (York Powell, *Færeyinga Saga*, London, 1896, p. 75).

Such cases justify the saying *fjórðungi bregdr til fóstrs*, 'the fostering is a quarter of the man' (Cleasby-Vigfusson, s.v. 'Fóstr').

In many cases the foster-father gives part of his property to his foster-son. The amount that may be thus conveyed is limited by the ancient law in the interest of the proper heirs (*Norges Gamle Love*, Christiania, 1846, i. 213); but in the Sagas the foster-son is sometimes made heir to half or all his fosterer's property (K. Kaalund, in *Aarbøger for nordisk Oldkyndighed og Historie*, 1870, p. 279).

(2) *Strength of sentiment*.—The affection which sprang from this relationship is described as of extreme intensity, both as between foster-child and foster-parents, and as between foster-brethren; as in Ireland, it is said to have been even stronger than the tie of consanguinity.

When Thorhall, one of Njál's foster-sons, heard of Njál's death, he was so violently moved that 'he swelled all over and a stream of blood burst forth from both his ears, and could not be staunched, and he fell into a swoon' (*Burnt Njál*, ii. 195).

A violation of this sentiment is regarded as an offence against the natural charities.

The tragic motive of the *Laxdæla Saga* consists in the gradual estrangement brought about by the machinations of a wicked woman between the foster-brothers Bolli and Kjartan, which issues in a fratricidal conflict. Attacked unwillingly by Bolli, Kjartan flings away his weapons, saying: 'I am much more fain to take my death from you than to cause the same to you myself' (*Laxdæla Saga*, tr. M.A.C. Press, London, 1899, p. 178).

The term 'foster-brothers' came to be extended to those who had gone through the ceremony of swearing brotherhood, as in the so-called *Fóstbrædra Saga*. (This rite is described in Vigfusson and York Powell, *Origines Islandicæ*, Oxford, 1905, i. 319 and in art. BROTHERHOOD [Artificial], vol. ii. p. 857; cf. Dasent, *Gisli*, Edinburgh, 1866, p. 23.) The proper term for such a 'sworn-brother' is, however, *eidbródr* or *svarabródr* (see Vigfusson and York Powell, *Corpus Poeticum Boreale*, Oxford, 1883, i. 424).

(3) *Reasons of special development*.—The causes which gave the practice of fosterage peculiar importance in Scandinavia must be sought in the barbarous and violent condition of society described in the Norse and Icelandic Sagas. The weaker man, unable to secure the safety of his household, could gain the protection of a stronger neighbour by fostering his son. Or, again, one who found himself isolated and threatened by enemies might acquire in this way the support of powerful friends.

In the *Færeyinga Saga* the crafty and treacherous Thronð, being a kinless man, takes to himself foster-sons from three different families. Tord of Geirulfsöre, in the *Vigaglums Saga*, is fosterer to one of Helge Asbjörnson's children; being convicted of theft, he refuses to pay the usual fine, saying that 'it would be little good he should get by fostering Helge Asbjörnson's son, if he should have to pay the penalty in a case like that!'

The fosterer is therefore, as a rule, in a position of inferiority to the parents of his charge: hence the saying that 'he is the lesser man who fosters another's child' (Cleasby-Vigfusson, s.v. 'Barnfóstr').

This maxim may be illustrated by a tale which is told in the *Saga of Harald Hárfager* (S. Laing, *Heimskringla*², London, 1889, i. 391-4). Athelstan of England had tricked Harald into performing an act which might be construed as a form of homage to the English king. Wishing to pay him back in kind, Harald sent his infant son, the child of a servant-girl, to Athelstan under the charge of Hauk. On being admitted to the king's presence, Hauk advanced and set the child on the king's knee; and, when Athelstan asked what this meant, he replied: 'Harald the king bids thee foster the child of his servant-girl.' Taking a child on one's knee (*knésetja*) was among Germanic peoples the usual form of accepting parentage. Athelstan was very angry, but presently accepted the situation, and brought up the boy, who grew up to be king Hakon. Harald was de-

lighted at the success of his retort, 'for it is the common observation of all people,' says the chronicler, 'that the man who fosters another's children is of less consideration than the other.'

Instances are, however, to be found where the offer to undertake the charge of a boy is made as an overture of friendship, as when Heidrek, in the *Hervertar Saga* (p. 111), offers to foster the son of the king of Gardariki; the queen's advice to her husband on this occasion shows that it was dangerous to refuse such a proposal when made by a formidable and ruthless warrior. Again, the person who offers fosterage may be an equal or superior, and his intention may be to make reparation for injuries done, by thus accepting the inferior position. So Njál undertakes to foster the boy Hauskuld, whose father has been slain by Njál's son Skarphedin (*Burnt Njál*, ii. 59).

(4) *Fosterage as a legal contract.*—The ancient laws of Scandinavia give the foster-father a legal status, and define his rights and obligations in respect to the foster-child and the actual father. The parties enter into a regular contract, and the foster-father receives a certain amount of money or goods or land to defray his expenses. If either side fails to fulfil its part of the bargain, the law provides compensation. Thus, if the child is withdrawn by the father, he cannot recover the money he has paid; while, if the fosterer sends the child home before the proper time, or if he does his part so badly that the father is justified in withdrawing his child, he must refund a proportion of the amount paid to him (*Grágás*, tit. xxi.; *Gamle Love*, i. 286, § 88). In some cases recognized by the *Grágás* no payment is made by the father, fosterage being given in consideration of benefits rendered or promised. The case of an orphan is specially provided for: if he is reared by a person not legally responsible for his nurture, the fosterer may claim a fee (*fóstrlaun*) out of any property which may come to the foster-son, or out of any *wergild* which may be adjudged for injury done to him—provided always that the person who makes such a claim has formally undertaken the duties of a foster-father. By so doing he acquires the rights and undertakes the liabilities of the natural parent: he is entitled to make claims on behalf of his foster-son, and is responsible for claims made against him.

Thus, when Sigmund in the *Færeyinga Saga* (as above, pp. 36-38) claims *wergild* from Thrond for the murder of his father Breste, Thrond, as a counterstroke, undertakes the fosterage of Laf, whose father had been slain by Sigmund, and makes a cross-claim against Sigmund for *wergild* on behalf of Laf. Under the ancient *Gulathingsslov*, either of a pair of foster-brothers has the right to demand a *wergild* of 12 *aura* for the death of his fellow from the slayer (*Gamle Love*, i. 80, § 239).

In all this legislation there is much that is closely similar to the provisions of the *Ancient Laws of Ireland*; the whole conception of the foster-relationship is much the same, and there are striking coincidences in points of detail.

5. *Gaelic Celts of Ireland.*—(1) *Legal enactments.*—References to the subject of fosterage are scattered throughout the five volumes of the *Ancient Laws of Ireland* (which, it must be remembered, do not constitute a code and have no historical unity). The most important locus is the *Cáin Iarraith*, or Law of Fosterage-Fee (ii. 146-192). The term *iarraith* answers to the Scandinavian *fóstrlaun*, and denotes the value in money or kind made over to the fosterer by the parents. The amount of this fee is fixed on a scale varying according to rank, a higher rate being charged for girls than for boys. Provision is made, as in Scandinavian law, only with more detail, for the termination of the arrangement on either side, and for compensation to be made by the foster-parents in case of neglect or of harm done to their charge. The treatment which the foster-child receives is to

vary according to the rank of the parents and the amount of the *iarraith*. Rules are laid down as to gradations of food and dress, with a minuteness that belongs to artificial theory rather than actual practice (for details, see CHILDREN [Celtic], § 7). The foster-father is to teach the useful and agreeable arts, especial stress being laid on riding. He has the right of inflicting castigation and other punishments in case of misbehaviour; on the other hand, he is made responsible for mischief done by the foster-child, so far as this can be ascribed to his own neglect or ill teaching. His functions thus include those of a tutor; the importance of the moral influence so exercised gave rise to a saying to the effect that fostering is two-thirds of a child's nature (O'Donovan, *Battle of Magh Rath*, Dublin, 1842, p. 294). As one man might foster several boys, it is clear that in a more settled state of society the foster-father would easily pass into a schoolmaster. And, in fact, the term *aite* may mean either 'foster-father' or 'tutor,' and the derivative *aitechas* or *oideachas* is in modern Irish the regular equivalent of 'education'; so also *dalta* is an ambiguous term meaning sometimes 'fostering' and sometimes 'pupil.' The relations between tutor and pupil are expressly recognized by the Laws as constituting a distinct species of fosterage; a section of the *Cáin Lánamna*, or Law of Social Connexions, defines the mutual obligations of the 'teaching foster-father' (*aite forctail*) and his pupil (*Laws*, ii. 349). Maine has pointed out the analogy between this relationship and that which subsists between the Bráhma and his disciple (*Early Institutions*, 242). In ecclesiastical documents, such as the *Lives of the Saints*, the same terminology is employed to designate the spiritual teacher and the pious youths who come to live with him and receive instruction in the Faith.

It is significant that in the *Cáin Iarraith* the foster-mother (*muime*) is barely mentioned. It is true that this omission is to some extent made good by paragraphs in the *Cáin Lánamna* (*Laws*, ii. 349); but there can be no doubt that among the Gaedels, as in Scandinavia, the foster-father was the pivot of the relationship.

In the Laws, as is natural, fosterage is regarded mainly as a contract for mutual advantage. Yet even here it is expressly stated that it may be undertaken for love; and, even where a consideration is paid, it is recognized that the relationship established does not end with the termination of actual fosterage, which is fixed at the age of 17 for boys, 14 for girls (*Laws*, ii. 176, 193). A durable connexion has been created, described as *lánamnas*—a term which ordinarily denotes the most intimate of all relations, that of husband and wife. When the foster-father returns his charge to the parents, he gives parting gifts (*seóit gairitechta*), which are, in fact, the assertion of a lasting claim on the gratitude and good offices of the foster-child (*Laws*, ii. 190).

(2) *Historical evidence.*—There is much uncertainty as to the period in which the Irish Laws first took definite shape, and it is difficult to judge how closely their theory corresponds with actual usage; but there can be no doubt that their enactments in regard to fosterage are founded on a custom which was inwoven with the life and habits of the Gaedels as far back as they are known to us. It is already in vogue in the legends of the Ulaid (the cycle of Conchobar and Cúchulainn), which represent a state of society perhaps as old as the Christian era; and it meets us at every turn in Irish literature and history, down to the break-up of the old tribal system about the year 1600. Even in the 17th and 18th centuries it still lingered in certain regions.

In Ireland, as in Scandinavia, it was deemed an

honour and advantage to be allowed to rear the son of a powerful chieftain, and thus establish a claim to favour and protection. A passage in the *Laws* (ii. 285) seems to imply that fostering could be undertaken only by persons who stood in a certain degree of consanguinity to the parents. This may have been the rule in very primitive times, or it may have been a point of artificial theory, not really observed in practice; at all events, if there ever was such a restriction, it must have disappeared very early. As a rule, no doubt, the foster-parents belonged to the same clan as the father, but this was not always the case. The son of a noble house often had several fosterers.

At the birth of Cúchulainn, who was nephew to the powerful king Conchobar mac Nessa, and whose future greatness was foretold by Druids, a competition at once arose for the privilege of fostering the child (Thurneysen, *Sagen aus dem alten Irland*, Berlin, 1901, p. 61). The daughter of another king, Eochaid Salbuide, had twelve foster-fathers (*ib.* 63). When St. Patrick preached to the daughters of King Lögair, and told them of the greatness of God, they asked, among other questions, whether many had fostered God's Son, implying that this would be a test of His rank and power (Joyce, *Soc. Hist. of Anc. Ireland*, ii. 17). In the latest days of the old national life we find the same view expressed. Fynes Morison says that women of good wealth seek with great ambition to nurse the children of lords and gentlemen, 'not for any profit, but rather spending much upon them while they live, and giving them when they die sometimes more than to their own children. But they do it only to have the protection and love of the parents whose children they nurse' (Itinerary, in C. L. Falkiner's *Illustrations of Irish History*, London, 1904, p. 318).

According to Sir John Davies (in H. Morley's *Ireland under Elizabeth and James I.*, London, 1890, p. 296), the poorer and weaker sometimes actually bought the 'alterage' of a 'potent and rich' man's children—an inversion of the principle of *iarrraith* described above. It is probable that, during the centuries of constant warfare with the English invaders, the desire to gain protection and support gave additional strength to the system of fosterage, and imparted fresh intensity to the feeling by which foster-kindred were united.

(3) *Strength of sentiment.*—The feeling referred to had always been one of singular power. Everywhere in the older literature the tie between foster-father and foster-child, or between foster-brothers, is regarded as equivalent to the ties of blood.

In the tale of Ronan and his son Malfiothartig, the latter's two foster-brothers are his trustiest companions: one of them dies with him, the other avenges his death ('Fingal Ronain,' in *RCel* xiii. [1892] 368). In the tale of the Battle of Magh Rath (ed. O'Donovan, pp. 135, 161, etc.), King Donnall is throughout deeply concerned about the personal safety of his foster-son, Congal Cloen, though the latter is in rebellion against him. When circumstances force men so connected into conflict, the situation is felt to be peculiarly tragic, as in the combat between Cúchulainn and Fer Diad (E. Hull, *Cuchullin Saga*, London, 1898, p. 186 ff.), or in the destruction of Conaire by his foster-brothers, the grandsons of Donn Desa (*Togail Bruidne Dá Derga*, ed. W. Stokes, in *RCel* xxii. [1902]).

Giraldus Cambrensis in the 12th cent. (*Topog. Hibern.* iii. 23) and many English writers and politicians of the Elizabethan period bear emphatic testimony to the binding force of this attachment.

'In the opinion of this people,' says Sir John Davies (as above, p. 296), 'fostering hath always been a stronger alliance than blood, and the foster-children do love and are beloved of their foster-fathers and their sept more than of their own natural parents and kindred, and do participate of their means more frankly, and do adhere to them in all fortunes with more affection and constancy.' Stanihurst (*de Rebus in Hibernia gestis*, Antwerp, 1584, p. 49) and Fynes Morison (p. 319) speak in similar terms, and Spenser (*View of the State of Ireland* [Works, Globe ed., London, 1906, p. 636*]) describes a scene equally barbarous and impressive, when, after the execution of Murrough O'Brien, his old foster-mother flung herself on the ground and drank the blood that flowed from the headless corpse.

(4) *Political significance.*—The passion which inspired such actions was to Englishmen morally unaccountable and therefore repugnant; and its consequences were politically inconvenient. A relationship so wide-spread and so intimate formed a social cement of great tenacity, and helped to

solidify the tribal system which the conquering race was above all things anxious to undermine. If a native leader had a turbulent and dangerous following, it was apt to be commanded by a foster-brother, who clung to him with desperate loyalty.

The State Papers supply instances in point. When the Sagan Earl of Desmond was finally hunted down, the only man left with him was his foster-brother, Thomas O'Feighey (R. Bagwell, *Ireland under the Tudors*, London, 1890, iii. 391). See also J. Perrott's report as to the fosterer of Turlough Lynagh O'Neill (Calendar of State Papers [Ireland], 1674-1685, p. xxii).

Another circumstance gave a formidable extension to the influence of the custom. The relationship was not confined to the family of the fosterer, but might be accepted by the whole sept to which he belonged. Examples of this are given by O'Curry (*Manners and Customs*, ii. 375), who goes so far as to assert (ii. 355) that fosterhood 'was generally that of a whole family or tribe,' and that 'in very many cases it became a bond of friendship and alliance between two or more tribes and even provinces.' This is an exaggeration; it is more probable that the tribe was concerned only when the fosterling was the son of an important chief. Such cases are to be met with frequently in Elizabethan times.

Hugh Roe O'Donnell, born about 1572, was fostered by chieftains of the O'Donnells and McSwineys and also by the O'Caahans, thus uniting the support of three of the strongest clans in the north of Ireland (*Life of Hugh Roe O'Donnell*, ed. D. Murphy, Dublin, 1895, pref. xxxii). The strength of the famous Shane O'Neill is reported to lie 'not in the nobility nor yet in his kinsmen and brothers, but in his foster-brothers the O'Donnellaughs, about 300 gentlemen' (Calendar of State Papers [Ireland], 1509-1573, p. 333; cf. *Intro.* to this volume, p. xv). In a description of the state of Ulster in 1588 the Quins and Hagans are spoken of collectively as fosterers of the Earl of Tyrone (Cal. State Papers, 1608-1610, *Intro.* p. x).

It was not only the cohesion thus imparted to the tribal system that made the custom objectionable to English politicians. They saw in it one of the main influences which tended to merge the English settlers in the native population. The Statute of Kilkenny in 1367 declared fosterage and *gossipred* between English and Irish to be high treason; and 'fosterage and alliance with the Irish' headed the list of charges for which the seventh Earl of Kildare and eighth Earl of Desmond suffered attainder, and the latter execution, in the year 1468 (*DNB*). Nevertheless, the Statute of 1367 soon became inoperative in this respect. Sussex, writing in 1557, complains that it is not put in execution (Cal. State Papers, 1509-1573, p. 138). Fynes Morison (p. 260) classes fosterage, along with intermarriage, among the five main causes which combined to alienate the Anglo-Irish from the English connexion. At the very end of the 16th cent. Spenser (p. 675*) declares that the English settlers tend to 'become mere Irish, with marrying with them, fostering with them, and combining with them against the Queen.' Amid the general effacement of native institutions which followed the suppression of Tyrone's rebellion, fosterage disappeared, though traces of the custom persist in later days.

6. *Gaedels of Scotland.*—As the Scottish Highlanders were originally an offshoot of the Irish race, it is not surprising to find that fosterage prevailed amongst them also. It did not attain the same political importance here as in Ireland, but there is sufficient evidence to show that it was equally common and associated with an equally powerful sentiment. Two striking examples of the devotion displayed by foster-brothers are cited by Sir Walter Scott in the preface to his *Fair Maid of Perth*. As the native social system lasted unbroken in the Highlands longer than in Ireland, this characteristic feature survived later. Dr. Johnson found it still in vigour when he visited the Hebrides in 1773. His *Journal* describes in detail the arrangements made between foster-parents and the fathers of their charges (*A Journey*

to the Western Islands, London, 1876, p. 118). Skene (*Celtic Scotland*, Edinburgh, 1876-80, iii. 221) gives four examples of written contracts of fosterage, the latest of which dates from 1665. They confirm the accuracy of Dr. Johnson's statements, and agree in principle with the Irish *Cáin Iarraith* already quoted. The obligation of the foster-father and the parent, and the share of expenses to be borne by each of the parties, are very precisely specified.

7. Wales.—Among the Brythonic races the evidence of fosterage is much more meagre than with their Gaelic relations. The remains of Breton and Cornish literature are too slight to furnish any information, but in the *Mabinogion* instances are found sufficient to show that the custom held a certain place in the primitive life of the Welsh people (see the tales of Peredur, Kulhwch, and Branwen, in Lady C. Guest's *Mabinogion*, London and Llandoverly, 1849, i. 313, ii. 250, iii. 114).

The references to the subject in the *Ancient Laws of Wales* are casual and unimportant in comparison with the elaborate provisions found in the Irish Laws; but they imply that it was a common practice for a noble to allow his sons to be fostered in the house of a serf (*aillt* or *taeog*). If such fosterage lasted a year and a day, the boy thereby acquired a right to a share in the goods of his foster-father (*Ancient Laws of Wales*, London, 1841, pp. 95, 393). No such right seems to have existed in the case of freehold (*breyr*) land.

The sons of kings seem to have been frequently brought up in noble houses. The early Latin *Life of St. Samson*, who lived in the 6th cent., speaks of his parents' families as being of high rank and fosterers of kings (*altrices regum*) (*AS*, 28 Jul., vi. 574). Giraldus Cambrensis declares that in his time this usage led to civil discord, as the nobles who had thus reared the different sons of a royal house took each of them the side of his own foster-son, and pushed his interests against his brothers'. Giraldus adds that truer friendships are accordingly to be found existing between foster-brothers than between brothers in blood (*Descriptio Cambriæ*, lib. ii. cap. 4, 9).

A remarkable instance of this is quoted in J. E. Lloyd's *History of Wales*, ii. 549. When, on the death of Owain Gwynedd, war broke out among his surviving children, and his son Hywel was defeated and slain by his half-brothers, he was defended to the last by the seven sons of his foster-father Cadifor, who died fighting round him.

Sir J. Rhŷs (*Welsh People*³, London, 1902, p. 207, note) suggests that the explanation of the custom of fosterage in Wales is to be sought in the character of the marriage-contract and the division of the children on the separation of the parents. But this theory is at variance with the whole treatment of the subject in Irish law, and it is not likely that the custom had different origins in two neighbouring peoples of kindred race. It is perhaps more likely, as is suggested by Anwyl (see CHILDREN [Celtic], § 1), that it was connected with some primitive tabu which forbade the father to see his children until they had reached a certain age (cf. the account of the Circassian practice quoted above, I. § 4). Whatever the origin of fosterage may have been, the evidence here collected indicates that it is most likely to develop and assume importance in a disturbed and unorganized condition of society, where the individual, not being able to rely on a central authority or on corporate social instinct, is led to seek security by laying great stress on family ties, and by giving to artificial relationships the same sanctity as to the natural obligations of blood-kinship.

LITERATURE.—For discussions and descriptions of fosterage in different countries, see especially the following: H. S. Maine, *Lectures on the Early History of Institutions*⁷, London, 1906, pp. 241-243; *EBr*¹¹, art. 'Foundling Hospitals,'

with the authorities there quoted; R. Cleasby and G. Vigfusson, *Icelandic-Eng. Dict.*, Oxford, 1874, under 'Barn-fóstr,' 'Fóstr,' and derivatives; V. Gudmundsson, in H. Paul's *Grundriss der german. Philol.*, Strassburg, 1891, iii. 415 ff., with authorities cited; K. Weinhold, *Altnord. Leben*, Berlin, 1856, p. 285 f.; K. Kaalund, in *Aarbøger for nordisk Oldkyndighed og Historie*, 1870, p. 279 ff.; *Ancient Laws of Ireland*, vol. vi., Glossary, Dublin, 1901, p. 460, s.v. 'Iarraith'; E. O'Curry, *Manners and Customs of the Ancient Irish*, London, 1873, ii. 355, 375; P. W. Joyce, *Soc. Hist. of Anc. Ireland*, do. 1903, ii. 14-18; C. Plummer, *Vitæ Sanctorum Hiberniæ*, Oxford, 1910, i. cvi; J. E. Lloyd, *Hist. of Wales*, London, 1911, i. 310, ii. 549. For primitive peoples, consult the references given by A. H. Post, *Grundriss der ethnolog. Jurisprudenz*, Oldenburg, 1894-95, i. 96-98, ii. 67, 177.

E. J. GWYNN.

FOUNDATION, FOUNDATION-RITES.

—Throughout the lower culture the erection of a new building, or the foundation of a new settlement, is the occasion for certain rites, which may be described as magico-religious, and of which the rites still performed in civilized countries at the laying of a foundation or memorial-stone, or at the consecration of a church or masonic lodge, are the pale and attenuated survival.

1. Choice of site.—The first business is naturally the choice of an appropriate site. Among savage and barbarous peoples this choice is guided not merely by considerations of health or suitability to the occupation (whether hunting, fishing, agriculture, or the rearing of cattle) whereby they gain their means of livelihood, or of safety from enemies or from wild beasts, but also by its acceptability to superhuman beings and the prospect it affords of good fortune. For this purpose recourse is had to divination, the methods of which are various.

The site having been provisionally selected, the Mundas of Chotâ Nagpur dig a hole at each of the four corners and place a small quantity of rice in them, with a prayer to the divinity Singbonga that the test may truly indicate whether the site be good or bad. If the rice is found next morning undisturbed, the omen is good, and with another prayer to Singbonga for a blessing on the site the work of building proceeds (Dalton, *TES*, new ser., vi. [1868] 33). This mode of augury is common in India and Africa. In Africa sometimes, but not always, the omen is reversed, as among the Maravi, west of Lake Nyasa, where a small heap of flour is laid under a tree. If twenty-four hours later it is found undisturbed, the site is rejected as displeasing to the *Wazimo* (ancestral spirits), who decline to partake of food there. But, if the flour has been disturbed, the *Wazimo* have eaten of it, and the choice of site is ratified (Andree, *Ethnog. Parallelen*, Stuttgart, 1878, i. 24).

The foregoing are illustrations of a simple method of divination. When professional diviners are called in, the ceremonies frequently become very complex, and it is impossible to enumerate or even roughly classify them. Attention may, however, be drawn in passing to the Chinese practice, which has elaborated geomancy into a pseudo-science called *feng-shui* (*q.v.*), without which no site is selected for any purpose (de Groot, *Rel. Syst. of China*, Leyden, 1892 ff., iii. 936; Dennys, *Folklore of China*, London, 1876, p. 65). But there are some methods of divination which, followed by uncivilized peoples, have found a place in mediæval times, and among the more backward inhabitants of modern Europe. Animals of good omen for this purpose are met with in many countries.

In Japan a Buddhist temple was erected, under the Emperor Kotoku, on the spot where a white deer was seen quietly moving (*Nihongi*, Aston's tr., Yokohama, 1896, ii. 236). In Germany the Abbey of Herford was erected on a site shown, in answer to prayer, by a snow-white cow bearing a burning taper on either horn; and the site of a neighbouring church was determined in the 11th cent. by a flight of doves (Pröhle, *Deutsche Sagen*, Berlin, 1863, p. 132 f.). Many such sites in France and Germany are alleged to have been chosen by similar indications. The capture of a bear in the forest on the banks of the Aar on Good Friday, 1191, when Duke Berchthold of Züringen was contemplating building a fortress to overawe his rebellious lieges, is said to have decided the site of the town of Berne (*ib.* 160). The contrary case is reported from India, where the village of Ner Pinglai in Berar was built by Nawab Muhammad Khan Miyazi on the spot where, we are told, a hare turned on one of his hounds and put it to flight (*NINQ* iv. [1894-5] 205; cf. 108, and Crooke, *PR*², 1896, i. 100). On the N.E. slopes of the Carpathians the Huzule peasant does not regard every site as lucky, and thus suitable for his house. He is guided in the choice by his cattle, and builds where they prefer

to lie. He avoids the place where red ants make their hill; but a hill of black ants promises good fortune. Like a wise man, however, he will sleep over it, and that on the very spot. If his dreams are fair, especially if of fine cattle, this settles the matter; otherwise he looks elsewhere. Or sometimes he will test the site by leaving on it a glass not quite full of water and covered with a leaf. If on the following day the water has increased, the place is lucky; if it has not, he will avoid it. If these precautions be omitted, the site may turn out to be haunted by evil spirits; and then the house also will be haunted, and mischief will result to the inmates (Kaindl, *Die Huzulen*, Vienna, 1894, p. 29).

Another form of divination is found frequently in French legend, as, for instance, in the story of the foundation of the famous abbey of Cluny, concerning which we are told that the monks were unable to agree where it should be built. The dispute was finally decided by one of them, who was a mason, flinging his hammer; and the abbey was erected on the spot where it fell (Sébillot, *Folk-lore de France*, iv. [Paris, 1907] 114).

A somewhat similar mode is employed by the Southern Slavs. It is not, indeed, employed to fix a site, but to determine whether the hill-spirit will permit the erection on a hillside provisionally selected. The peasant-farmer who proposes to build rolls a flat round cake down the hillside. If it ultimately falls on its face, the hill-spirit which haunts the place is favourable; otherwise the omen is against him, and the farmer must seek another position. The cake here is perhaps an offering to the hill-spirit. In the Austrian Duchy, furthermore, the peasant lays about the chosen site some large stones. Coming three days later, he turns them over to see whether worms are to be found beneath them; and he builds on the spot where that stone lies under which the worms appear. The worms are the messengers of the earth- or hill-spirit who dominates the place, and their presence is a sure indication of his consent (Krauss, *Völkgl. der Südslaven*, Münster i. W., 1890, p. 168).

Throughout N. W. Europe a very common legend relates that the site, especially of a church, was changed by supernatural means. The legend is usually ætiological, and its object is to account for a site the original reason for which has been forgotten. But it often points to the necessity for securing the consent of the local earth-spirits to the erection. This belief appears repeatedly in both legend and custom in many parts of the world. It is brought prominently forward in many stories relating to the elves or fairies, in the British Isles and elsewhere.

In Galloway, for example, 'when the new house at Greenan was being founded, a woman appeared and asked the masons and others taking a hand in the work to change the site. She told them that the house on that site would be right over her dwelling, and in consequence much annoyance and inconvenience would be caused to her and her household' (*Rep. Brit. Ass.*, 1897, p. 491). In Sweden great care is taken to avoid a spot haunted by the underground folk. The builder must go to the chosen place, make known his purpose in a loud voice, and ask permission; and the day before he intends to begin work he lays his tools and materials there. If the underground folk agree, the noise of people busy with hammering and hewing will be heard in the silence of the night. In the Faroe Islands an instrument as modern as the compass is laid on the site. According to its behaviour it is ascertained whether the *Huldre* dwell there; if they do, they must not be disturbed (*Zeitschr. d. Vereins f. Volksk.* viii. [1898] 274, 273).

Sites in Europe and elsewhere, especially for churches, are said to have been indicated by the direct command or the apparition of supramundane beings, such as the Virgin Mary. Or an image is found in a certain spot and cannot be removed. It is needless to refer here to instances. Sometimes the Divine will is shown by a flame or light seen in a bush, as in the case of the Monmouthshire church of Llantilio Bortholly (*Parochialia, Arch. Cambr.*, 6th ser., xi. [1911], Suppl. 38, 71). Some of these sites, such as that of the famous shrine of Our Lady of Guadalupe, near the city of Mexico, may have been places of pagan worship, converted to Christianity in accordance with the well-known policy of the Church.

2. Appropriation of the site.—The site being chosen, the next business is to appropriate and exorcize it, and incidentally to mark it out. Among the Basuto, when the village, or *kraal*, as it is often conveniently termed, is to be removed, the chief drives into the ground a peg covered over with

charms to nail the village firmly to the soil of the new site, and in order that neither war nor any other misfortune may distress the inhabitants and force them to change their abode. This is a formal and religious act, and probably attended with ceremonies which our authority has unfortunately not thought proper to recount (Casalis, *The Basutos*, Eng. tr., London, 1861, p. 124). Among the A-Kamba of East Africa (like the Basuto, a Bantu people), when a new village is founded, a medicine-man is generally consulted, and, having satisfied himself by divination that the site chosen is lucky, he kills a goat and walks over the rough outline of the village, sprinkling it as he goes with the goat's blood and the contents of its stomach. The fence of branches surrounding the site is then put up. The head of the village, and his family camp in temporary shelters inside the fence for several nights before beginning to build the huts. On the second and fourth nights of their preliminary occupation the head of the village must cohabit with his wife—doubtless as a magical rite to obtain prosperity, and increase in cattle and crops, as well as in the human population (Hobley, *Ethnol. of A-Kamba*, Camb. 1910, p. 58). The circumambulation of the site as performed by the medicine-man of the A-Kamba is also a magical rite. In Siam, when the ground for the erection of a Buddhist temple is first dedicated, eight *luk nimit*, or round marking stones, are sprinkled with holy water and buried, to mark the limits from which evil spirits are warned off (Alabaster, *The Wheel of the Law*, London, 1871, p. 272 n.). Doubtless the priest performs the sprinkling by walking the boundary. The Etruscans, on founding a city, ploughed with a cow and a bull a furrow round the limits; and we gather from Ovid's account of the *pomerium* of Romulus that the animals yoked to the plough were white (*Fasts*, iv. 826). To some such rite as this, misunderstood by later ages, we must attribute the numerous legends assigning, as the extent of lands given for various purposes, the quantity that the recipient could walk or ride round in a day. Thus Coirbri, when a fugitive from the south of Munster, was given by his son-in-law Aedh, king of Connaught, as much of certain wooded lands as he could pass round in one day. As in all these stories, the extent of the land thus acquired was much greater than the donor anticipated, and led to subsequent trouble (*Annals of the Four Masters*, Dublin, 1851, iii. 239 n.). Variants of the tale are by no means confined to Europe.

The most famous of all is perhaps the Hindu legend of Vishnu, who appeared to Bali in the form of a dwarf mendicant and begged three paces of his vast kingdom. The boon was granted contemptuously. Forthwith the dwarf with his first step measured the earth, with the second the skies, and there was no space left for the third. Bali submitted to the god, and was made the judge of the dead (Southey, *The Curse of Kehama*, quoting in a note Sonnerat's *Voyages*. The ultimate literary source is the ancient poem of the *Harivamsha*).

Of similar origin are the stories which represent the quantity of land as to be enclosed by a bull's hide. It is cut into very thin thongs, and the area is thus rendered unexpectedly great. The earliest example of this is the tradition of Dido, who obtained the site for Carthage in this way. Parallel tales are found in Britain and Scandinavia, though not without suspicion of literary influence—a suspicion, having regard to the legend of Gefjon's Ploughing, not entirely deserved. The legend is also current among the Tatar tribes of Siberia, and as far to the east as China. There, in one version, the settlers are Spaniards, in others Dutch; and to the Dutch and Portuguese is attributed a similar trick in India and Cambodia. The incident is even told by the Hottentots of the first settlement of the Dutch at the Cape of Good Hope (Arbousset and Daumas, *Exploratory Tour in S. Africa*, Eng. tr.,

Cape Town, 1846, p. 25). The kind of rite to which these legends point may be illustrated from the practice of the Bechuana in founding a new town.

A bull is taken, its eyelids are sewn together, and, thus blinded, it is allowed to wander at will for four days. It is then killed where it is found, roasted, and eaten on the spot. The witch-doctors take the skin, and, after it has been marked with certain appropriate markings and 'medicine,' it is cut into one long spiral thong. This thong is finally divided into lengths of about two feet. One of the lengths is pegged down in each of the paths leading to the new township. 'After this, if a foreigner approaches the new town to destroy it with his charms, he will find that the town has prepared itself for his coming' (*JAI* xxxv. [1905] 308 f.). It is clear that we have here a mystic rite intended for the protection of the town and its inhabitants.

Among some of the Kaffir tribes of South Africa the medicine-man formally disenchanting the site before the work of building was begun (*Mélusine*, x. [1900-01] 70, citing Magyar, *Reisen in Süd-Afrika*, Budapest and Leipzig, 1859).

The practice of the Yaos and Manganja about Lake Nyasa prescribes that the chief, with his brother and the medicine-man, shall rise at dawn. Walking round the site, they tie the grass tufts into little knots, smearing them with medicine. At the spot where the *Kuka* hut is to be erected they take fire and put 'medicine' upon it. Then, taking water, they blow it in a spray from the mouth. This is to guard the village from lions and cannibals. The people then bring the building materials, and clear the ground (Rattray, *Folklore in Chinyanja*, 1907, p. 109).

Among the Ho tribe of Ewe, a Negro people of West Africa, a big mound is cast up. The priest then takes four cowries in his hand, mixes meal and water in a calabash, and prays 'the earth which they have just found' (possibly the *genius loci*) for favour and human fecundity, and that nothing evil may happen. He pours the meal and water on the ground, praying the earth to be soft, and throws the cowries upon it. If they, or even two of them, fall with the opening upwards, the augury is favourable. When the site has been cleared and prepared for building, 'medicine' is made and sprinkled on the earth, and the people all wash their faces with it, and are asperged with holy water. Lastly, an offering of meal is made to the earth for favour (Spieth, *Die Ewe-Stämme*, Berlin, 1906, p. 367).

In some of the Moluccas, where the population is Muhammadan, a ceremony which, like that of the Ewe, is called by our authorities 'consecration' is performed.

On the day of the new moon the owner's wife measures a piece of rope with her 'fathom'—that is, presumably, the length of her outstretched arms—and gives it to her husband, together with a bottle of water and an egg. The rope is rolled up and laid partly in the ground, with the bottle and the egg. The owner invokes the prophet Loqman the Wise, and explains to him that these objects are placed there to obtain an augury. He watches all night. If a dog approaches, it forebodes quarrels in the house; if a cat passes by, it means sickness. If neither of these contingencies occurs, and if next day the rope is found of the same length, the bottle still full, and the egg uncorrupted, the omens are favourable, and the work proceeds. This rite would seem to be not merely a consecration, but an endeavour, like some of those previously discussed, to ascertain the will of the higher powers (Riedel, *De sluik- en kroesharige rassen*, The Hague, 1886, p. 160).

Nor is consecration of the site, even of ordinary dwelling-houses, unknown in Europe. In some parts of Germany pious people of the old faith still sprinkle the site with holy water and bless it. Formerly a priest performed this function; and by its means all evil, all ghosts and demons, were exorcised (*Globus*, xci. [1907] 335, quoting Montanus, *Die deutsche Volksfeste*, Iserlohn, 1854-58). Consecration (*q.v.*) of sacred sites is, of course, well known. It is not a specially Christian rite, but has descended from much more archaic times and practices.

3. Laying the foundation.—When the site has been appropriated, it is cleared and levelled. The next step is to collect the materials. This is often done either by rule, or in accordance with the directions of a priest or medicine-man after divination; and certain rites must be observed. It is begun on a day declared lucky, or (where astrology is practised) according to the calculations of the astrologers. Except among highly civilized peoples, where more substantial materials are easily obtainable, or in the case of very important buildings, the fabric is usually of timber. If a block-house, as frequently among the peasantry of Europe, the lower beams constitute the foundation. Otherwise the

stability depends on the centre-poles or the corner-poles; and it is consequently about their erection that ceremonies tend to aggregate. Such ceremonies to procure stability may be roughly divided into those whose object is: (a) to scare away evil spirits and destroy spells; (b) to conciliate the local spirits; (c) to provide a new tutelary power.

Among many peoples the house must face in a particular direction, frequently to the east. On some of the Moluccas it faces the east, in order not to offend the divinity Upulero (Riedel, 380). In the State of Manipur (India) it is the rule of some of the Nāgā tribes that the house must not face the west, because that is the direction taken by the spirits of the dead. As showing how utilitarian sometimes coincide with superstitious considerations and render it difficult to distinguish the real origin of a practice, it is to be noted that the prevailing wind is westerly, and it would, therefore, enormously increase the danger of fire to build the house fronting in that direction (Hodson, *Naga Tribes of Manipur*, London, 1911, p. 43). The custom of many North American tribes is to place the encampment with its entrance to the east. This was always done among the Omaha when the tribe encamped for tribal ceremonies; while at other times, if the entrance was not actually in that direction, it was always symbolically so reckoned, and the position of the various clans relatively to it was the same (Fletcher, *27 RBEW* [1911], 137). In the lower culture the plan and erection are always traditional, and it would be a serious breach of custom to depart from them. When a chief of the Bechuana chose a site and fixed the place of his own dwelling and the public cattle-kraal, each of his tribesmen knew the relative position of his own hut (Mackenzie, *Ten Years North of the Orange River*, Edinburgh, 1871, p. 367).

(a) To scare away evil spirits and destroy spells.—Some of the ceremonies at the foundation of a house or more important building are in themselves apotropaic.

The Tlingit, as appears from one of their recorded traditions, cut the large trees for the timbers of a feast-house fasting; and, while it is being completed, the drum is beaten continually (Swanton, *Tlingit Myths and Texts*, Washington, 1909, p. 335). The Japanese ritual for the building of a royal palace prescribes that the ground is to be levelled and cleared by young virgins; with a sacred spade they are to dig holes for the uprights; with a sacred axe they are to make the first cut in the trees selected for the timbers; and at the completion a ceremony is performed at the gates, in the course of which the names of the gods who watch over the house are repeated by the officiant (*TASJ* ix. [1881] 190 ff.). In building a house the Baganda begin from the roof. The apex is a ring of cords bound together, and into this the reeds for the roof are stitched. The workmen who made the rings for the royal houses were required to live apart from their wives while they were at work; and no one might come near them or touch the work (Roscoe, *Baganda*, London, 1911, p. 370 f.). The sprinkling of 'medicine' in the ceremony practised by the Ho tribe has already been mentioned (§ 2). In the neighbourhood of Dinant, in Belgium, the owner of a new house dips a box-twig, which has been blessed by the priest, into holy water and asperges the foundation-stone before laying it, and the twig is built into the wall (*RTP* ix. [1894] 563). The virtues of holy water, both heathen and Christian, are well known.

Near Goslar, in Protestant Germany, a tale is told of a master miner bold who successfully explored a vault belonging to the mountain-folk and wrested from them a silver goblet. He sold the goblet, and applied the proceeds in building a new wall to his kitchen. But, as soon as the fire was kindled, the wall fell in. When this had happened several times, he consulted the parson, by whose advice he bought a new Bible and built it into the wall; and the wall stands to this day, though the owner and his family have died out (Pröhle, 80).

In some parts of the Scottish Highlands 'there should be placed below the foundation of every house a cat's claws, a man's nails, and a cow's hoofs, and silver under the door-post. These will prove omens of the luck to attend the house' (J. G. Campbell, *Superstitions of the Highlands*, Glasgow, 1900, p. 281). In Sussex a bottle containing pins is buried beneath the hearthstone to ensure safety from witchcraft (Henderson, *Folks of Northern Counties of Eng.*, London, 1879, p. 232). In Lincolnshire an animal's heart stuck full of pins was regarded as a great protection (*FL* xii. [1901] 176). In Ceylon, four pebbles and four silver coins should be charmed, and one of each buried at each corner of the site. Precious stones of poor quality may be

substituted for the pebbles with advantage, since they attract the 'sight' of gods and benevolent demons (*JRAI* xxxviii. [1908] 190).

The Huzules lay incense, money, salt, and bread under the lower beams of their blockhouses towards the interior, and towards the exterior charcoal and mortar from a baking oven. The former objects are regarded as luck-bringing, the latter as efficient against enemies, probably spiritual. We may, however, perhaps see here a relic of the custom of bringing fire from the old house (Kaindl, 31). Salt and bread are widely regarded among comparatively civilized peoples as valuable talismans, the former as driving away evil influences, the latter as bringing plenty. They are among the first objects to be brought into a new house; and salt is commonly placed on the breast of a corpse while it is lying in the house. Money, like bread, and doubtless for similar reasons, is pre-eminently lucky.

When Pope Julius II. in full canonicals laid the foundation-stone of the citadel of Civit  Vecchia, he spread mortar in the form of a cross (an apotropaic spell) and put under the stone a vase full of coins (*RTP* ix. 90, citing Bonanni, *Numismata summor. Pont.*, Rome, 1696). During the viceroyalty of Lord Dufferin, Lady Dufferin laid the foundation-stone of a hospital in India and put underneath it coins, together with a little golden serpent, an infallible charm for the building (*RTP* vii. [1892] 489, quoting Lord Dufferin's *Four Years of Viceroyalty*, ii. 231).

Pre-historic celts and arrow-heads are amulets wherever the Stone Age has been forgotten in the march of civilization. In France they are constantly found buried beneath the foundations or in the walls of houses, or even churches, as preservatives against thunder or fire; or they are kept in the house for the same purpose, or hung up in the stables and outhouses to secure the domestic animals from disease. They are also worn on the person or stuck into fruit-trees (S billot, iv. 70).

Various plants, too, are held to be prophylactic. The consecrated box-twig at Dinant has already been mentioned. On the island of R gen a juniper-bush is laid in the foundation to keep out the devil and evil spirits (Kuhn, *Sagen, etc., aus Westfalen*, Leipzig, 1859, ii. 60). On the island of Serang in the Moluccas, beneath the spot where the sleeping apartment will be, health-giving herbs and roots are buried to keep off evil spirits (Riedel, 119). Sacrifices of men or animals will be discussed below. Independently of sacrifice, however, blood has a well-recognized magical value. The Ottoman Jews, on digging a well, cut the throat of a cock and allow three drops of blood to fall into the excavation in order to destroy the effect of any talisman which might cause it to fall in (*Melusine*, viii. 281). To the blood of fowls, among other substances, the Nicobarese ascribe occult virtue; they smear their houseposts, or even their own bodies, with it, either alone or mingled with various powerful ingredients, for protection against evil spirits (*Intern. Archiv*, vi. [1893] 13). In Aberdeenshire the first stone laid is that behind the fireplace. A chicken is struck upon it until it is covered with blood. This will ensure that the pot boiling on the fire will always be well filled, so long as he for whom the house is built occupies it (Gregor, in *RTP* vi. [1891] 173). It is said that the mortar used to build the Tower of London was tempered with the blood of beasts (*NQ*, 7th ser., vi. [1888] 350, quoting Fitzstephen's *Survey of London*, London, 1598). Blood is prescribed for this purpose in many places; whether it is actually used is another question. Not very long ago a builder at Brooklyn went to much trouble and expense to try the experiment with bullock's blood; but the results did not justify the outlay (*ib.* vii. 13). Like all barbarous customs, the use of blood tends to the adoption of a milder expedient. One of the traditions relating to the bridge in the Kuventhal, Lower Saxony, affirms that a bottle of wine is walled up in the founda-

tion (Schambach-M ller, *Nieders chs. Sagen*, G ttingen, 1855, p. 18). To this origin we may attribute the breaking of a bottle of wine against the bows of a ship in the ceremony of launching.

(b) *Sacrifices*.—In cases like those hitherto examined, the shedding of blood seems not to have a sacrificial object, but to be performed for the prophylactic virtue of the blood itself. More numerous, however, are the instances in which it constitutes a sacrifice. In connexion with this we shall find that life, whether of men or of the lower animals, is not the only form of sacrifice at the foundation of a building.

Sacrifices are sometimes offered to ancestors on these occasions. In German South-west Africa, when a man dies at a *werft*, or village, the *werft* is abandoned and a new one founded. If he has been a man of importance, he is buried in the cattle-kraal of the old *werft*. After a lapse of years the people often return to the former site to rebuild there. The holy fire of the *werft* where they have been living in the meantime is extinguished, in order that new fire may be made with fire-sticks in the sacred manner on the site to which they are returning. Before doing this, they invoke the deceased chief of the *werft*, calling themselves his children and telling him they have done as he ordered. When the new sacred fire has been made, it is the custom to slaughter a sheep as a sacrifice before the huts are put up (*S. Afr. Folklore Journal*, i. [1879] 61). On the island of Buru in the East Indies, as soon as a site has been decided on by divination, an offering to ancestors is made (Riedel, 12).

This also seems to be the explanation of an obscure Maori custom. 'The ground-plate which supports the house is carved to represent the prostrate figures of slaves who had been sacrificed; on them the figures of ancestors stood.' Taylor (*Te Ika a Maui*², London, 1870, pp. 36, 502) explains this as referring to 'an extinct custom of killing human victims and placing them in the holes made to receive the posts, that the house, being founded in blood, might stand.' The crushing of human victims beneath the pillars of a new building is, as we shall see hereafter, capable of another explanation. But, if it were really a sacrifice here, it would without doubt be a sacrifice to ancestors.

More usually, however, it is to divine beings or to local or earth-spirits that the sacrifice is offered. In India the examples are very numerous. Only a few can be referred to here; some others will be considered later.

The Kols of Chot  Nagpur offer an egg to the good god Singbonga, the yolk being his symbol (F. Hahn, *Einf hrung in das Gebiet der Kolsmission*, G tersloh, 1907, p. 91). When the fort of Lohagad was built, a Maratha offered his son and his son's wife to be buried under the foundation, because the king was warned in a dream that 'the favour of the god of the hill was won by burying alive a man and a woman' (*BG* xviii. pt. iii. p. 249).

The practice of slaughtering an animal on such occasions is firmly rooted throughout the west of Asia and the north of Africa.

The Arabs of Moab, east of the Dead Sea, thus endeavour to pacify the *jinn* (who are regarded as malevolent spirits) whenever a tent is set up in a new place. As soon as the tent is fixed, a fat sheep is taken, its head turned to the south, and its throat cut with the words, 'Permission, O possessor of this place!' This is a request for authority to enter the tent and to dwell there. Part of the blood is received from the victim in a bowl. With it the master of the tent anoints the centre-pole; and sometimes the goat-skin curtain closing the entrance on the west side is also asperged with the blood. The half-sedentary Arabs of the same country make a similar offering at the building of a house, first on putting up the vault, again on the threshold when the lintel is laid, and once more on the threshold at completion. The practice even extends to Christians of the Greek and Latin communions (Jausen, *Coutumes des Arabes*, Paris, 1908, p. 339 ff., cf. 319).

Analogous to this was the ancient Roman custom on fixing a boundary stone. A victim was killed and offered as a burnt sacrifice. Fruits of the earth, together with the bones, ashes, and blood of the victim, were put into a hole, and the boundary stone was rammed down upon them. It has been suggested with probability that the

annual festival of the *Terminalia*, in the course of which a lamb and a sucking pig were slain and the boundary stone sprinkled with their blood, was a renewal of the rite with which the stone was originally fixed in its place (Fowler, *Roman Festivals*, London, 1899, p. 325). In the east of Europe a lamb or, as an alternative, a cock is commonly sacrificed; for, according to a popular adage in Greece, 'there must be blood in the foundations.' The object of the sacrifice seems to be to propitiate the *στρογγύον*, or familiar of the spot (Rodd, *Customs and Lore of Mod. Greece*, London, 1892, p. 148).

The Sea Dayaks of Borneo, when removing a village, kill a fowl or pig for every family before digging the holes to receive the posts. The blood is smeared on the feet and sprinkled on the posts to pacify Pulang Gana, the tutelary divinity of the earth (Roth, *Natives of Sarawak*, London, 1896, ii. 15; cf. 215). The Milanaus in N.W. Borneo seem originally to have offered a human sacrifice to the earth-spirit (*ARW* xii. [1909] 140). In the Malay peninsula brazil-wood, ebony, and scrap-iron are deposited in the hole for the centre-post. The last is possibly apotropaic. A fowl, goat, or buffalo is sacrificed by cutting its throat, and the blood is spilt into the hole, or an egg is deposited in it (Skeat, *Malay Magic*, London, 1900, p. 143 f.).

In the New World, similar sacrifices appear to have been made, though the exact object is not quite so clear. The Mazatecs in Southern Mexico, for instance, dig a hole beneath the place intended for the fireplace, and bury there cacao-beans, eggs, and small chickens, 'to secure good fortune' (Starr, *Ethnog. of Southern Mexico*, i. [1900] 79). In Guatemala, the Kekchi Indians, when building a communal house, slaughter a pig at midnight and smear the posts and beams with its blood (*ARW* vii. [1894] 465).

In Africa, when the foundations were laid of a European house, built by some German missionaries and other prisoners for the king of Ashanti before the taking of Kumasi, a sheep was slain, and the blood sprinkled on certain places with prayers to the 'Fetish' (Ramseyer-Kühne, *Four Years in Ashantee*, ed. London, 1875, p. 226). When Tako-donu, the founder of the Kingdom of Dahomey, conquered the Foyas about the year 1625, he took Da, their king, put him to death, and built his palace upon the victim's body, whence the palace and ultimately the kingdom were called Dàwhomi, 'Da's belly' (Ellis, *Ewe-speaking Peoples*, London, 1890, p. 279 f.).

It is perhaps open to doubt whether this last was literally a sacrifice, or a ceremony such as those described in the following section. The same question does not arise as to the practice in Polynesia, where human sacrifices were not uncommon. At Maeva, for example, such sacrifices were performed at the foundation of temples. The central pillar of one of these was said to rest upon the body of a man who had been offered as a victim to the sanguinary deity worshipped there (Ellis, *Polyn. Researches*², London, 1831, i. 346). Similar rites were practised in Melanesia (Codrington, *Melanesians*, Oxford, 1891, p. 301).

In Western Europe numerous cases are reported from Brittany and Belgium where an animal has been killed and the foundations sprinkled with its blood. Usually the animal is a domestic fowl; but in the Morbihan it is said that at the building of a house or a church an ox would be killed, and its blood offered to the earth-spirits, that they might not destroy the building. A pair of fowls was often offered. They were feathered and buried in the middle of the site. Afterwards they were dug up to ascertain whether the sacrifice was accepted. This would be deemed to be the case if they were found eaten by worms. In Anjou and Maine the custom of burying in the foundations a small living animal, such as a frog, was continued to very recent times (*RTP* vii. 37, 179, ix. 564; Sébillot, iv. 90 f.). So in Leitrim, Ireland, it was usual to kill a hen and allow the blood to drip into holes at the four corners of the house (*FL* x. [1899] 118). Remains pointing to the practice of killing and burying animals have been discovered in Germany, in pulling down old houses (*Am Urquell*, iii. [1892] 165). The dried bodies of cats found so frequently walled up in old houses both in this country and on the Continent point to their having been immured alive. The hypothesis derives probability from the belief that every new building must have

a victim, in order that human life may be preserved. This belief is at the root of the numerous legends in which the erection of a bridge is undertaken by the devil, with the stipulation that he is to have the first living being (or soul) who crosses it, but he is usually outwitted with a dog or a cat. The devil of Christian belief here doubtless replaces the river-spirit of pagan Animism (see art. BRIDGE, in vol. ii. p. 851). The same belief applies, however, to other constructions.

Many legends of human sacrifice in India relate to the erection of embankments or the excavation of tanks and artificial lakes. In the government of Jaroslav, Russia, there is a story of a miller who used to seize and drown in his mill-pond a belated wayfarer to keep the water-spirit in good humour and prevent the weir from being washed away by the spring floods (Löwenstimm, *Aberglaube und Strafrecht*, Berlin, 1897, p. 16). Among the Masurs, about Gilgenburg in Eastern Prussia, the first living thing that enters a newly built house must not be a human being, for Death lurks there for his prey. It is customary, therefore, to fling a dog or cat first into the house (Toeppen, *Aberglauben aus Masuren*², Danzig, 1867, p. 90). At Liège a cat was formerly shut up in a new house to die of hunger before any one else entered; for, when any living creature has died in a house, it is believed to be a guarantee of the life of the rest (Monseur, *Le Folklore wallon*, Brussels, 1892, p. 115). Such practices are, in fact, found all over Europe. The Russian peasant believes that the building of a new house is apt to be followed by the death of the head of the family (Ralston, *Songs of the Russian People*, London, 1872, p. 126)—a belief found in Galloway in the vaguer form that it is 'unlucky for one to build a house to live in' (*Rep. Brit. Assoc.*, 1897, p. 463). Among the Ewe, the Ho tribe think that whoever first enters a new village must die; hence the old people are sent in before any one else (Spieth, 370). The Yoruba send two slaves to sleep the first night in a new house, to break the enchantments of the evil spirit Akalasho (Andree, i. 25). In Russia, where slaves are not available, a specially bold person, generally a relative of the owner or a servant, is chosen for this purpose. If nothing untoward happens, and he has no bad dream, the house is safe (*Globus*, lxxxvi. [1905] 51). Or, as among the Ho, the oldest member of the household enters first (Ralston, *loc. cit.*). It is not an unusual thing in the west of Europe for the curé to attend to sprinkle holy water and bless the house, in order to exorcize the evil spirits and prevent the death of the house-master during the following year (*RTP* xii. 332; Harou, *Le Folklore de Godarville*, Antwerp, 1893, p. 195). In the Sandwich Islands, offerings being made to the gods, presents were also made to a priest, who entered the house with prayers and other ceremonies and slept in it before the owner took possession, in order to keep away evil spirits, and secure the inmates from the effects of incantations (Ellis, *Polyn. Res.* iv. 322)—a practice followed also in some parts of Melanesia and West Africa.

In course of time sacrifices of living victims, whether human or not, are frequently commuted for something which merely symbolizes the real intention. Thus in Germany, and indeed in other European countries, the skulls or hoofs of horses, querns, and pottery and vegetable remains have been repeatedly found beneath the walls of buildings. In Ireland, horse-skulls have been found, as well as broken querns, buried beneath houses or in recesses of the walls (*FL* xxii. [1911] 54). In Lincolnshire the old-fashioned jugs known as 'greybeards' are sometimes found embedded beneath the foundation, the threshold, or the hearth-stone of ancient buildings (*FL* xii. 176). Among the Saxons of Transylvania a human bone used to be buried beneath the floor to give stability to the building (von Wlislöcki, *Volksgl. und Volksbr. der Siebenbürger Sachsen*, Berlin, 1893, p. 202). In the middle of last century, when Corgarff Castle, Aberdeenshire, was demolished, it is said that the workmen found in the foundations a fragment of a skull wrapped in a red material. And Dr. Gregor discovered some evidences of a former custom, on the erection of important houses in Ross-shire, for the workmen to seize the first person or animal they met in the morning on going to work, and to touch his head with the first stone to be laid (*RTP* ix. 563). In taking down old Blackfriars Bridge (built in 1760-1768) for the purpose of rebuilding in the year 1867, the engineers discovered, under the foundations of the second arch on the city side, and fifteen feet below the bed of the Thames, a quantity of bones of cattle and sheep and some

human bones. On these the foundations had been laid (Liebrecht, 285, citing *Illustr. London News*, 2nd March 1867). In mediæval times, if not later, at Rome it was the custom to bury ancient statues—the smaller whole, the larger smashed to pieces—under the foundation. Between 1872 and 1882 no fewer than 200 statues and busts were found on the Esquiline alone, buried in this way; and doubtless many more have been since recovered (*FLJ* i. [1883] 23, quoting a communication by Signor Lanciani to the *Athenæum*). Other surrogates will be referred to below (p. 115^a).

Many substances, however, put beneath a foundation have their own proper value as offerings. Thus a favourite offering in the Moluccas, by way of propitiating the divinity of the earth, is gold or silver—either in dust or small pieces—food and *sirih-pinang* (Riedel, 63, 200, 225, 255, 286, 423); and in the Pueblos of New Mexico sacrificial deposits of turquoise and shell-beads have been found (*Amer. Anthr.*, new ser., ii. [1900] 169).

(c) *The provision of a guardian spirit.*—Numerous legends relate that on the construction of an important work such as a palace, a bridge, an embankment, or a city wall, the building repeatedly fell, until a living human being was buried in the foundations; or that such a victim must be obtained to render a fortress impregnable. In the Balkan Peninsula and adjacent parts of the Levant the tale is the subject of many ballads, of which the best known is perhaps that of the Bridge of Arta. Generally the victim is the master-builder's wife, but in the most piteous of all an innocent child is walled up; often it is a virgin or a beggar-boy, in one case a student. These legends are most numerous in Germany, the East of Europe, and India; but they are also found in the west of Asia, North Africa, throughout the European continent, and in the Celtic parts of the British Isles. Specimens have been discussed in the article already referred to (*ERE* ii. 850). Nor are they unknown on the American continent. The Shuswap believe that the beaver, when constructing a dam, kills one of its young and buries it beneath the foundation, that the dam may be firm (*Rep. Brit. Assoc.*, 1890, p. 644). It is common in tales of the N. W. tribes, and indeed a matter of actual practice, that, when a chief or great man built a house, captives and slaves were put to death and the house-posts reared upon their bodies; others were buried beneath the fireplace or the totem-pole in front of the house (Boas, *Ind. Sagen*, Berlin, 1895, p. 186; *JAF* vi. [1893] 51; *Rep. Nat. Mus.*, 1895, p. 357; *26 RBEW* [1908], 437). In central America the incident is mentioned in the *Popol Vuh*; probably, therefore, the practice was not unknown. In S. America the palace of the Bogota, ruler of the Chibchas, was believed to rest upon the bodies of maidens (Liebrecht, 287; cf. *Anthropos*, v. [1910] 1166).

So deeply engrained are these stories and the beliefs which they imply in the popular mind that in modern times and civilized countries public scares have repeatedly arisen at the erection of great architectural and engineering works.

In India they have recurred many times within recent years, notably at the building of the Hooghly Bridge and the construction of the Calcutta Harbour Works and the new waterworks at Delhi. At the building of the cathedral at Shanghai it was said that the municipal council required a certain number of human bodies to bury beneath its foundations; and for a week people were afraid to go out by night, especially near the site. There was a similar scare in the north of China during the construction of the Manchurian railway. If in our pride we deny that these populations are civilized, let us remind ourselves that such scares have arisen in Germany, as when the bridge at Halle (finished 1843) was built (Grimm, *Teut. Myth.*, London, 1880-88, p. 1142), and during the construction of railways; that it was seriously believed by some people that a man had been thus buried beneath one of the towers of the great bridge between New York and Brooklyn (*NQ*, 7th ser., vii. [1889] 13);

and that Lord Leigh, barely half a century ago, was accused of having built an obnoxious person (some people said eight!) into the foundations of a bridge at Stoneleigh (Liebrecht, 285, citing *Nature*, 15 June 1871).

No adequate explanation of legends and scares like these is feasible in the absence of a widespread custom which deeply impressed the popular imagination. Such a custom was not only once common; it is not yet abandoned among barbarous nations. Without going further afield than Turkey, it was reported by the correspondent of the *Echo de Liège*, on 1st Oct. 1865, that, when building a new blockhouse at Duga, near Ragusa, the Christian workmen who were engaged on the work caught two Musalmān soldiers in the act of preparing to bury two young children alive in the foundations. In many cases we have seen that the victims are regarded as a sacrifice to a god or spirit, while in others a magical virtue is attached to their blood. But there is yet another reason. The vague intention expressed in many of the legends to render the building stable or impregnable conceals the purpose, expressed more clearly in the accounts we have of actual sacrifices, to provide a supernatural guardian, a daemon, to watch over it.

Thus when a new gate was made or an old gate was repaired in the walls of Bangkok, it used to be customary to crush three men to death under an enormous beam in a pit at the gateway. Before they were led to their doom, they were regaled at a splendid banquet: the whole court came to salute them; and the king himself charged them straitly to guard well the gate that was to be committed to their care, and to warn him if enemies or rebels came to assault the city. The next moment the ropes were cut and the beam descended on them. The Siamese believed that these unfortunates were transformed into the genii which they called *phi*' (Frazer, *GB*³, 1911, 'Taboo,' 90).

The same purpose is explicitly attributed to similar practices prevalent in Burma up to the date of the British conquest. The notion that a human being put to a violent death becomes a powerful daemon is extensively believed. Nor is such a being necessarily hostile to the murderers; it may be, at any rate, propitiated and its friendship secured. The East Indian practice of head-hunting is an attempt to convert an enemy or a stranger into a supernatural protector. The well-known legend of St. Romuald, whose reputation was so great that the community proposed to secure him in perpetuity as a tutelary saint by putting him to death and thus obtaining possession of his relics, is typical of many tales localized from China to the Atlantic. And the same notion is probably—to some extent, at least—responsible for the veneration of the relics of Christian and Muhammadan martyrs. Mighty kings and heroes are sometimes buried on the boundary of the kingdom, to ward off attacks by their supernatural power.

Thus, according to the Norse Saga, Ragnar Lodbrog's son Ivar, dying in Northumbria, was buried by his own desire where his realm was most exposed to attack. Nor could William the Conqueror penetrate the territory until he had dug up Ivar's body and burnt it to ashes. In the *Mabinogion* we are told that, when Bran the Blessed, invading Ireland, was wounded to death with a poisoned dart, he commanded his men to cut off his head and take it to the White Mount, in London, and there bury it with the face toward France. When they did so, 'no invasion from across the sea came to this island while the head was in that concealment' (C. Guest, *Mabinogion*, London, 1877, p. 383). Eoghan Bell, king of Connaught, was similarly interred for the protection of his kingdom.

The custom of living burial for the same purpose was, if we may believe Irish traditions, which are no doubt accurate on this point, carried over into Christianity in connexion with the foundation of monasteries. Oran, one of the companions of St. Columba, offered himself, or the lot fell on him, to be buried alive under the monastery of Iona. Clonmacnois was consecrated by the similar burial of a leper who was in St. Patrick's retinue. The protective purpose does not definitely appear, it is true, in these stories. It is clear in the case of the

sisterhood at Cill Eochaille, founded by St. Senan of Inis Cathy. They entreated Senan that the body of a lowly monk of his community might be given to them 'to be buried by us, so that his relics may protect us.' Senan replied: 'Verily this shall be granted to you. Be in no distress as to one from whom your protection shall come' (*Arch. Cambr.*, 5th ser., xvii. [1900] 256). Probably in this case the monk was not buried alive. However that may have been, bodies or human skeletons are often found built into the foundation or the walls of churches in this country and on the Continent; and it has been conjectured that in the practice to which these discoveries point we have a relic of the belief now under discussion. The conjecture seems well-founded; but in the later Middle Ages, at all events, such burials, unless of persons renowned for sanctity, and even perhaps in their case too, may have been carried out without any definite reason beyond compliance with custom. Numerous tales of burial in the wall, whether inside or outside the church, in order to avoid the consequences of a pact with the devil, and of persons walled up alive by way of punishment, may have been founded on the custom when its origin had been forgotten.

We have already seen that in Russia the head of the household is liable to death on building a new house. In this connexion it is important to note that the *Domovoj*, or household spirit, is the soul of the founder of the homestead (Ralston, 122, 126; cf. DEMONS AND SPIRITS [Slavic]). The Roman legends of the slaughter of Remus by his brother Romulus and the self-sacrifice of Curtius, as well as the numerous tales, East and West, of the architect of a building put to death by the king, that he might not eclipse the achievement by any future work, have been referred upon plausible grounds to the rite by which a human victim becomes the tutelary spirit.

For the purpose of this rite, as for others, surrogates have frequently been provided for human victims. The statues found beneath buildings at Rome have already been mentioned. If we may believe Olympiodorus of Thebes, during the reign of the Emperor Constantine there were dug up in Thrace, on the Illyrian frontier, three silver statues in barbaric costume, with their hands bound behind their backs, which must have been buried for prophylactic purposes; and he notes that, shortly after they were found, the Goths, Huns, and Sarmatians invaded Thrace and Illyria (Liebrecht, 289). Whatever credit we may give to this story, it is quite certain that, as everywhere in the lower culture, magical virtue was attached during the Middle Ages to an effigy, and many stories illustrative of the superstition have got into literature. Its use in witchcraft is well known. A statue was frequently supposed to be possessed of a god or spirit who, unless a personage celebrated in Christian hagiology, was necessarily regarded as evil. The belief is still applied to the consecration of a house in some parts of India. The image of *Vāstu*, or the *genius loci*, is placed in a box face downward and buried in a pit near the foundation pole (*BG* xx. 525; cf. Crooke, *PR*² i. 102). In this way the genius is secured and effectually prevented from escaping.

Even easier modes of identification with the intended victim are practised. In Europe, in modern times, the ignorant populations of the Balkan Peninsula and adjacent islands would continue the rite of burying a human being beneath an important building, if the law permitted them to do so. Since it is forbidden, a man is sometimes enticed to the spot, his body, or simply his shadow, is measured, and the measure is buried under the foundation-stone, or the

stone is laid upon the shadow. It is believed that he will die within the year, or, as it is said in some places, within forty days. In default of a human shadow, that of one of the lower animals is measured (Frazer, 89 f.).

In the island of Kisser in the East Indies, the guardian divinity of a house or village is the measuring-tape which has served to measure the foundations of the house or of the village-temple. It is wound round a stick, the head of which is carved into the figure of a human being, and is kept in a box (*ib.* 91 f.). In Russia, the carpenters at the first few strokes of the axe call out the name of some bird or beast, believing that the creature mentioned will rapidly perish. 'On such occasions the peasants take care to be very civil to the carpenters, being assured that their own names might be pronounced by those workmen if they were neglected or provoked' (Ralston, 126). The pronunciation of the name at the moment of the stroke causes the blow in some magical way to reach the owner of the name. British law in Burma is equally opposed to the rite in its cruder forms. Accordingly the Nāgā tribes of Manipur, who used to put a head under the main post of a new house, have discovered that a lock of hair is of equal value, 'for the ghost of the wretch would go there and seek the missing lock and be for ever compelled to remain beneath the post' (Hodson, 116).

Thus, in order to obtain a tutelary spirit, it is not absolutely necessary to immure a human victim. Fowler is of opinion that the real object of the rites already described at the fixing of a boundary stone among the ancient Romans was to provide a *numen*. Whether this was so or not (and it seems probable), there can be little doubt that the church-*grim* believed to haunt churches in Scandinavian and Teutonic countries was the ram, horse, or other animal killed at the foundation, or buried alive beneath the building. Many weird tales are told of the manner in which it performs its tutelary function.

In building a house it is often desired not to obtain a new protector, but merely to convey the family-god and settle him in the new abode. Images, icons, and ancestral tablets are in various countries reverentially and with soothing ceremonies transported to the place appropriated for them. The bringing of fire from the old home, as among the Russian peasants, is explicitly a transfer of the old house-spirit, who is formally welcomed to his new domicile (Ralston, 120, 137). The Hindu custom of interring earth from the parental homestead in the new foundations has probably a similar meaning (*PNQ* i. [1884] 87).

LITERATURE.—The principal works dealing with the foundation sacrifice are E. B. Tylor, *Primitive Culture*, London, 1872 (41903), i. 94 ff.; G. L. Gomme, *Folklore Relics of Early Village Life*, do. 1883, ch. i.; F. Liebrecht, *Zur Volkskunde*, Heilbronn, 1879, p. 284 ff.; R. Köhler, *Aufsätze über Märchen und Volkslieder*, Berlin, 1894, p. 36 ff.; E. Westermarck, *Moral Ideas*, i. [London, 1906] 461 ff.; E. Thurston, *Omens and Superstitions of Southern India*, London, 1912, p. 214 f. It has been most fully and systematically considered in an article by P. Sartori, in the *ZE*, Berlin, 1898, p. 1. Accounts of the other rites discussed must be sought for chiefly in works of descriptive folklore and ethnography, such as those to which reference has been made in the course of the article. The writer is indebted to his friend, Mr. William Crooke, for references to a number of Indian and other examples.

E. SIDNEY HARTLAND.

FOUNTAIN OF YOUTH.—The legend of the Fountain of Youth was known throughout Europe in the Middle Ages, and is even intertwined with the history of discovery in the New World, where Ponce de Leon sought the Fountain after hearing of the medicinal springs of Florida, with which he associated the Fountain of Youth the more readily since in popular belief the latter was located in the Indies. In Europe, this tradition of the Fountain was inextricably united with that of the River of Immortality. But the two did not have the same origin, and they should be kept apart as distinct legends. The River, or Spring, of Immortal Life was Semitic; the function of the river in legendary history was to preserve life. The Fountain of Youth was not Semitic but Hindu, and the function of this water was not to render man immortal, but to renew his vigour. The one idea easily glides into the other, and history shows

that the two national legends actually became united, the more quickly perhaps because the Semites themselves had the notion of rejuvenation, though it was not associated with man, and not at first with a fountain. This parallel phase of the legend is that of the rejuvenation of the eagle, which in Semitic legend renews its youth (cf. Ps 103³), but not at first by means of bathing.

In India the Fountain of Youth appears in early Brāhmanic legend and has continued down to the present day, although many of the modern 'Fountains of Youth' are in reality so called only by Europeans, most of them being known to the natives only as healing waters. The idea that some water was curative undoubtedly formed the basis of the legend in India, as it did in Florida. On the other hand, rejuvenation, either by fiat of a spiritual power or by means of drugs, charms, etc., was recognized as possible much earlier than was the special form of rejuvenation utilized in the legend of the Fountain. As early as the Rigveda, water is spoken of as medicinal, and men are rejuvenated by the will of the gods; but the two ideas are not brought together till a later period.

In Greece and Rome there was no Fountain of Youth attainable for man in this world, but only a spring of rejuvenation in the next or the spirit world. And so, originally, the Semitic 'Water of Immortality' was found only in Paradise, not within the reach of man on earth.

The legend of the Fountain of Youth was not known in France or Germany until it was introduced from the Orient. There is no reason, therefore, to suppose that this was an Indo-European myth. The kettle of Medea, which used to be brought into connexion with this myth, has a different motive, and the water here used has no similarity with the Fountain. In French and German legend the Spring is called *La Fontaine de Jovent*, the *Jungbrunnen*, etc., and the different popular versions, mixed with the Semitic legend of the Water of Immortality, are found to be clearly drawn from Oriental sources, all being originally forms of the story known as 'The Three Brothers.' The tale of Alexander's search for the Water of Immortality in India did much to facilitate the (otherwise natural) combination of the Semitic and Hindu legends. At the time of Sir John Mandeville, the 'Fountain of Life,' now identified with the 'River of Immortality,' was placed definitely in India. Older authors referred the legend of the Fountain more vaguely to 'the Orient.' In America there was no Fountain of Youth, only a medicinal spring, till European tradition had built upon native belief. Chinese and Muhammadan accounts have joined in spreading the tradition through the Pacific, where, again, European thought has often interpreted some other means of rejuvenation as a Fountain of Life, or the River of Immortality as a Spring of Youth.

It is probable that the Hindu fable was brought from India by the Nestorians (possibly by the Arabs), and was thence conveyed to Europe. Independently of the Nestorians there was constant communication with India as early as the 7th century. The Persians were not likely to have been the intermediaries, as they did not have the legend of rejuvenation, but only that of the Water of Life. Northern rather than Southern India (where European legend placed it) was the home of the Fountain. Outside of India, the eagle (see above) and the phoenix are rejuvenated. These two legends are also more or less confused. But it is to be noticed that the rejuvenation of both birds is ascribed to a fountain in the Orient. No classical writer, however, knows of such a fountain. As for the eagle, even Origen and Augustine, when commenting on Ps 103³, on the eagle's renewed

youth, do not ascribe it to a bath; though Donatus (*ad Heaut.* iii. 2. 10) attempts thus to explain the allusion to *aquilæ senectus* in Terence. But Jerome (*Ep. ad Præsidium*) has the legend, probably from an Oriental source, since, when the eagle's fountain is first located, it is placed 'in India.' To go back to earlier classical authorities is to lose all trace of the eagle's spring of rejuvenation. Aristotle (*de Anim.* ix. 22. 2), Pliny (*HN* x. 3. 3), and even Aelian (*περι ζώων ιδιότητος*) and Aulus Gellius (in his ch. concerning marvels, ix. 4), are silent on the subject, although they have much to say of eagles, Aelian especially stating (*op. cit.* ii. 26) that the eagle 'needs no spring' (being superior to thirst)—a statement he would scarcely have made without modification had he known of the eagle's spring of youth. We may, therefore, conclude that the eagle was not rejuvenated by a bath in a fountain till the Oriental version of the Fountain of Youth became familiar to the Mediterranean littoral.

To sum up the tradition and legends of rejuvenation: there are various means of rejuvenation, but the Fountain of Youth appears to be derived from India, where it is first known. In European thought it was combined with the Semitic Water of Life, and with the classical Spring Immortal, which confers endless health and life on those who have passed the bourne whence there is no return, Anostos land, which coincides with the ends of the earth imagined as a home for the blessed. This, in time, coincides with the belief in the earthly paradise of the Golden Age described by Hesiod (*Works and Days*, 113) as free from disease and old age. The Fountain of Youth, considered rationalistically, is medicinal water with exaggerated properties.

LITERATURE.—E. Rohde, *Psyche* 2, Freiburg, 1898, ii. 390; E. B. Tylor, *Early History of Mankind*, London, 1878; Baring-Gould, *Curious Myths of the Middle Ages*, do. 1868-68, vol. i., Appendix 2; also E. Washburn Hopkins, 'The Fountain of Youth,' a monograph in *JAOS* xxvi. (1905).

E. WASHBURN HOPKINS.

FRATRES ARVALES.—See ARVAL BROTHERS.

FRAVASHI.—This is the Avestan name (Pahlavi *Fravāhr*) of a spiritual being, conceived as a part of a man's personality, but existing before he is born and in independence of him; it can also belong to divine beings. The concept so largely arises out of ancestor-worship that a complete account of it would include all the material already given in art. ANCESTOR-WORSHIP AND CULT OF THE DEAD (Iranian), vol. i. p. 454 f.

The etymology of the word given by Lehmann (in art. cited) is still accepted by Geldner and other excellent authorities, but it must be regarded as exceedingly doubtful. A. V. Williams Jackson has abandoned it, and Bartholomae marks the origin of the word as obscure. There are many proposals, but none can be regarded as proved. *Fravashayō asāunam*, 'the Fravashis of the followers of Asha (Right, Truth),' first appears in the prose *Gāthā Haptanghātī*, which represents a decided relapse from Zarathushtra's teaching towards the old polytheistic Nature-worship which he tried to supersede by his spiritual monotheism. The significant absence of the Fravashis from the *Gāthās* proper is best explained in the same way as that of Mithra and Haoma, divinities for whom Zarathushtra could find no room without compromising the unity of God. The Fravashis, as described in the oldest and most authoritative document, the *Farvardīn Yast* (*Yt.* 13), have no definitely ethical character; nor is there any attempt to moralize them until the Sasanian age. Zarathushtra, who would admit to his heaven only spirits of the most abstract and ethical character, associating them with Ahura Mazda as a real part of his own hypo-

stasis, was not likely to approve of the popular *manes*-worship, which moved in a far lower plane. He made much of the *daēnā*, the 'self' or 'individuality,' which, indeed, may well have owed its origin to his own analysis. He taught the great ethical lesson that this *ego*—a part of every man, good or bad—was the real determiner of a human destiny. The Fravashi has a certain resemblance to the *daēnā*; but the difference is vital, in that the former is divine, though in a sense in which the divine may be far lower than the human. Parsiism never allowed the association of Fravashis with the personality of a bad man. This was capable of interpretation on the same lines as the silence of the NT about the *πνεῦμα* of a sinner; but the original reason was very different. It was simply because the maxim *de mortuis nil nisi bonum* has a very serious significance among primitive peoples, and euphemism becomes a necessary precaution; hence the 'Fravashis of the pious' in Parsiism, and the *Di Manes*, or 'good gods,' in Roman religion. If in ordinary Parsiism 'unbelievers have no *fravashi*,'¹ it is only because the concept was too deeply rooted in ancestor-worship to be capable of association with the world of evil. The question was not pursued as to what happened to the Fravashi of a pious man who went wrong. Two exceptions are noted from late periods in the history of the religion. The *Sad-dar Bundahis* (ed. and tr. Spiegel, *Trad. Lit. der Parsen*, Vienna, 1860, pp. 173, 175) says that the Fravashi of an unbeliever goes to hell with his soul and his 'perception.' Al-Bīrūnī (A.D. 1000), in describing Farvardīgān (the All Souls festival), makes the souls of the dead return to their old homes 'from the places of their reward or their punishment' (*Chronol. of Anc. Nations*, tr. Sachau, London, 1879, p. 210). This may be safely regarded as an outsider's inference, and a wrong one.

Speaking generally, we may say that the Fravashis when plural are ancestor-spirits, acting only collectively, like the *manes*. When the word is singular, there is usually an emergence of other elements in the concept; these form the principal subject of the present article. Before turning to them, we must notice a subsidiary characteristic of the Fravashis which is mainly due to their connexion with the benignant departed, as is shown by the fact that it manifests itself only when they appear in companies. The name 'guardian spirits,' by which E. W. West renders the Pahlavi *fravāhr*, is decidedly inappropriate as an equivalent for the Avestan term, as we shall see. But there are some tutelary functions which are exercised by the Fravashis, though we do not find any one Fravashi acting as guardian angel for the human being with whom he is linked; and this, of course, is the fatal objection to the use of the term 'guardian,' which would naturally suggest a conception like that found in mediæval Christian theology. But the Fravashis act together as bringers of rain and givers of fruitfulness to plants; here the *Amshaspands*, *Haurvatāt* and *Ameretāt*, took their place in strict Zarathushtrian doctrine. To judge from the strangely imperfect definition of these twin archangels given by Plutarch (*Isis and Osiris*, 46), the popular mind was never eager to accept such shadowy figures in place of the beloved ancestral spirits whom men continued to invoke for the necessities of life. The Fravashis were most conspicuously active in promoting conception and birth, and the healthy growth of the babe at the breast. (Here their competitor was *Anāhita*, who was not really Iranian at all, still less a deity recognized by Zarathushtra.) The primitive belief that ancestor-spirits reincarnated themselves may account for the distant beginnings of this concep-

¹ Geldner, *EBr*¹¹ xxviii. 1043.

tion; but it must be noted that no doctrine of metempsychosis could spring from it on Iranian soil without bringing hopeless confusion into the relation between a Fravashi and his human counterpart. The Fravashis acted collectively here again, like their fellows the Indian *Pitāras*. They are powerful helpers in battle. The nearest approach to individual tutelary action is just where the connexion with the dead is strongest. In *Yast* 13 there is an immense list of names of departed saints whose Fravashi is adored separately. Some of these are invoked for specific help—deliverance from evil dreams, heresy, persecution, etc.

So far we have dwelt on functions which link the Fravashis with the *manes*; we have now to note that these Iranian spirits have marked points of contact with another Roman conception, that of the *Genius*. Some of the characteristics already observed may come as well from this side as from the other. The *Genius*, with his female counterpart the *Juno*, was conspicuously associated with the promotion of birth; and this is perhaps pre-eminent among the activities of the Fravashis. The Fravashi, like the *Genius*, belonged to gods as well as men, and to communities as well as individuals; and tutelary functions were recognized in both to about the same very limited degree. The Greek *ἀγαθὸς δαίμων* is a kindred conception, less fully developed; and all three may well go back in their history to the common store of the pro-ethnic Indo-European people. It is possible that we may link it in its remote origins with the notion of an External Soul.

We come now to the ideas connected with the Fravashi in the singular. Avestan psychology made the human personality include five immaterial elements—'vitality' (*ahū*), 'ego' (*daēnā*), 'perception' or 'sense' (*baodhah*), 'soul' (*urvan*), and Fravashi (*Yt.* 13¹⁵⁸). The last was the highest, the immortal part, which, according to an important passage from the *Great Bundahis* (tr. Darmesteter, *Zend-Avesta*, Paris, 1892-93, ii. 500 f.; Blochet, *RHR* xxxii. [1895] 104), dwelt with Ahura in life and united with the soul at death, thus saving it from extinction, when the other parts were dispersed among the elements. The pre-existence of the Fravashi was as essential a characteristic of the conception as its continuance. *Yt.* 13⁶⁷ tells us that the Fravashis appointed the paths of sun, moon, and stars. In the *Bundahis* (ii. 10 f., tr. West, *SBE* v. [1880] 14) we read of the choice originally offered them by Ahura Mazda, between abiding eternally in the spiritual world and becoming incarnate to join in the battle against the demons. The same great Pahlavi cosmogony makes the first of four trimillennia in the world-year belong to the spiritual creation alone, the Fravashis living with Ahura above, before anything material was made. The silence of our earlier sources makes it probable that this first trimillennium was added in Sasanian times; but that the Fravashis existed before the other elements of human personality is beyond doubt an ancient idea. It is implied, of course, by the fact that in *Yt.* 13 the Fravashis of the yet unborn *Saošyants* are adored. They are, moreover, classed with those of the 'men of the primitive law' (*paoiryō-kaēša*), Zarathushtra and his immediate followers, as the most powerful of all the host. That the Fravashi-concept has travelled a long way from exclusive association with ancestors is sufficiently shown by this strong and repeated connexion with men yet unborn, and by the express statement that 'the Fravashis of the living faithful are mightier than those of the dead' (*Yt.* 13¹⁷).

The connexion of the Fravashis with communities was alluded to above, among points in which the Roman *Genius* showed kinship. In *Yt.*

13²¹ we find that each of the four concentric circles of the Iranian commonalty—house (*nmāna*), family (*vis*), clan (*zantu*), and district (*dahyu*)—has its heavenly counterpart. The much disputed phrase *vithibiš bagaibiš*, in the Persepolis inscription of Darius, seems to be best rendered 'with the gods of the (royal) family,' the *theoi βασιλῆϊοι* of Herodotus. There is an analogy here with the 'princes' of Persia, Greece, and Israel in Daniel, and with the 'angels of the churches' in the Apocalypse. Actual Persian influence in developing a conception rather decidedly out of the normal course of Jewish angelology can be argued more plausibly than is possible in most of the alleged cases of borrowing from Persia. Two NT passages speak of individual 'angels' in terms which strongly resemble the heavenly counterpart of Parsiism, whether or no the idea has been developed under Parsi influence. Mt 18¹⁰ makes the 'angels' of the little ones dwell perpetually in the Presence. The declaration is completely interpreted if these are the heavenly counterparts, the Fravashis, of those who have not yet learned to sin; no other conception of angels suits it so well, since tutelary angels of children would have no special reason for precedence over those of adults. In Ac 12¹⁵ Peter's 'angel' is clearly his 'double'—his counterpart which has taken his place while he still lives. (See on this and some other Biblical passages the present writer's paper in *JThSt* iii. [1902] 514-527.)

The connexion of the Fravashis with the stars was probably a feature peculiar to Magian theology, never naturalized in Parsiism. In *Yt.* 13 they guard the heavenly bodies, but only in the same way as other *yazatas* are said to do. Identification with stars is not found till a late Pahlavi treatise (*SBE* xxiv. [1885] 92), where it seems to be mentioned only as an opinion held by some. It is quite in keeping with Magian star-lore—one of the most prominent notes of the Magi in ancient accounts of them, but conspicuous only by its relative absence in the Avesta. If the Magi did thus identify Fravashis with stars, we have a promising suggestion for the interpretation of Mt 2, by the help of their well-known devotion to divination by dreams. An apparition of a bright Nova in the sky would suggest the Fravashi of a great one newly born.

LITERATURE.—In addition to that cited in vol. i. p. 455, reference may be made to C. Bartholomae, *Altiran. Wörterbuch*, Strassburg, 1904, col. 994 f., and to the chapter on the subject in the present writer's forthcoming Hibbert Lectures on *Early Zoroastrianism*.

JAMES HOPE MOULTON.

FREE CHURCH OF ENGLAND.—See REFORMED EPISCOPAL CHURCH.

FREE CHURCH OF SCOTLAND.—See PRESBYTERIANISM.

FREEDOM.—See EMANCIPATION, FREE WILL, LIBERTARIANISM AND NECESSITARIANISM.

FREEMASONRY.—The Freemasonry of the present day, organized as we now have it with its associations of Lodges (as the various units are called) grouped territorially under what are known as 'Grand Lodges' with their hierarchies of 'Grand Officers,' took its rise from very humble beginnings in London in the year 1717, when the famous 'Four Old Lodges' combined in order to establish the first 'Grand Lodge' of the world. Until that time there had been isolated Lodges of Masons, working for the most part independently of each other, as far as is now known, in different parts of Great Britain. Whence, then, had these various Lodges come? What was their origin? These are the problems that confront any one who would write a history of Freemasonry.

The earliest Masonic documents now extant are a number of MSS known as the 'Old Charges of British Freemasons,' so called because they contain certain charges as to conduct and duties which were in bygone times read or recited to a newly admitted member of the craft. Of these, 78 different versions (according to the latest list) are known to exist, the earliest of all (known as the Regius or Halliwell MS, and preserved in the British Museum) having the date of c. 1390 assigned to it by experts. These 'Old Charges,' though differing in details, all have the same general character, and consist of three divisions: (1) an invocation or prayer, addressed to the Holy Trinity; (2) the legendary history of Masonry; (3) the charges addressed to the new member.

According to the legendary history of the craft as narrated in these old MSS, masonry (or geometry, as it is called in them) was originated in Egypt by Euclid, and spread thence into various countries, reaching England in the time of St. Alban (A.D. 300), who is said to have obtained increased pay for masons from the king, and to have 'got them charges and manners.' It is further stated that King Athelstan (925-941) granted a charter to the masons of England allowing them to hold an assembly every year. No doubt, in thus ascribing the origin of geometry to the Egyptians, the compilers of these 'Old Charges' were but following the tradition (confirmed by modern research) that the Egyptians were compelled to invent it in order to restore the landmarks effaced by the inundations of the Nile. Egypt may also be considered the birthplace of architecture, which commenced there with the construction of the Pyramids, 3000 years or more before the birth of Christ. Much, again, of the present Masonic symbolism can be traced to Egyptian counterparts, and Egypt was the home of the 'Mysteries'; but we doubt whether any connexion between modern Freemasonry and Egypt can be established.

The rules or precepts contained in the 'Old Charges' were plainly intended for the government of bodies of operative masons, and it is to such bodies that we must look for the origin of the Freemasonry of the present day. With the progress of civilization the art of building necessarily grows more and more important, and those who practise it tend to become more and more a close society with their own trade secrets and rules for their governance, just as with other bodies of men who practise the same calling or trade. Thus it is on record that, from the very earliest times of the city of Rome, there were corporations of men with common interests called *Collegia*, which were recognized and allowed by law. Some of these corporations were formed for trade and commerce, such as the *Collegium Fabrorum*, or gild of workers in hard materials, the *Collegium Pistorum*, or gild of bakers, and others, members of which had a common profession, trade, or craft upon which their union was based, although every man worked on his own account. These corporations or gilds spread throughout the Roman Empire, until in the time of Theodosius II. (A.D. 401-450) there were, in almost every city and considerable town, companies similar to those which existed in Rome, who exercised some particular trade or occupation for the safety, benefit, or amusement of their fellow-citizens. That there was a *Collegium Fabrorum* in Britain is established by a reference to it on a tablet now preserved at Chichester, which records the erection of a temple to Neptune and Minerva. Probably the origin of English Freemasonry may be attributed to these Roman *Collegia*, though it may be impossible to trace its actual descent from them. This supposition is strengthened by the number of

points of resemblance that can be traced between the organization of a Roman *Collegium* and that of a Masonic Lodge. It may be asked, Why did the masons alone of all trades preserve their organization? Because, being largely employed to erect ecclesiastical buildings, they came specially into contact with churchmen, as the 'Old Charges' show, and thus may be supposed to have been more highly organized than other combinations of workmen, besides being more skilled; and because, as they moved about the country wherever their services were in request, they would need such organization more than the others would. It is known that the masons of the Middle Ages, when employed to erect some important building, used first to make for their own use a temporary hut or shed near the place where the work was to be carried on, which they called the 'lodge.' Thus, in the Fabric Rolls of York Minster, we find an order for the workmen issued in 1352 as follows:

'In summer they are to begin work immediately after sunrise until the ringing of the bell of the Virgin Mary; then to breakfast in the fabric lodge (*logium fabricae*); then one of the masters shall knock upon the door of the lodge, and forthwith all are to return to work until noon. Between April and August, after dinner, they shall sleep in the lodge; then work until the first bell for vespers: then sit to drink until the end of the third bell, and return to work so long as they can see by daylight.'

Hence we see that the masons employed on a particular building, and living together in the lodge, would naturally become a more or less exclusive and organized community. That such bodies did exist is proved by some MSS now in the Bodleian Library at Oxford, which contain lists of the members of what is called *la loyge Lathamorum*, or Lodge of Masons, attached to the Priory of Canterbury for the years 1429, 1431, 1433, and following ones. Such bodies of skilled workmen would naturally have their own operative secrets, and would be jealous of admitting outsiders to a knowledge of them, and would have some set ceremonial for the admission of apprentices. There can be little or no doubt that the Freemasons of the present day are the descendants of such bodies of operative masons, who moved about the country and set up their lodges wherever their services were needed, having a system of secret signs and passwords by which a craftsman who had once been admitted could be recognized by the members of another lodge. They were called 'Free' Masons because they were free to travel about in times of feudal bondage and to render their services where any great building was in process of construction. The earliest instance known of the name in this sense is found in a list of the companies entitled to send representatives to the Common Council, dated August 1376, and now preserved in the Corporation Records at the Guildhall, London; in this the nineteenth Company on the list is that of the 'freemasons.'

These organized bodies of workmen, with their rules and regulations, seem to have been more common at one time in Scotland than in England, or at all events to have left behind them more records of their existence in the north than in the south of Great Britain; thus two codes of rules for operative masons, drawn up in 1598 and 1599 respectively, which dates they bear, are still preserved in Scotland. They are signed by 'William Schaw, Maistir of Wark, Warden of the Maisonis,' and hence are known as the Schaw Statutes. William Schaw was appointed Master of Works in Scotland in 1584, and had under his care all the royal buildings and palaces in the Northern Kingdom. The later of these two Statutes provides that Edinburgh shall be 'the first and principal lodge in Scotland,' Kilwinning the second, and Stirling the third lodge, and contains an elaborate code of rules for the government of the craft. The Lodge

of Edinburgh possesses minutes commencing in July 1599, and has been in continuous existence from that time, and, inferentially, from an earlier date.

In England the Masons Company of London, though its extant records date only from 1620, is considered by its historian (Edward Conder) to have been established about the year 1220, if not earlier, at which time there was great activity in the masons' trade in London, consequent on the building of London Bridge, which was commenced in 1176, and of Westminster Abbey, of which the foundation-stone was laid in 1221. These works, especially the latter, would naturally attract to London the members of such operative bodies as that previously mentioned as having existed at Canterbury, which were attached to religious houses, and possessed certain signs, secrets, and symbols relative to their craft. These symbols had doubtless descended from a remote antiquity, together with some knowledge of geometry, which was then regarded as a trade secret.

We have now to trace the gradual process by which the lodges of operative masons lost their operative character and were converted into the present-day Lodges of speculative Masons, who meet in secret, and have changed the working tools of the operatives into symbols inculcating moral lessons, so that the square with which the operative mason tries and adjusts rectangular corners of buildings is now regarded as a teacher of morality, the level denotes equality, and the plumb-rule uprightness of life and actions. This change was in progress both in England and in Scotland during the 17th cent., until it culminated, as before mentioned, in the establishment of the Grand Lodge of England in 1717; and various instances can be mentioned of the admission of non-operatives into the craft before that time. Thus it is on record that, on 8th June 1600, John Boswell, Laird of Auchinleck (a village in East Ayrshire, Scotland), was present at a meeting of the Lodge of Edinburgh, when, like the operative members present, he attested the minutes by his mark. In England the earliest proof of the existence of a non-operative or speculative Freemasonry is afforded by the records of the Masons Company of London, from which it is made clear that previously to 1620, and, inferentially, from a remote past, certain members of the Company and others met from time to time to form a Lodge for the purposes of speculative or symbolical Masonry, and were known as the 'Accepted' Masons. Hence comes the familiar title of 'Free and Accepted Masons,' implying a combination of operative and speculative Masons. Then it is also on record that Sir Robert Moray, who was Quartermaster-General of the Scottish army which occupied Newcastle in 1641, was admitted into Masonry in that year at Newcastle by some members of the Lodge of Edinburgh, who were also serving in the army. Next we find the celebrated antiquary, Elias Ashmole, founder of the Ashmolean Museum at Oxford, stating in his diary that he was made a Free Mason at Warrington in Lancashire in the year 1646; he also gives the names of the members of the Lodge, and it has been ascertained that they were all men of good social position, without a single operative mason belonging to their number. He also records in his diary that in 1682 he attended a Lodge at Masons Hall, London, when six persons were admitted into the Fellowship of Freemasons. In 1688 was published the *Academie of Armorie*, by Randle Holme, who was a heraldic painter and a professional genealogist, and acted as Deputy Garter for Cheshire, Shropshire, Lancashire, and North Wales; in it he writes: 'I cannot but Honor the Fellowship of the Masons because of

its Antiquity: and the more, as being a Member of that Society, called Free-Masons.' It is, therefore, obvious that symbolical Masonry must have existed in Lancashire before the admission of Ashmole, and in London before 1620; and that the gradual change of operative into speculative Freemasonry had begun early in the 17th cent., if not before.

However, we have no means of tracing the change with any completeness, until, in 1716, four of the then existing London Lodges met together and determined to unite under a Grand Master 'as the Centre of union and harmony'; and accordingly, on St. John Baptist's Day in 1717, the Grand Lodge of England was established at the Goose and Gridiron in St. Paul's Churchyard, London. Apparently the operative masons were already in a minority, for of the three principal officers then appointed one is described as 'Gentleman,' one as 'Captain,' and the third as 'Carpenter.' Dr. James Anderson, the historian of these events, says that they 'revived the Quarterly Communication of the Officers of Lodges (call'd the Grand Lodge), resolv'd to hold the Annual Assembly and Feast, and then to chuse a Grand Master from among themselves, till they should have the honour of a Noble Brother at their Head.' Hence the establishment of this Grand Lodge in 1717 is commonly known as the 'Revival' of Freemasonry, though there are no authentic records now extant of any previous Quarterly Communications or Annual Assemblies. But some sort of Annual Assembly must have been held, for the 'Old Charges' previously mentioned constantly refer to the duty of a Mason to attend the Assembly when properly summoned to do so; and possibly the note in Aubrey's *Natural History of Wiltshire* (ed. 1847, p. 99), that on 18th May 1691 there was to be 'a great convention at St. Paul's Church of the Fraternity of the Adopted Masons,' may refer to some such occasion, which was sufficiently notorious to be known even to a non-Mason. However that may be, this 'Revival' in 1717 forms the starting-point from which continuous Masonic history dates.

A similar Grand Lodge is known to have been in existence in Ireland in 1725, though the precise date of its establishment has not yet been ascertained; and in 1736 the Grand Lodge of Scotland was erected. From these three Grand Lodges have come, directly or indirectly, all the other regular Grand Lodges and their subordinates throughout the world, so that modern speculative Freemasonry has descended from the operative masons of Great Britain, who, in turn, may possibly have been descended from the Roman *Collegia*.

The founders of the premier Grand Lodge were quickly able to get 'a Noble Brother at their Head,' for in 1721 the Duke of Montague was their Grand Master, and from that time onwards an unbroken succession of noblemen or members of the Royal Family have presided over the Craft in England, the present (1913) Grand Master of English Freemasons being H.R.H. the Duke of Connaught, who succeeded the late King Edward VII.

In 1751 a rival Grand Lodge was established in London by some Irish Masons, who claimed that they alone preserved the ancient tenets and practices of Masonry, and that the regular Lodge had made innovations; so they called themselves 'Ancient' Masons, and styled the members of the 1717 Grand Lodge 'Moderns'; the two bodies continued in rivalry until 1813, when the 'United Grand Lodge of Ancient Free and Accepted Masons of England' was formed, and this body has continued ever since.

The spread of speculative Freemasonry through-

out the world since 1717 has been something marvellous, especially of late years, until there are now in existence about one hundred and ten independent Grand Lodges, with almost twenty-three thousand subordinate Lodges, from which the operative element as such has quite died out, and with over two millions of members owing allegiance to these various Grand Lodges, which exist in all civilized countries, except Russia, China, and Japan.

Besides the 'pure Antient Masonry, the growth of which we have been trying to trace, which consists of three degrees and no more, and is known as 'the Craft' *par excellence*, there are a number of other organizations calling themselves Masonic, a few being of real antiquity, but most being of quite modern growth. Among them may be mentioned the Masonic Knights Templars, a body of great strength in the United States of America; the Mark Masons, who are very flourishing in England; and the members of the Ancient and Accepted Rite, besides many others which it is needless to particularize in the present article.

The question is frequently asked, Is Freemasonry a religion? The answer to this must depend upon the meaning to be given to the term 'religion.' The latter may be defined as 'a system of faith in, and worship of, a Divine Being.' Freemasonry is defined to be 'a peculiar system of morality, veiled in allegory and illustrated by symbols.' But 'morality' is concerned with man's duties to his fellow-men, and is therefore different from 'religion,' which is concerned with his duties to his Creator. Thus our question may be answered in the negative—Freemasonry is not, and does not profess to be, a religion. At the same time it may be called a handmaid of religion, for it is founded upon the purest principles of piety and virtue; and no man who endeavours to live up to and act upon its teaching can fail to be a better man for doing so. As the early communities of builders in England, from whom our modern Freemasonry is descended, were mainly employed upon ecclesiastical buildings, it is only natural that Christianity should have been the religion of the early Masons, as is conclusively proved by the 'Old Charges' previously mentioned: it was not until the formation of the Grand Lodge of England in 1717 that they were left free to belong only to that 'Religion in which all men agree . . . that is, to be Good Men and True.' Freemasonry has never met with favour from the Roman Catholic Church, and has been expressly forbidden by several Papal Bulls; and some writers have maintained that its symbolism was only a cloak for a conspiracy against government and religion. But, whatever may have been the case with Continental Freemasonry, such an accusation is groundless as regards British Freemasonry; and Masonic Lodges in Great Britain were specially exempted from the operation of an Act passed in 1799 for the suppression of secret societies. Cf. art. FREE-THOUGHT, p. 122^b.

Now, with the spread of Freemasonry over the whole world, men of all religious faiths are admitted as members, and work together under its banners in harmony, as also do men of most varying political views; and Freemasonry has become a potent factor in promoting a feeling of universal brotherhood among mankind. ✓

LITERATURE.—R. F. Gould, *History of Freemasonry*, 3 vols., London, 1886-87; W. J. Hughan, *The Old Charges of British Freemasons*, London, 1895; Edward Conder, *Records of the Hole Craft and Fellowship of Masons*, London, 1894; D. M. Lyon, *History of the Lodge of Edinburgh*, Edinburgh, 1873; R. F. Gould, *A Concise History of Freemasonry*, London, 1903.
E. L. HAWKINS.

FREE-THOUGHT.—The term 'free-thinker,' as applied to certain writers and others who,

individually or in societies, impugned the supernatural authority of the Christian Church, came into use during the 18th cent., and gained general currency largely as a result of its employment by Shaftesbury and Collins (cf. Collins, *Discourse of Freethinking*, London, 1713; Fr. tr. 1714). In France those belonging to societies of this type were called *libres penseurs*, *libertins*, or *esprits forts*; in Germany, *Freigeister* or *Freidenker*. The extent to which the designation was adopted by the free-thinkers themselves, and to which it eventually prevailed in common speech, forms a still unsolved problem in the literary and social history of the 18th cent. (cf. art. DEISM, vol. iv. p. 533 ff.; and ENCYCLOPÆDISTS, vol. v. p. 302 ff.).

In any case the essential feature of the term is its having been applied to certain fairly comprehensive societies and circles which agreed in regarding their 'free' views as palpably identical, while, on the other hand, the more eminent original thinkers of the period—from Hobbes and Locke to Hume, Gibbon, Voltaire, and others—did not apply the term to themselves. This fact indicates the two most salient characteristics of the free-thinkers—the one negative, viz. their opposition to the Church's doctrine of authority and revelation, and their implied appeal to the freedom and independence of autonomous thought; the other positive—their assumption that such free or natural thought leads universally to essentially identical conclusions in a natural morality and religion. Free-thought is thus intimately related to Deism. It rests upon the assumption that reason contains a truth which has existed from the dawn of human history—a truth which has been obscured and defaced by the historical development, and, in particular, perverted by superstition in the Christian Churches, but which may nevertheless be restored by the free exercise of rational thought. Specifically, however, free-thought, in its attitude towards Christianity, leaned in some cases to the more conservative view that natural truth was supplemented and reinforced by revealed religion, and in others to the more radical, that only the kernel of Christianity—that element, namely, which harmonizes with natural reason—can be maintained. The whole movement was really a reflexion of the ecclesiastically orthodox mode of thought, which desiderates a uniform and absolute truth, in a mode of thought free from ecclesiastical bias; and, further, it had recourse to an old idea which had become fused with the theology of the Church, viz. the Stoic doctrine of the universal ethical religion of conscience and providence. Formally, therefore, free-thought was the repudiation of supernatural authority, while, materially, it was the liberation of the Stoic doctrine of ethics and religion from the Christian dogma with which it had hitherto been incorporated.

It is true that this holds good only of the earlier stages of free-thought, i.e. of its English forms. In France, where Catholicism, conformably to its nature, had drawn a much more rigid line of demarcation between religious doctrine and modern thought than that found in Protestant England, free-thought, as represented by Voltaire, renounced all connexion with Christianity, and in the Encyclopædists and their adherents it broke away from religion altogether. In England the free-thought and Deistic movement issued from a revolution having positive religious aims and subject to powerful religious influences, whereas in France it was associated with a purely social and political revolution, whose exponents identified religion with the Catholic State Church, and so took up a position of fundamental antagonism to both at once. It was in France, accordingly, that the movement assumed its most radical form. Of

its French representatives, Rousseau alone adhered to a form of religion in essence identical with Christianity. In the Netherlands and Germany, on the other hand, the English influence predominated, producing a more decidedly Christian variety of free-thought, the adherents of which, from the time of Grotius and Leibniz, maintained the essential identity of Christianity with Natural Religion, and differed in opinion only as regards the extent of the positive additions and guarantees which the former contributed to the latter.

In England, free-thought was, in a religious regard, extinguished by the rise of Methodism, and, as a philosophy, transcended in the historico-psychological relativism of Hume. In Germany it gave way before Herder's doctrine of development, and the poetic pantheism of philosophy. In France it succumbed to the anti-metaphysical principle of Positivism and the historico-critical method. In the purely religious sphere it declined greatly before the rehabilitation of ancient creeds which set in slowly with the Methodist movement, and then effectively asserted itself after the Napoleonic wars. More recently it has suffered further impairment at the hands of Socialism and its new-fledged ethical and metaphysical theories.

It must not be forgotten, however, that among the people generally, in so far as they have freed themselves from ecclesiastical authority, and yet desiderate some provision for religious education and edification, the tendency towards a form of free-thought that will meet this need is still active at the present day. To some extent the masses are predisposed towards such a type of free-thought precisely as in former times, by the natural theology which commingles with Christian teaching. The tendency is due partly to the elements of Christianity which survive when it has abandoned mysticism and the belief in miracles, and, accordingly, it continually re-emerges from the work of criticism in the Christian sphere. Partly, again, it rests upon ideas towards which the moral and religious emotion of mankind, emancipating itself from all historical data, readily gravitates; and, indeed, such ideas have a natural affinity with the moral and religious instincts, and are so far not unjustifiably called 'natural.' To these influences we must add that residuum of tradition from the deistic and rationalistic epoch which has all along continued to operate powerfully in poetry and general literature, and in positive and apologetic theology, and from which a popular rationalism may ever anew be developed. It is to be noted, moreover, that almost all endeavours to enlighten the masses, and all democratic movements and organizations inspired by modern philosophy, tend naturally to approximate to the same position. Virtue, love of mankind, belief in Providence or in development, progress, the unification of the race, and an all-embracing philosophy of teleological optimism—such are the features of a phase that ever recurs in this sphere.

It is true that, among the classes referred to, belief in the personality of God, the immortality of the individual, and the freedom of the will has become less assured. Here, in fact, modern science is at work with its conceptions of the universe and of law, and tends to effect some sort of synthesis between the teleological idea of ameliorative optimism and agnostic or pantheistic conceptions. Then the ideals of progress have come to be focused more upon the present world, upon the social and humanitarian factor, and—in place of personal immortality—the permanence of the race. This is just what was to be expected. The older type of free-thought belonged to an age which knew nothing of the achievements of modern scientific thought, or of its pantheistic metaphysics, and was thus more

favourably disposed towards the belief in God, immortality, and a responsible freedom: regarding these, in fact, as truths issuing from the light of nature. But, discounting these changes, we may venture to assert that, in all civilized countries where the people are no longer under the control of the Church, a wide-spread tendency to free-thought pervades the lower and middle classes. Within the sphere of pure science, on the other hand, and among the higher classes—so far as they have been influenced by science—the clash of fundamentally antagonistic systems and the habit of scientific scepticism have conspired to produce sheer anarchy in such things; and to speak here of a free-thought exhibiting any kind of unanimity in its conclusions is out of the question.

This brings us to a phase of the subject which, though of great importance, is usually overlooked. The characteristic feature of free-thought, as distinguished from modern science, properly so called, is its pervading sense of an axiomatic unity amongst its adherents, based upon the assumption of certain self-consistent, universally binding, and 'natural' truths. The sociological aspect of ethical and religious thought manifests itself here in the assumption—'natural' and self-evident—that all independent thinkers will inevitably arrive at uniformity in their convictions and modes of thought. On the foundation of natural religion arises, so to speak, a 'natural' Church of free-thinkers. At the outset, indeed, the free-thinkers proposed simply to continue the process of purifying the Church by criticism, and the English Deists and free-thinkers had originally no other end in view; their object was the conservation of the old religious organization—imbued, however, with a purified or natural knowledge of God, which, after all, was the true essence of Christianity. But, in proportion as the Church resisted their efforts, and their internal development carried them beyond the Christian sphere of thought, they found it necessary to form communities and societies of their own. It would certainly be wrong to dissociate this tendency from the purely theoretical and dogmatic side of the movement, where, on the assumption of a free, autonomous, and individual thought, it might appear, of course, as something altogether individualistic. As a matter of fact, however, such movements in the sphere of doctrine, like all other human interests, have a social aspect. This is found, first of all, in the axiomatic character which the free-thinkers expected to attach to the uniformity of their assumed principles, and in the fact that, being invisibly united in these, they were feeling their way towards becoming a power of the future and of progress—a spiritual federation of mankind, which would of itself come to prevail in virtue of the mere force of natural thought. Thought, just because it is free, *i.e.* because it issues from the necessity of nature, which is everywhere the same, is likewise a socially unifying factor. But, again, they were, of course, forced to recognize that, though the community of man would come into being of itself, it nevertheless required the aid of education and propaganda. They were thus brought to realize the necessity of organization, and, in the nature of things, their organizations became counterparts and imitations of the Churches. But they went further still. Even for fully developed and mature minds they felt the need of some visible means of confirming and deepening the convictions held in common—some kind of ceremonial and worship which should present these convictions to the imagination in vivid form, and thus evoke the stimulating and elevating force of solidarity. The result was the establishment of something analogous to Church worship,

which, indeed, has to some extent the same end in view, while the only elements thereof that the free-thinkers could not use were the idea of exerting a real influence upon the Deity and the preaching of ecclesiastical dogma.

It was in this way that the movement was led to adopt the policy of forming associations, and became allied with the forces working for the disestablishment of the Church. Of outstanding free-thinkers, Rousseau alone wished to make the new religion an official and compulsory one, proposing at the same time, however, that the individual be allowed to cultivate his distinctive tenets in his own way.

Here, then, we have the explanation of the fact that the 18th cent. was crowded with secret societies and free-thought unions, the secrecy being resorted to partly as a protection against the power of the State Church, and partly as a means of drawing the masses, or, as it might be, of out-rivalling the attractions of Church life. The academies of the 17th cent. had already pointed the way. From the soil of Deism sprang Toland's scheme of a *Socraticum Sodalitium*, for which his *Pantheisticon* was to serve as a liturgy. But the most outstanding example is found in Freemasonry (*q.v.*), which was instituted in England by the foundation of the Grand Lodge in 1717, was introduced into France in 1725, and found a footing in Hamburg in 1733, and which now pervades the whole civilized world. Freemasonry created a sacred symbolism and ritual of its own, as also a sacred mythical history, and thus actually forms a kind of rival to the Church, though it has here and there found it possible to keep on good terms with the latter. In Romanic countries it has become an organization working aggressively against Catholicism. Here, too, should be mentioned the Theophilanthropists of France (1797), the Abrahamites of Bohemia (1782), numerous Unitarian societies, and the ephemeral *Culte de l'Être Suprême*, instituted in France on the lines laid down by Rousseau.

The task of exploring the annals of the 18th cent. with reference to the formation of secret societies is one which still awaits the investigator. But the phenomenon is in no sense confined to the 18th century. When the religious revival of the first half of the 19th cent. had thrust such associations into the background, and the progress of science had largely undermined their Deistic principles, fresh combinations made their appearance—due partly to the reaction against the religious revival, and partly to the advance of modern science. The so-called *Deutsch-Katholicismus* founded by the contumacious priest Johannes Ronge, and the community which, under the name of *Lichtfreunde* (1840), set itself against the Protestant supernaturalism of the religious reaction, led to the formation of numerous 'free-religious' and free-thinking congregations in Germany (see art. DEUTSCH-KATHOLICISMUS, vol. iv. p. 672 ff.). In France the Religion of Humanity took shape at the hands of Comte; in Britain, America, and India arose societies professing the religion of reason. In 1880 an international society of free-thinkers, with national sections, was instituted at Brussels; and it was in the interests of that society in Germany that Bruno Wille wrote his *Lehrbuch für den Jugendunterricht freier Gemeinden* (Berlin, 1905), and Andreas Bard compiled his *Freidenker-texte* (Schwerin, 1909), while Edgar Monteil did the like for France in his *Catéchisme du libre-penseur* (Antwerp, 1877). The non-religious ethical instruction given in the schools of Paris—the so-called *instruction civique*—proceeds on similar lines. Another free-thought federation is the International Order for Religion and Ethics, which has its

central organization in Berne (1908); it owes much to the influence of Auguste Forel. Similar aims are pursued by the societies for moral culture which, originating in America, have spread throughout the civilized world. The latest organization of the kind is the Monistic Society inaugurated in Rome by Ernst Haeckel, but it is not likely to be the last. It stands to reason that, if modern thought should eventually prove unable to remodel the Churches, and find itself totally incapable of coming to terms with them, it must provide something to take their place. The alternative organizations which it has hitherto produced have been mainly imitations of the Church in one or other of its aspects, and a really sufficient substitute has not yet been found.

On the whole, we may affirm that the principle of an autonomous and non-theological type of thought for which the free-thinkers contended has, so far as science is concerned, been fully vindicated, and is now regarded as axiomatic and outside the sphere of controversy. But their other principle—their belief in the universally valid conclusions of Natural Theology—has completely broken down in the face of modern historical relativism and amid the clash of the great philosophical systems. Free-thought is thus, in one of its aspects, a self-evident principle, and, in the other, a shallow illusion now finally dispelled. This fact, again, militates against its tendency to produce new associations and groups, though fresh efforts in that direction are always being made. Cf. also art. MODERNISM.

LITERATURE.—E. Troeltsch, art. 'Deismus,' in *PRE* iv. (1898); L. Zscharnack, art. 'Freidenker,' in *Religion in Geschichte u. Gegenwart*, ii. (Tübingen, 1910); J. M. Robertson, *Short Hist. of Freethought*, London, 1906; Ludwig Noack, *Die Freidenker in der Religion*, Berne, 1853-55; U. G. Thorschmidt, *Versuch einer vollständigen engländ. Freidenker-Bibliothek*, Halle, 1765-67; Goblet d'Alviella, *L'Évolution religieuse contemporaine chez les Anglais, les Américains, et les Hindous*, Paris, 1883 (Eng. tr. 1885); R. F. Gould, *History of Freemasonry*, London, 1886-87, 1908. See also artt. DEISM and ENCYCLOPÆDISTS, and Lit. given there.

E. TROELTSCH.

[Additional Note.—Owing to a lack of sufficient material on which critical inquiry can profitably exercise itself, it is a work of peculiar difficulty to trace the progress of free-thought in the religious life of the *Ancient East*. But, as Max Müller long ago pointed out, the religion of Buddha was originally a pure a-theism. It was only as a reaction set in, and the popular mythology began to exercise itself in the direction of a Buddha-cult, that this system of atheology decayed. In the Brahmanic cults it is not, perhaps, incorrect to say that pantheism took its rise in a semi-developed attitude towards 'free-thinking' in its widest application; while in Persia the reaction from polytheism in favour of a partially enlightened Mithraism, and the later Mazdaism, issued in nothing that deserves the name of free-thought. In *Egypt*, despite the vast store of materials that bear upon the problems of religion, little definite knowledge has come to hand; though it is arguable that the religious reformation attempted by Akhenaten was prompted by what may, for lack of better nomenclature, pass as Rationalism.

With *China*, different tendencies were at work. Apart from ancestor-worship, the religion of China has been, and still is, rationalistic in a pronounced degree. The arrested growth of religion, as generally understood, is one of the significant facts that face the historian. In the 'religious' reformations connected with such names as Kung-fu-tse, Lao-Tse, and Mencius, the purely ethical side of religion, and the reduction of supernatural elements to a minimum, are points that deserve consideration.

Free-thought in *Israel* was never truly realized save partially and sporadically; of a system of

Rationalism we cannot properly speak in this connexion. It is true there are traces of a free-thought movement in the later books of the OT, such as Job and Ecclesiastes; but these lie out of the main current of the nation's religious development, which was in the direction of a rigid monotheism, akin in many respects to the creed of Islām.

Not until we reach *Greece* do we find those forces vitally at work out of which a co-ordinated system of free-thought springs; but, once there, we realize that those forces were active all down the stream of Greek history. Many reasons might be alleged for the unique place which Greece holds in the evolution of human freedom; but they are not germane to the present inquiry, which is to indicate the direction of the movement itself. It may be noted, however, that nothing contributed more to the rationalizing of all religious thought, which characterizes the most progressive epochs in Ancient Greece, than the fact that for the people generally there was no definite creed, no sacred book, no universally acknowledged priesthood. 'Each local cult had its own ancient ritual,' says J. M. Robertson (*Short Hist. of Freethought*, i. 137).

Of any definite cult of free-thinking in *Ancient Rome* there is scarcely a trace. Religion was largely based on purely material considerations, and the element of 'mystery' was noticeable by its absence. It was the very lack of this element which brought about the hankering after weird emotional cults, which became such a feature in the last days of the Republic and in the early Empire. Lucretius is, perhaps, the one genuine exception to the statement made above; his great poem, *de Rerum Natura*, based on the teaching of Epicurus, is one long attack on supernaturalism, and a pæan, in hexameters, to the spirit of Rationalism.

Coming to a later period, we must briefly mention the rise of Rationalism in the *Muslim world*. No free-thinker of any country—Voltaire alone excepted—is more celebrated in England than Omar Khayyam, the high priest of free-thought and of pessimism. But, though Omar has attained no great vogue in Islām, he does not stand alone; the names of al-Kindī and Averroës (to mention two only) at once spring to the mind. Of free-thought in later times there is less to record; but that the foundations of Islām are being gradually undermined in the modern Muhammadan world by its contact with Western thought, no serious student can doubt; and this in spite of phenomenal successes secured by the followers of the Prophet in Central Africa during the past half century.

Of Rationalism in *Christian Europe during the Middle Ages* we find many traces; but the questions that arise in dealing with its progress must be sought for in a history of heresy. With few exceptions, a free-thought propaganda during those centuries was mainly confined to the struggles of 'heretics' and the semi-'orthodox' to assert for themselves a right to worship in accordance with what they held to be reason and revelation.

It is with the *Renaissance* (q.v.) that free-thought, in the modern sense of the term, begins to make itself powerfully felt. The free-thinkers of the 15th and 16th cents. once more set ablaze the torch of human liberty which had been smouldering for a millennium. The complex ecclesiastical organization which had its centre at Rome had tried—and almost successfully—to quench it; but the re-discovery (so to speak) of Greek culture, and the opening up of vast avenues of thought which was the consequence of that discovery, finally broke the domination, mental and spiritual, exercised for ages over the minds of men. A beginning

was made by Boccaccio and Petrarch; the movement culminated in Machiavelli, the politician, and Giordano Bruno, the philosopher and man of science.—E. H. BLAKENEY.]

FREE WILL.—I. GENERAL.—1. Freedom a vital question.—The Free Will controversy is sometimes regarded as turning 'merely upon words and ambiguous expressions' to which 'a few intelligible definitions would immediately have put an end' (Hume, *Philos. Works*, Edin. 1854, vol. iv. 'Liberty and Necessity'). Historically, a vague terminology—will, motive, necessity, determination—has undoubtedly caused confusion. But, while the controversy has often been verbal, there is a real issue at stake. 'The government of God and the responsibility of man are equally involved' (H. B. Smith, *Faith and Philosophy*, Edin. 1878, p. 359). Again, the Free Will controversy is not an indifferent one, as Sidgwick implies (*Methods of Ethics*, Lond. 1901, ch. v.). Historically, indeed, thinkers of the most diverse moral systems are indiscriminately found on both sides of the discussion. Anthony Collins the free-thinker defends necessity against Clarke. Bramhall defends freedom against Hobbes. Edwards and Chalmers seem to fall into the same ranks as Hume and Mill. This *quæstio vexata* seems to cut athwart well-defined moral affinities. The capricious manner in which men 'of high-toned character and devoted piety' (J. Martineau, *A Study of Religion*, ii. 196) are affiliated to either side of the controversy is no proof, however, that the question of freedom is an ethically indifferent one. For (1) this caprice is more apparent than real. Though Bain, for instance, may claim to have Chalmers on his side, yet the *Weltanschauungen* represented by the two are separated *toto cælo*. Leslie Stephen and Green also may both be called determinists, but in a very different sense. Principal Cunningham took Hamilton to task for identifying predestination and philosophical necessity, and historical justice demands such differentiation (W. Cunningham, *Reformers and Theol. of Reformation*, Essay ix.). (2) We must also discriminate between what thinkers are defending and what they are denying. Thus Augustine denied free will in order to defend God's free grace. The defence was the real aim, the denial was incidental.

'There are theses which are, outwardly considered, entirely untrue, but, inwardly considered, true. Thus is Augustine's doctrine of sin and grace to be judged. As an expression of psychological religious experience it is true; but projected into history it is false' (Harnack, *Outlines of the Hist. of Dogma*, Eng. tr., Lond. 1893, p. 372).

This is really a vital point to remember. Many who oppose free will do so because they wish to conserve the effects of good actions already done (so T. H. Green, *Prolegomena*, p. 129), while many who champion free will do so to give some ground of hope to those who feel the burden of the past (so W. James, *Pragmatism*, New York, 1907, p. 120). The problem of freedom is neither a linguistic nor an ethically indifferent question. It is a permanent problem of thought.

2. Ground of problem in human nature.—Kant has emphasized the difference between man's theoretical and his practical activities. Man, as intellectual, demands coherence in experience. From this point of view, character is 'empirical'; i.e. it falls under the law of causation. Man belongs to the realm of Nature. But man, as moral, looks on himself as an 'intelligible' character, and 'the intelligible character has this prerogative over all other beings that he fixes his end for himself' (*Werke*, ed. Hartenstein, Leipzig, 1867-68, iv. 85). Viewed thus, man belongs to a realm of ends. Whatever may be thought of Kant's use of this distinction (see J. Ward, *The Realm of Ends*, Lect.

xiv., for a discussion both of its importance and of its liability to abuse), the distinction itself is recognized as important, and so

'for us, as for Kant, the question of freedom takes the form of a deep-seated antithesis between the interests of the scientific or intellectual consciousness on the one hand, and the moral and religious convictions of mankind on the other' (J. Seth, *A Study of Ethical Principles*, p. 345 f.).

The moral life is a real part of human experience, and it must not be denied in the theoretic interests. This at once obviates many objections to freedom. (a) When the psychologist denies freedom, he does so in the theoretic interest. Psychology is in the third person, its point of view is that of the spectator (cf. H. Höfding, *Outlines of Psychology*, Eng. tr., 1892, p. 345); morality is in the first person, its point of view is that of the agent. To raise the question of freedom at all is to transcend the ground of psychology, unless, indeed, we get a psychology, such as Boyce Gibson outlines in *Personal Idealism* (London, 1902, pp. 136-192), that takes the inward point of view.—(b) In the same way arguments against freedom based on the law of the Conservation of Energy lose their force because such discussions are carried on in a universe of discourse which leaves the moral attitude outside.—(c) It is quite true also that historians and statisticians are able to appeal to uniformities of experience due to material conditions 'without regard to the volition' of men (Buckle, *Hist. of Civilization*, 1867-68, p. 24), but that is just the business of the statistician (cf. W. James, *Will to Believe*, p. 216 f., for a brilliant refutation of this objection).—(d) 'We always explain the voluntary action of all men except ourselves on the principle of causation by character and circumstances' (H. Sidgwick, bk. i. ch. v.). Sometimes we excuse our own actions on this principle, yet if one

'really seek to excuse himself in the sequel, by trying to show that it was impossible for a man with his particular antecedents to act otherwise than he did, he is regarding the action entirely from an external and non-moral (which for him in the circumstances is an immoral) point of view' (Pringle Pattison, *The Philosophical Radicals*, Edin. 1907, p. 101; cf. p. 322).

These and all similar attempts to deny freedom shatter on the moral consciousness. W. James, in 'The Dilemma of Determinism' (*op. cit.* 145-183), has shown by a series of arguments *e consequentiis* how Determinism destroys the ineradicable moral instincts of man. Butler also dismissed Necessity from the same point of view with a 'disrespect amounting to contempt' (W. E. Gladstone, *Studies Subsidiary to Butler's Works*, Oxford, 1896, p. 268).

The problem of freedom may thus be said to be grounded in human nature. To discuss it is to raise the validity of the moral consciousness. It is a philosophical and theological question, not a question of physics or empirical psychology.

The admission of a freedom from co-action or compulsion is not enough to satisfy the moral demand. To man in normal conditions this is not denied by any one. It may be impaired by disease, it may be limited by inadequacy of material, it may be compulsorily taken away, but otherwise it is a common human possession. Such a power, however, is purely non-moral. It does not distinguish man from life in general. But freedom has meaning only in reference to the moral nature of man. 'It is the reason's postulate for the dictamina of conscience' (J. Duncan, *Colloquia Peripatetica*, 1907, p. 30).

Nor is it sufficient to view freedom as the action and reaction between character and environment. On this view, character is partly inherited, partly acquired, but the acquired character is the inevitable product of the inherited one. 'The whole man is inherited, if we may use such a phrase' (Leslie Stephen, *Science of Ethics*, Lond. 1882, p. 289). Freedom may be thus regarded in the interests of naturalism or of idealism. T. H. Green

does it in the latter interest. 'The action is as necessarily related to the character and circumstances as any event to the sum of its conditions' (*Proleg.* p. 126; cf. p. 129). Logically, in either case the moral consciousness is violated. According to this view, things could not possibly have been otherwise; and praise and blame, punishment, obligation, and the hope of progress are illusions. In short, the moral point of view is disregarded. For, morally viewed,

'action is not referred backward in time to the circumstances and predispositions of which as motives it is the legitimate outcome, but the man brings his action face to face with a "Thou shalt" which he finds within him, and according to its conformity or want of conformity with this law he approves or condemns his conduct' (Pringle Pattison, 322).

We must take our stand on the moral nature of man; and, while admitting the prevalence of habit, the power of inherited character, and the force of circumstances, and so refusing a *liberum arbitrium indifferentiæ* which is dismissed now by indeterminists as a contradiction in terms (cf. Wendt, *System der christl. Lehre*, 196), we at the same time have to determine whether the consciousness that things could have been otherwise—that evil might be abolished, that responsibility is a fact, that punishment is not a fiction—is possible of vindication on any *Weltanschauung* that can gain the respect of the reason. This is the problem of Freedom.

II. PHILOSOPHY AND FREE WILL.—I. Free Will and Naturalism.—Naturalism explains all Reality in terms of matter and motion. It carries necessity all through experience. On this view, freedom has no meaning. So the philosopher who believes in free will has to defend its possibility against this system. This can be done (1) by an argument from consequences.

'Those who hold "naturalism" are bound to believe that every decision at which mankind have arrived and every consequent action . . . was determined by the quantity and distribution of the various forms of matter and energy which preceded the birth of the solar system' (A. J. Balfour, *The Foundations of Belief*³, 1895, p. 20).

(2) The concept of the 'Uniformity of Nature,' which is the foundation of Naturalism, may be shown to be not opposed to mental activity, but a fruit of it. It is a reflexion, in short, of the activity of the self into the realm of Nature—a metaphorical explanation of Nature in terms of human action. Natural laws are symbolic formulæ of explanation, not ontological dogmas. They fail even to earmark individual cases in their own sphere; they are thoroughly inadequate to explain all reality. This offspring, then, of the active self cannot be used to discredit its parent. (3) Again, in conscious life we find all along a subject as well as an object. T. H. Green has shown that knowledge is inexplicable without a subject. Hume's sensationalism is inadequate to explain cognition. But feeling and conation imply a subject also. For feeling and conation depend on interest and attention. W. James finds that the 'duration and intensity' of mental effort are not dependent on the object, but on the subject. He calls this an 'independent variable' at which science has to stop (*Text-Book of Psychology*, N. Y., 1892, p. 455); but it is not so. It is only one phase of the activity of the subject which is all along present. This we may call the psychological possibility of freedom, and

'freedom is a permanent attitude of the conscious subject, consciousness always implying a consciousness of the subject's relative independence in relation to the object that conditions but does not necessarily regulate its activity' (*Personal Idealism*, 161 f.).

This 'creative synthesis,' which characterizes conscious life in general, is the distinguishing quality of moral life in particular. For here we are in the realm of ideals, of values which create and control activity. This is admitted by 'Ideal-

ism' and 'Pluralism' alike as against Naturalism. How, then, do they explain this activity itself? What is their view of freedom?

2. Freedom and Absolutism.—The problem of freedom arises when we ask: (1) What is the relation of the self to the character? (2) What is the relation of both—of a person—to Reality?

(1) Absolutism tends to identify the self and the character. 'This is one result of equating the 'real' and the 'rational,' but it overlooks the fact that experience for us is not complete, and that the 'ought to be' is not the 'is.' H. Bergson has pointed out that there is another and a truer way of looking at things.

'Hence there are finally two different selves, one of which is, as it were, the external projection of the other, its spatial and, so to speak, social representation. We reach the former by deep introspection, which leads us to grasp our inner states as living things, constantly *becoming*, as states not amenable to measure, which permeate one another and of which the succession in duration has nothing in common with juxtaposition in homogeneous space. But the moments at which we thus grasp ourselves are rare, and that is just why we are rarely free. The greater part of the time we live outside ourselves . . . we "are acted" rather than act ourselves. To act freely is to recover possession of oneself, and to get back into pure duration' (*Time and Free Will*, Eng. tr., p. 231 f.).

It is not simply, however, by deep introspection that this happens. It takes place also when we obey great ideals. On this view, the self, though manifested in the present character, is greater than it. Hence it is possible for sudden changes of character to take place, to make a new beginning. The evil past can be transformed, and its very memory may be an inspiration in its own undoing; while the past, in so far as it is of value, is made a ground of further development (cf. Boyce Gibson, *Rudolf Eucken's Philosophy of Life*, Lond. 1906, p. 27 f.). We hold, then, that the self acts teleologically on its own character, *i.e.* it acts through ideals. The mechanism of character it either accepts or modifies and turns into new channels for new purposes. The mechanical and intelligible worlds of Kant are thus brought together in the unity of a growing personality—free, yet using its freedom in ordered calculable ways.

(2) Absolutism tends to make the self a phase of Reality. In fact, the self in this system is in a state of unstable equilibrium. Its essential features are either projected into the social order or sublimated into the Absolute Experience. We have seen how on the first view freedom is attenuated. On the second view we have the acosmism of Spinoza, which can give no place to freedom except as the rhythm of the Divine life (cf. J. Seth, 379-386, for a criticism of this view of freedom).

3. Pluralism and Freedom.—Pluralism recognizes the distinction between the self and the character. Freedom is its watchword; but, as expounded by some, the objective element in experience is undervalued. As a reaction against Naturalism it makes truth wholly pragmatic. Nature is absolutely plastic. There are no laws there till we make them. The world is an *ἀπειρον*, and chance governs all (*τύχη κυβερνᾷ πάντα*). This 'Tychism,' however, errs in overlooking the persistence of character. For, even in the case of a sinner converted, his past is recognized somehow as his own. Moreover, civilization and Nature, impersonal and mechanical in some sense, are yet the very media through which the self acts. Moral ideals, again, though self-accepted, have the characteristic of universality. We are in danger here of laying exclusive stress on a bare activity of the subject. But this is not enough; objectivity and unity are also required. These are given us in the physical and psychical orders in which our freedom works as well as in the universality of the moral ideal itself.

We have already attempted to give a view of the freedom of the subject in relation to the character. What is this freedom in relation to

outward reality? This is the most living problem in modern metaphysics. It involves not only the relation of man to Nature, but that of Nature to God and of man to God.

Freedom touches the problem in so far as the power of obeying the moral imperative is concerned, and thus it postulates at least that the mechanism of Nature must not be either indifferent or hostile to its own teleological activity. The difficulty of the problem is increased by the fact that between man and Nature there is what Comte called *l'humanité*, i.e. Nature as modelled by man.

This aspect of Nature is the hope of the moral consciousness—that all Nature is in reality a fit vehicle of spirit. When moral endeavour has already done so much to make the world familiar and subservient, may it not do all? On the other hand, *l'humanité* often fills moral endeavour with despair. For here progress against evil customs and perverse institutions seems to be helpless; and even customs and institutions, good in themselves, hinder progress when taken as final resting-places of the living spirit.

The relation of persons to Nature, then, is actually one neither of freedom nor of slavery; but, ideally at least, moral effort demands that Nature become a fit mechanism for realizing worthy ends. This suggests that much of *l'humanité* (in the Comtian sense) must and can be subverted; it does not imply, however, that Nature itself is inherently opposed to freedom; for mechanism here may become media of purposive acts (cf. R. H. Lotze, *Microcosmus*, Eng. tr., Edin. 1885, i. 261; and H. Bergson, *Creative Evolution*, Eng. tr., Lond. 1911, for the relation between persons and Nature).

III. *FREE WILL AND THEOLOGY*.—Theology refers everything to God. Its great danger in so doing is that the personal attitude inherent in moral experience may be submerged. It is always difficult to do justice to God and man (cf. Pringle Pattison, *Hegelianism and Personality*, Lond. 1887, p. 153). Man's moral nature is threatened from this side even more than from the side of Nature, because, while the moral life rises up in self-defence against Nature, it feels secure in dependence on the Divine.

The religious consciousness asserts both the sovereignty of God and the freedom of man. Pharisaic Judaism held both views side by side (Jos. *BJ* II. viii. 14), and St. Paul (Ro 9. 10) emphasizes now the one, now the other. To do this is more important for morals than to do violence to either in the interests of premature synthesis. St. Paul did not neglect the individual attitude.

'The ethical sense of responsibility, the energy for struggle and the discipline of will was not paralysed or absorbed in Paul's case by his consciousness of redemption and his profound spiritual experiences' (J. Weiss, *Paul and Jesus*, Eng. tr., Lond. 1909, p. 113).

St. Paul, however, did not deal with free will from the standpoint of an insulated individual. The latter from the religious point of view is an *ens rationis*. Every man is related to God, and is—within the movement of history—open to influences of sin and grace. For St. Paul, God is the author of his redemptive experiences: they are not the effect of his free choice; they came to him from God. But they are not opposed to free choice. They are a gift; they are also a task.

Within the individual religious experience, freedom thus tends to coalesce with necessity; this freedom is not power to do anything irrespective of character, nor is this necessity physical coercion. This is the *felix necessitas boni* of Augustine (cf. Luther's *Freiheit eines Christenmenschen*, opening paragraphs). This freedom is perfect in God. It is the *non posse peccare* of a holy character. In

man it is a progressive attainment nurtured by the Holy Spirit. The sovereignty of God is thus essential to this freedom because it means the conservation of spiritual values, and it gives the individual certainty of moral victory while it frees him from the tyranny of sin and the world. Negatively, it is freedom from sin; positively, freedom for righteousness.

It was in the interests of this ideal freedom that Luther and Calvin tended to neglect its natural basis in man's moral nature (cf. J. Oman, *The Problem of Faith and Freedom*, London, 1906, p. 14). This ideal freedom (cf. T. H. Green, *Works*, ii. 308 f., for philosophical cognates) is not an attained reality in religious experience. 'A power of choice is not thought of in this freedom, but a state of the most fixed and settled decision for God' (J. Müller, *Christian Doctrine of Sin*, ii. 12). Hence, till we reach that ideal, we need a conception of freedom to represent present experience. '“Freedom” in a world already perfect could only mean freedom to *be worse*, and who could be so insane as to wish that?' (W. James, *Pragmatism*, New York, 1907, p. 120).

Can God's sovereignty be reconciled with such a freedom of choice as we require? It cannot if God's absoluteness is asserted without qualification; then the moral life becomes unintelligible. Butler has warned us against speculating on how God ought to reveal Himself. We ought rather to find out how He has revealed Himself. So, God's absoluteness must be approached from experience. The defect of Augustinianism and Calvinism is that they start from a knowledge of God's absoluteness above experience, deduce logically from this eternal decrees, and so explain individual experience. We must start from experience, however; and, doing so, the problem is to reconcile God's absoluteness in grace with man's freedom. If we deny the latter, we deface man; if we deny the former, we are in a world which is a moral chaos, where ideals have no reality that can be depended on, where the holiest hopes of men may never be satisfied. The history of Free Will within theology is an oscillation between these two interests. The Greek Church had to conserve human freedom against the Gnostic fatalism, with its three fixed unalterable types of men (pneumatic, psychic, hylie). This was done in such a way as to obscure the distinction between nature and grace. Augustinianism, again, made an impassable gulf between the moral consciousness of responsibility and the new life of grace. In any attempted reconciliation both interests must be conserved.

1. *Freedom and Omnipotence*.—It is not enough to admit freedom *in civilibus* or *in moralibus* and deny it *in spiritualibus*. That is not the way to safeguard religious experience. So even Calvinists like Chalmers, who adopt the Edwardean position, insist on their right to make a free gospel offer (cf. T. Chalmers, *Works*, Glasgow, 1849, ix. 312 f.). It may be said that this is speculatively inconsistent, and it is so because God's omnipotence is logically started from instead of being explained from experience. The power to embrace God's offer of salvation must be granted to man. The difficulty is created by starting with an individual cut loose from God, by separating the *ἐνέργεια τοῦ θεοῦ* from the *τὸ θελεῖν* in man. But that is not thinkable. God is there all along, though only in the religious life is His power graciously accepted. Hence the freedom theology requires for man is freedom in a universe where God is active, and where man is active too. In short, this is not a 'block universe,' but a realm of ends realized in God, realizable by man within the limits of his finiteness, opposable by man also within these limits. No other view

of freedom can satisfy the moral demand as it shows itself negatively in guilt, and positively in responsibility for future obedience.

2. Freedom and Omniscience.—Nor can we be satisfied with a bare foreknowledge unrelated to experience. It is true that, on the human analogy, we have foreknowledge of one's action without being its efficient cause; and so some theologians (Rothe, Martensen; cf. Gladstone, *op. cit.* 273, and Jowett, *Epistles of St. Paul*, 1894, ii. 370) have regarded the Divine prescience as the logical knowledge of everything apart from any causal connexion with anything; but we are in danger here of lapsing into the Epicurean view of God as careless of mankind. Again, thinkers (e.g. Royce) have regarded God's knowledge as timeless, as 'knowledge at one glance of the whole of the temporal order' (*The World and the Individual*, Lond. 1900, ii. 374; cf. J. Ward, *The Realm of Ends*, p. 313 f., for a criticism). Both these views err in not relating God's knowledge to human experience, but it is just this relation that is of religious value. Religion demands God's activity all through, but it demands this in harmony with morality. Hence it speaks of God changing His mind, of God delaying His judgments when men repent. In short, it admits a possible change in the course of history dependent somehow on human action. The very essence of the religions claims—repentance, new obedience—does not postulate a closed universe in which God is fettered or man predetermined either by omnipotence or omniscience. While God must thus be actively aware of all possibilities, and cannot be surprised, or His purposes ultimately frustrated, yet there is within this real contingency.

Thus it is possible to have a view of God's foreknowledge which is immanently present and lovingly active all through, but works in accord with holy purposes. This view, with all its difficulties, seems to us to safeguard God's freedom in Nature, to substantiate His continual efficiency in grace, and yet to conserve man's responsibility. It is the task of theology to furnish a *Weltanschauung* consistent with both these positions.

Cf. also the artt. ELECTION, FATE, LIBERTARIANISM AND NECESSITARIANISM, PREDESTINATION, SYNERGISM.

LITERATURE.¹—Dugald Stewart, *Moral Philosophy*, Edin. 1854, vol. i. 'Of Man's Free Agency'; Wilhelm Vatke, *Die menschliche Freiheit*, Berlin, 1841; H. H. Wendt, *System der christl. Lehre*, Göttingen, 1906, p. 189 f. (a select bibliography [German] given); W. James, *The Will to Believe*, New York, 1897; A. E. Taylor, *Elements of Metaphysics*, London, 1903; *Personal Idealism* (ed. Henry Sturt), London, 1902, Essay iii.; T. H. Green, *Proleg. to Ethics*, Oxford, 1899, and *Works*, London, 1906, ii. 308-33; J. Martineau, *A Study of Religion*, 2 vols., Oxford, 1888, vol. ii. bk. ii.; A. C. Pigou, *The Problem of Theism*, London, 1908, pp. 65-80; H. Rashdall, *Theory of Good and Evil*, Oxford, 1907, vol. ii.; J. M. E. McTaggart, *Some Dogmas of Religion*, London, 1906; J. Seth, *A Study of Ethical Principles*, Edin. and Lond. 1894, pp. 345-88; J. Ward, *The Realm of Ends*, Cambridge, 1911, esp. chs. xiii. and xiv.; H. Bergson, *Time and Freewill*, Eng. tr., Pogson, London, 1910. (For a full bibliography of Free Will and Predestination, see W. A. Copinger, *A Treatise on Predestination, Election, and Grace*, London, 1889; A. Harnack, *Hist. of Dogma*, Eng. tr., London, 1894-99, and J. A. W. Neander, *Church History*, Eng. tr., London, 1850-58.) Cf. also J. Müller, *Christian Doctrine of Sin*, Eng. tr., Edin. 1868, vol. ii. 1-226; W. Cunningham, *Reformers and Theol. of Reformation*, do. 1862, Essays viii. and ix., also *Historical Theol.*, do. 1863, vol. i. ch. xx.; H. B. Smith, *System of Christian Theology*, New York, 1891, chs. ix. and x.; cf. also *Free Church of Scotland Appeals (1903-4)*, ed. R. L. Orr, 1904, p. 477 ff.; also books on Dogmatics by H. L. Martensen (Eng. tr., Edin. 1874), C. Hodge (Lond. and Edin. 1875-78), J. J. van Oosterzee (Eng. tr., Lond. 1886), etc.; Marcus Dods, *EBR*, art. 'Predestination.' See also the additional authorities cited throughout the article.

DONALD MACKENZIE.

FRIENDLY ISLANDS.—See TONGAN RELIGION.

¹ For Hamilton and Mill, see art. LIBERTARIANISM AND NECESSITARIANISM.

FRIENDLY SOCIETIES.—I. The theory of mutual aid.—Friendly Societies are institutions formed for the purpose of mutual insurance, and have been one of the chief means employed by the working classes for providing against the risks of sickness, old age, and funeral expenses. The inadequacy of purely private providence to cope with the uncertainties of life and health among working people has been recognized from very early times, while religious and social fraternities have everywhere devoted some attention to guarding their members from losses due to these vicissitudes. The Greek *επαυος* appears frequently to have undertaken provident functions, and the mediæval gild in Germany and England used its 'box' or 'chest' for the purpose of assisting members in distress. Grants of burial money were a remarkably general feature of such fraternities, even when the common purse was used mainly for feasting, or when the primary object of association was the control of a craft. Some writers, indeed, assert that the modern Friendly Society is an actual descendant of the mediæval gild; but, except for some similarities in their fraternal functions and the fact that the English gilds decayed about the time when Friendly Societies took their rise, there is little to warrant the belief in any direct connexion. Feasting, attendance at funerals of members, solemn entrance oaths, contributions to the 'box,' processions to church, and assistance in times of distress, were common characteristics of fraternities of all kinds, and the fact that they appear in the earlier Friendly Societies does not suffice to prove that these institutions had any organic relation to the gilds. Possibly the customs of the gilds had an influence upon those of the Friendly Societies, but evidence for any closer connexion is lacking in England, although in Scotland, where the gilds continued in existence to a later period, some of them gradually merged into Friendly Societies as they lost their trade privileges. Cf. art. GILDS.

The Friendly Society is not a mere institution for promoting thrift. It must be sharply distinguished from Savings Banks, Building Societies, and similar organizations, which have afforded facilities for investment in small sums to the working classes. Its differentiating characteristic is that of mutual insurance as contrasted with individual investment, and in some important respects the security and welfare of the contributor may be more adequately promoted by becoming a member of a Friendly Society than by depositing small savings in a bank. Death, though certain, may come early or late. Sickness may fall upon one before he has had time to make any savings commensurate with the burden; to another, who has saved more, it may be so protracted as to consume all his reserve long before he is again fit for work; to a third it may not come for twenty or thirty years, and even then may be of brief duration. Old age, again, when the earning power ceases, is reached by a minority, and it may or may not be protracted in any particular case. Mutual insurance meets these contingencies as individual saving can seldom do, because the uncertainties of life and health for a single person may be almost translated into certainties when a large number of persons are concerned, so that, instead of taking account of the extreme possibility of the particular case, it is necessary only to proceed on the basis of average probabilities.

Many men could not possibly save sufficient to maintain themselves even on the barest necessities of life during a protracted old age; still more could not do so without undergoing very great privation during their working years. As it is also problematical whether they will ever reach old age, it may be quite unwise in some cases for them to

undergo the discomfort of saving much for this purpose, particularly if that would reduce their present industrial efficiency or retard the development of their families. But if, on a calculation of average probabilities of life in that social class, it can be shown that a contribution of a few pence a week from all will suffice to provide for the superannuation of those who do attain a given age, it may be well within the means of most of them to pay on this basis of average probabilities, although it would be unwise to save on the assumption of the extreme possibility of the individual case.

The risk of illness is precisely similar. Any individual may be suddenly stricken down with a long illness or even permanent disablement, and few working men could by private thrift provide against this extreme possibility; while even a brief illness may occur before sufficient has been saved to meet it. But provision for the average probabilities may come within the reach of the vast majority. The mutual insurance of Friendly Societies is based upon this principle of average probabilities; and, while ensuring systematic contributions from each member, it also shares the risk among a large group.

2. Recent growth of scientific methods.—Although there has always been implicit in Friendly Society activities some recognition of the principle of average probabilities, the actuarial data by which to calculate the proper contributions and benefits are a late development. The fact that certain contingencies occur with remarkable regularity, when sufficiently large numbers of persons are considered, may be generally known before even approximate estimates of the degree of frequency can be made. But, when account is taken of the further circumstance that mortality and sickness vary according to the occupations, economic conditions, and habits of the people, so that a table which is appropriate to a certain class or trade cannot forthwith be applied without modification to quite a different section of the population, it is scarcely surprising to find that a host of early Friendly Societies worked almost at random, and yielded a dismal story of insolvency and inability to meet the obligations which they had undertaken. For a few years, while the members were mainly at the healthiest periods of life, the Societies would appear to flourish; but it soon became manifest that, as the average age increased, the contributions and levies were insufficient to meet the higher risks, and dissolution precisely at the period when the needs of the members were greatest has been the melancholy experience of thousands of these institutions. Many of them had so little appreciation of the factors to be allowed for in the calculation of risks, that they proceeded on the assumption that a contribution from each member which sufficed to meet the outlay on benefits during the first year would also suffice permanently to cover all claims. It was not understood that the risks are largely prospective, so that even a Society with an accumulated fund might not be actuarially solvent. A valuation of its assets and liabilities might well show a deficiency. A Friendly Society is in a sound financial position only when the sum of its existing funds and the present value of the future contributions of its existing members equals or exceeds the present value of the benefits which those members may be expected to claim in the future, together with any expenses of management. The value of these prospective benefits depends upon appropriate estimates of sickness and mortality, which, again, depend upon such factors as the age of the members; and, similarly, the present value of prospective contributions is dependent upon the expectation of life at different ages, as

well as upon the rate of interest. It follows that a premium adequate to cover the risks must vary with the age of the entrant if the Society is to be permanent; and, in order to protect itself from an accumulation of bad risks, a voluntary Society must also refuse to admit individuals who do not give evidence of normal health. Periodically it should make a thorough valuation of its assets and liabilities; and, if this reveals a deficiency, arrangements should be made either to raise the premiums or to lower the benefits, since persistence in the old course will lead to eventual insolvency.

In the light of these general principles it is easy to account for the failures so abundantly manifest in the history of Friendly Societies. Ignorance of the actuarial factors, sometimes combined with dishonesty of officials, led to sad disappointment among the thrifty labouring people who sought to provide against the risk of pauperism through ill-health and old age. There are still many small Friendly Societies in existence which cannot stand before a valuation test, and every year adds a few of them to the long list of disasters. As, however, the long experience of some of the largest societies has been analyzed by competent actuaries and made available to the public, sound statistical data have accumulated, and a proper appreciation of the elements which must enter the calculations has become more widely diffused. On the whole, there has been a marked improvement both in methods and in stability during the last thirty years.

3. Historical development and legislative recognition.—The oldest existing Friendly Society is the United General Sea Box of Borrowstounness in Scotland, which was founded in 1634. In England, it is interesting to note that the Societies which can trace their history furthest back are those founded about the beginning of the 18th cent. by the Huguenot refugees in Spitalfields. Some of the earliest Societies were confined to workers in a particular trade, while others had distinctively religious restrictions, as in the case of the Society of Lintot, founded in 1708, in which the members must belong to the church of Lintot and be good Protestants, loyal to Queen Anne. These were all isolated local associations, and before the end of the 18th cent. such Societies had grown up in nearly every part of Great Britain. There are preserved in the British Museum the rules of a large number of these small clubs centring about Newcastle-on-Tyne in the second half of the 18th cent.; and there is abundant evidence that in most districts such organizations were then meeting at the village ale-houses, and included a large proportion of the population. The social and convivial side appears to have been pronounced, and one of the earliest references to them in the Statute book describes them as 'societies of good fellowship.'

Meanwhile there arose a new class, distinct from the local sick clubs, which has now become in some respects the most important form of Friendly Society, viz. the Affiliated Order, owing its inspiration mainly to Freemasonry (*q. v.*), and borrowing from that movement its rites and ceremonies, secret signs, and gorgeous costumes. Of greater moment is the fact that the Orders adopted the model of Freemasonry in their organization of local branches or lodges; and, though the chief emphasis at first was convivial, by the end of the 18th cent. the Free Gardeners, Oddfellows, Druids, Foresters, and Conical Fellows had developed into Friendly Societies with many branches.

The growing importance of the associations led to a general interest in them and a desire to afford them a better legal status, and to this end in 1793

there was carried through an 'Act for the encouragement of Friendly Societies,' which granted to them valuable privileges on condition of submitting their rules to the approval of the justices in Quarter Sessions. While a large number of local societies were enrolled and obtained a definite legal status under this Act, the Affiliated Orders were being repressed by other legislation aimed at Secret Societies whose members took any oath not required by law. Hitherto the enrolment of Societies under the Act had not restricted their financial management, and there were growing complaints of their instability and failure. In 1819, Parliament attempted to deal with this phase of the problem by requiring the justices, before confirming the tables of contributions and benefits, to see that they had been approved, by at least two persons who were professional actuaries or persons skilled in calculation, as fit and proper according to the most correct calculation of which the nature of the case would admit. Yet this bold attempt to secure financial soundness had little effect in practice. On the one hand, there was nothing to prevent Societies from operating without becoming enrolled by the justices, and any stringent requirements of this nature simply led to a decrease in registration. On the other hand, 'persons skilled in calculation' in practice frequently meant village schoolmasters and others who had no special training for the work, so that numerous Societies were still enrolled without sound financial bases.

In 1829, provision was made for central registration, a barrister being appointed to examine the rules of Societies; while, instead of the approval of the financial tables by two skilled persons, it was simply required that the justices should be satisfied that the tables could be adopted 'with safety to all parties concerned.' This meant, in effect, that the attempt to procure financial soundness by legislation was relaxed; and in 1834 even this mild provision was repealed, so that thereafter the Societies could adopt whatever rules, benefits, and levies they pleased, so long as the barrister certified that they contained nothing contrary to law. After this, Parliament vacillated on the question. In 1846, when a registrar took the place of the barrister, he was required to obtain an actuarial certificate before registering a Society; and it was enacted for the first time that every registered Society should be valued once in five years. But in 1850 these provisions were repealed, and in the amended Act of that year no arrangement for valuation was demanded, while a distinction was drawn between certified and registered societies. The former had their tables approved by a qualified actuary, while others were merely registered; but in point of fact very few Societies sought to obtain certification, and in 1855 a new repealing and consolidating Act abandoned all pretence to regulation of the financial tables of the Societies.

By this time the Affiliated Orders, which had been studiously ignored by the Friendly Society legislation until 1850, began to be recognized, though prior to 1875 they could register only as if each branch were a separate organization. They were the pioneers in securing financial stability by voluntary methods. The Manchester Unity of Oddfellows made a complete valuation of all its branches in 1870, and a partial valuation was made by the Order of Druids, thus paving the way for the provisions of the Act of 1875, which, in spite of later amendments and consolidations, contained almost all the chief legislative regulations affecting Friendly Societies before the National Insurance Act of 1911 came into force. Registration remained optional, and no endeavour was

made to impose upon Societies actuarially sound tables. Societies are still registered even if they charge small subscriptions and promise absurdly large benefits. But a registered Society comes under the obligations of making an annual return to the registrar and of undergoing a quinquennial valuation. This publicity conduces in some measure to financial soundness, although a Society which shows a deficiency in its valuation is not struck off the register, and is not compelled to raise its levies or lower its benefits unless the members decide to do so. Yet this method enables the members to ascertain the financial condition of the Society, and to remedy any defects if they so desire. Also, if a certain proportion of the members request it, the registrar must appoint an inspector to examine into the affairs of the Society, or must call a special meeting of members; though, again, the inspector may merely report, and the members are at liberty to disregard his statements or suggestions. If a Society becomes insolvent, members may apply to the registrar to wind up its affairs.

4. Membership and funds.—Although a Friendly Society thus surrenders little of its independence by becoming registered, there are still very many small local Societies which have not taken advantage of the legislation, and it is to be feared that most of them would show serious deficiencies in a valuation. The registered Societies, however, have become stronger, numerically and financially, since the passing of the Act of 1875. A large number of different organizations may register as Friendly Societies, including those which provide by voluntary subscriptions of members against such diverse risks as shipwreck, loss of tools by fire, or insurance of cattle; but these may here be neglected. Three groups of organizations account for 94 per cent of the total membership, and for 96 per cent of the accumulated funds, of all kinds of registered Friendly Societies in the United Kingdom. The growth of their membership and funds from 1877 to 1909 is shown in the following table; but it should be remarked in this connexion that many individuals are counted more than once, since it is not uncommon for a skilled workman to be a member of two Societies.

	Number of Members.		Amount of Funds.	
	1877	1909	1877	1909
Collecting Societies	2,439,988	6,829,164	£1,172,363	£9,117,347
Affiliated Orders	1,528,216	2,703,607	£7,752,050	£27,167,536
Ordinary Societies	1,287,670	3,526,639	£5,211,052	£20,987,352

5. Burial clubs.—The Collecting Societies, which, while registered as Friendly Societies, are also regulated by a Special Act of 1896, may be said broadly to deal with a poorer section of the population than do the other organizations, and to insure only for burial money. In 1909 they were 63 in number, and had a larger membership than the other two groups combined; but their relative importance is diminished if regard is had to the amount of their accumulated funds and to the fact that, as a rule, they do not provide for sickness or old age. Moreover, the majority of the members are young children. The work done by these Societies is very similar to that of the Industrial Assurance Companies, which do an enormous business in petty death policies; and from the standpoint of thrift they are subject to the same criticism of high cost of management. Here, as

in so many other cases, the poor have to pay proportionally much more than the well-to-do for the benefits they receive. The premiums are collected by canvassers at the houses of the insured, and the cost of this and of general administration absorbs about one-half of the contributions, so that for every penny invested for his own benefit the member pays another penny to agents and officials. Three Collecting Societies, the Royal Liver, the Liverpool Victoria Legal, and the Scottish Legal, together embrace about six millions of members, leaving under one million to the remaining sixty Societies. The accumulated funds appear to be very small relatively to the membership, but, in fact, a very high proportion of those who become members cease after a time to contribute, and the membership lapses. Thus, in the year 1909, 2,124,709 new members were admitted to Collecting Societies, 120,041 members died, while no fewer than 1,556,855 members lapsed in the single year. The melancholy conclusion at which the investigator arrives is that a large part of the membership is temporary, and never obtains any return for the premiums. That there is a clamant need for the institution of a system of small insurances for payments at death, in which the poor would receive benefits commensurate with the premiums, is manifest to all who have practical acquaintance with the lives of the poor; but, so long as the contributions have to be collected in pence from door to door every week, there seems to be little chance of meeting this need. Nor are the cost of management and the number of lapses the only drawbacks. Despite the small number of Collecting Societies, there are almost every year some that collapse after obtaining the money of the poor. Speculative assurances on the lives of persons in which the contributor has no real interest are believed to be frequent, although they are contrary to law. Sometimes, too, there is said to be danger to infant life in the practice of insuring babies, though for a child under five years of age the maximum payment at death is fixed by law at £6. Yet it must be granted that the Collecting Societies induce some provision for burial, and for small benefits to survivors, among a poor and improvident class who would otherwise remain untouched by the institutions for thrift.

6. **Sickness insurance by Friendly Societies.**—The Affiliated Orders provide for sickness as well as sums at death, and frequently for superannuation and other minor risks. Their aggregate funds are higher than those of the other two groups, although their membership is the lowest. They differ from the Collecting Societies in the following important respects. (1) They administer sickness benefits, which it is generally impossible for a Collecting Society to undertake because of the supervision required as a check to malingering. These benefits usually include medical aid, as well as the more important grants of weekly sums to members who are ill and, consequently, incapable of earning. (2) They are organized on a basis of self-government by the insured, while the Collecting Societies are managed by a hierarchy of paid officials. Consequently, the expenses of management are about 10 per cent of the receipts as contrasted with 50 per cent in the Collecting Societies. (3) They permit of a common bond among the members, who meet in the local lodges, courts, tents, or divisions, for social purposes and for the discussion of topics relating to their general welfare.

These advantages are generally found in the ordinary or single Friendly Societies as well as in the Affiliated Orders; but the latter have the distinctive merit of supplementing local independence

with a salutary central control. The lodge manages its own affairs in an area sufficiently small to admit of thorough supervision and social life, thus providing an excellent unit for friendly relations, political training, and discussion, as well as for checking malingering; while the lodges are usually grouped into districts in which the claims for funeral money are equalized and the accumulated funds invested to better advantage than could be done by the lodges themselves. It was customary until recently for the district body, composed of delegates from the lodges, to levy sums from the lodges to meet the funeral expenses when they occurred; but latterly this has developed into a system of charging premiums from each lodge in accordance with the age-constitution of the members. Above these there is the central body, or general meeting of delegates from the districts and lodges, which is either held permanently in some city or moves from place to place. This 'high court,' or 'movable committee,' secures capable men for the guidance of the Order, makes general rules which the lodges must observe, often prescribes the rates of contribution, and administers a central fund for the aid of branches that are in difficulties, when it is deemed advisable to render such assistance. This, however, does not amount to a guarantee of the solvency of each lodge by the central body. The relative importance of the different forms of benefit is indicated by the fact that out of nearly £20,000,000 paid to the members of the Ancient Order of Foresters during the thirty years from 1876 to 1905, 72 per cent was devoted to sick pay for the maintenance of members during illness, 12 per cent to medical aid, and 16 per cent to funeral allowances.

The group designated 'Ordinary Friendly Societies' includes a great variety of bodies, from the small local benefit club to the centralized class, the strongest of which is the Hearts of Oak, with a membership of over 300,000 in 1909. The centralized Societies dispense all benefits from the head office, and they are unable to check malingering so efficiently as a local society or branch, since they must depend solely on the medical attendant without the aid of the visitations of fellow-members. Consequently, the rate of sickness, even in the best centralized Society, is in excess of that experienced by the Foresters or Oddfellows, where the local court or lodge provides against fraud. There are also local Societies confined to particular trades, especially among miners and railway servants, Societies of juveniles and of females. Moreover, in addition to the membership shown in the foregoing table, there are a great many village clubs and county Societies that have not registered and, therefore, do not enter the returns.

7. **Dividing Societies.**—Some of the small Societies still adhere to the primitive method of dividing the surplus each year among the members. They charge weekly sums, frequently higher than those levied by other Friendly Societies, pay sickness benefits to the members who may be ill during the year, and divide the remaining funds among all the members at the end of the year, carrying forward only a small reserve. Such Societies, sometimes called 'tontines' and 'slate clubs,' appeal very strongly to the working classes in some parts of the country; but they obviously lead a precarious existence, from the fact that they have no accumulated funds and virtually begin afresh every year. From the standpoint of insurance this is a very questionable method, for the older members are liable to be left out of the Society precisely when their sickness is greatest. Though there may be no intention to dismiss every year the members who have become burdensome to the funds, it generally happens in practice; for, if they

do not leave the club, the younger and healthier members break away and form another Society of their own, so that the original Society soon collapses. The inadequacy of a Dividing Society is manifest from the fact that, while the expectation of sickness is about one week per annum at the age of 30, at the age of 48 it is two weeks, at 53 it is three weeks, at 57 it is four weeks, and increases rapidly thereafter. Hence insurance against sickness is mainly a provision for the later years of life, and a Society which accumulates no fund can scarcely be said to cope with the chief problem. Despite this disadvantage, however, the Dividing Societies attract large numbers of members, who use them for the purpose of saving for Christmas expenditure as well as for sickness benefits; and since 1875 they have been permitted to register on condition that no division of funds takes place before existing sickness claims have been met.

8. Lapses from membership and deficiencies of funds.—One of the greatest weaknesses attaching to Friendly Societies as a whole, and, indeed, to every form of voluntary health insurance, has been the large number of lapses from membership. In recent years the Affiliated Orders and the Ordinary Societies have experienced about three lapses from membership for every four new members added. Thus in 1905, while 458,854 new members were admitted, 64,528 members died, and 338,235 members lapsed. A large proportion of these lapses were due to temporary difficulty in maintaining the contributions. In the Collecting Societies, as was observed above, the number of lapses is still greater.

The other serious weakness is that a very large proportion of the small Societies still show a deficiency in their periodical valuations: and, beyond ensuring publicity in the case of registered Societies, the law imposes no obligation upon them to take steps towards solvency. A large Affiliated Order is usually financially sound, because the central body not only imposes upon the branches an official valuation, but, if a deficiency is revealed, the branch is compelled to readjust its contributions or benefits. Lacking this salutary control, however, the small independent Societies promise benefits out of proportion to the contributions, which they may succeed in granting for many years when the average age of the members is low, but, as a result, many of them show increasing deficiencies at every valuation, until they finally fall to pieces when the rate of sickness and mortality becomes high.

9. The Friendly Society work of Trade Unions.—Many Trade Unions have undertaken the provision of sickness and funeral benefits, in addition to the more distinctive unemployment and strike benefits. It is estimated that about 1,500,000 trade unionists subscribe for burial money, and about 900,000 for sick pay. But the friendly functions of Trade Unions have been carried on without reference to actuarial calculations, since the primary object has been to have all the funds available for strike purposes at any moment. No adequate reserves have been kept, and from the standpoint of mutual insurance the Unions have always been financially inferior to good Friendly Societies. They have never viewed their contract to pay sickness benefits as binding. They may expel a member at any time if he disobeys orders during a strike or accepts less than the standard wage; and, although he may have paid for years to the sick and superannuation funds, he can claim nothing. They may alter or abolish the benefits in any period when the funds are required for strike pay. In view of the entire absence hitherto of any guarantee that the funds would be reserved to meet the sickness benefits, this system cannot be ranked with the health insurance of Friendly Societies.

10. Effect on Friendly Societies of the National Insurance Act.—The National Insurance Act of 1911, which made insurance against sickness compulsory upon a large proportion of the population of the United Kingdom, is, in the main, being worked through the agency of the Friendly Societies, subject to the approval of their rules by the Insurance Commissioners. This measure has led to a great increase in the membership of the Societies, and to a strengthening of their financial position. Allowing for the many persons who belonged to more than one Friendly Society, and for the overlapping of membership between these Societies and the Trade Unions, it is probable that in 1911 not more than 5,000,000 individuals in the United Kingdom were insured against times of sickness by the voluntary system. The actuaries who worked out the statistical data for the Insurance Act estimated that in 1912 the persons compulsorily insured against sickness would number over 13,000,000, in addition to those who might voluntarily avail themselves of the provisions. From the data now available (Jan. 1913) this estimate seems likely to be realized, the vast majority of this number having already become members of existing Friendly Societies or formed new ones. The conditions attached to approval of Societies under the Act, and the financial supervision by the central Government for which provision is made, should also suffice to afford due protection to the members. Indeed, the plan of finance is so arranged as at the same time to increase the assets and to relieve the liabilities of existing Friendly Societies, thus putting most of the small insolvent Societies on a sound basis as a start, while it will keep them solvent in future by the rules and supervision imposed upon them. It will no longer be possible for a Society to run on indefinitely with a deficit, as it will cease to be approved under the Insurance Act, and so cannot receive the compulsory contributions from the workman, the employer, and the State. The benefits or contributions must be adjusted every three years to the position shown in the official valuations. A Collecting Society can be approved under the scheme of health insurance only if it institutes quite a separate branch for the purpose; while Trade Unions must keep the funds quite distinct from their 'fighting' resources, and must observe all the regulations applicable to other Societies, if they wish to take part in the administration of the Act. See also art. INSURANCE.

LITERATURE.—C. Hardwick, *History of Friendly Societies*, Manchester, 1869; J. F. Wilkinson, *The Friendly Society Movement*, London, 1886, and *Mutual Thrift*, do. 1891; J. M. Bärnreither, *English Associations of Working Men*, do. 1891; E. W. Brabrook, *Provident Societies*, do. 1898, and *The Law of Friendly Societies*¹⁴, do. 1909; A. C. Stevens, *The Cyclopaedia of Fraternities*, New York, 1899; *Annual Reports of the Chief Registrar of Friendly Societies*, London, 1887-1911.

STANLEY H. TURNER.

FRIENDSHIP.—One of the numerous 'essayers upon friendship' justly observes that 'there is no subject of morality which has been better handled and more exhausted than this' (Addison, *The Spectator*, no. 68). The leading Greek thinkers represent the view of this virtue that prevailed in the ancient world; and perhaps the things they said first on the subject are not only the most original, but the best. Roman friendship was formed on the model of Greek, and the celebrated treatise of Cicero, *de Amicitia*, apart from its attractiveness of style and reminiscence, seems to have been drawn in substance from Aristotle's successor, Theophrastus. The halo thrown around ancient friendship has been dispersed by the ideals of Christianity; and the tie of marriage, wherever social and moral enlightenment has been reached, has in great measure superseded the tie of friend-

ship, which knit together heroic pairs like Achilles and Patroclus in the Homeric age, and bound master and scholar, or like-minded youths, in the gymnasia of Greece. Friendship, as a modern sentiment and force, is directed by ends and motives that were not present in pagan society. We shall see this by considering the subject in some of its historical phases.

I. *PLACE AND DISCUSSION OF FRIENDSHIP IN ANTIQUITY.*—It is the poets, and especially the philosophers, of Greece who present the ancient view of friendship, and from them we see its extraordinary influence in intellectual discourse, and in social life and institutions. The conditions of society explain the rise of this sentiment, and the prominent place it was allowed to fill. Ordinarily the position of woman was inferior, and the State, as in Plato's *Republic*, dwarfed the individual. The traditional religion failed to supply adequate motives for conduct, and thus friendship became a social distinction, a moral safety-valve, and an intellectual and religious inspiration. The citizen or politician who sought an escape from the hardness and corruption of society could say with Socrates, 'I have a passion for friends' (Plato, *Lysis*, 211). Friendship, indeed, touched Greek life and morality with emotion, and acted with 'the expulsive power of a new affection.' Its exercise is a revelation of the Greek mind, and its history is the summary of Greek moral life (Dugas, *L'Amitié antique*, 400). In a delightful essay, which fixes attention on this feature, Harnack points out that 'the history of the Greek schools of philosophy is at the same time the history of friendship' (Excursus on 'Friends,' in *Expansion of Christianity*, Eng. tr., 1905, ii. 25-34). See, further, the following article.

II. *FRIENDSHIP IN THE OT AND IN CHRISTIANITY.*—I. Dignity and attractiveness of Hebrew friendship.—Unlike some religions (*e.g.* Hinduism) which tend to repress individuality, the religion of Israel stimulated patriotism and the production of characters of a high and heroic type. At the different and critical periods, therefore, of Hebrew history, men and women were not wanting who could assume the responsibilities of leadership and wield a corresponding influence. It has been rightly said that the key to friendship lies in individuality, and that the OT knows well to appreciate this virtue, as history and circumstances required it (Rothe, *Theol. Ethik*, 1845-48, iv. 68 f.). Both on account of the high and brilliant examples that attract our notice, and the number of wise and sententious utterances that call attention to the importance of this subject, the claim that friendship receives a favourable and prominent place in the Hebrew Scriptures, and in Jewish literature as a whole, is fully justified.

The historical books of the Bible furnish several instances of genuine friendship; and the pithy sayings of the Wisdom literature, of Talmud, and of Midrash, contain a philosophy of friendship. The Bible endows friendship with a peculiar dignity by making it symbolical of the intimacy that exists between God and man (*JE* v. 520, art. 'Friendship').

One peculiar and determining consideration has to be mentioned. Under the influence and history of revelation, the consciousness of God as an overruling but gracious Power rose to clearness and intensity in the Hebrew mind. Later, in the schools of Greece, the Divine Being was the object of dim and remote speculation. But already in Israel the faculty of spiritual intuition was being trained, and God's entrance into friendship with men gave rise to a new and astonishing line of experience. Abraham and Moses, the outstanding figures of Hebrew history, not only towered above their fellows in virtue of their leadership, but, on account of the intimate and wonderful intercourse they were admitted to, stood in the unique position

of 'friends' of God (Ex 33¹¹, Is 41⁸). This conception or relationship never entered the mind of a thinker like Aristotle, who held that friendship is destroyed when persons are separated by a wide inequality; and therefore between God and man, or personalities so far removed from one another, friendship or intercourse was not conceivable (*Eth. Nic.* bk. viii. ch. vii. [Grant's notes]).

We may glance at some of the examples contained in the OT. The friendship between Ruth and Naomi, recorded in a charming fragment of literature, is a specimen of what is not often celebrated in classical writings, viz. an independent and beautiful relationship between women. Ruth's expression of affection and loyalty (Ru 1^{16L}) corresponds to the warmth and disinterestedness of sentiment incorporated in the Greek and Roman ideals, and exhibits the two component elements which, in Emerson's view (*Essays*, 'Friendship'), make up friendship, and are named *truth* and *tenderness*. That author, in the course of his sparkling and paradoxical essay, describes unconsciously, in defining the end of friendship, the traits that distinguished the friendship of Ruth:

'It is for aid and comfort through all the relations and passages of life and death. It is fit for serene days and graceful gifts, and country rambles, but also for rough roads and hard fare, shipwreck, poverty, and persecution.'

More celebrated and influential is the relationship between Jonathan and David, who form the classic pair, the Pylades and Orestes, of the OT, and whose friendship was formed spontaneously, and pledged deeply and lastingly (1 S 18¹⁻⁴). Each of these noble characters, in their perfect intercourse and devotion, felt to the other as to himself, and their attachment was, in Aristotle's phrase, applicable to the friendship of the good, 'incapable of being disturbed by accusations' (Grant's *Aristotle*, ii. 259). No friendship on pagan soil can rival the qualities displayed by Jonathan and David: 'the best that Greece and Rome have to show of friendship looks pale beside this' (J. C. Shairp, 'Friendship in Ancient Poetry,' *N. Amer. Rev.*, Nov. 1884). In their case, the 'prelude' or preliminary trial, required by prudent moralists, was unnecessary. As Jeremy Taylor puts it, in a sentence marked by less than his usual amplitude (*Works*, i. 86), 'some friendships are made by nature, some by contract, some by interest, and some by souls.' The beauty of Jonathan's friendship has been immortalized in David's elegy (2 S 1²⁶), and the intercourse of these twin souls stirs fresh admiration in the historian, who sees in it a healthy testimony to the period in which it was realized, and the spectacle of 'a friendship which shines for all ages as an eternal type' (Ewald, *Hist. of Isr.*, Eng. tr., iii.², 1878, p. 76). In the personal attendants who accompanied and ministered to the Hebrew prophets (*e.g.* Elisha, the servant of Elijah [2 K 3¹¹]), in the band of disciples who gathered round Isaiah as their spiritual leader and guide (Is 8¹⁶), and in the circle of godly people who drew together in degenerate and dangerous times (Mal 3¹⁶), we see further interesting developments of this principle, and how various are the sympathies and services that test and prove the worth of friends.

What may be termed the 'Directory' of the OT on the subject of friendship is to be found in the Book of Proverbs. Its pointed and scattered sayings crystallize the maxims and warnings drawn from Hebrew wisdom and experience on this topic, and contain a practical philosophy designed to meet some of the duties and dangers connected with friendship and companionship. A few instances will suffice. (1) *Prudence is required in choosing friends*: 'walk with wise men,' etc. (Pr 13²⁰). (2) *Friendship may prove closer and more enduring than natural relationship*: 'a friend loveth at all

times,' etc. (17¹⁷, cf. the latter half of 18²⁴). This excellence is noticed also by Cicero: 'whereas you may eliminate affection from natural relationship, you cannot do so from friendship' (*de Amic.* ch. v.).

(3) *Plain speaking is sometimes a duty, and is better than flattery*: 'faithful are the wounds of a friend' (27⁶). (4) *A primary virtue in friendship is loyalty*: 'thine own friend, and thy father's friend, forsake not' (27¹⁰); cf. Shakespeare, *Hamlet*, I. iii. 62:

'Those friends thou hast, and their adoption tried,
Grapple them to thy soul with hoops of steel.'

(5) *Intercourse is the life and soul of friendship*: 'iron sharpeneth iron; so a man sharpeneth the countenance of his friend' (27¹⁷). Similarly, in Aristotle's judgment (*Eth. Nic.* ix. 12), men brighten each other's powers, and add to the zest of life, by frequently coming together; cf. Tennyson's tribute to Hallam, *In Memoriam*, canto cx., 'Thy converse drew us with delight.' So cordial and practical is the Hebrew appreciation of friendship and its blessings (cf. Sir 6¹⁸ 'a faithful friend is a medicine of life').

2. *Distinctiveness and reality of Christian friendship*.—It is an old and almost a stock objection that friendship occupies a subordinate place in the NT, compared with the prominence assigned to it in ancient ethics. Certainly, it is nowhere made the subject of formal discussion and of express precept. This reproach has been traced to the period of the Renaissance and the rise of Humanism, when men turned admiringly to the models of classical art and literature, and when the worship of friendship became a romantic and religious passion. The objection has received attention at the hands of writers on Christian ethics (Rothe, followed by Luthardt, Martensen, and Köstlin), and is reproduced by Aristotle's sympathetic commentator in the passing judgment that 'Christianity ignores friendship' (Grant's *Aristotle*, ii. 250).

The difficulty is hardly solved, in Rothe's manner, by distinguishing between the writings of the NT and Christianity, and still less by the admission that no proper examples of friendship meet us in these writings. It is true that the relationship of Jesus to the Twelve, and in particular to individuals like John and Lazarus, did not contain the element of 'equality' which marks ordinary friendship. But this feature should not be pressed unduly. Jesus welcomed His disciples and followers to the higher platform of His friendship, and made their admission to His confidence and intimacy a matter of distinct recognition (Jn 15¹⁶). It is right, therefore, to take the friendships we find in the NT in their natural and honest sense (see Stalker, *Imago Christi*, 1889, ch. v. pp. 93-95, where this objection is vigorously challenged).

But, while Christianity does not ignore friendship, it absorbs it in a deeper current, and creates out of the ancient relationship a special and distinct type. The ordinary category of friendship is no longer prominent, and the virtue characteristic of pagan ethics is transformed. The contrast is noteworthy. The ancient world was distinguished by friendship, which was enjoyed as a privilege by few; the new world originated by Christ and the gospel is distinguished by love, which may become the possession and inspiration of all. While, therefore, Christianity enters into the natural order of society, and assimilates institutions like the family and friendship, it transforms their character and content, and moulds anew the types and ideals that formerly prevailed. Love to Christ is the mainspring of the new moral world, the 'golden thread' which binds men to their Divine Master and to each other; and this friendship, on the part of Christ's followers, is prompted as the response to His own supreme

act of friendship, and must be evidenced in each case by the virtues of sincerity and obedience (Jn 15¹³).

Apart from this general conception of friendship which distinguishes Christianity, and the use of the term 'friends' in its ordinary and natural sense (Lk 12⁴, Jn 11¹¹), there are two instances that call for remark. In Ac 27³, mention is made of Paul's friends (*τοὺς φίλους*) whom he was allowed to visit. The expression may be taken as simply synonymous with Christian brethren and disciples, previously known. Again in 3 Jn 14 the closing salutation runs: 'The friends (*οἱ φίλοι*) salute thee. Salute the friends by name.' This shows that the primitive communities of the NT, or groups of Christians, constituted an inner circle of disciples and brethren, and that the term adopted by Jesus continued to carry a special and spiritual meaning. But in neither of these cases need we infer that the term is used in a technical sense, or that the first Christians applied this title to each other as it had been used professionally by Greek philosophers or the Epicurean school. Harnack points out that the early Christians, in accordance with the fellow-feeling which animated them, preferred the warm and close term of 'brethren' to that of 'friends,' and that later, in the 14th and 17th centuries, with the rise of the *Gottesfreunde* (see FRIENDS OF GOD) in Germany and of the Quakers (see FRIENDS, SOCIETY OF) in England, the term 'Friends' was appropriated, and acquired its special usage (*Expansion of Christianity*, Eng. tr., ii. 31-34).

III. *QUESTIONS IN THE STUDY OF FRIENDSHIP*.—A few remaining points involved in the elucidation and appreciation of this subject may be presented.

1. *Friendship and youth*.—It is generally acknowledged that youth is the golden period of friendship. Aristotle did not fail to notice, however, the impulsive tendency of youth to enter on and dissolve friendships in one day (*Eth. Nic.* bk. viii. ch. 3). On this account Cicero observes that such enthusiastic attachments, readily contracted at games, are not to be trusted, and that men must come to maturity before their friendships can be regarded as solid and permanent (*de Amic.* ch. xx.). On the other hand, modern ethical writers (e.g. Schleiermacher and Rothe) properly allow that, when the tutelage of the family is left behind, and character is still open and impressible, friendships may be considered not only natural but invaluable. This fact suggests that the friendships of youth should not be arbitrarily hindered, but wisely fostered and directed. The question as to the place of friendship in modern education arises here, and has been commonly neglected. The Greek custom of turning friendship at this stage into a recognized institution, and of laying down rules to guide elder youths who are responsible for those under them, is worthy of imitation (Muirhead, *Chapters from Aristotle's Ethics*, 1900, p. 185 ff.; and E. Carpenter, art. 'Affection in Education,' in *IJE*, 1899, pp. 482-494). In a curious 'Fragment of an Essay on Friendship,' the poet Shelley refers to an attachment, at the age of eleven or twelve, to a school-companion as his introduction to 'the sacred sentiments of friendship.' In this sphere the discipline of healthy moral training is indispensable (cf. Lecky, *The Map of Life*, London, 1899, p. 237).

2. *The number and choice of friends*.—(1) If friendship is viewed as an example of the concentration of feeling and sentiment, then Aristotle's opinion that a plurality of friends is not possible or desirable seems justified. The classical friendships were in pairs, and it is contrary to human nature to stand the strain of intimacy or intense

occupation with many (*Eth. Nic.* bk. viii. ch. 6, ix. ch. 10). But it is unwarranted to say that we can have but one friend, and that our having many friends is a proof that we have not yet found the true friend (Rothe). On this point Hebrew Wisdom saw the danger of alliance with multiplied friends or advisers (Pr 18²⁴ [RV]; cf. Sir 6⁹); and Plutarch humorously observed that it is difficult to satisfy the conflicting wishes of a number of friends who would have one go on a voyage, appear at a law-court, and attend a marriage or funeral (Dugas, p. 321). The law of parsimony, or quality rather than quantity of friends, is the true principle. 'The condition which high friendship demands is ability to do without it' (Emerson). 'When a man has six friends, to introduce a seventh is usually hopeless' (R. L. Stevenson, *Letters*, ed. Colvin, ii. 133).—(2) Socrates lamented that men attended to trifling matters, but took so little trouble in choosing their friends (*Xen. Mem.* bk. ii. ch. 4). In the same vein Aristotle valued friendship as the outcome not of passing emotion but of settled moral purpose (*προαίρεσις*). The fact that friendship has this voluntary character, and is specially a bond of our own making, explains the severity of the punishment meted out by Dante to traitors to friends and guests, who have more claim on our loyalty than even natural kinsmen (*Inferno*, canto 33; cf. J. S. Carroll, *Exiles of Eternity*, London, 1903, pp. 429, 453). At the same time, there is a subtle and potent influence at work in friendship which defies analysis. In his sprightly manner, Montaigne (*Essays*, Eng. tr., bk. i. ch. 27) says: 'If a man urge me to tell wherefore I loved him, I feel it cannot be expressed but by answering: Because it was he, because it was myself.' In certain cases like draws to like, or one seeks in another what is wanting in himself (Tennyson, *In Memoriam*, canto lxxix.). But, again, the act of choice may be superseded, and friends come to our door 'unmasked, unhelped' (Newman), with whom we associate no particular feeling of gain or advantage, and who rule by the irresistible spell of character and personality.

3. Types of friendship.—The varieties of friendship have been enumerated by different writers (see Lemme's treatise, ch. iv., 'Die Formen der Freundschaft'), and are noteworthy. In antiquity the heroic type appeared early and called forth admiration and self-sacrifice on the part of comrades. Among the philosophers and politicians of Greece, friendship assumed also specific forms, which will always find their opportunity in society, and may be classed as friendships of vocation. In modern times the rise in the spirit of friendship, and in the character of the services and benefits which friends seek to render, is mainly due to Christianity. Three standing types may be mentioned. (1) *Sentimental* friendships. This variety blossoms in the season of youth, and was seen in the shallow and romantic attachments that were fashionable in Germany in the 17th and 18th centuries. Feeling, rather than intellect or character, is the cause of their formation, and also of their want of durability.

Perhaps Lessing's light and amusing comedy, *Damon, oder die wahre Freundschaft* (1747), is the best example of this sort of friendship, and hits off admirably its foibles and absurdities. Damon and Leander, two of the principal characters in the play, are such conscientious and devoted friends that neither will claim the hand of the widow with whom they are in love, for fear of disappointing the other. Lessing employs the wit of the widow's maid to explode effectually this dry, lofty, and impracticable notion of friendship.

(2) *Intellectual* friendships. The capacity for friendship was traced by Aristotle to the exercise of man's intelligence or thinking faculty, and modern psychologists agree in holding that sympathy or friendship is in part an intellectual endowment, and cannot flourish under conditions

where the requisite amount of intelligence, in individuals or tribes, is not attained (Bain, *The Emotions and the Will*, London, 1865, ch. vi. p. 87). In this class, æsthetic, literary, and scientific friendships may be combined. The condition of freshness in these relationships is that minds keep growing, and are always capable of contributing something to enrich the common stock of ideas. To keep friendships in repair, in accordance with Dr. Johnson's maxim, is a matter of intellectual as well as social duty and difficulty. The friendship of Goethe and Schiller is a celebrated example of this class, and shows how men of culture come gradually to approach each other, and can subordinate differences of temperament and character to community of aim in pursuit of art and truth (see Carlyle's *Life of Schiller*, pt. ii. and App. no. 3).

(3) *Religious* friendships. Here friendship reaches its highest intensity (Rothe), and friends 'treat of the deepest of human affairs' (Martensen). The respect and reverence due to friends are seen at their best in this circle of relationships, and it is in the practical religious life that the fruits of friendship are most valuable and necessary, viz. 'peace in the affections and support of the judgment' and 'aid and bearing a part in all actions and occasions' (Lord Bacon). A typical example of this class is the friendship of Luther and Melancthon—another evidence that friendship at its deepest rests not on agreement of opinions, or identity of constitution, but on those underlying principles and convictions that are rooted in a common spiritual experience.

The characteristics and atmosphere peculiar to this type of friendship—a type unknown to the pagan world—are seen in a volume, now rare, published by Delitzsch in 1842, consisting of essays by others, and two by himself, on Christian friendship (quoted below). The titles are such as these: 'The Character of Christian Friendship,' 'The Observance of good Habits in Christian Friendship,' 'On friendly Prayer,' 'Indecent Trifling of God's Children with Friends,' 'The Eternity of Christian Friendship.' One of the authors of these essays was Susanna Cath. von Klettenberg, a friend of Goethe's mother, the 'Schöne Seele' of *Wilhelm Meister* (Carlyle's tr. bk. vi., 'Confessions of a Fair Saint').

Ordinary friendship, as was seen long ago, is rooted in nature and society. This highest type of friendship is rooted in God, and is the goal of man's spiritual experience and endeavour.

LITERATURE.—Plato, *Lysis*; Aristotle, *Nicom. Ethics* (bks. viii. ix. [Grant's commentary, 1874, full and valuable]); Cicero, *de Amicitia*; Kant, *Metaphysic of Ethics*, Clark's tr., 1871, pp. 278-282; H. Sidgwick, *Methods of Ethics*, 1884, pp. 255-258; C. E. Luthardt, *Moral Truths*, etc., Clark's tr. 1876, Lect. x.; H. L. Martensen, *Christian Ethics (Social)*, Clark's tr., ii., 1882, pp. 72-77; L. Lemme, *Die Freundschaft*, 1897 [a useful treatise in 5 chapters], and art. 'Freundschaft,' in *PRE*; J. Taylor, 'Discourse,' *Works*, vol. xi.; the *Essays* of Montaigne, Bacon, Addison, and Emerson; F. Delitzsch, *Philemon, oder das Buch von der Freundschaft in Christo*, Gotha, 1878; H. Clay Trumbull, *Friendship the Master-Passion*, 1892; L. Dugas, *L'Amitié antique*, Paris, 1894 [a learned and elaborate treatise on philosophic theories and ancient manners]; Hugh Black, *Friendship*, 1897 [popular and suggestive]; art. 'Friend,' in *HDB*, vol. ii., and 'Friendship,' in *DCG*, vol. i. Of poems inspired by this theme, Milton's *Lycidas*, Schiller's ballad, *Die Bürgschaft*, and Tennyson's classic tribute, *In Memoriam*, are examples. See also Hallam, Lord Tennyson, *Tennyson and his Friends*, London, 1911 [a charming volume].

W. M. RANKIN.

FRIENDSHIP (Greek and Roman).—I. The Seven Sages.—Each of the seven sages had his say on the matter. Thales of Miletus admonished men to remember their friends whether present or absent (Diog. Laert. i. 37). Pittacus of Mitylene gave the advice, 'Speak not ill of a friend,' adding, 'or even of an enemy' (*ib.* 78). Bias of Priene suggested 'loving as though one might hate,' giving as his reason that 'most men are bad' (*ib.* 87). Solon's word of wisdom to the world was, 'Get not friends quickly; but, when you have got them, do not reject them' (*ib.* 60). Cleobulus of Lindus said that 'one ought to benefit

a friend, so that he may be more a friend, and to make an enemy into a friend; for one ought to be on one's guard against the censure of friends and the plots of enemies' (*ib.* 91). Even Periander of Corinth had his amiable sentiment on this subject. 'Be the same to friends in their good and evil fortune' (*ib.* 98). Chilon the Lacedaemonian went further, by bidding men be 'more ready to join in the ill fortune than in the good fortune of their friends' (*ib.* 70). Plato (*Prot.* 343 A), in his list of the Sages, substitutes for Periander a very obscure person called Myson, who is not credited with any saying on friendship. It appears to have been alien to his temperament, for the story runs that he was caught chuckling when he imagined himself to be alone, and admitted that it was because he imagined himself to be so (*Diog. Laert.* i. 108). The reason for the exclusion of Periander by Plato was doubtless the detestation which that philosopher felt for tyrants. Anacharsis the Scythian, who was Greek on his mother's side, is sometimes reckoned as one of the Seven. His remark is uncontroversial, that 'it is better to have one friend who is worth much than many who are worth nothing' (*ib.* 105). These sentiments of the Sages received general applause, with the exception of that of Bias, which became a scandal to idealists. Cicero makes Scipio single it out for condemnation (*Lael.* 59). Still, when coupled with its counterpart, 'to hate as though you might love,' which, if not said by Bias himself, was added for him (*Arist. Rhet.* ii. 13. § 4), it became part of the general Greek doctrine of moderation, and, as such, received poetical expression both from Sophocles (*Ajax*, 679-683) and from Euripides (*Hipp.* 253-260), and philosophical approval from Philo (ii. 401) and from Aulus Gellius (i. 3. 30).¹ Another remark made by Bias displays the same shrewd practicality. He said that it is better to judge between one's enemies than between one's friends; for in the latter case *one* is sure to become an enemy, in the former a friend (*Diog. Laert.* i. 87). The Sages lived in the early part of the 6th cent., being referred to the year 586 B.C. as a meeting point.

2. Pythagoras.—Let us now descend to the latter part of the same century, and come to the philosopher Pythagoras (*A.* 531 B.C.). As Pythagoras instituted a communistic brotherhood, it is natural that the proverbial saying, *κοινὰ τὰ φίλων*, should be attributed to him.² So is another word which goes deep into the heart of the matter—that about one soul in two bodies.³ No less penetrating is the saying that friendship is equality, which is ascribed to the same source.⁴ The addition of the adjective 'harmonious' to 'equality' is peculiarly Pythagorean (*Diog. Laert.* viii. 33).

3. Socrates (Xenophon, Plato).—The Ionic School was too much occupied with physics to attend to friendship. So we drop at once from Pythagoras to Socrates. He was the first of the Humanists, the first to say in effect that 'the proper study of mankind is man.' This was a reversion to the attitude of the Sages, who, with the exception of Thales, were more occupied with man himself than with his dwelling-place. The views of Socrates on friendship are preserved to us in the *Memorabilia* of Xenophon, and to some extent also in the *Lysis* of Plato. The second

¹ This last author attributes it to Chilon: 'Hac,' inquit, 'fuit ames, tanquam forte fortuna et osurus, hac itidem tenus oderis, tanquam fortasse post amaturus.'

² *Diog. Laert.* viii. 10. x. 11; Plato, *Lysis*, 207 C; *Arist. Eth. Nic.* viii. 9. § 1, *Eth. Eud.* vii. 2. §§ 33, 38; *Ter. Ad.* 803 f.; *Cic. Off.* i. 51; *Mart.* ii. 43.

³ *Arist. Eth. Nic.* ix. 8. § 2, *Eth. Eud.* vii. 6. §§ 7, 8, *Mor. Mag.* ii. 11. § 44; *Cic. Lael.* 81, 92, *Off.* i. 56 ('efficiturque id, quod Pythagoras vult in amicitia, ut unus fiat ex pluribus').

⁴ *Eth. Nic.* viii. 5. § 5 (*φιλότης ἰσότης*), viii. 8. § 5 (*ἡ δ' ἰσότης καὶ ὁμοιότης φιλότης*), ix. 8. § 2 (*ἰσότης φιλότης*); *Diog. Laert.* viii. 10 (*εἰς τε πρώτος . . . φίλιαν ἰσότητα*).

book of the *Memorabilia*, with the exception of the first chapter, might be entitled *περὶ φιλίας*. The second chapter is a homily on filial affection, in which Lamprocles, the eldest son of Socrates, is exhorted to bear with his mother, in spite of her shrewish tongue. He is reminded of all that a child owes to a parent, especially to a mother, and it is pointed out to him that, while the State neglects all other forms of ingratitude, ingratitude towards a parent is punishable by law. As a fitting sequel to this chapter there is a little sermon on brotherly love, which might have been preached from the text:

'Behold, how good and how pleasant it is
For brethren to dwell together in unity!' (*Ps* 133!).

Then, extending his view beyond the family, Socrates dilates in ch. 4 on the value of friendship, and insists that a good friend is the most useful of all possessions. In ch. 5 he even appraises the money-value of friends. Ch. 6 begins with advice as to the choice of friends, and ends with directions as to how to gain them. It appears in the course of it that there is a natural basis for friendship in men's need of one another, in the instinct of pity, in the benefits derived from co-operation, and in the feeling of gratitude (*χάρις*) which is thereby engendered; but it becomes plain also that friendship is possible only among the good. The rest of the book dwells on certain commercial aspects of friendship, closing with advice to a rich man to buy friends when they are cheap, on the principle enunciated by Horace (*Ep.* i. xii. 24):

'Vilis amicorum est annona bonis ubi quid deest.'

Thus we see that the views of Socrates on friendship were, as on other matters, thoroughly utilitarian.

The *Lysis* is a very 'Socratic' dialogue, of the kind known as 'mæutic' or elicitory. It is designed to stimulate, not to satisfy, inquiry; it discusses everything and decides nothing; opens wide vistas, where we seem to be laying hold of a principle which shall carry us far beyond the immediate subject, and then suddenly blocks our view by interposing some logical obstacle. In its pictorial setting it is among the most charming of Plato's dialogues, but, like others which reach the highest point of artistic perfection, it is poisoned by the taint of perverted amativeness. The Socrates of Plato begins where the Socrates of Xenophon left off. For the first position maintained in the *Lysis* is that whether a person will be loved must depend upon whether he is useful (210 C). Then, after some word-play on the active and passive meanings of *φίλος*, which lend themselves to verbal contradictions (212, 213), and during which the valuable idea is started that reciprocity is requisite for friendship (212 D), Socrates appeals to the poets as the fathers of philosophy (214 A).¹ Does not Homer authorize us to believe that likeness is the basis of friendship, when he says (*Od.* xvii. 218):

*αἰεὶ τοὶ τὸν ὁμοῖον ἀγαπᾷ θεοὶ ὡς τὸν ὁμοῖον?*²

But this principle, though it falls in with the philosophy of Empedocles (*q.v.*),³ is soon found to be only a half-truth, since there can be no friendship between the bad. It amounts, therefore, to saying that friendship is confined to the good. Against this, however, there lies the objection that like is of no use to like. Therefore the good are friends to the good, not in so far as they are like, but merely in so far as they are good. But against this, again, there lies the objection that the good man is supposed to be sufficient to him-

¹ Cf. Philo, ii. 467.

² The quotation is put in a more gnomic form than it really possesses in the text of Homer, which reads not *αἰεὶ τοὶ* but *ὡς αἰεὶ*.

³ Cf. *Lysis*, 214 B, with *Arist. Eth. Nic.* viii. 1. § 6, *Eth. Eud.* vii. 1. § 6.

self,¹ and, as such, does not stand in need of friends. Moreover, there is equal authority, both poetical² and philosophical,³ for quite the contrary doctrine, namely, that friendship is between opposites. But against this also there lies a fatal objection. For good and bad are opposites, and the good cannot be a friend to the bad. Perhaps, then, the indifferent is the friend to the good. If so, it must be owing to the presence of evil, before that evil has been able to corrupt the indifferent nature. Hence it is those who are conscious of ignorance that love wisdom, *i.e.*, that are philosophers, not those who possess knowledge, nor yet those who are so ignorant as to think they do (218 A; cf. *Apol.* 29 B) without doing so. And generally it is that which is neither bad nor good that is a friend to the good, in order to rid itself of the bad. This seems to be a conclusion in which all are willing to acquiesce. But a doubt soon suggests itself. For, if one thing is loved for the sake of another, is it not the other thing that is truly loved? From this it would follow that what is truly loved must be loved for its own sake. Furthermore, can friendship be due to the presence of evil, while it might still exist in a world from which evil was removed (221 C)? A new basis for friendship is now discovered in desire. But one desires what one lacks, and one lacks what one has lost. Whence it follows that friendship is for one's own. But if one's own (*τὸ οἰκεῖον*) is identical with one's like, we are back in our old difficulties. If it is not, then either good must be 'one's own' to all, or else good must be 'one's own' to good, bad to bad, and indifferent to indifferent. Either supposition lands the interlocutors in conclusions which seem already to have been refuted. Socrates, however, nothing daunted, is casting round for fresh lines of inquiry, when the pedagogues of the two boys, Lysis and Menexenus, with whom he has been conversing, swoop down upon their charges, and carry them off home. Socrates and the bystanders at first try to prevent them, but they are in no mood to be argued with, having had a little refreshment at the Hermæa. And so the Assembly breaks up, and we are left in perplexity as to the true nature of friendship. Still, many of the ideas have already been brought out which we shall find figuring later in the more systematic treatment of the subject by the Peripatetics.

4. The Cynics, Cyrenaics, etc.—Among the immediate disciples of Socrates we have dealt with Xenophon and Plato, but there remain others who may be spoken of. Antisthenes, the founder of Cynicism, held the two positions which are regarded as inconsistent in the *Lysis*, namely, that the sage is sufficient to himself,⁴ and also that 'good men are friends.'⁵ Among his numerous works, however, we find no mention of one on friendship. Neither does Aristippus appear to have written expressly on the subject, but we know the general view of the Cyrenaic school to have been that the end of friendship is utility.⁶ The followers of Hegesias accordingly denied that friendship is an end in itself (*Diog. Laert.* ii. 93); so also did those of Anniceris, on the ground that the happiness of a friend is not perceptible to oneself (*ib.* 96), while they risked their consistency by declaring that love for a friend would induce one to forgo pleasure and undergo pain. Diodorus the Atheist, however, was of sterner stuff than his master Anniceris. He denied that

¹ ἰκανὸς αὐτῷ is Plato's term here (215 A); αὐτάρκης does not occur until the later dialogues.

² *Hes. Op.* 25, 26; *Arist. Eth. Nic.* viii. 1. § 6.

³ Heraclitus. Cf. *Lysis*, 215 E, with *Eth. Nic.* viii. 1. § 6.

⁴ *Diog. Laert.* vi. 11: αὐτάρκη τε εἶναι τὸν σοφόν.

⁵ *ib.* 12: οἱ σπουδαῖοι, φίλοι.

⁶ *Diog. Laert.* ii. 91: τὸν φίλον τῆς χρείας ἐνεκα.

friendship exists either among fools or sages. With the former it is a question of utility, with the latter it is superfluous (*ib.* 98). Of Simmias of Thebes, another of the immediate disciples of Socrates, we can say only this, that in his book containing twenty-three dialogues the fourteenth was *περὶ φιλίου* (*ib.* 124).

Cicero mentions friendship among other topics connected with moral and political philosophy, which had been treated in ornate and weighty language by 'the old Peripatetics and Academics' (*de Fin.* iv. § 6), whom he always maintained to have been really one school under two names. Plato was succeeded in the Academy by his sister's son, Speusippus, among whose numerous works there was one *περὶ φιλίας* (*Diog. Laert.* iv. 4). His successor Xenocrates had also a treatise in two books on the same subject (*ib.* 12).

5. Aristotle and his successors.—We come now to Aristotle, to whom, directly or indirectly, we owe the greatest pronouncements of antiquity on the subject of friendship. These are to be found in bks. viii. and ix. of the *Eth. Nic.*; bk. vii. chs. 1-12 of the *Eth. Eud.*; and bk. ii. chs. 11-17 of the *Magna Moralia*. The treatment in *Eth. Nic.* is far more finished than in *Eud.*, but the two treatises proceed ultimately from one mind. The author of the *Magna Moralia* seems to have both the other writers before him.

The Greek word *φιλία*, which we render so inadequately by 'friendship,' corresponds more nearly to 'love.' It means the attractive principle in human nature generally. It is to mind what gravitation is to matter. It has its roots in animal nature, in the instinctive love of parents, especially of the mother, for offspring. It is the bond of the family, the tribe, and of the State, and generally the principle of political cohesion, the main object of the legislator being to bring it about. Just as in Christian ethics 'love is the fulfilment of the law' (Ro 13¹⁰), so Aristotle remarks that friendship supersedes justice, whereas justice does not supersede friendship (*Eth. Nic.* viii. 1. § 4).

Waiving aside the wider and quasi-physical speculation as to whether it is likeness or unlikeness that produces friendship, Aristotle confines himself to such questions as concern the philosophy of man. Friendships differ in kind according to the several objects of love. Now, there are three things that attract love—the good, the pleasant, and the useful. Hence there are three kinds of friendship according to the end that is sought to be attained. There are also three conditions of friendship: (1) that there should be a feeling of goodwill; (2) that this feeling should be reciprocated; (3) that the object of the feeling should be aware of its existence. Friendships for the sake of the useful and the pleasant are at bottom selfish, and are easily dissolved. The former is found chiefly among the young, the latter among the old. It is the friendship of the good, who love each other because they are good, which alone is lasting. And this includes the characteristics of the other two kinds, since the good are at once useful and pleasant, both in themselves and to one another. Such friendship is naturally rare, and is slow of formation, but, when formed, it is above calumny and distrust. It, therefore, is alone truly entitled to the name. Hence friendship in the highest sense is confined to the good, but the friendships of pleasure and utility are open to good, bad, and indifferent alike. In the highest sense also friendship implies equality and perfect reciprocity, though there are forms of friendship in all three kinds, in which there is a natural superiority on one side. In such forms reciprocity is not to be expected.

Any form of association among men, even down

to dining-clubs, is regarded by Aristotle as having its appropriate 'friendship.' And all these lesser associations are included in the great fellowship of the State, which aims at the common interest. There are three normal forms of constitution—kingship, aristocracy, and commonwealth or timocracy; and three perversions (*παρεκβάσεις*) of these—tyranny, oligarchy, and democracy. Among the latter, tyranny is the worst, as being the opposite of the best, and democracy the least evil, as it involves the smallest deflexion from the corresponding normal form. The analogues of the three normal forms of government may be discerned in family relations. Paternal rule corresponds to kingship, the relation between husband and wife to aristocracy, and that between brothers to timocracy. The relation between husband and wife is founded on a natural instinct, and continued on the principle of the division of labour. It involves both profit and pleasure, and its friendship may also be based upon virtue. Children constitute an additional bond; so that childless couples more often separate.

Returning to friendship as existing between individuals, Aristotle lays down that all the characteristics by which friendship has been sought to be defined are drawn from the relation in which a good man stands to himself. For a friend is one who has an effective desire, not merely for the being but for the well-being of another; companionship in life is deemed indispensable to friendship, and so are identity of purpose and sympathy in joys and sorrows. These characteristics are not found in the bad man, who is at war with himself, and cannot be said to have one soul. The good man's relation to himself, then, constitutes, as it were, the ideal limit of friendship, so that a friend is in very truth a second self. The happy man will need a friend, because man's nature is social, and that he may joy in his friend's existence, even as he joys in his own. The essence of friendship lies in loving rather than in being loved.

Theophrastus, who succeeded Aristotle as head of the Lyceum, also wrote a treatise on friendship in three books (Diog. Laert. v. 45), in which he discussed the casuistical question whether one ought sometimes to aid a friend contrary to strict justice, and, if so, to what extent, and on what sort of occasions.¹ He argued that, though rectitude is more valuable in kind than utility, yet on certain occasions a great utility to a friend may compensate a slight departure from rectitude, just as, though gold is more valuable in kind than bronze, yet a great weight of bronze may be of more value than a thin flake of gold. Another topic on which he touched was the inexpediency of recriminations on the part of friends who had become reconciled after a quarrel (Aul. Gell. viii. 6). He also gave the advice which has been crystallized by Seneca with his usual happy terseness—'post amicitiam credendum est, ante amicitiam judicandum.'

6. The Stoics and Epicureans.—The Stoics, of course, had their say upon friendship, but their style was execrable after that of their predecessors. It is told of Zeno that, when asked what a friend is, he replied, 'Another I' (Diog. Laert. vii. 23); but we have seen that the idea was familiar to Aristotle, and that in substance it goes back to Pythagoras.² The Stoics naturally confined friendship to the wise, as they did everything else to which they attached value (Stob. *Ecl.* ii. 601, Gaisford). They made friendship to consist in social intercourse coupled with harmony of opinion in relation to life (*ib.* 565). They also displayed their

usual verbal subtlety in the distinction of terms on this subject.³ Cleanthes, who succeeded Zeno in the Porch, is recorded to have written a treatise on friendship (Diog. Laert. vii. 175). Not so Chrysippus, or his great rival Epicurus. But the example of Epicurus on this subject was more powerful than his precept, and the Epicurean school, as is well known, was celebrated for the charm and fidelity of its friendships (Cic. *de Fin.* i. 65). Atticus, the friend of Cicero, inherited its traditions.

7. Cicero.—Theophrastus died in the year 287 B.C. Some two and a half centuries later Cicero, having enlisted his rhetoric in the service of philosophy, selected the work of Theophrastus as the basis of his celebrated treatise 'On Friendship.' The *Laelius, vel de Amicitia*—to give the work its exact title (Aul. Gell. xvii. 5. 1)—was part of Cicero's astonishing literary output during the year 44 B.C., when his daemon must have warned him that his time was short. Admirable as this work is, it still does not possess quite the charm or the transparent lucidity of diction which characterize the companion treatise *de Senectute*, and therefore it suffers somewhat by comparison. While availing himself freely of the material provided by Theophrastus (Aul. Gell. i. 3), Cicero displayed his discretion by not following that philosopher into the casuistry of a clash between friendship and justice, but by passing the matter over with a vague generality (*Lael.* 61). His purpose in his philosophical writings was always to edify. His practical solution of the problem raised by Theophrastus is 'writ large' in the *pro Milone*. There is reason also to believe that Cicero in this treatise was indebted to Stoic works on the same subject.⁴ His obligation to Xenophon in one passage is obvious.⁵

The definition of friendship given in the *Laelius* appears unsatisfactory. For to describe friendship as 'agreement on all subjects sacred and secular, coupled with goodwill and affection' (§ 20), is to put intellect before feeling, where the latter ought to come first, while it also leaves reciprocity out of the account. In his juvenile treatise, the *de Inventionibus* (ii. 166), Cicero gave a happier definition of friendship when he declared it to be 'the willing good things to another person for his own sake, together with the same will on his part towards you.' Cicero follows the Peripatetics in tracing the origin of friendship to nature, not to utility.⁶ There is much in his work that reminds us of Aristotle, yet he has nowhere the air of directly borrowing from him. This fits in exactly with what we know of his relation to Theophrastus. The chapter 'de Amicitia' in Valerius Maximus (iv. 7) is merely anecdotal, after the manner of that writer.

8. Seneca.—Seneca has brilliant passages on friendship scattered up and down his works, especially in the *Moral Epistles*. His sentiments, indeed, are so fine as to suggest the question whether they were quite sincere. You ought to wish for a friend, he tells us, not, as Epicurus said, 'that you may have somebody to sit by your bedside when you are ill, and to succour you in imprisonment or poverty,' but that you may have somebody by whose bedside you may sit yourself, and whom you may rescue from the dungeon of the enemy (*Ep.* ix. 8). Now there are friends who will do these things for one another, without being sages, but even a Florence Nightingale or a John Howard

¹ e.g. *γνωριμότης* and *συνήθεια* (Stob. *Ecl.* 566). The four terms which follow—*ἰταυρία*, *ξενία*, *συγγενική*, and *ἔρωτική φιλία*—were four species of friendship recognized by the Peripatetics (cf. Stob. p. 636).

² Cf. *Lael.* 28 with *de Nat. Deor.* i. 121.

³ Cf. *Lael.* 62 with *Xen. Mem.* ii. 4. §§ 1, 2, 4.

⁴ *Lael.* 27; cf. *Eth. Nic.* viii. 1. § 7.

¹ εἰ δὲ βοηθεῖν τῷ φίλῳ παρὰ τὸ δίκαιον καὶ μέχρι πόσου καὶ ποῖα (Aul. Gell. i. 3. 9).

² In phrase even, according to Philo, ii. 659: τὸ Πυθαγόρειον ὄμμα . . . ἄρα ἴσται φίλος ἑταῖρος ὡς ἐγώ:

hardly regards them as choice-worthy in themselves. No one, however, will challenge the truth or beauty of the maxim which Seneca quotes from Hecaton, a pupil of Panætius, 'I will show you a love-potion without drug or herb or any witch's spell: if you wish to be loved, love' (*ib.* 6). On the loss of friends, which he admits to be the greatest a man can sustain, Seneca, after the manner of his school, is not very sympathetic. Instead of mourning them, he tells us (*Ep. civ.* 11 f.), it is better to make new ones. 'But they will not be the same.' 'Neither will you be the same,' is the rejoinder; 'you are changing every moment of your life.' Yet he allows a measure of tears in one of his terse and glittering antitheses (*Ep.* lxiii. 1):

'Nec sicci sint oculi amisso amico nec fluant. Lacrimandum est, non plorandum.'

Again, in the *Remedies against Accidents* (xv. 2), addressed to his brother Gallio, he has this not very consoling reply to one who complains that he has lost a friend: 'Be of good heart, if you have lost only one: blush, if he is the only one. Were you riding at one anchor in the storm of life?' Of his professed treatise 'On Friendship' there remain only mutilated fragments published by Niebuhr in 1820 from a Vatican manuscript.

9. Epictetus.—Among the discourses of Epictetus, as edited by Arrian, there is one labelled 'On Friendship.' Its theme is that friendship is confined to the wise, and it has a touch of the Cynicism which we trace in the stout-hearted slave-philosopher. You may see puppies, he says, fawning upon and playing with one another, so that you would say, 'How loving they are!' but throw in a bit of meat among them, and watch the result! Even so brothers may have been brought up amid mutual endearments; but throw in between them a pretty girl, or property, or honour, or power, and you will see what their affection is worth. 'For generally (be not deceived) every living creature finds its own interest nearest and dearest to itself.' It is, therefore, only those who identify their own interest with fidelity and justice and right who can be trusted not to pursue it to the detriment of another.

'For wheresoever is the "I" and "the mine,"
Thither the creature must needs incline.'

This is Epictetus' way of saying: 'For where thy treasure is, there will thy heart be also' (Mt 6²¹).

10. Marcus Aurelius.—In the *Meditations* of Marcus Aurelius Antoninus there is much about forbearance and consideration for others, but no word on friendship. Was it part of the tragedy of that crown of thorns that the monarch who would fain have been a friend to all was himself without a friend?

LITERATURE.—The original sources have been cited in the article. Cf. also the preceding art. and the Literature appended to it.

ST. GEORGE STOCK.

FRIENDS OF GOD.—A name current, chiefly in the 14th cent., for individuals and groups of individuals who aimed at cultivating a deeper piety and a closer spiritual fellowship than did those around them in the Church, or than the Church encouraged. What distinguished them from others was not anything in their mode of worship, creed, or dress, but aloofness of spirit from the world, and simple devotion to the will of God. Hence they were not a sect. As a rule, they remained within the bosom of the Church—not consciously disloyal to its dogmas, discipline, or practice. They were much rather a spiritual brotherhood comprehending men and women of all social grades, stages of culture, and forms of experience. Love of God—predominantly mystical in some cases or mainly practical in others—was the uniting bond.

1. Historical antecedents.—Any direct connexion with previous movements in the Church is not

traceable. But in the 12th cent. the name 'Friend of God' is applied to Bernard of Clairvaux. It was suggested by Jn 15¹⁴, but also by Ps 138¹⁷ (LXX) and Ja 2²³. In this last sense the word meets us in the German literature of the 12th and 13th cents. as an epithet for the Evangelists and Apostles, for OT heroes like Moses, and in general for all saints and pious people in heaven and earth. In the 13th cent., moreover, the expression *ausgewählter Gottesfreund* has already become a current one as applied to the pious and faithful believer. But not till the 14th cent. is the same expression reserved as a sort of formula for the ideal of a soul elevated through Christ out of slavery into the friendship and sonship (*Kindschaft*) of God (Jn 1¹² 11⁵², Ro 8¹⁴ 9⁸).

It has been asserted that there are documents of the Middle Ages in which the name 'Friends of God' is given to the Vaudois; and that, at any rate, the Friends of the 14th cent. were in secret union with the Waldenses. But this, as Gieseler says (*Eccles. Hist.*, 1853, iv. 177, note 1), is a mistake, due most likely to statements met with about the somewhat legendary Nicholas of Basel, and is inconsistent with the submissive attitude of the Friends to the visible Church—the Waldenses, on the contrary, being its declared antagonists.¹ But it is true that the spiritual attitude of the two was alike, and that the impulse which proceeded from the Waldenses—as well as from their precursors, the order of the Humiliates—would tend to produce an atmosphere in which the Friends flourished. Much the same may be said of the impulse derived from the Mendicant Orders.

2. Chief centres.—The foci of the movement were Strassburg, Cologne, Basel; but its circuit included the Rhine Valley, from Brabant up to the high valleys of Switzerland, with the upper regions of the Danube. It was in favour from the first with the Preaching Orders on the upper and lower Rhine. Among the nuns of their convents it found many adherents to whom especially some of the leaders addressed themselves—*e.g.*, Tauler and Henry of Nördlingen to those at Basel, Nicholas of Strassburg to those at Freiburg, Suso to those at Zürich, etc. Two nuns in particular, Margaretha Ebner (of Maria Medingen, near Nuremberg) and Christina Ebner (abbess of the convent of Engelthal, near Nuremberg), stand out as devotees—the correspondence of Henry of Nördlingen with the former being 'the most important and reliable source of information respecting the Gottesfreunde of the South.' But its members were even more numerous among the laymen; and, if most of these were of the peasant class, they also included men of good station like Henry of Rheinfeld in Aargau, a knight of Pfaffenheim from Upper Alsace, a knight of Landsberg and his wife from Lower Alsace, Rulman Merswin, merchant of Strassburg, etc.

3. General characteristics of the movement.—
(a) It was distinctly a *laymen's* movement, and there is an evident purpose in the literature of the Friends of God to exalt the ordinary lay Christian, and to show how the Church can be saved and the ministry purified by unordained persons; but these men do not show any spirit of revolt from the ancient system, they have not gained the Protestant temper, and they never dreamed of dispensing with the mediation of the Church, though they occasionally admit that spiritual life is possible without such mediation.²

Nevertheless, the prominence given to 'unordained persons,' whose authority as guides lay simply in the fact that they had been taught of God, marked a radical divergence in principle from the Church—a divergence which did not become 'Protestant' only because it had not yet become explicit.

(b) The movement was necessarily *supernaturalistic*. In this respect the Friends of God were children of their age. They shared the common belief in the virtue of relics, the objective reality of visions, the power of every sense—sight, touch, smell, taste, and hearing—to be the medium of a

¹ Harnack, however, points out (*Hist. of Dogma*, Eng. tr., 1894-99, vi. 90, note 1) that one section of the Waldenses, viz. the Lyonnese Poor, as distinguished from those of Lombardy, were less sharply opposed to the Church.

² Rufus Jones, *Studies in Mystical Religion*, London, 1909, p. 254.

Divine revelation. Visions especially were looked for and often experienced—visions which declare themselves at once as hallucinations born of the abnormal psychic conditions into which the subjects of them were brought by their too rigorous treatment of the body.¹

(c) It was strongly *apocalyptic*. The influence, on the one hand, of the 'great German prophetesses' St. Hildegard, St. Elizabeth of Schoenau, and St. Matilda of Magdeburg—of which there are marked traces—and, on the other hand, the state of Christendom around them account for this. As to the latter, it was the period of 'the Babylonish Captivity,' when (from 1309 to 1377) 'the papal seat was changed to Avignon, and the popes were more or less puppets of France'²—a period followed by the Great Schism (1378–1417), during which each of two rival popes demanded the allegiance of the Church. In addition, there were the terrible social evils due to the great civil war which followed upon a double election of Emperors. Finally, these human terrors were accompanied by what seemed to be dreadful signs of the Divine wrath—notably the 'Black Death.'³

The effect of such phenomena upon the Friends of God was such as might be expected from the simplicity and fervency of their faith. It made them seers and prophets of the End.⁴

(d) *Asceticism* was a prominent feature in the practice of the Friends of God, but not so much for its own sake as for the sake of the higher stages of spiritual experience to which it was supposed to open the way. Asceticism disciplined the soul through the body, and formed the lowest round of that mystical ladder whose top reached to the enjoyment of God by clear vision and perfect union. The leaders of the Friends, at least, were mystics of the usual mediæval type—with their idea of God as a Being absolutely transcendent, with their notion of the way to Him as a process of complete self-emptying, and with their yearning for those occasional leaps into immediate and vital contact with Him which were called ecstasies.⁵

(e) But the chief note in leaders and followers alike was not this or anything else abnormal. It was *inwardness*—a life of simple faith, hope, and love derived from personal fellowship with God and flowing out in all the moral virtues. What they sought and found was a first-hand spiritual experience. They believed in the living actual educative work of God in the soul. They were pupils in the 'upper school of the Holy Spirit'⁶—a school to which every one of humble and sincere heart may have free access.⁷

4. Leaders.—(1) For the friends of God the leader *par excellence* intellectually and spiritually was *Heinrich Eckhart* (see MYSTICISM [Christian]). He was so, at least in two respects: (a) in the first place, by his constant emphasis on the capacity of the soul for God in virtue of its very nature. Not merely in the soul of prophet, priest, or scholar, but equally in the soul of 'every man,' there is something which is Divine. It may be designated 'the ground of the soul,' or 'the spark,' or 'the soul's eye,' or 'right Reason.' Names do not matter. The essential point is that there is in man what can rise to God and know Him and enjoy the bliss of friendship with Him. (b) In the second place, the type of piety prevailing among the Friends of God was Eckhart's. For he taught them to think of religion as something practical as well as something inward and spiritual. He 'was a highly practical man, who did his day's work with fidelity and telling effect.'⁸ Similarly,

¹ Rufus Jones, p. 256 f.

² *Ib.* 243.

³ *Ib.* 244.

⁴ *Ib.* 286 f.

⁵ *Ib.* 258.

⁶ *Ib.* 269.

⁷ Cf. for this note of inwardness especially the *Theologia Germanica*.

⁸ Rufus Jones, 236; cf. p. 237 f.

Eckhart proclaims liberty from the restrictions of local and ceremonial worship.¹

(2) One who was a Friend of God to his inmost soul, and may well be described as the 'spiritual splendour' of the movement, owed much to Eckhart—especially to his good sense at a time of crisis when good sense was the best counsellor. This was *Heinrich Suso* (c. 1300–65)—the 'Minnesinger of the Friends of God'—whose life-story was written down by his spiritual daughter, Elizabeth Staglin. He was a beautiful soul full of tender sympathy, 'not only with men, but with every little beast and bird and all the small creatures God had made.' After repeated painful spiritual crises, he went to Eckhart for comfort, and the latter 'set him free from a hell which he had long been enduring.'² He knew nothing of Eckhart's so-called heresies, and was impervious to his philosophy. What the Master taught him was to believe in the love of God, and prefer God's yoke to any of his own invention. So he became no longer a servant, but—to use his own phrase—the knight of God; and entered upon that later stage of his career in which may be seen one of the brightest examples of the practical love for men which is inspired by an enlightened love for God.³

(3) Another of Eckhart's disciples was probably *John Tauler* (see MYSTICISM [Christian])—though the relation of the two has sometimes been reversed. He had opportunities of hearing him both at Strassburg and at Cologne, and in one sermon at least he quotes him (13th after Trinity, 2nd sermon). But perhaps disciple is hardly the right word—unless it be taken to mean no more than that Tauler derived from Eckhart his best impulses and his most characteristic view of the spiritual life. There is little trace in Tauler of Eckhart's philosophy or subtlety.

5. 'The Friend of God from the Oberland.'—According to a story printed in all the editions of Tauler's sermons from 1498 onward, there came a momentous break in his life, occasioned by the visit to him at Strassburg of a mysterious person known as 'the Friend of God from the Oberland.'

His visit was made, it is said, in obedience to a Divine intimation that a certain Master of Holy Scripture preached there whom it behoved him to hear. He heard him five times and perceived that the Master was 'a very loving, gentle, good-hearted man by nature, and had a good understanding of the Holy Scripture, but was dark as to the light of grace.' So the man persuaded the Master to preach a sermon in order to show how one may attain to the highest and utmost in spiritual things. This the Master did, and the man took down the sermon word for word. Then, coming with it to the Master, he said: 'You are a great clerk and have taught us a good lesson in this sermon, but you yourself do not live according to it.' At first the Master resented such words, especially from a layman. But presently he discerned his right to speak as one taught of God, and put himself under his direction. Hereupon the man convinced him: (a) that in the sense of being a self-pleaser he was so far a Pharisee; (b) that his deepest need was conversion, to which end he must at once break through all his ways and habits. With deep humility the Master followed the layman's counsel. Renunciation was the keynote; and the Master was put to the test by being enjoined to renounce 'all his proud ingenious reason which he has through his learning in the Scripture.' He was for a time neither to study nor to preach, though he must continue to fulfil his daily duties as a monk, and must yield obedience in all faithfulness to his superiors. The Master consented; and at a cost of great and varied suffering—foretold by his director—he persevered. At length, after two years, as he lay in his cell utterly weary and sad 'but fully awake, he heard with his bodily ears a voice saying: Stand fast in thy peace, and trust God, and know that, when He was on earth in human nature, He made the sick whom He healed in body sound also in soul. Straightway when these words were uttered, he lost his senses and reason, and knew not how, or where, he was. But, when he came to himself again, he felt within himself that he was possessed of a new strength and might in all powers outward and

¹ Rufus Jones, p. 223 f.

² *Ib.* 232.

³ See art. on Henry Suso—a review of Melchior Diepenbrock's *Heinrich Suso's Leben und Schriften*—in *CQR* lxi. [1905] 164; also Rufus Jones, p. 239, for the lovely story of his search after his fallen sister.

inward, and had also a clear understanding in those things which aforesaid were dark to him, and he wondered greatly whence this came.' His Friend assured him that now at last he had received the light of the Holy Spirit; and that thus illumined he would possess a much clearer insight into the Scriptures than he had before. He might now begin again to preach. He tried, and was overcome by emotion. This made him a laughing-stock. But, being allowed to deliver a lecture in Latin to the brethren only, the result was 'such an excellent lecture as they had never heard in their lives before, so grand and deep and godly was his doctrine.' Next, therefore, he was permitted to preach in the church where he was 'wont to preach.' He did so with amazing power. Thereafter for 'full eight years' the Master 'preached both to clergy and laity,' his influence growing all the time. Thus he drew to his end. For more than twenty weeks he suffered sorely. His last hour was laden with dreadful and amazing anguish, which the Master himself, in an appearance to the Friend three days after his death, explained as his purgatory.

This picturesque story was first questioned in 1719 by Quétif and Echard, who, in their *Scriptores ordinis prædicatorum*, treated it as an allegory. More than a century later this view was accepted by Weiss in the *Biographie universelle*, art. 'Tauler' (1826). But the traditional view held its ground until H. S. Denifle, the great Dominican scholar, published his pamphlet (Strassburg, 1879) entitled *Taulers Bekehrung kritisch untersucht*.¹ Here he worked out the following conclusions:

(1) The epithet 'Master' means Master of Holy Scripture. This Tauler was not. (2) The Master's two years of seclusion (*Zurückgezogenheit*) are placed between 1346 and 1352. Tauler during this time was active as a preacher. (3) The Master died in the Dominican convent. Tauler died outside. (4) The Master shows himself (*bekundet sich*) a very second-rate, inexperienced, unimportant preacher. Tauler is seen in his sermons to have been the reverse of this. (5) The Master exhibits a distracted nature. Tauler is a harmonious personality. (6) The Master disowns any gift of eloquence in his style. Tauler in his appears as one of the great German speakers of his time. (7) The Master was not identified with Tauler until a hundred years after his death, and then as the result of conjecture, not evidence.

Who, then, was the Master? Had he really existed? Denifle at this time did not fear contradiction when he identified him either with the 'Gottesfreund' himself or with Rulman Merswin. Merswin certainly was a historical personage, a native of Strassburg, belonging to an important family of the city, and born in 1307. At the age of 40 he retired from his business as a banker with a large fortune, and devoted himself entirely to Divine things. Though married—to Gertrude of Bietenheim—he resolved to live henceforth as a celibate. But he did not give away his money; he kept it 'to use for God' as He might direct from time to time. In 1348, John Tauler became his confessor. In 1366 he found occasion for a pious use of his money in building a house for the Brethren of St. John on an island at Strassburg called the *Grünenwörth* ('Green Meadows'). In 1382 he died. A document entitled 'das Büchlein von den vier Jahren seines anfangenden Lebens,' purporting to be autobiographical, not only tells the story of the 'stages of spiritual experience' through which he passed during the first four years after his conversion, but also relates the first appearance of the Gottesfreund, and how, at his instigation, the book was written.

By Merswin the Friend is represented as the son of a rich family, who had spent a dissipated youth, was suddenly changed by the grace of God, withdrew into solitude and drew to him others like-minded, and by the illumination of the Holy Spirit became able, in the space of 30 weeks, to understand the Scriptures as thoroughly and speak as good grammar as if he had studied all his days in the best university. He appears at the castles of nobles and knights—even in the palace of the Pope—holding up to all alike, in writing and speech, a mirror of themselves; and effecting 'conversions' everywhere from the love of this

¹ Printed separately also as pt. 36 of *Quellen und Forschungen zur Sprach- und Culturgesch. der german. Völker*, Strassburg, 1879.

vain transitory world to the inner mystic love of God. Such a man surely could not be hid. Yet apparently he was. Though he visited Strassburg in 1346 and converted the Master, nothing was seen of him. Though he visited Merswin and sent frequent letters to him, none but Merswin was aware of it. In connexion with the purchase of the 'Green Isle' and the constitution of its convent, Rulman Merswin planned nothing and did nothing apart from the advice of his friend; but no hint of this came to the eyes or ears of the Brothers for whom he was acting. Nor did they at all realize till after his death that the good Merswin had been living so God-devoted a life—the life of a saint. Only when they discover his own account of the 'vier Jahren' in a sealed casket are they enlightened and made to wonder at his great humility.

The story bears upon the face of it suggestions of romance; and Denifle's final belief that Merswin was the romancer is not surprising.

But, meanwhile, quite another line had been taken by the Strassburg professor, Karl Schmidt, who in the years from 1839 to 1866 published, in almost unbroken succession, a series of writings which consisted chiefly of extracts from original documents found in the convent of St. John at Strassburg (*Die Urkundenbücher des Johanniterhauses*), and assumed by him to be those of the 'Gottesfreund' and Rulman Merswin. Not only did he identify the unnamed Master (of the *Meisterbuch*) with John Tauler, and credit the whole story of his conversion by the 'Friend,' but he also convinced himself that he had discovered the original of the latter in a certain Nicholas of Basel of whom nothing is otherwise known except that he was burnt as a Beghard at Vienne, near Poitiers, after 1382.¹

Schmidt's views carried the day for a time, even Denifle being among his adherents. At this time, however, Denifle, *e.g.*, had to base his judgment entirely on the documents adduced by Schmidt. But before long the process of historical criticism brought to light the fact that Schmidt had exercised a quite arbitrary choice in his editing of the sources, and had—without due indication—altered rubrics and text in accordance with his own opinion. The first to reject Schmidt's identification of the Gottesfreund with the layman Nicholas of Basel was Preger (1869). Denifle's rejection, the result of still wider and deeper investigation, came next (1870, 1876). Schmidt did not retract. In 1875 he published his *Nikolaus von Basel, Bericht von der Bekehrung Taulers*, reaffirming his view. This brought about a complete refutation of it during the years 1879–81—mainly by Denifle, who came step by step to the conclusions already described. Denifle's work was so thorough and convincing that Schmidt's, on the chief point in question, was completely undermined. Even A. Jundt—whose *Les Amis de Dieu* (Paris, 1879) took the old ground to the extent that it still assumed the objective existence of the Gottesfreund—though identifying him with John of Chur (Coire) instead of Nicholas of Basel, was driven to concede the main point, viz. the fictional character of the Gottesfreund. But he was unwilling to think of Merswin as a conscious deceiver; and, in order to clear him of this charge, he suggested that 'Merswin was a "double personality," of a pathological type now well known to all students of psychology. In his *primary state* he wrote the books ascribed to him and experienced the events recorded in his autobiography; while in his *secondary state* he became the person known as "the Friend of God from the Oberland," and in this state he wrote the books, treatises, and letters ascribed to "the

¹ See Gieseler, *Eccles. Hist.*, iv. 186.

Friend of God."¹ In 1893, Preger (in the third part—'Tauler, der Gottesfreund vom Oberlande'—of his *Gesch. der deutschen Mystik*), armed with some new material, made a fresh attack on Denifle's results, but utterly failed to do more than emend or correct them in details. Their foundation has stood sure. In fact, Denifle's view as to the non-existence of the Gottesfreund may be said to have found general acceptance among German scholars. See especially P. Strauch's art. on 'Rulman Merswin,' in *PRE*².

A completely new standpoint has been taken up by an equally eminent authority on the subject, viz. Karl Rieder, first in two magazine articles,³ and then in an elaborate essay.⁴ According to this, Merswin had nothing to do with the unknown Friend. He was a fiction, but one not due to Merswin. The inventor of him was Merswin's trusted secretary, Nicholas of Louvain, who, after his master's death, falsified and forged documents in order at once to glorify him, and, by a heightened portrait of their founder, to stimulate the pious devotion of the Grünenwörth brothers.⁴ As to Merswin himself, it is certain that no one knew, while he lived, of his being so favoured a friend of God (*ein so begnadeter Gottesfreund*). Nicholas says this expressly. Nor, apart from Nicholas, did any suspicion of the fact come to light after his death. He was not the impostor (*Betrüger*) he is made out to be by the theory which makes him the author of the writings in question. In their composition he had no part at all. We may picture him as a man who shared the deep, inward faith characteristic of the mediæval age—a faith intent upon good works and pious foundations. In order to create a home for himself, the childless man, in the days of his sickness and old age—a home and also an oratory and last resting-place—he acquired possession of Grünenwörth. Then, further, he conceived the plan of fashioning it into a house which should be a pattern of its order (*ein Meister-Ordenshaus*)—a house where laymen as well as clerics should have a voice in affairs. And, if to reach his end he did not scruple to use some of the cunning and hardness which are peculiar to a man of wealth (*Geldmann*), we need not wonder. On the other hand, the devoted attachment of Nicholas to his early master is a beautiful feature, which reflects a certain glory upon the character of the latter.

Strauch showed himself sceptical of Rieder's view, when it first appeared, in his articles of 1902.⁵ When he developed his own view in the *PRE*² art. already referred to, he had not seen Rieder's larger work.⁶ In a supplement, however, to that article he takes account of it; and he gives it as his opinion that even a superficial examination is enough to stagger belief, by reason of its difficulties and contradictions. Still, no difficulties can stand before a demonstration; and Strauch promised to test, later, Rieder's claim to have produced one. He redeemed his promise in the *Zeitschrift für deutsche Philologie*, Jan. 1907. Here he considers with great care and thoroughness how far,

¹ Rufus Jones, p. 252. He adds: 'This view, if proved sound, would surely make Rulman Merswin one of the most interesting psychological "subjects" in the entire range of history.' Cf. Rieder, *Der Gottesfreund vom Oberland*, Innsbruck, 1905, p. 12.

² 'Zur Frage der Gottesfreunde: 1. Rulman Merswin oder Nikolaus von Laufen; 2. Bischof Heinrich III. von Konstanz und die Gottesfreunde' (*Zeitschrift für Gesch. des Oberrheins*, new ser., xvii. [Heidelberg, 1902] 205, 480).

³ *Der Gottesfreund vom Oberland: eine Erfindung des Strassburger Johanniterbruders Nikolaus von Löwen—mit 12 Schrifttafeln in Lichtdruck*, Innsbruck, 1905.

⁴ P. 13.

⁵ See Strauch's ed. of *Schürebrand*, Halle, 1903, p. 55.

⁶ See 'Nachtrag' to the article, where he says that it was written in Sept. and Oct. 1904, though not published before 1906. Rieder's work was also written in 1904—at least the preface bears date Rome, 4 Nov. 1904—and came out in 1905.

if at all, Rieder's argument may be taken as valid. His conclusion, which is all we need give here, is as follows. Rieder's zeal and research are admirable, and not less so his penetration as regards particular points. But his investigation has not gone deep enough, and he has set out from rash and preconceived positions which are palpably untenable, and not likely to survive the second thoughts even of the author. Rieder does not claim to have dealt with the whole subject exhaustively, and only professes to have laid a foundation—though a sure foundation, and one upon which all subsequent inquiries must be built. Strauch denies this. The decisive test is not (as Rieder assumes) historical; it is stylistic and linguistic. It is, e.g., whether Nicholas, a man born and bred in the Netherlands, could compose all he did in Alsatian (Strassburg) German without disclosing a trace anywhere of his native speech. It is, again, whether there is unity, or difference, of style between the Tracts and the historical parts of the memorial-books—not merely in the case of the revised Tracts as we have them, but also in the case of their precursors, viz. those anonymous Tracts with which Rieder makes so free. Rieder, indeed, does not dare to evade this test altogether, and makes an occasional use of it. But he fails to see its decisive importance; and so his use of it is far too restricted. He must condescend to such a use of it as is thoroughly systematic before he can hope to reach a satisfactory solution of his problem.

Here the controversy rests for the moment. None but an expert can venture to decide between two such champions of their respective views; but the present writer may add that he finds it hard to see how the detailed evidence of Rieder is undermined by Strauch's objections, and even less how these invalidate the general soundness of his method.

LITERATURE.—C. Schmidt, *Johann Tauler von Strassburg*, Hamburg, 1841, and *Die Gottesfreunde im 14ten Jahrhundert*, Jena, 1854; *History and Life of the Rev. J. Tauler*, with Introduction by Hitchcock, ed. S. Winkworth, London, 1858; *Theologia Germanica*, tr. S. Winkworth, London, 1874; K. Schmidt, *Nikolaus von Basel, Strassburg*, 1875; M. Rieger, *Die Gottesfreunde im deutschen Mittelalter*, Heidelberg, 1879; A. Jundt, *Les Amies de Dieu au XIV^e siècle*, Paris, 1879, and *Rulman Merswin*, do. 1890; W. Preger, *Geschichte der deutschen Mystik im Mittelalter*, Leipzig, 1893, vol. iii.; R. A. Vaughan, *Hours with the Mystics*, London, 1893; W. R. Inge, *Christian Mysticism*, London, 1899; K. Rieder, *Der Gottesfreund vom Oberland*, Innsbruck, 1905; F. von Hügel, *The Mystical Element of Religion*, London, 1909; R. M. Jones, *Studies in Mystical Religion*, do. 1909; P. Strauch, art. 'Rulman Merswin,' in *PRE*² xvii. 203; and the other works mentioned throughout the article. FRED. J. POWICKE.

FRIENDS OF LIGHT. — See DEUTSCH-KATHOLICISMUS.

FRIENDS OF THE TEMPLE (*Tempelfreunde, Templar*). — A sect which originated in Württemberg in 1861; now Unitarian, with headquarters in Palestine, where the colonists form an important economic factor. It was derived from Pietism, as developed in Württemberg by J. A. Bengel, with a chiliastic trend. Early last century this gave rise to a scheme outlined by J. M. Hahn, and sanctioned by the king on the advice of G. W. Hoffmann. It contemplated new settlements, exempt from control by the Church authorities, where colonists should live model lives, morally, socially, and educationally. Germany has been prolific in such plans—the mediæval monasteries, the Bohemian Brethren, the Anabaptists in Moravia, the Moravians at Herrnhut being familiar instances. The first of the new colonies was planted in 1819 at Kornthal, seven miles from Stuttgart, and was governed with much success by G. W. Hoffmann till his death in 1846. In its strongly chiliast atmosphere, under the influence of Philip M. Hahn, grew up his son.

Christoph Hoffmann (b. 1815). His experience as head of the Crischona College, near Basel, saddened him by the conventional morality and the dead formality of the State Church. He therefore founded a new college at Salon; and, when elected delegate to the Diet at Frankfort, sought to bring about a reform within the Church. The effort failed; and at length he was expelled its communion in 1859, whereupon he prepared to organize independently, spreading his views by lectures and by the press.

Hoffmann recognized God's judgments on dead churches in the victories of Islām and the revolt under Luther. He commended Baptists and Methodists for their freedom and their life. Forecasting the future, he emphasized the Return of Jesus Christ, and studied the conditions precedent. He concluded that the time of bearing witness was expiring, and that the Return might take place in a generation or two—when Kornthal was founded, a limit of 17 years had been expected. Penetrated with a sense of the value of the OT prophets, and of the types in the Jewish ritual dealing with circumcision, offerings, temple, priesthood, kingship, he elaborated a theory as to the Spiritual Temple which Christ would build. He recognized that this would be independent of nationalities and places, and that worship would be everywhere. To this ideal he saw an actual obstacle in that under Muslim rule all extension of Christian worship was illegal, and Jerusalem in particular was impossible as the capital of that kingdom where Christ might reign. The removal of this obstacle now became the object of his efforts.

First he thought of obtaining a firman permitting Christian colonies to be planted in Palestine. He failed to obtain political support in Germany, and a visit to Palestine convinced him that his scheme of 1855 would need serious change. He continued lecturing and publishing, chiefly in Stuttgart, and formulated a Confession in 1864. The first overt act was to establish a settlement at Kirschenhardt-hof, where G. D. Hardegg († 1879) was put in control of the civil side, Hoffmann and twelve elders being the spiritual authority.

By 1868 a second step was possible. Since the Treaty of Paris the old Ottoman methods were largely abandoned, and the admission of Turkey to the European Concert seemed to bring the peaceful penetration of the East by the West into practical politics. An American colony under Adams settled at Jaffa, actuated by the same general idea of transporting a body of Christians, assured of local autonomy under the Treaty, destined to extend, and to leaven the native population. It might have been expected that this would fare better than the 1849-53 migration led by Mrs. Minor, also with the intention of preparing for the Return of Christ. But both American schemes collapsed, and Hoffmann saw his opportunity. Negotiations were opened through Basel, whence a previous German colony had gone to Jerusalem with slightly different aims; and by 1868 the Friends of the Temple acquired the Jaffa property. It was soon occupied, and a second plantation was opened at Sarona, a few miles away; also a new one close to the north-west of Haifa, which seemed better as a port, being sheltered by Mount Carmel, and lying at the mouth of the valley of Esdraelon, with easy access to the lake and to Damascus. These model villages absorbed most of the Kirschenhardt-hof adherents; and, whereas in 1869 they had been the most numerous of all dissenters in Württemberg, though hard run by the Baptists, that centre rapidly sank to be little more than a recruiting and forwarding depôt, so that Hardegg resigned in 1874. New colonies were planted at Nazareth and Tiberias, at Beirut and Ramleh, and even at Alexandria. To

secure immigrants, other depôts were opened in Saxony and Russia, while the United States¹ furnished an even better seed-plot. Finally, the headquarters were transferred to Jerusalem itself, and this phase of the movement closed with the death of Hoffmann in 1885. Under his guidance the theology had become Unitarian.

Eight years later, his son Christoph became Guardian of the Temple, and the movement received an impulse from the visit of the German Kaiser in 1898. The colonies are an important German asset in the complicated politics of Syria; their economic value seems now to exceed their religious interest. After overcoming the legal difficulties as to holding land, they have settled down to steady work. Their example in agriculture and viticulture has greatly altered native methods. They have introduced new industries—brewing, improved milling, soap-making, wood-carving, silk-spinning, and good hotels. The settlements are laid out as garden cities, with substantial stone buildings; the colonists have built good roads to link Nazareth and Jaffa with Haifa. Here the community numbers 360, with church and school of its own; the total number settled in Palestine is variously estimated at 1200-1400.

LITERATURE.—C. Hoffmann, *Occident und Orient*, Stuttgart, 1876, *Mein Weg nach Jerusalem*, do. 1881-84; C. Palmer, *Die Gemeinschaften und Sekten Württ.*, Tübingen, 1877, *Württ. Kirchengesch.*, Stuttgart, 1893; F. Lange, *Gesch. des Tempels*, do. 1899; E. Kalb, *Kirchen und Sekten der Gegenwart*, do. 1909; C. F. A. Kolb, 'Tempel, Deutscher,' in *PRE*³ xix. [1907] 482-488. For the Eastern settlements: L. Oliphant, *Haifa*, Edin. 1887; Murray's and Baedeker's current guides to Syria and Palestine.

W. T. WHITLEY.

FRIENDS, SOCIETY OF.—I. The name.—The first Friends called themselves 'Children of the Light'—a name used by the oldest Quaker community at Mansfield in 1648; and 'Friends in the Truth' or 'Friends'—a term used as early as 1652. These unsectarian names correspond with the universal scope of the early Quaker message. The narrower title 'Society of Friends' is later. It occurs, though hardly yet as a formal title, in an anti-Quaker tract of 1665, John Wiggan's *Anti-christ's strongest Hold overturned*, p. 49: 'matriculated or registered into their Society of Friends.' Later in the century, Friends referred to themselves as a Christian society, but the form 'Religious Society of Friends' was not adopted till about 1800. The terms previously in general use were 'Friends,' 'the body of Friends,' and 'the people called Quakers.' In America the usual name is simply 'the Friends,' or, in some cases, 'Friends Church.' The nickname 'Quakers' was given by a Puritan magistrate, Gervase Bennett, at Derby in 1650. In 1647 a sect of women from beyond sea, who shivered and shook under religious excitement, were known as 'Quakers' (see word in *OED*), and the trembling of Friends under 'the power,' as they called it, led to the term being applied to them.

2. Fundamental principles.—Quakerism is the product of the spiritual experience known as the Inward Light. The 'opening' came to Fox, 'that Every Man was enlightned by the Divine Light of Christ, and I saw it shine through all; And that they that believed in it came out of Condemnation and came to the Light of Life, and became the Children of it; But they that hated it, and did not believe in it, were condemned by it, though they made a Profession of Christ. This I saw in the pure Openings of the Light, without the help of any Man, neither did I then know where to find it in the Scriptures, though afterwards, searching the Scriptures, I found it' (*Journal*, 1694 ed., p. 22).

This great affirmation, which was a thing of first-hand experience to the early Friends, conflicted with the Puritan disbelief in immediate revelation, and with current doctrines of election and reprobation. The Quaker, following the Inward Light,

¹ In the United States the sect is now known as the 'Temple Society in the United States.' In 1906 it returned 376 members in 3 congregations.

felt that Christ was come to teach His people Himself, and to call them away from the world's ways and teachers to His own living teaching. The indwelling life of Christ became to him the supreme fact of religion.

The far-reaching consequences of this experience, with respect to worship and ceremonial and ministry, and to the practical cross-bearing of daily life, are vividly shown in the following from Edward Burrough, who was 'convinced' in 1652:

'In all things we found the Light which we were inlightned withall, and all mankind (which is Christ) to be alone and onelie sufficient to bring to Life and eternal salvation. . . . And so we ceased from the teachings of all men, and their words, and their worships, and their Temples, and all their baptisemes, and Churches, . . . and we met together often, and waited upon the Lord in pure silence, from our own words and all men's words, and hearkned to the voice of the Lord, and felt his word in our hearts to burn up and beat down all that was contrary to God, and we obeyed the Light of Christ in us, . . . and took up the Crosse to all earthly glories, Crowns and waies, and denied our selves, our relations and all that stood in the way betwixt us and the Lord. . . . And, while waiting upon the Lord in silence, as often we did for many hours together, . . . we received often the pouring down of the spirit upon us, . . . and our hearts were made glad and our tongues loosed and our mouths opened, and we spake with new tongues, as the Lord gave us utterance and as his spirit led us, which was poured down upon us, on Sons and Daughters, . . . and the glory of the Father was revealed, and then began we to sing praises to the Lord God Almighty and to the Lamb for ever, who had redeemed us to God, and brought us out of the captivity and bondage of the world, and put an end to sin and death, and all this was by and through and in the light of Christ within us' (Epistle to the Reader, prefixed to Fox's *Great Mystery*).

In such a passage we see how naturally the 'distinguishing views' of Friends flowed as corollaries from the main proposition—their distrust of an instituted ministry, their position as to the non-necessity of all outward ordinances, their views as to a worship of creaturely silence and spiritual spontaneity, their encouragement of the ministry of women, their nonconformity to the customs of the world, their determination to make life a walking in the light. Seldom has a great spiritual truth been followed along its untried consequences with more resolute steps. In the indwelling Light of Christ, the whole of life became sacramental and incarnational, penetrated with religion of the prophetic type, which draws its strength and its vision from intercourse with God. The cardinal principle of the Inward Light was, however, very imperfectly formulated, even by the Quaker Apologist, Robert Barclay, and has to be studied in experience rather than in statement. It was also held by Ranters and other mystical groups, who sometimes believed themselves freed thereby from all law. But the Quakers were 'children of the Light,' and from the first safeguarded the experience on the ethical side by insisting that there could be no real presence of Christ apart from a walking in the Light. In other respects their conception was seriously limited by the mental outlook of the age.

'They tried in vain to express this [the Divine] immanence in terms of the Augustinian dualism which had moulded the religious thinking of the Western world. So long as God and man were placed in separate chambers of thought, the light was necessarily either wholly human or wholly Divine. To make it human meant denial of the need for both revelation and salvation; hence it was claimed as absolutely Divine. But this involved the infallibility of each person to whom the Light was given, and the ousting of human faculties from any place in dealing with the things of God. Man had no religious faculty requiring cultivation; religious instruction was needless; the more his mind was emptied—the more it became 'like a sheet of blank paper'—the cleaner would it be for the writing upon it of Divine oracles' (Edward Grubb, *Authority and the Light Within*, p. 88).

The 'Light' or 'Seed' was, in Barclay's words, 'not only distinct, but of a different nature, from the soul of man and its faculties.' Especially was it to be distinguished from reason. As God gave two lights, the sun for day and the moon for night, 'so hath He given man the light of His Son, a spiritual Divine Light to rule him in things spiritual, and the light of reason to rule him in things natural' (Barclay, *Apology for the True*

Christian Divinity, prop. vi. sec. 16). As a result of this faulty conception of the Inward Light, the early Friends depreciated learning, and, in the sense of enhanced personality which came to them, thought themselves freed from human error and ignorance; and they were betrayed into extravagances of speech and conduct. Nayler's fall (see below) and other painful instances made them recognize the fallibility of the individual, which they sought to correct by bringing in the corporate judgment of the community. This had dangers of its own, especially at periods when the corporate enlightenment of the Society was low, though group-guidance proved of high value when it came from those who were spiritually alive and alert. The distrust of intellect long continued, and was a chief cause in bringing in a period of traditionalism, rigid in discipline but barren in vitalizing teaching and inspired leadership. In spite, however, of faulty formulation and intellectual sterility, the experience of the Inward Light maintained itself with the help of the prescribed ways of sober Quaker life, and the introspective silence of the Meeting for Worship. But the absence of a teaching ministry and systematic Bible study led, at the beginning of the 19th cent., to the merely subjective spirituality of Elias Hicks (see below), and then, in the evangelical reaction from such teaching, to official statements of belief which minimized the central Quaker experience.

It is, in fact, only under modern conditions of thought that this central experience has found adequate expression. Quakerism now sees no opposition between the human and the Divine, and, alike in the Scriptures, the Church, and individual experience, it expects to find the Divine illumination in partnership with human faculties. It recognizes the need for correcting personal illumination by the Light which has come to the race in science, history, and literature. It is beginning to realize that the prophetic type of religion calls in an especial degree for a broad and expansive education. A Society which has no ordained clergy or prescribed forms of service needs to be richly equipped with prepared men and women. It must live not by institutional strength, but by inspiration, by that personal and group-intercourse with the Divine which enriches man's highest faculties with the Light and Life of Christ.

3. Congregational principles and organization.—The Church is regarded as a body of disciples of Jesus Christ, *plus* Jesus Christ Himself, as its very life and Head, the whole forming together 'one flock, one Shepherd' (Jn 10¹⁶). Friends do not practise water-baptism as a condition of Church membership, lest it obscure the necessity for the vital spiritual experience (see art. BAPTISM [Later Christian] in vol. ii. p. 405*), and they find their spiritual food and communion in Christ Himself, and not in the use of symbolic bread and wine. They distrust formal creeds, and their doctrinal statements have been intentionally framed with a close adherence to Scripture language. The earliest of these was put forth by the Quaker Mission to New England in 1657; the latest is the Declaration of Faith issued in America by the Richmond Conference in 1887. For Robert Barclay's *Apology*, see art. CONFESSIONS, in vol. iii. p. 888. Membership in the Society is now either by 'convincement' of the spiritual truths to which Friends witness, or, in England, by birth if both parents are Friends. Many American bodies give these children at first only an associate membership.

For fifty years or more after the founding of Quakerism there was no regular membership; those who were 'grown in the Truth' were invited to sit in the business meetings, and lists of such persons were kept. In 1737, in connexion with poor relief, a rule as to settlement was set up by the London Yearly Meeting, which incidentally directed 'the wife and children to be

deemed members of the Monthly Meeting of which the husband or father is a member, not only during his life, but likewise after his decease, until they shall gain another settlement elsewhere.'

The Society is opposed to sacerdotalism, believing that all true disciples—men and women—are channels through which grace may flow to others (Jn 7³⁷⁻³⁹). This involves a responsibility upon the whole membership to be good stewards of the manifold grace of God. Persons—men and women—whose gifts are approved by the Church may be 'recorded' as ministers, but they have no salary or separate duties. The spiritual stimulus of Quakerism has at many periods been provided mainly by ministers itinerating 'under religious concern,' and their expenses are then always gladly borne. The Meeting for Worship is characteristic of the Friends. Here there is no ritual or pre-arrangement; the Meeting gathers on a basis of silence, or, more accurately, of waiting upon the Lord, with freedom for the offering by any of prayer or praise, ministry or teaching, under the guidance of the Spirit. Where the group-fellowship and worship of such a meeting are strong, the spiritual communion is a very real thing; but other types of meeting for teaching and evangelistic purposes are also found helpful, now that the Society is again expanding its borders. In them all, group-fellowship, wide-spread responsibility, and spiritual guidance are usually emphasized. In many parts of America, however, a pastoral system has been established under the stress of local conditions.

The Quaker movement had at first little organization; it depended mainly on group-life and inspired leadership. General meetings of neighbouring groups were held, and each group had its local leaders or 'elders,' and received occasional visits from the itinerating leaders or 'Publishers of Truth.' In 1653 business meetings for county districts began in the North, and by 1660 we find a general business meeting for the whole country held at Skipton. This incipient organization did not survive the storm of persecution after the Restoration, and the present system is due to the labours of Fox in 1667 and succeeding years. The Monthly Meeting, consisting of a group of meetings, is the executive unit of government, receiving and 'disowning' members, appointing 'elders' and 'overseers,' and caring for the meetings composing it. A superior meeting held quarterly links together a group of Monthly Meetings, while the Quarterly Meetings form the Yearly Meeting, which legislates for the whole body and does centralized executive work through its own committees, the name of its general executive committee, 'the Meeting for Sufferings,' taking us back to the old days of persecution. These Church-meetings are now open to all members, both men and women, and questions are not decided by voting, but by the 'Clerk' recording 'the sense of the meeting' in a minute that expresses the weight of spiritual judgment on the matter in hand. The practical result is conservative and unifying, for minorities are respected, and there is no cleavage into parties.

4. Antecedents.—The first Friends spoke of their experience as the revival of primitive Christianity after a long and dark night of apostasy. R. M. Jones, in *Studies in Mystical Religion*, has pointed out how the Separatist sects of the Long Parliament period were the product of centuries of striving after an inward way to God. 'There was in England . . . a real contagion of the idea of God as indwelling' (p. 469). The Familists and Boehmists on the one hand, and the General Baptists on the other, show many points of affinity to Quakerism, although the proof of direct

connexion is forthcoming only in the case of the Baptists (see below). In *Journ. Friends' Histor. Soc.* viii. 104-106, A. Neave Brayshaw shows, out of Edwards' *Gangræna* (1646-47), that all the distinguishing views of Friends are found somewhere or other in Edwards' list of 'errors, heresies, and blasphemies.' 'It was as if George Fox had put a magnet into a mass of rubbish and drawn out what few bits of iron there were in it.' The 'Seekers' (cf. the parallel Dutch 'Collegiants') were the direct forerunners of Quakerism. They were persons who had used the new religious liberty of the time to make a quest after truth, and, having found no rest in current forms or doctrines, were waiting, in a fellowship of prayer, for a further revelation and a new demonstration of the Spirit. The message of Fox found a quick response in the honest and good ground of their hearts. See SEEKERS.

5. History.—George Fox, of Fenny Drayton, in Leicestershire (1624-1691), the founder and prophet of Quakerism, learnt the trade of a shoemaker, and developed a singular purity and sincerity of character. He spent some years, from 1643 onwards, in a fruitless quest for truth; no man could satisfy his search.

'And when all my hopes in . . . all Men was gone,' he says, 'so that I had nothing outwardly to help me, nor could tell what to do, then, O then I heard a Voice which said, There is one, even Christ Jesus, that can speak to thy Condition; and, when I heard it, my Heart did leap for Joy. . . . For, though I read the Scriptures, that spake of Christ and of God, yet I knew Him not, but by Revelation, as He who hath the Key did open, and as the Father of Life drew me to His Son by His Spirit' (*Journal*, 1694 ed., p. 8).

A direct experience of truth came to Fox through these 'openings,' as he called them, and the Light and Life within him gave the young prophet a spiritual outlook on the whole of life, and sent him forth with a burning message. At Mansfield, in 1648, a company of 'shattered' Baptists accepted his message, and became the first group of 'Children of the Light.' In 1651 he gathered Quaker groups in Yorkshire, especially among Seekers at Balby, near Doncaster, and at Wakefield, where William Dewsbury (1621-1688) and James Nayler (1618-1660) were 'convinced.' But June 1652 was the creative moment in the history of Quakerism. Fox found 'a great people in white raiment,' waiting to be gathered, in a large community of Seekers in Westmorland, who had meetings throughout the district, and who met from all parts once a month, for religious fellowship, at Preston Patrick. They were men of deep religious temper and wide Bible knowledge, and many hundreds of them, under the influence of a few powerful meetings, won for themselves the same first-hand experience of a Living Christ which Fox enjoyed. Their leaders, Thomas Taylor (1617-1682), Francis Howgill (1618-1669), John Audland (1630-1664), Edward Burrough (1633-1663), and others, furnished the movement with the 'Publishers of Truth' who, with help from the Yorkshire Seekers, carried the message through the North of England in 1653 and 1654, and then, in the summer of 1654, spread over the South, paying special attention to London, Bristol, and Norwich. By the end of 1655, Quakerism had run like fire through England, and was being carried to Ireland and Scotland. It was readily accepted by many Seekers and some Baptists, but roused the dominant Puritan sects to great hostility.

'Satan,' say the Cumberland and Westmorland ministers, 'desgorgeth from his hateful stomach a swarm of Quakers; these . . . came upon us like a furious Torrent; all is on fire on the sudden, many are unsettled, the foundations shaken, and some apostatize: here we are beaten off, and are forced to lay other things aside, that we might more fully binde ourselves to quench these flames' (*The Agreement of the Associated Ministers*, etc., 1658, cited from B. Nightingale, *The Ejected of 1662 in Cumberland and Westmorland*, Manchester, 1911, i. 98).

Extravagances of conduct attended the beginnings of the movement, especially in the disturbance of ministers, virulent and aggressive controversy, and unwise testifying by signs, culminating in Nayler's Messianic entry into Bristol in October 1656, in sign of the cardinal Quaker experience that Christ was come and was revealed in His saints.

In spite of much sporadic persecution, the qualified religious freedom of the Commonwealth gave the ardent itinerating 'Publishers of Truth' their opportunity, and Quaker groups multiplied throughout the land. The storm of suffering in the early years of the Restoration period cut off many of the first leaders, and left the body weakened and distracted. Fox himself, during his imprisonment at Lancaster and Scarborough (1664-1666), was 'as a man buried alive.' On his release he devoted himself to binding Friends together in corporate life, especially by organizing 'Monthly Meetings' throughout England. Opposition, known as the Wilkinson-Story controversy from its two chief leaders, showed itself from those who distrusted all human arrangements; it lasted from 1673 till after 1700, but at the time the strengthening of organization greatly assisted the Friends, and their numbers increased in spite of persecution. Some men of great ability joined the movement: Isaac Penington (1616-1679), convinced in 1658; William Penn (1644-1718), convinced in 1667; Robert Barclay (1648-1690), also convinced about 1667; and George Keith (1638-1716), who about 1692 led a separation from Friends. With the passing of the Toleration Act (1689) a period of prosperity and traditionalism set in, during which the Society devoted itself to its discipline instead of to the raising of spiritual leaders and the aggressive work of the Church. In 1751, Samuel Bownas (1676-1753) wrote: 'The young generation of this age don't seem to come up so well as could be desired. The church seems very barren of young ministers to what it was in our youth, nor is there but very little conviction to what was then.' But signs of revival showed themselves before the end of the century. John Fothergill (1712-1780) had founded Ackworth School in 1779, and Friends were being interested in education, while John Woolman (1720-1772), 'the consummate flower of American Quakerism,' was profoundly stirring Friends on both sides of the Atlantic to a living witness on great human causes, such as anti-slavery.

Friends, at their first entrance into America in 1656, had met with fierce hostility from the Puritan rulers of Massachusetts, and in 1659 and the following years four Quakers were hanged on Boston Common—William Robinson of London, Marmaduke Stephenson of Yorkshire, Mary Dyer of Rhode Island, and William Leddra of Barbados. Quakerism, however, gained great importance in the New World. Rhode Island welcomed the message, and for more than a hundred years Friends were continually in office. They came into possession of West Jersey in 1674, and of East Jersey a few years later; and in 1681, William Penn began the 'holy experiment' of Pennsylvania. North Carolina also owed much to their influence, while in other colonies, and even in Massachusetts, they became a growing power.

'Their failure to appreciate the importance of the fullest expansion of human personality by education is the primary cause of their larger failure to win the commanding place in American civilization of which their early history gave promise. Their central Principle, properly understood, called for a fearless education, for there is no safety in individualism, in personal responsibility, or in democracy, whether in civil or religious matters, unless every individual is given a chance to correct his narrow individualism in the light of the experience of larger groups of men. . . . The absence of constructive leaders, the later tendency to withdraw from civic tasks, the relaxing

of the idea of reshaping the world, were due in the main to the lack of expansive education' (R. M. Jones, *The Quakers in the American Colonies*, xxvi. f.).

This same failure, leading to lack of Bible knowledge and of teaching ministry, paved the way for the serious 'Hicksite' division in America (1827-28). Elias Hicks (1748-1830) was a Quaker minister of commanding personal influence, whose emphasis on the 'spirit and power of God in the soul of man, as his Creator, Preserver, Condemner, Redeemer, Saviour, Sanctifier, and Justifier' (*Journal*, 1832 ed., p. 330), caused him to put into the background the person and work of Christ. Towards the close of his life he came into conflict with the section of Friends who held 'evangelical' views with regard to Christ and the Scriptures. In 1827 and 1828 a division took place in Philadelphia and some of the other American Yearly Meetings, in consequence of action by the 'elders' against Hicks, those who withdrew not necessarily identifying themselves with his views, but taking the position that God alone is Sovereign of the conscience, and that this inalienable right must be preserved 'unfettered by the hand of man and unalloyed with prescribed modes of faith, framed in the will and wisdom of the creature' (see Thomas, *Hist. of Friends in America*, 134 f.). The Society in America was cleft in twain, and each portion lost the balancing influence of the other. English travelling ministers had supported American Friends of the 'orthodox' school, and the separations powerfully reacted on the London Yearly Meeting. In 1829 a declaratory minute was passed, affirming belief in the inspiration and authority of the Bible and in the person and work of Christ. In 1835, Isaac Crewdson (1780-1844) of Manchester, a strong 'evangelical,' went beyond this by publishing *A Beacon to the Society of Friends*, in which he freely criticized the writings of Elias Hicks. The attack developed into a rejection of the central doctrine of Quakerism regarding the work of Christ in the heart; and, in 1836, Crewdson and about 300 other Friends left the Society. London Yearly Meeting, meanwhile, adopted a mediating position, asserting on the one hand, in 1835, the value of the writings of the early Friends, and on the other, in 1836, its faith in the authority of the Scriptures. The Society in England followed, as a whole, the leadership of men like Joseph John Gurney (1788-1847), an ardent philanthropist and Bible student, of evangelical but spiritual views, though a visit he paid to America in 1837 caused opposition from John Wilbur (1774-1856), who distrusted his views and his 'creaturely activities,' and led to a series of small 'Wilburite' secessions in some of the American Yearly Meetings. That in Ohio, in 1854, carried with it the sympathies of many Friends in the important Yearly Meeting of Philadelphia, which gradually retired into the semi-isolated position with respect to the other Yearly Meetings which it has since occupied. During the last half-century there has been much expansion and change in the group of Yearly Meetings styled 'Orthodox' in the United States Census, and a Pastoral System with arranged Services has gained great hold. This group has found a unifying and conserving force in a representative Five-years Meeting and a uniform discipline, which date from 1902, but sprang out of a Conference held at Richmond, Indiana, in 1887. Education is now provided for in a number of good schools and colleges, of which Haverford, Pennsylvania, is the best known. Philadelphia Yearly Meeting preserves a somewhat conservative type of its own. The so-called Hicksite bodies have declined in membership, but are now showing signs of fresh life, especially in philanthropic and educational directions. The

'Wilburite' bodies, though reinforced by other Friends who disliked innovations made in some of the 'orthodox' Yearly Meetings, are reduced in numbers and have little outlook.

In England, a great recovery of liberty has taken place as the fruit of a large tolerance. The fenced-in life of a peculiar people has passed away, and the spiritual experience and message of Friends have freely expressed themselves in home and foreign mission work, in philanthropy and education, in the service of business and public life, in the earnest study of social conditions, and, perhaps most characteristically, in the great 'Adult School' movement with a membership of over 100,000, which bears throughout the impress of its Quaker origin. The Manchester Conference of 1895 showed that the Society was receptive to the fresh life and thought of the age, and a strong educational and spiritual stimulus has been given through Summer Schools and the Woodbrooke Settlement at Birmingham.

Irish Quakerism, begun by William Edmondson (1627-1712) in 1654, became organized as Dublin Yearly Meeting. In the Rebellion of 1798, Friends maintained their peace principles and succoured the distressed at the cost of great peril and suffering. In the following year a separation took place, associated with the influence of an American travelling minister, of rationalistic views, Hannah Barnard. In more recent years the Society has responded to the same influences that have been at work in England.

Scotland forms part of London Yearly Meeting, which also includes some groups of Friends in Australia, New Zealand, and South Africa. Friends in Canada have their own organization.

English and Irish Friends have important foreign mission work in India, Madagascar, Syria, China, Ceylon, Constantinople, and Pemba, mainly under the care of the Friends' Foreign Mission Association which was begun in 1868. American Friends have work in Alaska, Mexico, Cuba, Jamaica, Palestine, Africa, and Japan.

Conscription has almost crushed out Quakerism in France and Germany. Holland at one time had a number of Quaker groups, and produced the Quaker historian, William Sewel (1654-1720). There are several small groups of Friends in Denmark and Norway.

6. Ethical and social features.—Quakerism has been called 'practical mysticism,' and has always had 'a moral earnestness and a social intensity which saved it from the easy pitfalls of mystical quests.' Fox laid constant emphasis on walking in the Light. Seeking to see the Light and to obey it, Friends gained clear vision on great moral issues. Their use of 'thee' and 'thou' to all ranks of men, and their refusal of 'hat-honour' and of oaths, were parts of their witness for reality in life and for a single standard of conduct before God and man. The Children of Light lived, as Fox said in 1651, 'in the virtue of that life and power that took away the occasion of all wars,' and the Society of Friends has steadily maintained the unlawfulness of war to the Christian. Friends were among the first champions of liberty of conscience, and kept their public meetings in the Restoration period in the face of terrible persecution, refusing to conceal or forgo their meetings, 'for such practices are not consistent with the nobility of the truth, and therefore not to be owned in the Church of Christ' (Yearly Meeting Minute, 1675). They were the first Christian body to free themselves from complicity in slavery, and became the back-bone of the anti-slavery agitation both in England and in America, and, later, of the anti-opium movement. They have taken a leading part in prison reform, temperance work, and

popular education; they have originated and shaped the 'Adult School' movement, and are keenly interested in the investigation and improvement of social conditions. In the American colonies, especially in Rhode Island, New Jersey, and Pennsylvania, they attempted the difficult task of righteous government, and have no reason to be ashamed of their record. The following states their present standpoint as to the duty of public service:

'Our conviction of the unlawfulness of war to the Christian, which prevents us from giving the military service to our country gladly rendered by many, should specially call us to voluntary service in other ways, even at the cost of much personal sacrifice. Those who devote themselves with public spirit to the building of national character, the shaping of righteous policy at home or abroad, or the manifold tasks of local or central government, are doing work of high value for the kingdom of God. But we feel the need in such service of continual watchfulness against bitterness of party-spirit, self-seeking, and disloyalty to the truth' (*Book of Christian Practice*, London, 1911, p. 126).

In private life, Quakerism has tended to produce a definite type of character—strong, straight, and serious—which has resulted from the habit of bringing the conduct of life to the test of the Inward Light, and from the personal responsibility in matters of religion thrown upon each individual member. The type stands out supremely in such men as John Greenleaf Whittier (1807-1892) and John Bright (1811-1889), and such women as Elizabeth Fry (1780-1845). The wide influence exercised by Friends seems primarily due to this cultivation of a spiritually enlightened judgment and an alert conscience.

7. Problems.—In this section especially, the writer cannot do more than give expression to his own personal views. The Society of Friends has to-day an opportunity not unlike that which it enjoyed at its rise, owing to the existence of numbers of earnest-hearted seekers after truth, to whom the sacerdotal and institutional forms of religion make little appeal, but who long for the help that comes from group-fellowship, penetrated by the living Spirit of Christ. At their best the Friends have this to offer; but, while they are now alive to the adequate intellectual presentation of their message, its actual embodiment in worship and in life is often feeble. The two pressing problems which are now being faced are (1) to re-interpret Christian discipleship under the social and intellectual conditions of the 20th cent., and (2) to give this group-discipleship free scope in moulding the meetings and other corporate activities of the Society. The social conditions and the aspirations of the age challenge such a body as Friends to a new taking up of the cross in daily life. George Fox in 1656 laid bare what has proved to be the besetting weakness of modern Christianity (*Ep.*, no. 131):

'There is the Danger and Temptation to you of drawing your Minds into your Business and clogging them with it, so that ye can hardly do anything to the Service of God, but there will be crying, My Business, My Business, and your Minds will go into the things and not over the things, and so therein ye do not come into the Image of God, in which is Dominion.'

As Friends open their hearts to see and obey the Light on the great social and moral problems of the day, their witness for truth will acquire fresh vigour, and they will be made 'friends of God and prophets.' Truer discipleship of this kind brings with it a kindling of group-fellowship which will make the meetings for worship and the other meetings of the Society glow with a new life. Thus only can Friends vindicate their great witness for the freedom and spirituality of the gospel order.

8. Statistics.—The following statistics relate to members only: there is also a large number of adherents. The figures in most cases are for the year ending 31st Dec. 1910.

EUROPE—	
Great Britain	18,840
Ireland	2,405
Denmark, France, Norway, Germany, Turkey	200
ASIA—	
Foreign Mission stations in Syria, India, Ceylon, China, and Japan	902
AFRICA—	
Cape Town, etc.	37
Foreign Mission stations in Madagascar	2,671
AMERICA—	
United States, so-called Orthodox branch	94,852
" " " " Hicksite	18,401
" " " " Wilburite, etc., branches	4,000
Canada " " " Orthodox branch	1,060
" " " " Wilburite	200
Foreign Mission stations in Alaska, Mexico, and Jamaica	2,872
AUSTRALIA and NEW ZEALAND	645
	<hr/>
	147,085

LITERATURE.—A substantially complete bibliography up to 1892 is contained in three important works by Joseph Smith: *A Descriptive Catalogue of Friends' Books*, 2 vols., London, 1867, *Supplement to a Descriptive Catalogue*, do. 1893, and *Bibliotheca Anti-Quakeriana*, do. 1873. The following works will be found of special value:

(1) *POLITY*.—Robert Barclay, *An Apology for the True Christian Divinity*, Lat. 1676, Eng. 1678, and later editions; see also his collected works, 1692; various treatises of Isaac Pennington, collected works, 1681; do. of William Penn, collected works, 1726; Jonathan Dymond, *Essays on the Principles of Morality*, London, 1829, and later editions; John S. Rowntree, *The Society of Friends, its Faith and Practice*, do. 1901; *Christian Discipline of the Society of Friends*, do. (Doctrine) 1883, (Practice) 1911, (Church Government) 1906. For the Inward Light, see Caroline E. Stephen, *Quaker Strongholds*, do. 1907, and *Light Arising*, do. 1908; Edward Grubb, *Authority and the Light Within*, do. 1908; J. Rendel Harris, *The Guiding Hand of God*, do. 1905; W. C. Braithwaite, *Spiritual Guidance in the Experience of the Society of Friends*, do. 1909; and the religious poems of J. G. Whittier.

(2) *JOURNALS*.—Records of service undertaken under religious exercise are the most characteristic form of Quaker literature. Among the most important are those of George Fox, 1694, etc., the original draft of which for 1650-1676 has been edited, with full illustrative notes, for the Cambridge University Press by Norman Penney, 2 vols., 1911; George Whitehead (1636-

1723), *Christian Progress*, 1725; Thomas Ellwood (1639-1713), *Life*, 1714, etc.; Thomas Story (1662-1742), *Journal*, 1747; John Woolman, *Journal*, Dublin, 1776, etc., esp. ed. with J. G. Whittier's preface, London, 1900; Stephen Grellet (1772-1855), *Memoirs*, London, 1860; Elizabeth Fry, *Memoir*, 1847, and *Life* by Georgina K. Lewis, do. 1910; Joseph John Gurney (1788-1847), *Memoirs*, do. 1854.

(3) *HISTORY*.—The Friends' Reference Library, Devonshire House, Bishopsgate, London, contains the largest collection in the world of MSS and printed materials. Its librarian, Norman Penney, is one of the secretaries to the Friends' Historical Society, which publishes a quarterly *Journal*, 1904 ff., and valuable *Supplements*. The Friends' Historical Society of Philadelphia, founded 1904, also publishes a *Bulletin* (ed. Allen C. Thomas). For sufferings, see Joseph Besse, *A Collection of the Sufferings of the People called Quakers*, 2 vols., London, 1753. For general history: William Sewel, *Hist. of the Rise, Increase, and Progress of the Christian People called Quakers*, London, 1722, etc.; Samuel M. Janney, *Hist. of Friends*, 4 vols., Philadelphia, 1859-67; James Bowden, *Hist. of the Society of Friends in America*, 2 vols., London, 1850-54; Allen C. Thomas and Richard H. Thomas, *Hist. of the Friends in America*, Philad. 1905; T. Edmund Harvey, *The Rise of the Quakers*, London, 1905; Elizabeth B. Emmott, *The Story of Quakerism*, do. 1908. A history, planned by the late John Wilhelm Rowntree, which should adequately exhibit Quakerism as a great experiment in spiritual religion, and should be abreast of the requirements of modern research, is now in course of preparation and publication. Three volumes have been published: Rufus M. Jones, *Studies in Mystical Religion*, London, 1909, dealing with pre-Quaker mystical movements; Rufus M. Jones, assisted by Isaac Sharpless and Amelia M. Gummere, *The Quakers in the American Colonies*, do. 1911; and W. C. Braithwaite, *The Beginnings of Quakerism*, up to 1660, do. 1912. For other historical studies, see Maria Webb, *The Fells of Swarthmoor Hall*, London, 1865, and *The Penns and Penningtons*, do. 1867; Robert Barclay, *The Inner Life of the Religious Societies of the Commonwealth*, do. 1876; Thomas Hodgkin, *George Fox*, do. 1897; H. G. Wood, *George Fox*, do. 1912; John Wilhelm Rowntree, *Essays and Addresses*, do. 1906; John S. Rowntree, *Life and Work*, do. 1906. For the Adult School Movement, see J. W. Rowntree and Henry B. Binns, *Hist. of the Adult School Movement*, do. 1903. For the distribution of the Friends in the United States of America, see *Special Reports of the Bureau of the Census, Religious Bodies* (1906), Washington, 1910, i. Index, s.v. 'Friends,' ii. 294-306. WILLIAM C. BRAITHWAITE.

FURIES.—See EUMENIDES, ERINYES.

G

GABARS.—The name popularly applied to the Zoroastrians still residing in Persia, in contradistinction to their co-religionists in India, the Parsis (*q.v.*).

1. The name.—The term 'Gabar,' 'Gabr,' or 'Guèbre' is of uncertain origin, but is connected by some Persian lexicographers with the Arab. *kāfir*, 'infidel,' which sense it bears, signifying both 'infidel' in general, and 'Zoroastrian' in particular (Vullers, *Lexicon*, Bonn, 1855-64, ii. 950). The abstract derivative *Gabrī* accordingly denotes 'the religion of Zoroaster'; the Perso-Turkish *Gia(v)ūr* (popular Turkish *Kiavūr*), which is given as the source of *Gabar*, is itself derived from *kāfir*. Other variants of the Pers. form *Gabr* are *Gāv* and *Gaur*. It is also noteworthy in this connexion to observe that in Balūchī *gaur* denotes 'infidel,' and in Kurdish the corresponding loan-words *gebir* and *gāvīr* connote 'Armenian' and 'Russian' respectively (Geiger, in *ABAW*, I. Cl. xix. [1891] section 2, p. 449), thus favouring the derivation of the Pers. *Gabr* from the Arab. *kāfir*. The view sometimes advanced that *Gabr* represents the book-Pahlavi *gabrā*, 'man,' is far less likely. It should also be noted that for *kāfir* the Kirghiz say *keuz*, first noted by Vambéry as the name of an unidentified people who inhabited Turkestan in the pre-Islāmic times (Radloff, *Versuch eines Wörterbuches der Türkdialekte*, St. Petersburg, 1839-98, ii. 51). Though in modern travellers the appellations 'Guèbres,' 'Gaures,'

'Gauvres,' and 'Gaori' are found, the latest English form is 'Gabar.' The Gabars designate themselves, however, as *Zardushtiān*, 'Zoroastrians,' or *Bih-dinān*, 'those of the good religion,' and also *Pārsīs*, from Fārs or Pārs, the old province of Persia Proper. *Gab'ar*, on the other hand, is a derogatory term not used among Zoroastrians.

2. Statistics.—It was impossible before the beginning of the 19th cent. to form an idea of the numbers of the Persian population who, after the Arab conquest, remained faithful to the old Zoroastrian creed. From this time, however, we can refer to some approximate censuses taken by European travellers. Dupré (1807-1809) and Kinneir (1813) give an estimate of 4000 families; Trezel (1807-1809) mentions 8000 Gabars at Yazd and in the surrounding villages; Christie (1809) and Frazer (1821) 3000 families in the whole of Persia; Abbot (1845) 800 families at Yazd and in the neighbourhood; Petermann (1854) registers 3000 families in Persia, of which 1200 were at Yazd; Goldsmid (1866) 4500 at Yazd and Kirmān; Evan Smith (1870) 3800 families, etc. (cf. Houtum-Schindler, *ZDMG* xxxvi. [1882] 54).

If we consult the censuses taken in 1854 by order of the Persian Zoroastrian Amelioration Fund of Bombay, the first shows a total of 7711 individuals, distributed as follows: 6658 at Yazd (3310 men and 3348 women); 932 at Kirmān; 100 at Teheran; and 21 at Shirāz (cf. Houtum-Schindler, p. 56).

In October 1879, Houtum-Schindler obtained the following figures: total population, 8499 individuals (4367 men and 4132 women), distributed as follows: Yazd 1242, and in the neighbourhood 5241; Kirmān 1498, and in the neighbourhood 258; Bahrāmābād 58; Teheran 150; Kāshān 15; Shirāz 25; Bushire 12 (cf. *op. cit.* p. 55).

In the month of February 1892, Kaikhosrū T. Khorsend, Agent of the Persian Zoroastrian Amelioration Fund, after having visited Yazd, Kirmān, and the other localities inhabited by Gabars, gave the exact number of the Zoroastrian population in Persia as amounting to 9269.

In 1902, Ardashir Edalji, the Teheran Agent for the Parsis of Bombay, furnished Jackson with statistics (*Persia, Past and Present*, p. 425) which show that the total number of Gabars in Persia was about 11,000. The figures, as Jackson states, indicate that the number of Zoroastrians is increasing slightly instead of declining.

3. Ethnography.—Ancient authors are agreed in placing the Persians, especially the women, amongst the most beautiful types of the human race (e.g., Xenoph. *Anab.* iii. 2. 25; cf. Brisson, *De regio Persarum principatu*, ed. Lederlin, Strassburg, 1710, pp. 561–563). The sculptures of the Achæmenian and Sasanian periods have fixed the features not only of the Persians but also of the conquered races—evidence which allows of the establishment of valuable comparisons. After the Muhammadan conquest one can follow the intermixture of races which have successively obtruded themselves upon Persia through conquest or invasion—the Semites with the Arabs, the Turanians with the descendants of Tamerlane; under the Şefavid dynasty (15th–17th cents.) the Georgian and Armenian element prevailed and played a preponderating part in the crossings of race. It was only in the 19th cent. that Persia became restricted to its own national resources.

As for the Gabars, the isolation caused by their religious faith and by persecution must have created special conditions for them and perhaps assured the persistence of the type, if one could be perfectly sure that, in conformity with the sentiment which opposed marriage with non-Zoroastrians, legitimate or illegitimate unions were never contracted between the Gabars and the other nationalities. Travellers who have met them have often described them. It seems that the fine Persian type—absolutely Aryan with the Gabars of Yazd—has suffered because of their persecutions, their difficult life, and their toilsome occupations. The amelioration of their material welfare will naturally tend to the physical elevation of the race.

4. History.—The battles of Buwayb and Qādi-siyya (A.D. 635–37) and the last defeat of Nihāwand (641) put an end to the great Sasanian empire which had lasted more than four centuries (226–652) (see art. SASANIANS). The king Yazdagird III. escaped, and after painful struggles at last fled for refuge to Merv, where he was murdered by a miller who coveted his jewels (651–2) (Ṭabari, tr. Zotenberg, Paris, 1867–74, ch. lxviii.). The Arab conquest did not spread at once throughout the whole kingdom; the Persians continued for some time to resist, entrenched in different countries, especially in Fārs, the heart of the dynasty and kingdom, and in the northern and hilly region of Tabaristān where the Ispahbads, or military governors of the Sasanian rulers, maintained their independence till 760. It was probably from this region that the Zoroastrians who settled in India came (see art. PARSIS). The results of the conquest were neither so rapid nor so complete as is generally supposed. The choice between the Qur'ān and the sword was not strictly imposed on

the population. The Zoroastrians shared the same fate as the Christians and the Jews, and were allowed to profess their religion on condition of paying the *jizya*—a just arrangement, on the whole, as the non-Muslim subjects of the Khalifs were exempt from military service and the alms (*sadaqat*) obligatory on the Prophet's followers. According to al-Balādhurī, it was a rule (see below), but it did not prevent the storming of citadels, bloodshed, and all the evils inseparable from military expeditions; hence the miserable fate of the conquered race, over which historians have always lamented.

If the position of the natives, including not only Zoroastrians, but also Jews and Christians, immediately after the conquest, was fairly tolerable, it grew worse under the Umayyad Khalifs; war had degenerated into raids, and strict orders from Damascus obliged the Governors of the Persian provinces to grind down the populations and to drain money from them. The subject races suffered much on account of that policy, and the burden of the exactions fell chiefly on the peasants, who were unable to make their complaints listened to by the rulers.

The old aristocracy and landed proprietors (*dihqāns*) were able to preserve power, money, and property by embracing Islām and serving the conquerors, who could not dispense with their administrative talents; but it was not so for the humbler class. As is pointed out by Van Vloten, the ambition and social pride of the Arabs, combined with their greed, offered an insuperable obstacle to the amelioration of their lot. The non-Arab Muslims were regarded by the Arabs as no better than slaves.

'Nothing,' says Ṭabari—in speaking of the revolt of Muktar (683–87), whose supporters consisted to a great extent of clients—'so exasperated the (Arab) Kūfans as to see Muktar assign to the clients their share of the spoil. "You have taken from us our clients," they said, "who are the spoil which God hath destined for us, with all this province. We have liberated them, hoping for a reward from God, but you do not trouble yourself about this and cause them to share in our booty"' (*Recherches sur la domination arabe . . . sous le khalifat des Omayyades*, Amsterdam, 1892, p. 16).

Under the cruel government of Ḥajjāj ibn Yūsuf, converts to Islām were compelled to pay the *jizya*, which caused great discontent among them, and led them to join a rebellion which was quenched in blood. The non-Arab Muslims were sent to the villages with their names branded on their hands. Their discontent was further increased by the loss of the hope of ever becoming the equals of their conquerors, and greatly contributed to the fall of the Umayyads and the rise of the Abbasids, in spite of the efforts of the tolerant and enlightened Umar ibn 'Abd-al-'Azīz.

This really pious man used to rebuke his officials when they complained of the large number of conversions in Egypt, as it was a loss to the revenue of the State, saying that God had sent His prophet to act as an apostle, not as a tax-collector. He gave almost the same answer to the governor of Khorasan, who also complained that the people embraced Islām in order to be exempt from the *jizya*, and avoided circumcision, again saying that God sent Muhammad to make known His true faith unto men, and not to circumcise them (cf. Dozy, *L'Islamisme*, Leyden, 1879, p. 180 f.).

The revolt of Sindbād the Magian (755–56) is connected with the Shi'ite movement, and is considered as the last effort of the Persian nation to recover its independence.

Sindbād was a great friend of Abu Muslim, a pious and upright man who had embraced the cause of the Shi'ites and helped to raise the Abbasids to the Khalifate, but was most ungratefully treated by the latter, and finally murdered by al-Manşūr. Though a great propagandist (he had converted many *dihqāns*), he was not intolerant, as is shown by his friendship with a Gabar and from the support given to him by the Magians. Sindbād started from Nishāpūr, his native place, under the pretext of avenging Abu Muslim's murder, collected a numerous troop of followers, occupied Rai, where he took possession of Abu Muslim's treasures, and then declared that he was bent on Hijaz and the destruction of the Ka'ba. His army was composed of heterogeneous elements—Magians of

Tabaristān, Shī'ites, and others, whom he persuaded that Abu Muslim was not dead. Sindbād was defeated and killed by an Abbasid chief, and so ended that insurrection which had lasted seventy days according to some, seven years according to others.

The fall of the Umayyad Khalifs marked the end of the purely Arab period, and the accession of the Abbasid Khalifs inaugurated a new era, in which the Persian element played an important part. The seat of the Khalifate was transferred from Damascus to Iraq, and the administration was more and more entrusted to the Persians. Some of the old customs were revived; the festival of the *Naurūz* (first day of the Persian year; see FESTIVALS AND FASTS [Iranian]) was resuscitated; on the coins a Khalif appeared clothed in the true Persian fashion, while the Persian garb was the official court-dress. During fifty years a family (some say, of Zoroastrian origin), the Barmecides (752-804), wisely directed the affairs of the Khalifate, till the jealousy of Hārūn ar-Rashīd led him to destroy the grandsons of Barmak and many members of that family. The Barmecides gloried in being the descendants of the Magian Barmak, the high priest of the temple of Nawbahār at Balkh; and during the time of their favour the Zoroastrians enjoyed a sort of protection, since the Barmecides clearly retained a certain partiality for their former co-religionists (cf. L. Bouvat, 'Les Barmécides, d'après les historiens arabes et persans,' in *Revue du monde musulman*, Sept. 1912, pp. 3-131).

It was in the 9th cent. that some provinces began to separate from the Khalifate, and local dynasties were founded. The Tāhirids (820-872) made themselves independent in Khorasan; the Saffarids (872-902) were succeeded by the Sāmānids (902-999), who were the grandchildren of Sāmān, a Zoroastrian converted to Islām by a governor of Khorasan; the other ruling families of Bulwayhids (932), Ghaznavids (973-1038), and Seljūqs (1038-1194) disappeared one after the other.

The murder of the last Abbasid Khalif and the sack of Baghdad (1258) by the Mongols under Hūlāgū Khān, the grandson of Jenghiz Khān, put an end to the Khalifate. Next came Timūr and the horrors of his savage inroad. It is supposed that the small Zoroastrian communities of Gujarat were reinforced by the fugitives who fled before the invasion. Gabars and Muslims alike contributed to Timūr's ghastly pyramids of heads so often alluded to.

During this long period the Persians had gradually embraced Islām, and the number of the faithful worshippers of Ahura Mazda yearly decreased. The Zoroastrians were still quartered in Fārs and Kirmān, but down to the present day their history is shrouded in obscurity. It was only under the Sefavid dynasty, after the conquest of Khorasan by Shah Ismā'il (1510), that Persia recovered for the first time a political unity. Under Shāh 'Abbās we find the Gabars at Isfāhān, and we can obtain some particulars about them through the accounts of the European travellers who visited the Sefavid court. Shāh 'Abbās had sent for them and allowed them to settle in the outskirts of the city beyond the river Zandah Rūd. We owe to Pietro della Valle a good description of that settlement (1616-25):

'A few days ago I went to see their new town [that of the Gabars], which was near the new Ciolfa [the suburb Julfa] inhabited by the Christian Armenians. The new Tauris, or Abbas Abad, inhabited by the Muhammadans brought from Tauris, touches Isfahan as a suburb, and, though it is at present separated by gardens, yet, in course of time, the number of the inhabitants daily increasing in a wonderful way, Isfahan and that residence of the Gabars with the two aforesaid will form but one place. That is the reason why I do not know whether I can call them either separate citadels, or suburbs, or rather considerable sections of that same town of Isfahan. Like the region beyond the Tiber and the borough of our Rome, that place of the Gabars has no other name that

I know of than "the residence of unbelievers," just as we call the place inhabited by the Jews "the Ghetto." It is well built; the streets are large and straight, handsomer by far than those of Ciolfa, because it was built more carefully; but all the houses are low, one-storeyed, and plain, quite in keeping with the poor condition of the tenants. In that respect they differ from Ciolfa, which are very good and well kept, because the Gabars are poor and destitute; at least they appear to be so' (ed. Paris, 1661, ii. 104).

Don Garcias de Silva y Figueroa, in his description of Isfāhān (*L'Ambassade de Don Garcias de Silva y Figueroa en Perse*, tr. Wicquefort, Paris, 1667, p. 179), mentions the four settlements outside the town, and gives a sketch of 'Gabrabad,' which was 'within a musket shot' of the building where the Ambassador had put up. He estimates the number of the houses at about three thousand, forming several long, broad, and straight streets, in some places shaded by trees to protect the people against the heat of the climate, so that it passed for a large and handsome borough, and even for a pretty town, though it was only ten years since the king of Persia had obliged the Gabars (called *Gavres* by Don Garcias) to leave their native land and to come and live near Isfāhān. (This gives the approximate date of the foundation of Gabrabad, Figueroa being in Persia in 1618.)

Tavernier, later on, referring to the bridge of the Gaures (Gabars) at Isfāhān, says that it was built partly for the Gabars, 'who had their own ward beyond the river, in order to prevent them from passing through the great avenue of the Tchar-bag, and to allow them on their way home to take the shortest cut and reach their dwellings more rapidly.' That ward was simply a big village of which the first houses were not far from the river. The avenue which led from Isfāhān to that bridge was larger and longer than that of the Tchar-bag, and was equally planted on both sides with a handsome row of trees, but without any channel in the middle (cf. Tavernier, *Six Voyages en Turquie, en Perse, etc.*, i. 409).

Chardin registers the destruction of that prosperous place. Besides the suburbs of Isfāhān (already described by him), he mentions two others beyond the river, built on its banks and connected with it by two bridges; one of the suburbs, Sadat Abād, 'the abode of Felicity,' was the place where the Gabars were first quartered. They were expelled from it in order to turn their borough into a place for pleasure, with bazaars, baths, mosques, and palaces. It had been built by Shāh 'Abbās II., who transferred the Gabars to the other end of Julfa (cf. Kaempter, *Amœnitatum exoticarum, etc.*, p. 164). Chardin explains that 'Abbās the Great had brought to Isfāhān the Armenians and Gabars, but had located them outside the town, because they were artisans. Those families (Chardin says 1500) had come from Kirmān, and at 'Abbās' death many returned to their country (*Voyages en Perse et autres lieux de l'Orient*, iii. 76-77, etc.). Daulier still mentions Gabrabād as a handsome village. It was, of course, the new one (*Les Beautés de la Perse*, pp. 51-53). Its vestiges still existed in the early twenties of the 19th century.

Ker Porter mentions the settlement as follows: 'The liberal spirit of Shah Abbas tolerated the existence of the Gabars at Isfahan, where afterwards the Afghan Mahmud gave them a mart and enlarged the suburb still called "Guebrabad," but, like that of the Armenian colony at Julpha, it is fallen to decay: nothing now inhabiting its ruined streets, but houseless dogs and the refuse of the people' (*Travels in Georgia, Persia, etc.*, ii. 46).

No trace of Gabrabād can now be found. Three hundred yards below the bridge of Julfa, and at about the same distance above the Pul-i-Khaju, the river is crossed by the Pul-i-Jhubi, a brick bridge of fourteen arches—a sort of aqueduct to convey water to the palace of Haft-dast on the northern bank. The suburb upon the southern bank at this spot was known as Gabristān because it was inhabited by the Zoroastrians; but the ground was cleared by 'Abbās II., who transformed the place into a royal residence (see above) which was named Sadat Abād, or 'Abode of Felicity,' where he kept his seraglio. The name alone has survived. Another souvenir of the Gabar suburb is preserved in one of the many appellations of the Pul-i-Khaju; it was called 'Bridge of the Gabars,' because it led to the suburb of Gabristān and was built by 'Abbās II., in order that the Gabars might not pass across the main bridge of Julfa (Curzon, *Persia*, ii. 47-49).

The condition of the Gabars under the Sefavid kings, if not enviable, was still respectable; but it grew worse after the Afghan invasion. Mir Vā'iz having taken possession of Qandahār, the Persian king sent him emissaries who were treated with contempt, and Mir Vā'iz's son and successor, in order to invade Persia, took advantage of the opportunity which occurred when the Afghans of Herat threatened the N.E. frontier of the

kingdom and the Arab prince of Muskat settled on the shores of the Persian Gulf. That invasion caused the direst calamities to the Zoroastrian communities, Maḥmūd having chosen Kirmān rather than the deserts of Sistān. Kirmān and Yazd were the places where the bulk of the Zoroastrian communities were still important. Tavernier says (*op. cit.* p. 431) that, when he visited Kirmān (1654), there were ten thousand Zoroastrians there. Slaughter and enforced conversion distressed the faithful.

At the time of the second invasion of Maḥmūd, the prince persuaded the Zoroastrians of Yazd and Kirmān to join his troops and to avenge the wrongs they had sustained for centuries (Hanway, *The Revolutions of Persia*, ii. 149). The simple Gabars were easily persuaded, and enlisted under the banner of their old enemies. Their fate, after the siege of Isfāhān (21st Oct. 1722), is unknown. One of the captains of a Gabar corps bore the Musalmān name of Nāsīrallāh, but Hanway considers him as a Parsi or Gabar (*op. cit.* p. 152). Under Nādir Shāh and his successors enforced conversions, exactions, and slaughter again harassed the Zoroastrians.

The siege of Kirmān by Muhammad Āghā dealt them a deadly blow, and they shared the general fate of the native population (1794). In 1810, H. Pottinger saw a pyramid of six hundred skulls, a trophy of the Kadjar eunuch's victory. As for Timūr's old trophy, skulls of Gabars were certainly blanching in the same pile with those of the Muhammadan victims. The ruin of the quarter of the Gabars is ascribed to that time as well as the loss of their valuable MSS. Khanikoff says that their number amounted to at least 12,000 individuals (*Mémoire sur la partie méridionale de l'Asie Centrale*, p. 193).

Ker Porter, who visited them after those awful calamities, describes the Gabars 'with eyes bent on the ground and pouring tears for lustral water on their dishonoured shrines.' Yazd still contained four or five thousand faithful, and, from the comparative respectability of so considerable a body, 'they more openly exercised the offices of their religion there, and from the same reason at Kerman, than is ever attempted by the poorer Gabars in the villages about.' But, on the whole, the condition of the Kirmānis was not so good as that of the Yazdis (*op. cit.* p. 56).

At all times the fallen condition of the former lords of the land had impressed travellers. We may quote the opinions of some of them.

Pietro della Valle, who saw them in their suburb of Gabrābād under the tolerant rule of the Šefavid princes, describes them as poor, simple husbandmen, carrying on no trade, earning their livelihood (*op. cit.* p. 104). They were all dressed in the same manner and in the same colour, similar to the cement made of bricks (p. 105). Figueroa, at Gabrābād also (p. 179), points out the gentleness of their manners; the women were quite free, and used to sit at their doors, spinning and weaving. At Kirmān they had retained their old mode of living, dress, and religion (p. 177).

According to Thévenot, they were easily recognized by a dark yellowish colour that the men had adopted for their garments and the women for their veil; besides, the Gabar women, most of whom had fine features, never covered their faces (*Relation d'un voyage fait au Levant*, ii. 216).

Chardin thinks them not so well made or so white as the Muhammadan Persians (*op. cit.* p. 127). The men, however, were lusty, of a lofty stature, and had a good complexion. The women were coarse-looking, of a dark and olive-coloured complexion, which he ascribes to their poverty rather than to their nature, some of them having handsome features. The men had long hair and a full beard; they wore a short tight jacket and a cap of fine wool, very much like a hat. They dressed either in linen and wool stuffs or mohair, preferring the brownish or feuille-mort colour as being more suitable to their fallen condition. The women were coarsely dressed, and Chardin emphasizes his remark by saying that he had never seen anything that was so ungainly and devoid of elegance. In fact, he thought that the dress of the Gabars was so much like that of the Arabs that one would be inclined to think that the Arabs had borrowed it from them when they conquered the land. They were agriculturists, workmen, fullers, or furriers, and they made carpets, caps, and stuffs of a very fine wool.

Daulier (*op. cit.* p. 62) describes them as clad in a woollen stuff of a tawny colour; the dress of the men was of the same shape as that of the other Persians, but the women's dress was totally different. The latter used to go out unveiled, and

wore on their heads a scarf loosely twisted up (*façotte à la négligence*) with another veil which covered their shoulders, after the fashion of the Bohemians. Their trousers were like the Swiss breeches which go down to the heels. Most of the materials worn by the Gabars were made at Kirmān.

The chief occupation of the Gabars was agriculture. According to Chardin (*op. cit.* p. 127), they considered it not only grand and innocent, but also noble and deserving—a view quite in keeping with their sacred books. Their manners were gentle and simple; they lived under the rule of their elders, who were their magistrates, recognized by the Persians (*op. cit.* p. 128).

That taste for agriculture was to be their chief characteristic up to the 19th century. Ker Porter found them employed as labourers and gardeners. At Teheran they were for a long time gardeners in the precincts of the Seraglio on account of their strict morality (Dosabhoj Framjee, *The Parsees*, p. 32).

In the middle of the 19th cent. the poll-tax (*jizya*) had become more and more onerous to the non-Muhammadan subjects, not to speak of the Armenians and Jews. As regards the Zoroastrians, the annual taxation (it has been verified) amounted to the sum of 660 *tomāns* (£330), but, since the governors and collectors used to increase it, in order to make a profit, it was raised to nearly 2000 *tomāns* (£1000). According to statistics, a thousand Zoroastrians were compelled to pay; two hundred could do it easily; two hundred with difficulty; and the rest were utterly unable to pay, even under the threat of death. Considering the prosperous position of the Zoroastrians of India and the renewed intercourse between the two communities, it was highly desirable that something should be done through their influence in favour of their Iranian brethren.

The position of the latter was, in the main, as follows: they were branded with the appellation of 'Gabars' (infidels), and had to bear the same vexations as those experienced in India by the 'Mahars' at the hands of the high-caste Hindus. Houtum-Schindler, before the abolition of the *jizya*, stated (*op. cit.* p. 56) that the position of the Gabars was better than that of the Jews at Teheran, Kāshān, Shīrāz, and Bushire, while at Yazd and Kirmān the status of the Jews was preferable. The chief grievances of the Zoroastrians were the following: they were threatened with forced conversion; the property belonging to a Zoroastrian family was forfeited for the use and benefit of the proselytes, in spite of the rights of the legitimate heirs, and property recently acquired could be taxed to the advantage of the *mullahs* up to the fifth of its value; it was forbidden to build new houses or to repair old ones; the merchants were subjected to taxes besides the ordinary customs-duties. The murder of Zoroastrians was not punished; and their sanctuaries were often desecrated. The Gabars could not wear new clothes or ride a horse; they were obliged to put on dull yellow garments—a permanent reminder of the disabilities which had been equally shared by the Jews and Christians who, under the reign of Muttawakil, were compelled by enactments (A.D. 850) to wear honey-coloured gowns, parti-coloured badges, and caps and girdles of certain ignoble patterns; to ride only on mules and asses, with wooden stirrups and saddles of strange construction. Again, any intercourse with the Gabars being pollution, all lucrative occupations were forbidden to them. Besides, the inequality of the law in any Muhammadan country, which gives only the Faithful help and assistance, but denies it to unbelievers, is well known.

The Parsis of India, whose lot had been so different, could not see the miserable destiny of their brethren without trying to better it. In the middle of the 19th cent. a Bombay Parsi wrote:

'Can we ourselves do nothing for our unfortunate co-religionists in Persia? Our community possesses considerable weight, and includes amongst its members names known all over the world for their exertions in the cause of humanity, and the amelioration of the condition of their countrymen generally. A deputation, therefore, of our race to the Persian court, duly accredited by the English government, and presented by the British Ambassador at Teheran, might, we believe, remonstrate with success against the cruelties now practised upon our Zoroastrian brethren in Persia. The amount raised by the capitation-tax now levied upon them, and which is attended by circumstances of so much cruelty, must be to the Imperial revenue insignificant in the extreme, and it is not improbable that a dignified representation on the subject made by a suitable embassy from the Parsis of India might succeed in abolishing it. Persian princes seldom know the true state of their subjects, and we cannot but think that our countrymen would reflect honour upon themselves by an adequate effort to relieve the miseries of our Zoroastrian brethren in the fatherland' (Dosaahoy Framjee, *op. cit.* p. 49).

The Persian Zoroastrian Amelioration Fund was started in 1854, and the trustees sent an agent, Manakji Limji Antaria, who left India on 31st March and was soon able to communicate a report, which was quite calculated to rouse the general feelings of the Bombay Parsis. A meeting held under the presidency of Manakji N. Petit took place in January 1855, in order to pass resolutions according to this report. In spite of the numerous grievances and disabilities which were made known in that report, the abolition of the *jizya* was deemed the most urgent reform, and efforts were made towards it, although it took twenty-five years to bring it about (1857-1882). During that long period no opportunity was neglected to stir up public opinion in favour of the unfortunate Gabars.

Manakji Limji Antaria took advantage of the friendly disposition of Henry Rawlinson, British Ambassador at Teheran, to have an audience with the Shah and describe to him the miseries of his Zoroastrian subjects. Rawlinson obtained a reduction of 100 *tomans* annually wrung from Yazd and Kirmān.

Another interview with the Shah was granted to a few members of the Bombay community, supported by E. B. Eastwick and Henry Rawlinson, at Buckingham Palace, in June 1873. The Shah was pleased to give a sympathetic attention to the memorial presented by the Parsi deputation, and 'if he finds,' says the reply, 'that your co-religionists are subject to any undue severities, he will take care that redress is afforded them.' But, in spite of the kind dispositions of the prince, no change took place, and even a pressing appeal through the medium of the British Ambassador at Teheran did not reach the royal ear.

It was only in 1882 that Dinsha Petit, the President of the Persian Zoroastrian Amelioration Fund, received through R. Thomson, of the British Embassy, the welcome news that the royal firman abolished the *jizya*-tax and relieved the Zoroastrian communities of its payment, beginning with 21st March 1882. The firman was given at Teheran in the month of August 1882. Thus ended their long campaign of twenty-five years, which had cost the Persian Amelioration Fund more than ₹100,564 (£10,000) (for all particulars on the abolition of the *jizya*, see B. B. Patel, *Parses Prakash* (Gujarati), pp. 657-662).

The devoted agent, Manakji Limji Antaria, died in 1890. His successor was Tir Andaz Khorsend, an Iranian by birth, who died three years later. He worked at Yazd and Kirmān, where he started the *Anjuman nasari*. After him the Committee appointed Ardashir Edalji, who worked till 1896. From that time there has been no paid agent. The affairs of the Iranian community are now managed by small committees appointed by the Bombay Fund, which has a capital of 287,600 rupees, and issues reports.

At Bombay there is a *dharamsāla* ('inn') at Chaupati for the use of destitute Iranians who come to India to find employment and help (1881); and an *agyārī* ('fire-temple') for the exclusive benefit of the Persian Zoroastrians. The head-priest is an Iranian *mobed*, and the ritual is purely Iranian.

5. Religion.—The Zoroastrians having lost for ever their political independence, we have now to describe the conditions under which they were allowed to outlive their national liberty and profess their religion.

At the time of the Arab invasion, Zoroastrianism, divided by sectarian controversies, was exposed to

the risk of perishing. The contact of Christians and Jews had created religious feuds and quarrels, and the primitive Zoroastrian doctrine was altered to such an extent that modern scholars have much difficulty in distinguishing the pure elements of the Mazdæan creed from foreign ones. To those sectarian controversies must also be added the intolerance of the Zoroastrian priesthood towards Persian sects such as the Manichæans and Gnostics—an intolerance which made them hateful.

'Persecution had stirred up feelings of bitter hatred against the established religion and the dynasty that supported its oppressions and caused the Arab conquest to appear in the light of a deliverance' (cf. T. W. Arnold, *The Preaching of Islam*, London, 1896, pp. 177-184).

Zoroastrianism did not disappear at once; the Magians were tolerated and treated like 'the people of the book.' In support of this statement, we may quote al-Balādhuri:

'It seems that the Caliph Umar had some doubts as to how he ought to deal with them, but 'Abdu'r-Rahman b. Awf sprang to his feet and cried: "I bear witness of the Apostle of God that he said: Deal with them as ye deal with the people of the Book"' (ed. de Goeje, Leyden, 1866, p. 267).

We have another example in the treaty concluded with the people of Dabil in Armenia. The safety of the lives of the Christians, Magians, and Jews was guaranteed as well as their property, churches, temples, and city-walls, as long as they consented to pay the land- and the poll-tax. Conversions, it seems, were not compulsory at first, some were quite free, especially in the higher classes, and took place even before the conquest, such as that of Salmān, one of the very first converts and a revered companion of the Prophet, to whom he was most serviceable at the siege of Medina on account of his talents in engineering and military science. He gave up Zoroastrianism, forsaking his father and his luxurious home at Isfāhān. The bent of his mind had led him to study religions, and in his youth he had frequented Christian sanctuaries.

After the defeat of Qādisiyya, four thousand soldiers from the shores of the Caspian Sea embraced Islām, joined the Arabs, whom they helped in the conquest of Jalūlā, and settled afterwards among Muslims in Kūfa. It seems that the great influx of Persian converts made Omar anxious, as he could not reasonably trust them. His forebodings were unfortunately fulfilled; he died the victim of a Persian convert.

The great number of converts is explained by Arnold (*op. cit.* pp. 177-180), who points out the simplicity and elasticity of Islām, the numerous eschatological ideas borrowed from Zoroastrianism, and the relief from the purifications and elaborate ritualism imposed by that religion; and it is quite certain that the bulk of the conversions were voluntary. But all converts were not sincere; the famous Ibn al-Muqaffa appears to have been a bad Muslim, and, speaking of Mihyar, a native of Daylam, al-Karim ibn Buhran remarked that by embracing Islām 'he had merely passed from one corner of hell to another' (Ibn Khallikān, tr. de Slane, London, 1842-71, i. 432 and iii. 51) (8th cent.). Ibn al-Muqaffa was one of the ten most eloquent writers of Arabic, and with this combined a thorough knowledge of Pahlavi. He was put to death about A.D. 760.

E. G. Browne has admirably defined the period of the two or three centuries which followed the Arab conquest; that period is generally supposed to be a blank page in the intellectual life of the people.

'It is, on the contrary,' he says, 'a period of immense and unique interest, of fusion between the old and the new, of transformation of forms and transmigration of ideas, but in no wise of stagnation or death. Politically, it is true, Persia ceased for a while to enjoy a separate national existence, being merged in that great Muhammadan Empire which stretched from Gibraltar to the Jaxartes, but in the intellectual domain

she soon began to assert the supremacy to which the ability and subtlety of her people entitled her' (*Literary History of Persia*, London, 1902 ff., i. 204).

In fact, the Persian converts were to give firmness and strength to Islām (Dozy, *L'Islamisme*, p. 156). The Arab and Persian scholars have at their disposal ample materials for that study, but as regards the status of the Zoroastrian communities the information is meagre and disappointing. The historian has simply to register the rapid decline of the creative faculties in their members, and to be grateful that, in spite of the most terrible persecutions and centuries of ignorance, some fragments of their religious literature have been preserved down to the present time.

At first, as we have already remarked, liberty of worship was not denied to the Zoroastrians. The fire-temples, even when their destruction was ordered by law, were not much injured, and severe punishments were sometimes inflicted by the Muhammadan authorities upon those who attempted to overthrow or damage them. The high-priests were still important personages; the Pahlavi literature continued to be cultivated for several centuries; and, if the most valuable books of the Sasanian period disappeared through the carelessness of the priests and the contempt of the Arabs, some souvenirs of that period have been preserved, and we can glean from the post-Sasanian literature information as to the position of the proscribed religion.

As an example we may cite from the Pahlavi *Dāstān-i Dinik* the opinion of Mānūšcihar, son of Yūdān-Yim, the high-priest of Fārs and Kirmān in the 9th century. According to another Pahlavi work of the same century, the *Dinkart*, the high-priest, 'the *mobed* of *mobeds*,' was a sort of supreme pontiff, whose decisions were listened to by the Faithful (*Dinkart*, ed. Sanjana, Bombay, 1874 ff., Eng. tr. p. 69). We can trust Mānūšcihar to disclose to us the real status of the communities.

'That which you ordered to write about the way of knowing and understanding not being for any one else but for your servant, was owing to your affection, and for the sake of kind regard; but on account of the importance of truth it is more expressly to be regarded as being proper to write also to other spiritual men, as to the learning which is more fully studied by them. For, even with the perplexing struggle of the fiend, and the grievous devastation and collapse which have happened to religious people, after all, through the persistence of the sacred beings even now there are pontiffs, priests, high-priests, judges, and also other religious leaders of those of the religion in various quarters. Moreover, the other priests and spiritual men here enumerated have well considered the commentary (*zand*) of the text (*mānsar*) which is muttered, are acquainted with opinions explaining the religion, and are, in many places, the cause of preferring good works' (*Dāstān-i Dinik*, i. 5-7, tr. West, *SBE* xviii. [1882] 5 f.).

Passing over three centuries, we shall now turn our attention to the northern part of Persia, Azarbaijan, at Rai, the capital of ancient Media, the *Ragha* of the Avesta (*Yasna*, xix. 18; *Vendidad*, i. 15), one of the most flourishing cities of the East, next to Baghdad. It had been the theatre of Muhammadan sectarian struggles: Khanifites, Shāfi'ites, and Shi'ites had killed each other in its streets. In 1220 it was pillaged by Jenghiz Khān's hordes. In spite of all these evils, the small Zoroastrian community had endeavoured to maintain its integrity (13th cent.). The high-priest had still retained the title of *Maubad Maubadān*, and had among his disciples the author of a Persian poem on Zoroaster's life, who is our best informer.

This author was young Zartusht, son of Bahrām, son of Pajū. Bahrām himself was a well-read *mobed* and an astrologer; as for Zartusht, he was conversant with the Pahlavi language, and could read a book wherein were recorded the chief events of the world, and the great deeds of the ancestors and kings, along with the explanation of Avesta and Zend and an account of the birth and events of the life of the prophet Zoroaster (cf. Rosenberg, *Zarātusht Nāma*, St. Petersburg, 1904, p. 2).

That book, however, had grown old, and men were no longer able to read it, and an old *mobed*

advised the young man to put it into verse; lest the traditions—the origin of which nobody could remember, no one being able to understand their writing—might be lost.

'Thou wilt do well to turn them into verse,' says the old man, 'in a pure style and in Persian writing. Thou wilt adorn this holy law with thy skill and restore rites and holy laws.'

We see how much rites and laws had suffered in the 13th cent.; they were doomed to suffer still more through Timūr's invasion.

It was in the end of the 15th cent. that the intercourse with the Parsis of India was renewed. The exodus of the little band of refugees to the shores of Gujarat had not been the only one (8th cent.); others had fled to foreign countries in quest of security and liberty of conscience, but all record of them is lost; no one can trace the place of their settlements or tell the sad tale of their vicissitudes and collapse. Now and then the historian catches a glimpse of the intercourse of Iranians with India.

In the 14th cent., Māhyār, a traveller from the city of Uchh, on the Indus, stayed six years with the herbeds of Sistān; he was taught by them the Zoroastrian faith and returned to India. He brought with him a copy of the *Vendidad* which had been made in Sistān in 1205, by one Ardashir Bahmān. From this copy other copies were made. The oldest now extant are copies made on a Cambay MS of the *Vendidad* brought by Māhyār (14th cent.).

Westergaard says (*Zend-Avesta*, Copenhagen, 1854, Introd. p. 22) that the Parsis never troubled themselves with the books on which their faith was based. Had it not been for the communication with Persia in modern times, Anquetil would probably not have found in India a vestige of a book. It is said elsewhere that, if those books had not been brought to India before the siege of Kirmān, none would have survived in Persia.

It was at the suggestion of Changah Shāh, the *dāvar* ('head-man') of the Parsis of Navsari, that messengers were sent to Persia in order to obtain a satisfactory solution of several questions concerning religion and forms of ceremonies. In the year A.D. 1478 the Parsis of Navsari, Surat, Broach, Cambay, and Ankleswar agreed to send Narimān Hōshang, a layman of Broach, to the learned *dasturs* and *mobeds* of Persia. Some passages of the answers transmitted by the Iranian brethren help us to see the position of the Zoroastrian communities at that time under the rule of the Turkomans. The Iranians pathetically declared:

'From Kayōmars up to this day, no time has been harder and more calamitous than the end of this millennium; and neither the period of Zohāk Tāzi, nor that of Afrāsyāb, nor that of the Sorcerer Tūr, nor that of Alexander the Greek,—of whom the Creator Hormazd says that they are gross sinners—no period has been worse than the end of this millennium, of which Hormazd has made mention, of which 847 years have already passed. Moreover, at this time the faithful have little help to perform meritorious actions in the path of Hormazd; and only a little of Nirang, Barsam, Purification, Purity, and Abstinence has remained; the rest has gone out of use' (Patel, in *Cama Memorial Volume*, Bombay, 1900, p. 171 f.).

In a letter brought by Narimān, they similarly deplore their condition:

'Among us, poor persons, there are four or five individuals who know their way in Pahlavi writing. But which is original is not known, for this reason, that, owing to oppression and tyranny, our fortunes, bodies, and clothes have all been contaminated' (Bombay University MS of Darāb Hormuzdiār's *Rivāyat*, i. fol. 13^b, ii. 6 f.).

One of the messages—the first—concludes with a pressing invitation.

'We wish that two intelligent priests may come hither, and study the Pahlavi writings, and distinguish the proper from the improper.' The traveller is carefully guided. 'As to the route, the land-route is short, and from Kandahār to Sistān the distance is short, and from Sistān to Yezd there is no fear' (Patel, *op. cit.* p. 172).

Narimān Hōshang seems to have enjoyed the journey, as in 1486 he went a second time to Persia in order to elucidate new questions. It is stated in this reply that,

'since many years the Faithful of Persia, who are few in number, are very anxious and desirous, that they may receive some clue to the existence of the Faithful in any other country' (Patel, *loc. cit.*)

In 1511 a third epistle came from Persia. The Zoroastrians of Iran had found their co-religionists' silence very long.

'Until the decline of the Arab dynasty and the succession of the Turks, we did not know whether the Faithful existed in the country of India. . . . Thirty-five years previous to this date, the late Narimān Hōshang came here, bringing with him letters addressed to us by the late Behrāmshāh, and Changah Shāh, and by the assembly of the Faithful and the head-priests. We had sent our reply twenty-nine years ago, written by Nōshirwān Khusrū and Marzbān Aspandiyār. You have not written to us anything during this long interval of years, and we do not know anything of the condition of the Faithful on your side' (Patel, *op. cit.* p. 172 f.).

Inquiries and explanations were made in this way down to the year 1768. The collection of the replies or explanations is named *Rivāyats*, or reports. Twenty-two such *Rivāyats* were formed out of the explanations brought from Persia from 1478 to 1768. These *Rivāyats* form our most precious source of information on the customs of the two communities, and through them old works, fragments of the most precious books of sacred literature, found their way to India, jumbled up with questions of pure ritualism or social life. Now and then Persian travellers happened to come to Gujarat. Two Persians, Kāūs and Asfād, visited Navsari in 1536 and wrote a poem, a copy of which is in the Mulla Firoz Library at Bombay. Later on Ardashir Kirmāni was summoned to the Mughal court by Akbar in order to help the compiler of the *Farhang-i Jahāngīri* (end of the 16th cent.). In 1614 a *dastur* named Azar Kaivān bin Azar Gosp died at Patna at the age of 85. He had disciples, and Muhammadans and Hindus are said to have joined the latter (cf. *Dābistān*, tr. Shea and Troyer, Paris, 1843, i. 87, 88, 89). In the 18th cent. (26th Nov. 1720) a *mōbed*, Jāmāsp Vilayati, came to India. He vainly attempted to enlighten his co-religionists in matters of religion (Patel, *Parsee Prakash*, p. 23; Anquetil du Perron, *Zend Avesta*, Paris, 1771, Prelim. Discourse, p. 327). He brought several religious books, a Pahlavi *Vendīdād* which served Anquetil's teacher, Dastur Dārāb, and is the one from which his famous translation was dictated. Jāmāsp found that there was a difference of one month between the Persian and the Indian Zoroastrians in the *roz mah* ('calendar') reckoning. It is the starting-point of the *kabisah* or 'intercalation' controversy (see art. CALENDAR [Persian]). He was able to teach Avesta to three intelligent priests—Dastur Dārāb Coomana of Surat, Dastur Jāmāsp Asā of Navsari, and a *dastur* of Broach (probably Dastur Fardunji); then he went back to Persia. In 1736 a *bihdin* named Jamshīd, conversant with astronomical calculations, took up the reform of the Indian calendar. During the long discussion of the *kabisah*, which lasted for more than a century, applications were often made to Muhammadan authorities, e.g. Hāji Nasham Isfāhāni and Āghā Muhammad Shūstari. All this shows that the Gabars were not absolutely ignorant.

The Gabars, who were so communicative with their Indian brethren, carefully kept aloof from the non-Zoroastrians. All the travellers have recorded this reserve, which was based upon the principles of self-defence.

'Never,' says Chéron, 'was the Cabbala of the Jews so averse to disclosing its secrets or so jealous of unweaving the mysteries of its science as the Gaures, or ancient Fire-worshippers, are careful to conceal their religion from those who ask for information. I have been obliged, in order to learn from them the little I know of it, to go many times to their place and to dissemble, lest they might suspect the design I had' (*Relations nouvelles du Levant*, Lyons, 1671, p. 429). 'They know by heart a big book written in characters differing from those of Persian or Arabic. They could read it, but they used to say that they did not understand it, and therefore held it in still greater reverence, stating that it sufficed that the words of their prayers to God could be heard by Him alone' (*ib.* p. 437).

It was with a Gabar of Yazd that Chardin was able to converse, and almost to obtain the sacred books. That Magian was one of the most erudite among the Isfāhāni Gabars. He used to read some passages to the stranger every day out of a book

for which he asked '1500 livres.' Chardin was allowed to keep the manuscript for three months, and, as he would not spend so much money on its purchase, the man disappeared (*Voyages en Perse*, iii. 128). Daulier found the Gabars so reserved about their religion that it was difficult to obtain any certain information (*Beautés de la Perse*, p. 52). Sanson was able to ascertain that the tenets of their religion were consigned to parchments, the contents of which their Magians, or priests, read to the community on some occasions, and they considered it a point of religion not to show them to any one. Their mysteries and creed were known only to their Magians, who were not more clever than the bulk of the community (*État présent du royaume de Perse*, p. 257). Chardin was, in fact, the most successful of the travellers, and he lost a unique opportunity of securing the Avesta books.

We have no reason to be surprised at the care taken to conceal the teachings of their religion, or at the obscurity in which their beliefs are involved, in view of the oblivion of their sacred language. It was in a sense the logical consequence of some of their religious injunctions. If we consult the old treatises, we find in them strict regulations to confine the teaching of the sacred language and the tenets of their religion to adepts alone. Some very curious things are said in the *Šad Dar* on this subject.

The characters of the Avesta had to be taught to those of the good religion 'in the presence of priests and teachers, so as to read, and that no error may continue in the *Nyāyīsēs* and *Yāsts*' (ch. xviii.; tr. West, *SBĒ* xxiv. [1885] 359 f.).

The incompetence of the priest in teaching is referred to in the following verses, such incompetence being considered as a sin, according to the words of Ormazd to Zoroaster:

'As to every priest and teacher who commits a blunder in teaching those of the good religion, I make him just as far from heaven as the width of the earth' (*ib.*).

The priests, moreover, were not allowed to teach Pahlavi to every one.

'Zaratušt enquired of Hōrmazd thus: "To whom is it proper to teach Pahlavi?" And Hōrmazd, the good and propitious, gave a reply thus: "To every one who is of thy family, an officiating priest, a high-priest, a spiritual chief, and every one who is an intelligent priest. Besides these that I have mentioned, if one teaches it to others it is a great sin for him; and if he has performed many duties and good works, the end for him may still be hell"' (*ib.* xcix. 2-4).

We can easily understand that the more the Zoroastrians were persecuted, the more they kept aloof from the non-Zoroastrians. In fact, any intercourse with the latter was forbidden to the true believer. About that we find in the *Rivāyats* injunctions which were as useful to the brethren of Persia as to those of India, who had just experienced the effects of the conquest of Gujarat by the Muhammadans; the main point was to keep the faith of the forefathers. A *Rivāyat* of Shāpūr Bhārūcha tells that, if a Zoroastrian was forced to become a Muhammadan with his family, it was better for him to poison himself and his family than to give up his religion. But if, after the Zoroastrian had changed his religion, he wished to be re-admitted among his co-religionists, he should be received after making him pray a *patēt* and giving *barašnūm* (*Narimān Hōshang Rivāyat*, 15th cent.). Yet conversion to Zoroastrianism was allowed. A non-Zoroastrian could be admitted to the Zoroastrian religion if willing to observe carefully its laws, and provided that no harm was thereby done to the community (*Kāūs Māhyār Rivāyat*, 16th cent.). The last sentence is suggestive, and shows a great deal of discrimination in the leaders. Above all, the Zoroastrian was enjoined to guard himself against contact with a non-Zoroastrian. A Zoroastrian should purify himself with cow's urine (*nīrang*) after touching a non-Zoroastrian (*Kāūdīn Shāpūr Rivāyat*, 16th cent.). Some other regulations, such as the following, have even a polemic character: a Zoroastrian should not partake of any food prepared by a non-Zoroastrian, even when travelling (*Kāūs Māhyār Rivāyat*), neither of *ghī* (clarified butter), nor of honey prepared by non-Zoroastrians (*ib.*); fruit touched by the latter has to be washed before it is eaten (*Narimān Hōshang*

Rivāyat); even so, a Zoroastrian should not use an earthen or copper utensil made by a non-Zoroastrian except after having washed it three times; and a *dastur* must not cook food in an earthen vessel made by a non-Zoroastrian (*Kāūs Māhyār Rivāyat*). It was necessary, therefore, for the Faithful to protect themselves against the impure, mischievous non-Zoroastrians, or *Darvands*. At the end of the 15th cent. and on the eve of the 16th, we find in the *Rivāyat* of Narīmān Hōshang the following privilege allowed to the Indian brethren—a privilege used, no doubt, by the Iranians during their daily life of struggle and misery.

'If a non-Zoroastrian is committing great sins and causing harm to Zoroastrians and does not listen to reason, and if a Zoroastrian kills him, he shall not be considered guilty of murder' (for all these references, see the Bombay University MS of Dārāb Hormuzdiār's *Rivāyat*).

The correspondence with the brethren of India, so active during the rule of the Šefavid kings, slackened during the Afghan invasions. The last messenger in the 18th cent., Kāūs Rustam Jalāl of Broach, took with him his son, the famous Mullā Firūz, who has left an account of his journey (*Derich kerde manjumi*). The siege of Kirmān put a stop to that literary and to all religious intercourse.

6. Social and religious customs.—The Zoroastrians are divided in Persia, as in India, into two classes—laymen (*bihdīns*) and priests (*athornans*). We have seen their unhappy fate, and the ruin of their national life. Their social life was a failure. In many cases they were obliged to conceal their religious faith and to feign to adopt Islām. Even in the *Rivāyats* we find permission to practise dissimulation. 'If a man is obliged to become a Muhammadan by force and if he has no faith in the Muhammadan religion, he cannot be called a Muhammadan'; and we have seen that the re-admission of the renegade into the community was easily granted. Some of the *bihdīns* sent their children abroad in order to have them brought up in their own faith.

i. LAYMEN (*bihdīns*).—The *modus vivendi* of the Iranian Zoroastrians has in general improved since the middle of the 19th cent.; yet at Yazd and Kirmān they continue to live in separate quarters, and are still kept at a distance by the Muhammadans. Their position, in the main, is respectable; they are no longer agriculturists only, but merchants; and their trade with India has been the source of fortune to some of them, and has even added (at least at Yazd) to the commercial reputation of the city, although they still labour under certain restrictions—being forbidden, for example, to sell food in the bazaars.

They occupy (at Yazd), says Lord Curzon, a position not unlike the Chinese *compradores* and agents in the Treaty ports of Japan, the bulk of the foreign trade passing through their hands (*Persia*, ii. 241). Some of them are naturalized British subjects. E. G. Browne has given many interesting details of their life, which he was able to learn during the time he resided amongst them at Yazd and Kirmān (cf. *A Year amongst the Persians*, chs. 13, 14, 15, 16). Other travellers have added valuable information since 1887 (cf. Jackson, *Persia, Past and Present*, pp. 353-400, and Malcolm, *Five Years in a Persian Town, passim*).

At Yazd the head of the community is [1912] Ardashir Mihrabān, a wealthy merchant. He is the President of the *Nasr-i-Anjuman* of Yazd, and an influential representative of the Irāni Zoroastrians. Ardashir Mihrabān was obliged to become a naturalized British subject to obtain certain liberties; in 1907, Arbāb Jamshid, a merchant at Teheran, was elected deputy of the National Persian Assembly. It is known that the elections have been made by colleges: (1) of the provinces, (2) of the communities. The political inequalities of the Gabars have totally disappeared, and the Zoroastrians are gradually regaining all their civil rights and their equality before the law and further liberty of cult.

(a) Ceremonies.—The chief ceremonial occasions in a Gabar family are the same as in a Parsi family (see art. PARSIS). For a description of them we must refer to the accounts of the first European travellers, although we cannot place much reliance on them, the Occidentals being always more or less

inclined to tax the Gabars with an exaggerated degree of ignorance or superstition. As regards their religious practices, intimately connected as they are with their social customs, we may refer to their *Rivāyats*, or correspondence with their brethren in India; for, though these *Rivāyats* contain no graphic account, they are still the best and surest source of information in matters of their own faith.

The ceremonies which mark the life of a Gabar are:—(1) The investiture of the *sudra* and *kustī*, called the *naujot* in India, and *sudra kustī dādan* in Persia (cf. Jackson, *op. cit.* p. 380 f., where it is stated that the wearing of the *sudra*, and even the formal investiture of the *kustī*, are not common at Yazd).—(2) The *marriage ceremony*, stripped of the Hindu finery and pageant imposed on the Persian refugees by the Rana of Sanjan, and reduced to prayers and admonitions (Jackson, pp. 384-386). Any marriage with non-Zoroastrians is still strictly prohibited, as Chardin has pointed out. The Gabars, he says, could not marry wives of another faith; they asserted that the wife was to be by education and birth of the same religion and race as the husband (*Voyages en Perse*, iii. 128).—(3) *Funerals*.—The funeral rites are conducted in Iran, as in India, according to the pure Avesta form (Jackson, 387-398). Most of the questions sent to Iran by the messengers of the Parsi *anjumans* of Gujarat referred to funeral rites, prayers, purifications, and disposal of the dead on the platforms of the *dakhmas*. These *dakhmas* have been described by many travellers, who have even seen the inside and have given us particulars as to their structure. In Persia, the Zoroastrians could not ensure the inviolability of their *dakhmas* and keep at a respectful distance the curious wayfarers or mischievous Muhammadans, as their co-religionists endeavoured to do in India, and at last succeeded in doing under British rule.

The *dakhmas* in Persia are not numerous: at Yazd, there are 6-4 old ones and 2 in use. At Kirmān we have to note a cluster of 9 towers: 3 are in use; 6 are old and out of repair. At Teheran there is a *dakhma* built at the expense of the Bombay Fund (A. Y. 1231=A. D. 1861). There is likewise a very ancient *dakhma* near Rai, about 30 feet high, but with neither door, *ohandār* (or central pit to receive the bones), nor *sagri*. The *pāvis* are arranged in rectangles instead of wheel-fashion (from the census of the Persian Amelioration Fund; cf. Browne, *A Year amongst the Persians*, 88 f., and Jackson, 439 f.).

(b) Dress.—The dress of the modern Zoroastrians in Persia is carefully described by Houtum-Schindler (*op. cit.* 68 f.). The people still retain the custom of wearing dark colours pointed out by ancient travellers. The men wear the turban, or *dastar*, rolled up around a small cap; the *kolā*, or black wool cap of the Persians, is adopted only at Teheran, Kāshān, Shīrāz, and Bushire; they put on the *penāra* (mod. Pers. *pirāhan*), 'shirt,' over their *sudra* ('sacred shirt'), and tie the *kustī* ('sacred thread') on their naked body; the trousers are called *tonbūn*. There are three other garments: the *dotāi*, a mere jacket, short and wadded; the *alkalyk*, another sort of jacket worn under a third called *kēma*. A *shal* (mod. Pers. *sal*) is passed over the *kēma*. The stockings and shoes have Persian names.

The women retain the ancient custom of winding pieces of cloth around their head, 'fagotées à la négligence,' as Daulier says (p. 51), and of using the same 'nippes colorées' mentioned by Raphael du Mans (*État de la Perse en 1660*, p. 43). They wear five different head-cloths: the thin *jul-shiv-sar* is bound round the head like a cap and kept in place by the *lacheh* (which is a ribbon rather than a cloth) tied under the chin. The *dastmāl-sar* falls on the shoulders, and is fastened under the chin; in fact, the head of a woman is visible only from the eye-brows to the chin; the brow is covered by the *maknō*. The women wear the *kustī* over the

shoulders on the under shirt, which is not the *sudra*, but is called *shiv-kustī*; over the *shiv-kustī* is worn the short shirt or *penāra*. The women do not wear petticoats, but trousers called *shelvar*, made of coloured cloth, either wadded or light, according to the season; they are broad and loose, but are drawn in tightly about the ankles. The tight-fitting jacket with narrow sleeves is called *mināsūkh*. The other jackets have Persian names.

The women of rank, when they go out, throw over themselves a veil of striped stuff, blue and white, called *chādar*, which is worn only by the poorest Muhammadans. The other women, viz. the townswomen, go out unveiled; a Muhammadan never looks at them, as he considers them impure.

(c) *Education*.—After having so often alluded to the ignorance of the Gabars, let us consider their intellectual status during the great campaign made by Manakji Limji Antaria in favour of the amelioration of the lot of his co-religionists. Houtum-Schindler gives reliable information (p. 82). At that time very few Irāni Zoroastrians could read the Avesta characters; in the province of Kirmān there was only one man, the *dastur*, who could read Zend; at Yazd there were several. All except the agriculturists could read and write modern Persian; many had some knowledge of Arabic. Among the women it would have been hard to find one who could either read or write. Some laymen were conversant with astrology, and knew as much of astronomy as was required for astrological calculations. They could, with the help of the astrolabe, find the latitude of a place within a degree. They had limited notions of geography; all their knowledge of history was derived from Firdausi. A few could study the *Avesta*, *Dasātīr*, *Dābistān*, *Dīnkarī*, and such other works, but quite superficially. All the class-books and the Qu'rān came from India. A Kirmāni or Yazdi Zoroastrian was not permitted to attempt to read the Qu'rān in the presence of a Muhammadan, and no copy would be sold to him. The improvement, even since the beginning of the 20th cent., is notable. Now there are 9 schools in Yazd, Kirmān, and Teheran. At Yazd there are 6 schools: a large *madrassa* built at the expense of Ardashir Mirhabān's father (149 pupils); another where Avesta and English are taught (53 pupils); Khurramshah (84 pupils); Taft (24 pupils); Sarfābād (32 pupils); Mubarka (no pupils). These six schools are branches of the Yazdi *madrassa*. At Kirmān are two schools, one near the Ātash-Bahrām (32 pupils); and one at Zufar (19 pupils). At Teheran there is one school built by N. M. Petit (13 pupils).

ii. *PRIESTS (athornans)*.—The modern Iranian priesthood is the humble representative of the great clergy of the Sasanian period, but one would hardly recognize in the persecuted *mobeds* of Yazd and Kirmān the *dasturs* and advisers of the mighty kings of Persia. Immediately after the Arab conquest, the priests were not ill-treated by the Muhammadans; we have seen that in the 9th cent. there were still *mobeds* and *ervads* who had learnt the *mantras* and studied the commentaries. They were men of position, and were allowed to take a share in the religious discussions held in the presence of the Khalifs themselves. This is proved by the *Ulamā-i-Islām* (ed. Mohl, *Fragmens relatifs à la religion de Zoroastre*, Paris, 1829, pp. 1-10; tr. Vullers, *Fragmente über die Religion des Zoroaster*, Bonn, 1831, pp. 43-67), in which is preserved a controversy between Mazdæan priests and Muhammadan doctors in the presence of Ali; and again by the *Māṭiqān-i-gujastak Abālish* (ed. and tr. Barthélemy, Paris, 1887), which relates another controversy between a Zendik called Abālish and the Zoroastrian high-priest Ātūr Farnbag before the great Khalif al-Mā'mūn, whose taste for disputes

on the merits of different religions is attested by al-Mas'ūdī (*Prairies d'Or*, ed. Barbier de Meynard, Paris, 1861-77, i. 30).

The presence of the Zoroastrian priests was thus tolerated at the court of the Khalifs, and their evidence was even accepted in lawsuits—that of a *mobed* in the case of Afshīn the heresiarch (9th cent.) (cf. Browne, *Lit. Hist. of Persia*, i. 331 f.); but this toleration gradually disappeared, and the Zoroastrian priests were taught to expect obedience and respect from true believers only. The priesthood continued to form a class separated from the rest of the community and to recruit new members from itself.

Nevertheless, an example of the possibility of admitting a layman into the priestly class is found in the 17th century. One *dastur*, Rustam Gushtāsp Ardashir, is said to have sprung from the laity and not from a priestly family (*SBE* v. [1880] Introd. p. xxxiii). In the time of this *dastur*, the Muhammadan king of Persia had ordered a general massacre of Zoroastrians, unless they proved that they were not idol-worshippers. Rustam Gushtāsp, though a layman, proved this to the satisfaction of the king, and he was made a *dastur*. It is quite in keeping with the old tradition of the division of men into four classes, restored by king Ardashir, with the exception of those who, by special merits for examinations, were qualified for a profession different from that of their forefathers. Such was the case of this Rustam Gushtāsp Ardashir.

In the 17th cent., the head-quarters of the priestly class was still Yazd. According to Chardin (*op. cit.* p. 131), the great pontiff had settled there, and was called *Dastur Dasturān*; he was an example to the other priests who lived with him, and to the students who formed a seminary under his auspices. The Muhammadans allowed this liberty, since the officers derived handsome presents from such toleration.

The ignorance of the priests is emphasized by the travellers, but in many cases that reputation is due to the ignorance of the travellers themselves. Yet, as with the laity, so with the priestly class, a general darkening of the intellect was but too real, especially after the siege of Kirmān (1794). Westergaard, at Yazd and Kirmān, noted that Pahlavi had been almost forgotten; Houtum-Schindler, as already stated, found in Yazd some priests who could read the Avesta characters, but at Kirmān only one—the *dastur*.

There is now at Yazd a *madrassa* where Persian and Avesta are taught, whilst in the village schools Khorda-Avesta and Persian only are taught. A certain number of young men come to study at Bombay. As a learned and distinguished priest, we must mention Dastur Tīr Andaz Ardashir, who has translated the *Khorda Avesta* into Persian.

The initiatory ceremonies for priesthood are the same as in India—*navar* and *martab*, with some slight differences in the ritual (cf. art. PARSIS).

At Yazd the *mobeds* live in a separate quarter; the *bihdīns* are spread over different villages and localities. Their duties consist in keeping up the sacred fire, the performance of the offices and religious ceremonies, and the like. For the distribution of the work and fees, they proceed as follows. Once a year, all the *mobeds* hold a meeting at the house of the high-priest and assign all the *bihdīns* of the different places to as many divisions as there are *mobeds*. They write down the names of the different villages on small slips of paper, which are folded and distributed by a young *mobed* to the *mobeds* as in a lottery. The religious ceremonies of the locality inscribed on the paper are performed by these *mobeds* and by no one else. Many of the *mobeds* appoint others to their place or ask others to help them; but they must always give their permission for any substitution.

A *mobed* who has just been made a *navar* cannot be employed until three years have elapsed after the ceremonies have been performed. The distribution of work is made yearly, and according to the increase or decrease of the number of the *mobeds*.

Temples.—Fire, the symbol of the Mazdæan faith, after having burnt in the Zoroastrian temples of the Sasanian period with all pomp and majesty, is now hidden, in Persia as well as in India, in dwellings whose outside does not differ from that of other houses. It is the worship of, or rather reverence for, fire professed by the Parsis and Gabars that has earned them the appellation of *ātash-pārastān*, or 'fire-worshippers,' given to them by travellers. Before the abolition of the *jizya*, their sanctuaries were desecrated daily. The history of the post-Sasanian temples has still to be written; the remains of the old temples are very few, and the poor modern *ādarāns* have nothing to remind us of the splendour of the former.

It is said that after the battle of Nihāwand, King Yazdagird fled from Rai and took with him the sacred fire that was revered in that place, one of the oldest *pyræ* of Persia. He went to Isfāhān, then to Kirmān, Nishāpūr, and Merv, where he erected, in a place two parasangs from the town, a *pyra*, where he enthroned the sacred fire that he had brought with him. The *pyra* was surrounded by gardens (Tabarī, tr. Zotenberg, ch. lxxviii.).

At first the Muhammadans seem to have given a real protection to the fire-temples and to have prevented their destruction. Thus in the 9th cent., under the reign of al-Mu'tasim (833-842), priests and doctors were flogged because they had destroyed the temple of Sugdh and built a mosque in its place (Arnold, *Preaching of Islam*, p. 179).

At the time of Mas'ūdī (9th cent.) *pyræ* were to be found in Iraq, Fārs, Kirmān, Sistān, Khorasan, Tabaristān, Azarbaijan, etc. (Mas'ūdī, ed. Barbier de Meynard, iv. 86); but on account of the invasions and wars the number of the Zoroastrians decreased, and the sanctuaries fell into decay. Travellers have all recorded how carefully the Gabars concealed their fire from the eye of non-Zoroastrians. The exceptions are few. Chinon went to the temple, but could not see the fire (p. 448), although Careri saw it (*Giro del mundo*, 1699, p. 134). In modern times, E. G. Browne and Jackson were introduced into the sanctuaries of Yazd and Kirmān (*A Year amongst the Persians*, pp. 373 f., 441 f., and *Persia, Past and Present*, pp. 366 f.). One of the first duties of the Persian Amelioration Fund was to repair the fire-temples.

7. Language.—All the travellers noted that the Gabars had a language of their own; they had retained the Avesta characters and their scriptures, but the Pahlavi language and literature had gradually disappeared and were replaced by a sort of jargon, unintelligible to strangers and different from the New Persian. The modern dialect of the Persian Zoroastrians is the *Gabrī*, spoken at Yazd, Kirmān, Rafsinjan, etc. It seems that Hyde knew of the existence of the *Gabrī* (*Veterum Persarum . . . religionis historia*, Oxford, 1700, pp. 364-429; cf. Anquetil du Perron, *Zend-Avesta*, ii. 429). There has been no literary activity amongst the Persian Zoroastrians of Yazd and Kirmān in recent times; and, though among themselves they continue to speak the peculiar *Gabrī* dialect, their speech in mixed society scarcely differs from that of their Muhammadan fellow-citizens, and their letters are entirely copied from the ordinary models. E. G. Browne studied it at Yazd. He says that the *Dārī* (as he calls it) is used by the Gabars only among themselves. When they speak their own dialect, even a Yazdī Muhammadan cannot understand what they are saying, or can understand it only very imperfectly; it is not written.

Cf. Houtum-Schindler, pp. 57-82, etc.; E. G. Browne, *A Year amongst the Persians*, pp. 187, 189, 388, 389; Huart, 'Le prétendu Déri des Parsis de Yazd,' *JA* xi. [1888] 298-302; E. G. Browne, *A Literary History of Persia*, i. 43, 86, 109; Geiger, in *GlrP* i. ii. [1896] 331 f., 404 f., 422; E. G. Browne, 'A Specimen of the *Gabrī* Dialect of Persia,' *JRAS*, 1897, pp. 103-110.

It is also interesting, in this connexion, to note that the Iranian pronunciation of Avesta differs

considerably from that current in India. The spirants are either despirantized or changed to aspirates (δ becoming either d or d' , etc.; t becomes d , and hh becomes nk). Besides becoming t or t' , θ is frequently interchanged in pronunciation with s ; and the vowels a , o , u are often confused, while there is a tendency to monophthongize diphthongs. On the other hand, anaptyxis and epenthesis are strictly observed. Knowledge of the metrical structure of large portions of the Avesta is lost, and all is read as prose (Jackson, *op. cit.* pp. 363-366).

LITERATURE.—i. HISTORY, ETC.—Foucher, 'Sur le Manichéisme et les Guèbres,' in *MAIBL* xxxi. (1884); B. B. Patel, *Parses Prakash* (Gujarati), Bombay, 1888, *passim*; Dosabhoj Framjee, *The Parsees; their History, Manners, Customs, and Religion*, London, 1858, pp. 29-51; D. F. Karaka, *History of the Parsis*, do. 1884, i. 53-90; D. Menant, 'Les Parsis, histoire des communautés zoroastriennes de l'Inde,' *AMG*, Paris, 1898, ch. ii. pp. 25-48, and 'Les Zoroastriens de Perse,' in *Rev. du monde musulman*, Oct.-Nov. 1907.

ii. ETHNOGRAPHY.—N. de Khanikoff, *Mémoire sur l'Ethnogr. de la Perse*, Paris, 1866, *passim*; E. Duhousset, *Les Populations de la Perse et pays limitrophes pendant trois années de séjour en Asie*, do. 1863, *passim*; A. Houtum-Schindler, 'Die Parsen in Persien,' in *ZDMG* xxxvi. [1882] 182; Houssay, *ap. M. A. Dieulafoy, Acropole de Suse*, Paris, 1890-92, Appendix, 'La Race humaine de la Perse,' p. 87 ff.

iii. CUSTOMS AND MANNERS.—Pietro della Valle, *Les fameux Voyages de Pietro della Valle, gentilhomme romain, surnommé l'illustre voyageur*, French tr., Paris, 1661, ii. 104-8; Silva y Figueroa, *L'Ambassade de Don Garcias de Silva y Figueroa en Perse*, tr. Wicquefort, do. 1667, pp. 176-179; Gabriel de Chinon, *Relations nouvelles du Levant ou traités de la religion, du gouvernement et des coutumes des Perses, des Arméniens, et des Goures*, Lyons, 1671, bk. iii. pp. 429-481; J. B. Tavernier, *Six Voyages en Turquie, en Perse, et aux Indes*, Paris, 1676, i. 430-448 (Eng. tr., London, 1684); Raphael du Mans, *Etat de la Perse en 1660*, ed. C. Schefer, Paris, 1891, pp. 42-45; J. de Thévenot, *Relation d'un voyage fait au Levant . . . avec la suite*, do. 1674, ii. 216 f.; J. Chardin *Voyages en Perse et autres lieux de l'Orient*, Amsterdam, 1735, i. 181, iii. 55, 126-133; A. de Daulier Deslandes, *Les Beautés de la Perse*, Paris, 1673, pp. 51-53; S. N. Sanson, *Etat présent du royaume de Perse*, do. 1694, pp. 256-264; A. Olearius, *Persianische Reisebeschreibung*, Hamburg, 1696, *passim*; E. Kaempfer, *Amoenitatum exoticarum . . . fasciculi v.*, Lemgo, 1712, p. 164; Gemelli Careri, *Giro del mundo, parte seconda*, 'Nella Persia,' Naples, 1699, pp. 133, 134 f.; J. A. Ducerceau, *Hist. de la dernière révolution de Perse*, Paris, 1728, i. 291, 294 f., ii. 131, 193, 291, 295; Corneille Le Brun, *Voyages par la Moscovie, en Perse, et aux Indes Orientales*, Amsterdam, 1718, ii. 387-389, etc.; J. Hanway, *The Revolutions of Persia*, London, 1754, pp. 149-152, 160, etc.

iv. TRAVELLERS IN THE 19TH CENTURY.—A. Dupré, *Voyage en Perse fait dans les années 1807-1808-1809*, Paris, 1819, ii. 100-110; R. Ker Porter, *Travels in Georgia, Persia, etc.*, London, 1821, i. 48-53, ii. 46, 54, 56; N. L. Westergaard, 'Letter to the Rev. Dr. Wilson written in 1843,' in *JRAS* viii. (1846) 350; H. Petermann, *Reisen im Orient*, Leipzig, 1865, ii. 203-206; N. de Khanikoff, *Mémoire sur la partie méridionale de l'Asie Centrale*, Paris, 1861, *passim*, and *Ethnogr. de la Perse*, do. 1866, *passim*; E. Duhousset, *op. cit. supra*; A. de Gobineau, *Trois ans en Asie*, Paris, 1859, pp. 371-380; E. G. Browne, *A Year amongst the Persians, 1887-1888*, London, 1893, pp. 363-486; G. N. Curzon, *Persia*, do. 1892, i. 155, 333, 352, ii. 47, 49, 239-241, 244, 493; A. V. Williams Jackson, *Persia, Past and Present*, New York, 1906, pp. 273-275, 336-338, 353-400, 413, 425-427; P. M. Sykes, *The Parsis of Persia, a Lecture delivered at the Soc. of Arts*, London, 24th May 1906; N. Malcolm, *Five Years in a Persian Town*, London, 1905, pp. 44-49, 51, 52, 63, 113, etc.

D. MENANT.

GAELS.—See CELTS.

GALLICANISM.—Under this name two doctrines are designated, which were once current in France, but which are quite distinct. The one was directed against the claims of the clergy, the other against the Papacy. The first, which was odious to the clergy, was supported by kings and parliaments, and may be called 'royal or parliamentary Gallicanism.' The second had the sympathy of the episcopate and of the French clergy, and is known as 'episcopal Gallicanism.' Each of these two doctrines, which have often been confused, has its own history, and they ought therefore to be separately treated.

I. ROYAL OR PARLIAMENTARY GALLICANISM.—Royal or parliamentary Gallicanism comprises three maxims. (1) The first proclaims the right that civil society possesses to defend itself against

the invasions of the clergy. It may be formulated thus: the clergy ought to be confined to the spiritual domain. (2) The second affirms the superiority of civil over religious power. Its formula is: the king is the head of the Gallican Church. (3) The third teaches that, to defend civil society against the encroachments of the clergy and to impose his authority on the latter, the king (represented by Parliament or the King's Council) should act in a practical manner, viz. by appeal by writ of error, which entails various penalties, notably the seizure of temporalities.

I. Defence of civil society against the encroachments of the clergy.—This is the very soul of the disputes which broke out from time to time between laymen and ecclesiastics. Profiting by the disorder caused by the invasion of the barbarians, the Church, in the 6th cent., had placed herself at the head of the social services. She had left her spiritual domain and invaded the domain of things temporal. But the day came when society became conscious of its growing strength. Then it thanked the Church for her past services and announced that it would henceforth look after its own administration. The Church, however, did not see things in the same light. She claimed a Divine sanction for rights which she owed to circumstances, and which she was unwilling to abandon. Hence arose the disputes which broke out as early as the reign of Charles the Bald, but more especially in the 13th century. In 1205, under Philip Augustus, then in 1225, under Louis VIII., the French barons formed a coalition to drive back the clergy into their spiritual domain and rescue laymen from their tribunals. At this latter date the Duke of Brittany, Pierre Mauclerc, assembled his vassals at Redon, urged them to work towards this end, and made them promise to brave the censures of the clergy. At the Assembly of Saint-Denis (1235) the most powerful lords of France discussed the matter again, and wrote to Pope Gregory IX. asking him to put an end to the continual encroachments of the bishops. Finally, in 1246, another League was formed—this time at the instigation of the Emperor Frederick II.—which proposed to limit the jurisdiction of the Church over laymen to cases of heresy, marriage, and usury. All these attempts failed. In 1235, Gregory IX. informed the lords that they were making an attempt against the 'liberty of the Church,' and threatened them with all sorts of penalties. Innocent IV. went still further: he excommunicated the members of the League of 1246. The bishops, supported by Rome, continued to bring before their tribunals a great number of civil affairs. The laymen, who thought themselves capable of administering their own affairs, continued to revolt against the humiliating guardianship to which they were subjected. During the whole of the 13th cent. matters underwent no change.

But, although the conflict went on as far as laymen and the Church were concerned, the interests of the former were no longer, towards the year 1300, entrusted to the same hands as formerly. At the time of Philip Augustus and Saint Louis, the opposition against the usurpations of ecclesiastical jurisdiction began with the barons. At the approach of the 14th cent. the attack came from the king, Philip the Fair, an imperious man and a great organizer, who proposed to entrust the execution of justice to lay officers nominated by himself, and to relegate the Church to the spiritual domain. The success of this project, however, was hampered by the king's quarrels with Boniface VIII., which compelled him to conciliate the clergy in order to secure their support. In fact, he had to concede to the Church unlimited jurisdiction in

civil affairs. At the same time he instituted a body of royal legists and notaries who should represent the lay spirit and form a kind of fortress of anti-clericalism. In the 14th cent. a power arose over against the Church—that of the legists—which had always an open eye for the ambitious schemes of the clergy and was ever ready to thwart or curb them. To the attacks to which she had to submit the Church replied with excommunication; but the legists seized the temporal belongings of the author of the ban and did not let their prey escape until the censures were cancelled. These ever-renewed disputes gave rise to a chorus of mutual recrimination. The Church complained that her 'liberty' had been violated; the legists, on their side, complained that the clergy interfered in the regulation of sale contracts, estates, etc.—in a word, that they interfered with many things that were altogether outside the spiritual sphere.

King Philip of Valois imagined that this discontent was occasioned by misunderstandings, and that, if light were thrown on the question of the jurisdictions, harmony between the laymen and the clergy would be re-established. In order to obtain the necessary light, he called an assembly of the prelates and barons of his kingdom, and each of the two parties was invited to state its side of the question with absolute freedom. The Assembly (well known as the *Assembly of Vincennes*) met in December 1329.

Pierre de Cugnères, Knight and King's Councillor, took up the defence of the interests of the laymen. He contended, enforcing his arguments by frequent reference to Scripture texts, that God had established two jurisdictions, the one temporal, the other spiritual; and that these could not be in the same hands; from which he concluded that the Church, which had received spiritual jurisdiction, could not exercise temporal jurisdiction. Then, descending from the region of principles to the realm of facts, he enumerated the abuses committed by the clergy who encroached without scruple on the domain of temporal jurisdiction.

The argument was replied to by Pierre Roger, Archbishop of Sens, and Pierre Bertrand, Bishop of Autun. These two advocates of the clergy argued that the two jurisdictions, the spiritual and the temporal, could be united without any inconvenience in the same person, and that, as a matter of fact, the Church had received the power of judging temporal as well as spiritual affairs. They admitted that abuses might have slipped in here and there, and promised to do what was necessary to correct them.

The most obvious result of this great debate was to show that the legists were separated from the clergy, not by misunderstandings, but by views irreconcilably opposed, and that any concessions by either must be imposed by the authority of the king. But Philip refused to take part in the strife. He made fair promises both to the clergy and to the legists, and left the quarrel where he had found it. It is not till the reign of Charles V. that we find the intervention of royal authority—and that on the side of the laymen. At this time the usurpations of the clergy were more irritating than ever to the laymen, whose discontent found vent in a curious book entitled *Le Songe du Verger*. Charles, who had inspired the book, justified its claims by the Ordinance of 8th March 1372, in terms of which the bishops were in future to have nothing to do with 'real' actions, i.e. with the sale of landed property, heritages, etc., and the royal officers were to prevent, by seizure of temporalities where necessary, all action of the ecclesiastical tribunal in such matters.

The Ordinance of 1372 was the first measure taken by the king of France to stem the flood of ecclesiastical power. It was confirmed, in the reign of Charles VI., by the Bill of 1385. Then came the Ordinance of Villers-Cotterets of 1539, and the Edict of 1695, which restrained ecclesiastical power in other directions. Jurisprudence, on its side, devoted itself to a similar task and obtained important results. In the 17th cent. the State had recovered possession of most of its essen-

tial privileges which had formerly been usurped by the Church. Nevertheless, the clergy still possessed the registers connected with civil affairs, and retained the monopoly of education. It was the Revolution which deprived them of these privileges. On 19th June 1792 the Legislative Assembly decided that births, marriages, and deaths should be registered in the Meeting Hall of the municipality. Several years later, the Convention, and afterwards the Empire, gave the management of education to laymen. The clergy were, by these measures, expelled from two positions which they had held for many centuries. In the course of the 19th cent., however, they had the consolation of partially repairing the losses which the Revolution had inflicted upon them in the domain of intellectual affairs. In 1833 they were authorized to provide, in line with the University, elementary education. To this first authorization a second was added in 1850—that of providing secondary education. Finally, in 1875 they obtained the liberty of providing higher education. The Church, then, even at the present day, may give instruction, but only under State control: education has been secularized.

2. The authority of the king over the Gallican Church.—The king of France considered himself head of the Gallican Church, the guardian of its teaching and discipline. We may add that he supervised it in order to prevent the great force at its disposal from being turned against the monarchy. His authority was exercised by several means: the nomination of bishops, the convocation of councils, the *regale*, the taxes, the control of doctrine and worship.

(a) *The nomination of bishops.*—Clovis, Charles Martel, Charlemagne, and some others encountered no obstacle in the exercise of this right. But complaints and grievances made themselves heard not infrequently. These varied according to circumstances. Sometimes they were confined to protesting against the choice of incompetent bishops, and the shameful traffic which went on in this connexion. Such was the attitude of Pope Gregory (in his letters to Brunehaut and to the Frankish princes), of Boniface (742–744), and of the Council of Paris of 829. At other times a return was demanded to the electoral régime which had held sway before the coming of the Franks (Council of Paris of 614, Abbé Wala in the Council of Aix-la-Chapelle of 828, the *False Decretals*, Hincmar, Gregory VII.). Or, again, a compromise was resorted to, and the king was authorized to confirm the choice of the electors (Council of Orleans of 549). It was this compromise which, theoretically, finally prevailed (the first time under Clothaire II. [615], then in the middle of the 9th cent.)—theoretically only, for in practice the elections were corrupted by official candidature. The king thrust his candidate upon the electors; the electoral régime was only a mask to disguise the royal nomination. Moreover, the bishops, before obtaining episcopal consecration, had to receive investiture from the king and take an oath of allegiance to him. This oath of allegiance, however, soon dwindled to a simple promise of fidelity, which, instead of preceding the episcopal consecration, followed it, and so lost much of its value. Nevertheless, during the whole of the 13th cent. the king was still, so to speak, recruiting officer of the episcopate. With Boniface VIII. the Papacy proposed to reserve to itself the nomination of the French bishops, and little by little it made considerable progress in this direction. The Great Schism modified the situation. It was then, in fact, that the French clergy tried to re-establish election, and it succeeded, thanks to the *Pragmatic Sanction* of Bourges, 1438. But its success was

fleeting, for the king gradually recovered lost ground and, in spite of the *Pragmatic Sanction*, nominated his bishops as often as he could. Finally, he completed and consolidated his victory by the Concordat of 1516. From this time onwards the king directed the appointment of the French episcopate under the control of the Pope, who confined himself to giving them canonical orders. This was not a complete return to the tradition of the early Middle Ages, seeing that at that period the nomination of the bishops was completed without any intervention from the Pope; but it was all that the recent increase of Papal power would permit. So in the Concordat of 1801, Bonaparte, who reserved for the civil power the right of nominating the bishops, accepted the conditions prescribed by the preceding Concordat, and granted the Pope the right of confirmation.

(b) *The convocation of councils.*—During the whole of the Merovingian period the councils did not assemble except by order, or, at least, with the authorization, of the king. From this fact arose the formulæ which we meet so frequently: for instance, 'A council of bishops assembled in the town of Orleans by order of His Most Glorious Majesty, King Clovis' (Council of Orleans of 511); 'By order of Their Most Glorious Majesties, we assembled in the town of Orleans to deliberate to the glory of God upon the observation of the Catholic law' (Council of Orleans of 533), etc. It was the same in the time of Pépin, of Charlemagne, and of Louis le Débonnaire. But, in 843, the Empire fell to pieces with the Treaty of Verdun. Then the Pope, who had become powerful, took the place of the kings, who were weakened by internal strife. As early as 846 the Council of Paris was assembled by Sergius II., who was on this occasion, however, merely the instrument of the Emperor, Lothair. Several years later, Nicholas I., acting in virtue of the superior rights of the Papacy, convoked the Councils of Metz (863), Soissons (866), and Troyes (867). Yet the Carolingian prince had not renounced the right exercised by his ancestors. He asked his bishops to meet in conciliar assemblies, and they obeyed. At least they still obeyed in 871 (Council of Douzy); for, in 876, it was as 'vicar' of John VIII. and 'in virtue of the Apostolic authority' that Charles the Bald convoked the Council of Ponthiou.

To find French councils again convoked by the king of France we must come down to the end of the 10th cent., when we see Hugues Capet assembling the Councils of Saint-Basel near Rheims (991) and of Chelles (993). This action is rendered still more curious by the fact that these Councils supported Hugues in his struggle against Rome. In the 12th cent., King Louis le Gros assembled the Council of Etampes (1130). Then at the time of the Great Schism, Charles VI. convoked in Paris the Councils of 1395, 1398, 1406, and 1408. Next appears the Council of Bourges, assembled by Charles VII. (1438). On this last occasion it was a question of adopting a definite attitude in the struggle which had arisen between the Council of Basel and Eugenius IV. In 1130 it was a case of deciding between two competing Popes. And it is well known that the Councils of Charles VI. had as their object the restoring of Christianity to unity of obedience.

On the whole, the king of France for many centuries did not convoke councils except in times of strife. In normal times he seemed to have forgotten the right which his Merovingian and Carolingian predecessors exercised. Yet, if we look into the matter closely, we find that he had not forgotten it, but had merely modified its use. From 1561 onwards, he periodically assembled the pre-

lates and the principal ecclesiastics of the kingdom to demand money from them. The councils of former times were succeeded by the 'Assemblies of the Clergy,' which were also convoked by the king and charged with finding supplies for the royal exchequer. These 'Assemblies' often relegated to the background the financial questions, which were the only reason of their existence, and concentrated their attention on problems of a theological or disciplinary character. They were, indeed, councils without being called by that name. In 1811, Napoleon, who was at strife with Pope Pius VII., reinforced the old tradition and convoked the Council of Paris.

(c) *The 'regale.'*—The king, who nominated his bishops and convoked the councils, also administered the property of the vacant bishoprics. He took possession of them through the medium of his officers, he managed them, and collected the revenues as long as the vacancy lasted—and it did not expire till the day when the new titular had registered his oath of fidelity at the Court of Accounts. Further, during the whole time of the episcopal vacancy, the king took the place of the bishop and filled up all vacant benefices that the latter had the right to confer. The king's collecting of the revenues of episcopal property during the vacancy was called the temporal *regale*; the collation of the benefices which chanced to become vacant during this time was called the spiritual *regale*. Both are testified to as early as the 12th cent., and no doubt go back still further. For a long time they gave rise to no difficulty. The spiritual *regale* was accepted as the logical consequence of the temporal *regale*, which itself appeared to belong to the king, inasmuch as he was the virtual owner, or, in any case, the guardian, of the property of the Church.

Not infrequently the king's officers plundered the property which they were commissioned to manage. These misdemeanours caused complaints, which found expression as early as 1274 in the second Council of Lyons (can. 12), and from that time onwards they were periodically renewed. As always happened, dissatisfaction did not long remain confined within its original limits. After the abuses of the *regale* had been protested against, a protest was next registered against the *regale* itself. In order to satisfy the complaints of the clergy in the 15th cent., Charles VII. promised to give the proceeds of the *regale* for some time to the chapter of the Sainte-Chapelle in Paris. But this temporary edict, rendered perpetual by Charles IX., was probably only a clever trick to deceive the public. In reality, the king of France, far from depriving himself of his right of *regale*, strove to extend it and introduce it into provinces that had not yet submitted to it. It was thus that Brittany was, after 1598, included under the common law. At the beginning of the 17th cent., four provinces were still exempt, viz. Languedoc, Provence, the Dauphiné, and Guyenne. Louis XIV. put an end to their privilege by the Edict of 1673, which imposed the right of *regale* on all the bishoprics of the kingdom.

The measure of 1598 which brought Brittany under the yoke was accepted without a murmur by the episcopate as well as by Pope Clement VIII. The measure of 1673 was also accepted by Pope Clement X. then reigning, and by all the bishops of the provinces affected except Pavillon, Bishop of Aleth, and Caulet, Bishop of Pamiers. It did not at first seem as if it would be a difficult task to reduce these two to reason; but, contrary to all expectation, they defied the government of the king, and, in 1678, Pope Innocent XI., whose help they demanded, sent to Louis XIV. two briefs of complaint, followed by a third threatening brief

(29th Dec. 1679). Although irritated by the attitude of the Pope, the king attempted to avoid a rupture. He negotiated with Rome, made fair promises, and relied on time to put everything right. But all his diplomacy was set at naught by a fourth brief—that of 1st Jan. 1681—in which Innocent excommunicated the Archbishop of Toulouse and all the ecclesiastics who had sided with this prelate in favouring the introduction of the *regale* into the diocese of Pamiers. Even bishops thought that the Church of France could not let this challenge pass without reply, and the convocation of a General Assembly of the Clergy was decided upon. It met in Paris at the end of October 1681, and opened its proceedings with the eloquent discourse of Bossuet on the *Unité de l'Église* (9th Nov. 1681). On 3rd Feb. 1682 it gave a decision in favour of the claims of the king. The same day it advised Innocent XI. to come to terms. The Pope replied by the brief of 11th April, in which he annulled the Assembly's decision; but the brief had no effect.

(d) *The taxes.*—Ecclesiastical wealth was, during the feudal period, the property of the king and the lord who gave the use of it to the bishop. Gregory VII., thanks to the quarrel about the investitures, managed to obscure this idea without absolutely abolishing it. After him and through his influence, the clergy began to foster sentiments of independence which found vent in the maxim that ecclesiastical property is exempt from the royal tax. This maxim, which remained uncontested in theory, was without effect in practice. In 1146, Louis VII., to provide for the expenses of the Second Crusade, imposed a tax on all his subjects. The clergy yielded on this and many other occasions, for Louis returned again to the charge. But they soon grew tired of paying, and in the Council of Tours of 1163 demanded that no subsidies on their property should be deducted without their being previously consulted. Philip Augustus accepted this condition. He asked the clergy for permission to take their money; but he took a great deal of it, notably in 1188 ('Saladin tithe'). Then Rome intervened. In the Lateran Council of 1215, Innocent III. forbade laymen to tax the property of the Church; he authorized bishops, however, in certain grave cases to come to the help of the country, but never without having first consulted the Apostolic See. Henceforth the ecclesiastical 'tithe'—so called because the king deducted the tenth part of the revenue of the clergy—was a contribution authorized by the Pope, who made this concession public in a Bull. But Philip the Fair, after 1294, freed himself from this humiliating subjection, and demanded a subsidy from the clergy without first obtaining the Pope's sanction. Boniface VIII. then launched the Bull *Clericis laicos*, which forbade princes, on pain of excommunication, to levy taxes on ecclesiastical property without the authorization of the Apostolic See, and prohibited ecclesiastics, under the same penalty, from paying any tax not authorized by Rome (24th Feb. 1296). A year later, Boniface, terrified by the threats of the king of France, retracted (in the Bulls *Romana mater* and *Etsi de statu*, 1297; there was already a veiled withdrawal in the Bull *Ineffabilis amor*, Sept. 1296). But on 5th Dec. 1301, he resumed the offensive by the two Bulls *Salvator mundi* and *Ausculda fili*, in which, as lord of the ecclesiastical property, he forbade all levy of subsidies on that property without his authorization. Boniface, however, was thwarted; his successors apologized to Philip the Fair, and the Bull *Ausculda fili* was suppressed. But further, scarcely had the above dispute begun when Boniface turned it into another channel (the Bull *Ineffabilis* of Sept. 1296) by

claiming to control the political authority of the king of France. It was this claim, accentuated in the *Ausculta fili*, and still more in the *Unam sanctam*, which led to the defeat of the Papacy. As to ecclesiastical property, it remained in the position in which it had been placed by the Lateran Council of 1215. Thus in 1337 we find Philip of Valois demanding tithes from Pope Benedict XII., who did not render them till 1340. And, in 1356, Innocent VI., hearing that the States General of Paris had collected a tithe from the clergy, recalls that 'these impositions are illicit without the permission of the Apostolic See.'

In the middle of the 14th cent., then, the king of France was still theoretically bound to ask permission from the Pope to demand money from the clergy. In practice, however, he had begun to free himself from this bondage; and soon the Popes, taking their cue from a state of things which they could not remedy, ceased to protest. The king, when he taxed the clergy, no longer needed to take Rome into account. But he had to take into account the unwillingness of the clergy, who claimed that the sacredness of their calling placed them above the financial burdens common to the rest of the nation. In 1489, Charles VIII., who had demanded a tithe from the clergy, received nothing. As a last resort, he had recourse to the Pope, and begged him to impose the tithe himself on the Church of France. It was not until the 16th cent. that the clergy finally submitted to the tax. But even then, to protect their principles, they strove to give their contribution an air of spontaneity. They promised the king a gift of money each year for a period of ten years. When the ten years had elapsed, they renewed their agreement for another period of ten years. The king, whose chief desire it was to be paid, allowed this innocent fiction to pass. He seemed to have forgotten the time when, as the owner of the bishoprics and abbeys, he conceded the right of occupying them to those whom it pleased him to make his feudatories.

But, if the king had forgotten the past, others remembered it. In the States General of 1560 the nobility and the *Tiers État* declared that ecclesiastical property belonged not to the clergy, who were only the usufructuaries, but to the king, and that he could in consequence transfer it. This idea was expressed in 1639 by Richelieu; in 1749, by the Comptroller of Finance, Machault. In 1788 the Minister of Justice formulated it again. Finally, in 1789 the *Assemblée Constituante* adopted it and everything it involved; the property of the Church was given back to the nation, which indemnified the ecclesiastics by giving them a salary.

(e) *The control of doctrine and worship.*—The king of France looked after the purity of faith and discipline. In 556, Childebert, hearing that Pope Pelagius had become implicated in the affair of the *Three Chapters*, submitted him to two successive examinations on orthodoxy, to which the Pope willingly consented. In the middle of the 8th cent., Pépin le Bref, on the advice of Boniface, abolished the Gallican liturgy and substituted for it the Roman liturgy; Charlemagne completed the work begun by his father, and in addition assembled several councils to deal with the Adoptianist heresy. In 811 he commanded all his archbishops to set forth in writing the true doctrine on the subject of baptismal vows. In 813 he commissioned the councils to work towards the reform of the customs of the Church. In 790, since he was of opinion that the Second Council of Nicæa and Pope Hadrian had taken up a wrong attitude on the question of images, he ordered their arguments to be refuted in the *Caroline Books*. He governed the Frankish Church.

The disorders which closely followed his death

put an end to this state of affairs for a long time. For several centuries the king of France, weakened by feudalism, and kept in check by the triumphant Papacy, gave up all attempt to hold that place in the Church which his predecessors had occupied. It was not until the middle of the 13th cent. that he again claimed the right of control in the domain of religion. It was Saint Louis who formulated this claim. His demand was but a modest one. Summoned by the clergy to force all excommunicated persons to give satisfaction to the Church, he was quite willing to obey, but on condition that the justice of the sentences should first be examined (1263). Forty years later, Philip the Fair went still further. He desired Clement V. to admit that Boniface VIII., in his dispute with the king of France, had been guilty of abuse of power. He obtained entire satisfaction, for Clement confirmed the absolution which his predecessor Benedict XI. had already granted Philip, annulled all the innovations contained in the Bull *Clericis laicos*, and exempted France from the orders contained in the Bull *Unam sanctam* (1305).

Since the time of Charlemagne, however, no king of France had penetrated the domain of doctrine properly so called. Philip of Valois renewed the tradition.

Hearing in 1333 that Pope John XXII. held very questionable views on the subject of the Beatific Vision, he consulted the most enlightened scholars, and received information from them as to the position of the matter; then, when he was thoroughly convinced on the subject, he wrote to the Pope and demanded that he should abandon the false position he had taken up (1334). In a word, he defended orthodoxy against the Pope.

Two centuries later, Philip's successors fulfilled their task with great vigilance. Protestantism had made its appearance in France; the object now was to get rid of it.

Francis I. proceeded with great vigour against heretics and had them burned at the stake (from 1534). His son, Henry II., was still more ferocious (Edict of Chateaubriant, 1551). Catherine of Medici, after having accorded the Protestants a provisory liberty by the Edict of Jan. 1562, had them massacred on St. Bartholomew's Eve (1572). Henry IV. promulgated in their favour the Edict of Nantes (1598), which guaranteed them safety; but this Edict was revoked by Louis XIV. in 1685. Not until the eve of the Revolution did Protestants recover their liberty (Edict of Louis XVI. of 14th Nov. 1787).

While the king of France was striving to preserve his subjects from heresy, he was attempting at the same time to free them from the yoke of Rome. It was towards this goal that the institution of the *placet* tended—a measure which subjected to royal authorization the circulation of Papal Bulls in France. In the memorandum of 1247, Saint Louis complained bitterly of Papal administration and of the harm it did to the French; but at the same time he took no measures against this scourge. In 1302, Philip the Fair burned the Bull *Ausculta fili*: this is an example of a violent *placet*. In 1423, Charles VII. placed an interdict on all the Papal Bulls which granted benefices in France: here we have the *placet* raised to the height of a legislative act. This act of legislation was developed by Louis XI. (Ordinance of 1475); after this date it was made use of by all succeeding governments in France down to 1870. It was on it that Catherine of Medici, Henry III., and Henry IV. relied when forbidding the acceptance of the decrees of the Council of Trent relating to reform. In 1639 the King's Council had recourse to it in order to set aside a decree of the Parliament of Bordeaux, which had registered briefs from Rome. In 1802, Bonaparte inserted it in the *Organic Articles* which followed the Concordat. In 1865, Napoleon III., taking as his authority the *Organic Articles*, forbade the French bishops to publish the *Syllabus*.

The king of France, who supervised Rome, also supervised her bishops and priests. He repressed the Jansenist theories which were spreading among

the clergy; he repressed the quietism of Fénelon. Although, as a rule, he only seconded the action of the Pope, sometimes he anticipated it.

In 1697, Louis XIV. asked Innocent XII. to condemn Fénelon. In the following year (Dec. 1698) he reproached the Pope with his slowness, and declared that he desired without further delay a 'clear and well-defined' condemnation. Some months later (March, 1699), hearing that Rome was trying to conciliate Fénelon, he expressed his violent displeasure with the Pope, and ordered him imperiously to do his duty. Finally, he had the joy of seeing the Pope obey, and launch against the Archbishop of Cambrai the condemnation which had been extorted from him. In 1705 he again pestered Rome, and demanded from Clement XI. a solemn Bull against the Jansenists. Clement, like Innocent XII. before him, yielded, and drew up the Bull *Vineam Domini*. Being pressed by the king a second time to issue a Bull against Queanel, he again obeyed, and drew up the Bull *Unigenitus*.

The anxiety which the civil power evinced to maintain orthodoxy took an unexpected turn in the 18th century. Parliament then protected the Jansenists, and protected them against the clergy, who, from time to time, refused these unfortunate men the last sacrament when they were dying. Each time that an act of this kind came to the knowledge of Parliament, they condemned it and forced the bishops either to dispense the last sacrament themselves or have it dispensed by their priests to all Christians who asked it. In 1731, Parliament drew up a measure in this direction, which was followed by other measures of a similar kind in 1749 and in 1752. The king tried to resist; but his resistance, though energetic at first, gradually grew weaker, and finally he capitulated. After 1754 the refusal of the sacrament to Jansenists who asked for it was forbidden by civil law.

3. Seizure of temporalities: appeal by writ of error.—In the exercise of the rights which he possessed over the Church of France, the king was often in conflict with the clergy. He was then reduced to employing violent measures, the chief of which was the seizure of temporalities.

In 869, Charles the Bald, to avenge himself on Hincmar of Laon, confiscated the property of his church. In 1092, Philip I., who was dissatisfied with Ives of Chartres, gave the belongings of his bishopric over to plunder. In 1107 the same king pillaged the property of the church of Rheims to avenge himself for the insult that had been done him in the rejection of Gervais, his candidate for this church. In 1142, Louis VII. prevented Pierre de la Châtre from taking possession of the bishopric of Bourges. In 1232, Blanche of Castille seized the temporalities of the Archbishop of Rouen, of whom she had cause to complain, and resisted Pope Gregory IX. when he tried to make her yield. In 1302, Philip the Fair seized the temporalities of the bishops who had gone to the Council of Rome in spite of his prohibition.

Towards the end of the Middle Ages the seizure of temporalities was divested of the brutal character which it had possessed for several centuries; it was preceded by a legal act which was called the appeal by writ of error. Of obscure origin, this appeal by writ of error came into more extensive use after the *Pragmatic Sanction* of 1438. It gained full force in the time of Jansenism.

Under Louis XV. the appeals by writ of error were frequent and effective. The curé of Paris, Bouettin, was put in prison (1749). The Archbishop of Paris, de Beaumont, and the Archbishop of Aix were exiled. The Bishops of Vannes and Nantes submitted to the penalty of confiscation (1754).

In 1802 the appeal by writ of error was inserted by Bonaparte in the *Organic Articles* which followed the Concordat: 'There will be recourse to the Council of State in all cases of abuses on the part of superiors and other ecclesiastical persons.' It remained in force till the day when the law of separation put an end to the Concordat (1905).

It has been said that royal Gallicanism was hateful to the clergy. It could not help being so from the fact that it proposed to limit the power of the ecclesiastics and put an end to their encroachments. In the 9th cent., Hincmar of Rheims presented a long memorandum to Charles the Bald, in which he accused the king of France of having, by his conduct with regard to the Bishop of Laon, violated the privileges of the clergy. Complaints of the same nature were

brought by Pope Gregory IX. (1232, 1233, 1238), by the Bishop of Angers, Guillaume Lemaire, in petitions addressed to Philip the Fair (1294 and 1299), and by ecclesiastical orators of the *Assembly of Vincennes* (1329). The clergy claimed that their 'liberties' had been crushed by civil society, and were determined to defend them. But civil society also claimed a right to defend her liberties against the invasions of the clergy. The disputants were thus quite irreconcilable. The controversy became still more grave from the day when Pierre Pithou published his treatise on the *Libertés de l'Église gallicane* (1594), which Dupuy completed by the *Preuves des libertés de l'Église gallicane* (1639). Emboldened by this exposition of the rights of civil society, Parliament took measures for the defence of the laymen, which did not meet with the approval of the clergy. Fénelon writes that 'the liberties of the Gallican Church are real servitude' (letter of 3rd May 1710 to the Duke of Chevreuse). Bossuet declares that the liberties claimed by the clergy have nothing in common with the liberties of which the magistrates talk (*Defensio declarationis*, ii. 10; letter of 1st Dec. 1681 to d'Estrées). In the middle of the 18th cent. the complaints became more bitter. In 1755 the Assembly of the Clergy denounced Parliament before the king for having arrogated to itself the right of legislating on the administration of the sacrament. In 1765 the Assembly published a theological dissertation entitled *Actes du clergé* to prove that the teaching of religion and the administration of the sacrament are not under the control of laymen. It will be seen later what the attitude of the episcopate was in 1790 with regard to the Civil Constitution. After the Revolution, the clergy accepted the situation laid down by the Concordat of 1801, and confined themselves to raising intermittent protests against the *Organic Articles*. But the hope of recovering the advantages of the past has led many of the clergy to take part in the attempts to restore the monarchy which have been made since the war of 1870.

II. EPISCOPAL GALLICANISM.—Episcopal Gallicanism imposes two limits on Papal authority: the one, from the side of the monarchy, rescues political authority from Pontifical jurisdiction; the other, on the side of the General Council, places the latter above the Roman Pontiff. It comprises, then, two fundamental maxims, which may be stated as follows. (1) The Pope may neither depose kings nor exempt their subjects from the duty of obedience; in other words, kings are independent of the Pope. (2) In the domain of spiritual things the supreme authority belongs to General Councils and not to the Pope, who, on the contrary, must obey their canons. It would occupy too much space to illustrate these two maxims in full historical detail; consequently we shall study Episcopal Gallicanism only from the year 1682 onwards.

We have seen (above, p. 159) that the Assembly of the Clergy of 1682 was brought together to solve the matter of the *regale*, and that it gave full satisfaction to the king on this point (3rd Feb. 1682). It must be noted here that the prejudices of the clergy carried them still further. They saw in the dispute between the French monarchy and Rome an opportunity for cutting short in a painful but salutary way the doctrinal and juridical pretensions of the Papacy; and they did not mean to let this opportunity slip. 'The Pope laid hands on us, he will repent of it,' said de Harlay, Archbishop of Paris; and this expressed the sentiment of the other prelates. They wished it to be understood that Pontifical omnipotence was rejected by the Church of France; and, in

order that Rome might not remain in ignorance of this fact, they charged Bossuet to draw up, in the name of the whole French clergy, a profession of faith combating this omnipotence. They intended the statement to be violent and radical—schism was hanging in the balance; but Bossuet drew it up with calculated moderation. This document was the famous *Declaration of 1682*. It comprised four articles, of which the following is the substance. (1) Popes may not depose kings, for the reason that their authority concerns only things spiritual and does not extend to things temporal. (2) Even in the domain of things spiritual, the authority of Popes does not extend beyond the limits fixed by the Council of Constance. (3) In so far as it is legislative and judiciary, this authority is—conformably to the decisions of the Council of Constance—limited by the canons and also by the usages and constitution of the kingdom of France. (4) In so far as it is doctrinal, it is subordinate to the judgment of the Church, which may reform it.

The Church of France rallied round her king. The king, to show his gratitude, established the Declaration as a law of the State, and made the teaching of it compulsory throughout the kingdom (Edict of 20th March, 1682, registered 23rd March). The French clergy and their king offered combined resistance to Rome. But Rome well knew how to return the blows which were dealt her. Innocent XI.'s first idea was to condemn the Declaration (Bossuet, letter of 28th Oct. 1682 to Durois; letter of 30th Oct. to de Rancé); but, changing his tactics, he decided to refuse canonical institution to those among the new bishops who had, as simple priests, sat in the Assembly of 1682. By this boycott he hoped to force the king to withdraw his edict. But the king, by way of retaliation, forbade those among the new bishops whom the Papal measure did not affect to provide themselves with their Bulls of investiture.

The hostilities, opened in 1682, had lost nothing of their acuteness in 1688. They were even more violent than ever, for it was at this date (24th Sept. 1688) that Louis XIV. ordered the Procurator General to lodge an appeal with the coming Council against all the procedures taken or to be taken by the Pope against him. The Church of France was not a handbreadth from schism. But, at this moment, the king, who was at war with the whole of Europe, was obliged to have recourse to political intrigues of which Rome alone could ensure the success. And then he remembered very opportunely—his counsellors recalled it to his memory—that he owed to the Concordat of 1516, i.e. to an agreement with Rome, the right of nominating his bishops himself, and that a schism, by restoring the episcopal elections so highly recommended by the *Pragmatic Sanction*, would favour the emancipation of the clergy. Obedient to the voice of his own interest, he conciliated the Pope and entered into negotiations with him. His first advances, the motive of which was clearly discerned at Rome, were coldly received; and, further, Alexander VIII., the successor of Innocent XI., annulled the Declaration without, however, branding it with any censure (30th Jan. 1691). Finally, under Innocent XII., matters were arranged. In a letter addressed to the Pope (14th Sept. 1693), Louis XIV. renounced his edict; in other words, he gave up making the doctrine of the Declaration compulsory. The same day those of the nominated bishops who had taken part in the Assembly of 1682 sent a letter to Rome, the ambiguous and cleverly chosen expressions of which might be construed either as a doctrinal retractation or as a simple apology. Innocent XII. was content to let bygones be

bygones, and refused no one canonical investiture.

Peace had been made; but each of the rival parties held to its old position. In 1695 the Spanish prelate, Rocaberti, made a violent attack on Gallicanism in three volumes, to which Rome gave approving briefs. Immediately Bossuet presented a memorandum to Louis XIV., in which he proposed that the king should forbid the sale of Rocaberti's work in France and demand from Innocent XII. 'explanations as to the intention of his briefs.' By a royal edict of 20th Dec. 1695, the sale of Rocaberti's book was forbidden. The Pope probably did not explain why and in what sense he approved of the work. In return, eighteen years later (1713) he asked the king for explanations as to the freedom with which Gallican maxims were circulating in France. The king replied that he had in 1693 given up enforcing these maxims as laws of the State, but that he had never undertaken to interdict them. Bossuet, who in 1682 had undertaken the *Défense de la Déclaration*, laboured till the end of his life to complete this important work. Fénelon, who strove to conciliate Rome, admitted nevertheless that she had 'too great pretensions' (letter of 3rd May 1710 to the Duke of Chevreuse); he even maintained that the Popes 'had desired to crush the episcopate' (*De summi pontificis auctoritate*, 4). And in 1705 the Assembly of the Clergy, called to receive the Bull *Vineam Domini*, adhered to it only after having submitted it to a thorough examination.

From all these and other indications, Rome could see that the French episcopate had, at the beginning of the 18th cent., remained faithful to the doctrines of the Declaration of 1682. But a new proof of this was given in 1728. At this date Pope Benedict XIII. extended to the Universal Church the observance of the festival of Gregory VII., and inserted in the breviary prayers for this Pope—most warlike prayers, in which Gregory was lauded for having deposed the Emperor Henry IV. On 27th July 1729 the Parliament of Paris—followed shortly afterwards by the Parliaments of Brittany, Metz, and Bordeaux—passed a statute suppressing the leaf containing these prayers, and prohibiting its use in public under penalty of the seizure of the temporalities of the Church. Six Jansenist bishops hastened to take advantage of this occasion to rebel against Rome. They joined the campaign of Parliament, and solemnly condemned the cult of Gregory VII. The great majority of the episcopate, without being so violent, were equally unprepared to submit to it. They did not condemn the cult of the Pope who had deposed Henry IV., but they rejected it as well as the prayers which had come from Rome. It was a case of revolt; but, instead of being violent like that of the Jansenists, it was silent (see, in the Assembly of the Clergy of 1730, the address to Louis XV.).

In 1790 the *Assemblée Constituante* established the *civil constitution* of the clergy, which broke the Concordat of Francis I., and reinforced the *Pragmatic Sanction*, but at the same time suppressed several bishoprics, overturned the dioceses, and restrained the authority of the bishops. This new state of affairs was in accordance with the wishes of the lesser clergy and of the *tiers état*. But the bishops, with four exceptions, began to wage war against it. To give to their hostility an air of disinterestedness, they discovered most opportunely that the spiritual jurisdiction of the Pope over the Church of France was a dogma, and they defended their action under the name of orthodoxy. These clever tactics made an impression on the people, and even on a considerable

part of the lesser clergy. By their means, the *civil constitution* of the clergy was rejected with horror by pious laymen, and in the ecclesiastical world it did not gain the support of more than a third of the curés. Eleven years later, when Bonaparte concluded the Concordat of 1801 with Rome, it was seen what the theological dissertations of 1790 were worth. Many of those bishops who were so attached to the Pope when their own interest demanded that they should rally round him refused to resign their office for Pius VII., when he required them to do so (15th Aug. 1801). Thirty-six out of the eighty remaining bishops rose in rebellion against Rome. And, among those who gave up their property, more than one did so on a promise of advancement.

The episcopate of Napoleon I. was Gallican, and so were his clergy, with a few exceptions, amongst those of lower rank. Sixty years later, the French bishops and priests rejected most of the maxims of 1682. In the space of two generations the Church of France had changed its point of view. The evolution began from the bottom, with the clergy of the second rank. The principal workers were Lamennais, the Jesuits, and Veillot. The work of Lamennais was violent and brilliant. That of the Jesuits was silent, hidden, but more profound. Yet it was not more profound than that of Veillot, who from 1839 onwards, through the medium of the daily paper, *L'Univers*, never ceased from inculcating the maxims of Rome into the mind of the clergy. The Concordat of 1801, by the prestige it gave to the Pope, may have had a certain influence, which, however, some historians have exaggerated. Finally, the books of Joseph de Maistre, *Du Pape* and *L'Église gallicane* (1820), did not fail to render some service to the Papacy.

Whatever was the reason, when the Vatican Council assembled (Dec. 1869) the Gallican doctrine of the superiority of Councils over Popes had only a small number of defenders in France, the best known of whom were Darboy, Archbishop of Paris; Dupanloup, Bishop of Orleans; Maret, Titular Bishop of Sura and Dean of the Faculty of Theology in Paris; Gratry, oratorian and member of the French Academy; Loyson, Carmelite and preacher at Notre-Dame in Paris; Montalembert, a layman. These defenders were vanquished, for in its fourth session (18th July 1870) the Vatican Council assented to the Pope's infallibility and full jurisdiction over the whole Church. Henceforward Episcopal Gallicanism became a heresy, and its upholders had either to repudiate it or leave the Catholic Church. Loyson chose the latter course, and tried unsuccessfully to found a national Church. A few priests left the ranks of the Catholics and took refuge in Switzerland, where they were admitted into the party of the Old Catholics. Montalembert died before the decision. The other Gallicans submitted to the Vatican Council. Episcopal Gallicanism was dead, and in its place the maxims of Rome reigned. As a matter of fact, these maxims have since made some concessions to circumstances. Pontifical omnipotence, which, before the French Revolution, embraced the political as well as the religious world, has, since the Revolution, allowed the political world to slip from its grasp. The Popes of the 19th cent. did not talk of deposing kings. No doubt they did not renounce the right, but they no longer exercised it (Pius VII., who excommunicated Napoleon in 1809, says in his Bull that he does not mean to pass judgment against temporal power and the obedience of subjects); they did not even dare to formulate it except in terms which were purposely vague (Proposition xxiv. of the Syllabus). On the whole, it may be said that French Catholics—like those of

other countries—think that they may be Gallican on this point without violating orthodoxy.

LITERATURE.—A. INDEPENDENCE OF KINGS IN THEIR RELATION TO THE PAPACY.—O. Delarc, *Saint Grégoire VII. et la réforme de l'Église au X^e siècle*, 3 vols., Paris, 1889-90; P. Dupuy, *Hist. du différend entre Boniface VIII. et Philippe-le-Bel*, do. 1855; P. Féret, *Henri IV. et l'Église*, do. 1875, *Le Cardinal Du Perron*, do. 1877; H. Finke, *Aus den Tagen Bonifaz VIII.*, Münster, 1902; Fustel de Coulanges, *Hist. des institutions politiques de l'ancienne France*, vi., Paris, 1892; C. Gérin, *Recherches histor. sur l'assemblée du clergé de France en 1682*, do. 1868; H. Grégoire, 'Hist. de l'émigration,' in *Mémoires*, ii., do. 1840; P. Guéranger, *Institutions liturgiques*, ii., Le Mans, 1840; A. Hauck, *Kirchengesch. Deutschlands*, ii., Leipzig, 1908; J. A. de Hübner, *Sixte-Quint*, 8 vols., Paris, 1870; P. Jaffé, *Regesta pontificum romanorum ab condita ecclesia ad annum post Christum natum 1198²*, 2 vols., Leipzig, 1886-88; A. Lapôtre, *L'Europe et le Saint-Siège à l'époque carolingienne*, Paris, 1895; de l'Épinois, *La Ligue et les papes*, do. 1884; J. T. Loyson, *L'Assemblée du clergé de France de 1682*, do. 1870; J. Michelet, *Hist. de la révolution française*, ii., do. 1847; C. Mirbt, *Die Publizistik im Zeitalter Gregors VII.*, Leipzig, 1894; G. J. Phillips, *Das Regalienrecht in Frankreich*, Halle, 1878; J. M. Prat, *Recherches histor. et crit. sur la Compagnie de Jésus en France du temps du P. Coton*, iii., Lyons, 1876; L. Ranke, *Die röm. Päpste*, ii. and iii., Leipzig, 1847; A. Sicard, *L'ancien Clergé de France*, ii., Paris, 1894; J. Turmel, 'Bossuet,' in *Revue du clergé français*, xxxviii. (1904).

B. SUPERIORITY OF GENERAL COUNCILS OVER THE PAPACY.—E. Berger, *Les Registres d'Innocent IV.*, vol. ii., Introd., Paris, 1884; I. v. Döllinger, *Das Papstthum*, Munich, 1892; P. Dubois, *De Recuperatione terre sancte* (ed. Langlois), Paris, 1891; Durand de Maillane, *De modo concilii generalis celebrandi*, do. 1671; R. F. W. Guettée, *Hist. de l'Église de France*, 12 vols., do. 1847-56; J. Haller, *Papsttum und Kirchenreform*, Berlin, 1903; A. Hauck, *Kirchengesch. Deutschlands*, i. and ii., Leipzig, 1900-03; P. Hinschius, *Das Kirchenrecht*, iii., Berlin, 1882; P. Imbart de la Tour, *Les Élections épiscopales dans l'Église de France du IX^e au XII^e siècle*, Paris, 1891; A. Kneer, *Entstehung der Konzil. Theorie*, Rome, 1893; E. Lesne, *La Hiérarchie épiscopale en Gaule et en Germanie*, Paris, 1905; E. Loening, *Gesch. des deutschen Kirchenrechts*, 2 vols., Strassburg, 1878; F. Lot, *Études sur le règne de Hugues Capet*, Paris, 1903; A. Malnory, *Saint Césaire, évêque d'Arles*, do. 1896; L. Pastor, *Gesch. der Päpste*, iii. and iv., Freiburg i. Br., 1895, 1906; H. Schrörs, *Hinkmar, sein Leben und seine Schriften*, do. 1884; L. Tillemont, *Mémoires pour servir à l'hist. ecclésiast. des six premiers siècles*, Paris, 1693-1712, iii. x. xv.; J. Turmel, *Hist. du dogme de la papauté des origines à la fin du IV^e siècle*, do. 1908; N. Valois, *La France et le grand schisme*, do. 1896-1902, *Hist. de la Pragmatique Sanction de Bourges*, do. 1906, *La Crise religieuse du XV^e siècle*, 2 vols., do. 1909.

C. ROYAL GALLICANISM.—P. Dupuy, *Preuves des libertés de l'Église gallicane*, 2 vols., Paris, 1639, 1651, etc.; A. Esmein, *Cours élémentaire d'hist. du droit français*, do. 1892; D. L. Frayssinous, *Les vraies Principes de l'Église gallicane*, do. 1826; H. Grégoire, *Essai histor. sur les libertés de l'Église gallicane*, 3 vols., do. 1826; A. Luchaire, *Hist. des institutions monarchiques sous les premiers Capétiens*, 2 vols., do. 1891, *Manuel des institutions françaises*, do. 1892; J. de Maistre, *De l'Église gallicane*, do. 1820; P. de Marca, *Concordia sacerdotii et imperii*, do. 1704; O. Martin, *L'Assemblée de Vincennes de 1329*, do. 1909; P. Viollet, *Hist. des institutions politiques et administratives de la France*, 2 vols., do. 1898; also the works of Phillips, Hinschius, and Hauck, mentioned above.

JOSEPH TURMEL.

GAMBLING.—I. Diffusion of the practice.—Games of chance are as old and as wide-spread as humanity (see art. GAMES). They are probably derived from the various methods of divination (*q. v.*) by which primitive man seeks to gain knowledge of the future, some of them serious, like the throwing or drawing of lots; some of them more playful, like the Greek *kottabos* and the 'willow bough' (Hall Caine, *Manxman*). The game of chance is a kind of secularized divination. In order to give zest to the game, the players stake some possession on the turn of chance. The N. American Indians bet on the different colour of pips or stones, the Siamese on the mussel-fish, whether the opening turns upwards or downwards; the Greeks already in Homer had their *δορράγαλοι* (knuckle-bones from the hinder feet of sheep, goats, and calves) marked with numbers on four sides to serve as dice. Later came the six-sided dice (*κύβοι*, derived, according to Hyde, from Arab. *qāb*, *qa'b*). Among the Romans, children played at 'heads or tails' (*caput aut navis*) with coins; there was also dice play, and the game of *morra* (*micare digitis*). Knuckle-bones are found in Egyptian excavations as far back as the XVIIIth dynasty,

and imitation knuckle-bones for gaming purposes were made of glass and shell. A gaming-board of gold and silver inlaid with crystal, ivory, and *kyanos*, discovered in Crete, dates back to between 1800 and 1650 B.C. Six-sided dice have also been found in pre-historic remains of Hradischt in Bohemia. In Babylonia, headless arrows were used for gaming as well as divination ('belomancy,' Ezk 21²¹); these have a very wide distribution over both hemispheres. The principle of the roulette is found in the spinning coco-nut (Tylor, *PC* i. 80) and the spinning dice of the Chinese. Card games are a later introduction; they give scope for calculation and skill. There is no mention of gambling among the Israelites until the days of the Exile (Is 65¹¹ 'forsaking Jahweh and forgetting my holy mountain, preparing a table for Luck and filling up mixed wine to Fortune'; cf. FORTUNE [Biblical and Christian]). The Israelites used the drawing of lots to ascertain the Divine will in regard to such matters as assignation of lands (Nu 26³⁵), choice of an officer (Ac 1²⁶), determining the rotation of office (1 Ch 24⁶, Lk 1⁹), or to identify an offender (Jos 7¹⁶, 1 S 14⁴², Jon 1⁷); but, so long as they remained agricultural, they seem to have been singularly free from the evil of gambling. In Babylon they became mercantile, and mixed with people among whom games of chance were part of regular ordinary life. The gambling habit infected the purity of the early Christians. Instruments of gambling are found in their tombs. Councils of the Church forbade it to the clergy. Christian preachers denounced it as worldly. 'If you say that you are a Christian when you are a dice-player, you say you are what you are not, because you are a partner with the world' (cf. Tertullian, *de Spectaculis*, xvi.; Clem. Alex. i. 325 [Charles's tr.], p. 29 [Potter's tr.]).

On the Aryan races gambling has had a special hold. A famous hymn of the Rigveda (x. 34) vividly sets forth the woe of the ruined gambler, and the length to which gambling was carried in India is well illustrated by the episode of Nala and Damayanti in the *Mahābhārata* (iii. 59-61) where the prince loses all that he has. The Sanskrit drama *Mṛchchhakatikā* (tr. Ryder, *The Little Clay Cart*, Cambridge, Mass., 1905) contains in its second act a lively picture of a gambler's quarrel, and Sanskrit literature abounds in allusions to the evils of play (Böhtlingk, *Ind. Sprüche*, St. Petersburg, 1870-73, nos. 615, 750, 1246, 1618, etc.; on gambling in ancient India generally, see Zimmer, *Altind. Leben*, Berlin, 1879, pp. 282-287; von Schroeder, *Mysterium und Mimus im Rigveda*, Leipzig, 1908, pp. 377-395; Lüders, *Würfelspiel im alten Indien*, Göttingen, 1907). For Greece, reference may be made to the picture of the ruined gambler presented by Alciphron (iii. 42). Greek boys gambled away their mothers' money (Herondas, *Mimes*, 3; Isocrates, *Areiop.* 149 CD). The Germans, according to Tacitus (*Germ.* 24), when they had the dice in their hands, knew no bounds, and were ready to gamble away even that which they valued above everything else in the world, their personal freedom. Generally speaking, it may be said that gambling has its chief hold on races which exist by hunting, and also on the pastoral, military, and mercantile types of culture. These modes of life are by nature less stable, and seem to generate a craving for sudden and exciting reversals of fortune, without which life seems colourless. The peasants, on the other hand, who have to work hard and steadily for their sustenance, are comparatively free from the habit.

2. Motives of gambling.—The demonic power of the passion seems due to three main causes: (a) the desire for gain, (b) the desire for excitement,

(c) the instinct of combativeness.—(a) *The desire for gain.* Human nature is impatient of the delays of regular work. It wants to acquire at one stroke, without trouble, and without the laborious accumulation of little by little.—(b) *The desire for excitement* is in one sense a revolt against the narrowness, the limitations, the ordinariness of existence. Man craves for intensified life; and gambling, with its risk, its suspense, its thrill, its hope, and its shock of surprise, supplies all the necessary catastrophic elements. Hence it is, on the one hand, the last resource of the *blasé* who wishes to goad his jaded senses; and, on the other hand, the outlet of the energetic and adventurous nature which finds ordinary peaceful existence too humdrum and lacking in sensation.—(c) In betting, a man backs his own powers, his judgment, or his luck. In a game of pure chance men *pit themselves against each other*, and, if there is no deception, each has an equal chance.

'If Hercules and Lichas play at dice
Which is the better man, the greater throw
May turn by fortune from the weaker hand:
So is Alcides beaten by his page'

(Shakespeare, *Merchant of Venice*, ii. i. 32).

Even when all seems lost, a sudden overmastering victory is still possible. Success lends a sort of supernatural glory to the winner, who is regarded as a 'favourite of fortune'; defeat does not wound the self-respect of the loser.

3. Cost of gambling.—The extent to which gambling prevails at the present time is difficult to assess with any approximation to accuracy. Most of it is centred in horse-racing. J. M. Hogge (*The Facts of Gambling*) calculates that, allowing for Sundays, there are only 10 days during the year in which there is no horse-racing of some kind in England. On every other day there are either one or more steeplechases or flat races. In all, there is an equivalent of 542 days' racing in the year. The amount of money which changes hands can be estimated only indirectly. The returns from the *totalisateurs* on two race-courses at Paris come to £5,000,000 yearly. The total amount of money betted through the *totalisateurs* in France is stated as £13,000,000 for the year 1910. It is within the mark to assume that there is, in England, at least three times the amount of racing that there is in France, so that a very moderate estimate of the betting on English race-courses would be twice the French total, viz. £26,000,000. But for every bet made on the race-course, there are probably two made by those who are not present, on the 'starting-price' system, so that, if the amount spent on the race-course is doubled, we have a moderate estimate of the amount of money which changes hands in gambling on horse-racing alone, viz. £52,000,000 per annum. To this must be added the coupon-betting on football, which is diligently fostered by many newspapers and weekly journals, especially in the North, under the guise of 'Skill Competitions.' A great deal of betting goes on also in connexion with professional bowling, cycle-racing, and other sports. There are the 'gambling schools,' chiefly found in the mining districts, where a glorified kind of pitch and toss is played on a large scale, and everything depends on the spin of a coin. There are, again, all the private bets, and the money which changes hands over cards, especially Bridge. On the whole, it may be safely asserted that little short of £100,000,000 changes hands every year in England in connexion with gambling transactions.

When money changes hands it is clear that the winners do not gain as much as the losers lose. At Monte Carlo the rate of profit made by the Bank works out, according to the published Balance-Sheets, at 1.4 per cent of the turnover. Stock-

brokers charge usually 25 per cent. In horse-racing the percentage is much higher, and in football betting, according to Ainslie Robertson (see Literature at end), the brokerage charge is more exorbitant still. It is, therefore, clear that, if one keeps it up long enough, the element of probability will even itself out. Any one, however long his purse, is bound to be ruined by the mere continual payment of brokerage. The brokerage mounts up steadily with the amount of play and eats up the gains, which have no tendency to increase with the amount of play.

That the practice is on the increase is clear from the large amount of space devoted by the evening and morning papers to the publication not merely of sporting but of betting intelligence. There is also a notable increase in the number of papers devoted entirely to sport, many of which circulate only through the post. At the time of the 'Limerick' craze, no fewer than 170,000 sixpenny postal orders were issued in one day, and one publishing firm received £41,586 in a single month in connexion with Limerick competitions.

Gambling has exploited most successfully for its own propagation the improved means of intercourse afforded by modern civilization, viz. the Post Office, the Telegraph, and the Printing Press. It exploits also the work of the schools, for without universal education it would be unable to carry on its business.

4. Legislation affecting gambling.—The vicious tendency of gambling has never been called in question. Lord Beaconsfield spoke of it as 'a vast engine of national demoralization.' Side by side with the betting odds and betting tips, the newspapers record the tragic results on those who yield to the temptation. In 12 years (1895-6 to 1906-7) there were 156 suicides or attempted suicides in England assigned to this cause, as well as 719 cases of theft or embezzlement, and 442 bankruptcies. In view of these facts, it is not surprising that, in all civilized countries, gambling is subjected to definite legislative restraints.

The earliest English statute in 1542 prohibited 'sundry new and crafty games' of a gambling nature, and prescribed that no folk of the working class should 'play at the tables, tennis, dice, cards, bowls, clash, cloyting, loggetting or any other unlawful game.' The purpose of this statute was to arrest the decay of archery, but the preamble alludes also to impoverishment, crime, neglect of Divine service. The first act directly aimed at gambling, apart from playing games, was in 1665. In 1698 lotteries were made illegal. Other Acts were passed in 1710 and 1751. The Acts of 1845 and 1853 were directed towards the suppression of public gaming-houses (though they did not touch private clubs like Tattersall's). Also, in 1854, it was made an offence to publish advertisements showing that a house was kept for the purpose of betting. The Act applied only to ready-money betting, and did not cover bets by letter, telegram, or telephone. The Act of 1868 prohibited the playing of pitch and toss in the streets, which had become a nuisance in the colliery districts, and the Vagrancy Act of 1873 extended the prohibition to all kinds of betting and wagering in public places. Municipal Boroughs and County Councils in some cases adopted by-laws for the repression of betting in public places. In 1892, Lord Herschell's Act made it a misdemeanour to send to an 'infant' any paper inviting him to enter into a betting or wagering transaction. In 1901 a Select Committee of the House of Lords was appointed 'to inquire into the increase of public betting among all classes, and whether any legislative measures are possible and expedient for checking the abuses occasioned thereby.' The inquiry brought to light the enor-

mous increase in the numbers of the professional bookmakers (estimated at over 20,000), and in the practice of betting among working classes—a practice which, when carried to excess, they found to be opposed to the true interests of sport, injurious to the general community, and apt to degenerate into one of the worst and most mischievous forms of gambling. The Committee considered that the best method of reducing the practice was to localize it as far as possible, by restricting it to race-courses and other places where sport is carried on. With a view to effecting this, they considered the advisability of (a) the licensing of bookmakers, and (b) the establishment of the *totalisateur* system. But they rejected these expedients, because either would imply legal recognition of the bookmaker, and necessitate the making of betting debts recoverable by law.

The law does all it can to discourage gambling, without attempting the impossibility of prohibiting it. Betting or gambling in a private house has never been treated as an offence at law, but no gambling debt can be enforced at law. The contract is void; it is not illegal. In bankruptcy, all claims of 'debts of honour' are struck out. All moneys deposited as cover before an event with turf commission agents or bookmakers having an address in the United Kingdom, whether deposited with them or with their bankers, can be recovered with costs (*Lennox v. Stoddart*, and *Davis v. Stoddart*, 1902).

The present state of the law in Great Britain is defined by the Street Betting Act of 1906. The object of the Act is to suppress betting in streets and public places. It is a criminal offence to frequent or loiter in a street or public place for the purpose of bookmaking, betting, wagering, agreeing to bet or wager, paying or receiving bets, or settling bets. This applies to all persons, whether acting for themselves or on behalf of another. Any constable may take into custody, without a warrant, any person committing an offence under the Act, and may detain all books, cards, papers, and other articles relating to betting which are found in such person's possession. The public places coming within the definitions of the Act include all regular football and cricket fields, and generally places where outdoor sports are carried on. But race-courses and the ground adjacent are exempt from the operation of the Act on the days when horse-races take place. The exemption applies only to horse-racing. The penalty for a first offence is a fine not exceeding £10; for a second offence, not exceeding £20; for a third or any subsequent offence, (a) under the Summary Jurisdiction Acts the penalty is a fine not exceeding £30, or imprisonment with or without hard labour for a term not exceeding 3 months; (b) on conviction on indictment, the penalty is a fine not exceeding £50, or imprisonment for a term not exceeding 6 months, with or without hard labour. It is made a special offence to bet with any person under 16 years of age; and, if it is proved that any person, whilst committing an offence under the Act, had 'any betting transaction' with a person under 16 years of age, he is to be treated as an offender for the third time, and is liable to the penalties above scheduled.

The Betting and Gambling Bill of 1912 proposed to suppress all gambling advertisements, and betting tips in newspapers and other publications; also all incitements to gambling by means of football coupons and gambling competitions.

Among the Redjang of Sumatra, gambling is prohibited—excepting cock-fights at certain times—under penalty of a fine of \$50, a sum which is also exacted from a householder who permits gambling on his premises. Games of chance are for-

bidden in China; the keeper of a gambling house is liable to punishment, and his establishment is confiscated by the State; while in older Japanese law the gambler appears to have been liable to capital punishment. Islamitic law forbids gambling. On the other hand, gambling agreements were valid in Aztec law if the parties making the agreements were legally competent to enter into compacts of any nature. By early Teutonic law, gambling agreements were legally valid—a situation which changed only by degrees to strict prohibition. See, in general, Post, *Grundriss der ethnolog. Jurisprudenz*, Oldenburg, 1894–95, ii. 412 f., 684 f., and the literature there cited.

5. Ethical bearings of gambling.—That the results of immoderate gambling are deplorable, no one will dispute. But, apart from the effects, it remains to inquire into the morality of the act in itself when kept within bounds. *Usum non tollit abusus*. The economic aspect needs no discussion. Gamblers add nothing to the wealth of the community. They may claim that gambling provides a form of recreation and pleasure which is not only legitimate but helpful, so long as the sums staked are such as a man can afford to lose. But (a) such a contention draws a line of distinction between rich and poor; what is right for the rich man is pronounced wrong in the case of the poor man. (b) The argument implies that the wrongness of gambling consists in losing the moneystaked; it is right, if one wins, because one can afford to win; but it is wrong, if one loses, because one cannot afford to lose. Any argument based on prudential grounds is only an appeal to enlightened self-interest, and the spirit of selfishness cannot cast out selfishness. (c) Though it is in society that the temptation comes, gambling itself is anti-social. It is, as Herbert Spencer says, a kind of action by which pleasure is obtained at the cost of pain to another. The happiness of the winner implies the misery of the loser. This kind of action, therefore, is essentially anti-social; it sears the sympathies, cultivates a hard egoism, and so produces a general deterioration of character. It is a habit intrinsically savage (see his *Ethics*, pt. iii. ch. 7, 'Amusements,' § 227; *Facts and Comments*, 'Essay on Rebarbarisation'). In an atmosphere of brotherhood no form of gambling could exist. In some cases, success appears to depend on superiority of judgment; but this is fallacious. It is never possible to be certain of a result, because all the factors which go to produce that result are not known. When the odds are 4 to 1 on a horse winning a particular race, and these odds are supposed to be 'fair,' the man who accepts the adverse odds does so because he relies upon the unknown factors of the problem; in fact, his appeal is to the unknown and incalculable element in human affairs, which men call chance. The appeal to chance implies a negation of all the nobler powers of man—reason, skill, the sense of justice and responsibility. In the habitual gambler, these higher faculties, through disuse, become atrophied, and his life, out of touch with honest labour, intoxicated by the excitation of his favourite passion, becomes besotted and depraved.

The Christian view of property exacts a still higher standard. Though in relation to his neighbours each man may be regarded as the proprietor of his goods, yet in relation to God he is only a steward. This higher view, by destroying the right of property relatively to God, gives the true basis for its use in the relations between man and man. A man may not claim to do as he likes with his own, because what he possesses is not his own, and he must render exact account for his use of it; he must also respect the property of his neighbours, because it does not belong to his neighbour, but to God, who entrusted him with it.

It has been urged that Herbert Spencer's condemnation applies only to the after effects of gambling, and not always then, because many losers feel no 'pain,' being so well off that they are not affected by the loss of the stake. This is true; but an act must be judged by its general tendency, and not by its effect under specially selected circumstances. It is also urged that what the loser pays for is the pleasure of excitement and anticipation he feels before the wager is decided. This argument will not stand, because the winner experiences an equal pleasure without paying for it—indeed, he receives in addition the forfeited stake.

But the immorality of gambling may be argued on higher grounds than a calculation of pleasure. (a) Every gambling transaction involves a transfer of property in one shape or another. When the gambler is asked why he stakes his money on a game or a race, his reply is, 'To add an interest to the game.' The interest thus added is, simply stated, the interest of acquisition. If the real object were, as is claimed, merely the sport and the excitement, then men might just as well wager counters, or, for the matter of that, agree to hand over all winnings to public charities. But this is not done. The transfer of property, in one shape or another, is essential to the act. There are only three ways in which property can be legitimately acquired—by gift, by labour, and by exchange. Gambling stands outside all of these. (b) Its motive is, however carefully disguised, covetousness. It is an attempt to get property without paying the price for it. It is a violation of the law of equivalents. It is a kind of robbery by mutual agreement; but it is still robbery, just as duelling, which is murder by mutual agreement, is still treated as murder. It is begotten of covetousness; it leads to idleness. (c) It is, moreover, an appeal to chance. If in any contest skill comes in, odds are given or handicaps arranged so as to equalize the chances as far as possible. To make chance the arbiter of conduct is to subvert the moral order and stability of life. (d) It concentrates attention upon lucre, and thereby withdraws attention from worthier objects of life.

Captious analogies have been drawn between gambling in sport and commercial speculation. There is, it is true, a kind of speculation which is merely betting on prices. Men buy or sell cotton or corn for future delivery, without ever intending to handle or distribute the actual commodities, but merely with a view to closing the contract before it is due, and profiting by the fluctuation of prices. A man may buy and sell stocks and shares in the same way. But there is also a commercial speculation which is necessary and legitimate. The merchant has to make provision for a social need, and, in buying ahead, chance must inevitably enter into the calculation. The gambler's business is wholly self-centred; he subserves no need of the community. The merchant's whole policy is to eliminate risk as far as possible. The gambler desires risk. No special legislation has been devised in Great Britain to restrict this commercial speculation; but Chief Baron Palles, in the King's Bench Division Court, Dublin, ruled that in the case of a contract for the purchase of any commodity, whether shares or not, if the real intention of the parties was that the commodity sold should never be delivered, and that the whole price of it should never be paid, but that at some future time the difference in value should be ascertained, and the excess or deficiency paid by one party or the other, then that contract was a gambling transaction, and was void under the Gaming Acts. Legislation to prohibit gambling in 'options' and 'futures' and margins in prices has been attempted

in Switzerland (1881), Canada (1892), Germany (1894 and 1896), Russia (1893-1895), Belgium (1896), Norway (1904), Austria (1903). [See Board of Trade Returns, 1904.] In the same way, it is said that to insure one's life or one's property is to make a bet with the Insurance Company. But the whole object of insurance is the very opposite of the gambler's; it does not create risk, it counteracts the inevitable chances of life, and equalizes them by wide distribution. These risks are ascertainable in their aggregate incidence, though not ascertainable in any individual case. The general effect, therefore, of insurance is to add to the stability of life. The general effect of gambling is to destroy that stability.

LITERATURE.—*Report of Select Committee on Betting*, London, 1902; J. M. Hogge, *Facts of Gambling*, do. 1904; B. S. Rowntree, *Betting and Gambling*, do. 1905; J. Percival, 'Speculation,' in *Church Congress Report*, 1904; W. D. Mackenzie, *Ethics of Gambling*, London, 1905; C. Booth, *Life and Labour of the People in London*, do. 1889-97, see Index; Ainslie Robertson, *Football Betting* (and other pamphlets), National Anti-gambling League, York. The effect of Gambling on character is studied in various novels: Walter Scott, *Fortunes of Nigel*; W. M. Thackeray, *Virginians*; H. Fielding, *Amelia*; R. L. Stevenson, *Kidnapped*; A. Colbeck, *The Fall of the Staincliffes*; G. Moore, *Esther Waters*.

On the question of commercial speculation, see S. J. Chapman, *Transactions of the Statistical Society*, June 1906; also art. 'Cotton,' in *EBR*¹¹, 'Marketing and Supply.'

J. L. PATON.

GAMES.—1. Definition and classification.—A game is an organized occupation, undertaken by two or more persons, the primary intention of which is not utility but pleasure or pastime by means of the exhibition of the skill or good fortune of the players. It proceeds according to definite rules, and sometimes necessitates special instruments or apparatus. Games may be broadly divided into three classes—games of skill, games of chance, and games of imitation. The rules of games of skill are framed to bring out the various qualities, physical, mental, or moral—strength, agility, quickness of the senses, rapidity of calculation and induction, endurance, patience, and so on—of the players. Games of chance, on the other hand, regard only the luck of the players, and are decided by events, such as the fall of dice, over which they have no control. The rules, therefore, are arbitrary conventions, designed to emphasize coincidences. Many games combine the elements of chance and skill in varying proportions. In games of imitation the rules are prescribed by the actions to be imitated—limited, however, by certain conventions appropriate to the circumstances of the players; and the result is measured by the verisimilitude of the performance as thus limited. Such games involve the germ of Drama (*q.v.*). Both in games of chance and in those of skill there is a contest. In games of imitation there is often little or none; and the pleasure sought is attained by co-operation, rhythmic movements, and song.

Games as thus defined are social institutions, owing their origin to the inherent restlessness of human beings and the necessity for constant use and practice in order to the development and preservation of their physical, mental, and moral powers. They enter very early into the life of the individual, and are of incalculable value in the training of children for the graver pursuits of adult years. To the adult—especially the adult savage—they are little less important; and from the lowest plane of culture upwards, games, either in the form of contest or of rhythmic movement (dances), are among the commonest activities.

2. Ceremonial (religious and magical) significance; origins.—Like other human institutions, games have grown from vague and undefined beginnings. Their vague beginnings contained also the germs of ritual, dance, and song. It is but gradually that they have been differentiated from

these; even yet, as we shall see, complete separation has not been achieved. Games of imitation bear obvious witness to this origin. It is impossible (the observation is trite) to watch the games of children, whether savage or civilized, without being struck by the fact, on the one hand, that ceremonies are the favourite subject of imitation, and, on the other hand, that rhythmical movement and the utterance of a set form of words, rhythmical also and married to musical notes, are essential features. In the game of 'Jenny Jones,' common throughout England, Scotland, and Ireland, for instance, the ritual of courting, death, and burial is the subject; while in some places the game becomes a regular drama, which ends with the restoration of the heroine to life, or her reappearance as a ghost, to the pretended terror of her companions. The dialogue is throughout sung to a tune. Nor is the distinction between ritual and games everywhere clear even in the case of adults.

'It is not altogether easy,' remarks Rivers (*Todas*, London, 1906, p. 596), 'to draw the line between Toda games and Toda ceremonies.' Among the Eskimo it is usual, when a stranger comes to a settlement, to receive him with a feast. In the south-eastern tribes of the Central Eskimo 'the natives arrange themselves in a row, one man standing in front of it. The stranger approaches slowly, his arms folded and his head inclined toward the right side. Then the native strikes him with all his strength on the right (*sic!* left?) cheek and in his turn inclines his head awaiting the stranger's blow. While this is going on the other men are playing at ball and singing; and thus they continue until one of the combatants is vanquished.' Among other proceedings a wrestling match and the game of 'hook and crook' are recorded as played by various tribes. The latter is a trial of strength, at which the victor has even the right to kill his opponent; but generally, we are told, the feast ends peaceably. The account given by the Eskimo themselves is that 'the two men in meeting wish to know which of them is the better man' (Boas, *6 RBEW* [1888], 609).

Here we have contests of strength and skill, which possibly, as Frazer suggests (*GB*³ iii. ['Taboo'], 1911, p. 108), have a magical significance, which in any case are ceremonial, yet which appear to be regarded by the people themselves as not entirely serious, but games leading up to a hospitable entertainment.

Many nations, in fact, play ceremonial games. These games, though the element of pleasure is large, are essentially rites of religious or magical import. Either the aborigines of America are specially addicted to such performances, or our information is unusually full on the subject of their games. The Zuni inhabit an arid tract of country in New Mexico. Rain is a prime necessity of life; but it comes rarely, and the droughts are long. The object of the games the Zuni play is, therefore, the bringing of rain, that their crops may grow. We read of races, ball games, games of chance played with split reeds corresponding to our dice, round games, and others.

Sholive, a game of chance, was esteemed by the rain-priests so efficacious in bringing rain that 'they organized a fraternity which they called *Showekwe* ("Arrow-reed people"), for the express purpose of playing the game for rain.' The fraternity in question has now degenerated into a body of professional gamblers; 'but the game is still played by the priests and others in all credence for rain' (*25 RBEW* [1904], 328 ff.).

The Omaha, a Siouan tribe dwelling in what is now the State of Nebraska, whither it had migrated, according to tribal traditions, from the east, was divided into two sections called the 'sky-people' and the 'earth-people.' The ten *gentes* of which the tribe was composed were distributed between these two sections. In their ceremonial encampments they were ranged in a circle with the entrance to the east, the earth-people on the southern side, and the sky-people on the northern. 'In former times a ball game used to be ceremonially played between the young men of the two divisions.' It was the duty of a member of the Wind sub-gens of the Konçe gens (one of the earth-people) to start the ball. A circle with two lines crossing each other at right angles towards the points of the compass was drawn on the ground,

and the ball was placed at the centre. It was first rolled towards the north along the line drawn from the centre to the edge of the circle, and then back on the same line to the centre. It was then rolled in a similar way successively towards the east, south, and west, and back. On returning to the centre from the west, it was tossed into the air, and the game proper began. 'The game is said to have had a cosmic significance, and the initial movements of the ball referred to the winds, the bringers of life. It was played by the two divisions of the *huthuga* [tribal circle] as representatives of the earth and the sky' (27 *RBEW* [1911], 198). But we are not told what, if any, significance attached to the victory. The Wichita, a tribe of the Caddoan stock settled on the Red River in Oklahoma, however, played a game of shinny, which beyond all reasonable doubt represented the contest of winter and spring, and was played in the spring, doubtless for the purpose of assisting by magical means in the conquest of the evil power of winter and the renewal of life. Tradition declared that it was originally played by Afterbirth-boy and his brother, two mythical heroes of the tribe, against a headless monster, who used a black shinny-stick and black ball; and the stakes were the lives of the players. The tribal heroes tried to stipulate for the use of their ball, which was green; but the monster refused. So they knocked his ball to pieces, and thus compelled the use of their own. With it they succeeded in winning the game, and the monster was put to death. They played with green sticks as well as a green ball, representing, we are expressly told, the spring of the year. 'Since that time the shinny game is played in the spring, under the power of Afterbirth-boy' (Dorsey, *Myth. of the Wichita*, Washington, 1904, p. 99). The Central Eskimo play a game resembling cup and ball, in the spring, to hasten the return of the sun. In the autumn, on the other hand, when the sun is going southward, they play cat's cradle to catch the sun in the meshes of the string and prevent his disappearance (*Bull. Am. Mus. Nat. Hist.* xv. [1901-7] 151, 422). The Kai of German New Guinea also play cat's cradle ceremonially, but for a different purpose. It is played after the yams are set, that their foliage may sprout luxuriantly and may become green and spread widely. Every figure in the game has its name (Neuhauss, *Deutsch Neu-Guinea*, Berlin, 1911, iii. 125, 256).

Indeed, wherever we find games played at a special season of the year, we may suspect that now, or at one time, they have, or had, a ritual value. In our own island the game of football, though doubtless not unknown at other times, used to be regarded as proper to Shrovetide. Sometimes it was played between two rival parishes. More usually, as in the parish of Scone, Perthshire, it took the form of a match between married and unmarried men. In the parish of Inveresk, in the county of Midlothian, it was reported in the latter years of the 18th cent. that 'on Shrove-Tuesday there is a standing match at Foot-ball between the married and unmarried women, in which the former are always victors' (Brand and Ellis, *Pop. Antiq.*, London, 1813, i. 76), quoting *Statist. Acc. of Scotland*, Edinburgh, 1795, xvi. 19). This implies that the victory of the married women was pre-arranged, and consequently that the game was not a real contest, but rather a piece of ritual. The object of the game was probably, like that of the shinny played by the Wichita, to aid in the conquest of winter by spring. The unmarried men and women represent the barren winter, and the married men and women the fruitful season ushered in by the spring. A similar ball-game, sometimes analogous to our football, sometimes to our hockey, is widely

played in Algeria in the spring. It is called *koura*. In Morocco it is equally prevalent; but in many districts it is reserved to the *tolba*, or those learned in the Muhammadan law; and, even where not so reserved, the *tolba* often play apart or in a special manner. Though played more particularly in spring, in case of persistent drought games of *koura* are organized, the playing of which is believed, at Miliiana, Laghouat, and other places, to bring the rain (Doutté, *Magie et relig. dans l'Afr. du Nord*, Algiers, 1910, p. 554).

As an example of a ceremonial game of another kind, mention may be made of that played by the Khāsi, a hill-tribe of Assam, for the purpose of expelling demons.

'The ceremony takes place in a fixed month of the year, and part of it consists in a struggle between two bands of men who stand on opposite sides of a stream, each side tugging at the end of a rope which is stretched across the water' (Frazer, *GB*², 1900, iii. 95).

This is what we call 'the tug of war.' Frazer (citing Bastian) suggests that the men on one side represent the demons. Comparison, however, with the ceremony as practised by the related tribe of the Syntengs, at their annual festival for driving away disease, renders it doubtful whether this explanation quite hits the mark. The Syntengs first cut down long poles, and, holding them across the stream where the goddess Aitan dwells, jump on them to break them. A pole is then fixed across the stream, and the players divide into two parties contending for its possession. The successful party is supposed to gain health and prosperity for the coming year (P. R. T. Gurdon, *The Khasis*, London, 1907, p. 157). The contestants thus appear to be purely human, striving for superiority in luck. The tug of war is applied in the Tanembar and Timorlaut archipelagoes in the Moluccas as a rain-charm whenever the westerly monsoon comes in without a fall of rain. Hymns are sung to Dudilaa, the male principle resident in the sun, for rain. The assembly then divides into two parties—those of the eastern side of the village, and those of the western side. The rope is a rattan of about 30 metres in length. Men, women, and children all join and pull with all their strength. Those of the eastern side must, we are told, put forth more strength than those of the western, as if to draw forth the west wind which brings the rain (Riedel, *Sluik- en kroesharige rassen*, Hague, 1886, p. 282). (Cf. the Burmese game, *ERE* iii. 26.) The same game is, in fact, played for analogous purposes in both Eastern and Western hemispheres.

In many of these half-serious contests clan is pitted against clan, or community against community. Numerous examples are found in N. America; the Omaha game has already been cited. By no means all of them are regarded as having any magical influence—at least, if our information be complete. In California a game resembling shinny is played by the Hupa, village against village, 'or tribe against tribe.' It seems to have no greater result than our football or cricket played between team and team (Goddard, *Life and Culture of the Hupa*, Berkeley, 1903, p. 60; cf. pp. 149, 214). Such cases are to be found all over the world, in Great Britain as well as elsewhere; and every reader's memory will furnish him with illustrations. The games so played may take their origin from racial or tribal distinctions; they may be relics of old enmities; or they may be magical ceremonies. The facts are usually so blurred by the process of time and the progress of civilization that it is impossible to read their primitive meaning. One thing only stands out clearly: the game is something more than a game; it is a ritual, the recurrence of which at stated seasons is imposed on the rival social units by force of custom and tradition, though its real meaning has been lost.

Games consecrated to special seasons are very common. In addition to those already mentioned, a few other typical instances may be adduced. In the south-west of England it is common to play thread-the-needle all down the street on Shrove Tuesday, or, in some places, on Easter Monday. There can be little doubt that it once had a religious or magical significance. Syrian and Armenian immigrants at Boston have been found addicted to a game with eggs at Easter. It is played by two persons, each having an egg. One holds his egg, and the other player strikes with his. The game is a contest similar in principle to those which boys play in England with chestnuts (*JAF* xii. [1899] 107, xvi. [1903] 138). At the solemn harvest festival of the Natchez a game of ball was played for a prize by two parties, each estimated by an eye-witness on one occasion at 800 men (Swanton, *Bull.* 43 *BE*, 117, 119, citing du Pratz and Dumont). By way of concluding the Green Corn, the Harvest, and the New Year festivals, the Iroquois used to play in the public council-house a betting game with a bowl and peach-stones, in which the peach-stones were dice (Culin, 24 *RBEW* [1907], 114). The Tigua of New Mexico also played a game with a species of dice all night on 'the day of the dead,' Nov. 3 (*ib.* 195). There appears to be no tradition recording its connexion with the day. Its meaning must probably be sought among the rites celebrated for the benefit of the departed. When the crops are ripe, the A-Kamba of British East Africa meet, hold dances, and play *mutingwano*, a game somewhat like what we call knuckle-bones or dibs (Hobley, *Ethnol. of A-Kamba*, Cambridge, 1910, p. 55). Among the Valans, a fishing caste of Cochin, the adult girls play a swinging game on the Thiruvathira festival in Dhanu, the month corresponding to our Dec.-Jan. (Anantha Krishna, *Cochin Tribes and Castes*, Madras, 1909, i. 257). At an early date after the accession of a new king of the Baganda, he paid a ceremonial visit to Nankere, a chief of the Lung-fish clan, who was never permitted to see the king on any other occasion. The object of the visit was the performance of a rite to prolong the king's life. This involved the putting to a cruel death of Nankere's son. The king then went to another chief. On the way he stopped to play a game of spinning the stones of a wild fruit-tree. It is played ordinarily by two children, who spin their stones together, and the stone that strikes the other and knocks it down is called the winner. The king played with one of his attendants; and on reaching the chief's house he played with him. The next morning he would again call for fruit-stones to play the game; but 'whoever ran to bring them would be caught and speared to death on the spot, with the object of giving the king long life' (Roscoe, *Baganda*, London, 1911, p. 210 ff.). Here the game is not played at a definite season of the year, but in connexion with the king's accession, and as one of the rites to procure him a long life. Funeral games have been discussed in art. *DEATH AND DISPOSAL OF THE DEAD*, vol. iv. p. 437.

To games a Divine origin has sometimes been ascribed. Thus the Olympic games were variously attributed to the Idæan Herakles or to Zeus himself, who was said to have wrestled at Olympia with Kronos, or to have instituted the games to celebrate his victory (Pausan. v. 7. 4). Whether the divinity in such a case was held to have invented or first taught the specific games, or whether he merely appointed the occasion on which they were to be played, may be arguable. In the belief of many of the N. American tribes they were indebted for the games themselves, as well as for the occasion, to Divine or quasi-Divine beings. The

Micmacs ascribe the invention of one of their dice-games to their hero Glooscap, and of another to one of his supernatural companions (24 *RBEW*, 76). The Wichita game of shinny was first taught to the people by one of their mythological characters; and, as we have already seen, it is played in a special fashion in the early spring, in accordance with the example and 'under the power of' another, for the purpose of accelerating the revival of Nature and the victory of vegetation. Other examples might easily be adduced.

3. Ritual surviving as amusement.—But, even if held to be of Divine origin, and though played for ceremonial purposes, games fall back into mere amusement, or are abandoned to children, when the stage of civilization proper to such beliefs or to such purposes is passed, or under the influence of the overmastering desire for excitement in gambling. Thus several of the games of British children have been conjectured by Lady Gomme to owe their origin to religious or magical rites, and others have been shown by her to be degenerate representations of ancient social customs and conditions. The game of London Bridge, in which two of the children hold up their hands to form an arch, and the others pass below it in long line holding one another's waists, 'remains unexplained by any appeal to modern life.' The children all sing a rhyme beginning, 'London Bridge is broken down,' and going on to inquire 'How shall we build it up again?' Silver and gold, iron and steel, wood and clay, and other materials, according to the version, are mentioned only to be rejected. Finally the arms of the two children forming an arch fall down on the string of players as they pass beneath; the last one is captured struggling, and thenceforth stands out of the game. This is interpreted as a reminiscence of the foundation sacrifice (see art. *BRIDGE*, vol. ii. p. 850 ff., and *FOUNDATION*, vol. vi. p. 112). The refrain of the song, which has usually to do with 'a gay lady,' seems to render the interpretation fairly certain (Lady Gomme, *Traditional Games*, i. 333; Haddon, *Study of Man*, 347 ff.). The game of 'Eller Tree' is one of several in which one of the children represents a tree, and a tree is the subject of the song. The children all take hands singing, and wind round the 'tree.' Usually it ends with a rough and tumble; but in at least one case the string of players unwinds, under the direction of youths with long leafy branches in their hands as standards; and the operation is said to be performed 'with almost military precision.' As thus played it is performed at St. Roche and some of the adjacent parishes in Cornwall, at the annual feast in the second week of June (Lady Gomme, ii. 386). Lady Gomme refers it to 'some religious observance, such as encircling sacred trees or stones, accompanied by song and dance.' Again, many games turn on love and marriage, and some of them doubtless enshrine archaic ritual, such as bride-capture. One of the most striking of these is called in Scotland 'Babbity Bowster' (Dance with the bolster). There is evidence that it actually used to be the last dance at weddings and merry-makings. Lady Gomme's conjecture is probably right that it was pre-eminently the nuptial dance at a wedding, and that the bride and bridegroom on performing their part in it retired from the company to their own chamber. But, if so, it was even then the degenerate representative of a rite by which the bridegroom took forcible possession of his bride in spite of her real or pretended reluctance (*op. cit.* i. 9, ii. 486).

Nor is it only in Britain that the process is found. Sicilian boys also play a game called *A vola vola lu mortu*, in which one of them feigns death and lies stretched on the ground, another

stands at his head as a magician and utters incantations to restore him to life, four others stand round him and, with a low continuous whistle made by drawing in the breath, extend their hands above the corpse, gradually raising them with a slow movement. The game is to keep up this movement and whistling while the incantation is repeated seven times without interruption by the magician. It is said to be the children's firm belief that in this way the corpse becomes as light as a feather, and that he ought to be able to raise himself in the air and there remain suspended so long as the whistling proceeds, but that with any interruption for the purpose of taking breath by those who perform the spell, he again becomes heavy and falls. The game, begun with more or less solemnity and secret terror, frequently ends with some trick upon the corpse, and laughter, or blows, and a quarrel (Pitrè, *Bibl. Trad. Pop. Sicil.* xiii. 263). But probably one of the most convincing examples is a game played by the children in Java. It presents the conjuring of a spirit, called Nini Towong, belonging to the ancient Javanese mythology, into a puppet, and its cult with prayers for help and protection. The serious worship of Nini Towong has ceased; the significance of the ceremony is no longer understood by the people; and the ceremony itself has become degraded to a puerile amusement (*ARW* vii. [Leipzig, 1904] 512).

Before quitting the subject, it may be observed that the bull-roarer (*q.v.*), one of the most sacred religious implements of the lower savagery, employed to produce sounds which the uninitiated are taught are the voice of a supernatural being, and carefully concealed at all times from the sight of women, suffers the same fate as society passes away from the stage of civilization which gave rise to its ceremonial use. Among the Bangala of the Upper Congo there is still, on the part of the elders, some aversion to its use as a plaything, while among the Kikuyu of British East Africa, as among ourselves, it is purely a toy (*JRAI* xl. [1910] 427, 446).

Games of chance are usually played with instruments of the kind familiar to us as playing-cards and dice. In more barbarous states of culture the instruments are the stones of fruits, pebbles, shells, split reeds, and so forth, marked in different ways. They are drawn from a promiscuous heap, or tossed in the air and allowed to fall on the ground or on some other flat surface. According as they fall (or are drawn) the player scores. This process is precisely the same as that by which divination is practised and auguries obtained in almost all parts of the world. Indeed, the very instruments used are the same, even in Europe, where fortune-tellers habitually exercise their profession by means of playing-cards. There is, therefore, a very large body of evidence in favour of Tylor's theory that the primary purpose of the appeal to chance was augury, and that games with the same or similar instruments are secondary. Many American tribes employ games of chance as well as games of skill for divinatory objects. One example may stand for all. The Onondaga play with peach-stones tossed up from a bowl or dish struck on the floor. It is common at the New Year's, or White Dog, feast.

'Clan plays against clan, the Long House against the Short House, and to foretell the harvest the women play against the men. If the men win, the ears of corn will be long like them; but, if the women gain the game, they will be short, basing the results on the common proportion of the sexes.'

This game is said to be intensely exciting. It was once much used in divination. It is, like other games, also still played for the sick; but, whereas it was formerly supposed to be a means of healing, it is now regarded more as a diversion of the patient's mind. In fact, it is ordinarily at the

present time a merely social amusement (*JAFI* ix. [1896] 270), though specially played for divination at the New Year's feast.

In India, where, as has been shown in the art. GAMBLING, dicing was carried to extremes, the casting of dice was employed not merely to divine the future, as is exemplified by the Skr. *Pāsaka-kevali* (ed. Weber, *MBAW*, 1859, pp. 158-180, Schröter, Borna, 1900; tr. Weber, *Ind. Streifen*, i. [1868] 286-307), but also as a part of the ritual of the kindling of the *sabhyāgni*, or 'fire of the assembly-house' (it is highly significant in this connexion that *sabhā* means especially an assembly-house for gamblers), which formed a portion of the *agnyādheya*, or setting up of the sacred fire.

According to the *Āpastamba Grhyasūtra*, v. xix. 2 f., a gambling table was set in the midst of the *sabhā* and sprinkled. Dice were thrown on the table, and gold was cast on them, and all were mixed up and then spread out; after two sacrifices had been made, the dice (100 in number) were given to the sacrificer with the words, 'Play for the cow against the rice,' etc. (see Hillebrandt, *Rituallitt.* [*GIAP* iii. (1897) 2], p. 108, *Ved. Mythol.*, Bonn, 1891-1902, ii. 119-121). It is plausibly suggested by von Schroeder (*Mysterium und Mimus im Rigveda*, Leipzig, 1908, p. 385) that the famous 'gambling hymn' of the *Rigveda* (x. 34) is intended for this portion of the ritual; and Hillebrandt holds, with good reason, that this ritual gambling was 'probably the survival of an old dice oracle connected with the new moon' (*Rit.* 106). In the ceremonial of *rājāsūya*, or consecration of a king, ritual gambling is an important feature. Here the dice are cast on gold, with the injunction that, 'vying with the sun's rays, they make the king become the firm centre of the people'; and later on in the *rājāsūya* a second game of dice of minor importance is played (Hillebrandt, *Rit.* 146).

A large number of children's games are either themselves used for divination or contain divinatory formulæ. This is especially noticeable in the 'counting-out,' which is preliminary to many games. By the process of 'counting-out' it is determined who is to take a certain part in the game. Simple though it generally is, the number of children concerned and the positions they take in the counting series are so variable that to the players, who do not stop to calculate seriously, the result seems a chance. Nor is it only the counting-out formulæ that betray a divinatory origin; games of skill are often referable to the same source. Lady Gomme assigns various ball-games (including cricket) to this source, and Pitrè reckons no fewer than sixty games of Sicilian children, or one-third of the entire collection he has made, as based upon 'the sacred processes of divination' (*op. cit.* xxxv.).

4. Prizes and stakes: gambling.—The winning of games, whether of chance or skill, is among all nations frequently rewarded with prizes. By an easy and natural gradation the prize passes into the bet, and games are played for stakes. This enhances the excitement, and, therefore, the pleasure of a game. Gambling is a passion confined to no race or country, to no rank of society, to no plane of civilization. The savage hunter is as much addicted to it in his hours of ease as the civilized stockbroker or horse-racer in his hours of business. No peoples were ever more passionate gamblers than the N. American Indians, both men and women. Throughout the length and breadth of the great continent they occupied, gambling was the favourite pastime. They betted on their games of chance, they betted on their games of skill, they betted on their most solemn ceremonial games. They even ascribed to gambling a Divine origin, and believed that it was the common occupation of the departed in the spirit-world. We may expect to find that so wide-spread a passion as gambling originated in very early times. The famous deposit of painted pebbles in the cave of Mas d'Azil may be conjectured to yield evidence pointing in this direction. If so, something more than a respectable antiquity may be claimed for the practice. For hardly had the Ice Age and the reindeer disappeared when the men of the south of France were

preparing their rude dice or counters, and enjoying the excitement of staking the produce of their more serious activities on games of chance. Certain it is that those of the pebbles that represent numbers must have been painted with some end in view other than an introduction into the mysteries of the higher mathematics (*L'Anthropologie*, vii. [Paris, 1896] 385, and the accompanying atlas of plates).

Gamblers are proverbially superstitious folk. Every gambler has his amulet or his prescribed observance, on which he depends for his luck. In this he does but emphasize a more general habit. But the emphasis is probably the natural product of his dependence on chance in his favourite amusement. Everywhere in N. America gambling is the subject of practices which are not merely superstitious—that is, performed with an unreasoned expectation of benefit—but distinctly religious. The gambler fasts and prays, he seeks supernatural aid in dreams, he observes continence, he burns tobacco in honour of his *manitou*. Where the interest or the glory of a village or tribe is at stake, the whole community join in a religious ceremony. Fetishes ('medicine'), of course, are universal. The intimate connexion of gambling with ceremonial games already alluded to may be thought to be responsible for such a development. The N. American Indians, however, are by no means singular in seeking supernatural aid for victory in their games. To take only a single instance—the Fijians play a game of skill called *tiga*. It consists in throwing along a course a ball with a pointed end like the head of an eel, and a tail formed of a reed one metre in length. It is played by two sides, often two villages or two tribes, and causes much excitement. Before playing, the Fijian weeds the graves of his ancestors and offers sacrifice to their *manes*, to render them propitious. The stakes are a feast of pork, which the losing party gives to the victors (*Anthropos*, vi. [1911] 476).

Almost everywhere games have been played for stakes involving the entire possessions of the players, their wives and children, their freedom, their life itself. Not many years ago a Cheyenne, having lost all his property, put up his sister as the stake in a game of cards. He lost her. Though the occurrence aroused great indignation throughout the tribe, nobody suggested that the unfortunate girl should not go and live as the wife of the man who had won her (*JAFI* xi. [1898] 301). This is a modern instance of an event which has formed the basis of many a folk-tale east and west. In Irish legend, Mider, the fairy chief, plays with king Eochaid Airem for his queen Étaín. In the great Indian epic of the *Mahābhārata*, Yudhiṣṭhira loses to Śakuni all his property, and finally Draupadī, the joint wife of the five brethren. In a Korean tale the hero is made to play chess for his bride (*JAFI* x. [1897] 291). The incident of playing for life or freedom is also common in folk-tales. A greater stake still—that of future happiness—is occasionally represented in European tales. A supernatural monk is said to haunt the *mielles* (dunes) of Normandy and play with passers-by for their souls (*RTP* xii. [1897] 304, quoting Souvestre, *Les Derniers paysans*, Paris, 1852, p. 79). More remarkable still is a dramatic ceremony annually performed at Lhasa for casting out the demon of ill-luck. In the course of the performance the Grand Lama is represented playing at dice with the demon, to prove the truth of his teaching. But the dice are false: the Lama can throw nothing but sixes, the demon nothing but ones. Consequently the demon is hopelessly beaten and chased away, to the no small amusement, comfort, and edification of the faithful (Waddell, *Buddhism of Tibet*, London, 1895, p. 512).

In view of the grave evils undoubtedly entailed on society by the practice of gambling, it may not be deemed impertinent to call attention to its utility at an early stage of culture. This can hardly be better done than in the words of the accomplished author of the *History of the New World called America*, whose untimely death a few years ago left the great work he had projected and partially executed no more than a precious fragment. He says:

'From invoking the decision of chance [by divination] as to whether a hunting expedition shall be undertaken, and who shall take part in it, the transition is easy to the distribution of its produce by this method; gaming does but extend the same process to the distribution of property in general between man and man. Gaming, as it develops, involves number in three different ways. Number enters (1) into the system and implements used in the game, (2) into the mode of scoring, and (3) into the reckoning of the stakes or forfeits; and, as gaming is the natural pastime of barbarism, it may fairly be assumed to have been a powerful factor in the development of arithmetic. The same counters and the same tables serve as the instruments of gaming and of ordinary calculations; in Mexico, as in Europe, calculation generally and some favourite game of chance bore the same name' (Payne, *Hist. Amer.*, Oxford, 1892-99, ii. 279).

See, further, art. GAMBLING.

LITERATURE.—On games in general, E. B. Tylor, art. 'The History of Games,' in *Fortnightly Rev.*, May, 1879; A. C. Haddon, *Study of Man*, London, 1898, chs. viii.-xv. On games of chance and some other games: Tylor, *Primitive Culture*, London, 1872 [⁴1903], i. 65-76, and *JAI* viii. [1879] 116-131, ix. [1880] 23-30 (it must, however, be stated that the illustrious author's conclusions as to derivation of the Mexican game of *patolli* from the Hindu game of *pachisi* are by no means generally accepted). On games of special areas: A. B. Gomme, *Traditional Games of England, Scotland, and Ireland*, 2 vols., London, 1894, 1898; W. W. Newell, *Games and Songs of American Children*, new ed., New York, 1903; G. Pitre, *Biblioteca delle Trad. pop. Siciliane*, xlii. 'Giocchi fanciulleschi Sicil.', Palermo, 1883; S. Culin, *cf. RBEW*, 1907, 'Games of the N. Amer. Indians'; E. Falkener, *Games ancient and oriental, and how to play them*, London, 1892.

E. SIDNEY HARTLAND.

GAMES (Hebrew and Jewish).—For the purpose of the present article it will be convenient to divide the entire range of Hebrew-Jewish history into Biblical, Talmudical, and post-Talmudical times, the Biblical period extending, roughly speaking, to the age of the Maccabæan rising; the Talmudical commencing at the epoch just named, and ending about A.D. 500; and the post-Talmudical reaching down to the present day.

1. In Biblical times.—The games and other amusements that were prevalent among the ancient Hebrews could not have been prominently bound up with the popular cult and the moral habits of the race; otherwise the authors and compilers of the Hebrew Scriptures, who were guided throughout by a religious and ethical purpose, would naturally have introduced, with more or less frequency, some detailed references to these pastimes and recreations of their countrymen. The games and diversions indulged in were merely, as for the most part they are everywhere now, so many ways of recruiting strength and whiling away an idle hour in a pleasant and attractive manner; and all that can be found in the OT on these matters consists of some general references and a number of more or less definite allusions to certain amusements and sports that were in vogue among the Hebrews of those days. Our task, therefore, in this part of the article is to collect the extant data in some orderly and serviceable manner.

The Hebrew verbs expressing something approximate to our idea of playing games and engaging in other social diversions are *pnw* and its synonym *pnx* (infin. *sahēk*, *ṣahēk*). The use of the last-named form in Ex 32^d (in connexion with the rejoicing at the making of the golden calf) is quite indefinite, and may possibly be best translated by 'to make merry.' But quite definite is the mention of a kind of tournament (or possibly best described as a game-of-war) in 2 S 2¹²⁻¹⁶, where the verb *pnw* is employed. Abner said to Joab: 'Let the young

men arise and play before us,' and there seems to be no reason to doubt that a mere soldierly trial of skill and strength¹ was originally intended, and not a prelude to a battle on a large scale, although the hostile passions which were aroused by it quickly led to a disastrous result.

Other exercises requiring the employment of physical strength or skill mentioned or alluded to in the OT are *the lifting of stones* (Zec 12⁹), *slinging stones* (e.g. Jg 20¹⁶, 1 S 17⁴⁰, ⁴², ⁵⁰, Zec 9¹⁵), *ball-games* (Is 22¹⁸, where—judging from the later use of the word, as can be seen from the Rabbinical dictionaries—the term for ball is כּוּרִי, and not כּוּרִי), *archery* (1 S 20^{30a}, Job 16¹², La 3¹²), *racing* (Ps 19⁶ [EV 19⁵], 2 S 1²³ 2¹⁸), and *jumping* (Ps 18³⁰ [EV 18²⁹]). One may also assume that the way in which Samson had to amuse the assembled Philistines at Gaza (Jg 16²⁵, where both the roots נָחַק and נָחַק are used) was by exhibiting feats of physical strength. More popular than any other kind of physical exercise was naturally *dancing*. A reference to children's dances is found in Job 21¹¹, and to that of adults on various occasions—e.g. Jg 21²¹ ('the daughters of Shiloh' to be captured, whilst dancing, as wives by the Benjamites), 1 S 18⁶ (the women saluting Saul and the victorious David), 2 S 6¹⁴ (David dancing before the ark).

With regard to the amusements of children, there is, besides the mention of dances already referred to, the significant fact that in Zec 8⁵ the vision of happiness in a restored and prosperous Jerusalem is made complete by the picture of boys and girls playing in its streets. The kinds of games indulged in are not mentioned, but one may safely fill in the canvas with frolicsome dances, racing, a primitive and quite innocent form of dice (see E. Sellin, 'Tell Ta'annek,' *DWAW*, vol. 1. [1904] p. 112), and diminutive terra-cotta figures of horses, dogs, and other animals (see H. J. Van Lennep, *Bible Lands*, London, 1875, p. 573 ff.). It is also possible that there is a reference to character displaying itself in children's games in Pr 20¹¹ ('even in his doings does a child make himself known, whether his work be pure, or whether it be right'). Another interesting though very vague reference to the diversions of young people is that contained in Job 40²⁹ (EV 41⁵): 'Wilt thou play with him (i.e. Leviathan) as with a bird? or wilt thou bind him for (or unto) thy maidens?'² The vagueness of these two forms of amusement is in no way diminished by a reference to Ps 104²⁶ and Bar 3¹⁷ ('They that had their pastime with the fowls of the air').³

Instrumental music would naturally accompany dancing. Vocal music (and, of course, instrumental also) is, as may be expected, mostly referred to in the OT in connexion with religious services; but there are also a few passages relating to purposes of amusement, so particularly the 'men singers and women singers' spoken of in 2 S 19³⁵ [EV 19³⁵] and Ec 2⁸.

As for amusement by means of *dramatic performances*, it is difficult to say to what extent—if at all—the ancient Hebrews engaged in it; but it is certain that their imaginative talent was lyrical rather than dramatic. If, indeed, the Song of Songs and the Book of Job are to be regarded as

¹ Thus, e.g., Solomon Yishāki (known as Rashi): כּוּרִי נָחַק ('by way of amusement'). H. P. Smith, *ICC*, *in loco*, remarks that the verb is 'used nowhere else of fighting'; but this consideration is alone sufficient to decide one against his opinion 'that the proposition was to have a combat of picked men as a prelude to the main battle.'

² Most commentators quote in illustration of this from Catullus, ll. 1, *Passer delicias meae puellae* (Gibson, *Oxf. Com.*, *in loco*).

³ In the *Variorum Apocrypha*, O. J. Ball, *in loco*, refers for comparison to 'the hunting scenes of Assyrian sculptures, and the tributes of rare and curious foreign animals depicted and recorded on such monuments as the obelisk of Shalmaneser.'

compositions of a more or less dramatic character, these great literary works would themselves justify the proposition just indicated; for it is in their lyrical element and vivid impressionism that their greatness consists rather than in elaborate dramatic representation.

The proposing and solving of riddles (חִידָה, חִידוֹת) as an intellectual pastime finds an illustration in Jg 14^{12a}. (Samson's riddle). The riddles proposed to Solomon by the Queen of Sheba (1 K 10¹) are not specified in the Biblical text, though the elaboration contained in later Jewish writings¹ may possibly embody some early amplifications. Akin to riddles proper is a certain kind of *māshāl* (simile), as exemplified in Ezk 17^{2a}. It has also been supposed that riddles lay originally at the base of Pr 30^{15a}.

2. In the Talmudical period.—As the ancient Hebrews do not appear to have been addicted to games of chance,² one may assume that such games were adopted by them from their neighbours during the Greek and Roman overlordship in Palestine and the adjacent countries. In agreement with this supposition is the fact that ethical considerations in relation to games are first met with in Talmudical times. The Mishna declares in two different places (*Rōsh hash-Shānāh*, i. 8; *Sanh.* iii. 3) that dice-players and participants in pigeon-racing are disqualified to act as witnesses in a court of justice. The principle underlying the enactment is that the winner is, in the Rabbinic sense of the term, guilty of robbery, and that, therefore, the mere act of participation is tantamount to engaging in a criminal act. The general designation of dice in all its varieties is קוּבִיא (κυβητα). In modern works פּוּסִים (ψηφος, ψηφίς) is often spoken of as another game of chance lying under the same condemnation, but it is in reality merely the principal variety of קוּבִיא, other varieties named in *Sanh.* 25b being nut-shells and pieces of orange peel, each of these objects having been used in a manner analogous to the throw of dice as known in modern days. The participants in pigeon-racing are called כּפּוּרִי יוֹנִים, but it is explained in the same passage of *Sanh.* that racing on a similar principle carried on with חֵרֶף הַיָּדוּמָה (domesticated quadruped, wild quadruped, and any kind of bird) involves the same disabilities on its participants.

The introduction of Greek athletic games into Jerusalem about 170 B.C. is recorded in 1 Mac 1¹⁴ and 2 Mac 4⁹⁻¹⁵. 'A place of exercise' (gymnasium) was built 'according to the customs of the heathen' close to the Temple, where men and boys forthwith ardently engaged in wrestling, boxing, archery, swimming, and other exercises; and 'such was,' according to the account given in 2 Mac., 'the height of Greek fashions, and increase of heathenish manners, . . . that the priests had no courage to serve any more at the altar, but . . . hastened to be partakers of the unlawful allowance in the place of exercise.'

The restoration of a conservative type of Judaism by the Hasmonæans naturally resulted in the abolition of these games and feats of strength, which were so revolting to the purer Hebraic spirit, partly on account of their close connexion with foreign cults, and partly because most of them were practised *in puris naturalibus*. But

¹ In the Second Targum on Est 1³ only three such riddles are recorded, but nineteen are given in a MS from Yemen published in *FL* i. [1890] 349-58.

² The primitive kind of dice found at Tell Ta'annek (see above) was probably of a very innocent infantile kind. The spreading of sacrificial tables to Gad and Meni (deities of luck and destiny), referred to in Is 65¹¹, may, indeed, be taken to suggest a tendency to seek fortune by methods of chance rather than by hardy exertion; but it must be noted that the prophet, writing from the true Hebraic point of view, condemns the worship in question, which, besides, may have come in late in post-exilic times (see, further, *Fortuna* [Biblical and Christian]).

about a hundred years later the same un-Hebrew practices, under a different form, were introduced by Herod the Great. The pre-Hasmonæan high priests built gymnasia to please Antiochus Epiphanes, and, similarly, Herod established circuses and theatres in order to ingratiate himself with Augustus. Both the theatre at Jerusalem and the 'very great amphitheatre in the plain,' writes Josephus (*Ant.* xv. viii. 1; see also ix. 6, and xvi. v. 1), 'were opposed to the Jewish customs; for we have had no such shows delivered down to us as fit to be used and exhibited by us; yet did he celebrate these games every five years, in the most solemn and splendid manner.' The general Talmudical attitude¹ towards these innovations may be described as an intensification of the opinion expressed by Josephus. In *Jerus. 'Aboda zara*, 40a (ed. Krakau, 1609), the view is taken that attending a circus is equivalent to an act of murder; in the *Bab. recension* of the same tractate (18b) the close connexion of theatres and circuses with idolatrous worship is emphasized; and in *Jerus. Berākḥōth*, 7b, col. 2 (ed. Krakau, 1609), a thanksgiving² is offered by a pious Rabbi for having had his lot cast 'in the house of learning and the house of prayer,' and not 'in theatres and circuses.'

It must not be supposed, however, that strict Hebraism laid all athletic exercises indiscriminately under a ban. The pious spirit fostered and developed by Talmudism regarded, indeed, everything as trivial in comparison with the study of the Torah; but the Jews were at the same time sensible enough to countenance a reasonable amount of amusement and recreation—so long as the un-Hebrew and heathen element remained excluded. In his *Com. on Zec 12*³ (mentioned in § 1), Jerome relates that, when visiting Syria in the 4th cent., he saw 'large heavy stones which Jewish boys and youths handled and held aloft in the air to train their muscular strength.' In *Bab. Nedārīm*, 104a, a reference is found to games, practised by women, with nuts and apples (apparently arranged in a heap, the object of the player being to hit and upset it), which were forbidden only on the Sabbath. Archery is referred to in *Mishna Kelim*, xii. 1, where קורה חוצים (i.e. the target for arrows; see Bacher, *REJ* xxvi. [1893] 63-68) is spoken of. That the art of swimming was practised is proved by the account given by Josephus in *Vita*, § 3, of how he, with a number of others, saved himself by swimming 'all the night'⁴ after a shipwreck, until taken up by another ship (cf. *Ac 27*⁵).

A picture of Judæan children engaged in mimic performances in the market-place (cf. *Zec 8*⁶, referred to in § 1) is found in *Mt 11*¹⁶⁻¹⁷ ('We piped unto you, and ye did not dance; we wailed, and ye did not mourn' (see also *Lk 7*³²). The nature of the gamenamed קטקט mentioned in *Nedārīm*, 25a, *Kiddūshīn*, 21b, has not yet been satisfactorily determined;⁴ possibly it may have had affinities with what is known as skittles (Abrahams, *Jewish Life in the Middle Ages*, p. 379). Dancing, swimming, and other forms of diversion are referred to in *Bab. Bēṣāh*, 36b (forbidden on the Sabbath day as well as on festivals). In *Jerus. Hagiga*, 7b (ed. Zitomir, 1866), jumping and dancing are mentioned as hav-

¹ References to a milder view are found, e.g., in *Bābā ḥāmā*, 83a, *Genesis Rabba*, lxxx. 1. In the first-named passage the general reference is to חכמת יונית ('Greek wisdom,' including manners and customs).

² This thanksgiving is still printed in several editions of the Jewish Prayer-book (at the beginning). In *Bab. Berākḥōth*, 28b, קרנוח ('street-corners') is substituted for 'theatres and circuses.'

³ No doubt an exaggeration, however.

⁴ For different forms of the word, see the Dictionaries (Buxtorf, Levy, and Jastrow). In Fischer's ed. of Buxtorf (Leipzig, 1869-82), the suggestion is made that the origin of the word is δστρακισμός. Levy renders *kleine Steinchen oder Scherben*. Jastrow derives the word from the Persian *iskodar* ('despatch-bearer'), and thinks that it was a kind of chess.

ing been indulged in at the circumcision of Elisha b. Abūyāh. Worth noting also is the extraordinary feat of a chief like Simon b. Gamaliel i., who, by way of amusing the people on the occasion of the Water Feast at Jerusalem, engaged in a grotesque dance with eight lighted torches in his hands (*Bab. Sukkah*, 53⁹); cf. art. FEASTING (Heb. and Jewish), vol. v. p. 806^b. Hunting is put into the same category as attendance at theatres and circuses in *Bab. 'Aboda zara*, 18b. This is, of course, in agreement with the ancient Hebrew view of the sport, Esau having been a man of the chase, whilst Jacob was given to agricultural and pastoral pursuits, though it should not be forgotten that Nimrod is described as 'a mighty hunter before Jahweh' (*Gn 10*⁹). Herod's proficiency as a hunter (see *Jos. BJ* i. xxi. 13) cannot, of course, be properly regarded as a Hebrew characteristic.

It had been supposed that chess was mentioned in the Talmud under the name of נרשיר (*Bab. Kethūbōth*, 61b), but the idea is no longer prevalent.¹ The subject must therefore be treated in the next section. The Jews were, however, at all times fond of intellectual pastimes, as is evidenced, e.g., by their love of riddles in all periods of their history. The Talmud and Midrash contain a fair number of enigmas; so, for instance, *Gen. Rabba*, lxvii. 6 (in a conversation between Marcus Aurelius and Rabbi Yehūdāh han-Nāsi),² and *Bab. Shabbath*, 152a ('Two are better than three,' i.e. two young legs are better than two old ones with a staff in addition). The Rabbinical elaboration of the riddles proposed to Solomon by the Queen of Sheba has been referred to in § 1.

3. In post-Talmudical times.—Strict Rabbinism from the 6th cent. onwards down to the present day has continued to regard games, sports, and other amusements from a severely ethical point of view, treating with indifference or benevolent toleration amusements and physical exercises of a harmless nature, but unhesitatingly condemning gambling as well as sports and amusements involving cruelty, or likely to excite the passions.

Dice continued to exercise its baneful attractions, and in addition the Jews adopted from their Gentile neighbours such games of chance as 'Odd and Even' and 'Back or Edge,'³ besides lotteries and various kinds of betting. At the beginning of the 14th cent.⁴ the Jews fell, moreover, under the dangerous fascination of card-games. Rabbinical ordinances, entitled *takkānōth*,⁵ were from time to time issued with the object of checking the evil in its divers forms, and prominent teachers and authors employed both satire and admonition of a more direct form in the hope of counteracting the destructive tendencies to gambling among their people (thus, against the earlier forms of it, Maimonides in his *Yad*, הלכות נזילה, vi. 7-11; Kalonymos b. Kalonymos in his *Maḥan Bēn*, composed in 1322); but the most pathetic means resorted to were the self-imposed vows of individuals, solemnly undertaking to abstain from games of chance either in perpetuity or

¹ Rashi († 1104) explains נרשיר by אישקקיש, 'chess.' The word was therefore used in that sense in his day: but Franz Delitzsch (in 'Über das Schach,' in *Orient*, Jan. 1840, pp. 42-58) shows that the term could not have denoted chess in the Talmud, as the Persians, from whom the Jews might have learnt the game, did not know it themselves before the close of the 5th century. Levy (*Neuhab. u. chald. Wörterbuch*, Leipzig, 1876-89) translates the word by 'chess'; but Jastrow (*Dict. of the Targumim*, New York, 1903) renders 'checkers.'

² The identifications are, however, by no means certain (see L. Ginzberg, art. 'Antoninus in the Talmud,' in *JE* i. 656).

³ 'This game was played with a knife, which apparently was thrown in the air, and the decision depended on which side fell uppermost' (Abrahams, *op. cit.* p. 391, note 2).

⁴ Card games (קלפים) are already mentioned in 1322 as being passionately engaged in (see Kalonymos in the work entitled *Maḥan Bēn*).

⁵ For an interesting account of such *takkānōth*, see Abrahams, *op. cit.* p. 394 ff.

for a given number of years. Conscience tried in this way—and not always successfully—to protect itself against the inroads of overpowering temptation. Such vows of abstinence are found written on the fly-leaves of sacred and cherished MSS in the possession of those wishing to free themselves from the ruinous vice, thus adding pathos to the intensity of their desire for reform.

An example of a vow to be binding in perpetuity is found in fol. 200b in the British Museum Additional MS 17,053. The entry is dated in the year 1535, and the resolution 'not to play in any manner whatsoever' was taken in the presence of several witnesses. As an example of a vow limited to a given period of time may be quoted the entry on fol. 294b of the British Museum Additional MS 4709. The entry is dated the 1st of April 1491, and the person concerned pledges himself by an oath on the Ten Commandments neither to play, nor to engage any one to play for him, any game except 'the game of the board' (צוחק המבלי, apparently draughts or chess), and to play even that game only occasionally, during the next ten years. No fewer than five persons were witnesses of the oath.

One of the most prominent Jewish victims to the attractions of card-games was Leon di Modena, who was Rabbi at Venice at the end of the 16th and the beginning of the 17th century. He must have been well aware of the dangerous tendency within him in his early youth, for he composed an interesting dialogue against gambling (entitled תלמיד חסד or סור סרע, 'The Gambling Scholar,' or 'Depart from Evil') when but fourteen years of age (see, e.g., H. Gollancz's English rendering in *Translations from Hebrew and Aramaic*, London, 1908). He was, however, never able to free himself from the vice. In 1628 the Rabbis of Venice published an order of excommunication against any member of the community who should indulge in card-playing within six years from the date of the decree, which, though not necessarily directed against Leon alone, must have been calculated to affect him as the most prominent offender. But he unfortunately defended the habit with great dexterity, and remained confirmed in it (see Abrahams, *op. cit.* p. 392).

Passing on to the game of chess, which, though not very prevalent among the Jews until the 12th cent., was, no doubt, known for several centuries before, one may remark that the fondness of so many of them for the game and their frequent skill in playing it may be regarded as an additional testimony both to their sense of strategy and to the high degree of intellectual clearness to which they are often able to attain.¹ The attitude taken up towards the game by Rabbinical authorities varied considerably. Maimonides (†1204) places persons who play chess² for money in the same category as dice-players and participants in pigeon-racing (Com. on the Mishna *Sanh.* iii. 3), thus declaring them unfit to give evidence before a court of justice. If by the word נורסיר³ Kalonymos b. Kalonymos (in his work אכן בהן already named, ed. Cremona, 8b) meant the game of chess, he clearly intended to express, in satirical form, an even severer judgment than that of Maimonides. From Isaac Lampronti's פתח יצחק, iii. 54a, col. 1, we learn that in the year 1575 three Rabbis of Cremona decreed, in consequence of a plague, that neither man nor woman, and not even young persons, from the age of ten upwards, living in that city should for a given time play any game except chess, provided that the latter was not played for money. In שבת סוטר (beginning of ch. 42) of Elijah Kohen of Smyrna (†1729), on the other hand, chess is disapproved of absolutely on the ground that it is a waste of time, and that the mental energy spent on it should be reserved for sacred study. The preponderant view was, however, in favour of the game as an intellectual pastime, and it was, as a

¹ It might at first sight seem strange that chess should have been popular among Jewesses also (see Schudt, *Jüd. Merkwürdigkeiten*, 1714-18, iv. ii. 381); but one should bear in mind that indoor games generally were in the Middle Ages chiefly engaged in by Jewish women, no doubt partly because they had more leisure than the men.

² שטרונג, *shitrang*, borrowed by the Arabs from the Persians. It must be stated, however, that the point is not sufficiently clear, for Maimonides appears to give שטרונג as one of the renderings of קוביא.

³ Even if the word does not mean chess in the Talmud, it at any rate in some quarters acquired that sense later (see the previous note on the word, showing that Solomon Yishāyā already understood it to denote chess).

matter of fact, often played without compunction even on the Sabbath, when, in honour of the day, chessmen made of silver were used (see Abrahams, *op. cit.* p. 388).¹

The Jews have also produced a number of interesting works on chess, the three most important compositions in Hebrew being חרוזים, or rhymes on the game, attributed to Abraham ibn Ezra,² a poem by Bensenior ibn Yahya (14th or 15th cent.), and a work entitled סעריני מלך ('Delights of the King'), which Steinschneider is inclined to attribute to Leon di Modena, the talented Rabbi already referred to in this part of the article.³

An adequate idea of Jewish interest in chess-playing in our own time may be obtained from parts of the article 'Chess' in *JE*; see particularly the page giving portraits of ten 'Eminent Jewish Chess Masters,' and the list of tournaments ranging from 1851 to 1902. It may in addition be mentioned that it was through chess-playing that Moses Mendelssohn gained the friendship of Lessing. Another interesting, though legendary, point to note is that in *Das Leben Elchanans oder Elchonans* (Frankfurt a. M., 1753; see also, e.g., the English presentation of it by G. H. Händler, *Elchanan: The Legend of a Jewish Pope*, London, 1910) Rabbi Simeon recognizes the Pope as his son, in the course of a game of chess, through a particular move which he had taught him in his youth.⁴

The ethical considerations militating against games of chance, and, if played for money, also in a minor degree against chess, were, of course, absent in the case of amusements of an innocent athletic character. We thus find that in the 12th and 13th centuries ball-playing was engaged in on festivals on public grounds (see *Tōsafōth* on Bab. *Beṣāh*, 12a, near the bottom of the recto, where children's games appear to be referred to). In Joseph Caro's *Shulhān 'Arūkh*, part *Orah Hayyim*, § 308^{ab}, on the other hand, ball-playing is prohibited on Sabbaths and festivals (the more lenient view of it being at the same time mentioned in a note). Among other amusements borrowed by Jewish children from their neighbours, and specially mentioned in the sources, were skittles, blind-man's buff, and leap-frog (see Abrahams, *op. cit.* p. 379 f.).

Of hunting a decidedly adverse view was taken, the sport not only involving cruelty to animals, but also being incapable of yielding a direct advantage to Jewish participants, who were by their law precluded from eating the meat obtained in the chase. The severest judgment ever passed on the sport is found in a decision of Meir Rothenburg (†1293): 'He who hunts game with dogs, as non-Jews do, will not participate in the joy of the Leviathan' (i.e. take part in the great meal of the righteous off the flesh of Leviathan in the Messianic kingdom).⁵ Another cause which in most countries strongly operated against Jews taking part in the chase was the frequent prohibitions against the carrying of arms by them (so, e.g., in an enactment of 1181 in England; see Joseph Jacobs, *The Jews of Angevin England*, London, 1893, p. 260). Jews are, however, occasionally found participating in this and other hardy sports, even including duelling (see Depping, *Les Juifs dans le moyen-âge*, Paris, 1834, p. 182).

¹ For some further account of Rabbinical opinion for and against the game, see *JE* iv. 19. It is, however, not correct to say that in the *Sefer Hasidim* ('Book of the Pious,' 12th-13th cent.) the game is strongly recommended (*ib.* p. 18, col. 1). It is, indeed, very far from certain that chess is even meant by 'the piece of wood wherewith one plays' in the paragraph referred to (§ 400); see Steinschneider, *Schach bei den Juden*, p. 6.

² Steinschneider (p. 7 ff.) denies the authorship of Ibn Ezra, but the early date of the poem remains unquestioned. English readers may refer to the translation by Nina Davis (now Mrs. Salomon) in *Songs of Exile*, issued in Philadelphia and London in 1901. In the *JE*, art. 'Chess,' the translation is reproduced, with the addition of remarks on certain special 'moves' indicated in this early composition.

³ For a fuller list of works, see Steinschneider, *op. cit.*; for modern Jewish publications on the game, see *JE* iv. 20. The three Hebrew works here named were printed, with Latin translations, in Hyde's *De ludis orientalibus*, Oxford, 1694.

⁴ Steinschneider, *op. cit.* p. 36, holds that the origin of the story can be traced to the beginning of the 14th cent., though the Rabbi Simeon of the work is probably meant to represent a famous Rabbi who lived about the beginning of the 11th century.

⁵ See Abrahams, *op. cit.* p. 376.

The drama as a species of literary art, and as calculated to rouse the emotions and inform the intellect, does not concern us here. It can only be referred to as a means of amusement and diversion. The pious Jew of the Middle Ages disliked the theatre quite as much as did his ancestors during the Roman domination of Palestine. He regarded everything connected with it as frivolous and indecent. There were, however, two occasions in each year when he allowed himself considerable licence, though not indeed by way of attending the theatrical performances of his neighbours, but by means of certain dramatic productions of his own. One of these occasions was the Feast of Purim, which falls in March; and the other was the Day of the Rejoicing of the Law (חג המצות), following the Feast of Booths (סוכות) in October. Besides the Ahasuerus Play, which, of course, was specially designed for Purim, representations of the sale of Joseph and of the encounter of David with Goliath were particularly popular.

'The synagogal merry-making on these anniversaries,' moreover, writes Abrahams (p. 262)—for the Synagogue itself was often the scene of these festive amusements—'sometimes included dancing, the introduction of amusing effigies, the playing of musical instruments, the burning of incense, and even the explosion of fireworks. Pageants, approaching very closely the real drama in its pantomimic phase, thus early fell within the scope of Jewish recreations.' Cf., further, DRAMA (Jewish).

Riddles, popular—as we have seen—both in Biblical and Talmudical times, continued to be cultivated in the period now under consideration, the Jewish intellect having always loved to seek occasional relief from the severer tasks before it in the quibbles, quips, and cranks which are part and parcel of the constructing and solving of riddles.

As prominent authors who seem to have taken a delight in composing riddles may be mentioned Moses Ibn Ezra (11th-12th cent.); Abraham Ibn Ezra,¹ already referred to; Yehudah Harizi († 1235); and Immanuel of Rome (14th cent.).

Special mention should be made of a series of enigmas on the numbers 1 to 13 at the end of the Passover-night domestic ritual (beginning: 'One who knoweth? One I know: One is our God in heaven and earth,' and ending: 'Thirteen who knoweth? Thirteen I know: thirteen are the attributes of Deity' (i.e. the thirteen attributes of mercy counted in Ex 34^{6,7}).

Special mention should also be made of the trick of *Gematria* (גימטריא), consisting in the manipulation of words in accordance with the numerical values of their letters. This kind of arithmetical amusement (for it can, in many instances, hardly be called by any other name) is common both in Talmudical and in post-Talmudical times. As an example may be given the counting up of the full number of Haman's children by adding together the values of the letters in רב (=208) in Est 5¹¹ (רב בניו, the multitude of his children). There is also a possibility of *Gematria* having been employed in Biblical times as well (see ZATW, Giessen, 1896, p. 122, where the number of sayings contained in Pr 10¹⁻²² is shown to be 375, i.e. numerically equal to שלמה [Solomon] occurring in 10¹; and the 136 sayings comprised in chs. 25-29 are similarly believed to be indicated in חזקיהו [Hezekiah] named in 25¹).

LITERATURE.—Most of the sources used for this article (including parts of the OT and the Apocrypha, Talmud, Midrash, Josephus, early Commentaries, Talmudical Compendia, and other works in different languages) have been already mentioned. In the chapters on 'Games and the Theatre,' in I. Abrahams' *Jewish Life in the Middle Ages*, London, 1896, which has been frequently referred to in § 3, an additional number of both medieval and modern authorities will be found. The art. 'Spiele bei den Hebräern,' in PRE³, though not covering the entire field, and worked on a different principle, has been found very useful. On the subject of chess, M. Steinschneider's *Schach bei den Juden* (originally published as part of A. van der Linde's *Gesch. u. Litt. des Schachspiels*, Berlin, 1874) is still indispensable. G. MARGOLIOUTH.

¹ One of the best known riddles of Abraham Ibn Ezra is that on the grammatical use of the letters אהי.

GĀNAPATYAS.—The name of this Hindu sect is derived from Skr. *Gaṇapati*, one of the many names of the Hindu god Gaṇeśa, the eldest son of Śiva (see BRĀHMANISM, in vol. ii. p. 807). Gaṇeśa is considered to be the leader of the *gaṇas*, or attendants on Śiva, and first appears in Hindu literature as a creator of obstacles, and, as such, hindering success.¹ He was thus primarily worshipped in order to induce him to abstain from impeding; but in modern practice, especially at his festival in August-September, he is looked upon as the remover of difficulties, the god of wisdom, and the guardian of the public ways. His image stands in nearly every well-to-do Hindu house, and there are numerous temples in his honour, not only in Benares,² but scattered over India. His image is also found in temples dedicated to Śiva. Every Hindu book commences with the words *Gaṇeśāya namaḥ*, 'Reverence to Gaṇeśa'; and in parts of Southern India, such as Travancore (*State Manual*, ii. 51), children on being put to school begin their writing lesson with the invocation *Harīḥ, Śrī-Gaṇapataye namaḥ*, 'Hari, Reverence to the holy Gaṇapati,' instead of the more usual *Oṃ, namo Nārāyaṇāya*, 'Oṃ, Reverence to Nārāyaṇa.' In Travancore there are special shrines, called *homapurās*, in which *homās*, or sacrifices, are daily offered to Gaṇeśa for the prosperity of the country; and, occasionally, *mahā-Gaṇapati-homās*, or great sacrifices to Gaṇeśa, involving considerable expense and trouble, are performed.³ Although the god is venerated and worshipped throughout Northern India, and is often adopted as a guardian deity, his cult among the general population is not so direct and public as it is in the South, and especially in Travancore.

Wherever we go in any part of India, there are few traces of any special sect devoted to the cult of Gaṇeśa in preference to that of other Hindu deities. The close connexion between Gaṇeśa and Śiva was, however, responsible for the existence of a group of sects in ancient India, classed together under the title of *Gāṇapatya*, which transferred the adoration of the worshippers from the latter to the former. Our authority for the tenets of these *Gāṇapatyas* is chs. xv.-xviii. of a work entitled the *Saṅkara-vijaya*, claiming to be from the pen of one Anandatīrtha, and to have been written in the 10th cent., but probably pseudonymous and of much later date. According to it (xvii.), the *Gāṇapatyas* were divided into six sects—the worshippers of Mahā-Gaṇapati, Haridrā-Gaṇapati,⁴ Uchchhiṣṭa-Gaṇapati, Navanīta-Gaṇapati, Svārṇa-Gaṇapati, and Santāna-Gaṇapati, respectively. These differed mainly in the form or title under which the god was adored, and in the words of the *mantras*, or initiatory formulæ, which were taught to converts. They all agreed in looking upon Gaṇeśa, and not Śiva, as the great First Cause, who alone exists eternally, and through whose *māyā*, or illusion, Brahmā and the other gods are created (xv.). Gaṇeśa, therefore, although endowed with personality, fills much the same position as the Brāhma of the Vedānta philosophy of Saṅkara. In the *Saṅkara-vijaya*, Saṅkara is introduced arguing with and confuting each of these sects.

The one sect that deserves particular notice is that of the worshippers of Uchchhiṣṭa-Gaṇapati. They followed some Saiva sects in adopting the

¹ See the article above referred to; also Hopkins, *Religions of India*, London, 1896, p. 451. A common name given to Gaṇeśa is Vighneśvara, 'Lord of obstacles.'

² See E. Greaves, *Kashi, the City Illustrious, or Benares*, Benares, 1909, pp. 63, 81, 84.

³ For details, see *State Manual*, loc. cit.

⁴ For the legend connected with this name, see Ward, *View, etc.*, i. 59. The same author (58) remarks that those Hindus of Bengal who adopt Gaṇeśa as a guardian deity are called 'Gāṇapatyas.'

so-called 'left-hand' worship, considering Devī as the *śakti*, or energetic power, of Gaṇeśa, not of Śiva. Their esoteric sect, the Hairambas, abrogated all obligatory ritual, distinction of caste, and the marriage tie. Promiscuous intercourse of the sexes was to them the highest act of worship, the male worshipper identifying himself with Heramba, i.e. Gaṇeśa, and the female with his *śakti*. The name of the deity worshipped by this sect—Uchchhiṣṭa-Gaṇapati, 'left-foot- or orts-Gaṇeśa'—has been variously interpreted. The *Śaṅkara-vijaya* (xvii.) states that he is so called because his followers follow the foul left-handed path; but, according to Colebrook (*Misc. Essays*, i. 212), the origin of the name is the fact that the worshipper pronounces his prayers with his mouth full of victuals, apparently in pursuance of the theory of abrogation of all solemn ritual. The same authority states that the distinguishing sectarian mark of the Gaṇapatyas was a circlet of red minium on the forehead.

The principal scriptures of these Gaṇapatyas were the *Gaṇeśa-khaṇḍa* of the *Brahma-vaivarta Purāna*, and the *Gaṇeśa Purāna* (one of the Minor- or *Upa-purānas*). For an account of the former, see Wilson, *Essays on Sanskrit Literature*, London, 1864, i. 103. It narrates the birth and actions of Gaṇeśa in a series of legends. It is noteworthy that in a subsequent section of the *Brahma-vaivarta Purāna* dealing with Kṛṣṇa's life and adventures, his spouse, Rādhā, is represented as adoring Gaṇeśa (Wilson, 117). For the *Gaṇeśa Purāna*, see the analysis by Stevenson in *JRAS*, 1846, p. 319 ff. Besides containing, like the *Gaṇeśa-khaṇḍa*, a series of legends,¹ it describes two ways of worshipping the god. In one, he is identified with the Supreme Spirit, Paramātmā, and is to be worshipped by mystical contemplation alone. In the other, an image of the god is crowned with flowers, and has offerings made to it on the occasion of the annual festival in his honour. Śiva himself is represented as waiting on him with the most austere devotion for ten years, and as thereby winning from him the boon of victory over the demon Tripurāsura.² Monier Williams (*Indian Wisdom*, London, 1875, p. 139) also mentions a *Gaṇeśa-Gītā*, which is identical in substance with the *Bhagavad-Gītā* (q.v.), the name of Gaṇeśa being substituted for that of Kṛṣṇa. In both the *Gaṇeśa Purāna* and the *Gaṇeśa-Gītā*, the important doctrine to be noted is that Gaṇeśa is identified with the Supreme Deity, and is superior even to Brahmā, Viṣṇu, and Śiva.

The worship of Gaṇeśa, though not at the present day the cult of a particular sect, is, as we have seen, specially popular in Southern India. He seems to have been originally a Dravidian sun-god³ adopted into the Hindu pantheon. A well-known verse, attributed by tradition to the sage Manu, but not occurring in the lawbook associated with his name, says that Śambhu (i.e. Śiva) is the god of Brāhmins, Mādhava (Viṣṇu) of warriors, Brahmā of the mercantile classes, and Gaṇeśa of the Śūdras, or aboriginal population,⁴ and it is probably more than a coincidence that the rat, on which, according to Hindu mythology, Gaṇeśa rides, is a totem of at least one Dravidian tribe, the Oraons.⁵

We meet relics of the old special cult still in

¹ These are reproduced by Rice in the *Mysore Gazetteer*, 1897, i. 469.

² Both Stevenson and Rice look upon this legend as an allegory representing the former ascendancy of Buddhism, and its overthrow by the revival of the worship of Śiva. The details are too numerous to quote here. Compare the similar theory regarding Gayāsura (see *GAVĀ*, § 4).

³ Cf. Crooke, *PR*, 1894, pp. 8, 287.

⁴ Cf. Wilson, *Religious Sects*, 2; and Hopkins, *Religions of India*, 487.

⁵ Risley, *TC*, 1891, ii. 113.

Southern India. The Travancore *homās* have been already mentioned, but much more striking is the celebrated case of the human shrine of Gaṇeśa in the village of Chinchvaḍ, near Poona in the Bombay Presidency. The story runs that some three hundred years ago a pious youth named Morobā was an ardent worshipper of Gaṇeśa. As a reward the god came to him in a dream, and promised to live in him and his descendants for seven generations. Thenceforward the family was believed to possess miraculous powers, and the temple founded by Morobā became richly endowed, even the Emperor Aurangzib giving the family a hereditary grant of eight villages. The representative of the seventh generation died childless in 1810, and a distant relative of the deceased was set up in his place by the priesthood in order to preserve the valuable grants to the temple. The present representative, although not a descendant of Morobā, is still venerated as a deity.¹

LITERATURE.—The scriptures of the ancient sect have been noticed above. The only account in English of their tenets is to be found in H. T. Colebrooke's *Miscellaneous Essays*, London, 1837, i. 212. The *Śaṅkara-vijaya* has not been translated. The text is published in the *Bibl. Indica* (Calcutta, 1868). The sections devoted to the Gaṇapatyas will be found on p. 106 ff. Aufrecht gives an analysis of their contents on p. 249 of his *Catalogus Codicum Sanscritorum*, Oxford, 1864.

For the modern worship of Gaṇeśa and the so-called Gaṇapatyas of the present day, see H. H. Wilson, *Religious Sects of the Hindus*, London, 1861, i. 266; *Aurangabad Gazetteer*, 1884, p. 348; *Poona Gazetteer*, 1885, i. 246; *Mysore Gazetteer*, 1897, i. 469; and *Travancore State Manual*, 1906, ii. 51. It will be observed that, with the exception of the first, all these refer to Southern India. For Northern India, the worship of Gaṇeśa is so much mixed up with that of other, and more prominent, divinities that no separate notices have been recorded concerning his cult. Cf., however, M. A. Sherring, *Hindu Tribes and Castes*, Calcutta, 1872-81, i. 10, 12, 13, 253. W. Ward, *View of the History, Literature, and Religion of the Hindoos*, London, 1817, i. 56 ff., may also be consulted.

There are many accounts of the human shrine at Chinchvaḍ. The earliest and fullest is that of E. Moor, written in the year 1800, during the lifetime of the sixth of the seven incarnations, and published in *Asiatick Researches*, vii. [1801] 383 ff. Another account will be found in the *Poona Gazetteer*, 1885, iii. 125 ff. The latter quotes as authorities the *Transactions of the Literary Society of Bombay*, ii. [1820] 69; *Murray's Handbook of the Bombay Presidency*, 1881, p. 178; G. A. Valentia's *Voyages and Travels, 1802-1806*, published London, 1809 and 1811, ii. 152; and Maria Graham's *Residence in India*, Edinburgh, 1812, p. 270.

G. A. GRIERSON.

GANDHĀRA.—The Sanskrit name for the modern District of Peshawar (British India). It is a vast undulating plain, almost entirely surrounded by a girdle of mountains which is linked in the S.E. by the right bank of the Indus. These mountains separate Gandhāra on the S. from the District of Bannu; on the N. and N.E. from the Swāt and Būner valleys, which were formerly known as Udyāna. On the Afghanistan side they are inhabited by the tribes of the Orakzais in the S.W., the Afridis in the W., and the Mohmands in the N.W.—all equally under the control of the Anglo-Indian Government. The district is watered by the Kabul-rūd (the *Kubhā* of the Indians, the *Kōphēn*, *Kōphēs*, or *Kōas* of the Greeks) and by its tributaries, which are only temporary torrents, with the exception of the river Swāt (*Suvastu*, *Souastos*). Beyond the immediate banks of these watercourses, which are the richest and most populated parts of the country, the scourge of drought has everywhere laid hold on the shadeless plains and on the classic bareness of the hills. Whatever may be the cause, the climate of Gandhāra has lost the moisture which used to be so much praised in the old texts, and the springs have completely deserted a number of sites where the ruins of buildings of considerable size prove that they used to flow. The English administration, however, is now employed in restoring its old fertility to the country by the opening of canals, some of which can be traced back to the Indian

¹ *Aurangabad Gazetteer*, 1884, p. 348.

period, but had been allowed to fall into disuse by the Pathāns. The greater part of the land, indeed, belongs at the present moment to the Yūsufzai, Mohamedzai, and Gigiani clans of the Pathān Khakhai tribe, which is supposed to have spread over the district in the 15th century. In spite of the persistence, in the village bazaars, of the commercial castes of the old Hindu population and the recent immigration of Hindkis (as the Pathāns call the natives of India proper), more than half of the 600,000 inhabitants are of Afghan race, and 90 per cent speak Pūshṭū (Afghan) in the native country of Pāṇini, the great authority on Sanskrit grammar.

At all epochs the district has been traversed from W. to E. and from S. to N. by two main roads. The former is the great trade route and the road taken by the invasions of former times. Emerging from the famous Khyber Pass beside Peshawar (Puruṣapura), it used to run through Puṣkarāvati (Peukelaotis, now Charsadda) and Po-lu-sha (now Shāhbāz-garhi), and finally reached, at Udabhāṇḍa (Und), the vast bed of the Indus, which was crossed in winter by a ford and in summer by a ferry, and from which Takṣaśīlā (Taxila) was reached by three stages. This natural road has been abandoned in modern times, owing to the exceptional facilities offered by the narrow gorge of Attock (several miles down the river from Und) for the construction of a permanent bridge, either one of boats or an iron one; but nothing could be more artificial than the actual route of the Grand Trunk Road and the railway, all composed of bridges and embankments across marshes and ravines—a triumph for the straight line and a feat of engineering skill. Similarly the Swāt was reached either from Puṣkarāvati, along the river, through the District of Haṣṭnagar, or 'the Eight-Towns,' or from Po-lu-sha by the great Pass of Shakhōta, which the natives still call the Elephants' Neck; but now the new Swāt, Dir, and Chitral road—which, branching off at Nowshera and passing through Hoti-Mardān and Dargal, reaches the Malakand Pass, while alongside of it a little narrow-gauge railway runs as far as the foot of the mountains—has completely supplanted its old rivals on the right and on the left. Nevertheless, the country still remains what Nature made it, the ante-room of India, and the meeting of the ways to and from Upper Asia and the West.

It will readily be understood that the possession of this frontier-country was long disputed by the two races, the Indians and the Iranians. Going back to the earliest mention of it that we can trace in history, we find that Gandhāra was one of the Indian conquests of Darius Hystaspis (521-485 B.C.). According to the chroniclers of Alexander, India, at the time of his raid in 326, still began at the Indus. Twenty years later, by a treaty with Seleucus, the Emperor Chandragupta annexed, along with Gandhāra, a good part of Ariana on the right bank of the river. His grandson, Aśoka, had his pious edicts engraved there about 257-6 B.C. But, fifty years later, the Greek kings of Bactria regained the upper hand in a most decided way and conquered N.W. India. From the hands of Demetrius and Menander it passed into those of the Indo-Parthian satraps—one of the last of whom is said to have been the Gondophares who was visited by the Apostle Thomas about A.D. 50—and then into the hands of the chiefs of Indo-Scythian hordes. Peshawar became the winter capital of Kaniska and, after him, of his successors; for, although the country had been utterly ruined at the beginning of the 6th cent. by an invasion of the Huns, a Turushka dynasty of Buddhist religion had kept its ground there under the traditional title of 'Sāhis.' This dynasty was supplanted, about the year 900, by a minister of Brāhman caste, but his line in its turn was destined to perish a hundred years later, under the blows aimed at it by Maḥmūd of Ghazna. From that time onward, Gandhāra shared the fate of the Musalmān kingdoms of N.W. India. After the Persians, the Greeks, the Parthians, the Scythians, the Turks, the Huns, and the Afghans, it saw the passage of the armies of Muhammad Ghorī (1175), Timūr (1398), Bābar (from 1505), Nādir Shāh (1738), and finally Aḥmad Shāh, of the Afghan clan of the Durrānis (1748). It was from these last that, at the beginning of the 19th cent., the European generals in the service of Ranjit Singh re-conquered the district, which, at the time of the annexation of the Panjāb (1849), passed directly from the Sikhs into the hands of the British administration. Such is, in short, an account of the vicissitudes experienced by this unfortunate country, which always had so much to suffer from the fact that it was situated on the great land-route of the conquerors of India.

In the present work, Gandhāra is specially worthy of notice on account of its importance in the history of Buddhism. If we judge by the terms of his 5th rock-edict, Aśoka still considered it as a country which had to be evangelized; if we believe the Sinhalese Chronicle it already was so, even in Aśoka's reign, through the working medium of the monk Madhyāntika. The one thing certain is that the doctrine of Buddha here met with exceptional and lasting success. In the eyes of the Chinese pilgrim Fa Hian and his companions, about the year 400 of our era, Gandhāra was now

on the same footing as Central India, and had become the second 'Holy Land' of Buddhism. It must be admitted that no one had dared to locate there the great events of the last life of the Master; but his previous existences were seized upon, and in the territory of Gandhāra or its immediate neighbourhood there were counted 'four great pilgrimages' to the four *stūpas*, now in ruins, which marked the places where the future Buddha had formerly dispensed in charity his eyes, his flesh, his head, and his body. Finally—not to speak of the great religious foundation of Kaniska in the neighbourhood of Peshawar, the relic-deposit of which was excavated in March 1909 by the Archaeological Survey—the country was covered 'with one thousand monasteries'; their ruins still slumber for the most part either in the hollows of the hills, or on the stony mountain spurs, or under the enormous tumuli which everywhere break the level of the country. If we bear in mind that Gandhāra, in virtue of its geographical situation, has been from all time the region of India most open to Western influences, we shall easily understand the double rôle which it has filled in the evolution of Buddhism when this religion crossed the frontiers of its native country. On the one hand, many of its learned monks contributed to the transformation of the old rational, but egoistic, doctrine of the *arhat* into the theory, more actively charitable but at the same time more metaphysical and devout, to which its followers gave the name *Mahāyāna*. On the other hand, by using the resources of Hellenistic art for the decoration of their buildings, its lay donors created the centre from which Buddhist iconography afterwards spread over the whole continent of Asia. At least it is from the soil of Gandhāra that a small number of excavations, unfortunately at first indifferently conducted, have drawn the vast majority of these so-called Græco-Buddhist sculptures, the best collections of which are preserved in the museums of Lahore, Calcutta, Berlin, London, Paris, and, in recent years, Peshawar.

LITERATURE.—H. W. Bellew, *General Report on the Yūsufzais*, Lahore, 1884; A. Cunningham, *Ancient Geography of India*, London, 1870; *Arch. Surv. Reports*, ii. and v.; *Panjāb Gazetteer, Peshawar District*, 1897-98; H. A. Deane, 'Note on Udyāna and Gandhāra,' in *JRAS*, 1896 and 1898; A. Foucher, 'Sur la Frontière indo-afghane,' in *Tour du Monde*, Oct.-Nov. 1899, and separately, Paris, 1901, 'Notes sur la Géographie ancienne du Gandhāra,' in *Bulletin de l'École française d'Extrême-Orient*, I., Hanoi, 1901, Introduction to the *Art gréco-bouddhique du Gandhāra*, Paris, 1905, etc.

A. FOUCHER.

GANDHARVA.—See BRĀHMANISM, VEDIC RELIGION.

GANGĀ, GANGES (Skr. *Gaṅgā*, possibly from rt. *gam*, 'to go').—The great river of N. India, draining the lower Himālayas and the N. and E. slopes of the Vindhya range. It is held sacred by a larger number of worshippers than any other river in the world.

1. Geography.—Under the name Bhāgirathī, the river rises in the Tehri State (lat. 30° 55' N.; long. 79° 7' E.) from an ice-bed near Gangotri (*q.v.*), 13,800 feet above sea-level. After receiving the Jāhnavī and the Alaknandā (*q.v.*), it enters the plains, passing Hardwār (*q.v.*); and lower down its course, with the Jumnā which joins it at Allāhābād (*q.v.*), it encloses the fertile tract known as the Doāb or Antarvedi, 'the region between the two rivers.' In the United Provinces its chief tributaries are the Rāmgangā, Jumnā, Tons, Gumtī, and Gogrā. When it reaches the frontier of Bengal, it is joined by the Gāgrā, and near Patnā (the Pātaliputra of the ancient Hindus, the Palibothra of early Greek travellers) by the Son; lower down by the Gaṇḍak; and, when it approaches the Bay of Bengal, by the greatest of its

affluents, the Brahmaputra. The total length of its course is 1557 miles. From a religious point of view, the most important cities and towns situated on its banks are Hardwār, Kanauj, Allāhābād, Benares, Patnā, Sonpur (*q.v.*); with Sāgar Island (*q.v.*) at the mouth of the Hooghly.

2. Early allusions and legends.—The sanctity of the river does not date from the earliest Vedic period. According to the oldest traditions, the Hindus (then settled in the E. Panjāb) regarded with special reverence the Sindhu or Indus, and the Sarasvatī, which at the present day, partially lost in the Rājputāna desert, joins the Ghaggar within the Patialā State. The Ganges is mentioned only twice in the Rigveda: in one passage (vi. 45. 31) its high banks form the subject of a simile; but in the hymn to the rivers (x. 75. 5) it is invoked with the Yamunā (Jumnā), Sarasvatī, Sutudri (Sutlej), Paruṣṇī (Rāvi), Asiknī (Acescines, Chināb), Vitastā (Jhilam), and Arjikiyā (Biās) (J. Muir, *Original Skr. Texts*, pt. ii., London, 1860, p. 355 f.; A. A. Macdonell, *Vedic Mythology*, Strassburg, 1897, p. 86 ff.). When the Hindus moved eastward along the Ganges valley, their Holy Land was fixed between the Ganges and the Jumnā (*Vasiṣṭha*, i. 12; *Baudhāyana*, i. 1. 2, 10 [*SBE* xiv. (1882) 3, 147]). In the *Mahābhārata* the sanctity of the river and its holy places is fully established.

'In this age Ganges is holy' (iii. 85, 90). 'He who bathes in Ganges purifies seven descendants. As long as the bones of a man touch Ganges water, so long that man is magnified in heaven.' 'No place of pilgrimage is better than Ganges' (iii. 85, 94-96; see E. W. Hopkins, *The Religions of India*, London, 1902, p. 372 f.).

Buddhist writers naturally pay little attention to the river, though its cult must have prevailed in their time. Buddha uses the pilgrim's attempt to reach its source as an emblem of the unreality of earthly things, and the obstructions in its channel represent the many miseries experienced in the course of re-birth (*Jātaka*, Cambridge tr., ii. [1895] 179; H. C. Warren, *Buddhism in Translations*, Camb., Mass., 1896, pp. 153 ff., 440). Anchorites live on its banks (*Jātaka*, i. [1895] 156, iii. [1897] 283). The 'heavenly' Ganges is mentioned, and the river is spoken of as 'Mother of rivers, known among men as Bhāgirathī' (*ib.* iv. [1901] 263, v. [1905] 51, 64). The earliest knowledge of the river gained by the people of the West was due to Megasthenes (Arrian, *Indika*, iv.), who describes the river as greater than the Indus and possessing seventeen tributaries, which Pliny (*HN* vi. 22 [18]) raises to nineteen. Strabo (xv. 35) calls the river (ὁ Γάγγης) the greatest in the three continents, next to it being the Indus, Danube, Nile; he states that the Indians worship Zeus Ombrios, 'the rainy' (Indra), the river Ganges, and local deities (see J. W. McCrindle, *Ancient India as described in Classical Literature*, London, 1901, p. 77, *Ancient India as described by Megasthenes and Arrian*, Bombay, 1877, p. 186 ff.; W. Smith, *Dict. Greek and Roman Geog.*, London, 1856, i. 972 ff.).

Many legends naturally gathered round the sacred river. In the *Rāmāyana* (i. 42) the royal saint Bhāgiratha, descendant of Sagara, performs austerities to induce Gaṅgā to descend from heaven and purify the ashes of the sons of Sagara, who had been destroyed by the offended sage Kapila, and thus to elevate them to Paradise. On his failure, Brahmā advises him to propitiate Śiva, who alone could sustain the shock of the falling Gaṅgā. Accordingly Śiva ascends the Himālaya and calls upon the goddess to come down. In her rage she tries to sweep the god down with her to Pātāla, the nether world. But Śiva compels her to circle for ages in the labyrinth of his matted locks, perhaps the icicles at the river source. Hence he is named Gaṅgādhara, 'Ganges-sup-

porter.' At last, being again propitiated by Bhāgiratha, Śiva allows her to flow to the sea and purify the ashes of Sagara's sons (J. Muir, iv., 1873, p. 365; R. T. H. Griffith, *Rāmāyana*, Benares, 1895, p. 51 ff.). Later bards endeavoured to associate the heroes of the *Mahābhārata* with the earlier Nature-gods, describing, for instance, Bhīṣma as son of Gaṅgā by Śāntanu. A curious tale is told by Plutarch (Περὶ ποταμῶν, ed. Paris, 1624, p. 1151 f.), in which the name of the river is explained by the tale that the nymph Kalauria bore Indus a son named Ganges, who committed incest with his mother, and in remorse threw himself into the river Chliaros, which was called after his name (see G. Oppert, *Original Inhabitants of Bharatavarṣa or India*, Madras, 1893, p. 126 f.; for other legends in the Purānas, see E. T. Atkinson, *Himalayan Gazetteer*, Allahabad, 1882-84, ii. 286 ff.).

3. Cult-titles, temples, images.—(a) The cult-titles of Gaṅgā are numerous. She is called Jāhnavī, because she was drunk up by the offended sage, Jahnu; Varanadī, 'excellent river'; Devabhūti, 'flowing from heaven'; Harasekharā, 'crest of Śiva'; Mandākinī, 'gently flowing'; Bhāgirathī, 'brought down by Bhāgiratha'; Tripaṭhagā, Trisrotah, 'triple-flowing,' i.e. in heaven, earth, and hell, under the respective titles of Mandākinī, Bhāgirathī or Gaṅgā, and Bhogavatī (see J. Dowson, *Classical Dict.*, London, 1879, s.v. 'Gaṅgā'; B. Ziegenbalg, *Genealogy of the S. Ind. Gods*, Eng. tr., Madras, 1869, p. 57). The primitive, animistic spirit of the river is now completely anthropomorphized.—(b) Temples dedicated to Gaṅgā are found in many places, especially at the sacred places along the river-bank, of which one of the most important is that at Hardwār (*q.v.*). But in many places she is identified with Pārvatī, or one of the other forms of the Mother-goddess, like Annapūrnā, goddess of food at Benares; and many of the goddesses worshipped by the non-Aryan-speaking tribes have been adopted as her manifestations. Thus Tuimā, the river-goddess of the Tipāras of E. Bengal, who is worshipped in Agrahāyana (Nov.-Dec.), by stretching from the nearest bathing-place to her shrine a thread which no one may cross, is now identified with Gaṅgā (E. A. Gait, *Census Rep. Bengal*, Calcutta, 1901, i. 186 f.).—(c) Her images appear in many of the W. cave-temples (Fergusson-Burgess, *Cave Temples of India*, London, 1880, pp. 326, 439, 455, 460, 470); and her image and that of Jumnā guard the entrances of Gupta temples, that is to say, they are in process of admission to the orthodox pantheon (V. A. Smith, *Hist. of Fine Art in India and Ceylon*, Oxford, 1911, p. 32; and see a photograph of her image from Besnagar in Bhopāl, *ib.* 160, fig. 112; for a photograph of the Hardwār image, *PR*², 1896, i. 35). In S. India she is represented as a siren, half-woman and half-fish, swimming in water and folding her hands as if in prayer; on her head she wears a crown, and on her forehead the Saiva mark in holy ashes; she is covered with jewellery (Ziegenbalg, 56). In Bengal she is represented by a white woman, crowned, sitting on the sea-monster *makara* (a kind of crocodile), having in her right hand a water-lily, in her left a lute (W. Ward, *The Hindoos*², London, 1815, ii. 206). At the great temple of Rāmnagar near Benares the three goddesses, Gaṅgā, Jumnā, Sarasvatī, have each a separate niche; and in another temple at the same place Gaṅgā is represented by a richly-dressed image in white marble, seated on a crocodile, with a crown on her head; she has four hands, one hanging down, the second uplifted, the third grasping a lotus flower, the fourth holding a brass vessel (M. A. Sherring, *The Sacred City of the Hindus*, London, 1868, pp. 170, 174).

4. The place of the Ganges in popular worship.—Gangā is everywhere regarded as benign, the giver of health, children, and other prosperity, the great purifier from the pollution of sin. This is specially the case at the points of junction with her tributaries, and in particular those with the Jumnā, Son, and Gandak. Though, according to the *Bhāviṣya Purāna*, her sanctity was fated to disappear in 1895 and to be replaced by that of the Narbadā, the prophecy has not been fulfilled (*PR*² i. 40). The pollution of her waters is regarded as a heinous outrage on Hindu feeling, as was shown in the strange scenes of general mourning and penance which followed the Benares riots in 1809 (*ERE* ii. 466; Sherring, 193 f.). According to Ward (ii. 212), many Brāhmins will not cook while sailing on the river, or throw saliva into it, or wash themselves or their clothing. Though attempts have been made at Hardwār and other places to connect the cult of Gangā with that of the orthodox gods, she remains non-sectarian, and all castes seek purification and blessings by bathing in her waters. To those who have been present at one of the great bathing-fairs nothing is more impressive than the reverence and fervour with which the wearied pilgrims greet the first view of the river, shouting *Gāngājī ki jai*, 'Victory to Lady Ganges!' She is commonly addressed as *Gāngāmā*, 'Mother Ganges.' Besides the bathing at auspicious moments prescribed by the local Brāhmins, a special rite is the shaving of the pilgrim and the dedication of his hair—a form of initiation whereby the physical bond between him and the deity is reinforced (cf. W. R. Smith, *Rel. Sem.*², 1894, p. 327 ff.; J. G. Frazer, *Totemism and Exogamy*, London, 1910, iv. 230, who suggests that it is intended to increase the resemblance of the neophyte to that of a new-born babe; for dedication of hair to rivers, see *GB*², pt. ii. [1911] p. 261). The special festival of the goddess is *Gāngā Saptamī*, 'Ganges' Seventh,' held on the 7th light half of Baisākh (April–May), or in Benares on the 7th of the following month, Jeth. On the 10th of this month, at Benares, her birthday is celebrated by bathing and bestowal of alms; little girls, probably as a rain-charm, float their dolls down the river, and for the next four months refrain from using dolls or other playthings (Sherring, 216; cf. Frazer, *Adonis, Attis, Osiris*², London, 1907, pp. 183, 195). In Bengal, with the exception of some special prayers to the goddess, most of the rites at the daily ablution are in honour of the greater gods. Bathing in the months of Vaisākhā (April–May), Jyaisṭhā (May–June), Kārttika (Oct.–Nov.), and Māgha (Jan.–Feb.) is specially efficacious. After bathing, the attendant priest says prayers and pours offerings into the water; at this time, if a worshipper places ten kinds of fruit on his head and immerses himself in the river, the sins of ten births will be removed (Ward, ii. 210 f.). At Hardwār, every twelfth year, when Jupiter enters the sign of Aquarius, one of the great bathing-fairs is held (A. Cunningham, *Rep. Arch. Survey*, Calcutta, 1871, ii. 236).

We have records of the merit of bathing in the Ganges from the time of the Buddhist pilgrim Hiuen Tsiang (A.D. 634), in the Purānas, and Muhammadan historians, to the present day (S. Beal, *Si-yu-ki*, London, 1884, i. 198; H. H. Wilson, *The Vishnu Purāna*, do. 1840, p. 228; H. M. Elliot, *Hist. of India*, do. 1867, i. 49 f.). The superintendence of these bathing-festivals is in the hands of a special class of local Brāhmins, known as *Gāngāputra*, 'sons of Ganges,' who have an evil reputation for roguery and rapacity (W. Crooke, *TC*, Calcutta, 1896, ii. 387 ff.). Bathing at eclipses removes the tabu (see the remarkable account by F. Bernier, *Travels in the Mogul Empire*, London,

1891, p. 301 f.; *BG* ix. pt. i. p. 395; *PR*² i. 22 f.). Many springs are supposed to have an underground connexion with the Ganges, and bathing in them is regarded as equally efficacious with that in the river itself (*Āin-i-Akbarī*, tr. H. S. Jarrett, Calcutta, 1891, ii. 224; *Rājputāna Gazetteer*, 1891, iii. 219; M. A. Macauliffe, *The Sikh Religion*, Oxford, 1909, iii. 26). The other holy rivers, including the Ganges, are believed to come to bathe in the Godāvarī (*q.v.*) when Jupiter enters the sign of Leo (*BG* xvii. 527).

The river plays an important part in the domestic rites of the Hindus. If possible, the dead are cremated on its banks; or, if death occurs at a great distance, the ashes are dispatched to be thrown into its water, special priests arranging to perform this duty, if the ashes are sent by the Government parcel-post. Pilgrims at Gayā (*q.v.*), the most suitable place for the performance of death-rites, offer to Gangā the first rice-cake (*pinḍa*) in the name of the ancestors (E. A. Gait, i. 190). The water is carried to all parts of India by pilgrims or professional carriers; it is used as a charm to repel evil spirits, dropped into the mouths of the dying, sprinkled at marriages over bride and bridegroom, poured into new tanks which thus become sacred, and used as a medium for taking oaths. In Bengal, at a cremation, the water is poured round the pyre, and a trench is cut in the ground so that it may flow back into the river (Ward, ii. 199). Suicides, with the object of gaining eternal felicity and freedom from grievous disease, were common on the banks of the river, and still sometimes occur. The sick are often taken to die near the river, and in former days what is called the *Gāngā-jātrā*, or 'Ganges rite,' was common, when the moribund were immersed, river mud was spread on the breast, and a friend wrote on it with his finger the name of some god (Ward, i. 195 f., ii. 313; N. Chevers, *Manual of Med. Jurisprud. for India*, Calcutta, 1870, pp. 625, 628 ff.). As a propitiation for grievous sin, such as the killing of a cow, offenders perform the rite of walking, by the left bank, from the mouth of the river to its source, and return by the right bank, this movement being known as *pradakṣiṇa*, 'going to the right,' the *deasil* of the Scotch, or *parikrama*, 'circumambulation' (*q.v.*); the same rite is also performed at the Narbadā (*BG* ii. 349; *PR*² i. 10 f.). In Bengal, some women worship Gangā after childbirth, and ascetics spend every night in the month of Māgh (Jan.–Feb.), seated stark naked on a platform erected over the river, engaged in such prayer and meditation as their sufferings from the cold will allow (E. A. Gait, i. 190). A male spirit, sometimes regarded as a consort of Gangā, Koilā Bābā, 'Father Charcoal,' an old grey-bearded personage, is worshipped as the navvy (*beldār*) of the river, who swallows whatever opposes her current (J. Wise, *Notes on the Races, Castes, and Trades of E. Bengal*, London, 1883, p. 347; H. Risley, *TC*, Calcutta, 1891, i. 296).

LITERATURE.—For the geography and general particulars, see *IGI* xii. (1908) 182 ff. The legends connected with the course of the Ganges in the Himalaya are given by E. T. Atkinson, *Himalayan Gazetteer*, Allahabad, 1882–84, and E. S. Oakley, *Holy Himalaya*, London, 1905. The earlier narratives of exploration are still worth reading: T. Skinner, *Excursions in India*², London, 1833; H. T. Colebrooke, 'On the Sources of the Ganges in Himadri or Emodus'; and F. V. Raper, 'Narrative of a Survey for the purpose of discovering the Sources of the Ganges' (both in *Asiatick Researches*, vol. xi., 1812). Further information will be found in the *Gazetteers of the Districts through which the river passes*. For the references in the *Mahābhārata* see S. Sørensen, *Index to the Names in the Mahābhārata*, London, 1904 ff., p. 297 ff. The remaining literature has been fully quoted in the course of the article.

W. CROOKE.

GANGAIKANDAPUR, GANGAIKONDAPURAM (Tamil, *Kangai Gandappuram*, 'city obtained from the Ganges,' believed to be so called

from the well in the temple precincts, which is supposed to have underground communication with that river; but the name is really a corruption of *Gangai-konda-chola*, 'the Chola king who conquered the lands near the Ganges,' a title of Rājendra Chola I. [A.D. 1064–1113].—A town in the Trichinopoli District of the Madras Presidency, lat. 11° 12' N., long. 79° 28' E., containing one of the most remarkable temples in S. India. It has been fully described by B. R. Branfill, who regards it as 'the largest and best specimen of a S. Indian temple proper'; roughly speaking, it is a facsimile of the temple at Tanjore (*q.v.*); and is possibly its prototype, but perhaps more probably a copy of the latter. But, as it has never been restored, and was built of very hard stone, it retains more of the pristine design and purity which are wanting at Tanjore. It consists of a sanctuary-steeple 100 ft. square, the dimensions of that of Jagannāth (*q.v.*) at Puri and that of Tanjore being 80 and 82 ft. respectively. Its height is 174 feet. It stands on a terrace decorated with a rail-ornament below, the upright posts being engraved with griffins, and on every third or fourth post an elaborate scroll-enveloped animal or figure. The double storey below the pyramid and immediately above the terrace is vertical, with five compartments, or towers, in each face of the temple, separated by four deep recesses, each containing a fine sculptural decoration. The figures are chiefly Śaivite, but important Vaiṣṇavite representations are also found; and the plain intervals of the flat wall are covered with what pretend to be historical scenes of ṛṣis (ancient Hindu saints), kings, worshippers, and attendants, celestial as well as terrestrial, in low relief. Above the double storey rises the pyramidal steeple in seven storeys to the neck, which is spacious, and supports, as at Tanjore, four bulls below the dome and semi-dome. The whole building is of stone, and the domed top is carved to represent a copper tile or leaf-pattern covering, like that of the five halls (*sabhā*) at Chidambaram (*q.v.*). The only ornaments of the pyramidal tower are the square and oblong cells of 'car' (*rath*) or 'spire-roofed' pattern, with elaborate fan-shaped windows, like spread peacocks' tails. East of the great tower is the high court, a three-storeyed portico or transept, covering the cross-aisle between the N. and S. entrances to the temple. This, as at Tanjore, is built to match the *vimāna*, or pyramid-tower. To the E. is the outer court, planned on the most magnificent style, but never completed. The courtyard is 610 ft. E. and W., by 350 ft. N. and S., with a fine entrance-tower (*gopura*) on the E., not half the height of the temple itself. 'The architecture,' says Branfill, 'struck me as grand, simple, and pure, with many traces of the wooden construction of which it is, in many respects, a copy.' The town was probably once an important city, one of the principal seats of the Chola kings. Fergusson fixes the date of the Tanjore temple in the beginning of the 14th cent., which is approximately the date of this edifice.

LITERATURE.—B. R. Branfill, *JASE*, vol. xlix. pt. i. p. 1π.; *IGI* xii. [1908] 128 ff. W. CROOKE.

GANGOTRĪ (probably *Gaṅgā-avatāra-purī*, 'the sacred manifestation of the Ganges').—A temple and place of Hindu pilgrimage, situated in the Tihri District of Native Garhwāl; lat. 31° N., long. 78° 57' E. At a short distance below the temple the Kedār Gaṅgā river meets the Bhāgirathī at a place called Gaurikund ('the pool of the goddess Gaurī,' spouse of Śiva), where pilgrims wash away their sins in the holy river. There is a small temple dedicated to Gaṅgā, the goddess of the Ganges, which was built by a Gurkhā officer

in the 18th cent.; and another of Bhairon, one of the non-Aryan gods elevated into the Hindu pantheon, who is, like all gods on their promotion, regarded as the warden (*dvārapāla*) of the greater gods who have their seats here. The real source of the sacred river is called *Gaumukh*, 'the cow's mouth,' a glacier cavern from which the head waters of the river issue as the ice and snow melt. But Gaṅgotrī itself is regarded as the source of the river, and few pilgrims venture higher up its course, though it is a popular error to suppose that the route is impracticable.

'Though this ablution,' writes Frazer (in Atkinson, iii. 235 f.), 'with due donations to the officiating Brāhmins, is considered to clean from all offences, the number of pilgrims is not considerable, in consequence of the great length and ruggedness of the journey, and the difficulty of procuring subsistence by the way. Flasks and similar vessels are filled at Gaṅgotrī with the sacred water of the stream, and, being sealed by the officiating Brāhman, are conveyed to the plains, where they are highly prized.'

LITERATURE.—W. Hamilton, *Description of Hindostan*, London, 1820, ii. 664 f.; T. Skinner, *Excursions in India, including a Walk over the Himalaya Mountains to the Sources of the Ganges*, do., 1833; F. Parkes, *Wanderings of a Pilgrim in Search of the Picturesque*, do., 1850, ii. 263 ff.; E. T. Atkinson, *Himalayan Gazetteer*, Allahabad, 1886, iii. 234 ff.

W. CROOKE.

GAONISM.—See RABBINISM.

GARHMUKTESAR (Skr. *Gaḍa-muktīśvara*, 'fort of the Lord of liberation,' a title of Śiva).—A celebrated bathing-place on the Ganges, in the Meerut District of the United Provinces of Agra and Oudh, lat. 28° 47' N., long. 78° 6' E., a town of considerable antiquity, and popularly supposed to have been a ward of the capital, Hastināpur (*q.v.*). But the place now pointed out as the site of Hastināpur is 25 miles distant. The chief temple, like the place itself, is named after Muktīśvara Mahādeva, and is dedicated to Gaṅgā, the goddess of the Ganges. Bathing-fairs are held here, and it is a favourite place for the cremation of the dead or for the disposal of their ashes in the sacred river. No fewer than 80 *satī*-pillars commemorate widows who in the old days immolated themselves on the funeral pyre of their husbands. The local cultus is now entirely devoted to Gaṅgā, who possesses four shrines, two on the Ganges cliff and two below it, in which her image, formed of white marble and clothed in brocade, is worshipped, especially at the great bathing-festival held at the full moon of Kārttika (Oct.–Nov.).

LITERATURE.—A. Führer, *Monumental Antiquities and Inscriptions of the North-west Provinces and Oudh*, Allahabad, 1891, p. 9; *IGI* xii. [1908] 162 f. W. CROOKE.

GARLAND.—See CROWN.

GATE.—See DOOR.

GĀTHĀS.—See AVESTA.

GAUR (Skr. *Gauda*, 'prepared from sugar or molasses,' the name being possibly derived from the characteristic product of that region).—A ruined city, the site of the ancient capital of Bengal; lat. 24° 4' N., long. 88° 8' E. The ruins, known also by the name Lakhnautī, or Lakṣmanāvati, are situated 8 miles E. of Angrezābād, or 'English Bazar,' the chief town of the Māldah District of Bengal, and on the E. bank of the Bhāgirathī, a stream which joins the Ganges below Gaur.

The city was not in existence in the time of Ptolemy; but he indicates the site (M'Crindle, *Ancient India as described by Ptolemy*, Calcutta, 1885, p. 215). The Hindu history of the city is lost, save that it was the metropolis of the Hindu kings of Bengal, and all that is known is that the name

was more strictly applied to the surrounding region than to the city itself. In A.D. 1194, or in 1198—the latter the date fixed by Blochmann (*JASB* xliv. 276)—it was conquered by the Muhammadans, and it was under them that it attained its magnificence. The Portuguese historian, Faria y Souza, in the 16th cent., states that it contained 1,200,000 inhabitants, and that its streets were so crowded that at religious festivals and processions numbers of people were trodden to death. It is now a scene of ruin, the destruction of the city being largely due to vandalism.

'There is not a village, scarce a house in the district of Māldah, or in the surrounding country, that does not bear evidence of having been partially constructed from its ruins' (Ravenshaw, p. 2).

The original walled city was probably about 10 miles long by $\frac{1}{2}$ mile broad; but the environs extended to 20 by 3 or 4 miles, and it was surrounded by immense embankments faced with masonry. At present, the whole country within the fortifications and for many miles round is wild, studded with numerous reservoirs, generally overgrown with grass and reeds, and abounding in alligators.

The chief religious buildings now standing complete, or in a partially ruined condition, are: (1) the pretty tomb of the saint Makhdūm Akhī Sirāj-uddin, who died in A.D. 1357, built in 1510; (2) an elegant mosque of embossed brick, known as Jān Jan Miyān, after a lady builder of that name, and dated A.D. 1534-5; (3) Sa'adullahpur Chāt, the only place connected with Hinduism now used for the cremation of the dead; (4) Bārahdwārī ('twelve-gated'), or Great Golden Mosque, perhaps the finest monument of Gaur, 180 feet long, 80 wide, with eleven arches on either side of the corridor, and one at each end (whence its name), built by Husain Shāh, and completed by his son, Nuṣrat Shāh, apparently in A.D. 1526; (5) Qadam-i-Rasūl mosque, so called because it contains a stone bearing the impress of the foot of the Prophet, said to have been brought from Medina by Husain Shāh, the sanctity of this relic having ensured the safety of the building, which is dated A.D. 1530; (6) the fine *minār*, or pillar, 80 feet high, which Fergusson (*Hist. of Indian and Eastern Architecture*, p. 550) dates between the years 1302-1315; he considers it to be a *jayastambha*, or 'pillar of victory'; but, according to Ravenshaw, it was erected as a place to call the faithful to prayer, and was probably built about A.D. 1487-9; (7) Tāntipāra, or 'the weaver's mosque,' dated about 1475; (8) the Lattan, or painted mosque, beautifully decorated with encaustic tiles of vivid colours, of which Francklin (see *Arch. Surv. Rep.*, 1902-03, p. 51 ff.) says: 'I have not myself met with anything superior to it for elegance of style, lightness of construction, or tasteful decoration in any part of Upper Hindustan'; it is supposed to have been built by Yūsuf Shāh, A.D. 1474-81; (9) the small Golden Mosque, better preserved than most of the Gaur ruins, which has been called 'the gem' of the city; oblong in form and roofed with fifteen domes, supported by massive pillars of hornblende stone, of which the whole building is constructed. The inscription is obliterated, but it is known to have been erected in the reign of Husain Shāh (A.D. 1494-1524).

The series of inscriptions on the buildings of Gaur are in the Tughra character, and in two of them the penmanship is described by Blochmann as unrivalled. They date from A.D. 1369 to 1535, and are most important in fixing the chronology of the rulers of Bengal and as illustrations of the progress of Arabic calligraphy in the early centuries after the Hijra, or flight of the Prophet.

Reproductions of these beautiful works of art are given by Ravenshaw (p. 69 ff.).

The last king of the Musalmān dynasty of Gaur was Firūz Shāh III. (A.D. 1532-7). It was sacked by the Afghāns in 1537. From that time its decay began, and its ruin is said to have been completed by an outbreak of plague about 1575. But this story is discredited by Buchanan Hamilton, who states that the city was occupied from time to time by the Musalmān viceroys of Bengal, until the capital was removed to Rājmaḥāl by Shāh Shuja', brother of Aurangzīb, after 1639, when the place was deserted. On the other hand, Hedges, Governor of the English Factories, who visited the place in 1683, found the chief buildings standing, and describes the 'Pallace, which has been (as appears by ye gates of it yet standing), in my judgment, considerably bigger and more beautiful than the Grand Seigneur's Seraglio at Constantinople, or any other Pallace that I have seen in Europe' (*Diary*, i. 88).

LITERATURE.—The chief authority, on which this article is mainly based, is J. H. Ravenshaw, *Gaur, its Ruins and Inscriptions*, London, 1878; see also H. Beveridge, 'Note on Major Francklin's Manuscript Description of Gaur,' *JASB*, vol. lxiii. pt. i. p. 85 ff.; A. Cunningham, *Archæological Reports*, xv. 89 ff.; F. Buchanan Hamilton, in R. M. Martin, *Eastern India*, London, 1838, iii. 68 ff.; J. Fergusson, *Hist. of Indian and Eastern Architecture*, do. 1899, p. 545 ff.; F. Parkes, *Wanderings of a Pilgrim in Search of the Picturesque*, do. 1850, ii. 84 ff.; *Diary of William Hedges*, ed. Sir H. Yule (Hakluyt Society, 1887); *IGI* xii. (1908) 186 ff.

W. CROOKE.

GAUTAMA.—See BUDDHA.

GAYĀ.—The name of a south-Gangetic District in the Bihār Province of British India, and also of its chief town. The area of the District is 4712 square miles, with a population (1911) of 2,159,498. It is bounded on the north by the District of Patna, on the east by the Districts of Monghyr and Hazāribāgh, on the west by Shāhābād, and on the south by the plateau of Chotā Nāgpur. As an administrative area the Gayā District is of late origin, dating only from the year 1865. Before that it formed part of the District of Bihār, and the whole roughly corresponded to the ancient kingdom known as Magadha (*q.v.*). At the present day the District is composed of two tracts—a northern and a southern—with very distinct characteristics. The northern half of the District,¹ together with the present District of Patna, is still known as 'Magah,' a corruption of 'Magadha,' and is well irrigated and fertile. The southern half, which locally bears the name of 'Rāmgārh,' is imperfectly irrigated and covered with forest. Magah, or Magadha, received its Aryan civilization from the North and West, and was the area from which Buddhism spread over India. Rāmgārh has received such civilization as it possesses from the South and South-West. Although the religion has long disappeared, Magah to the present day is a Buddhist country. It is covered with ruins of Buddhist shrines, and Buddhist images are frequently turned up in fields by the plough. Buddhism seems never to have penetrated Rāmgārh. During the times of Magadha sovereignty that country must have been a dense forest, inhabited only by wild tribes and by a few solitary hermits—outposts of Aryan civilization. It is now dotted over with remains of rude forts which local tradition attributes, and no doubt rightly, to the Kōls, or aboriginal tribes of Central India. In later years clearances were made by enterprising immigrants from Rājputānā, who were the ancestors of such Rājput families as those of Deo and Chandragārh. Magah is Buddhist, ancient, highly cultivated, and thickly populated. Rāmgārh is

¹ The boundary line runs east and west about ten miles south of Gayā Town, and a mile or two south of Bodh Gayā.

Hindu, modern, half-cultivated, and sparsely populated.

1. **History.**—It will thus be seen that it is unnecessary to give any detailed account of the history of the District. The history of Magah is merged in that of Magadha, of which the capital cities, Rājagriha and Pāṭaliputra, were in what is now Patna District; for further information the reader is referred to the article MAGADHA. No historical events of importance have occurred in Rāmgarh.

2. **General aspect of the District.**—From the Chotā Nāgpur plateau, which forms the southern boundary of the District, a number of ridges and spurs project into Rāmgarh. These here and there attain to an altitude of nearly 1800 feet above sea-level. As one goes north towards Magah, the country becomes a plain, with a decided slope, averaging four feet to the mile, towards the north. From this plain there stand out numerous semi-isolated hills and ranges; and, still farther north, separate ridges and wholly isolated rocky peaks crop up at irregular intervals.

The most remarkable of these long, low, outlying ranges is the Ganjās-Bhindās-Jethian range, which extends from near Bodh Gayā north-eastwards for a distance of forty miles with only two breaks, and rises at the Handiā Hill to a height of 1472 feet. The other ranges seldom exceed 1000 feet, and few of the isolated peaks are of any great height, the highest being the Mahār Hill (1612 ft.). . . . Of the other hills the most notable are the Barābar Hills, lying partly in the head-quarters and partly in the Jahānābād subdivision; the Hasrā, Pahrā, and Chirkī Hills, the Brahmjūni Hill, which rises some 400 feet above Gayā Town, the precipitous peak Kauwādōl, the Lohābar Hill (1799 ft.) in the head-quarters subdivision, . . . and Srīngirikh in the Nawādā subdivision.¹

These hills have been mentioned in some detail, as many of them are intimately connected with the religious history of the country.

3. **Sacred places.**—The interest of Gayā District depends entirely on the numerous sacred places that lie within its boundaries, and upon its association with the religious history of India, or rather, of the greater part of Asia. Every Hindu is expected to visit the town of Gayā at least once in his life, and there to make offerings to the spirits of his deceased ancestors. It was at Bodh Gayā that Gautama became 'The Buddha,' or 'The Enlightened One'; and this little village is now the most holy spot on the earth to something like a hundred and forty millions of people.²

4. **Gayā Town.**—The town of Gayā, a municipality with a population of 49,921 (1911), is divided into two parts, Old Gayā and Śāhibganj. The latter was laid out in the end of the 18th cent. by a Mr. Law, then Collector, and possesses no archaeological interest. The old town is built upon a rocky hill, separated from a neighbouring hill, called Brahmjūni (Skr. *Brahmayoni*), by a narrow defile, through which runs the road to Bodh Gayā. Brahmjūni is a pile of blackened rock and boulders rising to a height of about 450 feet. The old town hill is not so high, and has to its north the Murlī and Rām Silā (372 ft.) hills, the new town lying in the plain between. On its east runs the river Phālgū. A great part of Gayā, therefore, lies in a valley, and, owing to the reflexion of the sun's heat from the black rocks by which it is encompassed, it is extremely hot and dusty.³

The old town of Gayā is often called Brahmā Gayā, as being sacred to Brahmā,⁴ or else in order

¹ *Gayā Gazetteer* (1906), p. 8.

² So holy is it that there are Tibetan Buddhists who believe that it is no longer on earth, but is now in heaven.

³ The Chinese pilgrim Hiuen Tsiang (7th cent. A.D.) noticed these rocky hills of black stone, which translators have turned into 'a sombre valley,' and 'steep dangerous crags' (Beal), and 'dark gorges and inaccessible cliffs' (Watters). The valley is really far from sombre. It is all day under the blazing sun—as one who has lived in it for five years can testify—and any active person can climb the low hills without difficulty. The one gorge is black in colour, not sombre.

⁴ See *Ā'in-i Akbarī*, tr. Blochmann and Jarrett, Calcutta, 1878-94, ii. 152.

to distinguish the Hindu shrine from the Buddhist Bodh Gayā. Its sanctity and that of the country immediately surrounding it—the *Gayā-kṣetra*—depend upon a remarkable legend in the *Gayā-māhātmya* section of the *Vāyu Purāna*.¹ The main circumstances of the story are as follows:

There was an *asura*, or demon, named Gaya, who was a devout worshipper of Viṣṇu. He practised austerities till the gods became alarmed at the power he was acquiring by his accumulated merit. At Viṣṇu's suggestion they approached him and offered him any boon he might desire. He asked to be made perfectly pure—purer even than the purest gods. The gods granted the boon and returned to heaven. The result of his purity was that every mortal who touched or even beheld him at once ascended to Brahmā's heaven. The rest of the universe, including hell, became empty, and Indra, Yama (the Regent of hell), and other minor deities all found their occupations gone. Headed by Brahmā, they again approached Viṣṇu. Acting under his advice, they asked Gaya to allow a sacrifice to be performed upon his body. He consented, and lay down, his head being where the present Brahmjūni Hill is situated,² and his feet extended to the north. They began the sacrifice, but were surprised to find the demon still moving. Yama then brought a sacred rock from his home and placed it upon Gaya's head. This rock is the present hill. He still moved. Then all the gods sat upon the stone, but, even so, they failed to keep him quiet. Again they appealed to Viṣṇu, who, after unsuccessfully trying the expedient of sending an emanation from himself, came in his own person. He first rendered the demon motionless by striking him with his mace, and then, with all the gods, sat upon the stone. Gaya expostulated, saying that he would have remained quiet if Viṣṇu had only asked him, without using the mace. The gods, delighted, again told him to ask a boon. Gaya replied: 'As long as the earth and the mountains, as long as the moon and the stars shall last, so long may you, Brahmā, Viṣṇu, and Śiva rest upon this stone. May you, Devas, rest upon it too, and call this place after me the "Gayā-kṣetra," extending over five *krośas*, or ten miles, of which one *krośa* will be covered by my head. May therein abide, for the good of mankind, all the sacred pools on the earth, where men, by bathing and offering oblations of water and funeral cakes, may attain high merit for themselves, and translate their ancestors, blessed with a happy salvation, to the heaven of Brahmā. As long as Viṣṇu shall be adored by the learned, so may this place be renowned as the "Gayā-kṣetra," and may resort to it wash away even the sin of killing a Brāhmaṇa.' Viṣṇu and the gods granted this boon, promising that the offering of funeral cakes (*pinḍas*), and the performance of the funeral rites (*śrāddha*) in the Gayā-kṣetra, should translate a hundred generations of ancestors and also the performer to the desired haven. Moreover, by their worshipping Viṣṇu's feet he would obtain supreme salvation in the after life.

This legend is evidently of comparatively modern origin. In the *Rigveda*, the name of Gaya appears only as that of one of the seers (X. lxiii. 17, lxiv. 16). In the *Mahābhārata*, he is not an *asura*, but a pious king (III. xciv. and VII. lxii. ff.), who, amongst other acts, performed a sacrifice at Gayā (ix. 2205). Gayā is also mentioned as a holy spot remarkable for its sacred fig-tree (*akṣaya-vaṭa*), a pilgrimage to which secures a large family of sons (iii. 8075, 8305, xiii. 4253); but there is nothing about any benefit secured to ancestors (for further references, see Sørensen, *Index to the Names in the Mahābhārata*, London, 1904 ff., p. 303). In the *Rāmāyana* (II. cvii.), however, Gaya is said to have chanted a hymn at Gayā, to the effect that a man should have many sons, so that one at least may go to Gayā and rescue him from hell.

So far Gayā has been represented as a town sacred to Hinduism. We next find it mentioned in a Buddhist work, the *Lalita-vistara*, dating perhaps from the commencement of our era. It was still a Hindu town, and is described as the first place visited by Gautama on his journey from Rājagriha to Uruvilvā. He had been invited there as a learned Hindu ascetic by certain householders, who received him with a cordial welcome. After his enlightenment it was one of the first places that received his doctrines, and became the headquarters of the faith. If this account be true, Gayā became a Buddhist town in the 5th cent. B.C. Fa Hian³ (5th cent. A.D.) found it desolate and a

¹ Given in full by Rājendralāla Mitra in *Buddha Gayā*, 9 ff.

² According to Rājendralāla Mitra, p. 19, the true *Gayā-kṣetra*, or Gaya's Head, is not the Brahmjūni, but the adjoining hill, on which the old town and the Viṣṇupada temple have been built.

³ Beal, *Buddhist Records*, i. p. lxi.

desert; but, when Hiuen Tsiang¹ visited it in the 7th cent., it was a city strongly situated, but with few inhabitants. There were only about 1000 Brāhmana families, descendants of the original saint. These Brāhmanas were evidently the ancestors of the modern *gayāwāls* to be described subsequently. It appears, therefore, that Gayā was originally a Hindu shrine with a sacred fig-tree that granted offspring; then it became Buddhist; and finally, between the 5th and 7th centuries A.D., it again became Hindu, with the modern legend of the salvation-giving *asura*.

Rājendralāla Mitra² argues with great show of probability that this last legend is really an allegory of the triumph of Brahmanism over Buddhism. The ancient king of the *Mahābhārata* is converted into (curious contradiction!) a pious demon. As such he devotes himself to austerities and protracted meditation, and at a later stage cultivates the highest purity. His mere touch suffices to cleanse mankind from the most heinous sin and to give them salvation. His crime is that he made the acquirement of salvation too simple and too summary. As such, to Brāhmanas he was a heretic of the character that is assigned to the chiefs among the Buddhists. They were pious and self-mortifying, and devoted to penance and meditation, but they did away with the sacrifices and ceremonies of the Brāhmanas. The head-quarters of Buddhism were at Gayā, and the blow from Viṣṇu's mace indicates force used when persuasion failed to attain the end.³ 'The rock of religion was placed on the head of the infidel, and the force of the gods kept it fixed and immovable.' Just as happened elsewhere—at Puri, Bhuvaneśvari, and other Buddhist centres—the blessing of the gods sanctified the seat of heresy into a principal sanctuary of the Brahmanical faith. Buddhist emblems, Buddhist shrines, and even Buddhist idols, were made subservient to Hindu worship. In the great temple of Old Gayā, the object of worship is a stone on which is carved a representation of the feet of the Buddha. This is now the 'Viṣṇupada,' the footprint of Viṣṇu, by whom its worship is specially commended in the *Gayā-māhātmya*. In fact, the sacred Bodhi-tree, the most holy object in the world to the pious Buddhist, and situated, not in Hindu Old Gayā, but at the Buddhist Bodh Gayā, has also been made an object of Brāhmanical cult, and a special prayer to be offered to it is contained in the same work.⁴

Whether the above theory is correct or not, it does not affect the ordinary pious Hindu, who sincerely believes in the literal truth of the legend. Since the 10th cent. A.D.,⁵ Gayā has been celebrated all over India as a great place of pilgrimage. The various shrines are in charge of a caste of priests known as *gayāwāls*. These claim to be descended from Brāhmanas specially created by Brahmā on the occasion of the sacrifice on Gayā's body, when the then existing Brāhmanas refused to accept the offerings. With five important exceptions, these priests preside over all the ceremonies performed by the pilgrims. There are altogether 45 *vedis*, or shrines, at each of which the pilgrim, under the guidance of a *gayāwāl*, has to make an offering. If he is poor, or hurried, the list may be cut down, but it is absolutely necessary that *piṇḍas* should be offered to the spirits of the dead at three places—the river Phālgū, the Viṣṇupada temple, and the

¹ Beal, *Buddhist Records*, II. 113; Watters, II. 111.

² *Buddha Gayā*, 16 ff.

³ We know that, shortly before the time of Hiuen Tsiang, Buddhism had suffered much from the persecution of the Hindu Śaśāhka.

⁴ The site of the Viṣṇupada temple is almost certainly the same as that of the *stūpa* built by Aśoka on the place where the Buddha uttered the *Pao-Yun* and other sūtras (*Buddha Gayā*, 19).

⁵ *Gayā Gazetteer*, 61.

undying fig-tree (*aksayavaṭa*), which, we have seen, is the real old object of worship, dating from the time of the *Mahābhārata*.¹ Having finished his round, the pilgrim offers *piṇḍas* to the spirits of his ancestors and a final gift to the *gayāwāl*, before whom he prostrates himself. The *gayāwāl* touches him on the back, and blesses him with the word *suphal*, or 'fruitful,' assuring him thereby that his worship has been accepted.

Five shrines visited by pilgrims deserve particular notice. These are Rām Silā, a hill close to Gayā Town on the north, Pret Silā (540 ft.), about 5 miles to the N.W., and three others of less importance. Although a visit to these forms part of the regular tour of pilgrimage, the priests in charge are not *gayāwāls*, but an entirely distinct order, called *dhāmins*. These shrines are devoted to Yama and to evil spirits. An offering at Pret Silā, the Hill of Ghosts, is enjoined, so that Yama may not beat and bruise the ghosts of the dead. Similarly, at Rām Silā, his hell-hounds must be worshipped that they may not bark and bay at the unhappy spirits.² So, also, for the other three shrines. Here apparently we have Brāhmanism covering with its mantle not Buddhism, but the aboriginal demon-worship.

LITERATURE ON THE GAYĀ PILGRIMAGE.—Buchanan-Hamilton, *The History, Antiquities, Topography, and Statistics of Eastern India . . . collated from the original Documents at the E.I. House by Montgomery Martin*, London, 1838, vol. I. p. 51 ff. (this is B.-H.'s MSS [1807-1816], edited by Martin, commonly cited as 'Martin's Eastern India'); Rājendralāla Mitra, *Buddha Gayā, the Hermitage of Śākya Muni*, Calcutta, 1878, p. 9 ff.; L. S. S. O'Malley, *Gazetteer of Gayā*, Calcutta, 1906, pp. 59 ff., 214 ff., 217 ff.

5. Mahābodhi.—Gayā's chief title to fame lies in the famous temple of the Mahābodhi (the Great Enlightenment), situated in the village of Bodh Gayā (Gayā of the Enlightenment, often miscalled Buddha Gayā), about six miles to the south of Gayā Town on the west bank of the river Nilājan. Here is the *Bodhi-druma*, under which Gautama sat and received enlightenment. For nearly 2400 years this tree has been as sacred to Buddhists as the cross is to Christians. Pilgrims from all parts of eastern Asia have flocked, and still flock, to it; and its surroundings have been adorned with temples and monasteries by kings, not only of India, but of distant countries such as Ceylon and Burma.

For an account of Gautama's experiences of this spot, reference may be made to the art. BUDDHA (vol. II. p. 882). Here we shall confine ourselves to such facts as are necessary for the description of the locality. When Gautama visited Gayā as a Hindu ascetic, he passed some time on the Gayā-śiṛṣa hill, the modern Brahmjūni; but, finding there no peace, he went on, with his five disciples, to the village of Uruvilvā, the modern Urēl, close to Bodh Gayā. Here he passed six years in the most extreme asceticism, and then, becoming convinced that this was not the way to win the truth, he resumed the life of a mendicant, living upon alms. His disciples deserted him, and he wandered forth seeking for the place where he should obtain perfect knowledge. On the way he met a grass-cutter and asked him for some grass. This he spread under a neighbouring pipal tree (a kind of fig, *Ficus religiosa*)³ and sat upon it, taking his famous vow that, though his body were to shrivel up, though his skin, flesh, and bones were to rot to nothing, never would he rise from the seat till

¹ This fig-tree must not be confused with the Bodhi-tree, which is a pipal tree, an altogether different kind of fig. The *aksayavaṭa* is a banyan tree.

² *Gayā Gazetteer*, 71 ff.

³ According to Bloch, 141, the worship of this sacred tree can be traced back to very ancient times, long before the foundation of Buddhism, and the Buddhists selected it as the actual site of the Great Enlightenment merely on account of its previous sanctity. At the same time, Bloch does not question the Buddhist tradition as to the main facts of the Buddha's enlightenment occurring at Uruvilvā.

he had obtained the true knowledge. Then commenced the assaults of the Tempter, Māra, and the long night vigil. During the first watch he completed the meditation which enlightens the understanding; during the second he accomplished the meditation of ecstasy; during the third, the meditation which has no object of thought—a simple, but absolute, concentration of the mind upon itself; and, lastly, during the fourth, the meditation which is devoid of all pleasure and pain, and is absolute knowledge.¹

The place where Gautama spread the grass, and on which he sat, was evidently the mud platform which to the present day is built round the largest pipal tree in each village of North India, where the elders meet, and where learned men discourse on religious topics. In later times it was called the *Bodhi-maṇḍa*,² or 'Seat of the Enlightenment,' and in still later tradition it became the *Vajrāsana*,³ or 'Adamantine Throne,' believed to be the stable, indestructible centre of the universe. The tree itself was the *Bodhi-druma*, or 'Tree of the Enlightenment.' Gautama, now 'The Buddha,' or 'The Enlightened,' on accomplishing his vow, remained meditating for seven days under the tree. His subsequent actions are described in *ERE* ii. 882, and need not be repeated here. Suffice it to say that the remains of a cloister still exist which was built by Aśoka over the place where Gautama is said to have walked up and down for seven days in his first raptures of emancipation, and where flowers sprang up beneath his feet.⁴

6. The *Bodhi-druma*.—A pipal tree universally known as the *Bodhi-druma*, with a stone platform beneath it, identified as the *Vajrāsana*, exists on the west side of the great temple at the present day, and the question of the authenticity of the former naturally arises. The pipal is a quick-growing and comparatively short-lived tree, and it is impossible that the present one should be the identical tree under which the Buddha sat. There is, however, credible evidence that it is a descendant of the original *Bodhi-druma*, propagated by seed from generation to generation. According to Hiuen Tsiang,⁵ that tree, or one of its successors, was cut down and burnt in the 3rd cent. B.C. by Aśoka in his unregenerate days, but was miraculously restored from its ashes. Overcome by the portent, the king worshipped it so zealously that he forgot to return home. The same night, in her jealousy, his queen had it cut down again, but again it came to life. Śāsānka, the enemy of Buddhism, again destroyed it about the 6th cent. A.D., but a few months afterwards Pūrṇavarmā, the last descendant of Aśoka, by pious efforts restored it to life, and in one night it became ten feet high. He then built a wall round it, which Hiuen Tsiang saw. In 1811, Buchanan-Hamilton⁶ described how the tree in his time was in full vigour, but did not appear to be more than a hundred years old. Cunningham⁷ in 1862 found it in the last stage of decay, and in 1876 what remained of it was blown down in a storm, and a seedling from it was planted in its place. This is now the tree which is the object of

¹ *Buddha Gayā*, 39; cf. *Lalitā-vistara*, xxii.

² *Lalitā-vistara*, xix.

³ Hiuen Tsiang (Beal, ii. 116; Watters, ii. 114).

⁴ See G. A. Grierson, in *Proc. As. Soc. of Bengal*, 1896, p. 52 ff. The bases of most of the cloister-pillars still exist *in situ*, and not only do some of them bear masons' marks in the Aśoka alphabet, but one supplies a missing character, that for ṅ, not found elsewhere.

⁵ Beal, ii. 117; Watters, ii. 115. Bloch, p. 140, considers that Aśoka's action in destroying the tree was due to his objection to tree-worship, which he considered to be included among those 'despicable and useless rites' that are 'unproductive of any results,' and should be avoided. He also (p. 141) maintains that Śāsānka's destruction of the tree occurred in the course of a war with Pūrṇavarmā, and that it was dictated by political considerations and not necessarily by hatred to Buddhism as a religion.

⁶ Martin's *Eastern India*, I. 76.

⁷ *Mahābodhi*, 30.

Buddhist worship. We have already seen that the *Bodhi-druma* is also worshipped by Hindus as part of the Gayā pilgrimage. When the new seedling was set up in the old site, another was planted a short distance off by J. D. Beglar, then in charge of the restoration of the temple, and allotted specially to Hindus. There are thus now two *Bodhi-drumas*—one Buddhist, and the other Hindu.

The legends of the miraculous resuscitation of the tree are no doubt to be explained by the simple expedient adopted on the last occasion, or by the method of dropping a seed into a hollow of the dead or dying tree. In the course of centuries, owing to inundations from the Nilājan river, the whole level of the ground has been greatly raised, and in 1880, Cunningham found, thirty feet below the present level of the *Vajrāsana*, two pieces of an old pipal which may well have been fragments of the tree destroyed by Śāsānka 1300 years before.

7. The temple.—In the 3rd cent. B.C. the Emperor Aśoka built a temple and a monastery close to the Bodhi tree at a cost of 100,000 pieces of gold. A representation of the temple as it stood in the 2nd cent. B.C. exists in a bas-relief of the Bharut *stūpa* in Central India. It was an open pavilion, supported on pillars. In the middle lay the *Vajrāsana*, immediately behind which was the tree. Nothing now remains of Aśoka's temple but the *Vajrāsana*, a stone step of the entrance, portions of the foundations, the ruins of the cloistered walk, and a portion of the surrounding stone railings. The walk has been already referred to. The portion that has survived is nearly the whole row of bases of the pillars on the northern side of the walk, with a large fragment of what was probably one of the pillars. The bases of the southern row of pillars also exist, but are hidden within the foundations of the later temple.

Much better preserved is the famous so-called Aśoka railing.¹ It originally consisted of sixty-four stone pillars connected by massive stone rails. It was altogether about 250 feet in length and surrounded the whole building. The pillars and rails are covered with sculptures, and several can be dated by the fact of their bearing inscriptions in the Aśoka 'Brahmī' character. When, in later times, the present temple was built, the circuit had to be enlarged to about 520 feet, requiring double the number of pillars; and the original railing was evidently rearranged and added to. The remains of 62 of the pillars of this greater enclosure are approximately *in situ*. About half a dozen have been removed to South Kensington and to the Indian Museum in Calcutta, and 23 more, which until recently have been in the various courts of the present Śaiva monastery near by, have been restored to their proper place round the temple.² The railing forms one of the oldest sculptured monuments in India. The pictures carved in the stone are of the most diversified character—spirited and often graceful—and, considering their age, are in a wonderful state of preservation.

Aśoka's temple fell into ruins from lapse of time, and we learn from a Burmese inscription found in the neighbourhood that a new one was built at a date not stated, but which Cunningham³ fixes as during the reign of the Indo-Scythian kings in the 2nd cent. A.D. This he considers to be the existing temple. It was visited by the Chinese pilgrim Fa Hian in the 5th, and by Hiuen Tsiang in the 7th century. The latter gives a detailed description of the building as he saw it, and this closely

¹ According to Bloch, p. 147, the oldest pillars of this railing date from the middle of the 2nd cent. B.C., or a hundred years after the time of Aśoka. It has hitherto been believed that the Bhārhut sculpture represents the original temple of Aśoka, but Bloch (p. 144 ff.) does not agree.

² *Gayā Gazetteer*, 55; Bloch, 142.

³ *Mahābodhi*, 21.

agrees, even to the measurements, with what we have before us now.¹ He also tells us of hundreds of *stūpas* and *chaityas* with which the precincts were crowded. These, together with numerous monasteries and minor temples erected in later times, are now represented by mounds covered with trees to the north of the main building. This in the 11th cent. had fallen into ruins and was twice repaired by missions from Burma. At the end of the 13th cent. came Musalmān domination, and the place became a scene of desolation, although still visited by pilgrims. Cunningham believes that the holy tree and temple were, as above described, appropriated for Hindu worship in the first years of the 14th century.² At the end of the 15th cent. a Hindu ascetic founded a *maṭha*, or Saiva monastery, close to the temple. It was largely built from materials taken from the ruins, and several valuable sculptures have since been disinterred from its wall. In or about the year 1727 the then *mahanth*, or abbot, received the village in which the temple stood, in grant from the Emperor of Delhi, Muḥammad Shāh; and since then the Buddhist shrine has been in the possession of Saiva ascetics, although Buddhist pilgrims are freely allowed to come and worship, their gifts being made to the *mahanth*. In 1811, Buchanan-Hamilton³ described it as 'in the last stages of decay compatible with anything like a preservation of its original form.' In 1876 the king of Burma deputed officers to repair it, and, the attention of the Government of Bengal being drawn to the matter, in 1877 a celebrated Sanskrit scholar, Rājendralāla Mitra, was asked to visit the spot and to report as to what was being done. His report is embodied in the work entitled *Buddha Gayā*, published in 1878. It was evident that the Burmese repairs were being done without any regard for archæological fitness. The Government accordingly took the work of restoration into its own hands, and completed it in 1894. This was carried out by J. D. Beglar, under the superintendence of Cunningham. The work done has been subjected to much adverse criticism; but, in the opinion of competent judges, the temple has been repaired as effectively and successfully as funds permitted, and the site immediately surrounding it has been excavated in a manner which will bear comparison with the best modern work elsewhere.⁴

As it now stands, the temple consists of a main tower, rising to a height of 180 feet, in the form of a slender pyramid springing from a square platform, on the four corners of which are similar towers of smaller size. The outside walls have niches for the reception of statues, and access to the temple is obtained through an eastern gate, supported by pillars, which opens into an ante-room in front of the sanctum. In the latter is the principal image, a large mediæval statue of the Buddha. On an upper floor another chamber contains a statue of Māyā Devī, his mother. Owing to the general rise in the level of the country, the temple now stands in the centre of a great sunken courtyard, and one of the most interesting sights is the immense number of votive *stūpas* of all sizes, from actual small temples to little stone models hardly a foot high, with which the surface of the latter is crowded. These are only a small proportion of those dug up. Room could not be obtained for more. Several others are stored in a bungalow near by; and, before their removal was forbidden, hundreds were

¹ So Cunningham, *Mahābodhi*, 18. Watters, while admitting the possibility of the two buildings being the same, contends that Hiuen Tsiang's description does not agree (ii. 117 ff.).

² *Op. cit.* 56 f.

³ *Op. cit.* i. 72.

⁴ *Gayā Gazetteer*, 52. The account of the temple immediately following is taken from p. 51 of the same work.

carried away by visitors as mementoes of the birthplace of Buddhism.

LITERATURE ON MAHĀBODHI.—Buchanan-Hamilton, *ap. Martin's Eastern India*, as above: *Archæol. Survey of India*, esp. vols. i. lii. xi. and xvi. (Preface) (Cunningham), and viii. (Beglar), Calcutta, 1871, 1873, 1880, 1883, and 1878 respectively; Rājendralāla Mitra, *Buddha Gayā*, as above; A. Cunningham, *Mahābodhi, or The Great Buddhist Temple under the Bodhi Tree at Buddha Gayā*, London, 1892; L. S. S. O'Malley, *Gazetteer of Gayā*, as above; T. Bloch, 'Notes on Bodhi Gayā', in *Rep. Arch. Surv. Ind. 1908-9*, Calcutta, 1912, pp. 139-158. The travels of Fa Hian and Hiuen Tsiang should also be consulted. The editions referred to are S. Beal, *Sī-yu-ki, Buddhist Records of the Western World*, London, 1884, for both; and T. Watters, *On Yuan Chwang's Travels in India (629-645 A.D.)*, do. 1904-05, for Hiuen Tsiang (Yuan Chwang).

8. Other sacred places.—The District is so covered with sacred spots, nearly all of great antiquarian interest, that only a selection of the more important can be mentioned here. Amongst the Hindu sacred places may be mentioned the temples of Deo, Umgā, and Konch. In Deo, which is about 40 miles S.W. of Gayā Town, there is a fine temple built of cut stone without cement, and sacred to the sun, dating from the 15th century. Six miles distant, at Umgā,¹ which was formerly the head-quarters of the present Rājā of Deo's family, there is another very similar temple now in ruins. It was built A.D. 1439, and was dedicated to the Vaiṣṇava deities Jagannātha, Balabhadra, and Subhadra. The temple at Konch, about 20 miles N.W. of Gayā, is of brick, and is lighted by a tall opening in front formed with overlapping courses of brick, after the fashion of the Mahābodhi temple. In general appearance, however, it is more in the style of the Deo and Umgā buildings, and probably dates from the same period. According to orthodox Hinduism, the name of the ninth of the ten great incarnations of Viṣṇu is the Buddha. The merciful and gracious Viṣṇu took this form to secure the damnation of heretics by leading them still further astray. Curiously enough, in this temple there is a carving representing the ten incarnations, in which the Buddha incarnation is omitted, the total of ten being made up by dividing the fifth, or dwarf, incarnation into two scenes.

About thirty miles east of Gayā, at Sitāmaṛhi, there is a notable isolated boulder, in which has been hollowed out a small chamber 16 ft. long by 11 ft. wide. The interior is highly polished, and contains several sculptures. It is said to have been the residence of Sitā, the wife of Rāma Chandra, during her exile; and here her son Lava was born. The rock-cave was constructed for her by Viśvakarman, the architect of the gods, at the request of the poet Vālmiki, the author of the *Rāmāyana*. He lived at the neighbouring village of Bārat. The wide high level ground near the boulder is said to have been the field of the battle fought by Lava and his brother Kuśa against Rāma's army. This is not the only site connected with the Rāma saga. Some twenty miles to the S.E. of Sitāmaṛhi lies the romantic Singar valley. Here, on the mountain of Sringirikh, was the home of the saint Rīṣya-śringa. The legend regarding him is long and fantastically poetical. In this place it is sufficient to say that he ultimately married Sāntā, the daughter of King Daśaratha, and performed the sacrifice for his father-in-law that brought about the birth of Rāma.

For Buddhistical remains we may first mention the Barābar Hills, about 16 miles north of Gayā. Here there are seven artificial caves or chambers hewn out of the solid rock. Inscriptions show that four of them were excavated by Aśoka, and three about 231 B.C. by his grandson Daśaratha, for the use of ascetics called Ajivikas. It has not been definitely settled who these people were.

¹ See Kittos, in *JASBe* xvi. [1847] 656 and 1221; *Rep. Arch. Surv. Ind.* xi. [1880] 140.

They may have been Hindu Vaiṣṇavas, or Jains, or Buddhists.¹ Most of the caves have been left in the rough, with the marks of the chisel still visible, but in one or two the surface inside is highly polished, and there are handsome carved entrances. Near the Barābar Hills are Dharāwat, the site of the Buddhist monastery of Gunamati, and the lofty Kauwādol Hill, at the foot of which lay the monastery of Silabhadra. Both were visited by Hiuen Tsiang in the 7th century.² Rājagriha, the old capital of Magadha, where the Buddha lived and preached for many years, is just beyond the border, in the Patna District, but in Gayā there is the Jethian Valley leading into it. This is full of remains, and many legends of the Buddha are connected with it. The name is a corruption of *Yaṣṭivana*, or the forest of the staff, so called from a bamboo staff which was used to measure the Teacher's body, and then took root and developed into a forest. Hiuen Tsiang has left a detailed account of the locality and of the associated legends.³

The Kukkuṭapāda Giri, or Cock's-foot Hill, is another site mentioned by Hiuen Tsiang.⁴ Here Mahā-Kaśyapa, one of the earliest and greatest of the Buddha's disciples, lies buried, the mountain having cleft asunder to receive him. Here the Saint sleeps, awaiting his resurrection, when the coming Buddha, Maitreya, shall arouse him and cause him to enter into *nirvāna*. Three different places have been suggested as the site, and Stein's identification⁵ of the Hasrā Hill, about 12 miles east of Gayā, is the one which is now generally accepted. There are many other Buddhist sites of great archaeological and historical interest in the District, regarding which reference must be made to the authorities quoted at the end of this article.

9. Popular religion and folklore.—The popular religion of Gayā does not differ in its general character from that of the rest of Bengal (see *ERE* ii. 482 ff.). Uneducated Hindus and Musalmāns alike have a whole pantheon of village godlings, ghosts, and malignant spirits, whom they worship, or, when occasion arises, exorcize. As for Hindus, the elastic nature of the orthodox form of belief allows all these to be included in the religious system. There are practically no traces of Buddhism, although the present writer, in the year 1891, found a few ignorant villagers in the north of the District who worshipped a certain 'Baudh Deo' (Skr. *Baudha Deva*), whom the educated clerks in charge of the census then being carried out identified with the Buddha incarnation of Viṣṇu.⁶

We have seen (p. 183^b) how Hinduism has absorbed a part of the folk-religion of demon-worship into the official cult at Rām Silā and Pret Silā. On the other hand, the Buddhist images and broken sculptures which can be dug up in most villages in Magah have been utilized by the common folk as idols, representing in each case any particular god or godling with whom the superstition of the finder wished it to be identified. As a good example, in the early nineties the writer discovered a fine image of the Buddha buried in the ruins of Rājagriha. After cleansing it from the encrusted earth, he sent it off to his camp in charge of a village

¹ See G. Bühler, in *IA* xx. [1891] 361 ff. Bühler, following Kern, considered them to be Vaiṣṇavas; see, further, art. *АШИВКАВ*. K. B. Pāthak (*IA* xli. [1912] 88 ff.) shows that Jains considered them to be Buddhists. D. R. Bhandarkar, with whom the present writer agrees, maintains (*JRASo* xxi. 403 ff.) that they were a distinct sect, neither Buddhist nor Jain.

² Beal, ii. 104 ff.; Watters, ii. 108 f. Hiuen Tsiang narrates some interesting stories about both these places.

³ Beal, ii. 145 ff.; Watters, ii. 146. See also M. A. Stein, 'Notes on an Archaeological Tour in South Bihar,' in *IA* xxx. [1901] 61 ff., 81 ff.

⁴ Beal, ii. 142; Watters, ii. 143.

⁵ *Loc. cit.* 84-90. For another identification, see Rakhal Dās Banerji, in *JASB*, new ser., ii. [1906] 77 ff.

⁶ See the remarks regarding the Konch temple (above, p. 185^b).

watchman of the Dusādhs caste. When he himself returned to his camp in the evening he found the sculpture covered with a mess of oil and vermilion. On inquiry, he learnt that on the way to camp the watchman had made up his mind that it was an image of his tribal godling, had set it up *en route*, anointed and worshipped it, and made oblations to it.

Evil spirits, called *bhūt* and *dānk*, are worshipped with intent to propitiate. If properly treated, they are useful as field-guardians, striking with disease any one who pilfers crops under their protection. In the jungle-covered Rāmgarh, such spirits have a market value, and an *ojhā* (Skr. *upādhyāya*), or wizard-exorcist, will charge a good price for such a one safely shut up in a bamboo bottle and delivered to a low-caste cultivator. Most of these maleficent spirits are ghosts of some one who has come to an untimely end. Sometimes they enter into and possess a man or woman, and the services of an *ojhā* are required to expel them. Cf. DEMONS AND SPIRITS (Indian), vol. iv. p. 607^a.

Several of the castes worship deified heroes, each having its own. Thus, the Bhogtās worship Bān Singh; the Dusādhs, Goraiyā and Sālhes; and the Goālās, Lorik. The last two are the subjects of folk-epics of great interest. Sālhes was the great Master-Watchman, who conquered Chuhaṛ Māl, the corresponding Master-Thief. Dusādhs themselves are usually either thieves or watchmen. The epic of Lorik is of interminable length, and his exploits were not confined to Gayā. He was an Indian Paris who carried off a dusky Helen, and ultimately became a just and powerful ruler. He conquered Sālhes, here a thief, and ended his days at Benares, where, with the members of his family, he was turned into stone. He is also localized and sung of by Goālās in other neighbouring districts, such as Shāhābād, Mīrzāpur, and Baliā.¹

Musalmān villagers also have their own godlings. The most famous are the five *Pīrs*, worshipped all over northern India. These are, properly, the five Holy Persons of Islām,—Muhammad, 'Alī, Fātima, Ḥasan, and Ḥusain,—but practically they mean any five saints whom a man remembers or worships.² All that is required is that a *Pīr* must be a holy man, and that he has departed this life. Another Musalmān saint of wide celebrity, Chānd Saudāgar, is said to be buried at Dariyāpur Pār-batī, in the north-east of the District. The shrine at which he is worshipped is on the site of an ancient Buddhist *stūpa*, probably that erected by Aśoka to commemorate one of the Buddha's miracles.³

Other mythical personages are also worshipped by Musalmāns. Amongst them we may mention Shaikh Saddū, a sort of Aladdin, who found a wondrous lamp that controlled genii, and who lost his life through its misuse. Kamālo Bibī, a female saint, who is said to have lived in the time of a Buddhist Rājā Kanaka, and regarding whom many wondrous miracles are reported, is specially worshipped by women who desire offspring; but Hindus and Musalmāns of both sexes resort to her shrine for exorcism or the cure of any disease.⁴

More distinctly Hindu is the worship of Sultān Shāhid. Both Musalmāns and low-caste Hindus pay adoration to him. His shrine is commonly close to a temple of the Hindu goddess Devī, and cocks are offered in his honour before the worship of Hindus directed to her. Some regard him as the bodyguard, and others as the paramour, of Devī.⁵

¹ For the story of Sālhes, see G. A. Grierson, *Maithili Chrestomathy*, Calcutta, 1882, p. 3 ff. For Lorik, see *Arch. Surv. Ind.* viii. 79 ff. It is noteworthy that in the latter the principal god is the old Aryan deity Indra.

² R. Temple, *Legends of the Panjāb*, London and Bombay, 1885, ii. 372; W. Crooke, *PR*, Allahabad, 1894, p. 129.

³ *Arch. Surv. Ind.* viii. 108 ff., xv. 6 ff.

⁴ For Shaikh Saddū, see *Gayā Gazetteer*, 79. For the legends of Kamālo Bibī, see *Arch. Surv. Ind.* xvi. 37 ff.

⁵ *Gayā Gazetteer*, 80.

GENERAL LITERATURE REGARDING GAYĀ DISTRICT.—Buchanan-Hamilton, *op. Martin's Eastern India*, as above, vol. i., London, 1888; *Archæological Survey of India*, vols. i. iii. viii. xv. and xvi., Calcutta, 1871, 1873, 1878, 1882, and 1883 (vol. viii., by Beglar, is especially full of information, and contains an immense amount of folklore); G. A. Grierson, *Notes on the District of Gayā*, Calcutta, 1898 (the author does not now maintain the correctness of the economic chapters of this work, which are out of date); L. S. S. O'Malley, *Gazetteer of Gayā*, as above.

G. A. GRIERSON.

GAYATRĪ.—See HYMNS (Vedic).

GEHENNA.—See ESCHATOLOGY.

GENIZAH.—The name of the room in which damaged manuscripts of the Bible or other writings withdrawn from use are preserved, as well as a collective term for the writings so preserved. The substantive *g'nizāh* signifies properly the act of preserving, as *nomen actionis* to the verb *gānaz*, and occurs in the ancient Jewish literature which has been handed down to us only in the collocation *bēth-g'nizāh*, with which (in the meaning 'treasure-house') an old Tannaitic note explains the word *yēhāsēn* in Is 23¹⁸ (see *Pesahim*, 118b). *Bēth-g'nizāh* is the same as Aram. *bēth-ginzn* (Ezr 5¹⁷ 6¹), from which the New Hebrew word *bēth-g'nāzīn* is derived (occurring in many passages of the Bab. Talmud: *Shabb.* 10b, 105b; *Pesah.* 119a; *Kethub.* 111b; *Sanhed.* 104a, 109a). The verb *gānaz* means 'to conceal something,' 'to preserve carefully,' as one preserves things of value or treasures. In the *Hālākhā* (the tradition of religious law) the verb is applied to describe the laying aside and concealing of such sacred objects as for some reason or other can no longer be used but may not be destroyed. In order to prevent such objects from being profaned, they must be carefully concealed and preserved. In the instructions on the subject, the expression used is *gōn'ztn*, or in the passive *yiggānez* or *ta'ūn* (plural *ta'ūnīn*) *g'nizāh* ('marked for preservation'). Besides the instructions of the *Hālākhā* there are also reports, partly of a historical and partly of a legendary character, which—with the use of the verb *gānaz*—relate of certain articles that they were 'concealed.' The Hasmonæans, when they purified the temple, concealed the stones of the desecrated altar in one of the temple chambers (M. *Middoth* i. 6); it is the same fact which is mentioned in 1 Mac 4⁴⁶. (According to *Tosefta*, *Megilla* iv. 15, the stones of the temple building which had become worn were concealed.) According to a tradition of a priestly family, there was a room in the temple where the sacred ark was concealed (M. *Sh'qālīm* vi. 1, 2). It was said that king Josiah, in order to prevent the ark from being carried away to Babylon, concealed it, and 2 Ch 35³ was adduced in support of this view (Tos. *Soṭa* xiii. 1; *Yoma*, 52b, and elsewhere). In connexion with this view it was also asserted that the tent of meeting, i.e. the sanctuary erected by Moses, was concealed at the building of Solomon's temple (Tos. *Soṭa*, *ib.*). According to the view expressed by the Palestinian Jews in the writing at the beginning of 2 Mac (2⁶), it was not King Josiah, but the prophet Jeremiah (cf. Jer 3¹⁶), who concealed the ark, along with the tent and the altar of incense, and in fact hid them in a cave on the mountain (Nebo) which Moses had ascended before his death. In the same source we read too (1²³) that at the destruction of the first temple the priests, before they went into captivity, had concealed the fire of the altar. Here the Greek word used (*ἀπέκρυψαν*) is the same as we find in *Apocrypha*, and corresponds to the Hebrew *gānaz*. The information supplied by a well-known Tannaitic reporter, Abba Saul, seems quite credible, namely, that a sacrificial knife, which had become notched and unfit for killing the sacrificial animals, was concealed in accordance with a resolution of

the priests (*Zebāhīm*, 88a). In an old commentary on Lv 16²³ we are told that the linen garments worn by the high priest on the Day of Atonement must be concealed and not used again on the next Day of Atonement (*Sifra*, l.c. 82c, ed. Weiss; *Pesahim*, 26a, etc.). The command to conceal is especially emphasized with reference to the written text of the Bible and the writing of the Divine name. Those copies of the Bible which present an abnormal form of letters, or in which the sections are not divided in the traditional way, or in which portions of the text which ought to be written in *stichoi* are written continuously and inversely, are to be concealed as well as those in the preparation of which the prescribed ink was not used or in which the Divine names were written in gold (*Sifre* on Dt 6⁹; Bar. *Shabb.* 103b). It is also related (*Sopherim* i. 10) that the scribes ordered a manuscript belonging to a certain Alexander (*v.l.* 'the Alexandrians'), which had been shown to them and which had the Divine names written in gold, to be concealed. The command to conceal refers also to copies of the Bible which a heathen had written (*Gitṭin*, 45b), to remnants of those copies which had been eaten by cockroaches (M. *Shabb.* ix. 6), and to covers and holders which had been used to preserve Bibles (*Megilla*, 26b). Many other objects of this kind which had served a sacred purpose (*tashmishē q'dushsha*), as, e.g., the bands of the phylacteries, were concealed (*ib.*). If a heathen offered a beam of wood for the purpose of building a synagogue, and the dedication with the name of God was written on the beam, then the part containing the name of God must be cut out and concealed (Tos. *Megilla* iii. 15; *Arakhin*, 6a). The same instruction applies to stones on which the name of God is written (Mas. *Sopherim*, v. 13), to handles of house utensils, or the feet of bedsteads on which the Divine name had been inscribed (*Shabb.* 61b; *Arakhin*, 6a). Other instructions belonging to the casuistry of the Tannaim on this subject, as it meets us in the *Hālākhā*, are the following. If a wife suspected of unfaithfulness refuses to drink the 'bitter water that causeth the curse' prescribed for her in Nu 5^{17a}, then the roll on which the words of cursing are written (5²³) must be concealed and not used on another occasion (M. *Soṭa* iii. 3). If the whole property of a city which has gone over to idolatry (Dt 13^{12a}) is given up to destruction, then the tenth of all that is found in it as well as the copies of the Bible must be concealed (*Sanhed.* 112b). From the casuistry of the 'Amoraim we have the decision that a roll of the Pentateuch which had on every page (column) three errors must be hidden (*Menahoth*, 29b). With regard to sacred books written in any other language than Hebrew, the Tannaitic tradition tells us (M. *Shabb.* xvi. 1) that they must be concealed. That is a command which is to be treated with the same consideration as the prohibition of the use of written translations of the Bible, which, in fact, remained only theory, like the prohibition of fixing the oral tradition in writing. But, as an ancient piece of evidence for that command, the instance of Gamaliel I. is adduced (Tos. *Shabb.* xiv. 12; Bar. *Shabb.* 115a), who ordered a Job Targum, which was laid before him as he stood on the temple mountain, to be walled into a layer of stone (*nidbāk*) which was just at the moment being laid. His grandson, Gamaliel II., after he had heard of the action of his grandfather, as he on one occasion read the Job Targum in Tiberias, caused it also to be placed in concealment (*ib.*). This double anecdote shows us, first of all, how this 'concealing' of books was at times carried out, but also that the books so removed from use were preserved in other copies, and that the fact of their concealment was often

forgotten. Regarding the intentional 'concealment' of individual books of the Bible, we possess definite information about the prophecy of Ezekiel (*Shabb. 13b*) and the writings of Solomon (Proverbs [*Shabb. 30b*]; *Qoheleth* [*ib.*, *Leviticus Rabba*, c. 25 *ad init.* *Qoh. R.* to 1² and 11⁴]; both along with Canticles [*Aboth of R. Nathan*, c. i.]). In the last-mentioned source (ed. Schechter, p. 2) the tradition held by Abba Saul, the Tannaitic teacher already referred to, is as follows: 'In the beginning people said that Proverbs, Canticles, and Ecclesiastes were "concealed" (*g'núzim*), because they were only fictions and did not belong to the Holy Scriptures, and for this reason they ought to be concealed. It was the men of the Great Synagogue who first came and, by means of their explanation of those passages of these books which gave offence, brought it about that they were again received among the sacred writings.' This tradition is the only one in which the expression *g'núzim* (= Apocrypha) occurs as the term for such writings as are no longer in use. King Hezekiah is praised for having concealed a 'book of means of healing' (*M. Pesahim* vi. 56a; *Berakh. 10b*; cf. *Jerus. Sanhed. 18^b*). Regarding the 'Book of the Genealogies,' which, according to *Pesahim* (62b), was 'concealed,' see Schechter in *ExpT* xvi. (1905) 186. In relation to the Apocrypha of the OT, especially the Book of Sirach, which alone is mentioned in the Jewish traditional literature, there is no mention in the Tannaitic sources that it had been 'concealed.' But the Amora Joseph (head of the school of Pumbeditha, who died 333) speaks expressly of the fact that the scribes (the old authorities) have 'concealed' (*gān'zū*) the Book of the Son of Sira (*Sanhed. 100b*; see *ExpT* xvi. 236).

No particulars regarding the act—how the 'concealment' of sacred writings no longer in use and of fragments of the text was to be carried out—are contained in the traditions either of the Tannaim or of the Amora'im. Only a 4th cent. utterance of a Babylonian authority (Raba) is preserved, according to which a Pentateuch roll, which through age had become unfit for use, was concealed by placing it beside a scholar in his grave. Another of the Babylonian Amora'im (Aḥa b. Jacob) remarks in reference to this, in connexion with *Jer 32¹⁴*, that it was done by previously placing the roll in an earthen vessel (*Megilla, 26b*). On the authority of these two statements, the following precept is accepted in the Codex of Maimonides (*Mish. Torah, Hilkh. Sefer Torah* x. 3): 'A Pentateuch roll which has become old or unfit for use is to be laid in an earthen vessel and buried beside a scholar. In this consists its concealment' (*g'nizātāh*). This has been verbally carried over into the Codex of Joseph Karo (*Yoreh De'ah*, ch. 282, § 10).

The practice of the Jewish congregations had so developed that not only Bible manuscripts (and in later times printed Bibles) which had become unfit for use, but all Hebrew writings or fragments of these, as soon as they were useless, were brought to some room or other in the synagogue-building which was difficult to reach, and in this way preserved from profanation. Since the special aim here in view was to protect the Divine names contained in these hidden writings, the whole of the latter came to be called *Shēmōth* ('Names,' i.e. Divine names). From time to time the contents of the Genizah, in accordance with the instruction mentioned above, were deposited in the cemetery. That takes place still with great pomp—e.g. in Jerusalem. In the *Revue des Ecoles de l'Alliance Israélite*, 1901 (p. 103), there is an article on the burying of the Genizah which took place in Rustchuk (Bulgaria) in April of the same year:

'A large tent is erected in the cemetery; several rows of chairs are placed before the tent, in the neighbourhood of an erection after the form of a holy ark. Into this, after a sermon by the Rabbi, there are brought about two hundred small sacks, containing the writings which are to be buried. Then the right to take part in the burial is put up for auction among those assembled. Thereafter each carries his sack, and lays it into a grave which has been previously prepared. Then the grave is covered in, and receives later a monument with the inscription: "Genizah of the year 1901, Rustchuk."'

Regarding similar burials of the contents of the Genizah in the Jewish congregations of the East or of North Africa, see *JE* v. 613.

The instruction to bury the Genizah was, however, not always or in all places carried out. And so the Genizah has been preserved which in our day, like a real treasure-house, has disclosed its riches in precious remnants of the ancient Jewish literature—the Genizah of the ancient Ezra synagogue in Cairo. It was discovered in 1864 by the learned Jewish traveller, Jacob Saphir (see his book of travels, *Eben Sappir*, Lyck, 1866, p. 21b), who, however, had no idea of the importance of his discovery, and took with him only a few worthless leaves. Elkan N. Adler, too, who in 1888 visited the synagogue, did not succeed in getting the Genizah opened. A. H. Sayce was the first who succeeded in securing a considerable amount from the Cairo Genizah, after a part of the contents of the same had in the meantime, on the occasion of the synagogue undergoing repairs, been taken out and buried. This circumstance brought it about that, even before the whole Genizah was taken out by Schechter, many parts of it were offered for sale in Egypt. Among the parts purchased by the learned sisters Mrs. Lewis and Mrs. Gibson was that fragment which was recognized on 13th May 1896 by Schechter's acuteness as belonging to the Hebrew original of Sirach, and thus in so unexpected a way prepared for the rediscovery of this original. It was Schechter, too, who in 1897 went to Egypt, and, being authorized by the Jewish congregation there, removed the whole Genizah from Cairo, and brought these fragmentary manuscripts, whose value cannot be overestimated, to Cambridge. Under the name of the 'Taylor-Schechter Collection' this unique collection is now the glory of the Cambridge University Library. Many parts of the Cairo Genizah, some earlier, and some later, came into other public libraries, particularly the Bodleian in Oxford, as well as into the hands of individual scholars and collectors in Europe and America.

The whole riches of the Genizah fragments will not be fully discovered till the Taylor-Schechter Collection has been completely catalogued. It is expected to cast a new light upon large departments of Jewish literature, and to increase in an unusual degree the material for the history of the literature and the culture of Judaism. The portions of these fragments which have already been published show us how they are fitted to enrich and deepen our knowledge. The discovery of the Hebrew Sirach, which was due to them, has already been mentioned. The fragments are particularly rich in literature of the Gaonic period, both in Hebrew and in Arabic, some very important pieces being extant. A great deal coming from Saadya himself, or relating to him and his time, has been published by Schechter, under the general title 'Saadyana,' in the *JQR* (also published separately, Cambridge, 1903). This periodical has, since the year 1896, given us very remarkable and interesting selections from the Genizah fragments, sometimes with facsimiles, and including specimens of the handwriting of Moses Maimonides. With regard to the Arabic portion of the Cairo Genizah in Cambridge, H. Hirschfeld commenced in January 1903 (*JQR* xv. 167 ff.) to publish immensely valuable communications. From his introductory

remarks on this part of the Cairo Genizah the following details, indicative of its contents, are supplied:

'Roughly estimated, they [the Arabic fragments] count about 12,000, mostly written on paper, but many (about one-fourth) on vellum. . . . At first sight it seemed advisable to divide the whole mass into two large sections, viz. those written in Hebrew characters, and those written in Arabic script. . . . The following is an alphabetical list of subjects ascertained up to the present: Astronomy and Astrology, Bible (text, translation, and commentaries), Bills and Accounts, Calendar, Children's exercises, Cufic pieces, Documents, Dreams (interpretation of), Fiction, Geography, Grammar, History, Homilies, Legends, Letters, Lexicography, Liturgy, Māsōrah, Mathematics, Medicine, Midrash, Mohammedan Tradition, Natural History, Philosophy, Poetry, Polemics, Polite Literature (*Adab*), Proverbs, Qabbālāh, Qaraites, Qorān, Responsa, Sūfism, Talmud and Rabbīnics.'

To complete this list, we call attention to another remark in Hirschfeld's introduction, that among the Arabic fragments of the Cairo Genizah there are many containing Muhammadan texts in the Hebrew script as well as Hebrew texts in Arabic script. This shows us to how great an extent the Jews of Egypt—from whose midst the greater part of these fragments has come—had adopted the Arabic culture of their environment.

Apart from the MSS fragments, which for the most part were brought to Cambridge, there are also in the Cairo Genizah fragments of very ancient Hebrew printing, from which important information was gathered as to the history of Hebrew typography as well as contributions to Hebrew bibliography. Elkan N. Adler reports, as a result of personal observation, on the Genizahs of some other ancient synagogues (Feodosia in the Crimea, Bukhara, Teheran, Aleppo), in art. 'Genizah,' in the *JE* (v. 613).

LITERATURE.—In addition to the literature mentioned throughout the art., reference may be made to Marcus Jastrow, *Dictionary of the Targumim*, London and New York, 1886-1908; J. Levy, *Neuhebräisches und chaldäisches Wörterbuch*, Leipzig, 1876-89.

W. BACHER.

GERMAN CATHOLICISM.—See DEUTSCH-KATHOLICISMUS.

GERMAN EVANGELICAL CHURCH.—See PROTESTANTISM.

GESTURE.—See HAND, HEAD, SYMBOLS.

GHAIK MAHDI.—'Ghair Mahdī' (lit. 'not [expecting a] Mahdī') is the name given to those sectarian groups in Indian Islām whose adherents believe that the Mahdī (*q.v.*)—the promised Messiah of the Muslims—has already come, and that, accordingly, the hopes which centre in the future advent of such a Divine messenger are now groundless and futile. Thus, in the District of Kirmān, Baluchistān, there still survives the tradition of an Indian Mahdī, Muhammad of Jaunpūr, who, it is said, appeared about the end of the 15th cent., was persecuted and expelled from India by the orthodox, and, after many wanderings, died in the valley of Helمند in 1505. In contrast to the orthodox—the Namāzī, *i.e.* those who observe the traditional *ṣalāt*-ritual—believers in this Mahdī call themselves 'Dhikrī' *i.e.* those who give preference to a kind of *dhikr* for the *ṣalāt*. Another sect of similar character is called 'Dā'ire wāle'; they live in the province of Mysore, and their faith is bound up with a Mahdī who appeared over four hundred years ago. In the 'night of destiny' (*lailat al-qadr*), hallowed in Muslim tradition,—the 27th of Ramadān,—they erect a stone-circle (*dā'ira*, 'circular wall'), within which they perform their peculiar ritual; and it is from this ritual of the *dā'ira* that their distinctive name is derived.

These Ghair-Mahdī sects display an intensely fanatical spirit towards orthodox Muslims, and, in fact, regard them as unbelievers. Their creed ends with the words: 'The Imām Mahdī has come and has gone away; whoso believeth not this is a *kāfir*'; and they find support for this article in the *hadīth*-saying, *man kadhdhaba bi-l-mahdī faqad kafara* ('he who denies the Mahdī is thereby an unbeliever'). Sell is undoubtedly right in holding that the Mahdist pretensions of the 10th cent. A.H. were an outcome of millenarian expectations, and purported to be a fulfilment thereof. The rise of the sects which thus stigmatized all other Muslims as heretics is the subject of a *fatwā*, given by Ibn Hajar al-Haitamī († A.H. 973=A.D. 1505) against them, in which he called upon the Muslim authorities to take drastic measures against their adherents.

LITERATURE.—G. A. Herklots, *Qanoon-e-Islam, or The Customs of the Moosulmans in India*², Madras, 1863, p. 269; E. Sell, *The Faith of Islam*³, London and Madras, 1907, p. 116; *Revue du monde musulman*, v. [1909] 142; I. Goldziher, *Vorlesungen über d. Islam*, Heidelberg, 1910, p. 268 f.; Ahmad Shihāb al-dīn ibn Hajar al-Haitamī, *al-Fatāwī al-hadīthiyya*, Cairo, Maimaniya Press, 1307 (A.H.), p. 27 ff.

I. GOLDZIEHER.

GHATS.—See BENARES.

AL-GHAZĀLĪ.—See ETHICS (Muslim).

GHEBERS.—See GABARS.

GHOST.—See DEMONS AND SPIRITS, DOUBLES.

GIANTS.—At the present day there is no human race of 'giants,' taking that word to denote men greatly above the average human stature. There are, indeed, families or groups of exceptional height. In his *Anthropological History of Europe* (Paisley, 1912, p. 168 f.) John Beddoe observes, selecting Scotland as the home of the tallest Europeans:

'The men of the Merse are among the finest in Britain. Probably the average stature is about 5 feet 9 inches (1752 millimeters): the fishermen are not so tall as the peasantry, but 25 of the latter, of pure local descent, who were measured and weighed by Dr. Charles Stewart of Chirnside, yielded the remarkable average of 5 feet 10½ inches in stature (1784 millimeters), and 199 pounds in weight. Here the weight exceeds, though the stature falls short of, the huge proportions of the men of Balmaclellan in Upper Galloway, who as yet, I believe, hold the record as to stature among all tested communities in Europe.'

As Beddoe places the average height of the Balmaclellan men at 5 ft. 10¼ in., or nearly 1790 mm., that may be taken as the highest stature of any race in Europe—leaving out of consideration the exceptional cases of individuals whose height is greatly above that of their kinsmen. Probably, also, the figures just quoted represent the maximum average height of any human family. The Tehuelches of Patagonia, although long regarded as of gigantic stature, are now ascertained to possess an average male height of 5 ft. 10 in., or 1778 mm. Some individuals among them are as tall as 6 ft. 4 in., or 1930 mm., but the same thing can be said of other races. The statements made by Bourne cannot be quite ignored, but the subsequent information supplied by more accurate observers points to exaggeration on his part. He thus describes the Patagonian natives:

'In person they are large; on first sight, they appear absolutely gigantic. They are taller than any other race I have seen, though it is impossible to give any accurate description. The only standard of measurement I had was my own height, which is about five feet ten inches. I could stand very easily under the arms of many of them, and all the men were at least a head taller than myself. Their average height, I should think, is nearly six and a half feet, and there were specimens that were little less than seven feet high.'¹

¹ *The Giants of Patagonia: Captain Bourne's Account of his Captivity amongst the extraordinary Savages of Patagonia*, London, 1853, p. 29.

It is possible that at the time of Bourne's captivity (1849) a sub-division of the Tehuelches contained a larger proportion of tall men than can now be seen in any Patagonian tribe. His statements are very explicit, and he undoubtedly indicates a race exceeding, by several inches, the Balmaclellan men reported to us by Beddoe, even if some allowance is made for exaggeration on the part of Bourne. In any case, however, the alleged stature of those Patagonians is not so much above that of normal Europeans as to entitle them to be seriously spoken of as 'giants.' Nor is there any other human race, existing at the present day, which has a greater claim to that title.

There are, however, many individual instances of abnormal height in modern times. The case of the Russian giant Machnov, who was exhibited in London in 1905, is perhaps the most striking. Although a well-made man, and free from the physical defects which often accompany 'giantism,' Machnov's stature reaches the amazing height of 9 ft. 3 in., or 2819 mm. A famous instance in the 19th cent. is that of Chang, the Chinese giant, who was 7 ft. 9 in., or 2363 mm., in height. Like Machnov, Chang was in all other respects normal, in mind and body. The same cannot be said of the 18th cent. Irish giant Magrath, whose great height (7 ft. 5 in., or 2261 mm.) was due to disease. Magrath lived only to the age of twenty-four, and he had the feeble intellect and figure associated with 'giantism' regarded as a disease.

In his book on *Giants and Dwarfs* (London, 1868), Edward J. Wood gives numerous cases of individuals of giant stature in the past. Thus, he refers to John Middleton, who was born at Hale, Lancashire, about 1572-1578, and who was commonly called 'the Child of Hale.' Middleton's height was exactly the same as that of the 20th cent. Russian Machnov, 9 ft. 3 inches. His portrait is preserved in the library of Brazenose College, Oxford. Then there is a painting by F. Zuccherio in Hampton Court Palace, representing a native of the Low Countries who was a household servant of Elizabeth of England, and whose height was 7 ft. 6 inches. Contemporary with him was a Piedmontese seen by Martin del Rio at Rouen, in 1572, who was 9 feet high. In 1581, Stow records in his *Chronicle a Dutchman* whose height was 7 ft. 7 inches.

Johannes Goropius Becanus, physician to the sister of the Emperor Charles v., in his *Origines Antwerpianae* (1569), and *de Gigantomachia*, attests that he saw a youth nearly 9 feet, and a man almost, and a woman quite, 10 feet in height. The man lived within a few miles of the author's own residence in Flanders' (Wood, p. 94).

In considering the possibility of a woman quite 10 feet in height, one must keep in view the following statement:

'Styve in his *Memorials* tells us that giants were introduced into May games, and that on May 26th, 1555, there was a game in St. Martin's-in-the-Fields (London) with, among other amusements, giants, which were in fact men on stilts' (Wood, p. 94).

This suggests an easy explanation of the great stature of the woman referred to by Becanus, as well as of many other nominal 'giants.' Nevertheless, it will not explain every instance. There is no reason to suppose, for example, that John Middleton, whose portrait is preserved in Oxford, was anything else than a real giant; and, although his height was immense (9 ft. 3 in.), it is exactly paralleled by that of the existing Russian giant Machnov.

With the exception of Magrath, the giants here cited appear to have been quite healthy people. Their great stature was not, therefore, the result of disease. To what cause was it due? The usual explanation is that such abnormal stature is merely caused in the same way as any other exceptional development in the animal or vegetable world; that is, by a favourable environment accompany-

ing a happy combination of elemental forces. On the other hand, it is sometimes maintained that giants and dwarfs, of healthy body and mind, illustrate the atavistic tendency and actually represent a remote ancestor belonging to a very tall or a very small race. The probability of a race of giants having once existed is strongly advocated by Th. Zell, who, indeed, is so firmly convinced upon this point that he considers it beyond dispute. He argues that, assuming the races of average height to represent normal mankind, the fact that dwarf races have existed makes the hypothesis of giant races a necessary complement. He points to the discovery of dwarf skeletons alongside those of a larger race in the Neolithic station at Schweizersbild in Switzerland; and with these might be compared the skeletons found in the caves at Mentone, some of which represent a stature of from 6 to 7 feet, while others, of a very different racial type, show an average height of 4 ft. 6 inches. Zell further argues that, just as the folk-tales concerning dwarfs are now found to have a substantial basis (although with a superstructure of fantasy), so the traditions of cannibal giants are traceable to an actual race of men of primitive type who practised anthropophagy.¹

There is, at any rate, no doubt that a belief in the former existence of a race of giants is very wide-spread, indeed world-wide. It is quite possible that the origin of this belief dates from the time when two races of markedly different stature, such as those of the Mentone caves, were closely associated together. The memory of the tall race, whose stature might be increasingly exaggerated, would live on among the smaller race, and thus form the basis of many wild and impossible tales. In some cases, however, the tales are not radically incredible. A critical examination of various Hebrew, Greek, and Latin stories of giants seems to disclose nothing more wonderful than exceptionally tall or strong men.

'The Highland giants were not so big but that their conquerors wore their clothes,' observes J. F. Campbell, with reference to the *samhairean* of Gaelic legend; 'they were not so strong that men could not beat them, even by wrestling' (*Popular Tales of the West Highlands*, London, 1860, vol. i. p. xcix).

Here there is no indication that the 'giants' in question were even taller than their opponents. Another Gaelic name for 'giants,' *samhanaich*, is similarly pointless, so far as regards stature. The word *samhanaich* is derived from *samh*, a fetid odour, and the people so designated obtained this name on account of their malodorous habits. J. G. Campbell records a West Highland story of a certain Tuairisgeul Mór, whom he describes as 'a giant of the kind called *samhanaich*—that is, one who lived in a cave by the sea-shore, the strongest and coarsest of any.' He adds: 'It is a common expression to say of any strong offensive smell, *mharbhadh e na samhanaich*, "it would kill the giants who dwell in caves by the sea."²

Now, McAlpine, in his *Gaelic Dictionary*, translates *samhanaich* by 'savages,' and quotes a proverbial saying in which the word is introduced with this meaning—'you would frighten the very savages.' We have here a word, therefore, which in the opinion of one scholar indicates a race of malodorous savages, without any reference to stature, while another scholar understands that these savages were giants. Even the latter term, however, does not necessarily imply great stature. The large block of stone in the island of Hoy, Orkney, which bears the popular name of 'the Dwarfie Stone,' is so called because it was believed, according to one version, to be the home of a dwarf. But a writer of the year 1700³ states that

¹ See Zell, *Polyphem ein Gorilla*, Berlin, 1901, pp. 6 and 10.

² *The Scottish Celtic Review*, Glasgow, 1885, pp. 62 and 140 f.

³ John Brand, *Description of Orkney, etc.*, reprinted at Edinburgh, 1883, p. 63.

'the common tradition among the people is that a giant with his wife lived in this isle of Hoy, who had this stone for their castle.' As the hollowed-out chamber, or bedroom, in which this giant was supposed to lie, is only 5 ft. 8 in. long, it is obvious that the word 'giant' did not convey the idea of a person of tall stature, in the minds of the common people. A similar problem is presented by the Gaelic word *famhair*, or *fomhair*, which J. F. Campbell and other translators of Scottish Highland tales render by the English word 'giant.' But O'Reilly, in his *Irish Dictionary*, defines it as 'a pirate, a sea robber, a giant.' The Irish forms of the word are *fomhor*, or *fomor*, with plural *fomori*. Sir John Rhys speaks of

'the *fomori*, so well known in Irish legend, which, however, does not always represent them as giants, but rather as monsters.' He further states: 'I remember hearing, however, years ago, a mention made of the *fomhóraigh* (an alternative spelling), which, without conveying any definite allusion to their stature, associated them with subterranean places. An undergraduate from the neighbourhood of Killorglin, in Kerry, happened to relate in my hearing how, when he was exploring some underground *raths* near his home, he was warned by his father's workmen to beware of the *fomhóraigh*.'¹

When it is understood that the dimensions of the underground structures referred to are often so low and narrow that large men have difficulty in entering them, it will be seen that here, again, we have the idea of 'giants' whose stature did not exceed that of medium-sized men. In modern Gaelic the word *famhair* (literally, 'mole-man,' or 'mole-fellow') is used to denote a mole-catcher, *famh* signifying 'mole'; and it is not unlikely that, in the old legends, it was a contemptuous nickname, given to a race of 'mole-men,' the builders and occupants of the underground dwellings, of which numerous specimens are still extant in Ireland and Scotland. Be this as it may, the foregoing references show that in Scottish and Irish tradition 'giants' are frequently noted, not for their great stature, but as being pirates, sea-robbers, cave-dwellers, savages, and offensively-smelling people. Cf. art. CELTS, iii. 281.

That giants were regarded in some vague way as abnormal is further indicated by Teutonic references. The Old Norse *iötunn* or *jötun*, Swedish *jätte*, Anglo-Saxon *eoten*, Scottish *etin* or *ettin*, represents a being whose attributes are only partly human. In the translations of the Scandinavian Eddas, where the *jötuns* occupy a prominent place, their name is usually rendered by 'giant' (Lat. *gigas*). Like the Irish *fomori*, they are associated with subterranean buildings. 'Etenes bi old dayn had wrought it,' was said of the underground house wherein Tristan and Isolde lay (*Tristrem*, 3, 17). Grimm states that the *jötun*, 'when at rest, is good-humoured and unhandy, but, when provoked, gets wild, spiteful, and violent' (ii. 530). The *jötun-möper*, or rage of the *jötuns*, is strongly suggestive of the 'Berserk-fury.' Grimm further points out (iv. 1441) that one passage (*Saem. 55a*) describes the *jötun* as a pithecoïd being, '*Attrunnr apa, simiarum cognatus*.' The Red Etin of Northern Scotland is similarly remembered as a savage cannibal, scarcely human. Under other names, the 'giants' of Teutonic and Scandinavian tradition are intellectually inferior to men, Gothic *tumbo*, 'giant,' being translated by Latin *stupidus*. From many sides, therefore, there are indications that 'giants' differed from men chiefly on account of their more brutal nature, the question of stature being frequently left out of consideration.

How complex the evidence relating to giants is may best be realized by examining the data brought together by Jacob Grimm. 'There is no clear line to be drawn between giants and the wild hairy woodsprites,' he observes in one place (ii.

¹ *Celtic Folklore*, Oxford, 1901, pp. 286 and 432 f.

553); while on another page (ii. 536) he speaks of 'a giantess or merwoman,' as though these two names were synonymous. Many of his statements support the view that the giants of Europe were a primitive race that preceded the modern European:

'The old giant race have to give way to agricultural man, agriculture is an eye-sore to them' (ii. 540). 'Eaters of flesh give place to sowers of corn, hunters to husbandmen. Giants consider themselves the old masters of the land, live up in the castle, and look down upon the peasant' (iv. 1445).

In pointing out their similarity to the 'wild hairy woodsprites,' he further remarks (ii. 553):

'In the woods of the Bingenheim Mark are seen the stone seats of the wild folk who once lived there, and the print of their hands on the stones. In the vale of Gastein, says Muchar (p. 137), wild men have lived within the memory of man, but the breed has died out since. . . . Their strength was gigantic. . . . Their dwelling was an inaccessible cavern on the left bank of the Ache, at the entrance to the Klamm. . . . To the inhabitants of the valley they were rather friendly than otherwise, and often put a quantity of butter and milk before their house-doors. This last feature,' he adds, 'is more of a piece with the habits of dwarfs and elves than of giants.'

The mention of the stone seats of those wild folk accords well with the ascription to giants of numerous stone structures of primitive character which are found throughout Europe. The names *enta burg*, *risón burg*, and *Hünen wälle*, all denote giants' castles, and the Gaelic term *caiseal na fian*, found in Scotland, has the same meaning. It is of much significance that such names are specially, perhaps exclusively, associated with buildings of the character known as 'cyclopean,' in which the chief features are: the rudeness and size of the stones, the absence of mortar, and the use of the 'false' arch instead of the true or 'Roman' arch. The former is made by approaching the upper courses of the opposing walls together until the space between them is narrow enough to admit of large flag-stones being superimposed. Architecture of this kind is found in Palestine, Greece, Malta,¹ Sardinia, the Balearic Isles, and Scotland, its most striking manifestation being displayed in the three localities last named, in the form of the massive circular towers known respectively as *nurags* or *nuraghé*, *talayots*, and *brochs*. No fewer than 3000 of these towers are known to have existed in Sardinia, and 500 in Scotland. Besides these towers there are unnumbered megalithic structures above and below ground, of the same general order, not only in the localities just indicated, but throughout the Continent of Europe and in the British Isles. These are known by various names. The remarkable cairns, akin to dolmens, which are found in the province of Drenthe, in the Netherlands, are called *Hünenbetten*, or *Hunebedden*, while the similar structures in North Germany are known as 'Giants' Graves.'² There is great difference of opinion as to the age of these structures, some placing them within the Christian era, and others assigning to them a much greater antiquity. The cyclopean buildings in the Levantine region are believed to date from 3000 B.C. On the other hand, the brochs of Scotland are understood to have been built only ten or fifteen centuries ago. Both inferences may be correct, assuming that the more modern structures were built by the modified descendants of a more primitive race. Perhaps the most important point, in connexion with the present theme, is that in Greece, Sardinia, Germany, and the British Isles—presumably elsewhere—the builders of those rude stone structures are often, in popular tradition, regarded as giants. That that word is

¹ Reference may be made to R. N. Bradley's *Malta and the Mediterranean Race*, London, 1912.

² For an account of the *Hünenbetten* or *Hunebedden*, and of Hunen-folk associated with them, Grimm (iv. 1438) refers to Janssen's *Drentsche oudheden*, pp. 167-184. Other useful references are Fergusson's *Rude Stone Monuments*, London, 1872, and Munro's 'Megalithic Monuments of Holland,' in *Proc. Soc. Antiq. Scot.*, vol. xviii. (1883-84).

not invariably held to denote people of great stature is shown by the fact that some traditions speak of them as dwarfs.

Nevertheless, there is no doubt that the prevailing opinion with regard to giants is that they were beings of immense stature. It is possible that the term 'giant's grave' might have given rise to this conception. If a long mound of 15 or 20 feet once became known as a giant's grave, then the inevitable deduction would be that a race of men 15 or 20 feet high once existed. Out of this, beings of much greater stature and power might be evolved, in the popular imagination. From whatever cause, the existence of beings of great stature, called 'giants,' was once an article of faith in folklore. Innumerable instances of this might be adduced.

'We are often told,' says Grimm (ii. 548), 'of two giant comrades or neighbours, living on adjacent heights, or on two sides of a river, and holding converse. In Ostergötland, near Tumbo in Ydre-härad, there was a jätte named *Tumme*; when he wished to speak to his chum *Oden* at Hersmala, two or three miles off, he went up a neighbouring hill *Högatott*, from which you can see all over Ydre. . . . Two hūnes living, one on the Eberstein, the other on Homburg, had but one axe between them to split their wood with. When the Eberstein hūne was going to work, he shouted across to Homburg four miles off, and his friend immediately threw the axe over. . . . The hūnes of the Brunsberg and Wiltberg, between Godelheim and Amelunxen, played at bowls together across the Weser.'

The same kind of story is found in other countries. In R. Hunt's *Popular Romances of the West of England* (London, 1865, 1881), he shows that the Cornish people have parallel traditions.

'The giant on the Mount and the giant on Trecrobben Hill were very friendly. They had only one clobbering-hammer between them, which they would throw from one to the other, as either required it.'

This is a Celtic tradition, of the Cymric family. Gaelic tradition in Ireland, Man, and Scotland tells a similar story. Whether those immense and impossible beings are wholly the creatures of popular fancy, or have been gradually evolved from a real basis, is a problem that remains to be solved.

Although certain localities have received special consideration in these remarks, it is not to be supposed that the question can be limited to those regions, or to Europe; for it belongs practically to all countries and all peoples. Hebrew references, for example, are in accord with those of Europe.

Giants in Hebrew story are variously known as Gibborim, Nephilim, Rephaim, Anakim, Emim, and Zamzummim. The first of these terms, *Gibbōrim*, although translated 'giants' in the Septuagint, is held to mean nothing more than 'strong men,' 'heroes,' or 'warriors.' *Nephilim* is a word of wholly uncertain signification. It is applied to an antediluvian race in the well-known passage (Gn 6⁴), 'there were giants in the earth in those days'; the word is retained as 'Nephilim' in RV. Most of the English translations have 'giants,' but John Rogers (1537) merely uses 'tyrants.' With regard to the *Rephāim*, or *Raphāim*, they are referred to as the descendants of '(the) Rapha,' a Philistine of Gath (2 S 21²²). It is not improbable that this Rapha is merely the eponym of the race. During the Philistine wars in the reign of King David, the Rephaim figure prominently, and indeed they are included under the term 'Philistine.' It is recorded that in a battle fought between the Israelites and the Philistines at Gezer, Sibbecai the Hushathite slew Sippai, one of the Rephaim, 'and they were subdued.' Again, in a subsequent campaign, Elhanan the son of Jair slew Lahmi, the brother of Goliath the Gittite, 'the staff of whose spear was like a weaver's beam.' In a third war there figured another of the Rephaim, 'a man of great stature,' distinguished by the peculiarity of having six fingers on each hand and six toes on each foot, who was slain by Jonathan, the son of Shimea,

David's brother. These three, Sippai, Lahmi the brother of Goliath, and the unnamed warrior just described, are all said to have been 'born unto the Rapha in Gath.' 'And they fell by the hand of David, and by the hand of his servants' (1 Ch 20⁴⁻⁶). David's famous encounter with Goliath had, of course, preceded these events.

On more than one occasion 'the Valley of the Rephaim,' on the Philistian border, to the west of Jerusalem, was the scene of conflict (2 S 5¹²⁻²²). This seems to be 'the valley of the giants' which is referred to in Joshua (15⁸ 18¹⁶ AV). 'The land of the Perizzites and of the Rephaim' (Jos 17¹⁰), an interesting conjunction of names, seen again in Genesis (15²⁰), indicates the more northern territories of Galilee and Bashan. The reference, however, apparently signifies nothing more than that the Perizzites were neighbours to the Rephaim. But undoubted kinship is shown in the mention of the *Emim* who preceded the Israelites in Ar of Moab, on the east side of the Dead Sea; for it is stated that 'the Emim dwelt therein aforetime, a people great, and many, and tall, as the Anakim: these also are accounted Rephaim, as the Anakim; but the Moabites call them Emim' (Dt 2^{10f}). This statement is repeated, with some amplification, in the same chapter (vv. 20, 21), where it is said of Ar of Moab: 'That also is accounted a land of Rephaim: Rephaim dwelt therein aforetime: but the Ammonites call them Zamzummim; a people great, and many, and tall, as the Anakim; but the Lord destroyed them before them; and they succeeded them, and dwelt in their stead.' In these references (Dt 2) the AV always renders Rephaim by 'giants.' Thus we have the names of Emim, Anakim, and Zamzummim (perhaps the same as *Zuzim*) variously given to tribes of the race of Rephaim, or giants, formerly inhabiting Southern Palestine, the Anakim occupying territory on the western side of the Dead Sea, and the Emim or Zamzummim inhabiting Ar of Moab, on its eastern borders.

The last refuge of the Rephaim was N.E. Palestine, in the land of Bashan. At the time of the Israelite conquest under the leadership of Moses, Bashan was called 'the land of giants' (Dt 3¹²), and the latest representative of Rephaim sovereignty was Og, king of Bashan; 'for only Og king of Bashan remained of the remnant of the Rephaim.' The great stature attributed to him is demonstrated in these words: 'Behold, his bedstead was a bedstead of iron (is it not in Rabbah of the children of Ammon?), nine cubits was the length thereof, and four cubits the breadth of it, after the cubit of a man' (Dt 3¹¹). It is worth noting that these dimensions are consistent with the height ascribed to Goliath of Gath, which was about 11 feet, or 6 cubits 1 span (1 S 17⁴), and that consequently the Rephaim, whether in Bashan or in Philistia, were believed to be of that immense stature. In passing, it may also be remarked that the iron bedstead¹ of the king of the Rephaim, and the iron chariots with which their probable kindred are credited (Jos 17¹⁶), point to a civilization superior to that of the Israelites. The same deduction may be made from the statement that the Anakim were, as a nation, 'greater and mightier' than the Israelites, having 'cities great and fenced up to heaven' (Dt 9¹⁴). The armour of Goliath—helmet, coat of mail, greaves, and javelin—was all of copper, with the exception of the spear-head, which was apparently of iron. Herein there was no special difference between the champion of the Rephaim and his Jewish opponent, who was similarly equipped. Nevertheless, the Israelites regarded their giant foes as

¹ Unless the meaning be, as many modern commentators think, a sarcophagus of black basalt.

superior to themselves in several of the qualities that imply civilization. This makes it all the more difficult to understand how the Rephaim were eventually conquered and exterminated by the smaller race. Had the former been mere savages, their great bulk and strength would have been of no avail if they had to fight against a people possessed of superior weapons. But, if they were more civilized than the Israelites, as well as much stronger in body, then the Israelitish conquest cannot be easily explained. It may be that the great height attributed to the Rephaim is merely an exaggeration of the Jewish chronicler, anxious to enhance the valiant deeds of his people by magnifying the difficulties which they had to encounter. That the Rephaim were of greater stature than the Israelites may be accepted, but the statements as to their height need not be taken any more literally than the assertion that their cities were 'fenced up to heaven.' Certainly no skeletal remains have been found, in Palestine or elsewhere, which testify to the past existence of a race of men standing 10 or 12 feet high.

It is unnecessary to refer in detail to other stories of giants, in Scandinavian and classic legend. Of these a number are obviously the outcome of imagination, such as the explanation of an earthquake as the movements of 'a giant pulsing under ground,' or the creation of a race of 'frost-giants' to account for the mighty influence of Winter. Cf., further, the following article.

LITERATURE.—This has been indicated in the article.

DAVID MACRITCHIE.

GIANTS (Greek and Roman).—The English word 'giant' is derived from the Greek γίγας, plur. γίγαντες; and γίγαντες was the name of a certain mythological group of beings. There is no mention of Gigantes in the *Iliad*. In the *Odyssey*, the word occurs three times.

(1) In *Od.* vii. 59 the king and queen of the Phalakes are descended from a daughter of Eurymedon, 'who once was king of the haughty Gigantes; but he brought his infatuated people to destruction, and was himself destroyed.' This genealogy was presumably invented *ad hoc* by the poet; it serves to indicate that his Phalakes belong to the same order of being as the Gigantes. The name *Eurymedon* ('wide-ruling'), here assigned to the Giga-king, also looks like an invention of the narrator. The passing mention of the 'wickedness' and 'destruction' of the Gigantes implies that a story which had something at least in common with the later *Gigantomachia* was already known to the poet and his audience.

(2) In *Od.* vii. 201-208 the king of the Phalakes says: 'The gods are wont to present themselves to us in visible shape, . . . without disguise; for we are near (akin) to them, as are the *Kyklopes* and the wild tribes of the Gigantes.'

(3) In *Od.* x. 120 the *Laistrygones*, a tribe of man-eating savages of monstrous size, are described as 'not like men, but like Gigantes.'

To the poet of the *Odyssey* the Gigantes were a tribe dwelling upon earth in the distant past; they were mortals, but surpassed men in size and strength, and stood in close relation to the gods; they were wild and savage in their ways, and, having committed some great wickedness, they were extirpated.

In the Hesiodic *Theogonia* (185) we are told the origin of the Gigantes. When Uranos (Sky) was mutilated by his son Kronos, Gaia (Earth), impregnated by the blood-drops which fell upon her from the wound, gave birth to (1) the Erinyes, (2) 'the great Gigantes, flashing in armour, holding long spears in their hands,' and (3) the 'Melian Nymphs' (i.e. nymphs of the ash-tree). The three species here grouped together have little in common; but they are alike in this, that all three rise out of the earth. The Erinyes (originally the angry ghosts of murdered men) issue from the earth where it has been defiled by the spilling of blood (see art. EUMENIDES, ERINYES); the ash-tree grows out of the earth;¹ and the Gigantes

¹ The fact that spear-shafts were commonly made of ash-wood, and that the ash-tree was, consequently, associated with bloodshed, may help to account for the juxtaposition.

also sprang directly from the earth. The connexion of their origin with the mutilation of Uranos is, no doubt, a piece of deliberate systematization. But the notion that the Gigantes were sons of Earth stands on a different footing; it is based on primitive folk-lore, and forms part of the connotation of the term Gigantes throughout all later literature.¹

The notion is allied to a tradition as to the origin of men which was widely current among the Greeks, namely, that the first human generation grew out of the soil, like vegetables (cf. Paus. viii. xxix. 4). This tradition was largely overlaid by the prevailing tendency to trace back each human family to some divine ancestor; but the belief persisted that at least some of the Greek races were *autochthonous*, i.e. that their first ancestors had sprung from the soil; and the origin of the Gigantes was explained in the same way as that of other primitive races. A parallel instance may be seen in the legend of the Theban *Spartoi*, the men who sprang out of the earth (fully equipped for battle, like the Hesiodic Gigantes) from the dragon's teeth sown by Kadmos; and a variant of the same legend occurs in the story of Jason. The epithet 'earth-born' was suitable to the Gigantes for another reason also, when they came to be identified with personifications of subterranean Nature-forces; but there is no evidence that they were thus regarded in Hesiod's time.

In the prelude of the *Theogonia* (50) the Muses are described as singing first the birth of the gods and the rule of Zeus, and, next, 'the birth of men and of the mighty Gigantes.' The poet here distinguishes the Gigantes from men, and, no doubt, took them to be a species which had once dwelt on the earth, but had long been extinct; so that his notion of them is comparable with that of the 'Race of Bronze' described in *Works and Days*, 143 ff.—a race of fierce warriors 'sprung from ash-trees,' who occupied the earth before the age of the Homeric heroes, and perished by mutual slaughter.

So far, we have found no mention of the *Gigantomachia* ('battle of the Gigantes'), with the exception of the doubtful allusion in *Od.* vii. 59 f. But in all later times, the interest in the Gigantes centred in this battle. The story that the Gigantes made war against the gods, and were destroyed in battle by their divine opponents, was, no doubt, told in some of the later Epic poems which have perished; but the earliest positive evidence of its existence appears in certain vase-paintings of about 600 B.C. Xenophanes (c. 535-500 B.C.) speaks of 'battles of the Titans and of the Gigantes, and tales of the Centaurs,' as familiar themes; frequent references to the *Gigantomachia* occur in the poets from Pindar onwards; and its popularity is shown by the numerous vases on which it is depicted. But the first continuous and detailed narrative of it which has come down to us is to be found in the compendium of mythology which passes under the name of Apollodorus, and, in its present form, dates perhaps from the 1st or 2nd cent. A.D. That narrative (Apollod. I. vi.) runs as follows:

'Earth, in her indignation at the overthrow of the Titans, gave birth to the Gigantes; their father was Uranos. They were of huge bulk, of irresistible strength, and of frightful aspect; their hair and beards were long and thick, and they had scaly serpent-coils in place of legs. They were produced, according to some accounts, in Phlegrai, according to others, in Pallene. They hurled rocks and blazing tree-trunks against heaven. Eminent above the rest were Porphyryon and Alkyoneus. The latter was immortal as long as he fought in the land of his birth. (He had driven off the cows of the Sun from Erytheia.) Now the gods had been told by an oracle that the Gigantes could not be slain by gods, but would meet their death if a mortal joined in the fight against them. Earth, informed of this, was seeking a magic herb, by which the Gigantes might be secured against death at the hands of a mortal also; but Zeus, having commanded Dawn, Moon, and Sun to withhold their light, gathered the herb before Earth could find it, and, by the agency of Athene, summoned (the mortal) Herakles to take part in the fight. Herakles first shot

¹ The Greeks accordingly assumed the name *Gigantes* to be derived from γῆ ('earth') and γένος ('birth'). But this etymology is inadmissible. A derivation from the root of γένος is possible, but has not been proved (cf. Boisacq, *Dict. étymol. de la langue grecque*, Heidelberg, 1907 ff., p. 147); and it is quite as likely that the name is of non-Hellenic origin.

down Alkyoneus with an arrow; and, as he revived through contact with the soil, Herakles, at the suggestion of Athene, dragged him away out of Pallene, whereupon he died. Porphyriion assailed Herakles and Hera; but Zeus caused him to be seized with love of Hera, and, when he sought to do her violence, she cried for help; whereupon Zeus struck him with a thunderbolt, and Herakles killed him with his arrows. Ephialtes was hit in the left eye by an arrow shot by Apollo, and in the right eye by an arrow of Herakles. Dionysos killed Eurytos with his *thyrsos*; Hekate slew Klytios [with her torches¹]; and Hephaistos struck down [Mimas?¹] with lumps of red-hot metal. Athene flung the island of Sicily upon Enkelados as he fled; she also flayed Pallas, and used his skin as a shield to protect herself in the fight. Polybotes, pursued through the sea by Poseidon, had reached the island of Kos, when Poseidon broke off a piece of the island and flung it upon him; the little island called Nisyros is the fragment which Poseidon flung. Hermes, wearing in the battle the cap of Hades (which makes its wearer invisible), slew Hippolytos; Artemis slew [Aigaion?¹]; the Moirai, [fighting¹] with clubs of bronze, killed Agrios and Thoon. Zeus struck and destroyed with thunderbolts the rest of the Gigantes; and Herakles shot them all with his arrows as they were dying.

Here we have the fully developed story of the *Gigantomachia*—or, rather, the dry bones of it, stripped of the poetical flesh and blood. How did this story arise? The narrative is built up of discrete elements; most of the several incidents were current separately before they were included in the *Gigantomachia*. Thus, the combat of Herakles with Alkyoneus was known to Pindar (*Isthm.* v. 32, *Nem.* iv. 27) as an incident belonging to the story of Herakles, but unconnected with the battle of the Gigantes. Pindar's Alkyoneus has not yet become a Gigas; but in a lyric fragment of later date (Bergk⁴, iii. 713), Alkyoneus is called 'eldest of the Gigantes.' Porphyriion was incorporated earlier, for Pindar (*Pyth.* viii. 12-17) speaks of him as 'king of the Gigantes'; but, since the name also occurs (Paus. I. xiv. 6) as that of a pre-historic king of a district of Attica, it may be inferred that his legend also had originally a separate existence.² Porphyriion's assault on Hera is a replica of several other stories (cf. Ixion and Hera, Tityos and Leto, Orion and Artemis, etc.); it may be connected with a statement which occurs elsewhere, that Porphyriion 'was subdued by Aphrodite' (schol. Aristoph. *Av.* 554, 1252). A combat of Athene with Enkelados is also included in early representations of the battle: and in some accounts (e.g. *Batrachom.* 283; Eur. *Kykl.* 7) Enkelados is singled out as chief among the Gigantes. The incident of Athene flaying her opponent Pallas and using his skin as a shield is another independent myth, a variant of which appears in the story of the *aigis*, as told in Eur. *Ion*, 987 ff. Poseidon's combat with Polybotes is a local tradition of Kos; the evidence of art-remains seems to show that its insertion into the *Gigantomachia* had already taken place early in the 6th century.

On general principles it may be presumed that every Greek myth was at first known within a limited district only. The guardians of some sanctuary, or the people of some one tribe or city, told a tale about their own special deity or hero. Some poet embodied the tale in verse, interwove it with other tales told elsewhere, and gave it wider currency; the process was repeated again and again, with fresh combinations, till the local tradition became part of the common stock of all Greek-speaking peoples; and the system of mythology summarized in Apollodorus is the final out-

¹ On the textual emendations here adopted, see M. Mayer, *Giganten*, p. 200 ff.

² The word *porphyriion* meant a kind of water-hen. Why should a Giant be so called? It has been plausibly conjectured that the name is a popular corruption of *Pyrphorion* ('fire-bearer'), and that the Gigas-king was originally a *πυρφόρος θεός*, a sort of Hephaistos or Prometheus. The alteration into a bird-name would the more readily suggest itself, because several other mythical persons bore the names of birds; cf. Kyknos ('swan') and his father-in-law Keyx ('tern'), whose wife was Alcyone (*ἀλκυών*, 'kingfisher'). Porphyriion and Alkyoneus, 'Giant Coot' and 'Giant Kingfisher,' pair well together.

come of this long development. Accordingly, we may suppose that the germ of the *Gigantomachia* was a tradition, current in some particular community, concerning a tribe named *Gigantes*, which had in some way offended against the gods, and had been destroyed in consequence. Parallels are not wanting; in Arcadia, for instance, a similar story was told of the Lykaonidai (Apollod. III. viii. 1), and in Bœotia, of the Phlegyai (Paus. IX. xxxvi. 2). How the tale first arose, we can only guess. It may be that a race of invaders preserved in this form a vague tradition of their conquest and extirpation of the indigenous inhabitants (the conquerors would naturally assume their enemies to be also enemies of their gods). Or, again, it may have arisen out of a Nature-myth—a tale of conflict between the powers of light and darkness, or between the beneficent forces of Nature and the destructive violence of the thunderstorm, the earthquake, or the raging sea. We may safely assume that the Gigantes had at first no individual names, and were spoken of only collectively.

But numerous tales were also current concerning individuals in human or other shape who had fought against this or that god. Each of these tales had arisen independently, from Nature-myth or otherwise; but any such god-defier was liable to be brought sooner or later into the class of Gigantes, and thereby made to contribute a fresh element to the growing myth of the *Gigantomachia*. For instance, the *Odyssey* (xi. 305 ff.) tells of the Aloidai, two monstrous brothers, named Otos and Ephialtes, who, while still beardless boys, made war on the immortals: 'they strove to pile Mount Ossa on Olympos, and Mount Pelion on Ossa, that they might gain access to heaven'; but Apollo slew them. The Aloidai of the *Odyssey* are quite distinct from the Gigantes; but, as they had engaged in a similar enterprise, they were subsequently confused with them; and so we find the name Ephialtes assigned to one of the combatants in the *Gigantomachia* at an early date.¹

Again, the Hesiodic *Theogonia* (147 ff., 617 ff.) tells of three monsters, sons of Uranos and Gaia, named Briareos, Kottos, and Gyes, each of whom had a hundred hands and fifty heads. Their father, Uranos, horrified at their threatening aspect, imprisoned them beneath the earth; but, when Zeus was engaged in war with the Titans, he was told by Gaia that the help of the Hundred-handed Brothers would win him victory. Accordingly, he released Briareos and his brothers from their subterranean prison, and made a compact with them; and so, in the crisis of the fight, the monsters struck in on the side of Zeus and his adherents, and won the day for them. They hurled three hundred rocks at once with their stout hands, and darkened the air with missiles, and sent the Titans down to Tartaros, and bound them in grievous bonds: 'and there (keeping guard over the imprisoned Titans) dwell Gyes, Kottos, and Briareos, trusty warders in the service of Zeus.'

These monsters seem to be personifications of the forces of storm and earthquake (cf. EARTH, EARTH-GODS, § 4). Their abode is in the depths of the earth, in which they were imprisoned from their birth; they emerge for a moment to fight for Zeus, and then return to their home in the abyss. They side with the supreme god; yet a suggestion that they were by nature enemies of heaven appears in the statement that Uranos (who is ultimately a doublet of Zeus) imprisoned them in

¹ It occurs (in the form *Hipialtes*) as the name of one of the Gigantes on the vase of Cære. The word *ἐπιάλτης* means 'assaulter,' and was used by the Greeks in the sense of 'nightmare.'

the depths. Storm and earthquake, in fact, admit of two different interpretations. They are clearly manifestations of conflict between superhuman combatants; but are these terrible forces brought into action by rebels against the ruling god, or by the ruling god himself against his enemies? In the Hesiodic story of the Hundred-handed Brothers, it is the latter notion that happens to have prevailed.

In the *Iliad* also (i. 403) Briareos appears as an ally of Zeus.

Hera, Poseidon, and Athene once sought to put Zeus in bonds; but Thetis summoned to his aid 'him of the hundred hands, whom gods call Briareos, but men name him Aigaion: he is mightier than his father (viz. Poseidon?). And he took his seat beside Zeus, exulting in his glory; and the gods feared him, and did not put Zeus in bonds.' The alternative name Aigaion probably characterizes him as a sea-god and earth-shaker, of the type of Poseidon.

The Hundred-handed Brothers are, in early myth, clearly distinguishable from the Gigantes; for they are neither mortals nor opponents of Zeus. But, being powerful monsters of like nature, they too came to be regarded as Gigantes, and thus Briareos had a part in the *Gigantomachia* assigned to him. (The earliest certain instance is in Kallimachos, *Hymn. Del.* 143.)

Again, the Hesiodic *Titanomachia* (see art. TITANS) had something in common with the later *Gigantomachia*, since in both alike there was war between Zeus and a hostile power. Hence the distinction between the immortal Titans and the mortal Gigantes was often ignored in later literature; the words *τιτάν* and *γίγας* came to be used as equivalents (e.g. Eur. *Hec.* 472, *Iph. Taur.* 224); and the Hesiodic Titan Koios was enrolled among the Gigantes (Verg. *Æn.* iv. 179; Propert. iv. ix. 48).

The connexion of the Gigantes with the earth from which they had sprung was kept in view throughout the development of the myth; hence some pictures of the battle include a figure of Gaia, rising waist-high out of the ground, and vainly entreating the gods to show mercy to her sons.

The inclusion of various stories of single combats helped to determine the parts assigned to the several gods. Zeus holds the central position; among the rest, Athene is usually prominent; Poseidon also takes a leading place; and the picture is filled out with other deities. A conspicuous part in the conflict was given to Dionysos, especially in later times, when the warlike side of this deity's character came to be emphasized. But the aid given to the gods by the half-human Herakles was, from an early date, a point of special interest in the story; and we see him mounted beside Zeus in his chariot, or fighting on foot next to the supreme god. The legend of Herakles was at first a peculiar possession of the Dorian race, and remained in the background in the early Ionian Epic. In one passage of the *Iliad* (v. 385-404) he is even spoken of in terms of reprobation, as an audacious fighter *against* gods, and is coupled with the Aloidai. If this view of him had prevailed, Herakles himself might have come to be included in the list of the Gigantes. But the Dorian hero gained recognition among Greeks of all races; and, as it was the special business of Herakles to slay monsters and evil-doers, it was natural to give him a place in the battle in which a whole tribe of such beings was destroyed. Thus the task of fighting the Gigantes was added to his other labours, and he became, next to Zeus himself, the most prominent of the combatants (see Pindar, *Nem.* i. 67; Eurip. *Herc. Fur.* 177).

Yet another ingredient was supplied by the combat of Zeus with Typhoeus. A passing allusion in the *Iliad* (ii. 782) shows knowledge of this

myth; and the combat is described in Hesiod (*Theog.* 820 ff.).

After the overthrow of the Titans, Gaia, in union with Tartaros, gave birth to Typhoeus, a mighty deity, strong of hand and foot. From his shoulders rose a hundred serpent-heads with licking tongues and fire-flashing eyes; and from those heads there issued manifold voices, now such speech as the gods use, and now sounds as of bellowing bull and roaring lion and yelping hound, or piercing hisses. And he might have been king of gods and men; but Zeus marked the danger, and sprang forth, and hurled his lightnings, and smote the monster's heads. Typhoeus fell; and the flame of the thunder-smitten enemy of Zeus shot forth among the mountain-dells of Ætna,¹ and the earth ran like molten metal. Thus did Zeus hurl him down to Tartaros. And from Typhoeus spring the evil wind-storms which wreck ships at sea, and ruin the works of men on land.

Here the narrator is clearly conscious of the meaning of the Nature-myth. Typhoeus is the fire-fiend whose work is seen in volcanic eruptions, and in the blasting winds which were thought to be of similar origin; and the description of the conflict is probably based on accounts of some eruption of Mount Ætna, transmitted by the Greek colonists of Sicily.

The resemblance of the Typhoeus-fight to the various combats included in the *Gigantomachia* (some of which at least had arisen out of similar Nature-myths) was sufficiently close to cause Typhoeus also to be associated with the Gigantes; and through assimilation to him and other such monsters the shape and aspect of the Gigantes underwent a change. In the earlier form of the myth (Hes. *Theog.*) they are armed warriors; and, as depicted on early vases, they are indistinguishable in appearance from civilized combatants. Later, they appear in the form of savage men, clothed in beast-skins, and using rocks and tree-trunks in place of weapons. But from the time of Alexander the Great they commonly take the shape described in Apollodorus; head, arms, and trunk are human, but in place of legs they have a pair of serpent-coils. (The serpent form was the more appropriate, because the snake was among the Greeks a symbol of the earth and of the powers beneath the earth.) They are sometimes also depicted with wings, after the analogy of the wind-gods—which is again a sign of their assimilation to Typhoeus, the father of wind-storms.

Moreover, it was probably through their association with Typhoeus that the Gigantes came to be specially connected with *volcanic* forces; and this notion led to fresh localizations. The scene of the battle was commonly placed in 'Phlegra.' But Phlegra ('Land of burning') was a mythical land unknown to geography. Each of the various myths which entered into the composite picture had its own original site, one in Arcadia, another in Attica, a third in Eubœa, and so on; but a certain consensus arose in favour of Pallene, the westernmost of the three Chalkidic promontories on the north coast of the Ægean. We may suppose that the growing myth was carried to that region by the colonists from Chalkis in Eubœa who settled there. Confusions between similar names may have helped to fix the site of the battle in the Chalkidic Pallene. (A personage named *Pallas*, who came to be included among the Gigantes, was known to local tradition in the Arcadian *Pallantion*, in the Achaian *Pellene* near Sikyon, and in the Attic district of *Pallene*.) Moreover, the place was well situated for an assault on Olympos, which stood in full view across the Gulf of Salonika. Thus it came about that, at least as early as Herodotus (vii. 123), Phlegra, the scene of the *Gigantomachia*, was identified with Pallene.

There are no conspicuous signs of volcanic action in Pallene. But, through the westward coloniza-

¹ The reading *Ætna* here admits of doubt; but there is no doubt that the thing described is a volcano in eruption.

tion, the Greeks became familiar with two volcanic regions, the neighbourhoods of Etna and Vesuvius; and the settlers accounted for the outbreaks of subterranean fire by the fancy that some enemy of the gods lay buried alive beneath the soil. Thus, in the Hesiodic *Theogonia*, Typhoeus appears to be already located at Etna.¹ But the imprisoned monster might equally well bear other names, and was often identified with one or other of the Gigantes; hence comes, for instance, the statement in Apollodorus that Athene threw the island of Sicily on her opponent Enkelados. The volcanic district of the Campanian coast was, for like reasons, regarded as the scene of the *Gigantomachia*, and the name of Phlegra was accordingly applied to it (Polyb. III. xci. 7).

Again, after Alexander's conquests, the Greek emigrants carried their myths with them to fresh regions, and located many of them in their new settlements in the East. Thus Syrian Antioch, for instance, developed a local *Gigantomachia* of its own.

One incident in the Græco-Syrian legend will serve to illustrate the process of myth-making. The name of the city of Damascus sounded to Greek ears as if it were derived from the Gr. *dam-* ('conquer') and *askos* ('wine-skin'); hence was invented a Gigas named Askos, who was slain by Zeus or Dionysos, and was flayed by the victorious god to make a wine-skin (Phot. *Bibl.* 348. 13, ed. Bekker, Berlin, 1824-25; *Etym. Magn.*, s.v. *Δάμασκος*).

The popularity of the *Gigantomachia* was increased by the readiness with which the story lent itself to moral and political applications; for it might serve as a type of any victory won by the forces of order and legitimate authority in conflict with lawless violence. A good example of such applications may be seen in the first *Pythian Ode* of Pindar. Addressing Hiero, the monarch of Syracuse, the poet deals with the story of Typhoeus; and in his hands the myth becomes a parable, in which Zeus stands for harmony, and Typhoeus for discord. Hiero is the human Zeus, whose life-task is to beat the monster down, and to keep him safely bound; that is, to maintain peace and prosperity against unruly factions within his realm; to crush the foreign foes who threatened Western Hellenism—the barbarous Carthaginians and Etruscans—and, further (so the poet hints), to see to it that within his own soul, too, the forces of order and harmony prevail; else, he whom men now praise as a king might come to find them curse him as a tyrant.

Pindar elsewhere (*Pyth.* viii. 16) couples Typhoeus with the king of the Gigantes. Under whichever name the enemies of the gods are spoken of, the significance of the story is the same; and it was with some such meaning that the myth of the Gigantes was repeatedly employed in plastic art. Thus the Megarians (c. 550 B.C.) sculptured the *Gigantomachia* on the treasure-house which they dedicated at Olympia as a thank-offering for a victory over their neighbours of Corinth. At Athens, before the Persian invasion, the same subject was already represented in the sculptures of the earlier temple of Athene on the Akropolis; after the Persian war, it was carved on the *metopes* of the Parthenon, and on the shield of Phidias' colossal statue of Athene; and it was depicted in the embroideries of the robe which the Athenians presented to the goddess of their city at each Panathenaic festival. The *Gigantomachia* was an appropriate subject for an offering to the warlike goddess, who was prominent in the story of the fight; but, at the same time, the Gigantes might

¹ The *Iliad* (ii. 782) places 'the bed of Typhoeus' in 'the land of the Arimi,' a mythical country, which in later times (Verg. *Æn.* ix. 716) was sometimes identified with the island of Ischia off the Campanian coast. Pindar (*Pyth.* i. 17, viii. 16, fr. 92, 93) names Kilikia as the birthplace of Typhoeus or Typhon, 'the land of the Arimi' (i.e. Kilikia?) as the place of his defeat, and Campania and Etna as the places where he lies imprisoned.

be taken to represent the Persian enemy, and the battle-scene served to symbolize the victories won against barbarism and impious presumption in the fights of Marathon and Salamis. A *Gigantomachia* was also conspicuous among the sculptures of the temple of Apollo at Delphi (Eurip. *Ion*, 206 ff.).

The irruption of Gallic hordes into northern Greece and Asia Minor in the 3rd cent. B.C. suggested a fresh application of the story. Kallimachos (*Hymn. Del.* 174) speaks of the Gauls as 'late-born Titans (i.e. Gigantes) from the furthest West.' Attalus I. of Pergamon (Paus. i. xxv. 2), after his great victory over the Gauls, set up at Athens four groups of sculpture, representing respectively the battle he had won, the battle of Marathon, the *Gigantomachia*, and the fight of the Athenians against the Amazons; thus coupling his own victory with that of Marathon, and placing beside each of them a mythic prototype. So also the Battle of the Gigantes was the subject chosen for the decoration of the monument erected on the citadel of Pergamon by a successor of Attalus I. (c. 180 B.C.) to commemorate the defeat of the barbarous invaders by the forces of Hellenic civilization. This monument took the shape of a great altar; and along the sides of the rectangular block of building which formed the altar-platform there ran a continuous band of sculpture, over 400 feet in length, in which all the chief deities of the Greek Pantheon were represented, each engaged in combat with some special adversary. Of the Gigantes, who are falling stricken before the victorious gods, or offering hopeless resistance, some are in wholly human shape, and might be taken for idealized portraits of Gallic combatants; some are men with serpent-legs; some have wings springing from their shoulders; and here and there appears some more bestial monster.

References to the *Gigantomachia* are frequent in Latin poetry. Horace (*Od.* III. iv. 42 ff., II. xii. 6 ff.) found in it a type of the work accomplished by Augustus in suppressing the anarchy of the Civil Wars, and establishing the peace and order of the Roman Empire. Ovid began a poem on the subject in his youth (*Amor.* II. i. 11). In the last age of Pagan literature, Nonnos, in his *Dionysiaka*, makes numerous references to the myth, and (bk. 48) introduces an episode of his own invention, in which Dionysos single-handed fights the whole tribe of Gigantes, but refrains from destroying them, in order that something may be left for Zeus to do; Claudian (c. A.D. 400) wrote a Latin poem on the *Gigantomachia*, the first 129 lines of which are extant; and a portion of a Greek poem on the same subject has also come down to us under the name of Claudian.

The Cyclopes (*Kyklopes*), as described in the *Odyssey*, are giants in the sense in which the word 'giant' is used in our nursery tales; but they were not called Gigantes by the Greeks. The story of the encounter of Odysseus with the man-eating ogre Polyphemos is told in *Od.* ix. Polyphemos, a son of Poseidon and a sea-nymph (*Od.* i. 71), is one of a tribe of wild men called *Kyklopes*, who dwell on the coast of some unspecified land in the western seas. The *Kyklopes* are housed in caves; they do not cultivate the soil, but live on the natural products of the earth, and the milk of their flocks of sheep and goats. They are 'a lawless folk'; 'they have no gatherings for council'; each lives apart, 'giving law to his children and wives,' and 'they reckon not one of another.' So far, the poet might be describing a tribe of savages (cf. *Od.* vi. 5, where we are told that the Phaiakes migrated to Scheria, because in their earlier abode they suffered from the raids of the *Kyklopes*, 'overbearing men, who used to harry them'). But Polyphemos is distinguished from ordinary men

by his huge bulk and strength (he can lift a rock which could not be moved by two-and-twenty wag-gons), and it is implied that in place of two eyes he has a single eye in his forehead.

The Homeric conception of the *Kyklopes* persisted through all later Greek and Roman literature; e.g., Euripides adheres to it closely in his satyric drama *Kyklops*. In post-Homeric times the abode of these *Kyklopes* was localized on the coast of Sicily at the foot of Etna (Eur. *Kykl.* 20; Thuc. vi. 2). A later addition to the tale of Polyphemos was the story of his love of the sea-nymph Galateia, which was told in a poem of Philoxenos (c. 398 B.C.), and may have been invented by that poet.

But the name *Kyklopes* was also used in a different sense, which first occurs in the Hesiodic *Theogonia*. The *Kyklopes* there spoken of are three sons of Uranos and Gaia, born after the twelve Titans, and before the three Hundred-handed Brothers. The three *Kyklopes* are named Brontes ('Thunder'), Steropes ('Lightning'), and Arges ('Flash,' or 'Flashing Thunderbolt'); and 'they gave Zeus the thunder, and made for him the thunderbolt. They were like to the gods, except in this, that each of them had a single eye in the middle of his forehead. They had mighty strength, and were skilled in handicraft' (*Theog.* 139-146). Those parts of the narrative which have to do with the *Kyklopes* are somewhat obscure; but the meaning appears to be that they were imprisoned beneath the earth by their father, Uranos (*ib.* 154 ff.), and that Zeus, when about to fight against the Titans, released them from their bonds, and they, in gratitude, 'gave him thunder, thunderbolt, and lightning' (501-506). Armed in this fashion, Zeus warred against the Titans (687-712); and it is in the strength of the same weapons that he still rules over gods and men (506).

The Hesiodic narrative of the *Titanomachia* seems to have been constructed by interweaving two distinct versions of the story. In one of the two, Zeus owes his victory over the Titans to the help of the Hundred-handed Brothers; in the other, he owes it to the lightning-weapons with which he is provided by the *Kyklopes*.

The Hesiodic *Kyklopes* have nothing in common with the *Kyklopes* of the *Odyssey*, except that they are one-eyed. They are not men, but immortals; they are beings of the same order as the Hundred-handed Brothers; and their function is to supply Zeus with thunder and lightning. It is probable that they were originally demons of the thunderstorm, and were at first imagined as themselves thundering and flinging the lightning, but were afterwards subordinated to Zeus the Thunderer. The *Kyklopes* to whom sacrifices were offered on an altar in or near the sanctuary of Poseidon at the Isthmus of Corinth (Paus. II. ii. 2) were presumably storm-demons of this kind.

The Hesiodic conception of the *Kyklopes* survived in later literature side by side with the different conception of them which is presented in the *Odyssey*. As forgers of thunderbolts, they were associated with Hephaistos, the metal-worker of the gods (Orph. *Theog.* fr. 92, Abel), and were described by Alexandrian and Roman poets as workmen employed in his service (Kallim. *Hymn to Artemis*, 46 ff.); and the smithy in which they worked was located in some volcano (Lipara [Kallim. *l.c.*]; an island near Lipara [Verg. *Æn.* viii. 416 ff.]; Etna [Verg. *Georg.* iv. 173]). The immortal lightning-makers of the Hesiodic *Theogonia* seem to be confused with the mortal savages of the *Odyssey* in the story that the *Kyklopes* were killed by Apollo, who was angered with them because they had supplied Zeus with the thunderbolt with which he slew Apollo's son Asklepios (Hes. *Eoiai*, fr. 47, Götting; Pherekydes, schol. Eur. *Alc.* 1; Apollod. III. x. 4).

The *Kyklopes* were also spoken of as the builders of certain ancient fortress-walls, especially those of Tiryns, Mykenai, and Argos (Pindar, fr. 169, Bergk; Eur. *Herc. Fur.* 15, 944, *Iph. Aul.* 1500; Strabo, viii. 372; Paus. II. xvi. 4). As the walls of Tiryns were constructed of huge blocks of stone, it was natural to assume that their builders were beings possessed of more than human strength; and the notion that these builders were the *Kyklopes* may have been suggested either by the Homeric narrative, in which the *Kyklops* Polyphemos heaves vast masses of rock, or by the Hesiodic conception of the *Kyklopes* as skilled artificers.

The origin of the name *Kyklopes* is unknown. The Greek word *kyklōps* might mean 'round-eyed' (it was used by Parmenides as an epithet of the moon), but this meaning is not specially appropriate either to the one-eyed Polyphemos of the *Odyssey* or to the one-eyed lightning-makers of Hesiod. As to the notion of a being with one eye in his forehead, compare the description given by Pausanias (II. xxiv. 5) of an old statue of Zeus in the citadel of Argos, which had a third eye in the forehead. This may have been a statue of a lightning-god; and it is possible that the god whom it represented may have been originally called 'Kyklops,' though in later times it was supposed to be a statue of Zeus. The 'one-eyed Arimaspoi' of Aristeas (*Æsch. Prom. Vincit.* 830; Herod. iv. 27) are comparable rather with the *Kyklopes* of the *Odyssey*.

It may be conjectured that the name *Kyklopes* was first used to signify demons of the thunderstorm, and that the poet of the *Odyssey* (or some earlier story-teller whom he followed), working into his narrative an old tale of an ogre outwitted and blinded by a bold and cunning hero, made the ogre a member of an imaginary tribe of savages, and transferred to this tribe the name of the storm-demons.

Among the many representations of the *Gigantomachia* in art, the following are specially noteworthy: Ionic Amphora from Cære, Louvre (Overbeck, *Kunstmyth. Atlas*, Leipzig, 1872-89, Taf. iv. 8); Megarian Treasury at Olympia (G. Treu, in Curtius-Adler, *Olympia*, Textband iii., Berlin, 1897, pp. 5-15, and Tafelband iii., Taf. ii., iii.); Vase of Erginos, painted by Aristophanes, Berlin, 2531 (Gerhard, *Gr. und etr. Trinksch.* ii., iii.; Overbeck, v. 3); Amphora from Melos, Louvre (Ravaissou, *Monuments grecs*, Paris, 1875, iv.; *JHS* iii. 816); Altar-frieze of Pergamon, Berlin (Puchstein, *Beschreibung der Skulpturen aus Pergamon*, Berlin, 1895, *Die Skulpturen des Pergamon-Museums in Photographien*, do., 1903; Pontremoli-Collignon, *Pergame*, Paris, 1900, ch. 5).

LITERATURE.—M. Mayer, *Die Giganten und Titanen in der antiken Sage und Kunst*, Berlin, 1887; Preller-Robert, *Gr. Mythol.*, do. 1887, i. 63-78; F. Koepp, *de Gigantomachia in poeseos artisq. monumentis usu*, Bonn, 1888; J. Ilberg and E. Kuhnert, 'Giganten,' in Roscher, 1888; L. R. Farnell, in *JHS* iii. 801, iv. 122, vi. 102, vii. 251. On the *Kyklopes*, see W. Mannhardt, *Ant. Wald- und Feldculte*, Berlin, 1877, pp. 103-112. W. SCOTT.

GIFTS (Primitive and Savage).—I. General conception among uncivilized peoples as to the nature of the transaction of giving.—(1) It has commonly been assumed that the 'presents' of savages and barbarians are the outcome of the same feelings and intentions as those of the modern man. Our act in giving is (in theory, at all events) an act of spontaneous bounty without thought of a return. It springs from good-will, or generosity, or gratitude, or sympathy. But with the primitive man it is otherwise; and of him we may say generally what has been said of the western Eskimos, that of a free and disinterested gift he is absolutely ignorant.¹

(2) Of course, there are exceptions, real or apparent, to be found.

¹ J. Simpson, 'Observations on the W. Esquimaux and the Country they inhabit,' in *Further Papers relating to the recent Arctic Expeditions, presented to both Houses of Parliament, January 1855*, London, 1855, p. 926.

Thus Parry¹ tells us that on one occasion he received a present from a grateful Eskimo, who looked for nothing in return, although to give a counter-gift was the habitual practice of his people; and Howitt² says of the Dieri that they made presents to a white man whose advocacy had saved the life of one of their tribesmen. Finsch³ states expressly of natives on the banks of the Caprivi River that they expected no return for their presents of food; and von Siebold⁴ gives a similar account of the Ainus of Yezo. The Aleut, if he makes a present, even to a wealthy man, is said to expect no recompense;⁵ and, among the Banaka and Bapuku, the donor can demand a counter-gift only when he is poorer than the recipient.⁶ Among the Bogos and Abyssinians, a gift called *majbetot* by the former and *kalatha* by the latter is given to a relative impoverished or ruined by war, on condition that the donor may recover it if he falls on evil days, or if the recipient recovers his position.⁷ Again, it is not unusual for a tribe on the occasion of a visit to a friendly tribe to make presents; and of this we have an instance in the gift-dance of the Wintun.⁸ But it is to be kept in view that the gift-dancers receive similar gifts when the visit is returned.

(3) Further, it is to be observed that amongst many peoples—the Yahgan of Cape Horn,⁹ for example, and some of the natives of North Queensland¹⁰—the distributor, in sharing food, keeps little or nothing for himself;¹¹ and it is a commonplace that the rudest savage is often profuse in his hospitality, which frequently includes a parting gift to his guest, it may be in the form of provisions for his journey (see 3 (9) below, and art. STRANGERS). But it does not follow that such conduct is due to a spirit of unselfish liberality. For, where the supply of food is uncertain, and procurable only by the joint exertions of the community, it is not unnatural that he who has a superfluity will give, on the understanding that he will receive a return when he requires it.¹² And, where there is no provision for public entertainment, to travel, especially if the country is insecure, would be highly dangerous, if not impossible, were it not for a hospitality based upon the experience that 'he who is the host to-day may be the guest to-morrow.'¹³

(4) In the vast majority of instances, however, the gift is given on the understanding or, at all events, in the expectation that the recipient will make a return, either by giving something, or by doing or abstaining from doing something.¹⁴

2. Return in the form of a material thing.—

(1) The New Zealander sometimes gave away every article which he possessed;¹⁵ but he always expected an equivalent, and frequently, like the natives of Tahiti, dropped a hint of what he wanted in return.¹⁶ The Yahgan are ready to share what they have with others. They desire to possess in

¹ *Journ. of a Second Voyage*, London, 1824, p. 252.

² *Nat. Tribes of S.E. Australia*, London, 1904, p. 322.

³ *Samoafahrten, Reisen in Kaiser Wilhelms-Land, etc.*, Leipzig, 1888, p. 301.

⁴ *Nippon*, Leyden, 1852, ii. 237; cf. A. von Krusenstern, *Voyage round the World in the Years 1803-6*, London, 1813, ii. 71, 75.

⁵ W. H. Dall, *Alaska and its Resources*, Boston, 1870, p. 395.

⁶ S. R. Steinmetz, *Rechtsverhältnisse von eingeborenen Völkern in Afrika und Ozeanien*, Berlin, 1903, p. 56.

⁷ W. Munzinger, *Ueber die Sitten und Recht d. Bogos*, Winterthur, 1859, p. 72.

⁸ S. Powers, 'Tribes of California,' *Contributions to N. American Ethnology*, Washington, 1877, iii. 338.

⁹ T. Bridges, *Mœurs et coutumes des Fidgiens*, tr. P. Hyades (BSAP, 1884), p. 182.

¹⁰ O. Lumholtz, *Among Cannibals*, London, 1889, p. 199.

¹¹ Cf. W. G. Sumner, 'The Yakuts,' *JAI* xxxi. [1901] 68 f.

¹² Parry, p. 525.

¹³ E. Westermarck, *MI*, London, 1906, i. 581; see Hanoteau-Letourneux, *La Kabylie et les coutumes kabyles*, Paris, 1872-73, ii. 44; D. Crantz, *The History of Greenland*, Eng. tr., London, 1820, i. 172 f.; F. Nansen, *Eskimo Life*, London, 1893, p. 117; W. Brett, *Ind. Tribes of Gujana*, London, 1868, p. 347; T. M. Winterbottom, *Account of the Nat. Africans in the Neighbourhood of Sierra Leone*, London, 1803, i. 214; W. S. and K. Routledge, *With a Prehistoric People: The Akikuyu of British East Africa*, London, 1910, p. 246.

¹⁴ Cf. W. Jetté, 'On the Medicine-Men of the Ten'a,' *JRAI* xxvii. [1907] 167.

¹⁵ J. S. Polack, *Manners and Customs of the New Zealanders*, London, 1840, ii. 157 f.

¹⁶ E. Shortland, *Trad. and Superstitions of the New Zealanders*, London, 1854, p. 199; J. Cook and J. King, *A Voyage to the Pacific Ocean . . . in the Years 1776-81*, do. 1784, ii. 73.

order to give.¹ At the same time, they know that they will be well repaid by counter-gifts.² In these circumstances, it is not wonderful that misunderstandings frequently arise with strangers who imagine that they have purchased some article for a trifle, while the natives think that they have given a present for which they have not received an adequate return.³ The case of the Andamanese is similar. Among them visits are usually the occasion of an interchange of gifts, 'the hosts taking the initiative; and a *fracas* not infrequently ensues, for donor and recipient are not always of a mind as regards the relative value of their presents.'⁴

In Amboyna, the recipient of a gift says, 'Friend, you have given me this; with what shall I recompense you?'⁵ and a note is taken of the gifts received at a funeral ceremony, so that, when the donors die, like gifts may be given in return.⁶

'They [the natives of Rotuma] have the *saksoro*. If a man, say, wants a pig for a feast, he goes to another who has plenty, and asks him for one. He cannot well refuse, but in his turn is entitled to ask for something at some future time.'⁷

Again, the Drummond Islanders

'seemed to have no idea of receiving anything as a gratuity, but instantly made a return of something for whatever was given them';

and the inhabitants of other islands of the Kingsmill group

'never buy or sell, but, if any person desires an article which another has, he asks for it, and, if not too valuable or esteemed, is seldom refused. It is the general understanding that such favours are to be returned, and that the request should only be made by persons who can afford to do so.'⁸ "Give" and "give back" make the longest friends, if there is luck withal . . . gift always looks for return.'⁹

The 'potlatch,' or gift-festival, prevails among all the coast tribes of British Columbia. By a well-understood rule, which has the force of a law of honour, every recipient of a gift is bound to return twice its value at some future day; and in this repayment his relatives are expected to assist him; they are, indeed, deemed to be his sureties.¹⁰ So, too, among the Eskimos of Point Barrow, on the occasion of high festivals to which neighbours are invited, gifts are exchanged, especially among the wealthy, in expectation of a return.¹¹

Similar accounts are given of the natives of New Caledonia,¹² the Marshall¹³ and Caroline Islanders,¹⁴ the Samoans,¹⁵ the eastern islanders of Torres Straits,¹⁶ the Tlingits and Haidas,¹⁷ the Salish and Déné,¹⁸ some of the Indian tribes of North

¹ Hyades-Deniker, *Mission scientifique du Cap Horn, 1882, 1883*, Paris, 1891, vii. 243.

² Bridges, pp. 179, 182.

³ Hyades-Deniker, vii. 243.

⁴ E. H. Man, *On the Original Inhabitants of the Andaman Islands*, London, 1883, pp. 27, 120, 172.

⁵ Riedel, *De sluik- en kroesharige rassen tusschen Sebeles en Papua*, Hague, 1886, p. 43; see p. 192 as to Watabela Islands, and p. 371 as to Leti, Moa, and Lakor.

⁶ *Ib.* p. 80.

⁷ J. Stanley Gardiner, 'The Natives of Rotuma,' *JAI* xxvii. [1898] 408.

⁸ C. Wilkes, *Narrative of the U. S. Exploring Expedition during the Years 1838-42*, London and Philadelphia, 1845, v. 49, 89.

⁹ Vigfusson-Powell, *Corpus Poeticum Boreale*, Oxford, 1883, i. 12.

¹⁰ H. Hale, *Remarks on the Ethnol. of British Columbia* [in *Report of the British Association for the Advancement of Science . . . in 1890*], London, 1891, p. 556 f. An account of the festival is given at p. 588 f. See also M. Macfie, *Vancouver Island and British Columbia*, London, 1865, p. 429 f.; O. Hill-Tout, *British N. America*: i. 'The Far West—The Home of the Salish and Déné,' London, 1907, p. 155; J. G. Frazer, *Totemism and Exogamy*, London, 1910, iii. 262, 304, note. Note the custom of exchanging food practised by natives of islands in Torres Straits (*Reports of the Cambr. Anthropol. Exped. to Torres Straits*, Cambridge, 1912, iv. 310 f.).

¹¹ *Report of the Internat. Polar Exped. to Point Barrow, Alaska*, Washington, 1885, p. 41.

¹² C. Lambert, 'Mœurs et superst. de la tribu Bélep (Nouvelle Calédonie),' *Les Missions catholiques*, Paris, 1880, xii. 389.

¹³ J. Kohler, 'Recht d. Marschallinsulaner,' *ZVRW* xiv. [Stuttgart, 1900] 440.

¹⁴ L. H. Gulick, 'Micronesia,' *Nautical Mag. and Naval Chron.*, London, 1862, p. 180.

¹⁵ Wilkes, ii. 127.

¹⁶ *Reports of the Cambr. Anthropol. Exped. to Torres Straits*, Cambridge, 1908, vi. 118-119, 186 f.; see also J. Kohler, 'Recht d. Papuas,' *ZVRW* xiv. [1900] 370.

¹⁷ J. Kohler, 'Rechtsvergleichende Skizzen,' *ib.* viii. [1889] 86.

¹⁸ C. Hill-Tout, 156.

Carolina,¹ the Wanika,² the Waniamwesi,³ the Masai,⁴ and the Samoyeds.⁵

(2) Very frequently a small present is given in the hope of receiving a large one in return—a practice which illustrates the point of the saying 'beneficia non obtrunduntur.'⁶ In Nigeria the present which the king sends to the stranger is 'in every case to be regarded, not as an expression of good-will, but as the formal demand for a larger present';⁷ and Livingstone⁸ speaks of the practice near Senna, on the lower Zambesi, of making 'a very small gift, which is to win back to the donor at least twice its value.' If a native is asked to sell some article, he declines on the ground that it is *seguati*—it is not for sale, it is a compliment. The Chiboque 'are in the habit of making a present and demanding whatever they choose in return';⁹ the Wahkiacums offer presents, expecting three or four times their value in return.¹⁰

(3) While the donor always expects a return, he does not always stipulate for the precise shape which it shall take. Thus, at Wytoohee—an island of the Paumotu group—the inhabitants accepted with gratitude and delight anything given in return for the articles taken from them;¹¹ and, although the Bakairi exchanged the specialties of one district for those of another, they knew nothing of the practice of bartering specific article for specific article.¹² Sometimes the savage throws out a hint of what he wants;¹³ and sometimes nothing else will serve him but the article which has caught his fancy. In many cases, he is said to give some product of his industry or skill—the result it may be of the labour of months or years—for a mere trifle;¹⁴ while instances are not wanting of his shrewdness in making a bargain.

As to the savage's ignorance of or indifference to value, see J. Viehe, *Die Ovaherero*, ap. S. R. Steinmetz, p. 812; G. F. de Oviedo, *Hist. nat. et gén. des Indes*, tr. J. Peleur, Paris, 1556, pt. i. bk. v. cap. iii. p. 76a; D. Crantz, l. 161; R. Schomburgk, *Reisen in Brit.-Guiana in 1840-44*, Leipzig, 1847, i. 175; A. Donaldson Smith, *Through Unknown African Countries*, London, 1897, p. 277 f.; O. Dapper, *Descr. de l'Afrique*, Amsterdam, 1686, p. 389; G. W. Stow, *Native Races of S. Africa*, London, 1905, p. 250. See also R. C. Temple, 'Beginnings of Currency,' *JAI* xxix. (1899) 101 f.; F. Schultze, *Psychol. der Naturvölker*, Leipzig, 1900, p. 215 f.; J. Kohler, *ZVRW* xxii. (1909) 298; A. Sartorius von Waltershausen, 'Die Entstehung d. Tauschhandels in Polynisien,' *Zeitschr. f. Social- und Wirtschaftsgesch.* iv. (Weimar, 1896) 59 ff.

(4) Thus this primitive practice of exchanging articles partakes in some cases of giving rather than of bartering, and, in others, of bartering rather than of giving. On the whole, it seems best to regard the transaction as one of mutual gift, for the amount given is by no means exclusively

¹ J. Lawson, *Hist. of Carolina*, London, 1714, p. 232.

² J. L. Krapf, *Travels, Researches, and Missionary Labours during 18 Years' Residence in East Africa*, London, 1860, p. 150.

³ J. Kohler, 'Das Banturecht in Ostafrika,' *ZVRW* xv. (1901) 46.

⁴ M. Merker, *Die Masai*, Berlin, 1904, p. 206.

⁵ P. von Stenin, 'Gewohnheitsrecht der Samoeden,' *Globus*, lx. (1891) 187; see also E. W. Lane, *Modern Egyptians*, London, 1890, repr. from the 3rd ed. 1842, pp. 185 f., 263.

⁶ See R. M. Meyer, 'Zur Gesch. des Schenkens,' *Zeitschr. für Kulturgesch.* v. (1897) 25.

⁷ C. H. Robinson, *Nigeria, Our Latest Protectorate*, London, 1900, p. 98.

⁸ D. and O. Livingstone, *Narr. of an Exped. to the Zambesi and its Tributaries, 1858-64*, London, 1865, p. 87.

⁹ D. Livingstone, *Miss. Travels and Researches in S. Africa*, London, 1857, p. 348.

¹⁰ M. Lewis and W. Clarke, *Travels to the Source of the Missouri River . . . in the Years 1804-6*, new ed., London, 1815, ii. 371. Other instances are given by Hamilton-Grierson, *The Silent Trade*, Edinburgh, 1903, p. 19.

¹¹ O. Wilkes, i. 322.

¹² K. von den Steinen, *Unter d. Naturvölkern Zentral-Bra-siliens*, Berlin, 1894, p. 334.

¹³ E. Shortland, p. 199; Cook and King, ii. 73.

¹⁴ A. Ross, *Adventures of the First Settlers on the Oregon or Columbia River*, London, 1849, p. 323; B. Spencer, *Horn Exped. to C. Australia*, London, 1896, pt. iv. p. 36 f.

determined by purely commercial considerations.¹ See below, 5 (1).

3. Return consisting of an act or of an abstention from acting.—(1) We come now to the second class of instances—those, namely, in which the recipient makes a return, not by giving something, but by doing or abstaining from doing something. It is stated to be 'the universal custom of the East for none to present himself before a superior, more especially the king, without a present.'² Free-will offerings were brought to the chieftains of old Germany;³ and a similar practice prevailed in Mexico, and among the Chibchas, and has been observed in Tahiti and Fiji,⁴ in New Caledonia,⁵ among the Monbuttu,⁶ and in Sumatra.⁷ On the Lucalla, each district from which representatives attend the fair must give a present to the chief within whose territory it is held.⁸ Very frequently the protection of a king or headman, and his permission to enter the country, to trade within it, or to leave it, must be purchased with gifts (see art. STRANGERS); and it has been observed that the stranger may have less to suffer from beggars in a despotic than in a republican country, it being presumed that on his first arrival he had satisfied the greatest beggar of all—namely, the king.⁹

It may be noted by the way, that of the presents, of which the original purpose was to secure the protection of a superior, many lose in course of time their voluntary character. In Fiji, forced presents were made to *vasus* by their hosts;¹⁰ and in New Zealand,¹¹ and among certain Kaffir tribes,¹² chiefs on visiting expect to receive large presents from their entertainers, the revenue they derive being really a tax.¹³ Spencer points out that, where the political head assumes universal ownership, he recompenses his subordinates by giving them gifts.¹⁴ Thus, liberality is expected from the chief; so that, among the Abipones, for example, he must give what he has, even when asked for the garment on his back.¹⁵ 'We still have in vails and Christmas-boxes to servants, etc., the remnants of a system under which fixed remuneration was eked out by gratuities—a system itself sequent upon the earlier system under which gratuities formed the only remuneration.'¹⁶ The system to which Spencer alludes is in full force in the East. An Oriental expects not only to be paid for his services at the stipulated rate, but to receive a gift on leaving his employer; and this expectation prevails among persons in all ranks of society.¹⁷

(2) No one consults a prophet,¹⁸ or a priest or priestess,¹⁹ without giving presents; and, in New Guinea, the Toaripi tribesmen obtain the prayers of the sorcerer by means of gifts.²⁰ If bananas are not growing well, the Murray Islander takes some

¹ See W. Cunningham, *An Essay on Western Civilization in its Economic Aspects* (i. 'Ancient Times'), Cambridge, 1898, p. 26.

² A. H. L. Heeren, *Histor. Researches into the Politics, Inter-course, and Trade of the Principal Nations of Antiquity*, Oxford, 1833, i. 412; cf. Jg 817, 1 K 1010, Ps 7210.

³ Tac. *Germ.* 15; see J. Grimm, *Deutsche Rechtsalterthümer* 3, Göttingen, 1881, p. 245 f.

⁴ Authorities in H. Spencer, *Principles of Sociology*, London, 1879, § 369.

⁵ V. de Rochas, *La Nouvelle Calédonie et ses habitants*, Paris, 1882, p. 251.

⁶ Emin Pasha in *Central Africa*, tr. Mrs. R. W. Felkin, London, 1888, p. 205.

⁷ W. Marsden, *The History of Sumatra*, London, 1783, p. 275.

⁸ H. von Wissmann, *My Second Journey through Equatorial Africa*, London, 1891, p. 126.

⁹ J. L. Krapf, pp. 275, 370.

¹⁰ J. E. Erskine, *Journal of a Cruise among the Islands of the Western Pacific*, London, 1853, p. 255.

¹¹ Polack, l. 40.

¹² T. Nauhaus, 'Regierungsform u. Gerichtsbarkeit d. Kaffern,' *ZE* xiii. (Berlin, 1881) 351.

¹³ See A. van Gennep, *Tabou et totémisme à Madagascar*, Paris, 1904, p. 97. Many other instances will be found in Spencer, §§ 369-372; see also S. R. Steinmetz, p. 45, note 2.

¹⁴ § 375; F. H. Lang, *Die Waschambala*, ap. Steinmetz, p. 263.

¹⁵ M. Dobrizhoffer, *An Account of the Abipones*, tr. from the Latin, London, 1822, ii. 107.

¹⁶ Spencer, § 375.

¹⁷ H. Clay Trumbull, *Studies in Oriental Social Life*, London, 1895, p. 327.

¹⁸ 1 S 97f., 1 K 143, 2 K 88.

¹⁹ A. B. Ellis, *The Tshi-speaking Peoples of the Gold Coast of West Africa*, London, 1887, p. 124.

²⁰ J. Chalmers, 'Toaripi,' *JAI* xxvii. (1898) 333.

of them as a gift to the *zogo le*, who makes a charm to ensure a plentiful crop;¹ and presents are given to the medicine-man for his services in treating the sick,² and, if the latter dies, in ascertaining whose witchcraft slew him.³ If he fails to cure, he must return the gifts.⁴

(3) Often the purpose of the gift is to procure the abandonment of rights. Among the Jekris, Sobos, and Ijos, the son-in-law gives his father-in-law a *dash* (i.e. a present) on the birth of the first child;⁵ while, among the Ba-Yaka, on a child's birth, the chief of the mother's village gives a gift of fowls to the father; and, as soon as it can walk, it is sent to the chief's village, to which it legally belongs, and from which the father cannot even purchase it.⁶ Again, there are cases in which the bridegroom is resisted, as he meets the bride, by his own kinsmen, until he gives them something, and cases in which the bride refuses to enter the bridegroom's house until she has received a present from his friends.⁷ Sometimes a present is given by the bridegroom to his mother-in-law, to signify that the bride is thenceforth separated from the home of her girlhood,⁸ and with this gift may be compared that given, among the Chamorro, by members of the bride's and bridegroom's families to the latter's mother.⁹ Somewhat similar is the case of the bride in Uganda. During the first month of marriage she veils her face; and the bridegroom is permitted to lift the veil only on giving her a goat to be eaten by her and her friends.¹⁰ A present of money procures a similar privilege in modern Egypt.¹¹

(4) Sometimes a gift serves as compensation for loss. Thus, among the Banaka and Bapuku, it is obligatory on a husband whose wife has died to give something to her family; while the kinsfolk of a dead man must make a present to the relatives of his mother.¹² The Déné recognize the former obligation.¹³

(5) In Ashango-land, if a stranger accepts a present from the natives, he is bound to make some stay in their district.¹⁴

(6) Crime is expiated,¹⁵ and peace is purchased,¹⁶ by making presents. Again, a tabu may be removed by a gift of food;¹⁷ and by presents the imposition of a tabu may be bought off.¹⁸

(7) It is a world-wide practice for the suitor to open his suit by making a gift, it may be to the

¹ A. E. Hunt, 'Ethnogr. Notes on the Murray Islands, Torres Straits,' *JAI* xxviii. [1898] 8.

² Jetté, pp. 167, 171 (Ten'a).

³ A. C. Hollis, *The Nandi*, Oxford, 1909, p. 71 (Nandi).

⁴ Jetté, *loc. cit.*

⁵ R. K. Granville and F. N. Roth, 'Notes on the Jekris, Sobos, and Ijos,' *JAI* xxviii. [1898] 107.

⁶ E. Torday and T. A. Joyce, 'Notes on the Ethnography of the Ba-Yaka,' *JAI* xxxvi. [1906] 45.

⁷ W. Crooke, 'The Hill Tribes of the Central Indian Hills,' *JAI* xxviii. [1898] 239 f., also *Natives of Northern India*, London, 1907, p. 210 ff.

⁸ P. Desoignies, *Die Msalala*, ap. Steinmetz, p. 273.

⁹ C. E. Meinicke, *Die Inseln des stillen Oceans*, Leipzig, 1875-76, ii. 407.

¹⁰ O. K. Baskerville, *Die Waganda*, ap. Steinmetz, p. 190. As to Thonga clans, see H. A. Junod, *The Life of a South African Tribe*, London, 1912, pp. 113, 115.

¹¹ Lane, p. 156. Other instances will be found in A. van Gennep, *Les Rites de passage*, Paris, 1909, pp. 170 ff., and note, 181, 183 f., 188 f.; see esp. p. 177.

¹² Steinmetz, pp. 37, 40.

¹³ C. Hill-Tout, p. 147.

¹⁴ P. B. du Chaillu, *A Journey to Ashango-land*, London, 1867, p. 328; see also p. 243.

¹⁵ Bridges, p. 177; F. Parkman, *The Jesuits in North America in the Seventeenth Century*²⁰, London, 1885, p. 354; T. Williams and J. Calvert, *Fiji and the Fijians*, 2nd ed. by R. S. Rowe, London, 1860, i. 31; *Reports of the Cambridge Anthropol. Exped. to Torres Straits*, Cambridge, 1908, vi. 99.

¹⁶ J. Roscoe, 'The Bahima,' *JRAI* xxxvii. [1907] 108; Riedel, p. 446 (Wetar); L. Loria, 'Notes on the Ancient War Customs of the Natives of Logea and the Neighbourhood,' *Colonial Reports*, Annual, no. 168, British New Guinea (1894-95), London, 1896, p. 63; 1 S 251²⁸.

¹⁷ See 4 (a) (3) below; cf. the *jing sang* of the Khasis (P. R. T. Gardon, *The Khasis*, London, 1907, p. 77).

¹⁸ R. H. Codrington, *The Melanesians*, Oxford, 1891, p. 217.

girl's father,¹ or to her family,² or to her and her relations,³ or to her alone.⁴ Sometimes this gift is handed to the girl's mother,⁵ or, where she does not belong to her suitor's tribe, to her father and to the headman and other principal men of her tribe.⁶ If the suit is unwelcome, the gifts are in many cases returned.⁷ Among the Lapps⁸ and the Siena,⁹ presents are given at every stage of the courtship to the girl and her relatives; while among the Bororo¹⁰ and the Orang-Ot of Borneo¹¹ it is the lady who begins the courtship by giving presents to the man of her choice. In Japan, the sending of presents by the intending husband forms one of the most important parts of the nuptial ceremony;¹² while, in many instances, present-giving seems to be recognized as the only solemnity.¹³

It may be noted that Westermarck (p. 395) and Kohler ('Das Recht d. Birmanen,' *ZVRW* vi. [1886] 167, 'Das Gewohnheitsrecht der Provinz Bombay,' *ib.* x. [1892] 80) are of opinion that the giving of bride-gifts is a relic of a previous custom of marriage by purchase; while Crawley (*The Mystic Rose*, London, 1902, p. 387; cf. Steinmetz, pp. 307, 319; Lane, p. 147) regards the latter as a development from the former—a view which seems to be supported by the evidence.

(8) At Tlingit feasts in remembrance of the dead,¹⁴ and at gift festivals held by the tribes south of the Yukon River,¹⁵ men gain rank and reputation by giving away their whole possessions. Similar facts are reported of the Ahts¹⁶ and the Western Eskimos.¹⁷ It seems that the desire to establish his position as a great man forms the motive of the Lekunen bridegroom's generosity,¹⁸ and, to some extent, of the host's munificence in giving presents to his guests in Scandinavian antiquity.¹⁹ Among the Carriers, strips of skin are distributed on the death of the head of the clan by his successor

'as an act of atonement for the death of the deceased noble, gifts of such sort being looked upon as wiping out the shame and grief of the mourners' (C. Hill-Tout, *Brit. N. Amer.*, p. 149).

(9) The custom of giving presents to the departing guest is wide-spread (see 1 (3) above). It was

¹ J. Chapman, *Travels in the Interior of South Africa*, London, 1868, i. 259 f. (Bushmen); H. O. Forbes, *A Naturalist's Wanderings in the Eastern Archipelago, 1878-83*, London, 1885, p. 241 (Kubu); J. Bailey, 'An Account of the Wild Tribes of the Veddahs of Ceylon,' *Trans. of the Ethnol. Soc.*, new ser., ii., London, 1862, p. 291 ff. (Veddahs); G. Tellier, 'Kreis Kita, Französischer Sudan,' ap. Steinmetz, p. 151.

² S. Powers, iii. 317 f. (Nishinam); C. Hill-Tout, 'Ethnol. Report on the . . . Salish of British Columbia,' *JAI* xxxiv. [1904] 318 (Salish Tribes); O. H. Stigand, 'Notes on the Natives of Nyassaland, N.E. Rhodesia, and Portuguese Zambesia,' *JRAI* xxxvii. [1907] 122 (Achapeta, Atonga, Achewa, Ayao).

³ Gn 24²² 53; G. Turner, *Nineteen Years in Polynesia*, London, 1861, p. 185.

⁴ Steinmetz, p. 33 (Banaka and Bapuku); O. K. Baskerville, ap. Steinmetz, p. 188; M. Rautanen, 'Die Ondonga,' ap. Steinmetz, p. 330; A. van Gennep, p. 198 (Vai of Liberia), p. 201 (Herero).

⁵ Nicole, 'Die Diakite-Sarrakolesen,' ap. Steinmetz, p. 108; C. E. Meinicke, ii. 407 (Ladrones).

⁶ A. W. Howitt, *Native Tribes of S.E. Australia*, London, 1904, p. 185.

⁷ Fama Mademba, 'Die Sansanding-Staaten,' ap. Steinmetz, p. 68; M. Rautanen, 'Die Ondonga,' *ib.* p. 330.

⁸ J. Scheffer, *Hist. of Lapland*, Oxford, 1674, p. 110 ff.

⁹ A. van Gennep, p. 195 ff.

¹⁰ V. Fric and Paul Radin, 'Study of the Bororo Indians,' *JAI* xxxvi. [1906] 390.

¹¹ C. A. L. M. Schwaner, *Borneo: Beschrijving van het Stroomgebied van den Barito*, Amsterdam, 1853, i. 230.

¹² E. Westermarck, *Hum. Marr.*², London, 1894, p. 395.

¹³ J. B. von Spix and C. F. von Martius, *Travels in Brazil in the Years 1817-20*, London, 1824, ii. 246 (Puris, Coroados, and Coropos); E. Torday and T. A. Joyce, 'Notes on the Ethnography of the Ba-Mbala,' *JAI* xxxv. [1905] 410 (in the case of child-marriage); O. von Kotzebue, *A Voyage of Discovery into the South Sea and Beering's Straits*, London, 1821, iii. 210 (Caroline Islands).

¹⁴ H. J. Holmberg, *Ethnogr. Skizzen über d. Völker d. russischen Amerika*, pt. i., Helsingfors, 1855, p. 46 f.

¹⁵ Dall, p. 149 ff.

¹⁶ G. M. Sproat, *Scenes and Studies of Savage Life*, London, 1868, p. 112 f.

¹⁷ H. Rink, *The Eskimo Tribes*, London and Copenhagen, 1887, p. 28 f.

¹⁸ Hill-Tout, 'S.E. Tribes of Vancouver Island, B.C.,' *JRAI* xxxvii. [1907] 311 f.

¹⁹ K. Weinhold, *Altnordisches Leben*, Berlin, 1856, p. 449.

practised in the world of Homer,¹ and in the northern countries;² and it is in observance in the Andaman Islands,³ among the Banaka and Bapuku,⁴ in New Guinea, and among the Aleuts,⁵ in New Zealand,⁶ and among the Ostiaks.⁷ It may be noted that a gift is sometimes given by the guest to the host.⁸

(10) It is to be observed that in some of the instances mentioned above the object of the giver is not so much to procure the performance of, or the abstention from, an act, as to create in the recipient a disposition favourable to himself. For example, a man may give away his property in order to impress others with his importance, or to gain a reputation for generosity (see 3 (8) above). The suitor's present to the girl's parents may be due to his desire to ingratiate himself with them (see (7) and (8) above); and the host's parting gift may express nothing more than a wish to kindle friendly feelings in the breast of his guest (see (9) above). We shall return to the consideration of this topic (see 4 (6) below).

(11) In connexion with the last two instances mentioned in the preceding paragraph, it is to be noted that the purpose of the donor—the suitor who gives to the girl's parents, and the host who gives to his departing guest—is not always and everywhere one and the same. The suitor gives sometimes to gain the goodwill of the parents, and sometimes to buy off their rights in their daughter; and the host gives sometimes to strengthen the ties of friendship, and sometimes, it may be, to secure a similar gift when it is his turn to be entertained (see 1 (3) above). These instances might easily be multiplied. Moreover, it is not to be forgotten that, in making a present, the donor may have in view more purposes than one. He may, for example, be seeking, by one and the same act, to obtain the donee's favour, to acquire a material benefit for himself, and to take part in the performance of a religious or magical ceremony.⁹

4. The ground upon which the donor rests his expectation that a return will be made.—(a) *Where the return is in the form of a material thing.*—It is obvious from the evidence which has been adduced that, among uncivilized peoples, gifts are given in the expectation that a return will be made; and the question at once presents itself: What ground has the donor for entertaining this expectation? In other words, What is it which induces or constrains the recipient to make a return? We shall take, first of all, the case of a material return.

(1) Now, it is strictly in accordance with primitive notions to regard 'the nature of anything as inhering in all its parts,'¹⁰ even when the parts are separated from it,¹¹ and to treat as part of a man's substance not only his blood, saliva, umbilical cord, sweat and other *excreta*, hair-clippings, nail-parings, and the like, but earth from his foot-

prints, the remains of his food, his name, his portrait, his garments, ornaments, weapons, and implements.¹ This conception has two important consequences. If the man is in all his parts, whether these are or are not detached from him, it follows that they may be the medium either of his action upon others or of the action of others upon him. A part may be so impressed with his personality—with his intention for good or ill—as to benefit or injure any one with whom it may be brought into contact. On the other hand, whoever gets possession of it will be able through it to work his will, at any distance, upon the man himself.² Accordingly, if A give an article belonging to him to B, he gives a part of himself—a gift which may be dangerous to himself, for, by giving it, he puts himself in B's power; or it may be dangerous to B, for A may impress upon it his will to injure him.³ Thus, in Morocco, if a person give food or drink,

'it is considered dangerous, not only for the recipient to receive it without saying, "In the name of God," but also for the giver to give it without uttering the same formula, by way of precaution. . . . It seems likely that the custom of not receiving payment from a guest is largely due to that same dread of strangers which underlies many other rules of hospitality' (E. Westermarck, *MI* i. 590, 593).

(2) To give is frequently regarded as perilous to the donor. Thus, among the Australian tribes other than those of the centre, hair is never given by the owner, lest he should put it into the power of the recipient to injure him.⁴ Again, it is thought to be dangerous to give salt or leaven out of the house, for, if it pass

'into the hands of any person who has the power of wishing, i.e. of bringing down harm on another by uttering an ill wish, the possession of it places the giver entirely within the power of the wish.'⁵

(3) In some cases a gift will ward off harm at the hands of witch or fairy. Thus, in Cornwall, in the Isle of Man, in Somersetshire, and in some parts of Scotland, it was customary for the woman who carried a child to be christened to give bread and cheese to the first person whom she met;⁶ and a refusal of the gifts was regarded as an expression of evil wishes towards the child.⁷ With this practice we may perhaps compare that of the Stlatlunh (or Lillooet), among whom visitors to the parents on the birth of a child receive presents from its father.⁸ In the Highlands of Scotland, if a stranger has looked over a cow, the dangers of the evil eye are averted by offering him some of its milk to drink;⁹ and in Australia a tabu is removed by a present of food. Thus, among the Unmatjera and Kaitish tribes, a widow is under a ban of silence after her husband's death, usually for many months, until she is released from it by the dead man's younger brother.

'When this takes place she makes an offering to him of a very considerable quantity of food, with a fragment of which he touches her mouth, thus indicating to her that she is once more free to talk and to take part in the ordinary duties of a woman.'¹⁰

¹ *Od.* i. 311 f., ix. 267, xi. 353 f., xiii. 10, xv. 113 f.

² *The Story of Grettir the Strong*, tr. from the Icelandic by E. Magnússon and W. Morris, new ed., London, 1900, p. 60; R. Proctor, *The Story of the Laxdalers done into English*, 1903, chs. 9, 27, and 29; S. Laing and R. B. Anderson, *The Heimskringla, or the Sagas of the Norse Kings*, from the Icelandic of Snorri Sturlason, London, 1889, i. 358, iii. 26, 52, 172; see also *Tac. Germ.* 21; Weinhold, p. 448.

³ *Man*, p. 26.

⁴ Steinmetz, p. 45.

⁵ See art. STRANGERS, § 28. In these two instances, the gift takes the form of provisions for the journey.

⁶ G. Gray, *Polynesian Mythology*, London, 1885, p. 309.

⁷ P. S. Pallas, *Voyages . . . dans plusieurs provinces de l'empire de Russie et dans l'Asie septentrionale*, tr. G. de la Peyronie, Paris, 1800, v. 162.

⁸ Nicole, *ap.* Steinmetz, p. 123; *Tac. Germ.* 21; Weinhold, p. 448.

⁹ See A. van Gennep, *Les Rites de passage*, p. 50 f.

¹⁰ H. Spencer, *op. cit.* § 346.

¹¹ J. G. Frazer, *GB*³, pt. i., 'The Magic Art and the Evolution of Kings,' London, 1911, i. 52; E. Durkheim, 'La Prohibition de Pineste et ses origines,' *ASoc.* i. [1896-97], Paris, 1898, p. 51; E. B. Tylor, *Researches into the Early History of Mankind*, London, 1865, p. 127 f.; Crawley, pp. 117, 120.

¹ E. S. Hartland, *LP*, London, 1894-96, ii. 52, 55-116.

² J. G. Frazer, *GB*³, pt. i. vol. i. p. 175; Crawley, pp. 117, 120.

³ See J. H. Weeks, 'Anthropological Notes on the Bangala of the Upper Congo River,' *JRAI* xi. [1910] 423.

⁴ Spencer-Gillen^b, pp. 478, 605, *465, 553; Howitt, pp. 363, 365; cf. A. C. Hollis, p. 74 f. (Nandi); Riedel, p. 262 (Arru).

⁵ W. Henderson, *Notes on the Folk-Lore of the Northern Counties of England and the Borders*, new ed., London, 1879, p. 217. Analogous cases will be found in A. Wuttke, *Der deutsche Volksaberglaube der Gegenwart*, ed. E. H. Meyer, Berlin, 1900, §§ 582, 730; see also 'Choice Notes from Notes and Queries,' *FL*, London, 1859, p. 26.

⁶ 'Choice Notes,' *loc. cit.* pp. 147 f., 175; J. Napier, *Folk-lore, or Superstitious Beliefs in the West of Scotland within the Century*, Paisley, 1879, p. 32; W. Gregor, *Notes on the Folk-Lore of the North-East of Scotland*, London, 1881, p. 13.

⁷ Napier, p. 32; see (11) below.

⁸ C. Hill-Tout, 'Report on the Ethnol. of the Stlatlunh of British Columbia,' *JAI* xxxv. [1905] 139.

⁹ 'Choice Notes,' *loc. cit.* p. 257.

¹⁰ Spencer-Gillen^b, p. 608; cf. also pp. 218, 295, 526, 547, 554 f., 598 f., 600 f.; also *, pp. 257, 260, 382 f.; Howitt, p. 663; cf. Crawley, p. 231.

(4) To accept a gift may be no less dangerous. It is said of the Tlingits and Haidas that every gift is received with mistrust;¹ and the Annamese decline presents 'for fear of bringing ill-luck into the place.'² An offer of snuff unasked would be regarded by a Kaffir with suspicion; and, were he taken ill, it would be thought that he had been poisoned by the donor of the pinch.³ A somewhat similar risk is incurred by those who eat fairies' food; and the same idea is at the root of the drinking customs of Greece, Rome, and Germany.⁴ In Servia, it is usual, when sending an apple to a relative, to bite a little piece out of it, so as to show the mark of the teeth;⁵ and, in Melanesia, 'a native offering even a single banana to a visitor will bite the end of it before he gives it, and a European giving medicine to a sick native gives confidence by taking a little first himself.'⁶ Crawley⁷ cites an instance which makes clear the meaning of these practices:

'Amongst the Krumen, at a palm wine-drinking the goodwife of the house has to take the first and last draught herself, to show the guests that she has not been dealing in poison or witchcraft. This is called "taking off the fetish."⁸

(5) In other cases, a gift by a person whose evil wishes are feared seems to have the effect of rendering him innocuous. Thus, a Kayan stranger, who comes into a house where there is a young child, brings a gift with him, lest his appearance should frighten away its soul.⁹

The difficulty in deciding whether to take or refuse a gift is identical with the difficulty 'in knowing how to act when a witch offers to shake hands with us. No doubt there is some risk in accepting the courtesy, since the action entails on us all the ill she may wish us. Still it insures us equally all the good she may wish us, and therefore it seems a pity to refuse one's hand.'¹⁰

(6) How, then, are these dangers to be averted? We are told that, in New Zealand, when a chief has medicine administered to him by a European, he always demands payment;¹¹ and Hartland¹² informs us that, in Ireland, 'when a child is vaccinated, the medical man is not allowed to take lymph from its arm without giving some present, however trifling, in return.' In a case from Tipperary, the nurse reported that the child's arm was kept inflamed because the doctor had neglected, when taking the lymph, to put silver in its hand; and Hartland attributes this superstition to the belief in witchcraft.

'Payment,' he adds (*loc. cit.*), 'is always held to neutralise a witch's power over a person through something received from him, probably because what she gives in exchange would confer a like power over her, and hence becomes a hostage for her good faith.'

Accordingly, in order to avert these dangers in giving and receiving, each party to the transaction must both give and take. This principle is illustrated by the account which H. von Wissmann¹³ gives of his meeting with a dwarf people, whom he found among the Batetela. They gave him presents of which they implored his acceptance, and, on his taking them, they went away satisfied.

'They evidently acted in this way under the impression that my presents, if they did not return them, would give me some power over them. Such mistrust is quite a mark of the genuine savage.'

When the Spaniards at Cabo de Gracias a Dios would not take the articles set out by the natives, the latter laid down all that they had received near the sea, where the former found it the next day;¹⁴ and, in Tahiti, the islanders would not

¹ J. Kohler, 'Das Launegild bei den Tlinkit Indianern,' *ZVRW* viii. 86.

² F. Ratzel, *Hist. of Mankind*, tr. A. J. Butler, London, 1896-98, iii. 418.

³ J. Shooter, *The Kafirs of Natal and the Zulu Country*, London, 1857, p. 223.

⁴ J. Grimm, 'Ueber Schenken und Geben,' *Kleinere Schriften*, Berlin, 1865, ii. 178.

⁵ *Ib.* ⁶ R. H. Codrington, p. 204 and note. ⁷ P. 153.

⁸ J. L. Wilson, *Western Africa*, London, 1856, p. 124.

⁹ A. W. Nieuwenhuis, *Quer durch Borneo*, Leyden, 1904, I. 74; cf. Junod, p. 191.

¹⁰ *Wilkie MS*, ap. W. Henderson, p. 180.

¹¹ W. Yate, *An Account of New Zealand*, London, 1835, p. 104.

¹² *Ii.* 75. ¹³ P. 167.

¹⁴ A. de Herrera, *Gen. Hist. of America*, tr. Stevens, London, 1725, i. 264.

accept Wallis's presents until his men had taken all the articles which they offered in return.¹ The islanders of Mannicola declined to accept presents when they had nothing to give;² and the natives at Astrolabe Bay deposited on the beach every morning fresh gifts for their European visitors, with whom they were on terms of enmity, and left untouched the articles placed there as a counter-gift.³

With these instances may be compared those supplied by popular superstition: the case, for example, of the Durham schoolmaster, who dared not give a knife to one of his pupils without receiving a penny, in order that it 'might be purchased, not given';⁴ and the widely prevalent belief that it is unlucky to give a knife or a pair of scissors, unless some return be made to the donor.⁵ We are told that, in South Germany, the dwarfs were always careful to make a return for anything which they had received;⁶ and that, in Altenburg and Silesia, if anything is given out of a house, the luck is given away unless some trifle, such as a needle, be given in return.⁷

(7) We have seen that the principle of exchange is that of giving in order to receive—that the gift is made in the expectation, if not on the understanding, that a return will be made. Further, the evidence adduced seems to warrant the view that this expectation rests, to some extent, at all events, upon the notion that it is dangerous to accept the thing given without giving something in exchange for it, and that, if each of the parties both gives and takes, the danger is averted. What then is the nature of this new relation? It is that of union, brought about by an interchange of substance—a union, therefore, of the most intimate character.⁸

The closeness of the connexion is illustrated by the fact that, among the Eskimos of Bering Strait, persons exchanging presents at the 'Asking Festival' are considered to hold a certain temporary relationship. Formerly they gave and received presents at the festival every succeeding year.⁹ A somewhat similar instance is that of the Tarahumare, with whom a purchase establishes a kind of brotherhood between the parties to it. Thenceforward they call each other 'naragua,' and a confidence is established between them much the same as that which subsists between 'compadres' among the Mexicans.¹⁰

(8) The duration of this substantial union appears to differ in different cases. Where, for instance, men have been made 'brothers' by an exchange of blood or by the use of some other rite, the relation so constituted is often a lifelong, and sometimes a hereditary, relation (see BROTHERHOOD [Artificial]). Among the central Australians, a connexion which appears to be temporary is created between those who are about to take part in an avenging expedition, by an exchange of blood, which has the effect of rendering treachery impossible.¹¹ So, too, where the union is brought about by an exchange of food or drink, or by eating together—which is regarded as virtually the same thing—it is often merely temporary. Thus Doughty¹² tells us of the Bedawin that by 'bread and salt' peace is established with the stranger for a time—for, that is to say, two nights and the intervening day—'whilst their food is in him'; and Burton¹³ adds that some tribes required the bond to be renewed every twenty-four hours, as

¹ J. Hawkesworth, *An Acc. of Voyages in the Southern Hemisphere*, London, 1773, i. 451 f.

² P. Dillon, *Narr. of a Voyage in the South Seas*, London, 1829, ii. 151.

³ C. Hager, *Kaiser-Wilhelms-Land und der Bismarck-Archipel*, Leipzig, 1886, p. 65.

⁴ Henderson, p. 118.

⁵ 'Choice Notes,' *loc. cit.* p. 7 (Dutch Folklore); G. F. Jackson and C. S. Burne, *Shropshire Folklore*, London, 1883, p. 279; Napier, p. 138; Henderson, p. 118; see also F. Liebrecht, *Ger. Tilb. Otia Imperialia*, Hanover, 1856, p. 101.

⁶ A. Wuttke, § 46.

⁷ *Ib.* § 625. ⁸ Cf. Crawley, pp. 262, 372 f.

⁹ E. W. Nelson, 'The Eskimo about Bering Strait,' *18 RBEW*, Washington, 1899, pt. i. p. 359 ff.

¹⁰ C. Lumholtz, *Unknown Mexico*, London, 1903, i. 244.

¹¹ Spencer-Gillen^a, p. 461; ^b, p. 598; cf. D. M. Smeaton, *The Loyal Karens of Burma*, London, 1887, p. 168 f.

¹² *Arabia Deserta*, Cambridge, 1888, i. 228.

¹³ *Personal Narr. of a Pilgrimage to El-Medinah and Meccah*, London, 1855-56, iii. 84.

otherwise, to use their own phrase, 'the salt is not in their stomachs.'

(9) It would seem, then, that in every case of a breach of this union the wrong-doer lays himself open to the vengeance of the man whom he has wronged. But this is not the only or the greatest danger to which he exposes himself. For, where the relation is so intimate and so complete that each of the parties is, in a very literal sense, the *alter ego* of the other, its rupture may be productive of the direst consequences to him who is in fault; and these consequences are due not to the action of the injured party, but to that automatic retribution—in the form, it may be, of disease, or disaster, or death—which follows upon the breach of a tabu.¹

(10) If an exchange of presents can produce a union such as this, it is easy to understand why it is that the solemn occasions of savage or barbaric life are almost invariably celebrated by such an exchange. It signalizes the birth of a child,² and it accompanies marriage,³ circumcision,⁴ initiation,⁵ and the constitution of such relations as those of brotherhood by choice (see BROTHERHOOD [Artificial]), and those between protector and protégé,⁶ and club and privileged stranger.⁷ In China, it has a place in betrothal,⁸ and in mourning ceremonies;⁹ and it is practised at inter-tribal assemblies,¹⁰ in the formation of alliances,¹¹ on the conclusion of peace,¹² and in evidence of intimate friendships.¹³ Visits are frequently the occasion of an interchange of gifts, as, for example, those made to a woman on her confinement;¹⁴ while, in the Luang-Sermata group, the female visitors, who bring presents to the young mother, are, at a later date, entertained by the father to a feast.¹⁵ Among the Mohawks, visits are always accompanied by an exchange of presents;¹⁶ and similar accounts are given of the Andaman Islanders,¹⁷ of the Eskimos of Greenland,¹⁸ of the Yahgan,¹⁹ and of the natives of Samoa.²⁰

On days of feasting and rejoicing the Jews sent portions to one another;²¹ and a similar practice was followed in the Homeric world.²²

In Ceram, a man is assisted in building his house by relatives and friends. He feasts them in return, and the former give him presents.²³ The

¹ See A. van Gennep, *Tabou et totémisme à Madagascar*, Paris, 1904, pp. 56, 66, and Index, s.v. 'Sanctions'; G. Brown, *Melanesians and Polynesians*, London, 1910, p. 275 ff.; see also art. BROTHERHOOD (Artificial), § 56.

² G. Turner, p. 178 f. (Samoa); Williams-Calvert, I. 176 (Fijians).

³ G. Turner, p. 186 (Samoa); J. Anderson, *Mandalay to Momi*, London, 1876, p. 301 (Hotha Shans); F. Fawcett, 'The Kondayamkottai Maravars,' *JAI* xxxiii. [1908] 63; A. van Gennep, *Les Rites de passage*, p. 170 ff. (Baskkirs); G. H. von Langsdorff, *Voyages and Travels in various Parts of the World during the Years 1803-07*, London, 1813, I. 153 (Nukahiva); S. R. Steinmetz, p. 86 (Banaka and Bapuku); and see Crawley, p. 386 ff., where other instances are collected.

⁴ Riedel, p. 177 (Ceram and Gorong Archipelago).

⁵ A. van Gennep, pp. 110 f. (Ojibway), 120 (Banks Islands).

⁶ G. A. Hagenmacher, 'Reise im Somali-Lande, 1874,' *Petermann's Geogr. Mitth., Ergänzungsheft*, no. 47, Gotha, 1876, p. 32 (Somalis); V. de Rochas, p. 261 (New Caledonians).

⁷ K. Semper, *Die Palau-Inseln im stillen Ocean*, Leipzig, 1873, p. 298.

⁸ J. H. Gray, *China*, London, 1878, I. 191-197.

⁹ *Ib.* I. 289 ff.

¹⁰ J. E. Erskine, p. 432 (Fiji); *Report of the Internat. Polar Exped. to Point Barrow, Alaska*, p. 41 (Eskimos).

¹¹ O. F. Ph. von Martius, *Von d. Rechtszustände unter d. Ureinwohnern Brasiliens*, Munich, 1832, p. 18.

¹² J. Macdonald, 'Manners, Customs, Superstitions, and Religions of S. African Tribes,' *JAI* xx. [1891] 133.

¹³ Riedel, pp. 43, 128, 220 (Amboyna, Ceram, and Kei Islands); H. Cole, 'Notes on the Wagogo of German East Africa,' *JAI* xxxii. [1902] 321 (Wagogo).

¹⁴ Gray, I. 230.

¹⁵ C. Colden, *Hist. of the Five Indian Nations of Canada*, London, 1756, p. 13.

¹⁶ Man, pp. 27, 80.

¹⁷ Hyades-Deniker, vii. 373.

¹⁸ Neb 810. 12.

¹⁹ Riedel, p. 119.

²⁰ J. Crantz, I. 158.

²¹ G. Turner, p. 329.

²² *Od.* iv. 65, xiv. 487.

Lapps give and receive gifts on coming into the presence of a superior;¹ and, in Bhutan,

'an inferior on approaching a superior presents the white silk scarf, and, when dismissed, has one thrown over his neck, with the ends hanging down in front. Equals exchange scarfs on meeting, bending towards each other with an inclination of the body.'²

(11) This view of the operation of an exchange of gifts makes it readily intelligible why the refusal of a gift is generally regarded as in the highest degree insulting,³ or injurious.⁴ In old Germany, such a refusal had its special forms. Thus, in order to show that it did not proceed from selfish motives, it was accompanied by the invocation of a blessing upon the object returned—'got läze in iuwer bouge beiden saelic sin.'⁵

(b) *Where the return consists of an act, or of an abstention from acting.*—We have seen that, where the return takes the form of a material thing, each of the parties to the transaction—donee as well as donor—gives part of himself to the other. Each puts himself in the other's power. There is an exchange of substance which creates a union. But, in the case which we are considering, neither act nor abstention from acting passes to the donor as part of the donee's substance. Suppose, for example, that an inferior makes a present to a superior in order to obtain his protection, and that the latter accepts it on the footing that he will see to the security of the donor's person and property. The acts which he performs in fulfilment of his engagement are not parts of himself which he gives to the donor in exchange for his gift. They are not elements out of which a union is created. They are, rather, results flowing from a union already in existence, of which the elements are the donor's gift on the one hand, and the donee's acceptance of it on the other. This operation of acceptance appears still more clearly in those cases in which the return consists rather in a state of feeling towards the donor than in an overt act or abstention in his favour. In this connexion we may recall those cases, which we have noted above (see 4 (a) (3)), where a gift to the person, or by the person, whose ill-will is feared averts the danger; and, further, we may refer to the world-wide usage in accordance with which a girl sends a gift to her lover, in order to transmit to him her feelings and to quicken his affections. The gift may be, as in the case of the women of Timor, a flower from her hair or a scarf-pin from her bosom,⁶ or an article, such as a head-band, which, having been 'sung,' acts upon the wearer as a charm.⁷ It seems that, in all these instances, the acceptance of the gift by the recipient as his makes it part of himself, just as it is already part of the donor. Donor and recipient are thus united in and through it, to precisely the same effect as they are united by an interchange of presents; and precisely the same relation of reciprocal goodwill is brought into being (see above, 4 (a) (3) (5) (6) and Crawley, pp. 90, 237, 239). If these views be sound, it is plain why presents are given on days of friendly intercourse or family reunion, as in China, where valuable gifts are made to parents and heads of clans on their birthday festivals;⁸ and why gifts are distributed as part of ceremonies in which the community is interested, as on the

¹ O. Leemius, *de Lapponibus Finmarchia*, Copenhagen, 1767, p. 376.

² S. Turner, *An Account of an Embassy to the Court of the Teshoo Lama in Tibet*, London, 1800, p. 72.

³ s.g. Bridges, p. 179 (Yahgan); Powers, p. 318 (Nishinam); Dall, p. 395 (Aleuts).

⁴ See H. von Wissmann, p. 167, and 4 (a) (3) above.

⁵ Meyer, p. 25.

⁶ A. Featherman, *Soc. Hist. of the Races of Mankind*, Second Division: 'Papua- and Malayo-Melanesians,' London, 1887, p. 461; see also Hartland, II. 118 ff.

⁷ Crawley, pp. 120, 184 ff.; Gregor, p. 86; cf. Spencer-Gillen⁸, p. 542.

⁸ Gray, I. 270 f.

admission of a child into a gens among the Kwakiutl;¹ at the initiation of novices into the secret societies of the Bismarck Archipelago and Solomon Islands;² among the Brahmans of the Deccan and Madras Presidency at ceremonies of adoption;³ on the bestowal of a family name among the Lekunen;⁴ and on the burial of a leading chief at Duke of York's Island.⁵ At a Yahgan burial presents are liberally distributed.⁶

5. The completion of the transaction.—(1) The primitive transaction to which we in ordinary parlance assign the name of 'gift' is thus really a bilateral transaction; and the position of the donor is really that of a person who makes an offer which he can recall, until it has been accepted. In many instances acceptance is signified by some trifling payment or present—a survival, it seems, of the return-gift of which we have so often spoken—once familiar under the name 'launegild,' 'guidardone,' 'guerredon,' 'galar-don,'⁷ and recognizable in the earnest,⁸ or the luck-penny,⁹ which is sometimes given in evidence of the completion of the bargain. Edmond de Bryon¹⁰ quotes from Harou, *Le Folklore de Godarville* (Antwerp, 1893), the statement that, in cases of sale,

'en échange d'un objet qu'on vous offre, vous devez faire un cadeau, fût-il de la plus minime importance. Ainsi il est d'usage de donner une pièce d'un centime ou une épingle lorsqu'on va chercher du petit lait à la ferme.'

Instances are to be found in which other methods are employed to complete the transaction, and to place the object transferred beyond the donor's or seller's reach. Of these a common one is that by which the recipient makes the object his own, or, rather, part of himself, by some act of appropriation. Thus, Cook says of the natives of Tahiti that 'they have a singular custom of putting everything you give to their heads, by way of thanks, as we conjectured. . . . When we gave things to little children, the mother lifted up the child's hand to its head. They also used this custom in their exchanges with us; whatever we gave them for their goods was always applied to the head, just as if it had been given them for nothing. Sometimes they would look at our goods, and, if not approved, return them back; but, whenever they applied them to the head, the bargain was infallibly struck.'¹¹ A similar practice seems to have prevailed in Fiji.¹² So, too, the Eskimos of Savage Island 'lick with their tongue everything that comes into their possession,'¹³ 'as a finish to the bargain and as an act of appropriation.'¹⁴

The significance of these acts appears clearly from the converse practice of the Eskimos of Bering Strait, who retain and, in some cases, swallow part of the article which they are trading, in order to keep possession of its essential essence, and so, through its agency, to obtain another article of the same kind;¹⁵ and from other instances.¹⁶ Again, it is not unusual for farmers, market-women, hawkers, and the like, to spit for

¹ F. Boas, *Second Gen. Rep. on the Indians of British Columbia* (Report of the Brit. Assoc. for the Advancement of Science . . . in 1890), London, 1891, p. 609.

² A. van Gennep, *Les Rites de passage*, p. 118.

³ Dubois-Beauchamp, *Hindu Manners, Customs, and Ceremonies*, Oxford, 1906, p. 370 f.

⁴ C. Hill-Tout, *JRAI* xxxvii. [1907] 309; cf. the Scandinavian customs noted by K. Weinhold, pp. 263, 284.

⁵ B. Danks, 'Burial Customs of New Britain,' *JAI* xxi. [1892] 854 f.

⁶ Bridges, p. 176.

⁷ See Grimm, p. 174 f.

⁸ *Digest*, xviii. 1, 'de Contr. Emtione,' § 35.

⁹ Henderson, p. 119; Jackson and Burne, p. 273; C. H. W. Johns, *Bab. and Assy. Laws, Contracts, and Letters*, Edinburgh, 1904, p. 230.

¹⁰ *Le Folklore du droit immobilier*, Brussels, 1904, p. 59.

¹¹ *A Voyage towards the South Pole and round the World . . . in the Years 1772-75*, London, 1777, i. 222.

¹² Williams and Calvert, i. 155.

¹³ E. Chappell, *Narr. of a Voyage to Hudson's Bay*, London, 1817, p. 65; H. Ellis, *A Voyage to Hudson's Bay . . . in 1746-7*, London, 1748, p. 132; G. F. Lyon, *Private Journal . . . during the recent Voyage of Discovery under Capt. Parry*, London, 1824, p. 21 f.

¹⁴ J. Franklin, *Narr. of a Journey to the Shores of the Polar Sea in the Years 1819-22*, London, 1823, p. 18.

¹⁵ E. W. Nelson, *18 RBEW*, pt. i. p. 437.

¹⁶ See Merker, p. 252; P. Desoignies, *Die Msalala*, ap. Steinmetz, p. 281.

luck on all money received by them,¹ probably for the reason given in Lemon's *Dictionary* (1783), viz. prevent its 'vanishing away like a fairy gift';² and a like practice prevails among the Berbers of the Atlas.³ Interesting in this connexion is the advice given to those who receive money from a witch:

'Put it at once into your mouth, for fear the donor should spirit it away and supply its place with a round stone or slate, which otherwise she might do at pleasure.'⁴

It was from neglect of some such precaution that a fiddler who had been paid in gold for his music by a party of mysterious dancers found that the pieces were really beech-leaves.⁵ Among the Masai, purchases and gifts are completed by spitting on the objects transferred.⁶ By German custom, if a horse was given, the donor dismounted, and the recipient mounted; if a garment was given, the donor took it off, and the recipient put it on; if a necklace was given, it was clasped by the donor round the recipient's neck; while, in other cases, the thing given was in some way or other attached to the person of the donee.⁷ From this 'binding on' (*anbinden*), Grimm derives the expression *Angebinde* ('present').⁸

(2) In some cases a transaction of gift takes the form of a sale,⁹ it may be to bring within the domain of law a transaction which lies beyond it,¹⁰ or to avoid the risk of the cancellation of the gift,¹¹ or, perhaps, to escape the danger of giving, as in the case of the Durham schoolmaster noted above (see 4 (a) (6)).

6. Transition from the practice of exchanging gifts to that of barter.—(1) It has been pointed out above (see 2 (4)) that the primitive practice of making exchanges takes the form, in some cases, of giving rather than of bartering, and, in others, of bartering rather than of giving. Further, the evidence which we have already adduced shows that these exchanges take place sometimes between the members of the same clan or tribe, sometimes between the members of friendly tribes, and sometimes between strangers. Now, undoubtedly the most formidable obstacle to the extension of the practice of giving or bartering beyond the limits of the clan or tribe is the hate born of fear with which the stranger is regarded. To primitive man the little circle within which he lives forms the only possible world of social life. Beyond its limits lies an unknown country peopled by beings whom he fears and hates, and whose very existence he regards as a menace to his own. These beings have no part or place within this sphere, where alone right is recognized and enforced; and, accordingly, it is not robbery to strip them of their goods, nor is it murder to kill them. Rather it is a public duty to hunt them down and slaughter them like beasts of prey.

It is plainly impossible to lay down with any degree of precision the boundary-line where goodwill ceases and enmity begins.¹² Of the Yahgan of Cape Horn it is said that, outside of the family-group, the relation of man to man is doubtful, if not hostile:

¹ Jackson and Burne, pp. 166, 272 f.; W. Hone, *Year Book*, London, 1832, pp. 954, 1526; Napier, p. 100 f.; Henderson, p. 32; Elworthy, *Evil Eye*, London, 1895, p. 412; Hartland, ii. 266 ff.

² Jackson and Burne, p. 166.

³ E. Westermarck, *MI* i. 594.

⁴ *Wilkie MS*, ap. Henderson, p. 180 f.

⁵ B. Thorpe, *Northern Mythology . . .*, London, 1852, iii. 231; cf. ii. 130.

⁶ L. von Höhnel, *Zur Rudolph-See u. Stephanie-See*, Vienna, 1891-92, p. 272.

⁷ Grimm, pp. 183 f., 188 f.

⁸ *Ib.* p. 191 ff.; see also Meyer, p. 21.

⁹ J. Kohler, 'Die Bantus d. Elfenbeinküste,' *ZVRW* xviii. [1905] 454.

¹⁰ Heusler, *Institutionen d. deutschen Privatrechts*, Leipzig, 1885, i. 81, quoted by Meyer, p. 26.

¹¹ Vigfusson-Powell, *Origines Islandicæ*, Oxford, 1905, i. 233

¹² Hamilton-Grierson, pp. 1, 38, 40.

'The bond of a common language is no security for kindly offices. A stranger and an enemy are almost synonymous terms.'¹

On the other hand, it has been observed by Spencer and Gillen that, among the tribes with which they are acquainted,

'there is no such thing as one tribe being in a constant state of enmity with another.'² 'The members of one tribe will tell you that a distant tribe, with which they rarely or never come into contact, is very fierce and bloodthirsty and given to making raids. The same tribe will be living upon most friendly terms with its immediate neighbours, and some of the latter will be doing precisely the same thing with the tribe of which your informants are afraid and suspicious. At the same time it is quite true that, if a member of an unknown tribe made his appearance, except, of course, he came accredited as a sacred messenger, he would most probably be promptly speared. Anything strange is uncanny to the native, who has a peculiar dread of evil magic from a distance.'

In many instances the conception that the stranger is a being to be feared and hated is held most strongly by that portion of the population which is most remote from and, therefore, least familiar with him. Thus, those of the Yahgan who have never met with the Ona regard them as mortal enemies; while those of them who are their neighbours intermarry with them and fall, to some extent, at all events, under their influence.³ So, too, it is said of some of the N. Queensland natives, that they will hunt down and slay and eat the stranger who trespasses on their territory; while those of their divisions which lie nearest the border live on such amicable terms with their neighbours that the tribal boundaries are not easily determined.⁴ Thus, the range of social feelings is widely different in different cases. In some, they reach beyond the clan or even the tribe; in others, they hardly cross the threshold of the family-group (see STRANGERS).

The dread with which the stranger is regarded is largely due to the universal belief in his magical powers. The Bakairi,⁵ for example, and some of the Australian tribes⁶ regard evil and sickness and death as coming to them from those who dwell beyond their borders. In short, the stranger is looked upon as belonging to strange gods, and as bringing with him strange supernatural influences.⁷ He is possessed, and one of the duties of the medicine-chief and a main purpose of the ceremonies of hospitality are to disenchant him—or, in other words, to remove the tabu.⁸

(2) In the case of certain peoples, exchanges take place only between members of a tribe who are known to one another. Thus, while the Yahgan,⁹ like many another people,¹⁰ celebrate the occasion of a visit to their friends by an exchange of gifts, they appear to have had no such dealings with their neighbours the Ona and Alacaluf; nor had they any notion of barter with the stranger until they had learned to practise it from passing voyagers.¹¹ Among the Andaman Islanders, it frequently happens that a head chief organizes a

¹ Stirling, 'Residence in Fuegia,' *S. Amer. Miss. Mag.*, London, 1870, iv. 11.

² Spencer-Gillen^a, p. 82; ^b, p. 81.

³ Hyades-Deniker, vii. 15.

⁴ O. Lumholtz, *Among Cannibals*, p. 176.

⁵ K. von den Steinen, *Unter den Naturvölkern Zentral-Brasiliens*, pp. 344, 348.

⁶ Spencer-Gillen^b, p. 31 f.; E. M. Curr, *The Australian Race*, London, 1886, i. 50; Fison-Howitt, *Kamilaroi and Kurnai*, Melbourne, 1880, p. 259.

⁷ F. B. Jevons, *Introd. to Hist. of Rel.*, London, 1902, p. 71; A. van Gennep, *Les Rites de passage*, p. 36 ff.; J. G. Frazer, *GB*, pt. ii. 'Taboo and the Perils of the Soul,' London, 1911, p. 102.

⁸ R. I. Dodge, *Our Wild Indians*, Hartford, Conn., 1882, p. 119; see STRANGERS.

⁹ Hyades-Deniker, vii. 378.

¹⁰ O. Colden, 13 (Mohawks); J. Orantz, i. 158 (Eskimos); G. Turner, *Nineteen Years in Polynesia*, p. 329 (Samoans); Lambert, xii. 389 (New Caledonians).

¹¹ J. Weddell, *A Voyage towards the South Pole in 1822-24*, London, 1825, pp. 153, 182; see Wilkes, i. 122 ff.; P. P. King and R. Fitz-Roy, *Narr. of the Voyages of the 'Adventure' and 'Beagle'*, London, 1839, i. 444, iii. 241. It is stated that the 'canoe Indians' engaged in barter with the Patagonians (ib. ii. 172); but it is uncertain to what tribe these Indians belonged.

large gathering in order to receive the members of some distant community who have offered to give an entertainment of dance and song.

'Sundry implements or articles, which are more common in their community than in that of their hosts, are taken by the visitors on these occasions for purposes of presentation, or, to speak more correctly, of barter.'¹ Still, their mode of negotiating is that of giving.²

Nor is the interchange of presents limited to friends and acquaintances; for strangers, if introduced by mutual friends, are always welcomed.³ A very similar exchange of specialties upon the occasion of friendly visits is stated to take place among the Samoans,⁴ but it is not clear from the account whether this exchange is or is not subject to the same limitations as the practice of lending, which occurs only between members of the same tribe or clan.⁵ The Bakairi are not themselves potters, and they do not possess the stone suitable for axes. Accordingly, they procure these articles from neighbouring tribes.⁶ Each tribe has its specialty, and these specialties pass from tribe to tribe; still, the form of exchange is that of gift followed by counter-gift. On his arrival the stranger presents to his host some article peculiar to his tribe or locality; and the latter, either on receiving him, or, more generally, on parting, gives him something in return.⁷ But, until our informant's visit to them, the Bakairi knew nothing of exchanging specific object for specific object. The guest expected to receive something, but it remained with the host to determine what he should receive.⁸ Again, it is said of the Indians of Guiana that each tribe has some special manufacture; and that its members constantly visit other tribes, hostile though they be, for the purpose of exchanging the products of their labour for articles which they themselves do not produce. These trading Indians are allowed to pass through an enemy's country without let or hindrance,⁹ traders being treated, for the time being, as fellow-tribesmen.¹⁰ New Zealand affords another instance of the circulation of property by exchange of specialties. The inhabitants on the upper Wanganui send preserved parrots and other birds which are considered a delicacy 'as presents to other parts of the country where they are scarce; and, in due time, a return present of dried fish, or something else not to be obtained easily in the inland country, is received.'¹¹ Of the Bushmen we are told that 'they had no contact with people beyond their own little communities, except in war, for they were without a conception of commerce';¹² while R. Moffat¹³ informs us that they supplied Hottentots, Corannas, and Namaquas with quivers, bows, and poisoned arrows. S. Passarge,¹⁴ relying on the information of a Bushman attendant, speaks of the commercial relations of the latter's countrymen with Bantu tribes, and adds that large prices were obtained for certain commodities; but as to the *modus* of these transactions he leaves us in ignorance.

The most remarkable example of this primitive traffic is afforded by the aborigines of Australia. In their case it seems to reach its highest point of organization among those tribes of Queensland of which W. E. Roth supplies an admirable account. He tells us that

'certain trade-routes laid down from time immemorial along their own or messmates' country are followed by the members of a tribe or tribes, along which each knows that he is free to

¹ Man, p. 169. ² *Ib.* p. 120. ³ *Ib.* p. 80.

⁴ Wilkes, ii. 143 f. ⁵ G. Turner, 264.

⁶ K. von den Steinen, pp. 93, 203, 215. ⁷ *Ib.* p. 333.

⁸ *Ib.* p. 333 f.

⁹ E. F. im Thurn, *Among the Indians of Guiana*, London, 1883, p. 271.

¹⁰ *Ib.* p. 214. ¹¹ E. Shortland, p. 198.

¹² G. McCall Theal, *The Beginning of S. Afr. History*, London, 1902, p. 17; cf. p. 13.

¹³ *Miss. Labours and Scenes in S. Africa*, London, 1842, p. 6.

¹⁴ *Die Buschmänner der Kalahari*, Berlin, 1907, p. 118.

travel unmolested; these routes, of greater or less extent, are rigidly adhered to. The opening of the local market, so to speak, may take place at the instance of one of the elders or "bosses" at one of the larger camps . . . where instructions are issued as to when to leave, to whom to go, what to take, and what to return with.¹

Roth gives a list of trade routes and of the articles bartered at the various 'swapping stations,' and observes that this intercourse is productive of an exchange not only of material things but of ideas.² In the case of the tribes of S. E. Australia, commerce is less systematic in form. Trade-centres exist among them, but barter takes place only on certain solemn occasions, such as the settling of a blood-feud, the celebration of an initiation ceremony, or the occurrence of a great tribal gathering;³ and it is worthy of note that the very tribes which frequent those resorts make annual expeditions to obtain pitcheri and red ochre, during which they must be prepared to fight every inch of the way. But, besides this trading at recognized places, articles pass from one tribe to another by way of barter. Thus, the Yantruwunta obtained wooden shields 'from their neighbours higher up Cooper's Creek, who got them from tribes farther to the north-east';⁴ and, in the case of the central Australians, fighting clubs made by the Kaitish and Warramunga are 'traded down to the Macdonnell Ranges and right away to the south of the Arunta and Luritcha.'⁵ In this way ornaments,⁶ shields,⁷ spears,⁸ pieces of greenstone (diorite),⁹ stone for axes and hatchets,¹⁰ articles of food,¹¹ red ochre, sandstone, slabs for grinding grass and other seeds,¹² and skins¹³ pass from tribe to tribe by way of barter—those tribes being, in many instances, widely separated from one another.¹⁴

There are two Australian usages with regard to trade which deserve special mention. Of these the first, called *yutchin*, prevails among the Dieri. 'When a black-fellow is going a distance from home, either to another of the Dieri hordes, or its lesser divisions, or to a neighbouring tribe, some one at his camp becomes his *yutchin*. . . . It is then his duty to bring back with him articles for his *yutchin*, who while he is away also collects presents for him. Under no circumstances is such a pledge broken.'¹⁵ The second usage is practised by the Narrinyeri. When a tribesman has a child born to him, he preserves its umbilical cord, and gives it to a man of another tribe, who has children. In this way these children become *ngia-ngiampe* to the child first mentioned. He and they may not touch, or approach, or address one another; and, when they have arrived at adult age, they become the agents through whom their respective tribes carry on barter. Their estrangement is said to answer two purposes. 'It gives security to the tribes that there will be no collusion between their agents for their private advantage, and also compels the two always to conduct the business through third parties.'¹⁶ It is a matter of indifference whether the children do or do not belong to the same clan.¹⁷

(3) These instances from Australia establish the fact that the tribes of which Roth speaks possess a far more highly organized system of commerce than is to be found among the natives of the centre. They show us, further, that the S. E. aborigines engage in barter with strangers as well as friends at certain established trading-centres on certain recognized occasions; and they supply ample evidence of the passage of commodities from tribe to tribe, sometimes directly and sometimes through the medium of friendly tribes or of a

¹ *Ethnol. Studies among the North-West-Central Queensland Aborigines*, Brisbane, 1897, p. 132.

² *Ib.* p. 134 ff.

³ Howitt, p. 714 ff.

⁴ *Ib.* p. 714.

⁵ Spencer-Gillena, p. 602 f.

⁶ *Ib.* p. 573.

⁷ Howitt, p. 714.

⁸ Spencer-Gillena, pp. 670, 675; R. Brough Smyth, *The Aborigines of Victoria*, London, 1878, i. 181, ii. 298.

⁹ Brough Smyth, *loc. cit.*

¹⁰ *Ib.* p. 181, note; Spencer-Gillena, p. 588.

¹¹ Brough Smyth, i. 181; Howitt, p. 718.

¹² Brough Smyth, ii. 305.

¹³ Howitt, p. 714.

¹⁴ See Spencer-Gillena, pp. 575, 602, 611. An interesting account of a similar system as practised on the Congo will be found in A. Thonnar's *Essai sur le système économique des primitifs*, Brussels, 1901, pp. 90, 93 f.

¹⁵ Howitt, p. 713.

¹⁶ Taplin, in J. D. Woods, *Nat. Tribes of S. Aust.*, Adelaide, 1879, p. 82 ff.; Brough Smyth, i. 181; Curr, ii. 254.

¹⁷ Curr, *loc. cit.*

special class of persons. At the same time, it is obvious that, except perhaps in the case of the tribes first mentioned, such trafficking is exceptional. Yet the mere fact that it exists indicates that the parties to it have made a considerable advance along the path of commercial progress. The privileges accorded to the trader among the natives of Guiana point in the same direction.

The practice of exchanging guest-gifts has a wider range among the Bakaïri than among the Andaman Islanders. Among the former, it may take place between strangers; among the latter, it takes place only between friends, or between a host and an accredited stranger. Accordingly, it is plain that in each of the three last instances we meet with a personal exception to the general rule of treating the stranger as an enemy—an exception, that is to say, in favour of the stranger-trader and the stranger-guest.

(4) Now, a large body of evidence attests the prevalence, both in the past and in the present, in almost every quarter of the globe, of a mode of trading which throws, it is thought, no little light upon the origin of this exception. This so-called 'silent trade' is, in its simplest form, a transaction by way of exchange between persons who are unseen by one another; and examples of it are supplied by European and Asiatic Russia, by many parts of Africa, by Sumatra, Borneo, and the Moluccas, and by North, Central, and South America.¹ Here we propose to consider only those instances which occur amongst peoples regarding whose life and surroundings we have adequate if not full information.

It has been said that this form does not represent the first beginnings of intercourse with the stranger—that it is, rather, a device adopted by traders of a higher civilization in order to overcome the suspicions and fears of those belonging to a lower civilization and to induce them to trade. It is undoubted that to many primitive peoples the practice of making exchanges with persons outside of their own clan or tribe was unknown until it was introduced among them or forced upon them by strangers of a culture superior to their own. Thus, while there is no evidence of exchange between the extinct Tasmanians or Botocudos or Seris with the tribes in their neighbourhood, it is reported of the two former that they engaged in it with the Europeans with whom they were brought into touch,² and of the last named that they learned to practise it from the whites of Sonora, with whose missions and military expeditions they came frequently into contact.³ It would be unjustifiable, however, in view of the evidence, to attribute the origin of this curious form to the ingenuity of civilized traders; for, while it is true that not infrequently such traders employ this method in dealing with rude peoples, it is no less true that in many cases it is practised by such peoples in opening a trade with those outside their borders.⁴

(5) The Veddias of Ceylon, the Sakais (Senoi) of Malacca, the Toálas of Celebes, and the Kubus of Sumatra are regarded by the latest authorities as related races, on the ground of the similarity not only of their somatological characteristics, but of their habits and modes of life;⁵ and, consequently,

¹ See Hamilton-Grierson, pp. 41-47.

² H. Ling Roth, *The Aborigines of Tasmania*, Halifax, 1899, pp. 27, 41, 46; Maximilian Prinz zu Wied-Neuwied, *Reise nach Brasilien*, Frankfurt, 1821, i. 334, 339, 363.

³ W. J. McGee, 'The Seri Indians,' 17 *RBEW* [1899], pt. 1, pp. 114, 152*, 224*, 227*.

⁴ See Hamilton-Grierson, p. 62 ff.

⁵ F. Sarasin, 'Types humains intérieurs du Sud-est de l'Asie,' *Revue Générale des Sciences*, xix. [Paris, 1908] 303 ff.; B. Hagen, *Die Orang Kubu auf Sumatra*, Frankfurt, 1908, p. 162 ff. See also W. Schmidt, *Die Stellung der Pygmäenvölker in der Entwicklungsgesch. des Menschen*, Stuttgart, 1910, pp. 7, 12 ff., 25 ff., and *passim*.

it is of especial interest to us to find that all these peoples practise this method of exchange in its simplest form. Fa Hian is apparently speaking of the Veddas, when he says of Ceylon that

'it was originally uninhabited by men. Only demons, genii, and dragons dwelt there. Nevertheless merchants of other countries trafficked with them. When the season for traffic came, the genii and demons appeared not, but set forward their precious commodities marked with the exact price. If these suited the merchants they paid the price and took the goods.'¹

Many instances might be collected in which the merchant is said to have been uncertain whether he was trading with men or demons.² According to al-Biruni,³ the coast-people of Lañkā (Ceylon) traded cloves in accordance with this method. It is possible, however, that his account applies not to Ceylon, but to those islands in the Indian Ocean where, according to Qazwini,⁴ a clove-trade was conducted in this manner. The method is still practised by the Veddas of Nilgala.⁵ Accordingly, the statement of Bailey⁶ to the contrary appears to be erroneous.⁷

Robert Knox's account⁸—which is corroborated by many other reports to the same effect— informs us that, when the Veddas want arrows, they

'will carry their load of Flesh in the night, and hang it up in a Smith's, also a leaf cut in the form they will have their arrows made, and hang by it. Which if the Smith do make according to their pattern they will require, they bring him more Flesh; but if he makes them not they will do him a mischief one time or another by shooting in the night. If the Smith makes the arrows he leaves them in the same place as the Veddas hung the Flesh.'

It may be noted that in the case of the Smoos and Twakas, who employ a similar method of trading, each article has affixed to it a sample of what is wanted in return;⁹ and a similar indication is given by the natives of the Rio del Norte in bartering with the whites.¹⁰

The wild Sakais of Perak, in trafficking with the Malays, either employ a 'tame' Sakai as an intermediary, or deposit their wares, which consist of jungle produce, on the banks of rivers, at certain times and places known to the trader. They then withdraw, and return after an interval to fetch the articles offered in exchange.¹¹ Hugh Clifford¹² speaks of the 'tame' Sakai only as exchanging with the Malays, who deposit the articles of barter at certain spots in the forest, whence the Sakais remove them, replacing them with their wares. The Toālas of Celebes formerly practised this mode of trading, laying down what they had collected at some place of resort, whence any one could take it on leaving something in exchange.¹³ Winter tells us that the Orang Kubu of Sumatra deposit such articles as rattan, beeswax, resin, and ivory at a spot on a river-bank where they may catch the eye of the Malay trader, and then retire. They return from time to time; and, if they find that something which suits their taste has been laid down beside their offer, they take it away with them, leaving their barter for the trader to carry on board his proa.¹⁴

¹ *Pilgrimage of Fa Hian*, from the French ed. of the *Foe Koue Ki* of Rémusat, Klaproth, and Landresse, Calcutta, 1848, p. 832.

² See Ibn Batūta, *Voyages*, ed. Defrémery-Sanguinetti, Paris, 1853-59, i. 401; G. F. Lyon, *Narr. of Travels in N. Africa in the Years 1818-20*, London, 1821, p. 149; Hamilton-Grierson, p. 82 and note 9, and p. 83.

³ E. O. Sachau, *Alberuni's India, an Account of the Religion . . . of India about A.D. 1030*, London, 1910, i. 809.

⁴ Ap. J. Gildemeister, *Scriptor. Arab. de rebus Indicis loci et opuscula*, Bonn, 1838, i. 202.

⁵ O. S. V. Stevens, 'Amongst the Veddas,' *RAS*, Ceylon Branch, Proceedings, 1886, Colombo, 1888, p. 108; see also P. and F. Sarasin, *Ergebnisse naturwissenschaftl. Forschungen auf Ceylon in d. Jahren 1884-86*, Wiesbaden, 1887-93, iii. 557.

⁶ 'Wild Tribes of the Veddas of Ceylon,' *TES Lond.*, new ser., London, 1862, ii. 285.

⁷ See, however, C. G. and B. Z. Seligmann, *The Veddas*, Cambridge, 1911, p. 93; cf. p. 15, note.

⁸ *Histor. Relation of the Island of Ceylon*, London, 1681, p. 62.

⁹ O. N. Bell, *Tangweera*, London, 1899, p. 267.

¹⁰ A. von Humboldt, *Essai politique sur le royaume de la Nouvelle Espagne*, Paris, 1808, i. 304.

¹¹ Skeat-Blagden, *Pagan Races of the Malay Peninsula*, London, 1906, i. 229.

¹² *In Court and Kampong*, London, 1897, p. 102 f.

¹³ P. and F. Sarasin, *Reisen in Celebes . . . in d. Jahren 1893-98 und 1902-03*, Wiesbaden, 1905, ii. 276.

¹⁴ Quoted by Hagen, p. 118.

Hagen quotes de Sturla, Olivier, and H. O. Forbes to much the same effect. According to Olivier and Forbes, however, it is the Malay who opens the trade. Forbes¹ says that the Malay trader 'beats a gong in a particular manner so as to give notice of his arrival.' In Winter's time a person in need of assistance could summon the Kubus by striking a hollow tree so as to produce a certain series of sounds recognized as a call for aid. Whenever the Orang Ot of Borneo wish to gather the members of the tribe together, they beat upon a tree-trunk, and the Malays who trade with them use the same means to collect their clients;² and a very similar use is, or was, made of a gong or copper vessel in Bura.³ Bakuwi⁴ says that those who traded by this method with the people of Tibri—a country of the Sudan, distant about three months' journey from Segelmesa—announced their approach by sound of drum.⁵

The Ukits, the Punans, the Buketans, and the Ot Damung of Borneo are said to employ a similar method;⁶ but a recent account of the Punans from Malay sources shows that, when bartering, they no longer keep out of sight of the trader.⁷ According to Chinese writers, it was at one time in use up country from Banjarmasin.⁸

(6) A racial connexion, similar to that which is said to subsist between the Veddas and certain other peoples, is held by Schmidt⁹ to be established between the pygmies of Central Africa, the Bushmen, the Andamanese, the Semangs, and the Negritos of the Philippines. We have already referred to the modes of exchange practised by the Bushmen and the Andamanese (see 2 (1) and 6 (2) above). The Semangs are neighbours of the Sakais, and, although of a wholly different stock, exhibit a manner of life and a method of trading practically identical with theirs.¹⁰

The accounts of the pygmy peoples of Central Africa disclose an interesting variety of trading customs. The Akkas are grouped in small communities, and wander over the countries of certain of the Monbuttu tribes. They are hunters, and do not cultivate the soil; but they have a remarkable fondness for vegetable food, and not infrequently raid the fruit-trees of their neighbours.¹¹ 'After a successful hunt, when they possess abundance of food, they invade the banana groves, and for every bunch of fruit gathered they substitute a piece of meat.'¹² A very similar description is given of the Obongo of the Ogowe Basin,¹³ who are also said to employ the method of the 'silent trade.'¹⁴ The Batua are simple hunters, and know nothing of agriculture. They wander over the country of the Bakuba, Baluba, Bakaté, and other tribes, but are met with only on certain days at market-places situated within the virgin forest, and, in general, equidistant from the neighbouring villages. These spots are regarded as neutral ground, and are frequented by the pygmies in order

¹ *A Naturalist's Wanderings*, p. 235.

² O. A. L. Schwaner, i. 280 f.

³ Riedel, p. 15.

⁴ French tr. de Guignes, *Notices et Extraits de la Bibliothèque du Roi*, Acad. des Inscr., Paris, 1789, ii. 394.

⁵ As to the primitive methods of communication, by means of smoke-signals, fire-beacons, sound of drum, etc., see Hamilton-Grierson, p. 23, note 2, and p. 68, note 2; see also H. Wissmann, L. Wolf, O. de François, H. Müller, *Im Innern Afrikas*, Leipzig, 1888, p. 328.

⁶ Schwaner, i. 281; O. Beccari, *Wanderings in the Great Forests of Borneo*, London, 1904, p. 265; P. Cunyngname, 'Sarawak,' in *Scottish Geog. Mag.* xxviii. (1912) 368; A. Bastian, *Indonesien, oder die Inseln d. malayischen Archipel*, iv. 'Borneo und Celebes,' Berlin, 1889, p. 26.

⁷ M. W. H. Beech, in *Man*, xi. (1911) 17.

⁸ W. P. Groeneveldt, 'Notes on the Malay Archipelago and Malacca,' in *Miscell. Papers relating to Indo-China and the Indian Archipelago*, 2nd ser., London, 1887, i. 228.

⁹ P. 24 f.; see also F. Sarasin, p. 303 ff.

¹⁰ Skeat-Blagden, i. 227.

¹¹ G. Schweinfurth, *The Heart of Africa*, tr. E. E. Frewer, London, 1873, ii. 145; W. Junker, *Travels in Africa during the Years 1882-86*, tr. A. H. Keane, London, 1892, p. 85 f.; G. Casati, *Ten Years in Equatoria*, London and New York, 1891, i. 157 ff.

¹² Casati, 158; cf. G. Burrows, *The Land of the Pygmies*, London, 1898, p. 188.

¹³ P. B. du Chaillu, pp. 270, 315 ff.; O. Lenz, *Skizzen aus Westafrika*, Berlin, 1878, p. 110 ff.; *The Strange Adventures of Andrew Battell*, ed. E. G. Ravenstein, London, 1901 (Hakluyt Society), p. 52, note 1.

¹⁴ A. Bastian, *Die deutsche Exped. an d. Loango-Küste*, Jena, 1874, i. 140.

to exchange fresh or dried flesh for maize. As to the manner of the exchange, we have, unfortunately, no precise information.¹

The accounts of the trading methods of the Negritos of the Philippines are somewhat wanting in precision. We are told of the Aetas that they deal only with the Malay tribes which are their neighbours, in order to procure, for their honey and beeswax, such articles as arrow-heads, knife-blades, cloth, etc., which they cannot provide for themselves. It is said that they always, as far as possible, employ the same persons to conduct this traffic.² Further, it is stated by a recent American authority³ that

'in many places in the Archipelago to-day, especially in Mindanao, periodic commerce is carried on regularly on neutral territory. Market-places are selected where products are put down by one party, which then retires temporarily, and are taken up by the other party, which comes and leaves its own productions in exchange.'

Blumentritt's informants spoke of the Mamanuas of Mindanao as exchanging, but said nothing of the method of the exchange.⁴ The 'silent trade' is employed by the wild Apoyaos of Luzon in bartering their tobacco with the Christian natives.⁵

(7) Winter's description of the Kubus' mode of exchange is remarkably similar to Bell's account of that employed by the Smoos and Twakas of the Mosquito country.

'So much confidence have they in the honesty of transactions that I have frequently seen at the mouths of rivers a peeled and painted stick planted in a conspicuous position, and on landing have found hanging to the trees bunches of plantains, baskets of maize, rolls of *toonoo* cloth, skins, etc., and attached to each article a sample of what was wanted in return, such as a fish-hook to one, a few beads to another, a pinch of salt to the next, and so on. These were placed there in the expectation that the coast Indians passing by on the main river would make the required barter. After a while, if they were found to remain untouched, the river Indians bring the articles to the coast villages.'⁶ The last sentence seems to show that the practice was declining.

(8) This method of trade is found among the Gorgai and Tungu, the original inhabitants of Kola and Kobroor, islands of the Arru Archipelago, and was formerly in use in Buru and Ceram.⁷ From Japanese writers dating from the first half of the 18th cent. we learn that the practice was employed by the Ainus of Yezo in trafficking with the inhabitants of Ki-itat-soub, one of the Kurile Islands;⁸ and by the Ainus of Saghalien in trading with the people of the Anur country.⁹ According to Paulus Jovius,¹⁰ the Lapps made exchanges,

'yet so that they flye the syght and coompagnie of all merchantes. For comparyng and laying they wares together and leavyng theyr fures in a mydde place, they bargayne with simple fayth with absent and unknowen men.'

(9) Similar accounts are given of peoples regarding whom we have little information. Thus, we hear of the practice at Mozambique,¹¹ and, if we credit a native story, at Amboyna.¹² It was employed by the Paloungs in exchanging their tea with

¹ H. Wissmann, L. Wolf, C. de François, H. Müller, p. 256 ff.; see also C. S. L. Bateman, *The First Ascent of the Kasai*, London, 1889, p. 23 ff.; H. von Wissmann, *My Second Journey through Equatorial Africa*, p. 166 ff.

² A. Schadenberg, 'Ueber die Negritos d. Philippinen,' *ZE* xii. [1880] 135.

³ A. E. Jenks, *The Bontoc Igorot*, Manila, 1905, p. 159.

⁴ 'Ueber die Negritos von Mindanao oder die Mamanuas,' *AE* ix. [Leyden, 1896] 251.

⁵ A. Schadenberg, *ZE* xxi. [1889] 675.

⁶ Bell, p. 267; see also Bell, 'Remarks on the Mosquito Territory,' *JRGS* xxxii. [1862] 258 ff., where a short account of these tribes is given.

⁷ Riedel, pp. 15, 128, 271.

⁸ Rinsifée, *Aperçu général des trois royaumes*, tr. J. Klaproth, Paris, 1833, p. 194 f.

⁹ Von Siebold, ii. 193.

¹⁰ Richard Eden's tr. in *Notes upon Russia: being a Translation of the earliest Account of that Country* . . . , London, 1851-52 (Hakluyt Society), ii. 40; see also John Scheffer, p. 67 f.

¹¹ Caesar Frederick's *Voyage*, in R. Hakluyt, *The Principal Navigations . . . of the English Nation* 2, London, 1598-1600, ii. i. 242; cf. M. Thomans, *Reise- und Lebensbeschreibung*, Augsburg, 1788, p. 119.

¹² P. Valentyn, *Oud en Nieuw Oost-Indien*, Dordrecht and Amsterdam, 1724, pt. ii. ('Ambonische Zaaken'), p. 2.

the Burmans;¹ and the legends of the invisible smith in Berkshire, and in 'the Æolian Isles of Lipari,'² find an echo in Denmark,³ in Westphalia,⁴ and other parts of Germany,⁵ and on the West Coast of Africa.⁶

(10) We are told of the natives of Cumberland's Island, by the writer of Martin Frobisher's second voyage to the north, that

'their manner of traffique is thus: they doe use to lay downe of their merchandise upon the ground so much as they meane to part withal, and so looking that the other partie with whom they make trade should doe the like, they doe themselves depart, and then if they doe like of their Mart they come againe and take in exchange the others merchandise, otherwise if they like not, they take their owne and depart.'⁷

It is not quite clear whether those who carried on this trade were mutually unseen, or whether this instance is an example of another form of the practice, in which the parties are seen by one another, but keep at a safe distance.⁸ Of the latter form many examples might be cited.⁹ In some of these a considerable interval separates those engaged in the traffic, while, in others, a mere line drawn on the sand is the only division between them.

(11) A very instructive instance of another form of the practice is supplied by Lander.¹⁰ His object was to obtain yams, and some of the natives with him proceeded well-armed to a town near the river, and returned followed by many armed people carrying bundles of yams. They were accompanied by an old woman, who seemed to be a person of authority. On arriving at the river, she directed the yams to be placed in distinct and separate bundles before Lander's natives, and ordered the owner to retire to a short distance. The purchaser then inspected the bundles, and, having selected one to his own satisfaction, placed beside it what he considered to be its value in cloth, flints, etc. The old woman looked on while this was being done, and, if she thought that what was given was sufficient, she took up the cloth and gave it to the owner of the bundles, the purchaser taking away the yams. If, on the contrary, she thought that the purchaser's offer was insufficient, she allowed it to remain a short time, so as to give him an opportunity of adding something to it. If he did not add anything, she directed the owner of the yams to move them out of the way, and left the purchaser to remove his cloth. 'All this was carried on without a word passing between the parties.'

With Lander's account may be compared what is said of the Aleuts:

They never transact business with each other personally, but always through a third person. Whoever wishes to sell anything, sends it into another house by this agent, who, without mentioning the owner's name, says, 'Here is the *tayák*' (saleable object). The buyer asks what is wanted in return, and sends as much as he thinks fit of what is required. The agent takes this to the seller, and, if he is satisfied, the bargain is concluded. If he is not satisfied, he asks for something in addition, or proposes a new exchange.¹¹

This method of bargaining is remarkably similar

¹ A. Bastian, *Die Völker d. Ostl.-Asien*, Leipzig, 1866-71, ii. 169.

² See Hamilton-Grierson, p. 41.

³ J. M. Thiele, *Danmarks Folkesagn*, Copenhagen, 1843, ii. 181, cited by W. A. Craigie, *Scandinavian Folk Lore*, Paisley and London, 1896, pp. 407 ff., 450 and note.

⁴ A. Kuhn, *Sagen, Gebräuche, u. Märchen aus Westfalen*, Leipzig, 1859, i. 41; see also B. Thorpe, *Northern Mythology*, iii. 123 ff.

⁵ Thorpe, iii. 33.

⁶ P. B. du Chaillu, p. 106 f.

⁷ Hakluyt, iii. 63.

⁸ See Hakluyt, iii. 86; and cf. O. von Kotzebue, *A Voyage of Discovery into the S. Sea and Beering's Straits, 1815-1818*, London, 1821, i. 228 ff., as to the dealings of the Chukchis with the Eskimos near Kotzebue Sound.

⁹ See Hamilton-Grierson, p. 47 ff.; also *Early Voyages to Terra Australis, now called Australia*, ed. R. H. Major, London, 1859 (Hakluyt Society), p. 96; extract from Witssen's *Noord- en Oost Tartarye*, Amsterdam, 1705, regarding New Guinea; S. Müller, *Reizen en Onderzoekingen in den Indischen Archipel*, Amsterdam, 1857, i. 202; and Wallis, *Voyage*, in J. Hawkesworth, *An Account of Voyages in the Southern Hemisphere*, London, 1773, i. 451 f. (Tahiti).

¹⁰ *Journ. of an Exped. to Explore the Course and Termination of the Niger*, London, 1832, iii. 161 ff.

¹¹ Dall, p. 394.

to that employed by the Eskimos of Bering Strait at the 'Asking festival,' of which Nelson¹ gives an account.

(12) M. H. Kingsley² supplies us with an example of yet another form of this practice, in which a divinity safeguards the rights of the traders. She tells us that, when walking along a bush path, far from human habitation,

'you' will 'notice a little cleared space by the side of the path; it is neatly laid with plantain leaves, and on it are various little articles for sale,—leaf tobacco, a few yams, and so on,—and beside each article are so many stones, beans, or cowries, which indicate the price of each article; and you will see either sitting in the middle of things, or swinging by a piece of tie-tie from a branch above, Egba, or a relation of his,—the market god,—who will visit with death any theft from that shop, or any cheating in price given, or any taking away of sums left by previous customers.'³

It has been contended by a recent writer, F. Somlo,⁴ that this mode of exchange is not, in any of its forms, a primitive mode, because it is not practised by primitive peoples. In his list of such peoples he includes the aborigines of Australia, the extinct Tasmanians, the Botocudos, the Fuegians, the Andaman Islanders, the Negritos of the Philippines, the Bushmen, the Seris, and the Veddas. He does not notice some eight or nine peoples whom the best authorities regard as primitive, and who practise the method in question. He admits that the Veddas employ this mode of trading, and offers the explanation, without, however, adducing any evidence in support of it, that they borrowed the practice from their neighbours.⁵ In dealing with the Negritos of the Philippines, he says not a word of the practice of this method at Mindanao and elsewhere; and, while he names the Kubus, he excludes them from his list, without stating his reasons for so doing. Further, he refuses a place in it to the Ainus of Yezo and the Akkas of Equatorial Africa, on the ground that they are agriculturists or are influenced by agricultural tribes; and he would probably have treated in similar fashion, had he dealt with them, the Toálas, the Semangs, and the Sakais. It is quite true that the Ainu women cultivate small garden plots; but, as a people, the Ainu know nothing of agriculture.⁶ The Akkas, although they are hunters καὶ ἑφογγ, have an especial fondness for vegetable food, and frequently raid the fruit-trees of the tribes over whose lands they wander.⁷ The Toálas of Celebes are now cultivators of the soil; but the remains found in the caverns which they inhabited until recently show that formerly they were hunters pure and simple.⁸ But few of the Semangs till the soil,⁹ while the tillage of the Sakais is of the rudest.¹⁰ We have already noted that the Paloungs and the Apoyas grow respectively tea and tobacco (see 6 (8) and (9)). As to primitive methods of agriculture, see K. Bücher, *Die Entstehung d. Volkswirtschaft*,⁴ Tübingen, 1904, p. 54 ff. It has been pointed out again and again that the fact that a people has made an advance in one direction does not necessarily exclude it from the class of primitive peoples.¹¹ Thus, for example, the aborigines of Australia are universally and rightly regarded as being within that class, although among many tribes commercial relations have been reduced to an organized system (see 6 (2) and (3)).

It seems plain, then, that the method of exchange under consideration is or has been known to and practised by many primitive peoples; and, accordingly, we are freed from the necessity of discussing the question whether a usage is to be regarded as primitive only on proof that primitive peoples practise it.¹²

(13) It is obvious that considerable light is thrown upon these curious forms of trading by the evidence which we have adduced as to primitive conceptions regarding the nature, incidents, and effects of exchange (see 4 (a)). The problem which confronted the savage was this, How was he to obtain from those who were the objects of his suspicion and fear, if not of his open enmity, certain articles which they possessed and he coveted? He was

¹ 'The Eskimo about Bering Strait,' 18 RBEW, Washington, 1899, pt. 1, p. 369 ff. Other instances of the conduct of trade through the medium of middlemen will be found in Hamilton-Grierson, p. 50 f.

² 'Afr. Rel. and Law,' *Nat. Review*, xxx. (1897) 134; cf. R. E. Dennett, *At the Back of the Black Man's Mind*, London, 1906, p. 193.

³ See Hamilton-Grierson, p. 53 f.

⁴ *Der Güterverkehr in der Urgesellschaft*, Brussels and Leipzig, 1909, p. 160 f.

⁵ *Ib.* pp. 12, 134.

⁶ J. Batchelor, *The Ainu of Japan*, London, 1892, pp. 39, 40, 256, 287; R. Hitchcock, 'The Ainu of Yezo, Japan,' *Report of Nat. Mus.* 1890, Washington, 1891, p. 458.

⁷ Schweinfurth, ii. 145; Junker, p. 85 f.; Casati, i. 157 ff.

⁸ F. Sarasin, p. 307. ⁹ Skeat-Blagden, i. 53. ¹⁰ *Ib.* i. 65.

¹¹ See J. Kohler, 'Zur Rechtsphilos. u. vergleichende Rechtswissenschaft,' *Jurist. Literaturblatt*, vii. 197, and 'Zur Urgesch. d. Ehe,' *ZVRW* xii. 190 ff.

¹² See E. B. Tylor, *Prim. Cult.*, London, 1903, i. 16; J. G. Frazer, *Totemism and Exogamy*, do. 1910, iv. 156.

familiar with exchange as practised within his own group, and he believed that the parties to it were brought into a relation of such a sort as to secure their good faith. Here, then, was a method to his hand. He would exchange with the stranger, and by keeping out of sight—by neither seeing nor being seen by him—would limit his contact with him to that effected by the exchange itself. The stranger would not dare to take his goods without making a return; and the good faith of both parties would be guaranteed by the nature of the relation which united them for the time. Thus, the method, in its simplest form, is an application of the principles which operate in exchange, as adapted to the special circumstances of the case. Among the Aleuts, the contact of the parties is limited to that implied in the act of exchanging; but, in other instances, the case is different. Sometimes the parties come into view of one another; sometimes they even approach one another; sometimes they transact wholly through intermediaries; and sometimes they take the additional precaution of keeping silence so long as the traffic lasts. Lastly, there are instances in which honest dealing and peaceable conduct are assured by fear, not of the mysterious retribution which follows upon a breach of tabu, but of the punishment inflicted on the cheat and the truce-breaker by the god of the market. It will be seen from the facts which have been adduced that the mutual avoidance of the parties, accompanying, as it does, the mysterious union which exchange creates, serves more than one purpose. It begins, so to speak, by being a safeguard, and it becomes a rite, without, however, in many cases at least, losing its primary character. It seems not improbable, notwithstanding Somló's observations¹ to the contrary, that the method of trading by means of tabued persons in use among the Narrinyeri (see 6 (2)) is to be regarded as a survival of practices formerly prevalent among the natives of Australia before they had reached the stage of commercial development which they now occupy; and a like explanation may hold good in the instance supplied by Melville² of trading through the medium of a 'tabooed Kannaka,' and in the case of the Aleuts and the Eskimos of Bering Strait already referred to (see 6 (11)).

In only one account of this method of trade, and that a very vague one, is it expressly stated that the place of its occurrence is regarded as neutral ground.³ This matter will be dealt with in art. MARKET.

LITERATURE.—This is indicated in the footnotes.

P. J. HAMILTON-GRIERSON.

GIFTS (Greek and Roman).—1. There was an old Greek proverb that gifts persuade the gods and the majesty of kings (*Plat. Rep.* 390 E). Besides testifying to the universal efficacy of gifts, it serves to mark a natural division of the subject-matter. Gifts made to the gods will form no part of the present article; for information concerning them the reader is referred to SACRIFICE. But, even if these are excluded, the giving of presents on particular occasions was often dictated by superstitious fears, as in the case of birthday-gifts, which have survived from an immemorial antiquity to the present day, because that which was formerly accounted to possess a magic virtue has endured as a symbol of affection or a graceful act of courtesy (cf. BIRTH-DAYS). It is true that valuable gifts could never be out of season, when an enemy was to be won over or a friend had been estranged. Nevertheless, in heroic times the customs regulating the giving of presents had a

¹ P. 161 f.

² *Narr. of a Four Months' Residence among the Natives of a Valley of the Marquesas Islands*, London, 1846, p. 81.

³ Jenks, 159; see 3 (1).

serious importance, which the growth of civilization subsequently effaced (Monro on Hom. *Od.* xviii. 282). This may be illustrated by the survival of ceremonious gifts in the East, as well as by the dealings of travellers or political agents with the chieftains of savage tribes (see preceding art.). The gift was not merely treasured as a compliment, but coveted for its intrinsic value.

In *Od.* xiv. 323 ff. the Thesprotian king is represented as showing to another the parting gifts which Odysseus had collected on his travels—bronze, gold, and iron enough to support one owner after another to the tenth generation. In *Od.* xv. 82 ff., Menelaus offers to accompany Telemachus on a journey through the Peloponnese, and assures him that from every homestead he may visit he will take away something valuable—a brazen tripod or a bowl, a pair of mules, or a golden cup. In *Od.* xviii. 282 the disguised Odysseus rejoices at the cunning shown by Penelope in procuring gifts from the suitors without any intention of choosing one of them as her husband. The most instructive case in Homer is that of the embassy to Achilles in *Il.* ix. The refusal of Achilles to accept the handsome recompense offered by Agamemnon is clearly contrary to public opinion, as expressed by Phœnix (496 ff.) and by Ajax (628 ff.). Even the gods are open to persuasion, if the sacrifices and vows made to them are adequate to the occasion; for Achilles to reject the gifts of Agamemnon is to repudiate the god-like honours which the Achæans are anxious to bestow upon him. Even when a relative has been slain, if the blood-price is offered, no one persists in his resentment; but Achilles is stubborn and relentless after an inconsiderable affront.

2. In primitive times hospitality to the stranger is a binding obligation, enforced by the belief that his person is under the special protection of the gods, and that neglect to provide for his wants will be visited with divine displeasure. All strangers and beggars are favoured by Zeus; a gift, though small, is welcome, says Nausicaa to Odysseus (*Od.* vi. 207). It thus became a duty (*θέμις*) for the host to provide food and lodging suitably to his means for any stranger who arrived at his homestead; and such gifts were known as the guest-portion (*ξείνια, ξένια*)—an offering which no prudent man would refuse (see *Il.* xi. 778, xviii. 387).

It is possible that the motive which originally inspired these acts of hospitality was not so much piety as fear. Plenty of evidence has been collected by anthropologists to show that strangers (*g.v.*) were regarded by uncivilized men as a source of danger, and that special precautions must be taken to guard against their influence. Hence the reception of the stranger with particular marks of honour may have been in its inception intended to exorcize the evil spirits surrounding him, or to counteract his magical powers. Instances of this kind from the practices of savage tribes are quoted by J. G. Frazer, *GB*² i. 303; but the earliest civilization known to us in Greek literature has reached a much higher stage of development, and what was originally a mere act of superstition has become a religious and social duty.

The progress of civilization in later times tended to reduce to a formality the observance of hospitable relations; but that in critical circumstances the person of the stranger continued to be sacrosanct is shown by the story of Themistocles, when an outlaw, throwing himself upon the mercy of his enemy, the king of the Molossians (*Thuc.* i. 136). Normally, however, hospitality became less an obligation than a sign of good-will—a point of view which is illustrated by the sovereignty conferred by the Dolonci upon Miltiades, who had offered board and lodging to their envoys when passing through Athens (*Herod.* vi. 35).

3. Gifts were especially appropriate to the recurrence of particular occasions. The earliest allusion to a birthday feast is in the *Pseudolus* of Plautus, the original of which belonged to the year 309 or 308 B.C. But there can be no doubt that the celebration of birthdays prevailed at a much earlier date. For its special purpose was to invoke the aid of the Good Demon (*ἀγαθὸς δαίμων*) at a time when—on the border-line of two periods—evil spirits were especially prone to extend their in-

fluence. It may be inferred from *Æsch. Eum.* 7 that, at any rate as early as the time of Æschylus, presents were made to children on their birthdays (*γενέθλιον δόσιν*). At a later date there is plenty of evidence for the custom: as examples of such gifts we find the mention of golden rings and charms (*Plaut. Epid.* 639), a silver pencil-case (*Anth. Pal.* vi. 227), and a garland of flowers (*ib.* 345). In the same connexion it may be added that at the Amphidromia, a purificatory festival which took place five days after the birth of a child, presents were made by friends and relatives (*πολύποδες* and *σηπταί*, according to *Harpocr.* p. 15, 8), as at a modern christening. In *Ter. Phorm.* 13, the slave expects to have to give a present when the child is born, then again on his birthday, and a third when he is weaned.

4. Gifts made on the occasion of marriage require special treatment. In the Homeric age we find clear traces of the time when marriage was an affair of bargain and sale. Aristotle (*Pol.* ii. 8. 1268b, 41) testifies to the fact that the Greeks of old bought their wives from each other. The bride-price paid to the father by the suitor is called *ξεδνα* (*ξδνα*) in Homer (*ἀπερεια ξδνα* [*Il.* xvi. 178]). The value of the bride is sometimes reckoned in oxen. In *Il.* xi. 243 the premature death of the husband prevents him from getting a return (*χάριον*) for the 100 oxen which he had paid down on marriage, with the promise of 1000 sheep and goats afterwards from the increase of his flocks. Hence the epithet 'oxen-earning' (*ἀλφειβόλαι*) applied to girls who were able to fetch a high price (*Il.* xviii. 593). In exceptional instances, or as a special compliment, the father might remit the price, as when Agamemnon offered to Achilles one of his own daughters in marriage (*Il.* ix. 146, *ἀνάεδνον*). In *Od.* i. 277, where the *ξδνα* seem to come from the wife's family, we may detect a changing custom: the explanation is perhaps that they were sometimes expended for the bride's outfit, and to that extent were returned to the bridegroom. However this may be, it is unquestionable that, at least in the case of ladies of high rank, it was customary for their family to provide a suitable portion (*δῶρα*). In this sense *Andromache* and *Penelope* are *πολύδωροι* (*Il.* vi. 394, *Od.* xxiv. 294; cf. *Il.* xxii. 51).

When we examine the records of the Attic period, we find that an entirely different system has come into existence, though we have no evidence concerning the change by which the revolution in custom was effected. But the change is evidenced by the shifting sense attached to the word *ξδνα* by the poets who still continued to use it. Thus in *Æsch. Prom.* 579 it is applied to presents made by the bridegroom to the bride to induce her consent to the marriage; in *Pind. Pyth.* iii. 94, to gifts made by those who were present at a wedding—like our wedding-presents; and in *Pind. Ol.* ix. 10 and *Eur. Andr.* 153, to the portion of the bride. The practice of providing a daughter with a dowry eventually became the rule in Greece. The terms *φερνή* and *ποξ*, generally interchangeable, were in use to denote a dowry; but some authorities hold that *φερνή* was originally limited to the outfit or *trousseau* of the bride, and that it must be so understood in *Plut. Sol.* 20, to be presently quoted. Aristotle (*Pol.* ii. 9. 1270a, 24) affords the curious information that two-fifths of the land at Sparta had passed into female ownership in consequence of the number of heiresses (*ἐπικληροί*) and the size of the dowries. There is evidence, however, that in early times a law of Lycurgus had severely restricted the right of giving dowries (*Ælian, Var. Hist.* vi. 6; *Athen.* 555 C). In Crete the amount of a dowry was limited to half a son's share (*Strabo*, 452). There

was no such limitation at Athens, except the law of Solon forbidding any woman other than an *ἐπίκλητος* to receive any *φερνή* in excess of a few clothes and articles of furniture. If *φερνή* is to be understood in the full sense, it is clear that the law soon became obsolete: for it was so general a custom at Athens to provide a dowry for daughters and sisters that a respectable Athenian was obliged to make sacrifices for that purpose (see Plaut. *Trin.* 689; Dem. xl. 25). The reason was to be found in the facilities for divorce permitted by Athenian law. In such a case the wife's dowry became repayable to her guardian (*κύριος*), and the husband was often required at the time of the marriage to provide security (*ἀποσίμημα*) by a mortgage of real property (Dem. xxvii. 17, etc.). The position of a dowerless wife was not only precarious but degrading (Men. *Monost.* 369). The law required that an heiress (*ἐπίκλητος*) without estate must either be taken in marriage by her nearest male kinsman or portioned by him suitably to his means, if bestowed upon another (Dem. xliii. 54).

5. In these cases family pride and natural affection, apart from legal obligation, combined to supply the necessary motives stimulating to action. Otherwise there is little to show that liberality in giving was highly esteemed among the Greeks. The philosophers may be taken to stand upon a higher plane of morality than was attained by the average man, and Aristotle's account (*Eth. Nic.* iv. 1) of liberality (*ἐλευθεριότης*) is typical of the most elevated Greek sentiment. The action of liberality is thus described:

'The liberal man, being virtuous, then will give from a noble motive and in a right spirit; for he will give the right amount, and will give it to the right persons and at the right time, and will satisfy all the other conditions of right giving.'

But the Christian precept, 'It is more blessed to give than to receive' (Ac 20³⁵), ushered in an entirely new conception of liberality as founded upon love. Sir A. Grant, in an excellent note on *Eth. Nic.* iv. 1. 16, remarked:

'Aristotle's statement would be, "It is better to give than to receive, because it is more noble." . . . In Aristotle's whole account we do not find a word about benevolence or love to others as prompting acts of liberality. We find no other motive but the "splendour" (*καλόν*) of the acts themselves.'

The strictly prudential attitude of the average man (*do ut des*) is clearly indicated by the common usage of *χάρις*, a favour or free-gift. The word constantly implies a reciprocal relation. He who has received a boon lies under an obligation to return it. Hence the phrase *χάριν καταθέσθαι* is 'to bestow an obligation,' much as a deposit is made of a valuable property which on a convenient occasion may be reclaimed (cf. Thuc. i. 33). The philosopher may protest that a boon ceases to be such, if it is conferred with the ulterior object of prospective gain (Arist. *Rhet.* ii. 7. 1385a, 18), but is compelled to acknowledge that, so soon as the action is done, a return is contemplated; and the giver is as prone to overrate the value of his beneficence as is the recipient to disparage it (*Eth. Nic.* viii. 13. 1163a, 9).

6. Voluntary contributions to meet the needs of the State were known as *ἐπιδόσεις*. It seems, however, that, like the 'benevolences' of English history, the name was largely euphemistic. In a small community indirect pressure could readily be applied as a spur to the unwilling. From an inscription of the 3rd cent. B.C. (*CIG* ii. 334) we learn that a *minimum* and a *maximum* were sometimes prescribed—in that case 50 and 200 drachmæ respectively: the appeal was followed by a list of subscribers with the amounts given. Isæus (v. 37) tells of a man who, when challenged to subscribe, offered 300 drachmæ on a critical occasion, but failed to make good his word, and was posted with other defaulters. The mean man, according to the

description of Theophrastus (*Char.* xxii. 3), is apt to rise in his place as if to make an offer, but then quietly slips out of the assembly.

7. We pass to the juristic aspect of gifts (*δότες*), although our knowledge of the provisions applied to them by Greek law is extremely limited.—(a) As regards gifts *inter vivos*, in view of the testamentary disability which prevented a man from disinheriting his children, it is necessary to infer, in spite of the absence of evidence, that the law could not be evaded by gifts made in the lifetime of the donor. Similarly, impediments were placed upon the alienation of their property by public officials who had not passed their audit, and by freedmen dying without issue. In the latter case the bar operated in favour of their former owners (Ziebarth, in Pauly-Wissowa, v. 1599). Bastards were not allowed to receive gifts from their putative parents in excess of the amount fixed by law, which was 1000 drachmæ (Harpocr. p. 133. 1).—(b) Gifts made in contemplation of death occupy a middle place between gifts *inter vivos* and testamentary dispositions. A valid gift of this kind could be made by the deposit of a sum of money or valuables with another, to be retained by him in the event of the owner's death, but to be returned if he should survive a journey or other adventure about to be undertaken (see Dem. lii. 23, 24).—(c) An early instance of what we call a charitable trust is to be found in the dedication by Nicias of a piece of land at Delos, which he had bought for 10,000 drachmæ, on condition that the revenue should be used by the Delians in defraying the costs of a solemn feast (Plut. *Nic.* 3). In the Græco-Roman age the endowment of foundations for religious or secular uses became increasingly common. Thus, the erection and maintenance of public buildings, such as theatres, baths, and gymnasiums, were often due to the munificence of rich private citizens. In such cases a corporation was formed to undertake the ownership of the property and management of the trust so as to secure its perpetuation. A right was sometimes reserved for the founder or his representatives to intervene, in case the management failed to carry out the terms of the trust; or the State might exercise a supervising control through its own officers.—(d) Gifts by testamentary disposition require only a brief mention here (see WILLS [Greek and Roman]). A general right of disposition by will did not exist throughout Greece, and is not recognized by the law of Gortyn; but there is evidence of its wide diffusion, at any rate in the Hellenistic era. Our information is naturally most complete in regard to Athens. The right of disposition outside the family, but subject to certain restrictions, was first conferred by a law of Solon. All citizens of full age and of proper capacity were competent to make a will, but no one could disinherit a son (Dem. xx. 102), or, if he had no son, leave his property away from his daughter, although he might direct that a particular person should succeed on condition of marrying her (Isæus, iii. 68). When a man had no issue, he was at liberty to adopt a son either in his lifetime or by will (*ib.* vii. 1). Subject to these limitations, legacies might be given to friends or relatives.

8. It was customary at Rome for presents to be made by friends and relatives to each other at certain of the annual festivals. The first of March was the beginning of the year according to the Roman religious calendar, and was also the *dies natalis* of the temple of Juno Lucina on the Esquiline. On that day, to which Horace refers in a well-known ode (iii. 8) as celebrated by married folk, husbands were accustomed to make presents to their wives (Mart. v. 84. 10). Juvenal (ix. 50) mentions green parasols and amber balls as gifts

which a woman is likely then to receive. After the year 153 B.C., when the beginning of the civil year was transferred to the 1st of January, it became customary to give New Year presents on that day. The feeling—no less universal than primitive, which underlay the custom—of the importance of an auspicious start is acknowledged in *Ov. Fast.* i. 178.

The gifts might be of trivial value—a gilded date (*Mart.* viii. 33. 11), like our Easter eggs; a dried fig; or honey in a white jar (*Ov. Fast.* i. 186). Especially, it was usual to tender small brass coins, as a symbolical gift of wealth. These gifts were called *strenæ*; and the name, if not the custom, is preserved in the French *étrennes*. Suetonius (*Cal.* 42) describes Caligula, who had announced that he would accept *strenæ* on New Year's Day, as standing in his porch, while a crowd of persons of every class pressed round him with their hands full of coppers. On the other hand, Tiberius often absented himself from Rome at the beginning of January in order to avoid the nuisance (*Dio Cass.* lvii. 8).

Of all these occasions the best known to us is the festival of the Saturnalia, which lasted for several days from the 17th December, and was kept as a popular holiday, characterized by every kind of merry-making and licence. The giving of presents then was as common as it still is at Christmas, and there is no doubt that the sports of the Saturnalia have been perpetuated for ages in the observances of the Christian festival. Martial's xivth book is entirely occupied with epigrams on specimens of rich or poor gifts suitable to the Saturnalia. The same poet (vii. 53) gives an appalling list of useless presents supposed to be sent to him at the Saturnalia, in order to remark in conclusion how much more simple it would have been to present him with the money which they cost. The *cerei* and *sigillaria* deserve special mention. The former were wax tapers (*funiculi cerei*), which may originally have had a symbolical reference to the revival of the sun's power after the winter solstice. They afterwards passed into the Christmas ritual of the Latin Church. The latter were little images made of earthenware, and sometimes of dough; Martial (xiv. 182) mentions the earthenware figure of a humpback (*gibber*). These also survived into Christian times; and even in England it is recorded that bakers made little images of paste at this season (*Brand, Pop. Ant.*³, 1870, p. 180).

The significance of the giving of presents on the Kalends of January and March is to be found in the same superstitious feeling which has already been mentioned as operative in relation to birthday-gifts. Magic influence must be excited in order to assist the passage from the old to the new year. The gifts at the Saturnalia were perhaps prompted by similar reasons, although the origin and development of that festival have not been ascertained with certainty.

J. G. Frazer suggested, from the analogy of the Carnival of modern Italy, that the Saturnalia was originally observed in February or March, and was transferred to December after the change of the Calendar (*GB*² iii. 144).

On the occasion of a birthday, which was celebrated by a feast in honour of the *Genius natalis*, friends brought with them presents of all kinds (*Mart.* x. 87). Nor was the custom restricted to the birthday of the head of the household. *Palæstra*, in the *Rudens* of Plautus (1171), mentions a golden *bullæ* (i.e. a case containing an amulet which children wore round their necks) which her father had given her on her birthday.

9. A marriage was the occasion for a variety of gifts. At the betrothal (*sponsalia*), which sometimes preceded the marriage by a considerable interval, a feast to which friends and relatives were invited was given in the evening, and presents were made to the prospective bride (*Blümner, Röm. Privatalt.*, Munich, 1911, p. 346). Juvenal (vi. 204) is our sole authority for the custom of present-

ing the bride with a sum of money, gold coins of Trajan on a salver, on the day after the marriage. The Roman law of dower is elaborated in the writings of the jurists, and will be more fully treated elsewhere (see MARRIAGE); here it is sufficient to say that the provision of a *dos* by the wife was a customary duty, and that her father, or those who stood in his place, could be required to furnish it. The *dos* was under the control of the husband during the coverture, and he was entitled to receive the mesne profits. The capital he was liable ultimately to make good, and landed property could not be alienated by him. At the termination of the marriage by death or otherwise, the rights of other parties accrued, which were usually regulated by the terms of the dotal agreement.

Cicero received as part of the dower of his wife Terentia certain flats (*insulæ*) on the Aventine and Argiletum. After her divorce he retained these, in order that the rents might be applied towards the maintenance and education of their son (*Cic. Att.* xii. 32).

10. A special class of gifts were those made by men of rank to their clients or dependents. These were called *congiaria*, properly a definite measure of wine or oil, and were especially made by magistrates and candidates for office to their supporters or to the whole people. Thus in the year 212 B.C. (*Liv.* xxv. 2) a public distribution of oil was made by Scipio as curule ædile. Money was distributed in this way by provincial governors to their staffs and troops (*Mommsen, Abriss d. röm. Staatsrechts*, Leipzig, 1893, i. 300²). Julius Cæsar is the first of whom we hear as making a gift of money to the whole people (*Suet. Cæs.* 38). In Imperial times this was a customary act of munificence by the Emperor, either in his own name or through one of his family (*Tac. Ann.* ii. 42). The claim on the Emperor's generosity soon came to be regarded as a right, and any failure to make a suitable response was resented accordingly. For the lavish extravagance of Caligula, who squandered in this way the accumulated savings of his predecessor, see *Dio Cass.* lix. 2. The occasions for such distributions were various, including great public festivals, such as the accession of a new Emperor, and the celebration of private anniversaries belonging to the circle of the Imperial family. As distinguished from gifts to the people at large, extraordinary presents of money to the soldiers, which were sometimes also described as *congiaria* (*Cic. Att.* xvi. 8. 2), came to be known technically as *donativa*. This reprehensible practice, which must be distinguished from the division of spoils on the occasion of a triumph, appeared for the first time in the last century of the Republic. The earliest instance is associated with the name of Sulla, and his example was followed by Julius Cæsar, Octavian, and Brutus and Cassius. In Imperial times the donative to the legions, and especially to the prætorians, became a regular institution. A new Emperor invariably sought to ingratiate himself with the troops by a liberal gift, and the refusal of Galba to confirm the donative promised in his name was the immediate cause of his downfall.

11. In connexion with the gifts of rich men to their clients, the practice of the *sportula* deserves notice. In acknowledgment of the homage rendered by the clients who attended the house of their patron, and escorted him when he went abroad, it was customary to invite them to share the evening meal. Subsequently, under the Empire, those who attended to render their morning salutation also received a dole of food, which they carried away in a basket (hence the name *sportula*). This dole was soon commuted, as convenience dictated, for a money gift of 25 *asses*, or about 1s. 3d. (*Juv.* i. 120). An edict of Domitian enforced for a short

time the revival of the *cena recta*, or regular meal (Suet. *Dom.* 7; Mart. iii. 7).

12. The conditions necessary to a valid gift were minutely investigated by the Roman lawyers. A gift was a mode of acquisition by delivery arising out of a particular motive. It must be such as to increase the property of the donee and to diminish that of the donor, and must not, therefore, be confounded with a grant of freedom or of citizenship. But, when the lawyers endeavoured to distinguish the strict legal meaning of *donatio* from its looser acceptation in popular phraseology, they were often inconsistent. Thus it is denied that the surrender of an inheritance is a gift; but an alienation made to defeat creditors is elsewhere admitted to be a form of *donatio* which is not subject to the usual provisions applicable thereto.

The suspicion with which gifts were regarded and the restrictions imposed to hinder their extension are noticeable features of Roman jurisprudence. They were, no doubt, primarily attributable to the Roman spirit of *parsimonia*, which is amusingly illustrated by the account given in Polybius (xxxii. 13) of the surprise excited by the younger Scipio's liberality towards the sisters of his adopted father—a liberality which consisted in paying down at once a sum of 25 talents to each, when he was entitled to spread the payments by instalments over three years. This niggardliness was the product of the hard conditions endured by the early agricultural population, and was unaffected by the prevalence of present-giving on particular festivals which has been mentioned above. These latter presents were generally trivial in value, and were considered as differing in kind (*munera, dona*) from voluntary benefactions. The growth of wealth and the increase of political ambition, which were the outcome of the Punic Wars, led to the passing of the *Lex Cincia de donis ac muneribus* in 204 B.C. on the proposal of the tribune M. Cincius Alimentus. This law prohibited advocates from receiving honoraria (Tac. *Ann.* xi. 5), and prescribed certain restrictions on the validity of *donationes*, if above a certain amount, and unless made in favour of a certain class of persons (*exceptæ personæ*). Outside those limits a gift must be perfected by the observance of certain formalities, as, e.g., that *res mancipi* must be conveyed to the donee by *mancipatio*. It should be observed that the statute did not impose penalties or annul gifts, but prevented proceedings being taken to enforce them. In later times a form of registration (*insinuatio*) was required for any gift exceeding 200 *solidi*, but Justinian (*Inst.* ii. 7. 2) raised the limit to 500. A mere agreement to give (*pactum donationis*) was not binding until the time of Constantine, who required it to be reduced to writing. Justinian, however, made it valid whether in writing or not, requiring the donor to complete the gift by *traditio*. In Imperial times, the object of stimulating munificence had become more important than that of repressing extravagance. It was provided, however, that gifts *inter vivos* should in certain circumstances be revocable, either (1) by the donor, if he could show that the donee had been guilty of specific ingratitude; (2) by the near relatives of the donor on a *querela inofficiosæ donationis*; or (3) in favour of after-born children, when a childless donor had enriched his freedman.

13. A special branch of *donationes inter vivos* is that of *donationes ante nuptias*. Gifts passing between husband and wife, unless of a trivial kind like birthday-presents, were invalid. If the wife passed in *manum viri*, her property belonged to her husband; otherwise, she retained her previous rights so far as they had not been surrendered in relation to the *dos*. The latter was the contribu-

tion to the expenses of the marriage on behalf of the wife; and, as we have seen, it belonged to the husband, subject to an obligation to restore its value if the marriage came to an end. The custom which enjoined the making of a gift by the husband before marriage grew up in order to provide for wives who had no property of their own, and so could not contribute a *dos*. Hence the *donatio ante nuptias in dotem redacta*—a sum of money put into settlement by the intending husband, in order to provide for his wife, if she became the survivor. It was considered the property of the wife, but could not be alienated even with her consent. Justinian provided that these gifts might not only be increased, but might be first made, after marriage; and, accordingly, that they should be styled *donationes propter* (not *ante*) *nuptias*. Dowries were placed on exactly the same footing.

14. *Donationes mortis causa* are contrasted with *donationes inter vivos* as being gifts made upon condition that, if anything happens to the donor, the donee's title shall accrue; but, if the donee dies before the donor, the latter shall receive back the gift. The gift was always revocable at the pleasure of the donor. It differed from a legacy as being a disposition made in the lifetime of the donor, and not merely a charge on his inheritance, so that it would take effect altogether apart from the act of the *heres* on entering into possession. In other respects these gifts were placed exactly on the footing of legacies. Thus, (1) no one could make such a gift, unless he was of full testamentary capacity; (2) the property in question remained subject to the claims of the donor's creditors; (3) the heir could claim his Falcidian fourth from it: i.e., the provisions of the *Lex Falcidia*, forbidding a testator to give more than three-fourths of his estate in legacies to the detriment of the heir, were made applicable to the property subject to the gift. The English Law has adopted the doctrine of *donatio mortis causa* from the Roman, but has still further restricted it by insisting on the necessity of delivery, and making the immediate expectation of death an indispensable condition to the validity of the gift. The provisions of the Roman law concerning gifts made under a will are described in artt. INHERITANCE and WILLS (Greek and Roman).

LITERATURE.—On the legal aspect of gifts, see L. Beauchet, *Hist. du droit privé de la république athénienne*, Paris, 1897, iii. 122 ff.; O. Karlowa, *Röm. Rechtsgesch.* ii. (Leipzig, 1892) 584 ff.; H. Burckhard, *Die Stellung der Schenkung in Rechtssystem*, Würzburg, 1891; and for *congiarium* and *donativum*. J. Marquardt, *Röm. Staatsverw.* 2 ii. (Leipzig, 1881-1884) 132 ff. See also the articles 'Congiarium,' 'Donatio,' 'Donativum,' 'Dos,' and 'Dosis,' in Pauly-Wissowa, and the corresponding articles in Smith's *Diet. of Gr. and Rom. Ant.* 3, London, 1890. For birthday customs, see Wilhelm Schmidt, *Geburtstag im Altertum*, Giessen, 1908. A. C. PEARSON.

GIFTS (Hindu).—Gifts, especially religious gifts to Brāhmins, form an important subject with the early legislators of India. The receipt of gifts, according to the Sanskrit lawbooks, is one of the principal sources of income of a Brāhman. What has been once promised to a Brāhman may be claimed by him like an outstanding debt. Their greatest means of support consisted in the grants of land, including sometimes houses, tanks, gardens, etc., given in perpetuity to gods or the priests. There is no lack of special Sanskrit treatises on the subject of *dāna*, i.e. gifts to the Brāhmins. The gift of a man's weight in gold or silver, called *tulāpuruṣa*, was considered specially meritorious. Thus Chandēśvara, a minister of Mithilā (Tirhut), presented in A.D. 1314 an assembly of Brāhmins with his own weight in gold. Royal grants of land on copper-plates have been found in great numbers all over India, and have furnished many interesting historical dates. The

land was generally granted rent-free, and with other privileges. Many *agrahāras*, or villages occupied by Brāhmins, held either rent-free under special grants, or at a reduced rate of assessment, are still in existence. There is a rule that *devottar*, landed property, i.e. lands dedicated to an idol, to a temple, to the maintenance of Brāhmins, or to other religious purposes, cannot be subjected to payment of Government revenue, if they were so dedicated before A.D. 1765. Funeral ceremonies were a special occasion for making gifts to Brāhmins, likewise a marriage, a thread-girding, and other family festivals and religious celebrations.

LITERATURE.—G. Bühler and J. Jolly's translations of Sanskrit lawbooks in *SBE*, vols. ii. vii. xiv. xv. xxxiii.; J. Jolly, 'Recht und Sitte,' in Bühler's *Encyclopedia of Indo-Aryan Research*, Strassburg, 1896; H. H. Wilson, *A Glossary of Judicial and Revenue Terms*, Lond. 1855; H. Cowell, *Hindu Law*, Calcutta, 1870; *Epigraphia Indica*, Calcutta, 1892-94.

J. JOLLY.

GIFTS, SPIRITUAL.—See CHARISMATA.

GIFTS TO THE DEAD.—See ARYAN RELIGION, ii. 20; DEATH, iv. 429, 469.

GILDS.—There exist among many barbarous peoples certain systems of confraternity and association which are analogous to the guilds of mediæval Europe. The concurrence is inevitable in social evolution, but actual continuity cannot be established, as, for instance, it can be established in the case of the State or of marriage. An attempt has been made to trace the Teutonic gild to the blood brotherhood of the ancient Scandinavian peoples, in which occurred the ceremony of mingling the blood of the parties in a footprint.¹ This would connect the system continuously with the various methods of forming the brotherhoods which are a feature of the lowest wild societies (see BROTHERHOOD [Artificial]). But the thread is too slender.² Similar social impulses acting in different conditions and in different ages will produce similar forms of union. An earlier hypothesis has been discredited, viz. that the gild originated in the drinking feasts of the ancient Teutons.³ Herbert Spencer traced the origin of the gild system to customs of paternal inheritance;⁴ Maine, to customs of adoption.⁵ But it is merely analogous to these, as it is to the family itself. Alone among peoples other than the Western, the Chinese and Hindus possess a similar system. The comparison of the three groups suggests that the gild belongs to particular types of humanity at a particular stage of social evolution. It is generalizing somewhat too broadly to say that 'the conception of the gild belongs to no particular age and to no particular country.'⁶ The guilds of mediæval Europe were a growth from the crossing of Teutonic and Græco-Roman ideas and institutions. In this connexion it is to be noted that intercourse between the peoples of Europe and their knowledge of one another was, in spite of relative slowness and difficulty of communication, not less, but probably more, than it is to-day. Half a century later than the Code of Justinian, which takes cognizance of the classical *collegia opificum*, a craft gild of soap-makers was established at Naples, and in 7th cent. England the 'Laws of Ine' illustrate the conception of the frith gild. It has been suggested that the *corps des métiers* of early France were directly continuous with the Roman *collegia*.⁷ On the

¹ M. Pappenheim, *Aldän. Schutzgilden*, p. 18 ff.

² K. Hegel points out that this brotherhood did not exist among the Franks and Anglo-Saxons, where guilds first appear (*Städte u. Gilden d. german. Völker im Mittelalter*, i. 250-255).

³ C. Gross, *The Gild Merchant*, i. 175.

⁴ *Principles of Sociology*, 1879, ii. 559.

⁵ *Early History of Institutions*, London, 1875, lect. viii.

⁶ F. A. Hibbert, *Influence and Development of English Guilds*,

p. 7.

⁷ Hibbert, *l.c.*

other hand, the influence of the Christian Church is to be taken into account;¹ for an essential characteristic of the gild is the religious conception of brotherhood.

'When,' says Gross, 'the old kin-bond or *mægth* was beginning to weaken or dissolve and the State did not yet afford adequate protection to its citizens, individuals naturally united for mutual help.'²

The reference is to England in the 5th and 6th centuries, and we may compare the fact that the first mention of Continental guilds is in the Carolingian Capitularies of A.D. 779, and that Charlemagne regarded these 'conspirations' as dangerous to the State. It might be said that the early Christians were the first guildsmen.

Three classes of guilds are distinguished: (1) *social and benevolent*, often described incorrectly as 'religious' (religious guilds proper, such as were formed from the clergy, are a sub-species of the social); (2) *gilds merchant*; (3) *craft and trade guilds*. Roughly, this order represents the order of development. The second and third classes are not prominent until the 12th century. Even these, as perhaps may be said of every mediæval institution, had a strong religious element, and possessed the functions of social and benevolent guilds.

In the O.E. and O.N. terms several formations have apparently coalesced.³ The O.E. *gild* or *gyld* has the meaning both of 'payment' and of 'gild,' and also of 'offering' and of 'idol.' O.N. *giöld* is 'payment'; Goth. *gild* is 'tribute.' The decision of the earliest meaning of the root is difficult; it involves the question whether guildsmen were originally those who contributed to a common fund or those who worshipped and feasted together.⁴ The question is perhaps irrelevant; in all likelihood the distinction was never made either in theory or in practice. The one function involves the other in all 'societies' formed in early Europe from classical times onward.

It is convenient to bear in mind the analogy already suggested of the Christian Church, while tracing the history of the guilds. They were its microcosms. In guilds of the social class, life generally, in its social aspect, was the main object. In other guilds other objects preponderated, such as the furthering of commerce, or of a craft; in short, livelihood was the main object.

A gild, in general, is 'a confraternity, brotherhood, or association formed for the mutual aid and protection of its members, or for the prosecution of some common purpose.'⁵ It is for Europe essentially a mediæval institution; other applications of the term are secondary or metaphorical; in several cases, as in Scottish burghs, the modern use is directly continuous with the mediæval. Such a confraternity in its social aspect performed functions similar to those of modern burial clubs, benefit, insurance, and friendly societies, the most important of the last-named being direct descendants of the mediæval type. The earliest included the payment of the *wergild*; all included the saying of Masses, and the holding both of religious services and of an annual feast. The majority had a saint as patron. In the commercial and craft guilds, the religious and social functions of the benevolent gild were retained, though the worldly ideal was predominant. This in the *gild merchant* was the best use of the monopoly of the town's commerce; in the craft gild it was the furtherance of the art or trade in question, the maintenance of good work, the fixing of a reasonable price, and the organization of employment on the system of apprenticeship. The gild was essentially a local institution; its members were neighbours.

The gild had a master and various officials. Each member took an oath, and paid an entrance

¹ Gross, *s.v.* 'Gilda,' in *EBr*11.

² Gross, p. 145.

³ *OED*, *s.v.* 'Guild.'

⁴ *Ib.*

⁵ *Ib.*

fee and annual subscription. Regular business meetings and an annual gild day were held.¹ The livery of the gild was worn at festivals and at all meetings of a ceremonial nature.² Small parish gilds met in a room or in members' houses. Large and wealthy gilds possessed a gild hall. Legacies and donations were received; loans were made to members, and gifts of charity to poor gildsmen out of the gild funds. The gild possessed a chapel or chantry, where its Masses were said, and where members met on the day of the patron saint. Schools and churches were financed or founded by important gilds. This last function has become the chief business of some of the great Livery Companies. Men and women alike were eligible for membership. Technically there was no distinction of classes. Henry IV. and Henry VI. belonged to the Coventry Gild of the Trinity. By the 14th cent. their numbers were enormous. Every town had many social, religious, and trade gilds.

(1) The *frith gild*, or *peace gild*, so called, refers to an occasional feature of town life in Northern Europe from the 6th century. The 7th cent. 'Laws of Ine,' and the 10th cent. 'Dooms of London,' are constitutions of frith gilds in substance, though not in form. The intention is to supplement defective law and constitution no less than to further national defence by local co-operation.³ A 'gild' is said to have been formed in Canute's time at Roeskild for the purpose of defence against the Vikings. The frith gild as such never crystallized into a formal institution.

¹ Brentano's commonly accepted story of a great network of frith gilds covering England, battling with lordly oppressors, founding town constitutions, etc., is merely a phantasm of the imagination.⁴

There was no general development even of the *corps des métiers* in France or of the *arti* in Italy before the 12th and 13th centuries; while gilds for trade and commerce are unknown in England until after the Norman Conquest. The question has been extensively debated as to the character and number of the Anglo-Saxon gilds. It cannot be maintained that gilds were characteristic of the Anglo-Saxon period. The idea of them was implicit, and occasionally expressed, as in the gild of thanes at Cambridge, which gave its members assistance in the blood feud and provided the *wergild*.⁵ The oldest gild ordinances of Europe are those of Cambridge, Abbotsbury, and Exeter, belonging to the first half of the 11th century. It is often assumed that the Normans brought over to England the idea of craft gilds which had been so largely exploited in the Frank empire for three centuries. The Anglo-Saxon gilds themselves were of the social type, apart from a few traces of co-operation in monastic orders.⁶ But the fact that religious gilds proper flourished under the Anglo-Norman kings was due to the Normans themselves.

Among the most famous social-religious English gilds was that of Corpus Christi.⁷ Organizations of a gild type have been traced to a period prior to the 7th cent. among English monasteries. The modern Catholic confraternities are lineal descendants of religious gilds. Gilds of Kalendars, so called because the gild met on the first of each month, were formed among the clergy. Gilds of the higher clergy were major, those of the lower were minor.⁸ But the social gilds were strongly

¹ The annual 'Show' of London's Lord Mayor is derived from such.

² Hence the name of the great London Livery Companies, the survivors of trade gilds.

³ Dover possessed a gild hall in A.S. times (Hibbert, 12).

⁴ Gross, *The Gild Merchant*, i. 191.

⁵ Gross, in *EBr* 11.

⁶ Hibbert, 8.

⁷ J. M. Lambert, *Two Thousand Years of Gild Life*, Hull, 1891, p. 120 ff.

⁸ L. Toulmin Smith, art. 'Gild,' in *EBr* 9. On religious gilds generally, see Lambert, 106-119.

religious; their ideal is an interesting continuation of early Christian principles. The object of association was

'not only devotions and orisons, but also every exercise of Christian charity, and therefore above all things mutual assistance of the gild brothers in every exigency, especially in old age, in sickness, in cases of impoverishment, if not brought on by their own folly, and of wrongful imprisonment, in losses by fire, water, or shipwreck, and by loans, provision of work, and, lastly, the burial of the dead. It included, further, the assistance of the poor and sick, and the visitation and comfort of prisoners not belonging to the gild.'¹

Even the craft gilds had a religious tinge,² or, rather, the framework of the organization was religious. The Tailors' and Shoemakers' Gilds had chapels in St. Chad's Church, Shrewsbury.³ Wealthy gilds spent considerable sums on the embellishment and upkeep of their chantries and chapels. The annual pageant was in a sense a thank-offering for the year's blessings. Mass, or Morn-speech (*Mornspeche*), preceded the ordinary business meetings, as well as the feasts, as it preceded the day's work daily for all Christians. A mystery play often was a feature of the annual pageant.⁴ It was probably as being a network of Catholic influence throughout the people that the gilds were abolished in Protestant countries on the ground that they were 'superstitious foundations.' In the 14th cent. Wyclif had condemned the abuses of the gilds. With their disendowment their important work of poor relief was taken from them.⁵ The craft gilds were technically only disendowed of their religion⁶ in the great suppression of the social and religious gilds in 1547. Their social services, however, were limited to their industrial side. The property of disendowed religious and social gilds was taken over by the Crown; gild halls became poorhouses. In Denmark and North Germany they were similarly affected by the Protestant movement. Modern social and religious 'gilds' are thus technically a revival, rather than a survival, of the mediæval.

(2) The *Gild Merchant*, or Gild of Merchants, was the dominant form of the organization of English commerce from the 12th to the 15th century. It is also closely connected with the growth of municipal government. In Anglo-Saxon times it had not been instituted. The Laws of the City of London, supplementing deficiencies in the law, exhibit 'a complete authority for the supervision of trade corresponding to the later Merchant Gild in nearly every particular.'⁷ But London, like certain other great cities, such as Florence, never developed a Gild Merchant. The 12th cent. was marked by the growth of towns, due to the impulse given to trade by the Norman Conquest. At first the chief difference between town and country was that the former possessed a Gild Merchant.⁸ Trade being the *raison d'être* of towns, and the chief burgesses being the chief merchants, they naturally combined to frame commercial regulations. Traces of such action are found as early as A.D. 1000; a Chapman Gild is mentioned in 1109.⁹ On the Continent the method was already established. It is presumed that the Normans introduced it into England.¹⁰

The Gild Merchant was an incorporated society of the merchants of a town or city, having exclusive rights of trading therein. They regulated the trade monopoly of the town, confirmed to them by royal charter of *gilda mercatoria*. This included the right of wholesale pre-emption of all trade coming to the town, and that of retailing, restricted to individual members. Free trade was allowed periodically at fairs. The great merchants

¹ L. T. Smith, *loc. cit.*

² Gross, in *EBr* 11.

³ Hibbert, 32.

⁴ *Ib.* 43.

⁵ The important census of gilds made in 1389 records that there were, for instance, in Norfolk 909 of various kinds.

⁶ Gross, *l.c.*

⁷ Hibbert, 13.

⁸ *Ib.* 12.

⁹ *OED*, *s.v.*

¹⁰ Gross, in *EBr* 11, *s.v.*

were usually large landowners. The Gild Merchant was exempt from the town tolls, their chief obligation being that of 'scot and lot,' participation in the town assessments. On occasion they supplied the town with money. The majority of householders became members, but not all gildsmen were burgesses; the status of burgess depended on residence and burgage tenement. Many outsiders were in the Gild Merchant. The system worked well, and it is easy to see the possibility, often realized, that the Gild should develop into the Town Corporation.¹ But the Gild Merchant and Borough were not identical; the former may be regarded technically as being a department of the borough constitution, though it was never the basis or nucleus of it.²

During the 14th cent. mention of the Gild Merchant decreases. Trade and handicraft were becoming more complex, and it may be said that each creation of a craft gild or trade gild weakened the Gild Merchant. In its best days the latter included many artisans; by the 14th cent. the craft gilds began to supersede it. Each separate trade or craft was able to secure a monopoly from the Crown when it suited the Exchequer to grant it. Thus the new bodies, in one sense, specialized the functions of the once all-embracing Gild, and, in another, usurped them. But there was no actual struggle between the new gilds and the older body. Nor did the Gild Merchant give birth to the craft gilds; no real organic connexion can be established. The gild system was the system of the day; the process of devolution was as if small factories for special industries should be set up by private enterprise in towns which hitherto had possessed one general factory and universal emporium. Economically the process marks an advance in the scientific organization of the division of labour.

The Gild Merchant survived longest in the small boroughs. In some cases its religious framework alone remained; in others its only trace is an annual feast-day or show. In many cases the term survived as a designation of the totality of the craft and trade gilds. In some, it served to denote the Corporation, in which it was frequently merged. Or again in special cases, where it had become virtually the civic government, it remained as such, or as a 'select body' thereof. Its terms and title recurred in a Royal Grant to the Colony of Virginia in 1705.³ Cases where it simply disappeared are easy of explanation. But cases where a 'company of merchants' is found after its disappearance present the problem of continuity.⁴ However, the rise of the Merchant Staplers and the Merchant Adventurers really marks a new epoch in the history of English Commerce.⁵

One or two special cases are to be noted. In Coventry the Bakers' Gild had been established for more than a century before any Gild Merchant was created.⁶ It was authorized by the *Communa* in 1208, and still exists to-day.⁷ At Wisbech a religious gild was the precursor of the civic Corporation which obtained its charter from Edward VI.⁸ Such cases, as well as the following, simply show the universality of the gild principle. If we look at the principle, we may describe the mediæval civic corporations as being themselves, so far, gilds. But this is not to say that this religious or that trade or merchant gild became the municipal authority.

Scotland, as in other matters, so in the develop-

¹ Gross, *Gild Merchant*, i. 5, 135, ii. 133, 149; Hibbert, 13, 18.

² Gross, in *EBr*¹¹, and *Gild Merchant*, i. 191.

³ Gross, *Gild Merchant*, i. 109, 115 ff., 118, 159-163.

⁴ *Ib.* i. 127 ff.

⁵ *Ib.* i. 140 ff., 148 ff.

⁶ W. Cunningham, *The Growth of English Industry and Commerce during the Early and Middle Ages*, i. 343.

⁷ *Ib.* i. 338.

⁸ *Ib.* i. 344.

ment of municipal constitutions, was more strongly influenced than England by the Continent, and thus reproduced some special features of the history of Continental gilds. England was never subjected to the struggle between the Gild Merchant and the craft gilds which was so regular a feature of Continental municipal life in the 13th and 14th centuries. There was some friction in London, which was soon removed. In Scotland the large admixture of a Flemish element in the population led to a division of the inhabitants into *guildry* and *burgesses*, just as was the case in Bruges and Ghent, for example. The *guildry*, as elsewhere, were the mercantile aristocracy. Craft gilds did not become important till the 15th century. Each gild, as it was created, was regulated by a deacon appointed by the town. The craft gilds struggled during the 15th and 16th centuries for the right of electing their own deacons and for a share in the government of the burgh. They succeeded at the end of the 16th century. The privileges survived till 1846.¹ The term *guildry* is still applied to the municipal corporations of the Royal Burghs. By the 15th cent. the Guildry practically formed the Corporation. In Edinburgh, Glasgow, Perth, and Aberdeen, the 'Dean of Guild' is still elected by the Guildry; elsewhere he is chosen by the Town Council from its members. This Dean of Guild is technically the head of the Gild Merchant.²

(3) By far the most clearly defined, and historically the most influential, were the *craft gilds* and *trade gilds*. The former term frequently implies the connotation of the latter. Members of the same craft, industry, or trade, working in the same town, combined in association to protect and promote their common interests, but on principles very different from those followed by any modern industrial organization. Their lineal descendants in London are the Livery Companies, whose title retains the fact of the uniform worn by these gilds, and also one of two synonyms for the gild—'company' and 'mystery.' The latter is a reduction of the Lat. *ministerium*, and is frequent in the dual term 'craft and mystery.' *Gild* was the North German term, *Zunft* the South German, *métier* the French, and *arte* the Italian. They have been traced—not without success, as noted above—to the Roman *collegia opificum*. It is unlikely that they had any evolutionary connexion with the manorial groups of workmen. In the Frankish empire they may have been first formed as brotherhoods of artisan serfs. In England they are first mentioned in the reign of Henry I., and were probably due to Norman and Flemish influence combined. The Weavers of London, Oxford, Winchester, Lincoln, and Huntingdon, the Cordwainers of Oxford, and the Fullers of Winchester were among the first to be formed.³ In the 14th cent. they were extremely numerous, their number and importance growing with the growth of the respective trades. In Normandy, Flanders, and Germany they were prominent in the 12th century. They were

'first introduced into this country as royally authorized organizations among *alien artisans* settled in English towns. They appear to have been in occasional conflict with the town authorities, but by the beginning of the 14th century the causes of disagreement seem to have been set at rest, and the Mayor of London had succeeded in establishing authority over the Weavers' gild in 1300. From this time onwards gilds were organized among the *inhabitants* who worked at one craft, with the consent and approval of the municipal government, and were utilized for certain purposes of police and regulation by the town officials.'⁴

The Weavers' gilds were perhaps the earliest; the Lorimers' gild is heard of in 1261 as insisting on the Saturday and other half-holidays for its

¹ Cunningham, i. 348.

² *OED*, s.v. In England 'dean' or 'deacon' is synonymous with the beadle who summoned gild meetings.

³ Gross, *Gild Merchant*, i. 114.

⁴ Cunningham, i. 337.

brethren, providing against the enticing away of apprentices, and fixing terms of payment.¹ At their complete development, already attained in Paris by the 13th cent., the guilds comprised the three ranks of Masters having apprentices, Journeymen or Yeomen, and Apprentices.² An eldest son was free of the craft by patrimony. The central figure was the Master Craftsman, who owned his implements and sold his wares. The executive consisted of these and two Wardens, who had the duty of supervising the competency of apprentices and the right of search. There was a board of Assistants: two stewards, a clerk, and later a treasurer; with a beadle who summoned meetings and kept the door.³

The religious aspect of the guild has already been noticed. The town authority, the *Communa*, was careful to maintain control over the guilds (the history of this relation proceeded differently in Scotland and on the Continent). 'Compositions,' annual agreements, were made between them and the town. The latter, as a rule, did not encourage the guilds of building trades.⁴

The craft guild has no historical connexion whatever with the modern Trade Union. Nor was it at all similar in principles and aims. On the other hand, it is equally unconnected with the modern Employers' Association or Capitalist Syndicate. The guild represented capitalist, manual worker, and consumer alike.⁵ It has been described as an 'aristocracy of labour,'⁶ so far as the labour element was concerned. Considering all its elements, we can reach no modern analogy except the distant ones of Co-operative Societies and the trading Municipality, the latter resembling rather the older Guild Merchant. Large numbers of half-taught helpers and unskilled workers were connected with, but had no share in, or membership of, the guilds.⁷ At Newcastle and elsewhere the aggregate of craft guilds was spoken of as the Guild Merchant.⁸ In many towns 'the old Guild Merchant lived on, not so much as a distinct body, but in the life of the separate crafts into which it had been specialized.'⁹ In short, they 'can hardly be regarded as democratic bodies'; they were 'the élite of each trade,' closely attached to the interest of a particular town.

The economic principles which they expressed are significant of the age of their best work, most of which is the glory of their respective countries.

'The purpose of these guilds was the regulation of work in such fashion that the public might be well served and that the trade might therefore flourish.'

But, whereas nowadays the same purpose is carried out on the following principle that

'each manufacturer works to produce at as low a price as possible, and thus to force a sale for his goods by their cheapness [another avenue of profit being the exorbitant price of articles of the best material and workmanship, so-called luxuries], in old times, continues our soundest student of economic evolution, 'the effort was to secure satisfactory conditions for production—skilled workers and honest materials—and to ensure a price which should be "reasonable" to receive and therefore reasonable to pay for such wares thus made.'¹⁰

It was on these principles that all guild ordinances were framed. Hence the Warden's right of search, and the proviso in articles that members of the craft should be resident.¹¹ A guild was a police system, an association of *ateliers*, and a Christian brotherhood. Its members included consumers; its status and functions were closely connected with municipal government.

England was not, as Brentano supposed, the

¹ Cunningham, i. 338.

² *Ib.* i. 349.

³ Hibbert, 41 f.

⁴ Cunningham, i. 340.

⁵ Sidney and Beatrice Webb, *History of Trade Unionism*, pp. 13, 16 f.

⁶ *Ib.* 37.

⁷ Cunningham, i. 347.

⁸ Gross, *Gild Merchant*, i. 118.

⁹ Cunningham, i. 345.

¹⁰ *Ib.* i. 342.

¹¹ *Ib.* i. 343.

birth-place of guilds,¹ but guilds passed through their phases of development on more typical lines in England than on the Continent, with which for this purpose Scotland is to be classed. First heard of in Italy, they became important in pre-Carolingian France. Not till the 11th cent. did they become important in Norway and the Netherlands, at which period their revival in France, after their suppression by Charlemagne, is to be placed. Denmark and Sweden developed them in the 12th and 14th centuries respectively.² The Guild Merchant on the Continent is the *Kuplode Gilde*, *Kopmanns-Gilde* of Germany, the *Comansgilde*, *Comannen Gilde* of the Netherlands and Northern France (*Hanse* is a synonym in both areas), the *Mercanzia*, *Università de' Mercanti* of Italy.³ Often identified with 'patrician governments,' these Guilds Merchant kept up a conflict with the craft guilds during the 13th and 14th centuries, a conflict extending from Italy to Scotland. The craft guilds in the end succeeded in obtaining a share of authority. Such a struggle, but against the nobles alone, was carried on in Florence by the *arti majori*.⁴

The Reformation, by disendowing the religious and social guilds and crippling the organization of the craft guilds, prepared the way for Poor Law reform and the changes in industrial evolution which were then shaping. An intermediate process remains to be noticed. In England during the 14th cent. the class of guildsmen known as *journeymen* or *yeomen* set up confraternities of their own. The movement was analogous to a struggle between workmen and employers. It was followed by a similar movement in Germany in the following century. The result was the formation of subsidiary craft guilds. 'Journeyman's companies' and 'Merchants' Companies' (the latter not to be confounded with the old Guild Merchant) became important in 15th cent. England. Amalgamation followed in the 16th and 17th centuries, often resulting in a more or less definite identification of the guilds with borough organizations. The privileges of the craft guilds were not formally abolished till 1835, in Scotland 1846, some still surviving. But the new economic forces broke the old principles in the 16th and 17th centuries.⁵ The guilds of France were abolished in 1789; guilds of European origin survived in Constantinople till 1877. Their break-up, generally speaking, was more rapid and clearly marked in Northern Europe, where the new commercial and industrial factors had most influence.

LITERATURE.—Charles Gross, art. 'Guilds,' in *EBr*¹¹, Cambridge, 1910, also *Gilda Mercatoria*, Göttingen, 1883, and *The Guild Merchant*, Oxford, 1890; W. Cunningham, *The Growth of English Industry and Commerce during the Early and Middle Ages*, Cambridge, 1910; W. J. Ashley, *Introd. to English Economic History*, London, 1891, i.; Sidney and Beatrice Webb, *History of Trade Unionism*, do. 1911; F. A. Hibbert, *Influence and Development of English Guilds*, Cambridge, 1891; G. Unwin, *Industrial Organisation in the Sixteenth and Seventeenth Centuries*, Oxford, 1904; K. Hegel, *Städte u. Gilden d. german. Völker im Mittelalter*, Leipzig, 1891; E. Staley, *The Guilds of Florence*, London, 1906; W. W. Hunter, *The Indian Empire*, do. 1882; H. B. Morse, *The Guilds of China*, do. 1909.

In the older literature: W. E. Wilda, *Das Gildenwesen im Mittelalter*, Halle, 1831; L. Brentano, *History and Development of Guilds*, together with J. Toulmin Smith's ed. of the Chancery Return of 1389, London, 1870; M. Pappenheim, *Altöän. Schutzgilden*, Breslau, 1885; L. Toulmin Smith, art. 'Guilds,' in *EBr*⁶.

A. E. CRAWLEY.

¹ Gross, i. 175.

² Gross, in *EBr*¹¹. Early notices subsequent to the Carolingian Capitularies of 779 are in the enactments of the Synod of Nantes in the 9th cent. and the ordinances of Hincmar of Rheims (A.D. 852).

³ Gross, *Gild Merchant*, i. 284. The Continental Guild Merchant is not prominent until the 12th century.

⁴ E. Staley, *The Guilds of Florence*, p. 39. For Chinese and Hindu guilds, see H. B. Morse, *The Guilds of China*; W. W. Hunter, *The Indian Empire*, p. 183 f.

⁵ Gross, in *EBr*¹¹.

GILDS (Greek and Roman).—1. Origin, etc.—The word 'gild,' which is here employed in default of a better, is in some respects unsuitable to the alliances which have to be considered, because it carries with it ideas which are foreign to the ancient world, as will presently appear. The Greek and Roman gilds had a long history, and their character varied greatly under the stress of the manifold influences, local and general, which were continually remoulding the social structure. Broadly speaking, the association of private origin is a feature rather of the later Greek and later Roman civilization than of the earlier. Few of these unions or brotherhoods or corporations (if a somewhat loose use of this designation be permissible) existed on the Greek side of the Mediterranean earlier than the 4th cent. B.C., and on the Roman side few were older than the Imperial age. It is natural to connect the vast outgrowth of private associations in both cases with the ruin of freedom. When the liberties of the Greek city-State on the one hand, and of the Roman burgesses on the other, were impaired, men naturally sought to compensate themselves by extending and strengthening social bonds of various kinds. But it is important to observe that in the Greek and græcized lands after Alexander, and in the whole Roman world after the inauguration of the Empire, peace became more stable, international trade increased with improved communication, and forms of cult spread from their centres of origin over ever-widening areas. Religion, trade, social enjoyment—these were the main sources from which the ancient gilds sprang, and these naturally became more productive as political and municipal liberty declined. In the romanized provinces a gild is usually named *collegium* or *corpus*. On the side of the Roman dominions where Greek influence was paramount, the titles were varied, and nothing like a common designation was in use. The evidence for the history of the Greek as well as the Roman corporations, in the period before they were wholly subjected to public control, is to be found almost entirely in a vast multitude of inscriptions, chiefly brought to light by very recent research. The details thus revealed are of intense human interest, as opening up secrets of social evolution of which literature betrays almost nothing. From the 4th cent. A.D. onwards the gilds were enslaved to the State, and participated in the universal misery. The severe regulations then enacted form a great element in the history of the age, and the Theodosian code supplies not a little information.

The ancient gilds were intimately bound up with the ancient municipality. In one of its most momentous aspects the old Greek and Roman world consisted of a vast complex of municipalities, each retaining some semblance of State sovereignty. The gild was a group within a town, and rarely had any links connecting it with similar groups outside. A notable exception is that of the 'Dionysiac artists' (*τεχνίται*), a union of men who served the theatre and exhibitions cognate with it—actors, dancers, musicians, and the like. Exceptionally large gilds of these persons were early formed, and they gradually coalesced, until, in the Imperial age, they acquired an organization which covered the whole Empire. Their traces are found in almost all lands subject to Rome. The position of the gilds within the cities of the romanized West was more definite than that which they occupied in the communities of the hellenized East, and in all public ceremonies they had a precedence allotted to them. After the municipal senates came the peculiar religious bodies called *Augustales*, then the gilds, then the unorganized common people (*plebs*).

2. Classification.—The gilds may be considered with reference to their three main purposes. Some had religion as their chief bond, others trade or labour, others mere social amenity. But it is impossible to draw sharp lines of severance.

(1) *Gilds for religious purposes.*—On Greek soil the earliest voluntary unions came into existence for purposes of worship. There was often a certain divergence between the cults sanctioned by the rituals of the city-States and those beloved by the masses. Among cultured people, too, the advance of civilization brought with it a dissatisfaction with official religion, which is clearly reflected in the dramatic and philosophic literature of Hellas. Men, therefore, banded themselves together to satisfy their yearning after gods not publicly recognized. The attraction which a divinity introduced by foreign residents might have for the Athenians even in the great classical age, is illustrated by the mention of the festivity of the Thracian goddess Bendis in the introduction to Plato's *Republic*. But it must be noted that hardly any gilds, either Greek or Roman, were entirely dissociated from religion. As religion was primarily a municipal concern, and citizenship was intrinsically bound up with it, no organized body of persons within a town could live without a cult. But the degrees of importance which the religious element possessed in the organizations were very various. In some it was the principal, in a few the sole, interest. In most it was only one of the avenues to enjoyment which a brotherhood opened up to its members. Most of these institutions existed principally for the enhancement of the dignity of life and for the increase of its satisfactions. Religious ceremonies were mainly joyous, and the common sacrifice or offering was a natural occasion for the common feast. The whole story of the corporations which were predominantly religious is rich in attractions; but only a few of its points can find a place in this article. Such gilds are far more characteristic of Roman or romanized cities than of those which were or became Hellenic. An early propaganda, obscurely recorded, gave birth to many brotherhoods in regions where Greeks dwelt, which spread far and wide the ideas known as Orphic. Another remarkable movement began in the 2nd cent. B.C., in favour of cryptic and ecstatic forms of worship. It gave rise to many unions of men who described themselves as *mystæ*. It embodied a revulsion from unbelief similar to that which created the great drift of the Western world towards forms of pagan faith in the 2nd and succeeding Christian centuries.

At Rome the more antique brotherhoods which served the gods (*sodalitates* or *sodalicia*), apart from the great State colleges, were organized and supervised by the State. Such were the associations for the worship of the Great Mother, introduced from Asia in 205 B.C. In Italy, private religious groups were first called into life by Greek influence. Many societies for the veneration of Bacchus sprang up as a consequence of the passionate superstition which the disasters of the Hannibalic War engendered. The secrecy of these brotherhoods led the Roman government to regard them as criminal, and to believe the wildest allegations concerning them. In 186 B.C. and the following years the so-called 'conspiracy' was suppressed by judicial murder on an enormous scale. For a very long time the societies for the service of Oriental divinities—Isis, Osiris, Serapis, Anubis, Mithra, and others—struggled hard for existence in the West. It was not until the age of Sulla that any *collegium* of this type could live unmolested. The Jews were specially favoured in this respect both in and outside of Italy, al-

though the ordinary Roman deemed their creed an odious superstition. The persecution of Christian societies is partly to be explained by the fact that they appeared to be of a secret, and therefore a dangerous, character.

With religious guilds may conveniently be classed those which were maintained to provide for the decent burial of deceased members, whose spirits were treated with a veneration not unlike that accorded to divine beings. These were generally formed by the very poor, and sometimes even by freedmen or slaves, especially by the great groups of both classes which were in the Imperial service. The inscriptions (to be found in the work of Waltzing mentioned below) provide a vast amount of interesting and minute information about these *collegia funeraticia*, as scholars are accustomed to call them, though in the actual titles no ill-omened word is used. Many describe their members as worshippers of a particular divinity. In some cases these colleges are called officially 'health-giving' (*salutaria*). The regulations testify to the extraordinary depth of the desire among these obscure people, not only to secure a distinguished burial, but to make certain of remembrance after death. These associations were almost universal in the Western half of the Roman Empire, while on the Eastern side, in spite of the Greek scrupulousness about funerary rites, few were founded and most of those owed their existence to Roman influence. Strange as it seems to moderns, the burial clubs, like almost all others, subserved to some extent the purpose of common enjoyment. The place of interment provided by the contributions of the members often had attached to it rooms for reunions, in which feasts were celebrated, and meetings held to keep alive the memory of the dead. There was a bright and even joyous element in the ceremonials which is alien to the life of Christian times. It may be noted that many associations, not primarily burial clubs, paid some attention to the obsequies of members.

(2) *Trade guilds*.—When we turn to guilds formed by men of the same trade or occupation (and these constitute the largest section), we can observe a great distinction between the Eastern and the Western divisions of the Roman realms. In the West, unions of this class are to be found in abundance in almost every city. On the walls of buildings in Pompeii about 1500 scrawls have been discovered calling for the election of particular persons to local offices. Many of these appeals were issued in the names of guilds of artisans or traders. We find gold-workers, wood-merchants, mule-drivers, fruiterers, cooks, bread-bakers, confectioners, poulterers, fishermen, dyers, fullers, porters, tailors, barbers, and perfumers. In Roman Africa, by way of exception, the trade organizations hardly existed. Their social functions were carried out by associations based upon the political divisions of the citizens (into *curiæ*). In the East, where the Greek spirit ruled, societies constituted by workmen or traders were sporadic before the days of Roman ascendancy; and, though they grew in number afterwards, they were never widely spread. In only a few cities was there a general organization by trades and occupations, in the Western fashion. In the city of Philadelphia, for instance, the corporations of workers were the constituent elements of the local body politic, as was the case with many mediæval communities (see Waltzing, iii. 51). At Thyatira, again, the manual labourers and traders seem to have been as completely organized as they were at Pompeii and in the generality of Western municipalities (see Waltzing, iii. 55). At Rome there was a legend which ascribed to King Numa the creation of the trade guilds. This was a mere

deduction from the fact that all guilds had a connexion with religion, of which Numa was supposed to have been at Rome the general founder. Romans and Italians possessed in a remarkable degree the faculty for self-government, and it was to this faculty that the guilds owed their origin. The associations of Roman citizens in foreign communities, to which the name of *conventus civium Romanorum* was given, testify to the Roman power of self-organization. It is a curious fact that the earliest inscription (*CIL* xi. 3078) relating to a trade guild is one which emanated from a college of cooks, natives of Falerii near Rome, who were domiciled about 200 B.C. in Sardinia. They employed their own peculiar dialect, the 'Faliscan.' It may conveniently be noted here that foreigners everywhere organized themselves after the fashion of the Roman *conventus*, for the protection of their common interests. Delos, for example, and Ostia possessed numerous guilds of foreign residents (see inscriptions in the works of Waltzing and Poland, mentioned below). In the later centuries of the Roman Empire associations of Syrian traders existed in many parts of the Western provinces (see Mommsen, *Provinces of the Roman Empire*, London, 1909, (ii. 138). The spread of Oriental cults was, of course, much furthered by these foreign societies.

(3) A number of guilds existed mainly, and some solely, for the promotion of social recreation or enjoyment—a purpose from which, as has been said, no guild was wholly free. The organizations with which we now have to deal flourished almost exclusively in the sphere where the Hellenic spirit was potent. Athletic, gymnastic, and artistic brotherhoods were rare and exotic in the West, whereas on the Eastern side of the Empire they were a natural growth, and a city could hardly make the proud claim to be Hellenic if it did not possess them. Apart from these, many social unions, both in the East and in the West, must be regarded as ephemeral. Such are the numerous companies of 'life-comrades' (*συνβιωται* in Greek, *convictores* in Latin), and also associations with eccentric titles, such as the 'sleepers' (*dormientes*) and the 'late-drinkers' (*seribibi*). The 'little thieves' (*furunculi*) and the 'assassins' (*sicarii*) remind us of the young men at Athens who called themselves by the name of a savage Thracian tribe, the Triballi, and of the 'Mohocks' in London during the reign of Queen Anne. With the athletic guilds may be classed the organizations of boys for military training—boys who at that stage were called *ἐφηβοί*. These were not so much guilds as educational institutions originating with the State. From Athens they passed to every land where Greek culture was adopted. In many places, as their age advanced, the *ἐφηβοί* entered clubs of younger men (*νεοί*), and later on became members of elder men's guilds, which bore the designation *γεροντία* (to be distinguished from the municipal councils or senates which had the same name). The numerous 'colleges of younger men' found in the West (*collegia iuvenum*) may have originated in an imitation of Greek custom.

3. Constitution and activity.—We shall now give a brief sketch of the constitution of the guilds and of the manner in which their purposes were achieved, during their flourishing period. In their organization, the voluntary associations imitated that of the municipalities. The codes of rules which inscriptions have preserved resemble greatly the codes by which the cities were governed. Greek lines were followed in the Eastern half of the Roman Empire, Roman lines in the Western half. The guild always had officers elected by the members, just as in the towns local magistrates were chosen. The members paid regular contribu-

tions, usually month by month, into a common chest, and the general body sanctioned the disposal of the funds. Fines for neglect or malfeasance on the part of officers and members alike were laid down with much elaboration, as was the case in the municipal statutes. The office-bearers were, as a rule, the richer members. These were expected to contribute handsomely towards objects of common interest. Money might be given; or buildings, or statues, or other benefits for the enrichment or adornment of the society might be bestowed. In course of time such contributions were more and more regularized until, as in the towns, there was a tariff of payments to be made on accession to offices, whether of a sacred or of a secular character. Of course, there was no universal tariff; each city and each gild enacted its own. In this way there was a great continuous outflow of wealth from private coffers for the advantage of the gild, and especially of its less wealthy members. This is a great feature of the Roman Imperial age. Ambition led many holders of office to exceed the stipulated gifts, and generosity was repaid by many kinds of honours—in particular, eulogistic inscriptions, special titles, and statues. The towns were full of effigies of benefactors, and the mania for erecting them was a common subject of ridicule. Cassiodorus, in the 6th cent. A.D., spoke of the statues in Rome as surpassing in number the population. The resources of the gilds were further increased by a device commonly practised also by the municipalities. Rich persons were adopted as 'patrons,' and were honoured in proportion to their benefactions. The wealth of the gilds naturally increased when Marcus Aurelius made them legally capable of taking benefits under wills. We have many records of extensive endowments and rich properties acquired in this manner.

The expenditure out of the common chest was largely devoted to the gratification, in various ways, of the members by banquets, exhibitions of games, and other spectacles, and social enjoyments. In the case of the funerary gilds the main expense was incurred in granting sums to the representatives of the deceased, wherewith to carry out the obsequies. Benefactions to the associations, like those made to the municipalities, had the effect of enabling the poor to profit in a certain degree by the generosity of those better endowed. But the ancient gilds, unlike their mediæval counterparts, paid no heed to what we should regard as charity. In all the multitude of inscriptions which they have left behind them there is hardly one which records any benefaction in aid of the sick and needy (cf., further, 'Greek' and 'Roman' sections of art. CHARITY, ALMSGIVING). In this aspect the Christian societies from the first contrasted strikingly with those which were pagan, and they won thereby the admiration of their bitter enemy, the Emperor Julian. Indeed, the poorer the gild, the less likely was it to be the recipient of important gifts. The burial clubs, composed of the poorest of the poor, had hardly any resources beyond the contributions of the members. It is very notable that, when distributions of money (*sportulæ*) were made on festal occasions, the members of a gild who were higher in social station received a larger sum than those of humbler rank, just as in Christian societies the priest's share was larger than the layman's.

As the gilds were not charitable institutions, so they were not societies for mutual benefits, like the modern provident or mutual insurance associations. Exceptions are rare. Some Greek unions which bore the name of *ἐπαυος* advanced money for certain purposes, to be repaid by the recipients (see Poland's work, mentioned below). These societies

were characteristic of Attica and the Greek islands. Here and there similar practices may be traced in connexion with gilds bearing other titles, but not often. In the Roman army of the late 2nd and 3rd centuries the minor officers were allowed to form societies for mutual aid. Records of such unions have been found especially in Africa (Waltzing, i. 308). Expenses contingent on advancement or change of station were met out of the common funds. The institution provided, in effect, an insurance against possible sudden requirements.

Modern writers have often been tempted to compare closely the ancient gilds of artisans with the workmen's trade unions of our day, and with the gilds of the Middle Ages. There is hardly a single true point of comparison. By combining, the ancient workers might procure from local or central authorities advantages and immunities which scattered individuals could not have secured. But, apart from this consideration, it is not too much to say that the trade bond, which was vital in the mediæval gild, as it is in the modern trade union, was merely incidental in the ancient association. No league of artisans in ancient times made any attempt to force a rise in wages, to prescribe the conditions of work, or to regulate apprenticeship. Still less were the workmen's *collegia* companies for the carrying out of contracts, as has sometimes been imagined. The all too common modern phenomenon of the 'strike' was almost entirely absent from the society of the ancient world. Of course, the existence of slavery partly accounts for the fact. But among the free workmen, who were far more numerous in the cities than modern scholars often suppose, the strike was so rare an event that the known examples of it may almost be counted on the fingers of one hand. We have an instance (inscription of Magnesia in *BCH*, 1883, p. 504) of a Roman governor compelling the bakers of a city to return to work; but in the Imperial age the bakers were more and more under local or Imperial direction, in order that the supply of food might not be endangered. A decree of the island of Paros (*CIG* 2374e) tells how the people erected a statue to an official of the community who compelled the artisans to keep to their work and also forced their employers to pay wages without the necessity of legal procedure. What was the exact nature of the quarrel does not appear.

It may be observed that the inscriptions show not a few examples of freedmen, and even slaves, being admitted to membership of unions mainly composed of free workmen, and even to offices (Waltzing, i. 347). The fact appears less strange when we remember that, in the times of the Empire, capitalists often entrusted large operations to men who were technically slaves, but actually subordinate partners. Another noticeable circumstance is that women appear among the members of the funerary gilds; even in the earlier Imperial centuries they were not disdained as 'patronesses' (*patronæ*) of other gilds, and were sometimes given the title 'mother' of the gild (see Waltzing, iv. 369, 373).

4. Relation to the Government.—The process by which the gilds were, in the end, subjected to the most stringent control by Government fills a chapter in the history of the ancient world which is of the utmost moment. The earliest interferences with the freedom of private association were due to religious causes, as in the case of the so-called 'Bacchic conspiracy,' mentioned above, or to the misuse of liberty for political purposes. Numerous secret societies sprang up from time to time which were really dangerous to the common weal. Such were the 'comrade-bands' (*ἐταίρεια*) at Athens during the Peloponnesian War, and the groups of ruffians organized by Clodius and others in the dying days of the Roman Republic. In 64 B.C. the Senate of Rome dissolved a number of these pernicious associations. Six years later Clodius passed a law which established complete freedom. This state of things the Empire naturally could not tolerate, and to the Senate was given jurisdiction over all gilds and private societies within the Roman dominions. Many of them record in their extant memorials that they possess the Senate's licence (Waltzing, i. 125). But in this field, as in all others, the Emperors could intervene, and did intervene with ever increasing frequency. Some of the letters which

passed between Pliny and Trajan (see *Epp.* 33, 34, 92, 93) have reference to this subject. But a vast number of associations subsisted without public sanction. So long as they were innocuous, the Government disregarded them; when they became a nuisance, it suppressed them. A club which was secret was *ipso facto* suspect.

A great change was brought about when public services were demanded of the different corporations. At first these services were elicited by rewards and immunities, particularly in the case of the guilds connected with the provisioning of the capital. Special exemptions from taxation were given by Claudius to those engaged in the bringing of corn from over the sea. Gradually this duty became compulsory, and what at first affected Rome alone afterwards befell the municipalities of the Empire in general. The terrible scheme of Imperial taxation, which, in the 4th and succeeding centuries, crushed out municipal freedom, was also fatal to the freedom of the guilds. It became extremely difficult for a man whose father was a member of a guild to escape from it; and a system of caste, of a kind, was created. The oppression which lay on the local senates and on the guilds alike, in carrying out their duty of producing revenue or supplying service to the Government or municipality, led the victims to attempt every method of escape. When a man fled, there was a substantial reward for his capture, and if this failed his property was forfeited. Thus the dwellers in towns were to a great extent in a state of serfdom, like that of the tillers of the soil, due to the same causes. The immunities granted at first to the Christian clergy induced many members of guilds to seek ordination, and the Emperors were compelled to cut short the privileges of clerics who merely wished to escape obligations. Thus in A. D. 365, Valentinian I. forbade clerical ordination in the case of the corporations of bakers. Other ordinances followed, and in 458 the law of 365 was extended to the members of all colleges. Means of production fell more and more into the hands of the central authority. A sign of misery is that in not a few cases the workers sided with the barbarian invaders against the Roman power (see an example belonging to 376 B. C. in Ammianus Marcellinus, xxxi. 616). Yet, with all disadvantages, the guilds died out slowly. In Italy a number of them were vigorous in the days of Theodoric, who saw their value and tried to protect them. At Constantinople many guild-organizations survived down to the 10th century. It has long been a disputed question whether mediæval municipalities and guilds can be affiliated to their ancient counterparts. The problem is not likely to be brought to an acceptable solution. Cf. preceding article.

The relation of the early Christian societies to the guilds is an interesting but still obscure subject. There were undoubtedly many Christian guilds which presented the appearance of funerary organizations, and so escaped Government control. Behind this screen these guilds were, of course, used for purely Christian purposes. Titles resembling those of the pagan corporations were avoided, and such names as 'brothers' or 'brotherhood' (*fratres*, *ἀδελφοί*, *fraternitas*, *ἀδελφότης*) were adopted. The Emperor Valerian, by his edict of 257, attacked the Christians through these associations, by withdrawing from them the protection of the law and rendering them illicit, and by sequestering the burial-places. The fact that Christians were very familiar with the pagan private unions, and adopted their forms in part for themselves, must have had influence on the early structure of the Christian institutions. But the extent of the influence is hard to define. The conclusions of Hatch, in his Bampton Lectures on 'The Organization of the

Early Christian Churches' (1880), are now generally supposed to be exaggerated.

LITERATURE.—The Greek guilds are exhaustively examined by F. Poland in his *Gesch. des griech. Vereinswesens*, Leipzig, 1909; the Roman, by J. P. Waltzing, in his *Etude historique sur les corporations professionnelles chez les Romains*, Louvain, 1895-1902. The survival of guilds at Constantinople is studied by A. Stöckle, in *Spätrom. und byzant. Zünfte*, Leipzig, 1909, which is an appendix to the journal *Klio*. A good survey of the subject is given in art. 'Collegium' by Kornemann, in the new edition of Pauly's *RE*. The position of the guilds within the municipalities is shown in W. Liebenam, *Städteverwaltung im röm. Kaiserreiche*, Leipzig, 1900. See also W. M. Ramsay, in *HDB* v. 132.

J. S. REID.

GILGIT DARDS.—See DARDS.

GILYAKS.—1. Ethnology, etc.—A tribe of unknown racial affinities living among many other native tribes, especially the Tunguses, in the northern part of Saghalien, on the shore of the mainland opposite, and on the lower course of the Amur (between 49° and 54° 4' N. lat.). The Gilyaks are below middle height; the average height of twelve men measured by Zeeland was 162.2 cm. (5 ft. 4 in.); that of eight women measured was 150.4 cm. (4 ft. 11 in.). They are squarely built, with a short neck and well-developed chest, rather short and crooked legs, small hands and feet, a fairly big and broad head, swarthy complexion, dark eyes, and straight black hair, which the men plait in one tail, the women in two. The Gilyaks are of two types: the Mongolian or Tungus, and a type less far removed from the European, with a long-shaped face, moderate cheekbones, more open eyes, and more hair upon the face. There is every ground for believing that the original pure racial type has vanished owing to age-long crossing with various alien elements. What marks out the Gilyak among the Mongolo-Manchurian tribes by which he is surrounded is his language, which has nothing in common either with that of the Ainus or with that of the Tunguses. So far we can only say that certain grammatical peculiarities allow of our comparing Gilyak with the languages of the aborigines of N. America (see below, § 8). Ethnographers have accepted the view first set forth by Schrenck, according to which the original location of the Gilyaks was the Island of Saghalien, from which they migrated to the mainland. But the latest investigator of the Amur region, Sternberg, supposes that certain peculiarities of Gilyak life, survivals both in speech and in custom, and, finally, tradition, give us reason to suppose that the Gilyaks are immigrants from the distant north, from the Arctic regions. The most characteristic survival of this kind is the fact that on certain solemn occasions a Gilyak is compelled to use not the door but the smoke-hole of his pit-house, which among Arctic tribes serves as the regular entrance into the hut. The actual terms used to express the ideas of entrance (lit. 'diving down') and exit (lit. 'popping up out of') confirm this view of such survival. The modern name *Gilyak* is probably not of Chinese origin (as Schrenck, who derived it from the words *Kile*, *Kileng*, supposed), but rather spread to the Gilyaks from the Tungus tribes which bear the name *Gilyami*, *Gilyakha*. The Gilyaks' own name for themselves is *Nivukh*, *Nitsyvyts*, i. e. 'inhabitant of my place.'

The Gilyaks numbered in all, according to Sternberg's repeated enumerations made in the nineties, 4365 souls (2392 males, 1973 females); of these, Saghalien contained 1954 (1089 males, 865 females), and the mainland 2411 (1303 males, 1108 females). Since the appearance of the Russians the numbers of the Gilyaks have noticeably fallen off. Epidemics of smallpox, typhus, and measles in the sixties and seventies carried off 30 or 40 per cent. of

the population. Something must also be ascribed to periodic famines, along with the scurvy which inevitably accompanies them. According to tribal traditions, the nation of the Gilyaks would long ago have disappeared but for the constant immigration into its territory of solitary exiles and refugees from neighbouring peoples. These energetic immigrants, thanks to natural selection and to crossing, produced vigorous and healthy progeny, which delayed the process of extinction.

2. Mode of life, etc.—The Gilyaks live in settlements, whose numbers depend on the fishing conditions of the locality. There are small settlements with only five or six inhabitants, and large ones with two hundred. They follow a half-settled mode of life, changing their place of abode several times in the year, in accordance with the movements of the fish, their own occupations, and the seasons of the year. Their summer quarters are generally near the sea at the mouths of rivers; in the winter they move away from the sea to the edge of the *taiga* (Siberian jungle). Their winter huts are of two types. On the mainland and on the shore of Saghalien which looks towards it they have adopted a hut of the Manchurian type. It is a big shed-like house of timber, squared or unsquared, with a two-pitched roof supported by pillars inside, no ceiling, but windows filled in with fish-skin; along the walls under the sleeping-benches are run horizontally big heating pipes daubed with clay, and connected with two low stoves which are placed on each side of the entrance to the house. The pipes are generally made of whole trunks of hollow trees. Another type of winter quarters is the pit-house, half sunk in the earth, and having above its level only a pyramidal superstructure of timber with soil heaped upon it. In the middle of the pit-house is an earthen hearth surrounded by a low wooden fence. Above the hearth is the smoke-hole. The way into the hut is through a low movable door giving upon a vestibule. Round three sides of the hearth are the sleeping-benches, of which the one opposite the entrance is reckoned the most honourable. The summer habitation is either a wooden wigwam standing directly upon the ground or else a shed on high posts, which serves in winter as a store for preserved fish. The interior of the habitation is most unattractive: smoke, cold, darkness, dirt, and plenty of parasites.

The Gilyaks' chief occupation is fishing. Two species of the genus *Salmo* (*S. proteus* and *lagcephalus*) yearly visit their territory in countless numbers, and form the basis of their subsistence. Of the other kinds of big fish the most important are two species of sturgeon (*Acipenser sturio* and *orientalis*). They use the fish not only cooked but in a raw or frozen state. They catch them with hand-nets, hooks, cast-nets, and seines made of nettle-fibre; they also spear big fish. The second principal occupation of the Gilyaks is the chase of big sea-beasts. Their vegetable food consists of berries. Hunting is a secondary occupation. They kill bears chiefly in the time when the fish are passing, and the bears come down to the banks of the stream in whole crowds. Hunting sables, carried on by means of nooses, pitfalls, and traps, yields most of the money with which they purchase necessities.

The weapons of the Gilyaks are the bow and arrows with iron heads. It is particularly to be noticed that they use dogs for food, which is quite contrary to the custom of the other hunting tribes. Their means of locomotion are boats and, in the winter, sledges (*narta*) drawn by dogs. Their boats are of two kinds: (1) sea-boats after the Manchurian model; (2) river-boats of native production, dug-outs made from a whole poplar, with

round bottoms, long and narrow. The sledge is, like the boat, a dug-out, and very narrow, so that the driver sits astride upon it and his legs slide on snow-shoes on each side. The dogs, from five up to thirteen, get over as much as 12 *versts* (8½ miles) in an hour.

The Gilyak's winter costume is a tunic of dog-skin with the fur outside; from the waist to the knees there is worn above it a short skirt of seal-skin; besides this are fur thigh-pieces and boots of sealskin cut in the Chinese manner. On the forehead is worn a frontlet of squirrel tails, on the head a hat or bonnet of fur inside and out with ear-pieces—with the men these are separate; the women's form part of the bonnet. Their hands are covered with gauntlets of hare's fur. Their underclothing consists of a shirt of bought material and short drawers of the same down to the knees. The summer costume is nowadays almost exclusively of bought stuff, mostly red, blue, or black. Clothing of fish-skin and costly women's clothes of carp-skin, with numerous patterns embroidered in colours, are going out of use. Summer foot-gear is still made of fish- or seal-skin. The summer hat of the men is conical in form, and made of birch-bark with patterns on it; the women's is bought, and is of Chinese fashion. All the parts of their costume except the under-linen and the furs are edged and embroidered with the most delicate patterns. The Gilyaks are very skilful in carving wood: ordinary things, even cups of birch-bark, are adorned with very fine patterns. The modern Gilyak arabesque has developed gradually from the meshes of netting and the representation of various animals.

3. Family and domestic life.—The structure of the family among the Gilyaks has peculiar features. At first sight, marriage would appear to be absolutely individualistic. As a matter of fact, monogamy is the commonest form; polygamy is rare, and owes its occurrence to circumstances. According to the accounts given by the Gilyaks themselves, polygamy hardly exists at all either on Saghalien or on the estuary of the Amur or on the coast of the Sea of Okhotsk; it is fairly frequent along the course of the Amur; but, even where it is found, there are seldom more than two wives. A Gilyak buys his wives from outside his kin, and pays a bride-price for them, according to their value, in various precious goods. A Gilyak's wives and his children are reckoned his wives and children in the eye of the public; but at the same time there is a whole group of men—his younger brothers, cousins in every degree of kinship, and also the husbands of his sisters and his wife's sisters—who have the right to sexual intercourse with his wife. A group of brothers possesses the same right over all the sisters of the wives of each of them. Accordingly, any man who is joined in individual wedlock to any woman has rights over a whole group of women. Likewise, each woman who is married to a single Gilyak is at the same time participant in a group marriage with the whole group, consisting of the husbands of her own sisters and the brothers of her husband. This regulation of sexual intercourse, discovered by Sternberg in 1891, is in exact accordance with the words expressing relationship. Each man applies the word *an'khei* ('wife') not only to his individual wife, but to all his own wife's sisters and also to all the wives of his elder brothers; and the woman gives the name *puniva* ('husband') not only to her own individual husband, but also to the whole group of persons mentioned above. In the same way the terms 'father,' 'mother,' 'brother,' 'son,' and the like, are applied to whole groups of persons; the wives of brothers call each other 'sister,' and a daughter's husband calls his wife's father's sister 'mother.' The men of each kin

marry, for the most part (and formerly this was obligatory), the daughters of their mother's brothers, and women wed the sons of their father's sisters. The rules as to sexual intercourse among the Gilyaks can by no means be called immoral, inasmuch as towards persons in forbidden classes the strictest correctness is observed in all relations; with such not only jests, but even ordinary conversation, are forbidden. The position of women is one of subjection. Their marriage is often forced; betrothal is often arranged between children not yet weaned. The special sentiment of love is well known to the Gilyak. The death of a beloved wife, or the impossibility of marrying one's beloved, is often a motive for suicide. This sentiment is often the cause of women being carried off. Kinship among the Gilyaks is exogamous, founded on the agnatic principle; its signs are having: (1) the same hearth or lord of the hearth; (2) the same kin-gods and sacrifices; (3) the same kins into which the women are given in marriage, and from which the men take their wives; (4) the same common obligation of kin-vengeance; (5) the same cemeteries in common; (6) mutual rights of inheritance; (7) the bear-festival in common.

In spite of the agnatic principle, the Gilyaks do not recognize any patriarchal power of the elder. The elders of the kin or the richer members of it receive respect and exercise authority, but not power. Juridical relations are to a great extent regulated by the kin organization. By the agnatic principle only sons inherit, or, in their absence, brothers—preferably that one who takes over the wife of the deceased; but in any case the property does not pass out of the kin. Only by testamentary disposition can part of the property pass to daughters or to an outsider. A curious case of taking the law into one's own hands is the reclaiming, by force of arms, of a woman who has been carried off. But more frequently recourse is had to the decision of the kinsmen. An insult leads to a duel with sticks. Not long ago, if a kinsman was slain by an outsider, the kin of the slain man would all unite in sanguinary warfare with the murderer's kin, but the women and property were not touched. Sometimes such struggles ended in a peace, upon condition of the payment of a blood-price. Murder within the kin is not punished.

In general, juridical morality among the Gilyaks stands very high. Thefts are almost unknown; murders are never committed for the sake of gain. But the evil example of the Russian traders is beginning to have its destructive effect. The moral feeling which animates the Gilyaks is visible among them in the general propriety and in the modesty of the women. They live all together; but shameless nakedness is not allowed, nor the disgusting scenes which are met with among the Ainus. Of course, even among the Gilyaks, cases of unchastity outside wedlock occur; but the parents of a girl who commits such a fault treat her with severity; the mother, according to the Gilyaks, subjects her to corporal punishment; and the father, in case of an illegitimate child being born, tries to set the evil right by killing the child and hiding its body. The marriages, though based upon sale, generally run a peaceful course. As long as the wife is young, the husband guards her jealously, and she most carefully avoids giving him cause for anger. Moreover, both sides are kept in check by the fact that a husband who sends back his wife to her parents for any reason has no right to ask for the return of what he had formerly paid for her. If a wife leaves her husband of her own initiative, he can demand that the payment made for her be given back to him.

In allotting the labour of keeping up the domestic economy, incomparably the greater share falls

to the wife. The husband is responsible only for winning the most necessary means of subsistence. Hunting, fishing, trading, and the journeys connected with them, are the whole sphere of his activity. The time when the Salmonidæ pass up the Amur in masses perhaps requires of him redoubled energy; but in this case, too, the woman gives him no inconsiderable help. When the fish has been brought to the bank, she has to clean it, gut it, split it, and arrange it on the drying stages to be parched in the sun. It is also the women, partly with the help of the children, that lay up, for the winter, stores of food derived from the local flora, and collect berries, roots, herbs, mosses, etc. The Gilyak children are kept in an extremely dirty state. The mothers wash them only in very rare cases. Nevertheless they are usually, at any rate in winter, well and carefully dressed. Their clothing exactly reproduces in miniature the adults' garb, down to the smallest details and all the ornamentation. From the belt which secures the coat and apron of the little Gilyaks hang all the same objects as the adults carry—tinder, flint and steel, pipe-cleaner, etc. In their amusements and games the children love to imitate the work and pastimes of their elders.

In cases of polygamy all the wives live together in one and the same room, and each has for herself and her children an appointed place on the sleeping-benches. All the wives have equal rights, and each gives her share of labour to the domestic economy. But the division of labour is not always equal. The wife who enjoys the special favour of the husband is generally given only the lighter work; the heavier is allotted to the rest. According to local testimony, a Gilyak often contracts a second or third marriage solely in order to render easier the life of one or other of his former wives, by putting at her disposal a fresh worker. Men of the richer class, who from sheer ostentation, in order to make a show of their wealth, allow themselves the luxury of several wives, not infrequently adopt another means of lightening the labour of the latter. They allot the heaviest labour about the house to slaves, usually female, but occasionally male, bought for this purpose. The Gilyaks have a special word for them, *krygkhrys'* or, according to their sex, *krygkhrys'-umgu* for women, and *krygkhrys'-utgu* for men. It is to be noticed that they have no slaves of their own tribe; and the number of slaves, especially male ones, is rather limited. The reason for this is the high price which they have to pay in getting them either directly from the Ainus, or Goids, or, more frequently, from other Gilyaks at second hand. The price of a female slave is much higher than that of a wife. Slaves male and female are without any civil rights, and are entirely dependent on their lord; they are treated humanely only as far as the lord's own interests dictate, and he has perfect freedom to sell them whenever he likes. The business of slaves is to obey and to serve, but their chief suffering, especially in the case of the females, comes from their having no rights at all, and from the contempt with which they are treated by their masters, who do not allow themselves any human relations with them. Gilyaks are not allowed to marry female slaves, or have sexual intercourse with them; the latter rule, however, is not always kept by young unmarried men. But no Gilyak would ever allow himself to acknowledge progeny resulting from such intercourse. A child that comes into the world under such circumstances is reckoned to belong to its mother's tribe, and is the property of her owner. It is allowed to grow up along with its mother, and when it is adult it is kept or sold just like any other slave.

In view of what has been said about marriage, it is obvious that the right of inheriting extends only to persons of the male sex, and woman herself passes in inheritance like a chattel. The only direct heirs of a deceased Gilyak are his sons, however many they may be, on absolutely equal terms, no regard being had to seniority. The wife and daughters, whether married or single, have no rights in the inheritance. The only modification is when a man leaves behind him a wife with young children. The relict, along with all the property of the deceased, passes to his next eldest brother as his wife, whether he is single or married even to several wives. The levirate, however, is not quite obligatory. Any other person may, if he wish, marry the widow, with the consent of the brother-in-law and on payment of a certain sum. The children, according to custom, are not forbidden to follow their mother. Finally, if a deceased Gilyak leave neither sons nor brothers, the right to the inheritance passes to his nearest male relative. In the words of the Gilyaks themselves, the deceased is succeeded by his so-called *kall*. A clear distinction is made between relatives on the father's and on the mother's side. The former are called *ngafk*, and are reckoned blood relations; the latter *amal*, 'friends.' It is only the former who are subject to the obligations connected with the so-called blood-revenge, which plays such an important part in Gilyak life. Like all primitive peoples, the Gilyaks hold strongly to the feeling that every shedding of blood requires a corresponding retribution exacted by the victim or his kin. Not less deeply seated in their minds is the belief that any one who omits to fulfil this duty inevitably pays for the omission by misfortune or even death. This belief, which is universal among them, has in the execution of blood-revenge a powerful, decisive, and permanent influence upon the conduct of both sides—the offensive and defensive alike. The execution of blood-revenge is partly facilitated, partly hindered, by the fact that not only the immediate principals take an active part in it, but also their kinsmen, who are actually subject to certain obligations. The latter do not extend to all relatives, but only to the *ngafks*, i.e. those on the paternal side. The laws of blood-revenge unconditionally require *ngafks* to avenge a kinsman who has been slain outright or has died from wounds received and cannot avenge himself. If his hurt is not fatal, he is himself the avenger, and his *ngafks* only help him. The same obligations are imposed upon the *ngafks* of the original aggressor. The feeling of solidarity in the matter of blood-revenge, which binds together all the *ngafks* of one and the same kin, especially a large one, serves as some guarantee against attacks being readily made upon any of them.

4. Government.—When Schrenck was on the Amur the Gilyaks were subject to no one, and paid no tribute either to China or to Russia. It is true that in the beginning of last century they were still to some extent subject to the Chinese power both on the Amur and on Saghalien. In the twenties of the 19th cent. this state of things was altered. The authorities of Manchuria chose headmen in many places from among the natives, and upon them lay the duty of collecting tribute, each in his own district, and delivering it at Deren. Later, the Chinese rule sensibly weakened in those parts, and concentrated itself exclusively in that region of the lower Amur which extends up the river to the Sungari. The Gilyaks and Olchas remained only nominally subject to China and paid no more tribute; when Schrenck lived among them, they were very conscious of independence and liberty, and there was no talk of any headmen

among them, so that Schrenck even failed in ascertaining the Gilyak name for them. In the fifties the Russians established themselves firmly at certain points of the Amur region, e.g. at Petrovsk, Nikolavsk, and Mariinsk. By the time of Schrenck nothing was left of the institutions forced upon the Gilyaks by the Manchuro-Chinese administration, while the Russians had not yet had time to introduce any new arrangements. Accordingly the people was left to itself, and within certain limits nothing interfered with its action. This was the most favourable time for studying its native manners and customs, and it is these we shall keep in view in our survey.

With the exception of the regulations concerning the family and the paternal kin, the Gilyaks have no legal rules or accepted organization to determine the course of self-government. They do not elect from among themselves any persons with authoritative power to preserve proper order in the community, settle any differences which may arise, or the like. Indeed, there seems no need for anything of the kind. They have no wars with their neighbours or internal strife; they make no predatory raids on neighbouring lands, and exact no tribute; hence they need no leaders or headmen or such governing persons. On the other hand, there is a sharp difference among them in the matter of material prosperity. A Gilyak is reckoned rich who can make frequent journeys to trade with the Manchus and Sizams (the Gilyak name for the Japanese), and among them get a store not only of all the necessaries of life but of various articles of luxury. Further, journeys and intercourse with foreigners give the prosperous Gilyak such a breadth of view and experience, and make him so much more clear-sighted and logical, that, quite apart from his material importance, he acquires a great influence with his compatriots. Thanks to his wealth, he becomes, as it were, the soul of his village. It is his house that is chosen for the cheerful assemblies and feasts which accompany the bear-festival. The help a rich Gilyak gives to a poor one is not a matter of sending something or other to his house, but of supplying him with all the necessary means of subsistence gratis (in Gilyak *pai*). The chief ground of this is the communistic spirit which pervades all primitive peoples.

5. Calendar, etc.—The Gilyaks have no exact idea of time, and so they define it only very approximately. Besides the usual expressions like 'day' (*mu*), 'night' (*urk*), 'morning' (*tyt*), and 'evening' (*padf*), the time of day is defined according as the sun is rising or setting (*keng-myrrch* or *padnch*, 'being born'; *keng-yugch* or *much*, 'dying'), mounting the sky (*keng-tytyrakh-bokirch*), slanting down (*keng-kotrech*), or standing at its highest point at noon (*keng-muvuty*). It is especially difficult for them to define some day long past but in some way memorable, as it is exactly like the whole series of similar days spent at one place amid the ordinary duties. In spite of this, they follow very attentively the phases of the moon. They have separate terms for full moon and new moon (*long-charnch*, 'the moon is full'; and *long-much*, 'the moon is dead'), its waxing and waning, and also for the various stages of these phases of waxing and waning. The year is divided into twelve months, but the names of the months differ in various parts of the country. Some are current among the Gilyaks living on the lower Amur and its estuary, on the western coast of Saghalien and on the south coast of the Sea of Okhotsk, while others are used in the interior and on the east coast of Saghalien. The following are the names of the months among those on the west coast of Saghalien and on the mainland:

January,	<i>Cham-long</i> ;	July,	<i>Machn-chrar-long</i> ;
February,	<i>Karr-long</i> ;	August,	<i>Lygi-vota-long</i> ;
March,	<i>Chrad-long</i> ;	September,	<i>Ngarvi-long</i> ;
April,	<i>Arkait-long</i> ;	October,	<i>Oni-lami-long</i> ;
May,	<i>Vallen-tengi-long</i> ;	November,	<i>Tlo-long</i> ;
June,	<i>Tenga-vota-long</i> ;	December,	<i>An'-long</i> .

The Gilyaks divide the twelve months very unequally into seasons, of which, strictly speaking, they recognize only two—winter (*tulf* or *tulv-an'*) and summer (*tolf* or *tolf-an'*), corresponding to the times that they live in winter-houses and summer-houses. In general their year falls into the following divisions: winter, consisting of five months, November to March; spring, one month, April; summer, five months, May to September; autumn, one month, October.

Seeing the daily rising and setting of the sun, they naturally think that the earth (*mif*) stands immovable and the sun (*keng*) moves round it; further, the circle of the horizon makes them imagine the earth as a disk. But as to where the sun hides when he has set and night has come on, they do not inquire.

'When I asked them about this,' says Schrenck, 'they laughingly answered my questions with others, such as whether I had perhaps seen somewhere or other the sun after he had set. The more intelligent of them, such as Yuchin and Ruigun, involuntarily began to revolve the problem of the regular succession of day and night, and there came into their heads the idea of the uninterrupted motion of the sun about the earth, of the succession of day and night on the other or lower side of the earth, and, as its direct consequence, that of the possibility that there, as here, animals and people may exist. I found it much easier than I expected to get the Gilyaks to believe that the earth is not a disk but a sphere.'

The stars also, in their opinion, revolve round the earth, just as the sun does. Indeed, in regard to the stars, the Gilyaks have got so far in their conception of the universe that they reckon them similar world-bodies to the earth, supposing that it is only their enormous distance that makes them appear so small. This can be seen from the fact that the words *ungkhyr*, 'star,' and *ungkhyr-mif*, 'star-earth,' are with them identical. For some of the constellations they have their special names: e.g., three stars in the tail of the Great Bear are called *charv(u)krich*; four others *nyagr-nyo*, 'the mouse's store.' A constellation with many stars, perhaps the Pleiades, is called on the Amur *lumr*, 'sable'; on Saghalien *tagkhr-nyo*, 'the store of the little beast (*Tamias striatus*),' and also *tamml-ungkhyr*, 'many stars.' Orion's sword is called *chekhvak*; the Milky Way, *taighopan-tif*, 'the unknown way'; and so on. One of the commonest questions of the Gilyaks concerns the existence of people on the stars. When Schrenck said that the stars are so far off that people on them, if they do exist, could not be seen even through a telescope, the Gilyaks always replied that the shamans do succeed in seeing them. According to the latter, it is positively known that upon the stars there grow tall trees and whole forests with plenty of all kinds of animals—sables, minks, foxes, bears, dogs—and, finally, people whom the Gilyaks call sometimes *ungkhyr-nibakh*, 'star-people,' sometimes *ungkhyr-mif-nibakh*, 'earth-star-people.' These people are of gigantic stature, with thick brows, long noses, and so on. The inhabitants of the earth occasionally meet the star-people, and the shamans know what to do in these cases.

6. Festivals, etc.—The bear-festivals take the first place. These are festivals for the rich, who secure the bears for this pastime. When the beast has been caught the hunters fetter him securely, and carry him home in triumph on a pair of sledges tied together. Old and young run out to meet him with joyful cries. In Gilyak villages there is nearly always to be found a place prepared for a bear; if there is none ready-made, it is erected without delay. This place consists of a square log-hut,

open above, with a small door fastened from the outside, and a small window-opening which is never closed. After dragging the bear into it by force and untying him, they cover the hut over with planks, and pile heavy stones upon these so that there is not the slightest possibility of the prisoner's escaping. From that moment the bear becomes the object of the care of the village, which is bound to look after him and supply him with food, so acquiring the right to participate in the bear-festival. Thus the bear-festival is entirely communistic. It unites all the members of the village, and thereby offers a kind of centre about which the whole village-life revolves. The day of the festival is commonly fixed by the original owner of the bear, i.e. the man who bought him or caught him at the time of the trapping. He also figures as the leader of the feast, keeping strictly to the customs consecrated by time. Besides the chief delicacy, bear-meat, the leader of the feast enriches the festive board with other culinary productions in the Gilyak taste. In his anxiety for greater splendour, he invites to the feast not only his kinsmen, but all his friends and acquaintances. After the close of the festival the bear's skin is allotted to the organizer of the feast. The feeding of the imprisoned bear proceeds according to well-established rule. The food is introduced through the window-opening; it consists of fish, raw or dried (*yukaly*), and *mosi*, a kind of thick gruel. At rare intervals the bear is brought out of his prison chiefly in order that the hut may be cleaned. Before he is put back into it, he is led round the village several times. The period for which the animal is kept depends upon his age. Grown-up bears are kept in captivity only a few months, but cubs for several years until they have grown and put on fat. Bear-festivals are celebrated in the winter months, as at that time of year the Gilyaks live on the mainland in roomy houses after the Chinese fashion. The greater part of the bear-festivals occur in the month *An'-long* (December). During the opening days of the festival the bear is led solemnly round the village; there is a farewell feeding of him; he is set up as a target; and, after he has been killed, he is cut up and skinned, and his head and skin are borne to the hut. The following days are given to feasting, games, contests, dances, singing, sledge-races, and other pastimes. Throughout the festival an original kind of music is incessantly produced by rhythmical blows of a stick on a hanging beam, to the accompaniment of humorous songs. The last act of the drama is the sacrifice of dogs, and the carting off of the bear's head and bones to the common resting-place for the remains of bears.

7. Religion.—The religion of the Gilyaks is pure Animism. Regarding all Nature as animate, they give to it a completely anthropomorphic expression. The island of Saghalien is regarded as a live creature, with its head at Cape Mary and its feet touching La Perouse Strait. Every more or less important headland or hill is a live creature, to which are attached many romantic and tragic legends of a purely human character. As he sees in inanimate objects of Nature a living anthropomorphic existence, the Gilyak takes a yet more anthropomorphic view of animals, regarding them as beings to whom are granted the highest reason and strength, and for whom the animal envelope is only a mask hiding a human being. Every element, every force of Nature, has its own lord, in all his attributes and social conditions similar to a Gilyak. These gods likewise, in their turn, occasionally take the form of some animal or another. The chief gods or 'lords' are the following: *Pal'-yz'*, the lord of the mountains, jungle, and all that lives in them; *Toll'-yz'*, the lord of the sea, an

old man with a long beard, who throws handfuls of fishes' roe about in all directions; *Tly-yz'*, the lord of the heaven; *Mif-yz'*, the lord of the earth; and others. All these lords are kindly beings, and to them from time to time sacrifices are offered in the shape of various sweet roots, rice, tobacco, etc. In more important cases the sacrifice is a dog. Often such sacrifices are performed in the jungle to the lord of the jungle, or on the sea or the river to the lords of these.

The Gilyaks believe in the existence of the soul, and in life after death. The soul is the man's double. After the death of its possessor it passes into the under world, through a special opening in the earth, and there continues exactly the same mode of existence as above ground. Poor people have one soul each, the rich and the shamans have two or three. In the underground world a man dies once more, and passes into yet another world, and so three times. The Gilyaks burn a dead man after dressing him in his best clothes (several suits). After the cremation they break his cauldrons and sledges and kill his dogs. Not far from the place of burning they set up a little house. In it they put a doll which represents the dead man, dressed up in precious stuffs. Above the doll they set a wooden representation of a cuckoo, and round about cups, plates, pipes, tobacco, sugar, and various things to eat. During the time immediately following death, before the dead man is settled in his new place, his kinsmen visit his little house at intervals, make libations, and present provisions.

Disease and death are regarded by the Gilyaks as the results of the wiles of an evil spirit, who either seizes the soul or gradually eats it away after having entered into the man's organism. The shamans are invited to drive this evil spirit forth. In social relations the shamans are not at all to be distinguished from common Gilyaks, but the gift of shaman-craft is ordinarily handed down from father to son.

The worship of idols among the Gilyaks must be regarded as borrowed from the Tungus tribes, Manguts, Gol'ds, and Orochi, and also from the Ainus. The Saghalien Gilyaks have scarcely any idols. Special reverence is paid to a representation of a bear which is kept in a toy-house, into which they also put a store of victuals—tobacco, sugar, etc.—and other things belonging to the sacred animal.

8. Language, oral literature, etc.—The Gilyak language stands lexically quite isolated among the languages of the old world; grammatically it is possible to compare it with certain American languages. It is full of special coronal and dorsal sounds, aspirates, nasal gutturals, and hissing sounds; its phonetics are among the most difficult to master of any language. The Gilyaks have no kind of writing. Their oral literature consists of: (1) heroic poems; (2) cosmogonic and mythological legends; (3) stories and tales of ordinary life; (4) historical traditions; (5) lyrical and humorous songs and catches. Their poems, though in prose form, are sung. The singing of Gilyaks takes the form of various guttural modulations and howlings, rarely passing into melodious chest-notes. The character of their singing has been influenced by the shaman's chants. The singers are supposed to be helped by a special spirit, who has his seat in the tip of the tongue. Poems are, for the most part, inspired improvisations. In the songs and poems are the rudiments of dramatic scenes. The Gilyaks delight in sitting up whole nights through, listening to improvisers, with perfect faith in the reality of what is being related. They delight in playing on home-made instruments, one-stringed guitars, pipes, and such like; and lately they have even

learned to play the accordion. They are eager for knowledge, and possess remarkable mental ability. Even in the poorly equipped missionary schools they make quick progress in learning. They gladly adopt from the Russians everything which is useful and applicable to their way and conditions of life. In many places they have learned to salt fish, plant potatoes, breed horses, and earn a living as drivers. Their capacity for adapting themselves to new conditions of life gives them every chance of preserving their nationality.

LITERATURE.—L. von Schrenck, *Reisen und Forschungen im Amurlande in den Jahren 1854-56*, vol. iii. pts. i. ii., St. Petersburg, 1881, 1891; Zeeland, 'The Gilyaks' (Russian), *Bulletin (Izvestia) of the Soc. of Lovers of Natural Science*, vol. xlix. pt. iii., 1886; L. Sternberg, 'The Gilyaks of Saghalien' (Russian), *Ethnogr. Review (Etnograficheskoe Obozrenie)*, 1893, pt. ii., also 'A Journey to the Extreme North of the Island of Saghalien' (Russian), *Saghalien Kalendar and Materials for the Study of the Island of Saghalien*, 1895; C. H. Hawes, *In the Uttermost East*, London and New York, 1903; J. Deniker, 'Les Ghiliaks,' *REth* ii. (1883) 289-310. D. KLEMENTZ.

GIPSIES.—See GYPSIES.

GIRDLE.—A girdle in its modern sense is a belt or cord used to encircle the waist. In ancient times, however, the girdle had a much wider signification, and was employed not only as an article of clothing, but also as a sacrificial ornament, and as an amulet. The reason for its adoption by primitive races as an article of clothing is not far to seek, the waist being a natural means of support for the clothing of the lower parts of the body (see art. DRESS). When we attempt to explain the origin of its use in sacrifice, the question becomes more difficult and leads back to mythical times. Its use as an amulet for the cure of disease, and as an aid in childbirth, is so universal that it must be, like the former, of great antiquity; and, although the evidence at hand is somewhat fragmentary, it is probable that the amulet girdle was originally derived from the sacrificial cord of mythical times.

I. Girdles as articles of clothing and adornment.—On account of the fact that the girdle is so generally distributed amongst peoples as a support for the lower garments, it is impossible to give more than a bare outline of the subject. Among the Egyptians in very early times a girdle was employed above the loin-cloth, and to it was fastened either a tail of some animal or an imitation made of leather.¹ Girdles are also indicated in the sculptures as far back as the IInd and IIIrd dynasties.² The ancient races of India appear to have employed the girdle in dress, and richly embroidered girdles still persist in Indian costumes; in ancient Norse mythology, e.g. Frigga's golden girdle,³ and amongst the Chaldæans and Babylonians (Ezk 23¹⁵) reference is also made to them.

Coming to Biblical girdles, it is necessary to point out that in the EV the word 'ezôr is frequently translated 'girdle,' whereas it is more properly rendered 'loin-cloth.' Such were the 'girdles' of Elijah and John (2 K 1⁸, Mt 3⁴, Mk 1⁶).⁴ The true girdle of the Bible consisted of a long strip of cloth wound round the waist above the tunic, with or without the ends hanging down in front; but, in other cases, it varied from a simple rope (Is 3²⁴ RV) to the elaborate waist-belts of the priests and the 'golden girdles' of Rev 1⁸ 15⁶. The 'curious girdle of the ephod' (*hêshebh' 'aphud-dâthô*) was 'of gold, of blue and scarlet, and fine twined linen' (Ex 28⁸); it was wound several times round the waist and tied in front, the ends

¹ *Guide to Egyptian Collections, Brit. Mus.* (1909), p. 81.

² *Ib.* pp. 192, 194 (illus.); *Guide to 1st and 2nd Egypt. Rooms, Brit. Mus.*² (1904), pp. 40, 42 (illus.).

³ H. A. Guerber, *Myths of the Norsemen*, London, 1908, p. 42.

⁴ *SDB*, art. 'Dress,' § 2 (a), p. 106.

falling to the ankles.¹ The girdle also served as a sword-belt (2 S 20^b); as a purse (Mt 10^a RVm); and as a support for the inkhorn (Ezk 9²¹, 11). The application of the girdle in most cases in the Scriptures is used to indicate the completeness of the dress and readiness for action—e.g. 'gird thyself and serve me' (Lk 17^b).

Amongst the Romans, the girdle consisted of linen,² and was used to confine the *tunica*. It was worn by both sexes, and also formed part of the dress of the soldier and gymnast. The Grecian athletes also wore girdles in the games,³ and Hercules is depicted at Olympia as 'wrestling from the Amazon her girdle.'⁴ Among both Greeks and Romans the girdle was the usual receptacle for money. The *cinctus Gabinus* (so named from the town Gabii) was the term applied to the method used by the early Romans in warfare of wearing the toga, the end of which, instead of being thrown over the left shoulder, was drawn tightly round the body as a girdle, thus leaving the arms free.⁵ In Tibullus we read that at funeral ceremonies the garments were to be ungirdled.⁶ Gallo-Roman graves seldom contain girdles; on the other hand, beautifully ornamented girdles were found in those of the Franks and Burgundians. The Arch-Druids were clothed in a stole of virgin white, fastened by a girdle on which appeared the crystal of augury encased in gold,⁷ and the ancient Kings of Ireland on state occasions wore golden girdles inlaid with precious stones.⁸ Not till after the Norman Conquest, however, did the Anglo-Saxons adopt the girdle generally as a dress essential for both sexes. In the later 13th cent. the knight's surcoat was girdled at the waist with a narrow cord, and the great belt looped across the hips to support the sword. In the 14th cent. the girdles were worn somewhat below the waist, and were of exceedingly rich design. To the girdles of the 15th and 16th cent. were attached all the paraphernalia of the wearer, e.g. purses, daggers, keys, inkhorns, books, etc.; and laws were introduced to stop these extravagances: thus, priests were censured for wearing silver girdles with baselards hanging from them.⁹ In Skye 200 years ago we find that girdles were used to support the plaid, and the custom was, doubtless, general in the West at that time.

¹ The belt was of leather and several pieces of silver intermixed with the leather like a chain. The lower end of the belt has a piece of plate about eight inches long and three in breadth curiously engraved; the end of which was adorned with fine stones or pieces of red coral.¹⁰

Amongst curious customs in regard to girdles we find that bankrupts used to remove them in open court, that in France courtesans were forbidden to wear them, while the expression 'belted earl' is derived from the ceremonial of the investiture in olden times.¹¹

Girdles are still used by many Continental peoples, who preserve their national customs, e.g. in Macedonia, Sicily, Brittany, and Norway. In German New Guinea, a girl is invested with the girdle only on reaching maturity,¹² and similar customs prevail in many lands. As an illustra-

¹ SDB, art. 'Dress,' § 3, p. 197.

² Nettleship-Sandys, *Dict. of Class. Antiquities*, 1908, p. 148

³ Pausanias's *Descrip. of Greece*, tr. J. G. Frazer, 1898, i. xlv. l.

⁴ *Id.* v. x. 9.

⁵ Nettleship-Sandys, p. 640; cf. Pauly-Wissowa, iii. 2558.

⁶ Tibullus, iii. ii. 18; cf. Suetonius, *August. Octavianus*, 100.

⁷ M. Arnold, *Study of Celtic Literature*, passage from D. W. Nash's 'Tallesin.'

⁸ E. Hull, *Pagan Ireland*², Dublin, 1908, p. 94.

⁹ *EBR*¹¹, 1910, xii. 47, art. 'Girdle'; J. Brand, *Popular Antiquities*, new ed., London, 1900, p. 374.

¹⁰ M. Martin, *Descrip. of Western Islands of Scotland*², Lond. 1716, p. 209.

¹¹ *EBR*¹¹, i. c.

¹² R. W. Williamson, 'Melanesia,' p. 26 f., in *Customs of the World*, ed. W. Hutchinson, London, 1912-13.

tion of the various girdles in use as articles of dress the following may be cited: in Norway, fine old filagree silver girdles are preserved as heir-looms; the Lapps wear belts adorned with bear's teeth; the Uled-Nail women use a simple cord; the Swazis, Basutos, and Zulus, a beautifully embroidered band; Sarebas Dya women, hoops of rattan.¹ The girdle-wearing custom is also prevalent in the New World.

2. Girdles used in sacrifice and in religious ceremonies.—The earliest form of the sacrificial girdle was probably a cord worn round the waist by the priests. Later, it was worn on the right shoulder, and, finally, on the left shoulder. Such girdles, we shall see, can be traced in India, Umbria, and Mexico.² The structure of these sacrificial girdles and the part they play in the religious initiation ceremonies of various nations form a most interesting and comprehensive study in astrology and mythology, which would repay thorough investigation.

In the Zoroastrian ritual the sacred *kusti*, or girdle, with which every Zoroastrian child, whether boy or girl, is invested when about fifteen years of age,

'consists of a string, about the size of a stay-lace, which is first passed twice round the waist very loosely, over the sacred shirt, and tied in front with a loose double knot (right-handed and left-handed), and the long ends are then passed a third time round the waist and tied again behind with a similar double knot. This string contains six strands, each consisting of twelve very fine, white, woollen threads twisted together, or seventy-two threads in all. Near each end the six strands are braided together, instead of being twisted, and for the last inch they are braided into three separate string-ends of two strands each; these string-ends, therefore, contain twenty-four threads each, and form a kind of fringed end to the string. This fringe is a sort of remembrancer, as its six strands are supposed to symbolize the six Gahanbars or season-festivals, the twelve threads in each strand symbolize the twelve months, the twenty-four threads in each string-end symbolize the twenty-four kardaks or sections of the Visparad, and the seventy-two threads in the whole string symbolize the seventy-two hás or chapters of the Yasna.'³

The importance of the girdle in India is shown by the fact that its assumption, before which no religious rite may be performed, is the second birth.⁴ The rules regarding the northern Indians are noted below;⁵ among the southern Dravidian Brāhmans the girdle is made of three strands of cotton, in each of which are nine threads;⁶ and, similarly, a three-knotted girdle is worn by the Dervishes of S.W. Asia.⁷ The Vedic Brāhmans wear the girdle over the right shoulder, but during funeral ceremonies, when the customs connected with the living are frequently reversed for the dead (*ERE*, vol. iii. p. 658, vol. iv. p. 439^b, vol. v. p. 60), the girdle is removed to the left shoulder.⁸ At the annual May procession of the boundaries at Iguvium (Gubbio), a sacred girdle (*cringatiro*) was worn on the right shoulder.⁹

For different castes the girdle is of different materials.

'The girdle of a Brahman is to be made of a triple cord or *muñja* [*Saccharum munja*], smooth and pliable; but of a Kṣatriya it (should be) a bowstring of *mūrvā* [*Sansevieria Zeylanica*]; of a Vaiśya, a triple thread of hemp. If *muñja* cannot be had, (their girdles) are to be made of *kūṣa* [*Poa cynosuroides*], *atmāntaka* [*Bauhinia tormentosa*] (or) *valvaja* [*Eleusine indica*], threelfold, with one knot, (or) three, or even five.'¹⁰

The girdle of the Brāhman is composed of 3

¹ *Living Races of Mankind*, ed. H. N. Hutchinson, 2 vols., London, n.d., where many illustrations of girdles may be found.

² J. F. Hewitt, *Primitive Traditional History*, London, 1907, ii. 988.

³ West, *SBE* xviii. [1882] 122, note.

⁴ Manu, ii. 169-171.

⁵ For full references, see A. Hillebrandt, 'Rit.-Lit.' (*GIAP* iii. 2 [1897] 52).

⁶ Dubois-Beauchamp, *Hindu Manners, Customs, and Ceremonies*², Oxford, 1906, p. 160 f.

⁷ J. O'Neill, *The Night of the Gods*, London, 1893-97, i. 127.

⁸ *SBE* xii. [1882] 363, 423, 424, note 2, 428-433; cf. xxx. [1892] 16, 17, 251.

⁹ *Tab. Iguv.* ii. b 27, 29, vi. b 49.

¹⁰ Manu, ii. 42

strands of cotton formed of 9 threads, and the material must be gathered and spun by pure Brāhmins. After marriage the cord must have 6 strands, and may have 9; the months of March-June are the most favourable for the investiture, and begging is permitted to defray the heavy expenses of the ceremony.¹ The initiation with the girdle took place at 8 years old in the case of Brāhmins, at 11 years with Kṣatriyas, and at 12 years with Vaiśyas.² The following is the formula used at the ceremony:

'Here has come to us, protecting us from evil words, purifying our kin as a purifier, clothing herself, by the power of inhalation and exhalation, with strength, this friendly goddess, this blessed girdle.'

With these words thrice repeated, the girdle is tied from left to right thrice round; there should be one knot or three or five, and it is finally adjusted with the words: 'The sacrificial cord art thou. With the cord of the sacrifice I invest thee.'³ Further, the student has to repeat the verse 'Protecting us from evil word' and 'The protectress of right'; the initiator then makes a threefold knot in the girdle at the north side of the navel, and draws that to the south side of it.⁴ At funeral ceremonies the relatives of the dead wear their sacrificial cords.⁵ The Brāhmin who has been invested with the triple cord is called a *Brahmachāri*; the cord is called *yajñopavita* in Sanskrit, *jandemu* in Telugu, *punul* in Tamil, and *jenivara* in Canarese.⁶ Other Hindus share with the Brāhmins the honour of wearing the cord, e.g. the Jains, the Kṣatriyas, the Vaiśyas, and even the Panchalas.⁷

The oldest extant charm for a girdle is contained in *Atharvaveda*, vi. 133, and runs as follows:⁸

'The god that bound on this girdle, that fastened [it] together, and that joined [it] for us, the god by whose instruction we move—may he seek the further shore, and may he release us.

Offered to art thou, offered unto; thou art the weapon of the seers; partaking first of the vow, be thou a hero-slayer, O girdle.

Since I am death's student, soliciting from existence a man for Yama, him do I, by incantation, by fervour, by toil, tie with this girdle.

Daughter of faith, born out of fervour, sister of the being-making seers was she; do thou, O girdle, assign to us thought, wisdom; also assign to us fervour and Indra's power.

Thou whom the ancient being-making seers bound about, do thou embrace me, in order to length of life, O girdle.'

Girdles were in use for religious purposes in the Greek and Roman liturgy, and Anastasius mentions in the 9th cent. *murænula*, or jewelled girdles in the shape of lampreys or eels.⁹ Zodiacal amulets in the form of girdles were known to the early Christians,¹⁰ and the girdle of the ephod must be again referred to (see above); its end when the priest was engaged in sacrifice was thrown over his left shoulder.¹¹ As early as the 5th cent. Pope Celestine (423-432) deprecated the frequent use of the girdle by the priests as an article of adornment and distinction in their dress.¹² Some mention must be made of the *orarium*, a kind of scarf worn on the left shoulder and passing diagonally downwards to the right side; it was permitted to be worn by the Romans as a favour by Aurelian. The fourth Council of Toledo directed that the *orarium* should be worn by deacons over the left shoulder.¹³ The application of the *pallium*, which was used as early as A.D. 514—in its earliest form a narrow strip of cloth, passed over the left shoulder,

¹ Dubois-Beauchamp², 160 f.

² *SBE* xxix. 58 f., xxx. 63.

³ *Ib.* xxx. 67, 148.

⁴ Dubois-Beauchamp², 160.

⁵ *Atharvaveda*, tr. Whitney-Lanman, Cambridge, Mass., 1906, p. 330 f.

⁶ Addis-Arnold, *A Catholic Dictionary*⁶, London, 1903, p. 403.

⁷ Martigny, *Dict. des antiquités chrétiennes*, Paris, 1865, art. 'Zodiaque.'

⁸ R. A. S. Macalister, *Ecclesiastical Vestments*, London, 1896,

p. 4.

⁹ *Ib.* p. 28.

¹⁰ *Ib.* xxix. 61 f.

¹¹ *Ib.* xxix. 238.

¹² *Ib.* 169.

¹³ *Ib.* pp. 34-40

then round the neck and over the left shoulder again, leaving the two ends free, one in front and one behind¹—seems to the present writer to be connected with the *orarium*.

The girdle in its final form as an ecclesiastical vestment is a narrow band, usually and properly made of silk, but sometimes of cotton; white as a rule, it may be coloured. The esoteric meanings attached to it are: 'custodia mentis; discretio omnium virtutum; virtus continentiae; perfecta Christi caritas.' Properly it is about four yards long, and is used to secure the alb, the upper portion of which depends over and often hides the girdle.² The 'stole' is the successor of the *orarium*, and consists of a strip of embroidery 2-3 in. wide, and latterly terminating in a cross.³ Deacons wear it over the left shoulder and secure it under the right arm, while priests cross it over the breast.⁴ The 'pall' is also probably derived, through the *pallium* and stole, from the girdle, while the *subcingulum*, now worn only by the Pope, was originally a girdle with a lozenge-shaped lappet depending on either side of it.⁵

In the Orthodox Greek Church the *ζώνη*, in the Armenian Church the *kodi*, and in the Malabar the *zunro*, are all girdles; and other vestments used in their ceremonies show traces of girdle origin.⁶ The girdle is also an important article in the dress of many religious orders. It is often of black leather, although a simple cord or rope is also common.⁷

The above sketch of the part played by the girdle in sacrifice is by no means exhaustive. Little attention has been paid so far to the significance of the girdle in vestments; and attempts to trace the various metamorphoses which have taken place in its descent from mythical times are often vitiated by the omission by authors of accurate descriptions of the girdles and their mode of application.

Sympathetic magic appears in connexion with the girdle in the Germanic belief that a man can change himself into a werwolf (*q.v.*) by donning a belt of wolf's skin.⁸ According to Mahmūd Shabistari, who wrote his *Gulstan-i-Rāz* ('Rose Garden of Mystery') in A.H. 717 (A.D. 1317), the girdle signifies to the Sūfi 'the binding of the bond of obedience,' so that 'the knotted girdle is the emblem of obedience.'⁹ Perhaps influenced in part by some such passage as Is 11⁵ ('righteousness shall be the girdle of his loins, and faithfulness the girdle of his reins') or Eph 6¹⁶ ('having girded your loins with truth'; cf. also Ps 18³²⁻³³ 30¹¹ 65⁶), an Irish monk in Austrian Klosterneuburg wrote the curious hymn which may also contain some reminiscences of the pagan Celtic period:¹⁰

'The girdle (*cris*) of Finnen is round about me, to protect me, that I walk not the way which encircleth the people; . . . against disease, against anxiety, against the charms of foolish women. . . . The girdle of John is my girdle, . . . it putteth to shame the wrath of men, it averteth the charms of women. The girdle of the serpent is my girdle, the serpent is about me that men may not wound me, that women may not destroy me; to the stars it hath exalted me; at my hour it is about me.'

3. Girdles used as amulets for the cure of disease and for facilitating childbirth.—(a) *For the cure of disease.*—Girdles used as amulets for curing diseases are to be met with in many countries, and are employed in the treatment of multifarious conditions. No doubt they originally had some religious signification, but in the majority of cases this has been completely lost. Four in-

¹ R. A. S. Macalister, p. 47.

² *Ib.* p. 70.

³ *Ib.* p. 73.

⁴ *Ib.* pp. 96, 105-108.

⁵ *Ib.* pp. 235-253.

⁶ E. H. Meyer, *Germ. Myth.*, Berlin, 1891, p. 69; Chantepie de

la Saussaye, *Relig. of the Teutons*, London, 1902, p. 298.

⁷ Tr. E. H. Whinfield, London, 1880, pp. 83, 85.

⁸ Zeuss-Ebel, *Gramm. Celt.*², Berlin, 1871, p. 954 f.

stances may be cited as examples of their use. The natives of the Island of Harris wore a girdle of sealskin about the waist for removing sciatica; and in Aberdeenshire one was employed to cure 'chin-cough' (whooping-cough). In Ardnurchan to this day, when a child is born, a rope of grass is wound round it to keep away many diseases; an incantation is used, and the grass must be pulled, not cut; some place the rope round the neck and chest in the form of a cross; and it is finally cut into nine pieces and flung into the wine.¹ Among the Niam-Niam and Gour Tribes of Bahr al-Ghazal in Southern Egypt, a tight cord is placed round the chest of a man suffering from pleurisy; to the cord cylindrical wooden charms are attached.² These must suffice as typical illustrations of the wide distribution of such beliefs and of the variety of conditions in which they are employed.

(b) *In pregnancy and childbirth.*—The application of the girdle during pregnancy and labour forms a curious ethnological problem. It is well known that the popular idea in most nations is that everything must be unloosened in these contingencies: thus, husbands must not sit with their legs crossed, doors must be opened, knots of all kinds undone, and the hair even loosened. Whether the girdle idea arose as an offshoot of the sacrificial girdle or as a simple means of applying *vis a tergo*, one is not prepared to say with certainty, but the preponderance of evidence is in favour of the religious origin, as we shall attempt to indicate.

In the Brāhman marriage rites the bride is invested with a red and black woollen or linen cord with three amulet gems; this is not the sacrificial cord, which women were not allowed to wear.³ In popular Hindu birth-customs, a charm is bound about the belly of a woman in labour; this charm consists of an equilateral triangle or a collection of magic words arranged in three rows of three.⁴ In an Assyro-Babylonian fragment in the British Museum an incantation recited for a pregnant woman mentions 'binding being relieved.'⁵ The Bab. Ištar is goddess of the pregnant and of those in labour, and carries as symbol the womanly girdle; Ištar is, let it be noticed, comparable with Aphrodite and Frigga. Among the Greeks, a birth was forwarded or retarded by divine beings, the Eileithyiai, handmaids of Hera; there seem to have been two Eileithyiai, one advantageous and one unpropitious.⁶ According to Theocritus,⁷ the former is called 'the girdle-loosing' (λυσίλωπος). Later the two Eileithyiai were merged into one, who became the Roman Lucina. The Troezenian maidens had before marriage to dedicate their girdles to Apaturian Athene;⁸ and Athenian women pregnant for the first time hung up their girdles in the temple of Artemis.⁹ The Roman ladies bound the abdomen with a waistband-like girdle from the eighth month of pregnancy, and these bandages were probably made near the image of some god;¹⁰ the girdle was loosened at the confinement; hence the goddess of birth came to acquire the epithet *Solvizona*, 'the girdle-

loosing.' In some cases the husband seems to have tied and unloosened the girdle.¹

It will have been perceived by this time that two or three variations of custom exist in regard to these girdles. In some cases, the girdle is applied during labour as a charm, in others as a means of pressure, and it is also applied, probably as a support to the abdomen, in the later months of pregnancy, and removed when labour approaches. This introduces us to an interesting philological curiosity connected with the last variety. The Latin word *incincta* means 'girded,' sometimes 'ungirdled,'² and, in the vulgar tongue, 'a pregnant woman'; from this is derived the Italian *incinta*, 'pregnant,' Spanish *estar encinta*, 'to be pregnant,' French *enceinte*, 'pregnant,' and probably German *entbinden*, 'to unloosen,' and 'to deliver.' These words furnish excellent confirmatory evidence of the fact that the girdle played a most important part in pregnancy in early times. Amongst the Jews a girdle made of snake's skin or that of a she-ass was worn to prevent mishaps at birth, and the Turkish women hold similar beliefs;³ compare with the Jewish custom that of Brandenburg women, which consisted in binding the abdomen with a snake's skin to gain an easy delivery.⁴

The same beliefs are prevalent amongst the less civilized races; thus, in China, a belt is used during pregnancy and loosed at labour; the Japanese women wear a long and flowing silken girdle, and the custom is said to have been originated by the Empress Djin-go-Kogu about A.D. 200. The fifth month is selected for its application, and a girdle belonging to a woman who has had easy confinements is favoured and, therefore, borrowed, such a woman being referred to as 'the girdle-mother'; after the birth, part of the girdle is used to make some of the child's clothing.⁵ The Kalmuks, nomads of Mongolian race, buckle broad leather belts around the abdomen of the patient as soon as labour begins, and use pressure from above downwards;⁶ and the Burmese women wear a tight bandage from the 7th month onwards to prevent the child ascending too far.⁷ The central Australian tribes have curious modifications of these customs. A certain stone is believed to contain the spirits of children; by visiting it a woman becomes pregnant; and, by tying his girdle round the stone, a man can cause his wife to be with child. Again, the Arunta husband removes his hair girdle, which is then tied tightly round the woman just under her breasts, probably with the idea of expelling the child.⁸ During a Zulu confinement a grass rope is tightly fastened round the middle of the woman to prevent the child slipping up again;⁹ and, to judge from an illustration, the girdle is also worn during pregnancy.¹⁰ The Bantus of South Africa employ the girdle as an amulet for easy delivery.¹¹ A very curious girdle is used by the Shangaan women of Portuguese East Africa; it is of woven fibre, hinged in the middle so as to resemble a pair of callipers; but, as its height is only 6-7 in., one fails to understand how it is ap-

¹ M. Martin, 65.

² Information given by Rev. Angus Macdonald, Ullapool.

³ *Wellcome Tropical Research Laboratories 4th Report*, vol. B, plate xvii. fig. 68 (1911).

⁴ *SBE* xxix. 33; *Rigveda* x. 85, 28.

⁵ *Ib.* xxx. 44 n.

⁶ Cf. art. BIRTH (Hindu, Popular), vol. ii. p. 652; cf. G. J. Engelmann, *Labor among Primitive Peoples*, St. Louis, 1888, p. 6.

⁷ Cf. art. BIRTH (Assyro-Babylonian), vol. ii. p. 644.

⁸ Ploss-Bartels, *Das Weib*, ii. 16.

⁹ Homer, *Il.* xi. 270, xvi. 187, xix. 119.

¹⁰ Theocritus, xvii. 60; cf. *ERE* ii. 648.

¹¹ Pausanias, ii. xxxiii. 1.

¹² E. S. Hartland, *LP*, 1895, ii. 224.

¹³ Ploss-Bartels, i. 852; *ERE* ii. 649.

¹ Pliny, *HN* xxviii. 29; Tertullian, *de Anim.* xxxix.

² Tibullus, iii. ii. 18; cf. J. P. Postgate, *Selections from Tibullus*, London, 1903, pp. 146, 221.

³ *ERE* ii. 657; cf. Bernard Stern, *Medizin, Aberglaube, und Geschlechtsleben in der Türkei*, Berlin, 1903, i. 270, 274, 289, 290.

⁴ A. Engelen and W. Lahn, *Der Volksmund in der Mark Brandenburg*, Berlin, 1869; Ploss-Bartels, i. 858; cf. Brand, p. 332.

⁵ Ploss-Bartels, i. 854-856; cf. A. B. Mitford, *Tales of Old Japan*, London, 1871, vol. ii. app. B, p. 260.

⁶ Engelmann, 208.

⁷ *Ib.* p. 5.

⁸ *Customs of the World*, p. 178; Spencer-Gillen, pp. 338, 467.

⁹ *Brit. Med. Journ.*, 28 Oct. 1911, p. 1144.

¹⁰ *Living Races of Mankind*, ii. 303.

¹¹ Bastian, *Loango-Küste*, Jena, 1874-75, i. 173, 176; *ERE* ii. 866.

plied.¹ The practice is general among the American Indians, where the idea again seems to be pressure; the 'squaw belt' used by the Sioux Indians is of leather 4 in. wide, and has three buckles.² In Macedonian folklore, if one's girdle becomes undone, some woman of the family has just been delivered, and it is also an omen of easy delivery; girdles have also a place in their marriage ceremony.³

In historic times, and particularly among Catholic peoples, the belief in the efficacy of girdles in difficult labour has been, and is probably still, rife. In France, the girdle of St. Oyan; in England in 1159 that of St. Joseph, and that of the Abbot Robert of Newminster; and of the Holy Margareta in Swabia, have all been used for this purpose. In Germany a cord the length of the standing image of St. Sixtus was used about the 14th century.⁴ Spanish women tied their girdles or shoe-latchets about one of the church-bells, and struck the bell thrice.⁵ Further, we find in 1502, under the expenses of Elizabeth of York, a sum of money paid 'to a monke that brought our Lady gyrdelle to the Quene,' and the note that 'it was probably a relic from a monastery for her to put on in labour, as it was a common practice for women in this situation to wear blessed girdles.' Sometimes a long scroll containing the Magnificat was used. Dr. Leighton writes in a letter to Lord Cromwell (1537): 'I send you also Our Ladys Girdle of Bruton red silke, a solemn relike, sent to women in travail.' Other charms of a like nature were bound to the thigh.⁶

In the *Battle of Lora*, by Ossian (James Macpherson), the passage occurs:

'An hundred girdles shall also be thine, to bind high-bosomed maids, the friends of the births of heroes, the cure of the sons of toil.' Macpherson adds a footnote stating that 'Sanctified girdles, till very lately (1761), were kept in many families in the north of Scotland; they were bound about women in labour, and were supposed to alleviate the pains and to accelerate the birth. They were impressed with several mystical figures; and the ceremony of binding them about the woman's waist was accompanied by words and gestures which showed the custom to have come from the Druids.'

In commenting on this note, Laing believes that they were girdles consecrated by Irish saints and not by Druids,⁷ and one is inclined to homologate his criticism. These girdles still exist. Thus, in 1911, Henderson states that they are 'sometimes still worn by pious women . . . to "sain" the expected child as well as the mother from all harm, and to attach all good spiritual powers on her side.'⁸ That they are kept secret is evident, as the present writer has corresponded with several Highland medical men, none of whom can trace one.

Another modern survival of the custom exists in Brittany, where the Ursuline nuns of the Quintin convent send to any of their pupils who have married a girdle of white silk which has been touched by a relic of the Virgin and inscribed in blue letters with the words 'Notre Dame de Délivrance, protégez-nous.' The recipient hastens to put it round her body and compresses herself with it.⁹

Lastly, to bring the subject down to the present

¹ Anthropological Museum, Aberdeen Univ., Africa No. 243, Cat. 331.

² Engelmann, 25, 84, 91, 139, 160, 187.

³ G. F. Abbott, *Macedonian Folk-Lore*, Cambridge, 1903, pp. 99, 170 f.

⁴ Ploss-Bartels, l. 857; V. Fossel, *Volksmedizin . . . in Steiermark*, Graz, 1885; E. S. Hartland, *LP* ii. 225.

⁵ E. S. Hartland, *LP* ii. 224.

⁶ W. C. Hazlitt, *Dict. of Faiths and Folklore*, London, 1905, ii. 378; cf. Brand, p. 333.

⁷ *The Poems of Ossian*, by James Macpherson, with notes and illustrations by Malcolm Laing, Edin. 1805, i. 283.

⁸ G. Henderson, *Survivals in Belief among the Celts*, Glasgow, 1911, p. 335; cf. Sir W. Scott, *Letters on Demonology and Witchcraft*, London, 1830, p. 150.

⁹ L. Bonnemère, 'Une Ceinture bénie,' *BSAP*, vol. ix. ser. iii. (1886) p. 753; cf. E. S. Hartland, *LP* ii. 225.

day, the writer met with one of those girdles in Dublin; it was an ordinary leather belt, old and greasy, about 1½ in. broad and possessing an iron buckle; it was applied loosely round the patient's chest, and the writer was assured that it would hurry up matters; this it probably did, although the action must have been purely a psychological one. On inquiry of the person who owned it, no information could be got; but subsequently it was ascertained that it was a belt worn by people who are enrolled in a society of St. Augustine, and helps them in times of sickness and childbirth.

LITERATURE.—This is fully given in the footnotes. For further information, reference may be made to the work by Ploss-Bartels, *Das Weib*, Leipzig, 1885, frequently cited, and to an article by the present writer in the *Caledonian Medical Journal*, ix. (1913).

WALTER J. DILLING.

GIRNAR.—A sacred hill and place of pilgrimage of the Jains, with numerous ruined temples, situated in Kāthiāwār, Bombay; N. lat. 21° 30', E. long. 70° 42'. The hill reaches a height of about 3500 feet above sea-level, and includes five peaks, one of which was, till recently, a haunt of the loathsome ascetic Aghoris (*q.v.*). In the opinion of the Jains, the sanctity of the place is second only to that of Pālitāna, because it is associated with Neminātha, the twenty-fourth of their Tīrthānkaras, or deified saints. A rock at the foot of the hill is engraved with a copy of the edicts of Aśoka (*q.v.*; cf. V. A. Smith, *Asoka*², Oxford, 1909, p. 129 f.), and two other inscriptions—one of the Satrap Rudradāman (*c. A.D.* 150), recording the construction of the Sudarāna tank; and a second its destruction and repair in A.D. 458 (V. A. Smith, *Early Hist. of India*², Oxford, 1908, pp. 129 f., 290).

The original name of the mountain was Raivata or Ujjayanta; and the Buddhist pilgrim, Hiuen Tsiang, describes it under the Pāli form of the latter title, Yuh-chen-to or Ujjanta (S. Beal, *Buddhist Records of the Western World*, London, 1884, ii. 269). The Jain temples, the largest of which is that dedicated to Neminātha, are fully described by Burgess in his Report. On the verge of the hill, at some distance from these temples, is the huge isolated rock, known as Bhairava-jāp, 'the place where charms are recited in honour of Bhairava,' Śiva in his destructive form. In former days, fanatics used to hurl themselves down the precipice, in the hope of gaining immediate entrance into the paradise of Śiva (cf. Crooke, *PR* ii. 169). Another interesting temple is that dedicated to Ambā Mātā, the Mother-goddess, now one of the many forms of Umā or Pārvatī, the consort of Śiva (see DURGĀ). Here newly-married Brāhman couples resort, have their clothes tied together, and present coco-nuts and other offerings to the goddess, in the hope that she will secure for them a continuance of wedded felicity.

LITERATURE.—The place is fully described by J. Burgess, 'Report on the Antiquities of Kāthiāwār and Kachh,' in *ASW* ii. [1876] 93 ff. Some further information is given in later *Progress Reports of the W. Circle*, esp. that for 1898-99, p. 15; see also *IGI* xii. [1908] 247 f.; *BG* viii. [1884] 441 ff.

W. CROOKE.

GLASITES (SANDEMANIANS).—A Christian sect founded by John Glas (1695-1773), and his son-in-law, Robert Sandeman (1718-1771). Glas was born at Auchtermuchty, in Fife, where his father was parish minister. He graduated at St. Andrews, and studied for the ministry at Edinburgh. Licensed by the presbytery of Dunkeld, he was ordained as minister of Tealing (1719), and soon attracted large congregations by earnest and effective preaching. He was led early in his ministry to study the Scripture doctrine of the Church, through 'being brought to a stand,' while lecturing on the Catechism, by the question, 'How doth Christ execute the office of a king?' The result

of his inquiry appeared as early as 1725 in the forming of a society 'separate from the multitude,' drawn from his own and neighbouring parishes. Glas taught that there is no authority in the NT for a National Church, or for a National Covenant, such as then existed in Scotland. He maintained that the magistrate as such has no function in the Christian Church, and that the use of political and secular weapons as a means of reformation, instead of the word and spirit of Christ, is wholly wrong. This is the argument of his most famous treatise (Edinb. 1727), *The Testimony of the King of Martyrs concerning His Kingdom*. When it became apparent that Glas was teaching the Scriptural authority of Independency he was summoned before his presbytery. In 1728 he was suspended from the discharge of ministerial functions, and in 1730 he was deposed.

As the members of his congregation adhered to him, the first 'Glasite' church was formed, and Glas ministered to communities of this order in Dundee, Edinburgh, and Perth. They observed the primitive custom of the kiss of peace; and the Agape was celebrated as a common meal with broth. From this custom they became known as the 'kail kirk.' Although the General Assembly removed the sentence of deposition which had been passed, Glas remained an Independent minister to the end.

At Perth, Glas was joined by Robert Sandeman, who had become his son-in-law. Sandeman gradually became the recognized leader of the churches of the order. He was responsible for drawing the charge of antinomianism on the Glasite churches. He taught 'that the bare death of Jesus Christ, without a thought or deed on the part of man, is sufficient to present the chief of sinners spotless before God.' He maintained that justifying faith is a simple assent to the Divine testimony concerning Jesus Christ, differing in no way from belief in any ordinary testimony.

Owing to Sandeman's prominence, the Glasite churches became known as 'Sandemanian.' Diligent endeavours were made to make these churches the exact reproduction of the NT type. Elders, pastors, or bishops, who were all equal, were chosen without regard to education or occupation. Second marriage was a disqualification for office. There was a weekly observance of the Lord's Supper, and a love-feast at which every member had to be present. The members at one time washed one another's feet. Things strangled and blood were prohibited as articles of food. Decisions of the church must be unanimous. The accumulation of wealth was regarded as unscriptural, and therefore wrong, and each member considered his property as liable to be called upon at any time to meet the wants of the poor or the necessities of the church.

There were about a dozen Glasite or Sandemanian churches in Scotland, and a few in England and America. Michael Faraday was for many years a member of the Sandemanian Church in London. The most rigid churches of the order have now become extinct, and most of the members have joined the Scottish Congregational or Baptist Churches.

LITERATURE.—G. Grub, *Eccles. Hist. of Scotland*, Edinb. 1861, iv. 55; J. B. Marsden, *Hist. of Christian Churches and Sects*, Lond. 1856, ii. 297 ff.; W. Wilson, *Hist. and Antiquities of Dissenting Churches*, Lond. 1808-14, iii. 261 f.; the *Works of John Glas*, 4 vols., Edinb. 1761, 2nd ed., Perth, 5 vols., 1782.

D. MACFADYEN.

GNOSTICISM.—1. Name and character.—Under this name are included all the manifold systems of belief, prevalent in the first two centuries of our era, which combined the Christian teachings with a *γνῶσις*, or higher knowledge. According to Hippolytus (*Refut.* v. 6), the title of

'Gnostics' was assumed by the Naassenes; and we may infer that it did not originally bear the wider connotation which was given to it later. The pursuit of *γνῶσις* was so intimately bound up with the religious sentiments of the age that those who shared in it were unconscious of any close affinity, and did not think of calling themselves by a common name. But the eventual triumph of orthodox Christianity brought into clear relief the identity of principle which underlay the various heretical doctrines, and caused them to be grouped together under the general designation of 'Gnosticism.'

We have to deal, therefore, not so much with a definite scheme of thought as with a large and many-sided movement, which was continually changing. The nature of this movement has often been misunderstood through a failure to apprehend the precise significance of the term *γνῶσις*. It has been taken for granted that the Gnostics were the intellectual party in the Church, and that their object was to resolve the Christian message into a philosophy acceptable to cultivated minds. This estimate of the movement is not wholly erroneous. In working out their beliefs the Gnostic thinkers were led to construct highly speculative systems, which sought to explain the origin of evil, the nature of the Divine being, and the interaction of the spiritual and the material. In the words of Theodotus, as quoted by Clement of Alexandria (*Exc. Theodot.* 78), *γνῶσις* is 'the knowledge of who we were, what we have become, where we were, into what place we have been thrown; whither we are hastening, whence we are redeemed; what is birth, what is re-birth.' This definition, however, belongs to the later, more speculative phase of Gnosticism; and in any case it suggests the idea of a knowledge not attainable by ordinary intellectual processes, and only to be gained by a mystical enlightenment. To the term *γνῶσις*, as we meet it in Hellenistic writings, there always adheres this suggestion of a knowledge obtained supernaturally. The magical papyri describe their contents as *γνῶσις*. The word is constantly employed, by religious and philosophical writers, to denote an immediate vision of truth, as contrasted with a wisdom that comes by seeking. These two kinds of supernatural knowledge have both to be taken into account in estimating the purpose and character of Gnosticism. On the one hand, the Gnostic is in possession of an occult lore. He participates in mysterious rites, and is instructed in magical watchwords and secret names.

'By means of this *γνῶσις* a man receives power to overcome those very angels that made the world' (Iren. i. xxiii. 5). 'This is the book of the *γνῶσις* of the invisible God, contained in the hidden mysteries which show the way to the elect generation' (*Book of Jeu*, l. ch. 1).

On the other hand, he undergoes a mystical experience whereby he apprehends the true nature of God and enters into communion with Him.

'He who possesses a heart that is sanctified, and that shines with light, is blest with the vision of God' (fragment of Valentinus, quoted by Clem. Alex.).

The idea of *γνῶσις* is closely related to that of revelation. It is assumed in all the systems that man is unable of himself to attain to the higher knowledge, which is, therefore, communicated to him by a being from the heavenly world. This fundamental doctrine of Gnosticism has its classical expression in the Hymn of the Naassenes (Hippol. v. 5):

'Then said Jesus: Father, a searching after evil on the earth makes man to wander from thy Spirit. He seeks to escape the bitter chaos, but knows not how to flee. Wherefore send me, O Father! With the seal will I descend, travel through all *Æons*, disclose all mysteries, show the forms of the gods: the secrets of the holy path which are called "Gnosis" I will impart.'

Each of the sects claimed to be the repository of a secret message, revealed from heaven; and on the knowledge of this message, with its accompanying symbols and ritual, the entrance into the higher life depended. As there had been an original revelation, so, from time to time, there had arisen chosen spirits who had apprehended it with peculiar strength and fullness. Their record of it was contained in sacred books which had been handed down in the community of their disciples. The abundant literature of Gnosticism was for the most part pseudonymous. Sometimes the books were assigned to purely fanciful names, sometimes to prophets or heroes of antiquity, sometimes to disciples of Jesus who were supposed to have transmitted His secret teaching. Apart from this fabricated literature, the writings of the New Testament, and especially the Fourth Gospel, were transformed into Gnostic documents by means of allegorical commentaries. The revelation, however, was not wholly a matter of tradition. Gnostic teachers occasionally laid claim to an original insight into the mind of God, or even to a participation in the Divine nature. The Patristic references to cults that grew up around the persons of individual Gnostics (*e.g.* Simon, Epiphanes) have often been called in question, but without sufficient reason. Probably in all cases the founder of a Gnostic sect was regarded with a veneration which would hardly have been paid to a philosophical teacher. He was not only a teacher but the medium of a revelation, and in some degree, therefore, a manifestation of God.

2. Relation to syncretism.—According to the Church tradition, the originator of the Gnostic movement was Simon of Gitta, the 'sorcerer' whom Peter and John encountered at Samaria (Ac 8^{9a}). There is no reason to doubt that Samaria, with its mixed population, was an early centre of Gnosticism, or that Simon was a historical personage who was prominently connected with some important phase in its development. But the movement as a whole cannot be traced back to the activity of any individual teacher. It manifested itself under so many forms and in localities so widely separate that we can regard it only as the outcome of ideas and tendencies which were involved in the general life of the time. This is acknowledged by the Fathers themselves, who derive the heresies of Simon and his successors from Greek philosophical speculation; and the hypothesis has been accepted, in a modified form, by not a few modern scholars. Harnack defines Gnosticism as 'the acute . . . hellenising of Christianity' (*Hist. of Dogma*, i. 226). The Gentile mission entailed a rationalizing of Christian doctrine by means of the categories of Greek thought; and this process pursued its natural development in the work of the early theologians, and ultimately resulted in the orthodox creeds. But meanwhile there was the stormy episode of Gnosticism, when the Greek interpretation was pushed to an extreme limit by irresponsible thinkers. This view, however, cannot be maintained if we take 'hellenising' in its narrower sense of philosophical re-statement. It is true that in Gnosticism we meet with a variety of terms borrowed from philosophy, and in almost all the systems there is some attempt at a speculative construction. But, if Harnack's definition is to stand, we must read the widest meaning into the idea of 'hellenising.' The Hellenic spirit which so profoundly modified the Christian doctrines had itself been modified, in the most radical fashion, by influences from without.

For the true explanation of the Gnostic movement we must turn to the process of syncretism which accompanied the breaking up of the pagan

religions. This amalgamation of different types of national belief was carried out most fully in the first two centuries of our era; but we can trace its beginnings long before. Even in the period of the ancient Oriental monarchies, the frequent transplanting of peoples had led to a fusion of religions, as in the case of the tribes settled in Samaria, who 'feared the Lord, and served their own gods' (2 K 17³³). The fusion took effect on a large scale when Persia fell heir to the Babylonian Empire and imposed its dualistic religion on the various Semitic provinces. After the conquest of Alexander the tendency to syncretism became still more pronounced. The Hellenic culture, now diffused over the East, acted as a solvent upon the native forms of belief. Their myths and observances were interpreted in the light of Greek thought, and were at the same time thrown together in new combinations. The process was completed under the Roman Empire, which finally broke down all national boundaries and promoted a free intercourse of the Eastern races with one another and with the peoples of the West. Moreover, in the Roman period the influence of Stoicism became everywhere prevalent. The Stoic philosophy linked itself readily with the most diverse religious systems, and helped at once to disintegrate and to remould them. All over the East the syncretistic movement was in process, but it advanced most rapidly in the cosmopolitan centres, such as Antioch, Alexandria, and the great cities of Asia Minor. In each of these centres there arose a mixed religion, to which the local type of belief—Syrian, Egyptian, or Phrygian—naturally contributed the largest share. So far as the masses of the people were concerned, the syncretism was for the most part fortuitous, but there were circles in which it was carried out deliberately. From the time of Plato, the idea had obtained currency that a deeper wisdom was enshrined in the Oriental mythologies; and the beliefs now surging in from the East were eagerly embraced by eclectic thinkers. One man would often seek initiation into a number of cults, and would endeavour, with the aid of philosophical categories, to combine their teachings into a single system. We have thus to do with a fusion of religions which, to a great extent, was artificial—the result of conscious effort on the part of cultured and intellectual men. It was this that distinguished the syncretism of the 1st cent. from similar movements of which we have record elsewhere. It is this, too, that partly explains the strange mixture of crude mythology and lofty speculation in the typical Gnostic schools.

Judaism, more than any other Eastern faith, was a sharply defined religion, excluding on principle all foreign elements of belief. But Judaism itself had become involved in the general syncretistic movement. The Apocalyptic literature bears witness to the many alien influences which had affected Jewish theology during the period that had succeeded the Exile. At the time of Christ there were sects even in Palestine (*e.g.* the Essenes [*q.v.*]) which gave a place to foreign rites and speculations alongside of orthodox Judaism; and the communities of the Dispersion were much more accessible to influences from without. Of this we have the most signal, but by no means the sole, evidence in the case of Philo, who represents a studied attempt to bring the OT teaching into harmony, not only with Stoic and Platonic ideas, but with the native traditions of Egypt. The conspicuous part which is assigned in Gnostic speculation to OT legend and theology can, no doubt, be explained in great measure by its Christian affinities; but we have to allow for the probability that Judaism had made an impression

on syncretistic thought before Christianity had yet emerged. Indeed, it is possible—although of this we have no certain proof—that the Jewish contribution was of a decisive nature, and was one of the main factors which enabled Gnosticism to effect its alliance with Christianity.

The Gnostic movement, then, was the result of that mingling of diverse beliefs which had long been in process at many different centres; and it had developed itself, in all its essential features, before the Christian era had fairly begun. Of this pre-Christian Gnosticism we still have an impressive monument in the so-called Hermetic literature of Egypt—a literature which was compiled from sources that were certainly in existence in the 1st or 2nd cent. B.C. Not a few of the Gnostic systems described by the Fathers betray a pagan origin, although they have been artificially combined with Christian elements. Reitzenstein has succeeded in detaching a purely pagan document which underlies the Naassene teaching, as preserved by Hippolytus; and a similar analysis could probably be applied to the records of other systems with a like result. But, while we can thus speak of a pre-Christian Gnosticism, it was by no accident that the movement identified itself with Christianity in such a way that the earlier stages of its history became only the preparation for this, its characteristic development. From the Christian teaching it received a mighty impulse. The contact with a living religion gave a new vitality to pagan thought and compelled it to offer its own solution of the ultimate problems.

How was it that the syncretistic movement came to ally itself with nascent Christianity? A definite answer to this question is hardly possible. The tradition that connects the beginnings of Christian Gnosticism with Samaria may be well founded, for in the neighbourhood of Palestine the new religion would be first known and welcomed. But the same causes that led to its recognition in Samaria would operate independently in other centres where it was afterwards established. The Eastern religions were superficially akin to Christianity in their presuppositions and motives. They represented a striving after purity and redemption, and a belief that the true path to blessedness could be discovered only in the light of a Divine revelation. Earnest thinkers, in their effort to win the secret of the higher life, found in Christianity a wealth of spiritual conceptions which promised to aid them in their quest. The life of Jesus Himself was capable of an allegorical interpretation whereby it could be partially fitted into the prevailing mythology. In their eclectic scheme, therefore, they made room for the Christian message, and by its intrinsic power it gradually won for itself a central place. It must be remembered, too, that Christianity, when it first entered the Gentile world, was still in the process of free development. Within the Church itself its teachings were subjected to a constant revision, and the Hellenistic thinkers had little difficulty in modifying them yet further and adapting them to alien speculations. For that part, the assimilation of Christianity to the syncretism of the age was not effected entirely from the outside. In their endeavour to make their Gospel intelligible to the Gentile world, the missionaries had themselves clothed many of its conceptions in terms and imagery derived from the pagan cults. The cardinal idea of a salvation offered by Christ had been expressed, even by St. Paul, in a manner that easily suggested the current beliefs. Moreover, the Church was compelled, by deeper reflexion on its doctrines, to interpret them along the lines of Gnostic thought. The new religion, springing as it did from the soil of Judaism, was apocalyptic in character, and was thus

involved with conceptions that became more and more untenable. A reaction against the primitive millenarianism set in almost from the beginning; and the main task which was laid upon Christian thought after the end of the 1st cent. was that of transforming its apocalyptic beliefs into their spiritual equivalents. In the pursuit of this task it could not but avail itself of ideas which were already familiar in the religions of the time. Thus the alliance between Christianity and syncretism was a mutual one. At a later date the Church perceived the danger that threatened it from the encroachment of foreign beliefs, and required to free itself at the cost of a life-and-death struggle. But there was an earlier period when the boundaries between the Church and the contemporary cults were ill-defined, and influences could pass by many channels from the one side to the other. It was in this period that the Gnostic movement properly so called—the adoption of Christianity into the syncretistic system—took its rise.

3. Origin.—Gnosticism resulted from the fusion of a number of diverse beliefs, and the tracing of its origin is, therefore, beset with many complex problems. The attempt has been made by scholars in recent times to connect it more definitely with one or other of the religions out of which it sprang, but there are several considerations which make this attempt not a little hazardous. (a) 'Gnosticism' is a general term which covers a wide variety of religious thinking. It may be possible to assimilate one particular system very closely to a given religion; but the conclusions thus obtained cannot be made valid for the whole many-sided movement. (b) Certain features are common to many different Oriental religions (*e.g.* the Mother, the Redeemer, the Heavenly Man, the Serpent, the Ascent to a higher and the Descent to a lower state of being). The presence of these features in Gnostic systems affords us no clue to the source from which they are derived. They can be traced exclusively to one religion only by obscuring details in which they remind us of another. (c) Even when a characteristic element can be assigned, with practical certainty, to a given religion, we cannot be sure that it was borrowed directly from that source. A syncretism had been in process for a much longer time than we have means of following it; and the element in question may already have been incorporated into some later faith, from which it passed into Gnosticism. (d) In Gnostic thought the concrete is resolved into the abstract. Personal names are replaced by terms of philosophy, mythological figures are changed into qualities and attributes, and events into cosmical processes. It is next to impossible to make out the original colours and outlines of this blanched picture.

But, while we cannot determine, with anything like precision, the elements which enter into Gnosticism, some valuable light has been thrown on the problem by the investigations of recent years.

The work of Anz (*Ursprung des Gnostizismus*) was the first attempt at a scientific analysis. He discovered the central idea of Gnosticism in the ascent of the soul through successive stages of being, and sought for the origin of this conception. He found it in the astral religion of Babylonia, with its doctrine of a series of heavens, each under the rule of a planetary god, through which the soul must make its ascent by means of magical passwords delivered to the 'guardians of the doors.'

To this theory of Anz, at least in the extreme form in which he presents it, there are several objections. (a) The doctrine of the ascent of the soul, though, no doubt, of the first importance, cannot be singled out as the whole message of Gnosticism. From some systems it is entirely absent, and, even where it occupies a prominent place, it is combined with other ideas no less essential. The derivation of this one element of Gnostic thought cannot be made conclusive for the origin of the movement as a whole. (b) In the 1st cent. A.D., and, indeed, for several centuries before, the Babylonian religion belonged to a remote past. It is true that many of its superstitious survived in the current astrology, but they had now

merged in the general belief of the time. To assume a Babylonian origin for any system of thought in which we can recognize them is to confuse our whole historical perspective. (c) The planetary gods, as we find them in Gnosticism, have an altogether different place from that which they occupy in the Babylonian religion. They are no longer supreme Divinities, but are inferior and antagonistic powers by which man is held in bondage. His one endeavour is to throw off their bondage, and thus to procure for himself true life. Admitting, then, that there are elements in Gnosticism which must have had a Babylonian origin, it seems necessary to hold that they came in by an intermediate channel.

Bousset (*Hauptprobleme der Gnosis*) has advanced strong reasons in favour of the view that this channel was the Zoroastrian religion. He lays especial stress on the altered position ascribed in Gnosticism to the planetary gods, and finds in it an instance of that 'degradation' which is not uncommon in religious history. The Persians after conquering the Babylonian Empire had allowed a place to the ancient gods, but had deposed them from their sovereign rank to that of subordinate daemonic powers. To the Persian influence Bousset would attribute not only the Babylonian elements in Gnosticism, but most of its characteristic features, and, above all, the dualism which marks its theology as a whole.

It may be doubted, however, whether even the Persian influence was exercised directly. Not a few of the Gnostic doctrines are closely allied with those of Mithraism, which had branched out from the main stem of the Persian religion, and had already, in the 1st cent. A.D., become widely prevalent in Asia Minor. Mithraism had adopted the conception of the ascent of the soul through the planetary spheres, and had associated it with a sacramental and ritual system of a highly elaborate kind. As a mystery religion it powerfully attracted the votaries of *γνώσις*. But the influences from Babylonia and Persia were combined with others, hardly less potent, which can be traced back to Egypt.

An Egyptian origin of Gnosticism was first maintained by Amélineau, who based his argument on fancied resemblances between the mystical symbols in the Coptic documents and certain hieroglyphic signs. Of late years, Reitzenstein and other investigators have adduced stronger evidence, derived from the inner affinities of Gnostic with Egyptian thought. It is significant that the Hermetic literature, our chief existing record of pre-Christian Gnosticism, was composed in Egypt and is impregnated with Egyptian ideas. On the ground of the parallels supplied by this literature, we can assume, with a fair degree of confidence, that the Gnostic thinkers were indebted to Egypt for their theory of the Pleroma, of the birth of the *Æons* by a process of emanation, and of the syzygies, or pairs of male and female gods. To Egyptian influence we may also assign the conception of an apotheosis, or absorption into the Divine nature, which in Gnosticism is the final goal of the ascent to heaven.

The main sources of the Gnostic beliefs must be sought in Babylonia, Persia, and Egypt; but other religions added their contribution. Phrygia had long been the home of a peculiar worship, mystical and ecstatic in its character, which had powerfully affected all the Hellenistic cults. It centred in the two figures of Cybele and Attis, the Mother and the Victim-Deliverer; and it was largely through Phrygian influence that these figures, although they have counter-parts in almost all the cults, were brought into prominence. They hold a foremost place in Gnosticism, and are conceived in a manner that constantly suggests the Phrygian myths; indeed, the Naassene document in Hippolytus appears to be borrowed directly from Phrygian sources. In later Gnosticism we begin to discern traces of influences proceeding from India. The Basilidean system, as described by Hippolytus, affords striking analogies to Buddhist thought in its negative conception of God and its doctrine of the Great Ignorance (*Nirvāṇa*) which will accompany the final consummation. The theory of the Parasitic Soul, as held by Isidorus, son of Basilides, likewise suggests a well-known Buddhist conception, and Bardesanes, the 'last of the Gnostics,' was confessedly influenced by his acquaintance with Indian thought. It is easy, however, to attach undue importance to the Indian contribution even in the later systems; in the Gnosticism of the main period it seems to have played little or no part.

The ground-work of Gnosticism was supplied, then, by a number of mythologies which had become fused together in the process of syncretism. Ideas that had come down from the astral worship of Babylonia were blended with Persian and Mithraic beliefs, and these, again, with the cults of Egypt and Phrygia. Other religions (e.g. the local cults of Syria) also made themselves felt, although their contributions cannot be identified with any certainty. It is more than likely that this mixture of Oriental beliefs had been partially leavened, even before the Christian era, by elements taken over from Judaism. As a result of the Gnostic alliance with Christianity the OT came to occupy an even greater place in the building of the various systems. Attention was directed, more especially, to the opening chapters of Genesis, which hence-

forth supplied the framework for the Oriental cosmologies. The whole mass of belief which had thus been compounded out of the débris of many religions was informed with the spirit of Greek speculation. What had been given as myth and legend was construed metaphysically. Theories concerning the nature and destiny of the soul were interwoven with the ancient traditions. But, while Gnosticism availed itself freely of the language and ideas of philosophy, the appearance which it thus assumed was for the most part deceptive. It was not a speculative but a mythological system. In spite of all efforts to read a deeper meaning into its hieratic doctrines, the material could not be made tractable to philosophical interpretation. As a movement which strongly influenced Christianity in its formative period, Gnosticism has an important place in the history of human thought, but in itself it remained sterile. For all its pretension to hold the key to a higher wisdom, it never really transcended the primitive mythology out of which it sprang.

4. Doctrine of redemption.—The affinities of Gnosticism are not with philosophy but with religion, and it has to be explained throughout in view of its practical religious motive. This is forgotten by the Christian polemical writers, who deal almost exclusively with the Gnostic speculations. In all the sects these, no doubt, occupied a large place, but they were at best subsidiary to the religious interest. The central idea of Gnosticism, as of all the mystery religions, was that of redemption. A *γνώσις*, or spiritual enlightenment, was offered to the elect, whereby the soul might be delivered from its condition of bondage. Redemption, as understood by Christianity, is fundamentally ethical, although the ethical meaning is obscured, even in the NT, by apocalyptic or speculative forms. But in Gnosticism the ethical aspect of redemption falls almost completely into the background. Here we may discern the chief peculiarity of the movement, which gave direction to all its thinking, and brought it finally into open conflict with the orthodox Church.

Two ideas are involved in the Gnostic doctrine of redemption. They are closely associated, or even identified, in all the systems, but were different in their origin, and need to be considered separately. (a) The redemption is a deliverance from the material world, which is regarded as intrinsically evil. Gnosticism based itself on the Persian dualistic conception; but, while in Parsism light and darkness appear as two natural principles in eternal conflict, the Gnostics transformed the physical dualism into a metaphysical one. Under the influence of Greek speculation the contrast of light and darkness became that of spirit and matter—the lower world of sense and the higher world of pure being. Although these two are viewed as irreconcilable opposites, it is recognized that they have come to be mingled together. All the evil and misery in the world are set down to this forbidden intermixture of the antagonistic principles. This is the grand calamity which has made necessary a work of redemption.

In most of the Gnostic systems the Oriental dualism is frankly accepted, although we constantly meet with efforts to overcome it. The Naassenes conceived of a 'chaos poured forth from the First-born.' The later Valentinian school regarded the fall of Sophia as taking place within the Pleroma. Basilides, according to Hippolytus, resolved the history of all being into a single continuous process. Moreover, in a number of systems a mediating power is assumed between light and darkness (cf. the Sethian conception of *πνεῦμα* as a fragrance everywhere diffused). To thinkers trained in Greek philosophy the mere opposition

of the two worlds was a standing challenge to discover some ground of unity. But the dualism is rather concealed than overcome, and may be traced more or less clearly underneath all the apparently monistic constructions. Indeed, it constitutes the basis apart from which the Gnostic type of religion has no purpose or meaning. A spiritual essence has come to be imprisoned within a sphere which is radically alien to it; hence the need for a redemption, to be achieved only by some supernatural power.

(b) But the idea of deliverance from the material world is blended with the further idea of escape into a world of freedom. To ancient Hellenic thought, necessity was the power above the gods (see FATE [Greek and Roman]); and at the beginning of the Christian era this mode of thinking had been immensely strengthened by Oriental fatalism. The conception of a *εἰμαρμένη* imposed on all human action had grown into a veritable tyranny—all the more so as it was now connected with astrological beliefs which had come down from the Babylonian religion. The planets were regarded as the *ἀρχόντες* or *κοσμοκράτορες* to which the whole creation is subject. By their influences, controlling him from his birth, man is forced under the yoke of mechanical necessity, although conscious all the time of his vocation to freedom. Gnostic thought took its direction from these contemporary beliefs. Its motive was a genuinely religious one—to secure for the human spirit that liberty which is implied in its very nature. The deliverance, however, was sought for along the lines suggested by astral mythology. It was assumed that the soul was held captive by the planetary powers; and in order to win freedom it had to ascend through the spheres over which they ruled, subduing or deceiving the guardian demons by means of charms and pass-words. To this purpose of circumventing the hostile rulers the secret discipline of Gnosticism was mainly directed. The adept was prepared for his future journey by sacraments and lustrations, and by instruction in the hidden names of angels and the words and signs by which they could be overcome. All the resources of magical *γνώσις* were called into play to effect the deliverance of the soul from the cosmical powers which had brought it under the bondage of necessity.

These were the two aspects in which the idea of redemption presented itself, and they merge into one another at every point. The escape into freedom is conceived at the same time as a rising out of the material into the spiritual world. As the goal of the redemptive process the Gnostic looked for a return of the soul to its original place in the heavenly light. A doctrine of the resurrection of the body, or even of personal immortality, was precluded by the fundamental conception of matter as evil. The soul, freed from its limitations, is simply to be reunited with the 'Pleroma'—the fullness of the Divine being.

It is characteristic of all Gnostic systems that redemption is anticipated for only a limited number of chosen spirits. This has sometimes been set down to an exaggeration of the Christian doctrine of election; but it belongs rather to the aristocratic tendency of all mystery-religions, heightened, in the case of Gnosticism, by the underlying dualism. As there were two worlds, so there were two classes of men, absolutely separate from one another. For the grosser type of men, God was not responsible; only the spiritual natures had sprung from Him and were destined for the higher realm of light. These spiritual natures alone were capable of the redeeming *γνώσις*, and to impart it to others was a profanation. The earlier Gnosticism recognizes only two

classes—the *πνευματικοί*, and the inferior class which is variously described as *ψυχικοί*, *χοϊκοί*, or *ὕλικοί*. Later schools allow for three—*πνευματικοί*, *ψυχικοί*, and *ὕλικοί*, the intermediate class representing the ordinary Christians, who possess *πίστις* instead of *γνώσις*. The Coptic writings divide humanity into a large number of different classes. These, however, are merely attempts to conciliate the Church by obscuring the distinction between the Gnostic and the orthodox believer. The distinction is really an absolute one: those who share in the heavenly light can have nothing in common with those who are denied it.

5. Praxis and mythus.—In its essential purpose Gnosticism was a method of redemption, and consisted not so much in the profession of certain opinions as in the practice of given rites, which were supposed to aid the soul in its effort to shake off its fetters. Although the extant documents are concerned chiefly with the Gnostic theology, we have one detailed account of the praxis in the so-called *Books of Jeu*, and further light is thrown upon it by Irenæus' description of the Marcosians and the liturgical portions of the *Acts of Thomas*. As in the Christian Church, the act of initiation took the form of a baptism; but the Gnostic rite was more elaborate, and the ordinary baptism by water was supplemented by 'fire' and 'spirit' baptisms. The worship of the various sects seems to have been accompanied by a highly complicated ritual, intended, as in Mithraism (cf. Dieterich, *Eine Mithrasliturgie*), to typify and anticipate the ascent of the soul to heaven. Each sect had its own peculiar rites—lustrations, anointings, sacramental meals, repetition of magical phrases and formulæ. Symbols with a mystical import were frequently marked on the body, or were engraved on rings and gems, which were worn as amulets. Above all, the secret names of angels and demons were carefully committed to memory, along with the spells and invocations whereby the different powers of the invisible world could be controlled.

How was this praxis, consisting, as it did, of the usual apparatus of contemporary magic, related to the speculative side of Gnosticism? The relation appears to have been twofold. (1) The speculative systems were the interpretation of the praxis. In the *Pistis Sophia* we can almost follow the process by which a mythical history was woven together out of the details of the ritual, which was then regarded as the symbolical enactment of the experiences of a Divine person. The worshipper could thus feel that he was participating, by a series of sympathetic acts, in a deliverance which had already been realized on a higher stage. (2) The mythus was developed as a supplement to the praxis. Speculative minds were unable to rest in the bare assurance that by partaking in a certain ritual they would secure redemption. They could not but ask themselves why a redemption was necessary, what was its scope and nature, and by what means it had become possible? The answer to those questions was given in the Gnostic systems. Originally they were something added to the *γνώσις* proper, which was concerned entirely with the occult rites and formulæ. But in course of time they became an integral part of the *γνώσις*. It was taken for granted that redemption was in some measure conditioned by a knowledge of those higher speculations on the ultimate problems of being.

6. General features of the mythus.—In the details of their construction the systems are widely different, and cannot be fitted into any one general scheme. Yet there are certain elements which in one form or another belong to all of them, in view of the dualistic hypothesis that underlay the whole

Gnostic theory of redemption. It followed from that hypothesis (1) that matter was intrinsically evil—a lower world standing over against that higher one into which the soul sought to escape; (2) that the soul was native to the higher world, and had fallen from it, previously to its conscious existence, as the result of some cosmical disaster; (3) that the soul could be restored only by a Divine intervention, since its progress was hopelessly barred by its imprisonment in matter. The ideas which thus presented themselves to Gnostic speculation were set forth and elaborated in terms of mythus. It was assumed that man's spiritual nature was derived from a Divine being, who had fallen out of the world of light into the world of darkness. The process of deliverance involved, in the first place, the restoration of this fallen being, and the restoration could not be effected except by the voluntary descent of another Divine being, equal or superior in rank. Around these two beings—the fallen Divinity and the Redeemer—the Gnostic mythus in all its variations may be said to turn.

Allowing, then, for an endless diversity of detail in the manifold systems, the characteristic features of Gnosticism may be briefly indicated. At the head of the universe stands a Supreme God, who is not so much a personal Deity as the abstract ground of all existence. Sometimes (as in the *Pistis Sophia*) He is conceived as pure Light. Elsewhere He bears names which serve to emphasize His absolute transcendence—Father of All, Unbegotten, Ineffable, the Unapproachable God, the Abyss, the Unknowable. The Naassene and Barbelo systems describe Him as 'the Man' or 'the Primal Man,' and traces of this conception meet us even in Valentinianism. In view of the many analogies furnished by ancient religion (*e.g.* Parsism, the Hermetic writings of Egypt), we cannot assign it to Jewish or Christian speculation. It runs back rather to some primitive myth, the meaning of which can now only be conjectured, and which possibly underlies the imagery of Daniel and the Book of Enoch. From the Father or Supreme God there proceed a number of beings in a descending scale of dignity, who are arranged in pairs of male and female ('syzygies'), and in their totality make up the *Pleroma*—the fullness of all blessedness and perfection. Behind this conception of the *Pleroma* we can discern the purely mythological idea of a Pantheon, or family of gods; but in Gnosticism it assumes a mystical character. The Divine existences, while distinguished from one another, are the manifestations of the one God, who is Himself impersonal and unknowable.

In later Gnosticism—more especially in the teaching of Valentinus and his school—the members of the *Pleroma* bear the name of *Æons* (*q.v.*), and are created in successive pairs by a process of emanation. This doctrine of *Æons*, in which we can trace Mithraic and Egyptian ideas modified by Platonism, has often been singled out as one of the typical features of Gnostic speculation; but it is characteristic only of certain systems, and seems to represent an attempt on the part of later thinkers to overcome the dualism inherent in the movement. In a manner which partly anticipates the Neo-Platonic theory, the Primal Being is conceived as going forth from itself in a series of existences, each at a further distance from the centre, so that the interval between God and the world is partly bridged over.

The process of redemption becomes necessary through the fall from the *Pleroma* of the member that stands lowest in rank. To this *Æon* or Power is usually assigned the name of *Sophia*, a name suggested by the OT conception of the

Wisdom by which the world came into being. In Simonian Gnosis the fallen Divinity is called Helena (a reminiscence of *Σελήνη*, the moon-goddess), while in one important group of systems she appears as Barbelo (בארבע אלה, 'in the four is God'). The conception of Sophia is related in many of its features to that of the Mother (Ishtar, Isis, Atargatis, Cybele) who in the Babylonian myth descends into the abyss, where she is held prisoner. But, whatever may have been its origin, the figure of Sophia underwent a complete transformation at the hands of the Gnostic thinkers, who sought by means of it to solve their crucial problem of how the Divine principle of light could enter into contact with darkness. According to one theory, Sophia fell by leaving her appointed place in her desire to attain to the supreme light. According to another, she was lured into the outer depth by a false reflexion of the light. In Valentinianism, as in the Barbelo system represented by the *Pistis Sophia* and the *Books of Jeu*, the figure of Sophia is doubled. The higher Sophia remains in the *Pleroma*, or in a sphere just outside of it, while the lower Sophia sinks into the darkness. The purpose of this duplication is apparently to account more easily for the fall, which was unintelligible on the strict dualistic hypothesis; but it also reflects a conception of Sophia of which we have traces in all the systems. A twofold function is attributed to her. She is the fallen Divinity through whom the light becomes immersed in darkness; and she is also the intermediary between the higher world and the spiritual nature which has been exiled from it. Thus she is regarded not only as the object of redemption, but as herself assisting in the redemptive process—watching over the light until the deliverance comes.

The fall of Sophia has for its consequence the work of creation. Hitherto the world of light had stood over against an utterly formless world of darkness; but the commingling of the higher principle with the lower evolves a cosmos out of the chaos. As the agent of creation, Gnosticism assumes a *Demiourgos*, who is usually represented as the son of Sophia. He is himself ignorant of the *Pleroma* above him, and governs the world created by him in the belief that he is himself the Supreme God; but unconsciously he transmits the elements of light which have come to him through his mother. The figure of the *Demiourgos* is due to a blending of mythological with philosophical ideas. On the one hand, it points back to the astral religion of Babylonia; the *Demiourgos* (who also appears as 'Ialdabaoth'—a name of uncertain significance)¹ is at the same time the first of the Archons, *i.e.* the planetary god Saturn. On the other hand, it reflects the conception which has ever and again found utterance in philosophy, that creation is the result of a blind intelligence. The *Demiourgos* is conceived not as an evil power, but rather as a cosmical force which acts unwittingly. But, since he thus represents a mechanical will, controlling the spiritual life of which he has been the unconscious vehicle, he becomes the tyrant from whose thralldom the soul craves deliverance.

A singular feature of Gnosticism is the identification of this inferior God with the God of the OT. It is possible, as Bousset conjectures, that this identification was prior to Christianity, and was inspired by hostility to Judaism on the part of neighbouring peoples. But it seems more probable that we have here an exaggerated reflexion of the attitude of the early Church. Christian thought from the beginning had been compelled to deny the validity of the Law, although its

¹ Hilgenfeld, *Ketzergesch.* 238, 243, suggests ברהו ילדא, 'offspring of chaos.'

claim to a Divine origin and sanction was still acknowledged. In Gnosticism, the riddle which had perplexed St. Paul and the writer to the Hebrews was solved in the most drastic fashion. The God of the OT was regarded as different from the God revealed by Jesus, and in some sense hostile to Him. He was not, as the Fathers were wont to assert, identified with Satan, but he was clothed with inferior attributes and limited to the one task of blind creation.

The fall of Sophia breaks up the perfect harmony of the Pleroma, and this cannot be restored until the lost light is recovered from the darkness. An Æon of supreme rank—the *Soter* or *Christus*—undertakes the work of deliverance. According to the Naassene hymn, this Divine being acts throughout on his own initiative, but elsewhere (e.g. *Pistis Sophia*, Ophites of Irenæus) he is moved by the urgent prayer of Sophia. He comes down through the spheres of the Archons, taking on himself the forms of the spirits of each world as he descends. Arriving in the world of darkness, he gathers to himself the scattered seeds of Divine light, and finally re-ascends along with the rescued Sophia into the Pleroma. The figure of the Soter is itself anterior to Christianity and has many counterparts in the Hellenistic cults. Its prototype may possibly be found in the Babylonian light-God Marduk, who descends unrecognized to do battle with Tiamat, the monster of Chaos. Further elements are borrowed from the myths of Attis, Osiris, and Mithra, although all the definite features are blended together and resolved into one abstract conception. The grand characteristic of Christian Gnosticism is the identification of the mythical Redeemer with Christ, with whose history the pagan traditions are interwoven. But the Soter always remains distinct from the historical Jesus, who appears simply as a man of pre-eminent spiritual nature, united for a given time with the heavenly Redeemer. The union takes place either at his birth (Naassenes and *Pistis Sophia*), or when he is twelve years old (Justinian sect), or, according to the usual view, on the occasion of his baptism. Before the crucifixion the Divine being, who is incapable of suffering, separates himself from Jesus (cf. art. DOCETISM). This distinction of the Soter and the historical Jesus is partly necessitated by dualistic theory; but it must be explained, in still greater measure, by the radically un-Christian character of the whole movement. The Gnostic Redeemer had originally no connexion with Jesus. He was simply an abstraction of features common to the mythological Saviours, and this abstract figure was combined artificially with the Jesus of history. It was on this account that Gnosticism was unable, in spite of all efforts, to establish any real identity between the Redeemer and Jesus. Before it could adapt itself to the Gnostic construction the Gospel history had to be revised throughout, with a loss of practically all the elements which gave it significance to Christian thought.

The task of the Soter is twofold—to deliver the fallen Sophia, and to rescue the seeds of light which have become mingled with the darkness, owing to her fall. This double activity is emphasized in some systems by a duplication of the figure of the Soter, while in others the work of redemption is separated into two acts—the first of them in the period before creation, and the second at the advent of Jesus. The redemption accomplished by Jesus is not connected with His death, which is transformed into a mere outburst of hostility on the part of the Demiourgos. The real purpose of Jesus, or rather of the Soter who used Him as his instrument, was to communicate the hidden *γῶσις*. By means of this knowledge, imparted by Jesus

and preserved in the Gnostic tradition, the higher natures were freed from their earthly bondage and restored to the kingdom of light.

The *ethical system* of Gnosticism, like its speculative construction, was grounded in the dualistic hypothesis. By this hypothesis the idea of morality, in the ordinary sense, was excluded. All material conditions were regarded as necessarily evil, and the aim of the Gnostic was to rise above them into the purely spiritual life. To this struggle for deliverance from the bondage of matter all moral endeavour was subordinated. As a consequence, the Gnostic rule of conduct was liable to take either of two directions. (1) In most of the systems it is strongly ascetic in character. The soul is required to free itself from earthly conditions by holding aloof from all sensual pleasures and reducing the needs of the body to the barest minimum. A strict ascetic discipline is conjoined with the possession of *γῶσις* as its necessary support and complement. (2) But the same motives that dictate this ascetic morality lead as easily to the opposite extreme of libertinism. Spiritual natures are called on to assert their independence of the material world by indulging in its pleasures without restraint. The libertine tendency is reinforced by the identification of the God of the OT with the Demiourgos—the inferior and tyrannical God. It is assumed that the moral law as laid down in the Decalogue is founded on his arbitrary will, and aims at the subjection of man's free spirit to the yoke of necessity. To defy the ordinances of the law, and thereby throw off allegiance to the inferior God, is a duty obligatory on the true Gnostic. Carpocrates and his son Isidorus sought to establish the libertine theory of conduct on a regular philosophical basis. It was represented likewise by the Nicolaitans, and in a still more marked degree by the Cainites, who applied their inverted standards of moral values to the characters of Scripture. Cain, Esau, Korah, and Judas were honoured within this sect as the champions of spiritual freedom. How readily the one extreme could pass into the other is illustrated by the opposite attitude of kindred sects, such as the Peratæ and Sethians.

7. The Gnostic sects.—The diversity of the Gnostic systems, as portrayed in the writings of the Fathers, may in some measure be explained by controversial motives. One of the strongest arguments against the heretical beliefs was their tendency to conflict with one another, and the Patristic writers take every means to emphasize the confusion. Local and superficial differences are made prominent; alternative forms of the same doctrine are set forth under specific names, as if they were held by separate schools. But, when we have allowed for this artificial sub-division, the variety of the sects is still bewildering. Gnosticism drew from so many sources and was so irresponsible in its methods of speculation that no uniformity of belief was possible.

The difficulty of tracing the affinities and ramifications of the systems is all the greater because of our ignorance of their historical development. For the leading Gnostic teachers we can roughly assign dates between 130 and 190—the age of the Antonines; but a large number of schools cannot be connected with any personalities, and bear no marks by which the period of their origin may be computed. In their fundamental features these anonymous systems are pagan, and we may, therefore, infer that they are of an early date—perhaps anterior to Christianity. But they have become overlaid with Christian elements, and we cannot tell how or when they assumed their final form. The most accurate dating of the systems, however, would carry us only a little way. During all the

history of Gnosticism there seems to have been a continual process of borrowing and adaptation and revision. An arrangement of the sects in historical order would be largely deceptive, for the movement in its most developed stages was constantly reverting to ideas of a primitive stamp.

Attempts to classify the systems were begun even in Patristic times. They were grouped by Clement of Alexandria according to their ethical tendency, as ascetic and libertine; by Theodoret according to their speculative character, as monistic and dualistic. It is evident that no true classification can be arrived at by either of these standards. Among the many modern scholars who have tried to group the systems, the following may be mentioned. (a) Neander laid stress on the relation of Gnosticism to Judaism, and distinguished between the friendly and hostile schools. (b) Baur applied this test in a more scientific fashion and divided the sects according to their prevailing Jewish, pagan, or Christian character. (c) Gieseler sought to determine the countries in which they originated—Egypt, Syria, or Asia Minor. (d) Lipsius also adopted the geographical division, but was content to make it more general and to recognize two great Gnostic schools—the Syrian and the Alexandrian.

These groupings are all unsatisfactory, since they fail to take account of that intermingling of diverse types of religion which belongs to the essence of Gnosticism as a syncretistic creed. Perhaps the most convenient classification is that which is now usually adopted, and which distinguishes the anonymous systems from those associated with a definite founder or teacher. The distinction is at best a rough one, and is open to at least two serious objections. (1) The ascription of a system to a given founder is often accidental, and is due to nothing else than the existence of some well-known work in which its doctrine was expounded. (2) The Fathers were anxious, wherever possible, to connect each heretical sect with a prominent name; thus in many cases their references to a founder are purely conjectural. But, with these reservations, the grouping may be accepted, and serves to bring out a real and important distinction. The anonymous systems may fairly be held to represent the more primitive Gnosticism, which grew up more or less spontaneously out of the pagan cults and had only a superficial relation to Christianity. When a system bears the name of a definite teacher, we can regard it as a comparatively late product, based on philosophical reflexion and more closely allied to Christian thought.¹

(a) The anonymous systems are brought together, in the controversial writings, under the general head of *Ophitism*. They comprise, besides the Ophites proper, the Naassenes, Peratæ, Sethians, Cainites, Archontics, Severians, Barbelo-Gnostics, Justinians, Nicolaitans, Docetæ, and other more obscure sects. The figure of the serpent, to which the name refers, seems originally to have had a cosmological significance; but in various Hellenistic cults it had come to symbolize the world-soul, or eternity, or the Divine redeeming power. Its import for religious thought was enhanced by the Biblical stories of the serpent in Eden and the brazen serpent in the wilderness. Among the Ophite sects the serpent was a favourite symbol, typifying sometimes a beneficent, sometimes a hostile, power. But the term 'Ophitism,' although convenient, carries with it no definition of the systems. From some of them the serpent-symbolism is entirely absent, and in none can it be regarded as central and characteristic.

The Ophite or anonymous group of sects is marked by certain broad fundamental features. All the systems included in the group are rela-

¹ De Faye holds, however, that towards the beginning of the 3rd cent. the great schools diminished in importance and gave place to a multitude of minor sects. In proof of this he urges (a) the prominence given to the anonymous Gnostics by Hippolytus, (b) the affinities of the *Pistis Sophia* and the *Books of Jeu* (late works) with Barbelo-Gnosticism, and (c) the anonymous character of the sects opposed by Plotinus. But the evidence appears to point to nothing more than a vigorous survival of the earlier sects alongside of the later.

tively simple in structure, and have affinities with mythology rather than with Christian or philosophical speculation. The Æonic scheme, as we find it in later Gnosticism, is undeveloped or altogether wanting. The Godhead is conceived under the form of a Triad—the Supreme unknown Father, whose essence is light, and, associated with Him, the Mother and the Son. Other Divine beings have their place in the Pleroma, but the Triad appears so constantly that we cannot but feel that originally it was complete in itself. Beneath the higher world are the seven planetary powers—half gods, half demons—and at their head stands Ialdabaoth, who is identified with the God of the OT. He and the other six are throned above the lower world, which they have created out of the darkness, and in which the fallen particles of heavenly light have become imprisoned. The aim of the *γνώσις* is to enable these spiritual natures to free themselves and re-ascend to their native world.

As a typical example of Ophitism, the 'Gnostic' system described by Irenæus (*adv. Hær.* i. 30) may be reproduced in outline. It starts from the conception of a Supreme Being, 'the First Man,' from whom proceeds his son, 'Son of Man' or 'Second Man.' Along with these two there exists a third and female principle, 'the Holy Ghost.' Illuminated by the First and the Second Man, she produces another male principle, 'Christ.' But the overflow of the light communicated to her causes her also to produce the male-female Sophia or Prunicus, who sinks into the depth and assumes a body. The heavens are formed out of her body as she struggles to rise, and, finally, she raises herself to her Mother. Meanwhile, however, she gives birth to a son, Ialdabaoth, who begets sons in his turn, and thus there arises the Hebdomad, or group of seven planetary powers. Ialdabaoth, opposed by his sons, begets from the lowest matter another son, Nous, who is formed like a serpent; and by him he is led to believe himself the Supreme God. But his Mother reveals to him the existence of the true God, and, in order to distract the attention of the other six powers, he unites with them in creating man. The man thus formed is at first inert and shapeless, but Ialdabaoth breathes into him the breath of life, and thereby empties himself of his power, while man is inspired with the knowledge of the Supreme God. The wrath of Ialdabaoth is kindled, and he endeavours to keep man in ignorance and subject him to his own ordinances; but man, on the impulse of Prunicus, transgresses the will of the tyrant, and is driven by him out of Paradise. Henceforward the malign influence of Ialdabaoth moves through human history; but Prunicus has pity on man, and the prophets whom she sends in a constant succession keep alive in him the knowledge of the light. Finally, at her prayer, her Mother requests of the Supreme God that Christ should come to the help of man. Descending through the seven planetary spheres, he unites himself at the Baptism with Jesus, the son of Mary, and through him proclaims the unknown Father. Ialdabaoth and his sons bring about the crucifixion of Jesus, but Christ and Sophia ascend to the higher world. The crucified Jesus is raised in a spiritual body, and for eighteen months reveals the mysteries of Gnosis to his disciples. Then he is exalted to heaven, where Christ sits at the right hand of Ialdabaoth, drawing to Himself all souls which possess the spiritual nature. The consummation is effected when all the lost light is gathered together and restored to the higher world.

This example will illustrate the character of the Ophite systems, and a few brief notices will suffice for the others. The *Justinian* mythus bears a marked resemblance to that which has been outlined, except that it reverses the part assigned to two of the chief figures. The female principle Edem (corresponding to Prunicus or Sophia) is the hostile agency who seeks to thwart the beneficent influence of the creator Elohim. The rôle of Saviour is enacted by the angel Baruch. He enlightens a series of elect spirits (pagan as well as Hebrew) before he brings the final revelation to Jesus.

The *Naassene* sect appears to represent a highly primitive type of Gnosticism, the pagan features of which are thinly veiled by transferring to Jesus the attributes of the Soter. So far as we can gather from the confused account of Hippolytus (*Refut.* v. 2-5), the Naassenes assumed a Primal Being (First Man), in whom the whole universe (including the material world) potentially exists. His nature is threefold—material, psychical, and pneumatic—and the world-process consists in the segregation of these three principles. By the work

of creation the Divine Being purifies Himself of the material and psychical natures, in order to attain to His true life as absolute Spirit. In man, as in the First Man, the three natures are united, and require likewise to be separated. The process whereby the spirit in man may be set free from the alien elements adhering to it is revealed by the Saviour Jesus. (In the Naassene hymn preserved by Hippolytus we have an authentic document of the highest value for the study of earlier Gnosticism.)

Closely related to the Naassenes were the *Peratae*. Their name most probably points to an origin in the Euphrates valley, although it was explained by themselves as signifying that they had passed across the gulf of the transient and phenomenal. Like the Naassenes, they taught the doctrine of a tripartite being who had proceeded from the eternal Father. The Saviour was endued with the three natures, in virtue of which he carried out the work of separation alike in the cosmic realm and in the world of men.

The *Sethians* took their stand on the Persian dualism, and may originally have been a Zoroastrian sect. But along with the two opposing principles of Light and Darkness they allowed room for a mediating principle, the Spirit, conceived as a subtle odour diffusing itself through all things. Sparks of the heavenly light become intermingled with the darkness, and strive to free themselves with the aid of the Spirit. Their deliverance is at last effected by the Logos, to whom they are drawn like grains of iron to a magnet, escaping from the fetters of the body and the rule of the inferior God.

The so-called *Docetae* conceived of the Primal Being as a seed, infinitely small and yet containing in itself infinite potentialities. There proceed from Him three root-æons, which, in their turn, give rise to others; and these, in their totality, constitute the world of light. The light shines down on chaos, and produces the souls of all species of living beings. From the reflexion of the Logos arises the God of creation, who forms bodies in which He imprisons the souls born of the light. The souls migrate from one to another of these bodies, until the Saviour descends and frees them from the circle of re-birth.

The *Barbelo-Gnostics* assumed an unknown Father, with whom is associated a female principle, Barbelo. A succession of Æons, in pairs of male and female, comes into being; but one of the Æons, Sophia or Prunicus, is without a consort, and, in hope of finding one, leaps out of the Pleroma, where she produces the God of creation, who believes himself to be the sole God. Irenæus' account of the sect, which at this point breaks off, is of special interest, since there can be little doubt that the Coptic writings (*Pistis Sophia*, etc.) present a variety of the Barbelo-Gnosis. Indeed, it is probable that Irenæus derived his account from the recently-recovered *Gospel of Mary*.

(b) From the various systems of anonymous Gnosticism we now turn to those which are connected with the names of definite teachers. In the view of the Fathers, these are attached to one another by a regular genealogy; and, while this may be doubted, the systems in question seem to reflect the main development of Gnosticism in its alliance with Christianity.

The name of *Simon Magus* is uniformly placed at the beginning of the series. This may be partly due to the fact that Justin Martyr, the earliest heresiologist, was himself a native of Samaria, and would be particularly interested in the Simonian sect. But the figure of Simon, although obscured by legend, seems to be historical, and the narrative in the Book of Acts may embody a reminis-

cence of his efforts to ally Christianity with the syncretistic movement. Tradition makes him a disciple of Dositheos, and from this we may infer that he was a leader in the Dosithean sect, which seems to have existed in Samaria from about the time of the Maccabees. According to Justin (*Apol.* i. 26, 56, *Trypho*, 120), he was honoured as the highest God, and his companion Helena as the Divine creative Thought (*ἔννοια*). If this notice can be accepted, he must himself have come to occupy the centre of the system which is known by his name. The treatise entitled the *Ἀπόφασις Μεγάλη*, which is quoted by Hippolytus and attributed by him to Simon (vi. 6), was more likely an anonymous document of the Simonian sect. In the Simonian doctrine—which converges on the deliverance of the fallen Helena—there is little trace of Christian influence; and this is likewise true of the teaching of *Menander*, who, according to Irenæus and Justin, was Simon's fellow-countryman and disciple. A livelier interest in Christianity begins to manifest itself in *Cerinthus* (q.v.), towards the end of the 1st century. He appears to have been the first to promulgate the Gnostic conception of Jesus as a man of pure spiritual nature, temporarily united with the heavenly Saviour. *Satornilos*, the disciple of Menander, taught that the Supreme God created the world of angels, by seven of whom, with the God of the Jews at their head, the world was formed. They made man according to an image reflected from the Supreme God, who afterwards, in pity, bestowed on their creature a spark of Divine life. The Saviour descended for the sake of rescuing man from the oppression of the inferior powers, and was Himself a man only in appearance. Satornilos is important as the link between a more primitive Gnosticism and the elaborate speculations of Basilides and Valentinus; but prior to these speculations, and in the same country of Egypt, there appeared the remarkable system of *Carpocrates*. In this system, which reflects a Christianity strongly influenced by Plato, the antinomian ideas of Gnosticism are most fully developed. Good and evil are resolved into merely arbitrary commandments, imposed on man by the tyranny of the world-rulers. Freedom from these oppressors is given through Jesus. A man like others, but of exceptional purity of soul, He remembered what He had seen in the higher world, and received power from above to escape from the world-rulers. All souls that follow the path marked out by Him are endowed with the same power, and may even rise superior to Jesus. In order that they may pass through every phase of experience in their ascent to God, departed souls must undergo a series of re-incarnations; but the stronger souls are able in their lifetime to traverse all experiences, and so free themselves at once from the bondage of the lower law.

The teaching of the two great masters of Gnosticism forms a large and complex subject by itself, and is discussed in special articles (see *BASILIDES* and *VALENTINUS*). In the case of both of them the doctrine of the founder has to be carefully distinguished from that of his school. The nature of the original systems has been much debated; but, so far as we can gather from the scanty quotations, they had many points of affinity with the more primitive Gnosis—Basilides connecting himself with Satornilos, and Valentinus with the Ophite sects. Irenæus' account of Basilides is probably much nearer to the original than that of Hippolytus, but itself represents a later doctrine, in which an attempt is made to mitigate the uncompromising dualism of the earlier teaching. The theory that the Basilidean doctrine as set forth by Hippolytus is based on a 'mystification' has now

been generally abandoned. Not only is the system too profound and original to be the work of a casual forger, but it agrees in not a few important details with the teaching described by Irenæus, and may well reflect a further development of that teaching in its progress towards pure monism. From the account in Hippolytus, too, we are enabled to understand why the Basilidean influence ceased to play a part in the later history of Gnosticism. The cardinal Gnostic positions had been gradually abandoned by the disciples of Basilides, and his Gnosis merged itself at last in the ordinary philosophical speculations of the age.

The Valentinian movement, on the other hand, while it freely admitted the philosophical element, never ceased to be faithful to the distinctive Gnostic ideas, and drew into itself practically the whole stream of later Gnosticism. Hippolytus recognizes two separate Valentinian schools—the Italic or Western, and the Anatolic. To the Eastern school he assigns Theodotus and Bardesanes; to the Western, Ptolemæus, Heracleon, and Marcus. But the points of difference on which he insists appear somewhat arbitrary and superficial; and perhaps we arrive at a truer division when we conclude that Gnosticism, under the Valentinian influence, proceeded in three main directions. (1) The mythological and ritual elements were exaggerated—as in the Marcosian system, with its intricate machinery of symbolism, and mystical letters and numbers. Gnosticism in this phase of its development was ultimately absorbed in the magical and cabalistic lore of the later centuries. (2) The speculative tendency became predominant. Although the mythological scheme was retained and even amplified, it was subjected to a process of allegory. The history of the Æons was construed as a theory of the unfolding of the Divine consciousness. Ideas borrowed from Plato were interwoven with the mythical data, and served, in great measure, to disguise their real character. (3) The Gnostic beliefs were assimilated more closely with those of the orthodox Church. By so adapting itself, Gnosticism vastly enhanced the success of its propaganda, and continued to survive, even when its day was finished, in heretical Christian sects. Of this phase of the movement the outstanding example is Marcion (*q. v.*). That he is legitimately reckoned among the Gnostics must be admitted, not only in view of his undoubted dependence on the Gnostic teacher Cerdon, but because of the distinction which he drew between the Supreme God (*ἀγαθὸς θεός*) and the Creator, and his consequent rejection of the OT. But the ground-work of his theology was Pauline; and it was mainly in the interest of an exaggerated Paulinism that he accepted the Gnostic positions. It is probable that a similar judgment must be passed on Bardesanes, the last of the great Gnostic teachers (A.D. 154–240). The true character of his system is hard to recover from the contradictory records; but the judgment of Eusebius may be accepted that he was at first a disciple of Valentinus, and then turned to Christianity without completely abandoning his former errors (*cf.* the discussion by Haase, *Zur bardesanischen Gnosis*). Unlike Marcion, he seems to have held fast to the conception of one all-creating God; but he combined the Christian position with ideas of an astrological nature taken over from Gnosticism. Whether the hymns preserved in the *Acts of Thomas* can be ascribed to Bardesanes is doubtful. It has been clearly proved, by the investigations of Preuschen and Reitzenstein, that they are adapted throughout from pre-Christian sources; and the work of Bardesanes, if he had a part in them at all, can have been little more than editorial.

8. Results of the movement.—From a very early time the danger that threatened Christianity from

the side of Gnosticism became apparent, and in the NT itself we meet with a polemic which was almost certainly directed against incipient phases of the movement. The false teachers who are condemned in Colossians seem to belong to a variety of Jewish Gnosticism. The heresies contemplated in the Pastoral Epistles and in the messages to the Churches in Revelation are even more evidently of a Gnostic type. The Fourth Gospel rests upon the thesis that 'the Word was made flesh'; and, in view of the close relation between the Gospel and the 1st Epistle of John, there can be little doubt that the writer is opposing some form of Gnostic docetism. It is the peculiarity of the Fourth Gospel that its underlying polemic against the Gnostic teaching is combined with a certain sympathy. We are enabled to understand how, in spite of misgivings, the Church was led to compromise with the heretical movement, and so to encourage the attempt at an alliance. In the opening decades of the 2nd cent. the alliance had become imminent, and the Church was fully awakened to its danger. The letters of Ignatius are marked by the sharpest antagonism to the new doctrines; and all through the century this conflict with Gnosticism is the dominant interest in the theological life of the Church. The objections most frequently urged against the heresy are (1) its hostile attitude to the OT; (2) its doctrine of a higher God who is other than the Creator; (3) its docetic view of the Person of Christ; (4) its ethical teaching, ascetic or libertine; and (5) its denial of the Resurrection. These, however, were only the particular errors on which the ecclesiastical writers laid hold for the purpose of controversy; and beneath all else was the sense that the very existence of the Church was imperilled. Unless it closed the door on the heretical teaching, Christianity would be dragged into the vortex of contemporary syncretism, and would disappear as a separate religion.

The struggle to overcome Gnosticism was fraught with momentous consequences. (a) It led to a strengthening of the Catholic idea. As against the alien sects, which were always breaking up into new sub-divisions, the Church took its stand on its universality; and by the strict enforcement of uniformity in creed and worship it sought to make its catholic character more fully manifest. (b) It hastened the development of the episcopal form of government. The letters of Ignatius illustrate in the clearest manner how the rise of the heretical sects enhanced the position and importance of the bishop. He was at once the representative of the true Catholic tradition, and the centre around which the Church could rally, in the face of disruptive influences. (c) It made necessary a *regula fidei*—an authoritative standard of belief whereby all innovations could be tested. Out of this rule of faith, with its brief summary of the cardinal doctrines, arose the great creeds of succeeding times. (d) It contributed, more than any other cause, to the formation of the canon of the NT. The Gnostic sects were prolific in forged literature, which presented their own teachings under the sanction of consecrated names. To guard against this evil, and at the same time to define its own position more clearly, the Church was compelled to sift and collect the genuine documents of the primitive age. (e) It secured for the OT its permanent place as a sacred book. The causes which led the Gnostic thinkers to reject the Jewish Scriptures were operative within the Church itself; and in course of time would have brought about the same result. It was the conflict with Gnosticism which prepared the way for a truer appreciation of the OT. The Scriptures of the old religion were adopted by the new, to the enrichment of its spiritual heritage.

The chief results of Gnosticism were thus consequent on the reaction against it; but it made its influence felt, in a more positive manner, on the development of the Christian religion. It could not have diffused itself so widely over the world of the first two centuries unless it had answered to some real need of the time, and Christianity was able to conquer it only by the partial adoption of many of its aims and interests. In the following directions, more especially, we can discern a Gnostic influence modifying the life and thought of the Church. (a) The tendency to asceticism was strengthened. It is true that the Christian monks of the 3rd and subsequent centuries no longer appealed to Gnostic doctrine; but their contempt of the world was nothing, in the last resort, but a survival of the earlier dualism. (b) The sacramental idea of religion was more firmly established. Gnosticism had laid hold of the popular imagination by its claim to a secret praxis, which was itself sufficient to ensure all spiritual blessings. In place of the heretical ritual the Church now offered its own. The efficacy of the Christian faith was more and more identified with the value of the sacraments. (c) A mystical strain, originally foreign to it, was introduced into Christian thought. Already in the Fourth Gospel we have the example of a Christian writer otherwise opposed to Gnosticism, who was powerfully attracted by the mystical element in its speculations. The influence exerted by the Fourth Gospel was reinforced, in the course of the following century, by further contact with the Gnostic type of religion, until mysticism had worked itself into the very substance of Christianity. Here, perhaps, we can discern the most enduring of all the effects that are traceable to the Gnostic movement. (d) An impetus was given to theological research in almost all its branches. The Gnostic teachers were men of philosophical culture, and their free attitude to Christian tradition prompted them to investigations from which the more orthodox writers held back. In the letter of Ptolemæus to Flora (preserved by Epiphanius) we find the earliest attempt at Biblical criticism. The commentaries of Heraclion laid the foundations of exegesis, and afforded many hints to Origen. Marcion was the first to institute a NT canon—unwittingly suggesting to the Church its most potent weapon against Gnosticism. In the domain of theology proper, the Gnostics supplied an impulse which can hardly be over-rated; and among their other contributions may be reckoned the Christian hymn. Their literature abounded in hymns, many of them of great beauty, and these were taken over in not a few cases and adapted to the service of the Church. The recently discovered *Odes of Solomon* are possibly an instance of such adaptation.

That the Church was compelled to set itself in uncompromising antagonism to the Gnostic movement was in many ways a misfortune. Not only was it thus deprived of influences that would have proved helpful, but it suffered a partial arrest of development. The extravagance of Gnosticism was only the other side of that freedom which was the birthright of Christianity, and which breathes through the NT like a living air. To check the inroads of Gnosticism the Church had to prohibit freedom. Dogma was made rigid; the idea of new revelation was forbidden; ecclesiastical government became official and oppressive. The contrast between the 3rd and 4th centuries and the primitive period affords us a measure of the loss which the Church sustained by its triumph over heresy. Nevertheless, the victory, at whatever cost, was necessary. Gnosticism, associated though it was with much profound speculation and with a genuine and enthusiastic religion, belonged to the past. It

VOL. VI.—16

represented the final effort of paganism to maintain its hold on the world by allying itself with a new and vital faith. The whole history of the movement is a demonstration that such an alliance was impossible. In the Gnostic systems the Christian ideas were hopelessly buried under a débris of mythology; the Christian morality was sacrificed or perverted; the historical facts of the Gospel were eliminated. Christianity stood for an entirely new conception of religion, and could not develop, according to the law of its own nature, unless it broke loose from the insidious forces which would have anchored it to a bygone world. By its victory over Gnosticism the Church won its independence, and turned its face definitely towards the future.

9. The sources.—The often repeated statement that we know the Gnostics only from their adversaries can now be regarded as no more than partially true. Several extensive treatises in the Coptic language have been recovered which undoubtedly are genuine products of Gnosticism, although they reflect a late and decadent form of the movement. Three of these writings are still in process of editing, viz. the *Gospel of Mary*, the *Apocryphon Johannis*, and the *Sophia Jesu Christi*. They will appear in due course as the 2nd vol. of 'Koptisch-Gnostische Schriften,' ed. C. Schmidt. The other works comprise (1) the *Pistis Sophia*; (2) the two *Books of Jeu*; (3) a fragmentary work of unknown title and origin (Schmidt's ed. of these writings is of classical value). The *Pistis Sophia* was apparently written in Egypt towards the close of the 3rd cent., and in its existing form is a translation from the Greek. It consists of two parts, originally separate, and the title of 'Pistis Sophia' applies strictly to only the 1st part (books 1-3). Many scholars have assigned it to the Valentinian sect, but its affinities seem to be rather with the Barbelo-Gnosticism described by Irenæus (i. 29). This is true likewise of the *Books of Jeu*, which bear a close relation to the *Pistis Sophia*, and are mainly concerned with the ritual practices of the sect.

Apart from the Coptic writings, a large number of fragments, preserved by the Fathers, are to be ranked as original sources. Of special value are (1) the letter of Ptolemæus to Flora; (2) the *Excerpta Theodoti*, a series of extracts, contained in the *Stromata* of Clement of Alexandria, from the writings of one of the leading disciples of Valentinus; (3) the Naassene hymn; and (4) the hymns in the *Acts of Thomas*. Probably the controversial writings embody a great number of direct citations, but these are so entangled with summarized statements that they cannot be detached with any certainty.

For our main knowledge of the Gnostic teaching we have still to rely on the Christian polemical treatises. In the employment of these we have to make allowance not only for a controversial bias, but for a frequent lack of real understanding and adequate information. The earliest work written with the express purpose of counteracting Gnosticism was the *Syntagma* of Justin, now lost. On this writing the subsequent controversialists seem to have been largely dependent, although they supplemented its data by a further research (not always, perhaps, of a first-hand nature) into the Gnostic teachings. The great work of Irenæus, *adv. Hæreses* (*Ἐλεγχος καὶ ἀνατροπὴ τῆς ψευδωνύμου γνώσεως*), is preserved in a Latin translation, and until recent times was the chief store-house of knowledge on all subjects connected with Gnosticism. In 1842 a work was discovered which was at first ascribed to Origen, but has now been identified with the *κατὰ πασῶν αἰρέσεων ἔλεγχος* of Hippolytus. This work contributed an immense amount of fresh material, and is especially rich in data concerning the Ophite sects. For many years Hippolytus was

accepted without question as the basis of all study of Gnosticism; the estimate of him then passed to the other extreme, and his information was attributed to secondary or even to forged and garbled sources. Later investigation, however, has tended to re-establish his authority. So far as may be judged, he brought little critical discernment to bear on his material; but much of it is of the highest value, and must have been derived from first-hand documents. Irenæus and Hippolytus are the two chief Patristic witnesses; the others do little more than repeat their evidence, with occasional additions. Epiphanius, Philaster, and the pseudo-Tertullian seem to have drawn for the most part on the lost *Syntagma* of Hippolytus—a shorter work which preceded the larger one, and which was dependent mainly on Irenæus. Clement of Alexandria and Origen deal incidentally with the subject of Gnosticism. Of all the Fathers they were the best fitted to treat it intelligently and sympathetically; and their notes are always of value. But no systematic account has come to us from their hands.

LITERATURE.—Of the older works may be mentioned: A. Neander, *Genet. Entwicklung der vornehmsten gnost. Systeme*, Berlin, 1818; F. C. Baur, *Die christl. Gnosis in ihrer geschichtl. Entwicklung*, Tübingen, 1835; R. A. Lipsius, *Der Gnosticismus*, Leipzig, 1860; H. L. Mansel, *The Gnostic Heresies*, London, 1875; A. Hilgenfeld, *Ketzergesch. des Urchristentums* (following on a long series of previous writings), Leipzig, 1884; C. W. King, *The Gnostics and their Remains*², London, 1887; E. Amélineau, *Essai sur le gnosticisme égypt.*, Paris, 1887. The following may be singled out as among the most noteworthy of the later contributions: A. E. Brooke, *The Fragments of Heracleon, newly edited from the MSS*, Cambridge, 1891 (= *TS* i. 4); A. Harnack, *Dogmengesch.*³, Freiburg, 1894-97 (Eng. tr., London, 1894-99); W. Anz, *Zur Frage nach dem Ursprung des Gnostizismus*, Leipzig, 1897 (= *TU* xv. 4); M. Friedländer, *Der vorchristl. jüd. Gnosticismus*, Göttingen, 1898; G. R. S. Mead, *Fragments of a Faith Forgotten*, London, 1900 (revised ed. 1906); R. Liechtenhan, *Die Offenbarung im Gnosticismus*, Göttingen, 1901; E. de Faye, *Introd. à l'étude du gnosticisme*, Paris, 1903; E. Preuschen, *Zwei gnostische Hymnen*, Giessen, 1904; E. Buonaiuti, *Lo Gnosticismo*, Rome, 1907; W. Bousset, *Hauptprobleme der Gnosis*, Göttingen, 1911; F. Haase, *Zur bardesanischen Gnosis*, Leipzig, 1910 (= *TU* xxxiv. 4); R. Reitzenstein, *Poimandres*, Leipzig, 1904, *Die hellenist. Mysterienreligionen*, Leipzig, 1910; A. Dieterich, *Eine Mithrasliturgie*², Leipzig, 1910; J. Watson, *The Philosophical Basis of Religion*, Glasgow, 1907, pp. 248-300. E. F. SCOTT.

GOBARDHAN (Skr. *govardhana*, 'nourisher of kine').—A sacred hill and place of pilgrimage in the Muttra (Mathura) District, United Provinces of Agra and Oudh; lat. 27° 30' N., long. 77° 28' E. The hill, which is possibly the Erarasa of Ptolemy (McCrinkle, *Ancient India as described by Ptolemy*, London, 1885, p. 129), is, according to Hindu legend, a fragment of the Himalayan range, which was being carried by Hanumān, the monkey-god, ally of Rāma, to aid him in forming a bridge from the extremity of the Indian peninsula to Ceylon, when he was engaged in war with the demon Rāvana, who had abducted his spouse, Sītā. In passing Gobardhan he made a false step, and a portion of the mountain, falling, formed the present sacred hill. When Kṛṣṇa was manifested at this place, the people were accustomed to worship Indra by circumambulating the hill; but they abandoned his cultus for that of the new divinity. Indra was wroth, and, summoning the clouds from the four

quarters of the heavens, directed them to pour a deluge of water on the place. The inhabitants were in danger of being swept away, when Kṛṣṇa uprooted the hill from its base, supported it on the tip of his finger, and called his worshippers to take refuge beneath it. There they remained secure for seven days and nights, until, Indra finding his action fruitless, the heavens cleared and the people stepped out from under Gobardhan, which Kṛṣṇa quietly restored to its original site. Indra, being defeated, accepted the new god and worshipped him (Growse, p. 60). The legend probably indicates a conflict between the Vaiṣṇavite cultus and the worship of the Vedic gods. In the modern pictorial representations of the miracle the hill is shown as an isolated, solitary peak, which is as unlike the reality as possible. Hindus at the present day usually call it *Girirājā*, 'royal hill'; but in earlier literature it is known as *Annakūtā*, 'peak of corn.' There is a firm belief in the neighbourhood that, as the waters of the Jumnā are yearly decreasing in volume, so too the sacred hill is yearly diminishing in height.

The most important temples at Gobardhan are, (1) that dedicated to Kṛṣṇa as Gokulnāth, 'lord of Gokul' (*q.v.*), the image being brought over from that place on the occasion of the festival; (2) the temple of Harideva, Hari being one of the titles of Viṣṇu. This temple was erected during the tolerant reign of Akbar, about A.D. 1560, by a prince of Amber, on a site previously occupied by a succession of humbler fanes.

'It consists,' says Growse (p. 304), 'of a nave 68 ft. in length and 20 ft. broad, leading to a choir 20 ft. square, with a sacrarium of about the same dimensions beyond. The nave has four openings on either side, of which three have arched heads, while the fourth, nearest the door, is covered by a square architrave supported by Hindu brackets. There are clerestory windows above, and the height is about 30 ft. to the cornice, which is decorated at intervals with large projecting heads of elephants and sea monsters. . . . The construction is extremely massive, and even the exterior is still solemn and imposing, though the two towers which originally crowned the choir and sacrarium were long ago levelled with the roof of the nave.'

Close to this temple is the sacred tank known as Mānasī Gangā, the 'Ganges' supposed to have been called into existence by the mere action of the Divine will (*mānasa*). On one side of it are two stately cenotaphs (*chhattri*) dedicated to the memory of Rājās Randhīr Singh and Baladeva Singh of the Jāt dynasty of Bharatpur, who died in 1823 and 1825 respectively. A mile or so from the town is a third cenotaph in honour of Sūraj Mal, founder of the family, who died in 1764. Close to the hill stands the village of Anyor, where are annually celebrated the *Girirājapūjā*, or adoration of the sacred hill, and the *Annakūt*, or commemoration of Kṛṣṇa's sacrifice. Like most sacred places in N. India, Gobardhan seems to have been the scene of Buddhist worship. Outside the village stands a large statue of Buddha, with an inscription of the Indo-Scythian period.

LITERATURE.—F. S. Growse, *Mathura, a District Memoir*², Allahabad, 1883, p. 299 ff.; W. H. Sleeman, *Rambles and Recollections*, ed. V. A. Smith, London, 1893, n. i. ff.; A. Führer, *Monumental Antiquities and Inscriptions, North-West Provinces and Oudh*, Allahabad, 1891, p. 100 f.; A. Cunningham, *Archæological Reports*, xx. 4b. W. CROOK.

G O D.

Philosophical.—See THEISM.

Primitive and Savage (A. LANG), p. 243.

Arabian, pre-Islāmic (D. S. MARGOLIOUTH), p. 247.

Assyro-Babylonian (J. D. PRINCE), p. 250.

Biblical and Christian (W. T. DAVISON), p. 252.

Buddhist (A. S. GEDEN), p. 269.

Celtic.—See CELTS.

Chinese (W. A. CORNABY), p. 272.

Christian.—See 'Biblical and Christian.'

Egyptian (A. WIEDEMANN), p. 274.

Greek (L. CAMPBELL), p. 279.

Hebrew.—See 'Biblical and Christian.'

Hindu (A. S. GEDEN), p. 282.

Iranian (E. EDWARDS), p. 290.

Japanese (T. HARADA), p. 294.

Jewish (A. E. SUFFRIN), p. 295.

Mithraic.—See MITHRAISM.

Muslim (E. SELL), p. 299.

Roman.—See ROMAN RELIGION.

Slavic (L. LEGER), p. 302.

Teutonic (E. MOGK), p. 302.

Vedic.—See VEDIC RELIGION.

GOD (Primitive and Savage).—Whether or not we may speak of the supreme, or at least superior, beings of savage and low barbaric religions as 'gods' is a matter of the definition of 'gods' and of 'religion.' To such superior beings in the beliefs of Australian tribes, Howitt, in his *Native Tribes of S.E. Australia* (London, 1904), gave the name 'All-Father,' as they are usually spoken of as 'Father ours.' He adds that (as the present writer had already pointed out in *The Making of Religion*, London, 1898, pp. 202-204) the terms 'spirit' and 'Great Spirit' are not applicable to such beings in Australia; and this holds good in almost all savage and lower barbaric religions. It would not be easy to find the Eternal spoken of as a 'spirit' in the Hebrew Scriptures, and there is nothing spiritual in Homer's conception of his Olympians. The term 'spirit' or 'Great Spirit,' in application to savage All-Fathers, or highly superior beings, is an error of European introduction. It is important to remember these facts, for current anthropological theories usually explain the superior or supreme being of savage and other beliefs as merely the idea of ghost, or spirit, carried to the highest power. From the notion of ghosts, writes Im Thurn, 'a belief has arisen, but very gradually, in higher spirits, and eventually in a Highest Spirit.'¹ This is the current theory, held, with a variety of details, by Herbert Spencer, E. B. Tylor,² and their popular exponents.

The idea of a supreme being is not of late appearance in culture, and is not a reflexion from human kings. It is found among the democratic tribes of Australia, who, at most, may have a 'head-man' of the community, while the council of the mature men makes his position more or less 'constitutional.' The All-Father is not the glorified ghost of such an one, for he was before Death, in the myths, entered the world; and he still exists, usually in a world of his own, above the sky. Again, he is very seldom, if ever, envisaged as a spirit. He is simply a being, a magnified undying man, who lived long on earth, and then went to his own place, whence he watches men and their conduct, but seldom indeed takes any active part in their affairs. A good example of such a being is Atnatu, recorded by Spencer-Gillen as believed in by the Kaitish tribe, in the precise centre of Australia.

Atnatu was prior to the 'Alcheringa' (q.v.), or age of beginnings of things. 'He arose up in the sky in the very far back past. . . . He made himself and gave himself his name. . . . His sons he called Atnatu.' He expelled from his heaven a number of his sons who neglected his 'sacred services'; and they came down to earth, to which Atnatu sent 'everything which the black-fellow has.' He has wives, himself works sacred services, rejoices in the noise of the sacred bull-roarer (q.v.), and punishes mortals if they do not sound the bull-roarer at initiation ceremonies. There is a legend that he once caught up a neophyte to heaven and ate him, but found him unpalatable. He is 'a very great man, black,' and his name is said to mean, 'without anus.'³

In this self-existing being, dwelling above the

¹ *JAI* xi. (1882) 373.

² *PC* 1871, II. 109.

³ Spencer-Gillen b. 498f.

heavens, the father and benefactor of men, who are his disobedient children expelled from his abode, we recognize a familiar figure in human religion. Atnatu is said to care only for the ritual, not the moral, aspect of conduct; the latter is matter of concern to several All-Fathers among the S.E. tribes of Australia. As a self-created being (and, of course, he must have been in existence before he could create himself), Atnatu is no glorified ghost of a dead man. The 'ghost theory' or 'animistic theory' of Spencer and Tylor breaks down when it encounters All-Fathers like Atnatu, and others more concerned than he with human conduct and human fortunes both in this and in the future life. It is plain that if *these* All-Fathers are also creators, or makers of things, as they usually are, the very backward savage tribes who believe in them have, with no aid from ghosts, or spirits of any sort, arrived at a belief not easily to be distinguished from a rude form of belief in a God. The faith is touched with puerile and unseemly fables about the All-Father when he is envisaged as, when on earth, a capricious and very skilled hunter and magician. But nobody denies that Zeus and Apollo are 'gods'; yet much worse stories are told of them than of the black-fellow's All-Father. The myth about our Lord, in the old ballad, *The Bitter Willow*, is another example of the play of popular imagination around One held sacred; and the Apocryphal Gospels are also germane to the matter.

As the idea of the All-Father is so obviously the germ of, or a rough draft of, the highest of religious conceptions, as the All-Father is often creative and ethical, and as he is no glorified ghost (though Spencer-Gillen call Atnatu 'a spirit individual'), anthropologists generally ignored him, until examples of the belief from most parts of the savage world were persistently thrust on their notice. When they did see that some notice must be taken, they either (1) sought to discredit the evidence, as that of prejudiced missionaries, or of casual unscientific laymen; or (2) tried to explain away the unwelcome appearance, as if the higher elements, at least in the conception of the All-Father, were borrowed from missionary teaching and the ideas of Christianity or Islām. Though, of course, there are instances of borrowing in religion, the efforts to prove the All-Father to be a 'loan-god' have entirely failed. In the first place, the All-Father is in the *esoteric* faith of the men, in Australia, and it used to be death to reveal him to the women and the uninitiated, who were not left thus uninstructed by missionary teachers! Secondly, Howitt, in his *Native Tribes*, combats the idea that the All-Father faith in tribes known to him was of European importation. He himself knew nothing of its existence among the Kurnai and Yuin, till he was made free of their mysteries.¹ It follows that squatters and other white men who, without having been made free of any tribal

¹ *Op. cit.* 503-506.

mysteries, deny this article of native belief are negligible witnesses.

The other side is taken by Frazer and Spencer (see Frazer, *Totemism and Exogamy*, London, 1910, i. 145-153). After giving the sum of Howitt's conclusions, Frazer quotes Spencer, the explorer of the Central and North Central tribes:

'As to the "discovery" of a high ethical religion amongst the lowest savages, there is not, I am convinced, any such thing in Australia. The great difficulty is that we have had statements made on the authority of men like Gason.'

Gason was a police officer among the Dieri tribe on Lake Eyre. He knew the natives well and knew their language, which scientific visitors to a tribe hardly ever do. He appears to have confused a set of mythical beings, the *Mura Mura*, with a single great being, *Mura Mura*. Howitt gives *Kutchi* as the Dieri equivalent of the S.E. All-Father.¹ Spencer, after describing Gason as 'perfectly incapable of dealing with matters such as these,' goes on:

'In the days when the evidence of [concerning] Baiame and Daramulun was collected, the importance of securing minute and detailed information was not realised, nor was it imagined that there were men without any so-called religious ideas,' while it was easy for casual inquirers to be deceived, or, rather, to deceive themselves.²

Spencer must have forgotten that the chief authority on Daramulun is Howitt.³ Howitt also gave for other All-Fathers the information which he acquired after being initiated in the secret rites and doctrines of the Kurnai tribe.⁴ He was perfectly aware of 'the importance of securing minute and detailed information,' and was, of course, the most eminent of Australian anthropologists. Spencer overlooks these circumstances.

As to Baiame, the All-Father of the Kamilaroi, Euahlayi, and other tribes, the first author who is at all definite is James Manning, who, when very young, was advised by the aged Goethe to look into Australian religion. He began his researches about 1833-1834, when missionaries had not arrived, Melbourne did not exist, and there were no churches near his station, though his chief native informant had gone to church more than once from curiosity. Manning's notes were not written till 1844-1845. His fault is that by his Christian terminology he transforms Baiame (written 'Boyma' by him) and his son, Grogorally, who brings the spirits of the dead before him, into very close conformity with the Father and the Son of Christian doctrine. He might have done as much, speculatively, with Zeus and Apollo. His style does not invalidate the fact that as early as 1833 he found Baiame as a supreme being, with a paradise into which he receives the spirits of the deserving dead. It has been said that W. Ridley, twenty years later, invented the word *Baiame* (from *bai*, 'to make') as a name by which he might bring the Kamilaroi to a knowledge of God. Ridley, in fact, only made an etymological guess at the derivation of Baiame, who, on all the evidence, did make or create things in general.

Manning's account, setting his phraseology aside, is corroborated by Mrs. Langloh Parker (*The Euahlayi Tribe*, London, 1905) in many particulars. Manning's informant, who was much alarmed at his own temerity in revealing things hidden, refused to repeat the hymn to Baiame which, so many years later, Mrs. Langloh Parker procured.⁵ This lady, it is right to say, had read, and she drew the attention of the present writer to, Manning's notes of 1844, which were published in 1882;

¹ *Op. cit.* 89. From all that the present writer can find, *Kutchi* is here set on too high a pedestal.

² *Sp. Frazer, Totemism and Exogamy*, i. 148.

³ *Nat. Tribes*, 494 l., 526, 528, 543; and *JAI* xliii. [1884] 432 ff., xiv. [1885] 301 ff.

⁴ *Op. cit.* 492 l., 630; a much more copious account earlier in *JAI* xiv. 301 ff.

⁵ See Howitt, 501 f., for Manning, whose 'Notes on the Aborigines of New Holland' are in *Journ. and Proc. of the Royal Society of New South Wales*, xvi. [1832].

and one of her remarks as to the reason of the rarity of prayer among the Euahlayi may have been suggested to her mind by an observation of Manning's black informant. The sceptical student will do well to compare her book and her *Australian Legendary Tales* (London, 1897) with the published notes of Manning. Howitt recognized in Baiame, under the Athanasian terminology of Manning, the features of several All-Fathers who have each a Son, or deputy, mainly concerned with patronizing the tribal rites and the sacred bull-roarer. Thus a being, benevolent, creative, and guardian of the souls of the happy dead, is, under variants of his name (Boyma, Byame, Byamee), attested in 1833, 1855, and 1885-1895 by three witnesses, all very intimate with the Kamilaroi and Euahlayi tribes, and his first appearance is long prior to that of missionaries. The informants of Manning and of Mrs. Langloh Parker took every precaution against being detected in revealing the tribal secret. Thus the evidence is not quite so bad as Spencer supposes it to be.

Ridley, in 1855, published *Gurre Kamilaroi*, a text-book in Kamilaroi for native catechumens. In this he used Baiame as the translation of 'the Eternal' of the OT, relying on the native accounts of the All-Father. 'Missionary evidence' on this point is commonly rejected by anthropologists, who themselves do not know the tribes and languages of which the missionary is speaking. He is supposed to be so prejudiced by belief in a once-revealed religion that he must distort the facts. That an anthropologist may be a little blind to what he does not wish to see (as when Spencer seems to be ignorant of Howitt's own evidence) is a proposition quite as tenable. Ridley is entirely corroborated by Mrs. Langloh Parker, in her book on the Euahlayi tribe of north-western New South Wales. She settled among the Euahlayi when the nearest missionary was a hundred miles distant. She took her information from the oldest men of the tribe, comparing carefully the versions of various informants. To her, as we said, was communicated the hymn to Baiame, in a language no longer intelligible to her teachers. The result was that, whereas she came to the Euahlayi as a believer in Herbert Spencer's theory, she was obliged to yield to the evidence of facts. At funerals, and, as she was informed, at a certain point in the rites of initiation, the Euahlayi prayed to Baiame. She herself, of course, never was present at these ceremonies.¹

In another region east of the Grey and Barrier Ranges, A. L. P. Cameron is our chief informant as to aggregates of very primitive tribes, the 'nations' of the Itchumundi, Karamundi, and Barkinji. In *JAI* xiv. [1885] 344 ff. he gives a copious account of the All-Fathers of these tribes—Thatha-puli of the Wathi-Wathi, Tu-long of the Ta-tathi. One of them, like Baiame, is the Judge of the dead, who sends some to a region of fire. Cameron suspected here what Frazer calls 'a ray of Gospel truth,'² but, cross-examine as he would, could not find that there was any basis for his suspicion. As Cameron is the accepted authority for the totemic institutions of his remote and little known tribes,³ he cannot easily be dismissed as 'perfectly incapable of dealing with matters such as these.' As to 'the discovery of a high ethical religion' in Australia, a religion whose chief being sanctions unselfishness is not very low. Spencer, when he

¹ Marett, in *Man*, vii. [1907] 2 f., and 114 f., has criticized the evidence on this point of prayer as 'coloured,' and apparently thinks that Mrs. Langloh Parker's version is contaminated by that of Manning. For this reason the two reports ought to be compared. There is probably no other evidence in Australia for prayer to the All-Father, though the Dieri pray for rain to beings called *Mura Mura*.

² *Totemism and Exogamy*, i. 336, note 1.

³ *Ib.* 350-387.

writes that 'it was not imagined that there were men without any so-called religious ideas,' seems unaware that this was perhaps the prevalent opinion of anthropologists when Lord Avebury wrote *The Origin of Civilization* (London, 1870), while E. B. Tylor criticized that popular view in *Primitive Culture* (do. 1871).

It has been necessary to examine this instance of a great anthropologist's mode of treating evidence in this matter—a mode sanctioned by Frazer, who then proceeds to quote E. M. Curr, in *The Australian Race* (1886-7, i. 45), and his belief that the Blacks dress up what they have learned from missionaries 'with a view to please and surprise the Whites.'¹ Frazer neglects to inform his readers that Howitt (*op. cit.* 503-506) replied to and crushed Curr. First, Curr's own book contained evidence of the beliefs which that author rejected. Secondly, Howitt's own friends, the Kurnai, were, to the best of his knowledge, untaught by missionaries. Next, where missionaries have long been settled, as among the Dieri and the Southern Arunta, not the faintest ray of Gospel light was discovered by Spencer-Gillen among the Arunta, or by Howitt or his informants among the Dieri. Howitt found only a daemon named Brewin among the Kurnai (see *Kamilaroi and Kurnai*, Melbourne, 1881) till he was initiated into their esoteric rites and doctrines. His reply to Curr appears to have wholly escaped the notice of Frazer, who prints Curr's attack but does not notice Howitt's defence. Frazer concludes, as regards the All-Father:

'If the abstract idea of a powerful headman, kind to his own people and terrible to their foes, had blended with a belief in the immortality of the dead, it might easily have culminated in the worship of a tribal or national god.'²

But no evidence is quoted, and none is known to us, which suggests that the All-Father is 'terrible to the foes' of any Australian tribe; indeed, inter-tribal war is almost unknown. Belief in a future life, on the evidence of Howitt, Mrs. Langloh Parker, Cameron, and others, has blended with belief in the All-Father. It is unfortunate that an analysis of anthropological objections, by the most distinguished authorities, to the idea of the All-Father must be offered: the value of the objections is easily estimated when we remark on points not alluded to by the critics.

Howitt was by no means the first to bring the All-Father into full light, but the great German ethnologist Waitz (1866) had accepted the faith as unborrowed and genuine. In 1881, in his and Fison's *Kamilaroi and Kurnai*, Howitt, still uninitiated, knew nothing of the belief. In 1884-1885 he wrote copiously and with some enthusiasm about it in the *JAI*. He then spoke of the being as 'the Supreme Spirit, who appears to me to represent the defunct headman.' In 1904 Howitt³ renounced the idea that the All-Father is a spirit, but still regarded him as an idealization of a tribal 'head-man,' who had created the world or most of it, among other wonderful works, and whose very name was tabued among men on earth except on the most sacred occasions. He 'can go anywhere and do anything.' In the same work Howitt rather watered down his expressions of 1884-1885. He gave an account of such All-Fathers as he had heard of from the natives, from published books, and from correspondents; and he endeavoured to prove that the belief was a concomitant of social advance on the coast and in well-watered countries. But, in fact, he had recorded the belief among tribes with the simplest and most archaic social organization, without kins locally associated (a result of tracing descent in the male line)—tribes with descent in the female line—and among tribes

¹ *Totemism and Exogamy*, i. 151.

² *Ib.* 153.

³ *Nat. Tribes*, 503.

as far from the sea and in conditions as unfavourable as the peoples of the Darling River and its hinterland. Moreover, we have seen, on Spencer's evidence, Atnatu flourishing in a tribe of the arid and infertile centre. Again, no All-Father belief was discovered by Spencer-Gillen in the Arunta nation, in the northern tribes of the most advanced social organization, or on the coasts of the North. Thus it is impossible to make out that the All-Father was a concomitant of advance in social organization, or a belief propagated by sea-winds and plentiful rain.

Howitt (*loc. cit.*) admitted that the All-Father 'is evidently everlasting, for he existed from the beginning of all things, and he still lives. But in being so' (in being from the beginning and still living), 'he is merely in that state in which, these aborigines believe, every one would be if not prematurely killed by evil magic.'

Men can be killed; not so the All-Father, who is thus no ordinary man, and who was before Death entered the world. These are not strong arguments of Howitt. 'In this being, although supernatural, there is no trace of a divine nature'—in a benevolent and everlasting creator, in several cases the dispenser of reward and penalty in the future life! Howitt was exigent in his ideas of what 'a divine nature' ought to be. Again, the All-Father is only 'imagined as the ideal of those qualities which are, according to their [the natives'] standard, virtues worthy of being imitated.' But no moral conception of the Deity can possibly transcend the believers' ideal of moral excellence; and the gods of Homer and Hesiod and Pindar fell very far and frequently below *their* ideal of moral excellence. At this rate there can exist no being in human faith who has 'a trace of a divine nature.'

Howitt, observing that sacrifice is not offered, nor (except in very rare cases not recorded by him) prayer addressed to the All-Father, wrote: 'It cannot be alleged that these aborigines have consciously any form of religion.' It is, perhaps, no form of religion to believe that an everlasting, benevolent, and creative Being watches over and approves of human virtues. Howitt appears to have held that, where there is no worship, there is no religion. Yet he had described the worship of Daramulun, if 'dances round the [his] figure of clay and the invoking of his name by the medicine-men' are worship. What are they if they are not worship? Howitt ended by saying that 'such a change as a recognised religion' would have been brought about, if ever, by these medicine-men. By 'a recognised religion,' he appears to have meant what he recognized as religion—belief *plus* prayer and sacrifice.¹ Meanwhile, whoever thinks that belief in the kind of Being described, *plus* moral obedience, and dances and invocations of the sacred Name of the Being, does constitute religion has Howitt's high authority for holding that in Australia there was a religion, unborrowed and spontaneous—and highly unwelcome to anthropologists in general.

Not all anthropologists are so hard of belief. Van Gennep (whom nobody can call a *clérical*) accepts the evidence for Baiame as more than a tribal deity. Unscientific, of course, is the opinion of Ridley that the belief in Baiame, for example, was a lingering gleam of 'the true light,' namely, of some supernormal revelation to mankind. We have to do with facts and evidence, and Ridley's remark is no part of his evidence, but a statement of his theory. The current anthropological theory is that if, after all, we must accept the evidence as to the 'powerful headman' of a people above the sky, that belief is the result of comparatively advanced culture in favoured regions, where the relative easiness of obtaining food gives leisure for

¹ *Nat. Tribes*, 500, 506 f.

religious speculation. Yet few regions are less favoured than the steppes where the Kaitish, with their self-existent benevolent Atnatu, hunt very small deer. Their neighbours, the Arunta, have no hint of an Atnatu, but then, in Frazer's words, they have a 'theory of reincarnation . . . obviously incompatible with a deification of the ancestral spirits. . . .'¹ They also have a theory of evolution of species, human and other, in a marine environment, so that they cannot conceive of a creator or maker. The theory, granting the premisses, is elaborate and ingenious, and excludes the ideas of a God and a future life, not terrene. To work out this theory, men, we might think, need all possible advantages, but the region of the Arunta is as arid, except during the season of rain, as that of the Kaitish.

Meanwhile, it may as easily be argued that the Arunta once held the All-Father belief, and lost it, under the advance of their animistic and evolutionary speculations, as that they never had it. The usual All-Father has his subordinate, sometimes his Son, who manages the initiatory rites, and is the patron or first maker of the bull-roarer. This subordinate is a bogey, known, unlike the All-Father, to the women and children. The Arunta have him, under the name of Twanyirika; he is also known to the Unmatjera.² The Kaitish have his counterpart. The Arunta may have retained, as a bogey to scare the women, the deputy or subordinate of an All-Father, while dropping that personage. Among the Arunta, Gillen, Spencer's collaborator, discovered³ a great sky-dwelling Being, 'the great Ulthaana of the heavens.' We hear from Gillen nothing of his functions except that the spirits of the dead ascend to him and by him are cast into the sea, whence they are rescued by two minor Ulthaana and thenceforth live 'with the lesser Ulthaana.' In all probability this being was discovered in a southern branch of the Arunta not visited by Spencer and Gillen while collecting materials for their great book. Again, in a southern portion of the Arunta, C. Strehlow, intimately familiar with the Arunta language, finds a great sky-dwelling Being named Altjira Mara (Altjira the Good), who is not said to have made anything or to take an interest in mankind. The neighbouring tribe, the Loritja, have a similar being, Tukura, indifferent except as to rites.⁴

These peoples all have forms of the general Arunta theory of evolution and migratory spirit-germs born as men and women. It is more probable that, under stress of this philosophy, they have let their great sky-dwelling Being slip into the background, though 'good,' than that they have invented him for no reason, as he does not explain the world, and is not the creator or cause of anything. Spencer's section of the Arunta have entirely lost the idea of this Being; their neighbours, the Kaitish, retain Atnatu, who is benevolent but takes no interest in human conduct except in matters of ritual; while in several S.E. tribes the creative Being sanctions morality. Either the S.E. tribes began with a sky-dwelling Being destitute of *raison d'être*, and progressively clothed him with his creative, benevolent, and moral attributes, while the Kaitish (though sharing Arunta evolutionary ideas) worked him up into Atnatu, and the Southern Arunta and Loritja are just beginning to sketch an otiose but good Tukura Mura; or, on the other hand, all the tribes mentioned began with a Being who has a *raison d'être*, as a maker, father, judge, and friend; and his attributes, under the influence of the evolu-

¹ *Totemism and Exogamy*, i. 163.

² Spencer-Gillen^b, 332.

³ *The Horn Scientific Expedition*, iv. [1896] 183.

⁴ C. Strehlow, *Mythen, Sagen, und Märchen des Aranda-Stammes*, 2 vols., Frankfurt, 1907 ff.

tionary theory, have dropped gradually away, leaving Atnatu careless of human morality, and the Great Ulthaana, Tukura, and the rest otiose and negligible.

If the All-Father belief, among savages, were the latest result of human speculation, we should expect it to be the most prominent and powerful. Far from being prominent, it is, in Australia, an esoteric belief, concealed from women, young boys, and uninitiated white men. Among other peoples, ancestor-worshippers and polytheists, sacrifice and service to ghosts and gods are highly conspicuous, while the creative Being receives no sacrifice, or but 'stinted sizings,' and, often, is only the shadow of a name. He is, therefore, not the latest and brightest figure evolved by speculation, but precisely the reverse.

It has been necessary to enter minutely into the nature of our evidence for a creative and moral All-Father in Australia, because, as the natives are on the lowest grade of culture, as 'in their archaic forms of society and modes of thought we seem to touch the farthest past, the most rudimentary stage of human life now open to observation on the globe' (to quote Frazer¹), it is important to prove that they possess in many tribes the All-Father belief—a belief not based on Animism or ghosts, for these they do not adore, though in a few tribes some slight provision is made for the needs of the departed.

Many tribes, especially those of the north and centre, also believe, like almost all savages, in a pre-human, powerful, and magical race—the Alcheringa folk of the Arunta, the Mura-Mura of the Dieri. The Mura-Mura live in the sky, and the Dieri call on them, adding magical services, to make rain.² This is a form of religion, of prayer to superhuman personal powers. Concerning such pre-human and superhuman beings, as the introducers of sacred rites, many tales are told, and the pantomimic dances often dramatically represent their adventures. One tale is that of the search by a wife for the mangled remains of her husband. It is clear that such beings closely resemble Osiris, Demeter, and Zeus in low myths, and other deities of ancient polytheisms, whose adventures on earth were represented in the Mysteries of Demeter, Zagreus, and other Greek divinities. It is thus apparent that human religion could develop on three main lines: (1) that of ghost propitiation; (2) that of propitiation of these great pre-human beings (both lines leading to polytheism); or (3) that of the All-Father faith which, if steadily pursued, would tend to monotheism.

But the result of examination of the religions of the lower races proves that the accessibility to prayers and gifts, on the part of friendly ghosts and of gods, whether of animistic or of 'Alcheringesque' origin, causes such beings to be sought after, with sacrifice and prayer, while the All-Father, remote and in need of nothing that men can give, dwindles to a mere name, and is, at least, rarely propitiated by sacrifice. The chief, if not the only, exception to this neglect is in the case of Israel, whose prophets strenuously kept alive the idea of a supreme and ethical Creator, Judge, and Father. How deeply the Creator may fall from place and power is illustrated in the case of the Melanesian Massim of British New Guinea, among whom 'no cult of a superior being nor of the heavenly bodies could be discovered,' and there was but a faint hint of propitiatory relations with spirits of the dead.³ And yet, in spite of all this, the idea of a creative Being was perfectly

¹ *Totemism and Exogamy*, i. 92.

² Howitt, *Nat. Tribes*, 344 f., 394 f., quoting Gason.

³ Seligmann, *Melanesians of British New Guinea*, London, 1910, pp. 646-651.

familiar. He was a great snake, Garuboi, and had regulated human society as Baiame did; 'he separated mankind into' exogamous 'clans and named them,' giving the marriage rules. He 'made us,' said the native informants, 'the beasts, earth, and we know not what other things.' His marriage laws are now decaying, but still retain some force.

In Fiji (*q.v.*) we find, among a crowd of polytheistic gods, the same conception. The creative being is Ndengei (Williams) or Degei (Fison). He is conceived of as a serpent or as a body of stone with a serpent's head. In a hymn² Ndengei is represented as saying: 'We made men, placed them on earth, and yet they share to us only the under shell.' Ndengei has scarcely a temple, but prayers used to be made to him through the mediation of two of his sons, and there was a tradition that of old he received much sacrifice.³ He sends rain on earth. Here the gradual neglect of the creative Being is historically proved, and it is not unreasonable to suppose that Garuboi was honoured by the ancestors of the Massim.

Among the numerous worshipped gods and ghosts of the Baganda, an agricultural and monarchic people of Uganda, Mukasa held the highest rank, as a benign god of plenty, who refused human sacrifices. 'It seems to be almost certain that he was a human being,' says Roscoe.⁴ On the other hand, 'the Creator,' Katonda, 'received little honour or attention.' He 'was spoken of as "the father of the gods," because he had created all things, but not much was known about him.' Cattle were occasionally sacrificed to him, but usually they were allowed to roam about his *temenos*.⁵ Gods who 'had been human beings' were more sympathetic and easily entreated, like Saints in popular Roman Catholicism. A man or woman may pray for the intercession of the blessed Jeanne d'Arc, whose character is so sympathetic, who is so near to our idea of the tender and true.

The processes of deviation from the All-Father are perfectly intelligible and naturally human. The more Animism in religion, the more appeal to kindly spirits of men, the less theism—such is the obvious tendency; Israel, so incurious (as far as our evidence goes) concerning the dead and their propitiation, was the more free to concentrate effort on the worship of the Eternal. On this view of the case many peoples, if not all (which, of course, cannot be proved), had the opportunity of elevating their religion from such a faith as that in Baiame towards monotheism. 'But their foolish heart was darkened' (Ro 1²¹); and animal-worship may be, in some places, a result of totemism. Under the All-Father belief, in Australia, human sacrifices and other abominations of the higher barbarism, and even of Greek and Roman religion, if many legends speak true, are, of course, impossible, as nothing is given to the All-Father. He is not localized, and has neither temples nor favoured seats, for his people have no houses. There is no 'priestcraft,' for the medicine-men have not developed into priests.

The present writer's *Making of Religion* (London, 1898) gives an account of the superior beings of the religion of low races, and of the survival of All-Fathers and creators, usually neglected, in the polytheistic and animistic religions of peoples much more advanced. Thus Qing, a Bushman who 'had never before seen a white except fighting,' gave Orpen (not a missionary) an account of Cagn: 'He made all things and we pray to him'; 'more was known by the initiated.'⁶ For the Andamanese

¹ Sellmann, 437.

² Williams, *Fiji*, London, 1858, p. 217.

³ *The Baganda*, London, 1911, p. 290.

⁴ Lang, *Making of Religion*, 210.

⁵ *Ib.* 230.

⁶ *Ib.* 312.

we have Man's account of their All-Father, Puluga;¹ but A. R. Brown has recently impugned this work of Man, on the ground of his own recent researches in the Andamanese Islands.² Brown was an inquiring visitor from Cambridge; Man, who was not a missionary, knew the language of the people and sojourned among them for eleven years. He found Puluga an unborn creator who read the hearts of men. For traces of a Creator even among the Zulus, ghost-worshippers, see 'South African Religion' in the present writer's *Magic and Religion* (London, 1901). The Creator of the Dinkas (*q.v.*) of the Upper Nile has for him the evidence of an ancient native hymn.³ For African tendencies to monotheism, visible beneath their fetishisms, Waitz is still worth consulting, though he wrote fifty years ago.⁴ For abundant new evidence the later volumes of the *JRAI*, and books on the Masai, with M. H. Kingsley's works, may be consulted. For Ahone, the Supreme Being of the natives of Virginia, see *Historie of Travaile into Virginia Britannia*, by William Strachey, who studied the Indians in 1610-1612, and wrote in 1612. For the Pawnee Ti-ra-wa, Maker and Judge, see G. B. Grinnell's *Blackfoot Lodge Tales* and *Pawnee Hero Stories* (New York, 1892, 1889). For the Zuñi self-existing creator, see Cushing, *15 RBEW* (1896), 325 ff. Much evidence is contained in Schmidt's art. 'L'Origine de l'idée de Dieu' in *Anthropos*, iii. [1908] ff. For a Supreme Being among the tribes of higher and lower culture in Sarawak, see Hose-McDougall, *JAI* xxxi. [1901] 173-213, with a discussion in *Man*, ii. [1902] 85, 87, 107. For the All-Father of the Fans, see Allégret, *RHR*, Sept.-Oct. 1904.

Speculation as to the origin of the belief in such beings as we have been discussing is, of course, purely conjectural. Marett⁵ suggests that they are personifications of the bull-roarer used at rites of initiation. But, as they are often found in regions where the bull-roarer is unknown, and as the bull-roarer is found where such beings are said to be unheard of, the value of the theory is not great. If we admit it, we must go on to ask why men gave to a personified piece of wood the attributes of Baiame, Daranulun, and Atnatu. The same remark applies to Howitt's theory that these beings are idealized tribal head-men. Why should an ideal head-man be an everlasting Creator? Even the Altjira Mara of the Arunta is *ngambukula* (Spencer's *ungambikula*), 'eternal' or 'self-existing.' See also artt. on MONOTHEISM, RELIGION, etc.

LITERATURE.—This has been indicated in the course of the article.
A. LANG.

GOD (Arabian, pre-Islamic).—I. Sources.—Although numerous treatises were composed by Muslim authors bearing on the early religion of their country, it was not in their power to furnish much information on the subject; for no written manuals had survived from pre-Islamic times, and during the first century of Islām the very memory of the earlier condition was detested. Only enough then was retained to explain certain allusions in the Qur'an or the Prophet's biography; and even this is vague and contradictory. These authors, moreover, naturally regarded the Qur'anic treatment of the matter as authoritative; but, since the accounts of Judaism and Christianity given in that work are well known to be gross travesties of those systems, we have no guarantee that its treatment of Arabian paganism is any fairer or more intelligent. At most we may assume that

¹ *JAI* xii. [1883] 156 ff.

² *Man*, x. [1910] 33.

³ Lejean, *RDM*, April, 1862, citing Beltrame's *MS Dict. of the Dinka Language*.

⁴ Waitz-Gerland, *Anthropologie*, II. [Leipzig, 1866] 167.

⁵ *Threshold of Religion*, Oxford, 1909, p. 17 ff.

the religious terms employed by the Qur'an in connexion with paganism were understood by the Meccans, and that the latter were familiar with the concepts for which they stand. But we cannot trust the statement of their case by a bitter and passionate enemy. The sources whence the meagre information thus obtained can be supplemented are, in the first place, inscriptions discovered in N. and S. Arabia, which from the nature of the case mainly add to our store of names; in the second place, occasional statements by Greek authors; one of these, Uranius, actually compiled a treatise on Arabian affairs, several fragments of which are preserved by Stephanus Byzantinus.

2. Names for 'God.'—The word *ilāh* (identical with the *ilōah* of Job) is found in inscriptions belonging to various Arabian communities, and is used by the Qur'an as a common noun—e.g., 'the *ilāh* of Moses' (xl. 39); 'I know of no *ilāh* of yours save me' (xxviii. 38). A form *lāh* is quoted from an early poet (Baidāwī, ed. Fleischer, Leipzig, 1846-48, i. 4, line 25), but this may be evolved from *al-lāh*, 'the god,' where the elision of the *ī* is in accordance with Arabic morphology. *Ilāh* appears from its form to be originally a plural, and, indeed, of the earlier Semitic *il* (Heb. *ēl*), on the analogy of *shifāh* from *shaf-at*, 'lip' (where the *at* is a feminine affix). Of *ilāh* itself the Biblical *elōhīm* is a further plural, of which, curiously, there appears to be a trace in the Arabic vocative of *Allāh*, viz. *illāhumma*, which the native grammarians find the greatest difficulty in explaining. The employment of a foreign word as vocative in such a case could be paralleled. The verb derived from *ilāh*, 'to god,' means 'to take refuge with'; cf. 'I took refuge with it (*taallahtu ilāihā*), whereas had I fled from it' (*Qūt al-Qulūb* of Abū Tālib al-Makkī, A.H. 1310, i. 107). On the other hand, some think that the verb means 'to serve.' The feminine of *ilāh*, viz. *ilāhah*, is said to mean 'the sun,' just as Herodotus speaks of the sun as 'this god.'

A Qur'anic equivalent of *ilāh* appears to be *rabb*, 'great one,' 'lord'; in the singular it is always annexed ('my *rabb*,' 'your *rabb*,' etc.), but it is used absolutely in the plural; 'they have taken their doctors and their monks as *arbāb* besides Allah, whereas they were commanded to worship one *ilāh*, than whom there is no other *ilāh*' (ix. 31). Probably this word is taken over from Jews or Christians, as it occurs in the Divine name *rabb al-'ālamīn*, 'lord of the worlds,' which corresponds to *ribbōnō shel 'ōlam* in the Jewish tradition. The adjective *rabb* meaning 'great' is not used in Arabic.

The use of the form *Allāh* for 'God,' imitated in Christian Arabic by *al-Rabb*, 'Lord,' may be pre-Islamic, and the title may have been applied in various communities to their chief object of worship, but the matter is not free from difficulty. The identification of the *Allāh* of the Meccans with the *Allāhā* of the Syrian Christians may have been opportunist, like St. Paul's interpretation of the Athenian 'unknown God' (Ac 17²⁸); i.e., there may have been a deity worshipped at Mecca called *Allāh*, as is attested by the uniform Islāmic tradition, which even gives the Prophet a father named after that deity ('*Abdallāh*'), and states that the Meccans were generally known as *Allāh's* family; and of such a deity there are epigraphic traces. On the other hand, the polemic of the Qur'an assumes that the Meccans regarded *Allāh* as the Creator, and theoretically made their other deities subservient to him, though in practice they gave the others greater honour. If this could be accepted, it would strongly favour the Prophet's theory of an original Arabian or, at least, Meccan monotheism, which seems to be historically excluded. Further,

there is evidence showing that at one period in his career he wished to abandon the name *Allāh* for another. On the whole, some modification of the first suggestion seems the most plausible theory. It is a point which Islām shares with Christianity, that the Deity is regularly called only by a generic name with the article or its equivalent; the probability is, then, that the identification of the object of monotheistic worship with the Meccan god *Allāh* was at first avoided by the Prophet, but afterwards welcomed. It may be observed that the retention of the article in the vocative (*yā Allāh*) indicates that this form was used as a proper name at an early period. And the same seems to be evinced by the employment of a particular preposition in the sense of 'by' before this word only in oaths. It would also seem that the verb *alā*, 'to swear' (Heb. *ālāh*), was an early derivative; and the same may be the case with the old word *ill*, said to mean 'covenant.'

The epigraphic traces of the name are to be found in the Safaitic inscriptions, wherein a form which, it seems, should be identified with the *Allāh* of the Qur'an is found five times, but regularly preceded by the H of the vocative, e.g. *FHLH*, 'so, O Allah,' whence it is not possible to state with precision how the Safaites wrote the name when used without prefix. The feminine is similarly written *FHLT*, interpreted 'so, O Allāt'; but this formula is sometimes written *FHALT*, which is somewhat nearer to the ordinary Arabic orthography. The name is clearly that of a particular god, and not applied to gods in general. In the same inscriptions the old word *il* survives in proper names (see R. Dussaud, *Les Arabes en Syrie avant l'Islam*, Paris, 1907).

From the use of *ilāhah* for the sun there comes a verb *lāha*, 'to shine,' specially used of the mirage.

In S. Arabian inscriptions the name *shayyim*, 'patron,' often appears. With this we may compare the use of *wakīl*, 'trustee,' which is often applied in the Qur'an to God.

A name which figures in parts of the Qur'an, *al-Rahmān*, 'the Merciful' (where the word attached to the article is Heb. or Aram.), is said to have been abandoned because certain impostors adopted it in the sense of Messiah. It is found as an epithet of deities in pagan Aramaic inscriptions. In the common Islāmic formula called the *bismillāh* (q.v.), we find it wedged between the name *Allāh*, which was finally adopted, and an Arabic translation *al-Rahīm*, 'the merciful,' to prevent misuse.

3. Nature.—Herodotus, the earliest authority on this subject, says the Arabs believe only in Dionysus and the Queen of Heaven, calling the former Orotal, the latter Alilat (iii. 8) or Alitta (i. 131). Alilat is clearly identical with Al-Lāt, a goddess mentioned in the Qur'an (liii. 19; see, further, *ERE* i. 661^a). Orotal is a puzzle, hitherto unsolved. What Herodotus implied is that the Arabs assigned to these beings functions corresponding to those of the Greek god and goddess—those of Dionysus being well known. Now, it seems certain that even with the Greeks such assigning of functions was a late development, ascribed by Herodotus himself to Homer and Hesiod; the Arabian gods were all tribal or local, and gave the tribe whatever it wanted. Some other names are found in Greek authors which admit of identification—e.g., *Koze*, an Edomitic god who had priests (*Jos. Ant.* xv. vii. 9; and cf. art. *EDOMITES*, § 2 (e)), whose name appears in the phrase *qaus Quzah*, 'the rainbow'; *Dysares* (Stephanus Byzantinus, 106, 23), in Arabic *Dhū Sharā*, 'owner of Sharā,' a place famed for its lions. The Qur'an mentions in one verse (liii. 19) as a trinity 'Al-Lāt, Al-'Uzzā,

and Manāt the third, the other'; and many more such names have been collected. Al-'Uzzā, according to Ibn Ishāq († A.H. 150 [A.D. 767]), was a *house* (*bait*) honoured by certain tribes of Quraish, which Wāqidī improves into an *image* (*ṣanam*), out of which, when it was destroyed, a naked Abyssinian woman (the goddess herself) tried to depart, but her captor slew her (Ṭabarī, i. 1648; see, further, *ERE* i. 660^b). The difference between these narratives illustrates the difficulty which even the first Islāmic historians had in accommodating their minds to earlier religious theories.

The god of the Meccans seems similarly to have been a 'house'; their festival was 'the Feast of the House' (*ḥajj al-bait*; cf. *ḥag JHVH*, Lv 23³⁹). In the Qur'ān the word 'house' is used in some special theological sense where this phrase occurs, and we are told that the first 'house established for mankind is that in Bakka, for a blessing and guidance to the worlds' (iii. 90): possibly this last phrase means 'a model for all others'; 'it contains,' the text continues, 'manifest signs,—Abraham's station; and whoever enters in is secure.' The house here seems to mean 'consecrated ground,' though elsewhere the building called Ka'ba is clearly meant. Apparently, then, in the case of the local cults there was the confusion between the soil, the god who dwelt there, and something that marked it which is found in river-worships. The polemic of the Qur'ān is not directed against sanctuaries, but against certain objects called sometimes *aṣnām*, apparently meaning 'images,' such as were worshipped by Abraham's father and his compatriots, and which Abraham knocked down, mockingly ascribing the act to the greatest of them (xxvi. 71, xxi. 64). Clearly these were thought of as bearing some resemblance to human shape; each time Muhammad, before his call, approached a certain *ṣanam*, a tall white man would appear and bid him stand aside (*Dalā'il al-nubuwwah*, Haidarābād, 1324, p. 59); probably (if this story be old) the apparition was an angel rather than the god. Other old names for idols are *nuṣub* and *wathan* (plur. *authān*). The former were perhaps flat stones rather than images, since we read of animals being slaughtered upon them (*ib.*). The latter is perhaps to be identified with the Heb. word for 'old' (*yāshān*), and may, from the context in which it is used (e.g. Qur'ān xxii. 31, 'avoid the abomination of the *authān*'), be a term of abuse. Similar appellations occurring in the Qur'ān are *ṭāghūt*, evidently the Jewish *ṭā'ūt*, 'error,' used in the Targum for 'idol,' and *jibt*, possibly the γλυκῆ of the LXX.

The proper names of these deities tell us little of their character. Al-'Uzzā means merely 'the mightiest' (feminine), and resembles *al-'Azīz*, 'the mighty,' a name or epithet of Allāh. Al-Lāt appears to be the feminine of Allāh, meaning 'the goddess.' Manāt seems to be identical with *maniyyah*, 'fate.' A list given in Qur'ān lxxi. 22, 23 has the same amount of lucidity: *Wadd* ('love'), *Suwā'* ('prurience'), *Yaghūth* ('helper'), *Ya'ūq* ('hinderer'), *Nasr* ('vulture'). This last name is suggestive of zoolatry, of which otherwise Arabian paganism shows a few traces; some other names appear to be abstract, e.g. *Isāf*, 'melancholy'; or indicative of a quality, e.g. *Nā'ilah*, 'a giver' (fem.). Certain others (collected in the *Mukhaṣṣaṣ*, Cairo, A.H. 1320, x. 104) are obscure. A Sabæan deity to whom many tablets are dedicated, *Il-Maqqih*, means probably 'answering god.' The Qur'ānic description of these deities as 'names coined by your fathers' appears to be near the truth; they were mainly predicates without subjects.

4. Theology.—It is probable that, whatever the symbol, or whatever the origin of the cult, the

worshippers really thought of the deity as some one like themselves; and the Qur'ān itself, though denying their objective existence, cannot avoid treating the Arabian idols as human beings. On the Day of Judgment 'those whom they associate with God' will deny that they ever received any worship, and even call God to witness that they knew nothing about such honour being paid them (x. 29, 30); and they are charged with having instigated infanticide (vi. 138). The former scene is exactly analogous to a later passage, in which Jesus and His mother similarly repudiate the charge of having told mankind to worship them (v. 116); and the word *mushrik*, 'associator,' is applied to Jews and Christians as well as pagans, all being supposed to give some person or persons besides Allāh a share in Divine honours. The polemic of the Qur'ān assumes that the place which the pagans give these beings is secondary; they acknowledge that Allāh, and not the idols, created the world; and, indeed, they profess to worship these idols not as deities but as intercessors with Allāh (x. 19); as His daughters, treating them perhaps as the ordinary fugitive treats the females of the family to which he resorts, as more tender-hearted and less regardful of consequences than its male head. The Qur'ān comments in reply on the indignity of ascribing daughters to Allāh, when any Arab was ashamed of begetting one. The assumptions involved by this reasoning, viz. that the deities of the Meccans were all female, with the exception of Allāh, whom they regarded as father of the others, are confirmed by nothing that we know of the cults of Arabia, and appear to be of the same character as the Qur'ānic assertion that the Jews say 'Uzair (Ezra) is the son of God.

So far as the meagre evidence at hand can be used, we should infer that the Arabian deities were treated like other tribal and local gods by peoples in the anthropomorphic stage of religion. The word *'ibādah*, 'worship,' implies properly the relation of slave to master; and another old word, *'akafa*, apparently means 'wait upon,' 'attend,' in the style of a domestic servant, and this the idolaters are represented as doing all day on their deities (Qur'ān, *passim*). Another word which represents a slave's attendance is *ḥadāra*. Besides this they brought gifts of food and clothing; thus the 'house of Allāh' is still *clothed*, and sacrifices are still offered in Mecca. Al-'Uzzā was smeared with blood (*Mukhaṣṣaṣ*, *loc. cit.*). The tradition speaks of more precious offerings still—e.g., objects of gold, such as were offered by the Greeks to their gods. They were naturally witnesses to oaths, being doubtless thought of as immortal; and in certain cases they probably had priests (*sādin*, a word which appears to be connected with the Gr. σινδών, 'a sheet of fine linen') and treasurers. In S. Arabia they liked public acknowledgment of their services in the shape of eulogistic tablets. When they appeared to their worshippers, they probably did so in human shape, just as, according to the Prophet's biographers, the angel Gabriel and Satan, like Homeric deities, when they appear, take the form of some well-known man. But beyond this it is probable that Arabian theology varied as elsewhere with the intellectual capacity and bent of the worshippers. Thus there is evidence that the heavenly bodies were worshipped in some places, whether identified or not with other deities; and, even where the deity was thought of as permanently fixed in some spot, a fiction could be excogitated to enable him to accompany an expedition. The speculations, however, whereby contradictions were reconciled or blurred have not been preserved.

The almost entire absence of allusions to the

pagan cults in the relics of pre-Islamic poetry has often been noticed, and various explanations of the fact have been given. If any of this poetry is genuine, the most probable explanation is that it has undergone systematic expurgation. The theory of Cheikho, that its authors were mainly Christians, has not been widely accepted.

LITERATURE.—The *Kitāb al-ʿarab* of Ibn al-Kalbi is said to be in the press; this counts as the standard Arabic work on the subject; its author died A.H. 204 (A.D. 819). The fragments hitherto known served as the foundation of J. Wellhausen's *Reste arab. Heidentums*², Berlin, 1897. W. Robertson Smith's *Religion of the Semites*³, Edinburgh, 1894, has found many followers. Cf., further, art. ARABS (ANCIENT).

D. S. MARGOLIOUTH.

GOD (Assyro-Babylonian).—A careful study of the Assyro-Babylonian religion lifts the veil that has so long enshrouded the origins and evolution of that perfected Hebrew monotheism which was later to become the mother of both Christianity and Islām. Up to the present time the devout reader of the Old Testament has been taught that the idea of the Divine Unity as set forth by the ancient schools of the Hebrew Prophets was the result of a sudden inspiration and revelation of Himself to a 'Chosen People' by the God of the Universe, but it is now possible to comprehend how, far back in the morning of Semitic religious conceptions, the minds of this ever-religious race were tending towards a gradual development of this very idea of a single all-powerful Godhead—an idea which, however, was never to be fully developed in Babylonia or Assyria. The privilege of setting forth this magnificent conception in all its clearness was to be reserved for another branch of Semitic religious thinkers, viz. the Hebrew Prophets, who were certainly in this sense a Chosen People. As will appear from this article, the germs of the conception of a Divine Unity undoubtedly existed at a date far earlier than the beginnings of the Hebrew civilization. Indeed, the principle of a single God, first for all the tribe and then for all the world, may be said to be a common racial heritage among the Semites, who were so situated as to be able to bring this thought to a climax in the later Hebrew doctrine of the universality of Jahweh.

The earliest religion of Babylonia was what may be termed a polytheistic Nature-worship, a natural step forward from a still more primitive shamanism, or the belief that the government of the world was in the hands of a great number of benevolent and malevolent gods or spirits, whom it was necessary to placate by magic rites and spells. As will presently appear, many elements of shamanism remained as a part of the lower phases of the Babylonian religious system until the very latest period.

It is a curious fact that many ancient and modern primitive religions insist on the principle of the divine Triad. This may arise from the desire to emphasize the *multiplicity* of divine power. Some very primitive tribes look upon any number higher than two as a multitude. The ancient Sumerians, the predecessors of the Semites in the Euphrates Valley called 'seven' *i-min* (*i* = 'five' and *min* = 'two'), which certainly seems to point back to a time when these people regarded *five* as their highest numeral. It is easily conceivable that there was a time still further back in the history of civilization when *three* was considered a large number, and, consequently, instead of one or two divine principles, they conceived of three. Whatever may be the origin of the idea of a Trinity, the Babylonians undoubtedly had a double triad of gods. Since they revered the various phenomena of Nature, which worship is certainly the beginning of all religion, they naturally personified the three great parts of the whole—viz. the

heaven, under the name of the god Anu; the earth, represented by Bēl, who was also the divine type of everything on the earth; and the waters and everything under them and under the earth, whose patron was the god Ea, the deity of the Abyss. This is the first Babylonian triad of gods, and with it should undoubtedly be compared the similar Biblical division in Genesis and in Dt 5⁸, Ex 20⁴. The second Babylonian triad consisted of the sun Shamash; the moon Sin; and the planet Venus represented by the goddess Ishtar. These six deities formed the basis of the Babylonian religious system, but a host of lesser personifications of natural phenomena was also recognized. Perhaps the most important of these was the god Rammān, who was the cause of the wind and rain and of the thunder and lightning. The planets also had deities sacred to them; for example, Ninib and Marduk probably represented Saturn and Jupiter, while Nergal and Nebo were the gods of Mars and Mercury respectively. On the other hand, it must not be forgotten that the last four gods possessed attributes which had no connexion with these planets at all, but which overlapped the characteristics of certain other male deities.

At this point, the most important peculiarity of the Babylonian religion becomes apparent. Every god or goddess could be regarded from many sides, some of which were not always in harmony with the others. Thus, the sun was represented by the rising and setting sun, and by the southern and noonday sun, while Ishtar as Venus was worshipped differently as Ishtar of the Evening Star, the goddess of sexual love, and as Ishtar of the Morning Star, the goddess of war. In the same manner, Rammān was distinctly the Thunder-god as separate from the lightning. Of course, all the Babylonian deities were thoroughly anthropomorphic in conception, as was naturally to be expected. They all had wives, sons, and daughters, and even attendant spirits or demons in the Greek sense, i.e. lower beings whose chief duty was to execute the functions commanded by the greater gods. An examination of the Babylonian pantheon shows a most varied system of polytheism *so far as mere multiplicity of god-names is concerned*, but a great sameness of conception with regard to the functions of the different deities. Just here we note the first step towards a narrowing down of the divine functions.

In this connexion it should be remarked that every one of the more important Babylonian towns had its own tutelary deity, who was regarded by the inhabitants of that district as the highest of all the hosts of the pantheon. Consequently, a distinct priesthood of every such tutelary god arose in each of the cities in question; and this priesthood guarded the cult of its own particular god with the greatest reverence, often exalting him as practically the only deity whom it was worth while to worship at all. The most significant point in all this strange system is the fact that intolerance was practically unknown, particularly in the earlier days of Babylonian history, when the hegemony of the land was still an unknown quantity. As one city after the other got the upper hand, the god of the temporarily ruling city came to be regarded throughout the entire country as more powerful than all the others. Still, the worship of these other gods never ceased in their own peculiar shrines. On the contrary, the chiefs of the ruling city constantly made offerings to the gods of the conquered cities, in order to gain the confidence of the inhabitants. In this manner the tributary peoples came to consider the king of the ruling city as a patron of the cult of the conquered gods, and were consequently the

more disposed to regard the rule of the suzerain with favour. For example, when Babylon-Borsippa held the hegemony of Babylonia, they saw no inconsistency in ascribing the very highest attributes to Marduk, the sun-god, and Nebo, the god of wisdom, who were the city-gods of the capital. In the same manner, when Ur had the upper hand, its own moon-god Sin was looked upon as the chief deity of the entire land, before whom the other deities literally sank into nothingness. Yet these temporarily lesser gods were never seriously affected by this state of affairs, because it was generally recognized that at any time another city might get the suzerainty, and then its god could and should acquire the rank of chief deity in the pantheon. In short, the tutelary god of every city was worshipped in his own peculiar place as the chief deity of the universe, without interfering at all with the claims of any other god. This system is called *henotheism*, as distinct from the cruder polytheism.

Such flexibility of religious conception did not jar in the least on the ancient Babylonians, because their gods were, in reality, at no time in the later period more than mere names personifying Nature. Any name of a great god was as full of meaning to denote the divinity felt to exist in Nature as was any other great god's name; and this fact is still further demonstrated by the indefiniteness of the divine genealogy which prevailed until the latest period of Babylonian history.

The same deity is said, for example, to be the daughter of two gods, and that, too, in the same inscription! Compare, in the famous Hymn to *Bêlit*, who was the feminine counterpart of *Bêl*, and who was also regarded as being identical with *Ishtar*, the following lines: 'The exalted daughter of the judgment of *Bêl* I am. The noble heroine of my father *Sin* I am. I am the supreme one.' Here the goddess states that she is the offspring of two widely differing deities. The main point is that she is *supreme* over all other deities.

Probably no better example than this could be cited to show the indifference with which the Babylonian priesthood looked upon the genealogy of their deities, and nowhere more satisfactorily than in this passage do we see the great underlying principle of the universality of deity as such, irrespective of mere name.

It remained for the Assyrians, however, those Semitic colonists from primitive Babylonia, who established in the north that empire which was subsequently to absorb all Western Asia, to crystallize in the personality of their tutelary deity *Ašur* the principle of one central Divine figure in such a manner as had never occurred to the Babylonians. Indeed, the worship of this god *Ašur* was perhaps the nearest approach to an all-embracing monotheism which can be found in the Assyro-Babylonian religion. Unlike all other deities of the pantheon of this region, *Ašur* did *not* represent any great force in Nature, but was essentially a national god—indeed, practically the *only* god of Assyria, because in him, owing to the unprecedented success of the Assyrian arms, were incorporated all the qualities which the Babylonians assigned to various deities. It is really no exaggeration to state that *Ašur* became almost identical in character with the warlike *Jahweh* of earliest Israel. *Ašur*'s aid alone was all-sufficient in war and peace, and it is significant to observe that his devotees never attached to his train a host of minor gods, but always a number of the greater god-names. These greater gods, it will be noticed, invariably lost their identity alongside of the magnificence of the all-absorbing *Ašur*. Comparatively few other deities are invoked by the Assyrian kings, and even those few were really merged into the personality of *Ašur*; in short, they simply became *Ašur* under other names. There was, however, one great point of difference between the *Ašur*-worship and that of the Israelitish *Jahweh*.

Whereas in the Israelitish system there existed a special high-priestly class, distinct from the monarch, it was always the monarch who was the sole high priest of *Ašur*.

The symbol of this god was a standard, consisting of a double-winged disk, over which stood a figure of the god shooting with an arrow. This emblem seems to point to a solar origin for *Ašur*, as the disk always represented the sun.

In the *Ašur*-worship, then, we see exemplified the most striking tendency of the Assyro-Babylonian age towards a real monolatry, the first step towards pure monotheism.

At the same time, in spite of this obvious unifying tendency, a certain rank for the gods was duly observed by both Babylonians and Assyrians, which is portrayed in the peculiar system of assigning to each deity a specified number.

Thus *Anu*, the head of the great Triad, had as his numeral 60, which was the fundamental number of the ancient Babylonian sexagesimal system of counting. *Bêl* and his son *Ninib* had 50; *Sin*, the moon-god, had 30, the number of days in the lunar month. To *Shamash*, the sun-god, was given 20, while to *Ishtar*, the goddess of love and war, was given 15, the half of the lunar month; and to *Marduk*, the great tutelary deity of Babylon, also a manifestation of the sun-god, was assigned 11. *Rammân*, the storm-god, had 6; and *Nusku*, the fire-god, had 10. It is probable that some of the lesser numbers were assigned purely arbitrarily, because even this enumeration of the gods is not always constant.

It must not be forgotten, moreover, that the lower side of the Babylonian religion was full of all sorts of baser superstitions, undoubtedly the relics of the earlier shamanism. The people believed in a host of evil demons and lesser divinities, against whose baleful influence there existed an equally great host of conjurors of every kind.

Thus we find observers of birds' flight, soothsayers, invocers of the dead, dream-readers, etc. The incantations, of which a large number have come down to us, usually mention every kind of possible evil influence, because the conjuror never could be certain which particular influence was present in a given case. For example, 'Whatever hath afflicted the system of the man,—evil face, evil eye, evil mouth, evil tongue, in the name of Heaven be it conjured; in the name of Earth be it conjured.' Spittle played a large part in the acts of these physician-conjurors, who applied it freely to the person of the patient (cf. the act of our Lord described in *Jn 9⁶*). It seems that they also possessed the knowledge of the symptoms of many recognizable diseases, which, however, were always treated by driving out the evil spirits which were the cause of all disease. Parallels from the New Testament will readily suggest themselves.

It is not, of course, the purpose of this article to give a detailed account of the religion of Babylonia and Assyria. For the special characteristics of the many deities who appear as members of the Babylonian pantheon, the reader should consult the art. *BABYLONIANS AND ASSYRIANS*, ii. 309 ff., and the works cited in the literature at the close of this article, the chief aim of which is rather to illustrate the real oneness of deity as conceived of by the Assyro-Babylonians. Perhaps no better method of bringing out this important point can be followed than to quote at this juncture certain extracts from the religious literature, much of which shows a spirit of true devotion equalled only by the Hebrew Psalmody. Here attention may be called to only two points.

1. Like all Nature, all creatures were considered as being absolutely dependent on the Divine will for everything in life. Nothing could happen without the gods, and everything in existence was the result of the all-powerful creative Word, which is here undoubtedly the prototype of the *Logos* in the Gospel of John. This creative power of the word is admirably portrayed in a hymn to *Sin*, the moon-god, as follows:

'In heaven, who is exalted? Thou alone art exalted.
In earth, who is exalted? Thou alone art exalted.
When thy word echoeth in heaven, all the angels of heaven
cast themselves before thee in worship.
When thy word echoeth on earth, all the angels of the earth
kiss the ground.
When thy word roareth above like a storm-wind, it causeth
food and drink to flourish.

When thy word passeth over the earth, it causeth the plants to grow.
Thy word maketh fat the stable and barn; it increaseth the creatures of life.'

In much the same strain, but in this case with regard to the destructive word, we find a hymn to Marduk, the sun-god of Babylon:

'Thy word is an exalted word, which thou spreadest out over the heavens and the earth.

Upon the sea it sinketh down, and the sea draweth back.

Upon the field it sinketh down, and the meadows stand in mourning.

Upon the high flood of the Euphrates it sinketh down, and Marduk's word maketh it a pool of water.

O Lord, thou art exalted! Who can resist thee?'

2. The gods could be offended by sin, but they were always ready to show themselves merciful and gracious to penitent mankind. The birth of every single man was the act of God, and men as a race were the special creatures of the Godhead. Note how the god speaks to the king Esarhaddon: 'Put not thy trust in men; look to me; direct thine eyes to me.' The following extracts are illustrative of the offence of sin and the forgiving power of the gods:

'Who feareth not his god, is cut off like a reed.

Who honoureth not the goddess Ishtar, his limbs rot away.

Like the stars of heaven he disappeareth.

Like the waters of the night he melteth away.'

But the divine power was also merciful, and the truly sincere penitent might count upon the grace of his god:

'To my merciful god I turn me, seeking aid and sighing.

The feet of my goddess I clasp with tears.

O Lord, overthrow not thy servant.

Grasp his hand when he has fallen into the water.

Turn into grace the sin which I have committed.

May the wind bear away the misdeeds which I have done.

Tear like a cloth my many evils.'

The following example of an antiphonal Babylonian psalm illustrates still more strikingly the Divine pardoning power:

The Sinner: 'I am thy servant full of grief. I call to thee, O God.

The pious prayer of a transgressor thou wilt receive.

Thou wilt give him a gracious look, that he may live.

O thou, who rulest all things and steereest mankind,

How gracious is thy mercy which despiseth not the sighing of sinners.'

The Priest: 'The sinner's goddess and god are wroth; therefore he calleth upon thee.

Turn thy face to him and graciously take his hand.'

The Sinner: 'Thou leadest me in the right way, O God, like none other.

Give me of grace a firm look and accept my sighing.

Do thou only say: "When shall I get peace from his crying?" and let thy mood be mild.

Rage no more, O goddess. Turn thy countenance unto me.

Hear my sighing like the dove's moan; I am weary of lamentation.'

The Priest: 'With oh! and ah! and piteous plaint his heart is full.

He weepeth bitter tears and lamentably doth he lament.'

Any one of these productions reads like a Biblical Psalm. In this last example the priest plays the part of intermediary between God and man.

To sum up, then, with regard to the decidedly henotheistic-monolatric tendency of the Assyro-Babylonian religion: it is evident that the apparent confusion of their system of religion arose from the fact that these people were able to regard each and every god as the highest deity, without conflicting with the claims of any other god. The real reason for this phenomenon was that every god-name implied for them the true and all-embracing Godhead. In other words, they never lost sight of the fact—although it is probable that this was an innate feeling rather than a clearly enunciated principle—that beneath all the varied Divine appearances, there was in reality only one possible conception of the Divine. The student of this interesting system is forced to wonder why the religion of the Euphratean region never attained the highest ideal of all; to make for themselves a godhead out of Nature as a whole; to conceive of a Being with qualities like those attributed to the Hebrew JHWH, whose name is most appropri-

ately vowelled Jehovah, with the vowels of the Hebrew word *Adonai*, and equivalent in use to the word *Elohim*, literally 'gods.' Neither the Babylonians nor the Assyrians ever seem to have attained this goal, although the Assyrians came nearest to it of any Semitic people save the Hebrews. Nor do we learn anything in any source of an esoteric priestly belief in such an idea. Perhaps their minds were not sufficiently synthetic to reach this grand conception. Some scholars have thought, not without cause, that the chief reason why a pure monotheism never developed in Babylonia and Assyria was that the people had too deep-rooted a conception of a male and female principle in all their speculations regarding their deities. The Hebrews were able to go far beyond such anthropomorphism, and thus to throw off the yoke of that polytheistic henotheism which remained for thousands of years the established principle of the religions of Babylonia and Assyria.

Friedrich Delitzsch (*Babel und Bibel*, iii. 38 f.) says of the Babylonian as compared with other Semitic religions: 'Just as it is impossible for the Arab to think that his Allah, the one Almighty Creator of heaven and earth, whom Muhammad revealed, is any other than Jhvh, the one Almighty Creator of heaven and earth, whose worship Moses kept alive among his people, so the Israelites from the days of their forefathers worshipped the One God under the name Jhvh, the Moabites adored Him under the name Chemosh, the Ammonites under the name Milkom, the Decider; but all these nations mutually recognized the individual tribal gods as real and existing beings.' The fact is, of course, that a tribal god represented the popular unity, as was the case with Ašur in Assyria, and the doctrine of a 'Chosen People,' common to the Babylonians, Assyrians, and Hebrews, then arose most naturally from this general Semitic conception. The Israelitish prophets crystallized this thought into the idea of a God for all the world, but their own writings show how little success they had among the common people, who clung to the tribal henotheistic idea long after the last Israelitish prophet had spoken. But the seed of the doctrine of the Universal Godhead was sown, and this seed has borne fruit in that loftier spirit of truth which our Lord developed during His brief ministry on earth, and gave to the world to live throughout the ages.

LITERATURE.—A. Jeremias, *Bab.-Assyr. Vorstellungen v. Leben nach d. Tode*, Leipzig, 1887; P. Jensen, *Kosmologie der Babylonier*, Strassburg, 1890; A. H. Sayce, *Rel. of the Anc. Babylonians* (Hib. Lect. 1887), London, 1891; C. P. Tiele, *Gesch. der Religion im Alterthum*, i. 'Gesch. d. ägypt. u. d. bab.-assyr. Religion,' Gotha, 1895; H. Gunkel, *Schöpfung u. Chaos*, Göttingen, 1895; Morris Jastrow, jr., *Religion of Babylonia and Assyria*, Boston, 1898 (reviewed by D. G. Lyon in *New World*, March 1899), and *Die Religion Babyloniens und Assyriens*, vol. ii., Giessen, 1905; Fr. Delitzsch, *Babel u. Bibel*, Stuttgart, 1904, iii. (reviewed by J. D. Prince in *Amer. Journ. Sem. Lang.* xxi. 189-193); R. W. Rogers, *Cuneiform Parallels with the OT*, New York, 1912.

J. DYNELEY PRINCE.

GOD (Biblical and Christian).—The Christian conception of God, as it is held to-day, is the product of a long history, which it is the object of this article to trace in barest outline. It is the result of a gradual, but continuous, revelation on the part of God, together with a broken, fitful, and uncertain response on the part of man. The centre and pivot of the whole history is the body of writings known as the NT, or rather the events recorded in the NT and the interpretation there given to them. But the God of whom Jesus spoke, who is worshipped and believed on in the Gospels, is a Being who had previously made Himself known, and who had been the object of faith for generations in Israel. Some knowledge of the previous revelation is necessary in order to under-

stand the meaning of the phrase 'the God and Father of our Lord Jesus Christ,' while it is matter of frequent comment that the doctrine of God implied in the Sermon on the Mount seems to be removed by a wide interval from that of the Triune Deity worshipped and defined at Nicæa and Chalcedon. For a thousand years after the Fourth Ecumenical Council the Christian doctrine concerning God was practically a fixed quantity, though it was from time to time developed by the elaborate analyses, or overlaid by the ingenious syntheses, of scholastic philosophers. The modern period has left upon the Christian idea of God a mark of its own. The almost incredible enlargement of knowledge concerning the universe which has characterized modern thought, especially in the 19th cent., has profoundly influenced men's conceptions of the Divine, so that the traditional form of Christian doctrine has been enriched by a new and various content, as yet but partially assimilated and imperfectly incorporated with the old.

It has been denied that true and legitimate continuity has been preserved amidst all these changes. But, if the Christian view of God and the world be true, then, under the actual conditions of human life, revelation must be progressive on the Divine side; and the apprehension of God on the part of man will be gradual, various, and uncertain, according to the capacity and fidelity of those to whom the revelation has been given. It is the standpoint of this article that unity and continuity of conception have been sufficiently preserved, whilst growth and progress are throughout discernible. Elements in that conception may be traced back to Israel, ideas and forms of expression are due to the influence of Greek thought, the experience of the Church throughout the ages has indescribably enriched its theology, and the influence of modern science has done much to enlarge the conception of the Divine nature and operations. Still, throughout the history of Christian doctrine, the 'light of the knowledge of the glory of God in the face of Jesus Christ' has shone supreme. Christianity—a spiritual and ethical monotheism of the highest type, a religion of redemption of which Christ is both the centre and the sum—presents a consistent and ever developing doctrine of God, one that at the same time forms the true consummation of Judaism, and has proved itself to be the most potent and influential factor in the history of religion in the world.

I. *THE OLD TESTAMENT*.—The existence of a God is always pre-supposed by writers in the OT, never explained, still less argued out. But what was meant by the word, what connotation was given to the name, what attributes were implied by it, give quite other questions. The writings which record the earliest traditions on the subject range from the 9th to the 5th cent. B.C., and it is not easy to summarize the various ideas of the Divine being which find a place in them. The documentary strata recognized by criticism doubtless embody much earlier material, and may furnish evidence of the existence of primitive beliefs, not sanctioned by the religion of Israel, but influencing it to a considerable extent the thought and practice of the successive generations. It may not lightly be taken for granted that the God of Noah, of Abraham, of Moses, was identical in all respects with the God of the Jahwistic writer of 850 B.C., or of the Priestly Code after the Exile. Yet the utterance of Dt 6⁴, 'Jahweh our God, Jahweh is one,' passed the watchword of the religion of Israel in no tivial or perfunctory sense throughout the national history; and the Deity worshipped and claimed by Israel for centuries is the God of whom Jesus said that the first great command-

ment in the Law was to love Him with heart and mind and soul and strength.

For the present purpose all traces of primitive beliefs in pre-Mosaic religion may be disregarded. The Semitic tribes akin to the 'Hebrews' were generally polytheistic. Jos 24^{2, 15} recognizes 'the gods whom your fathers served' in the days of Terah, beyond the River. The revelation made to Abraham marked a clear stage in advance, and similar steps forward in the knowledge of God were made in the time of Moses. The God who spoke to Moses from the bush was not an unknown Deity; He was the 'God of thy father' and 'the God of your fathers'; even His name was previously known—'Jahweh the God of the Hebrews' (Ex 3^{15, 16}). In exactly what sense, and to what extent, this God was recognized by the people at large before the time of Samuel is a moot question. Materials for an answer are scanty, and some points are still in debate. Many superstitions and some idolatrous practices were retained amongst the people, while a long, steady warfare was maintained against them, with a strenuous assertion of the supremacy of Jahweh and His claim to sole allegiance and undivided service. The beliefs and practices thus indicated may be classified as (1) those which were avowedly polytheistic; (2) those which acknowledged the existence of demons, or inferior divinities; and (3) those which turned on the veneration of places, sacred stones, and sacred trees, consistent with the worship of Jahweh, though often indulged in in a spirit of disobedience and revolt.

What is, however, beyond question is the rise of a distinctive religion of Israel from amongst tribes in which polytheism, often of a cruel and licentious type, prevailed; and the attainment, by whatever exact stages, of a pure ethical monotheism of a uniquely lofty kind. The distinction between monolatry and monotheism is often a narrow one. A nation which whole-heartedly worships one God alone may change in its mode of regarding the gods worshipped by other nations. These may be viewed as inferior deities, whom it was sometimes a temptation to acknowledge and try to propitiate; or as spirits, more or less evil, that were not really 'gods'; or as 'abominations,' banned and denounced by true religion; or as empty figments of the imagination, the 'nothings' and nonentities which some Hebrew names for idols brand them as being. Indications of what are now called 'totemism' and 'tabu' may be found in the Levitical law; the divination and ancestor-worship forbidden in successive codes of legislation may have been relics of dying cults. The precise character and religious value of *'ashêrîm*, *'râphîm*, *maššêbôth*, and the religious history before the Exile do not belong to the present inquiry.

The lesson of the OT is the establishment of the worship of one God, unique, incomparable—the one God that matters. The main light shines clear, whatever vague forms flit and glimmer in the twilight around it. The history of revelation in the OT is a history of the way in which this light was seen to shine more purely and more powerfully till all the shadows of lesser deities fled away.

1. *Names*.—The names used for God were significant. *Elohm* was the generic term for Deity, *Jahweh* the personal name of the God of Israel. The term *El* was common to Semitic tribes; its etymology is doubtful. Other early names were *Shaddai* (Gn 17¹, Ex 6³), probably the Almighty or All-Sufficient One, perhaps an appellative of *El*; and *Elyôn* (Gn 14¹⁸, Ps 7¹⁶), mainly a poetical name for God Most High. The plural name *Elohm* is not to be understood as a remnant of polytheism, of which the form *Eloah* is the singular. The

plural number indicates either eminence and supremacy, or fullness and abundance of powers and resources. The origin of the sacred and characteristic name Jahweh (*q.v.*)¹ is still obscure. The attempt to show that it was a West Semitic name for the storm-god rests on conjecture only. The idea that it was gained from the Kenites is more than dubious. It should be understood as distinctly a personal name, going back to pre-historic times, but made the vehicle, or the channel, of special revelations, till it acquired a sacred character and significance, incommunicable otherwise. The interpretations of it given in Ex 3¹⁴ (EV 'I am that I am,' RVm 'I will be that I will be') are not strictly etymological in the modern sense, but are descriptive of the nature of God as then making Himself known—the one, true God, self-existent and self-sufficient, the cause and ground of all being, faithful to His promise, and constant in all His relations with His people. It would be an anachronism to draw out into a list of 'attributes' in modern fashion what none the less lies implicit in the simple sublime appellation—I AM. The content of the name was filled up in the course of history, as successive acts and manifestations showed Israel what kind of a Supreme Being it was whom they were bidden alone to worship. Jahweh remained the name for the covenant God of Israel, where the term 'covenant' indicates a special relation between God and His people, one on which the whole national history is a running commentary.

Stages of progress in the idea of God are more or less clearly traceable. But from the outset the conception was simple and concrete, not metaphysical, not an abstraction from the powers of Nature. The God of Israel was essentially (1) personal, (2) spiritual, (3) sole and supreme, (4) of an unapproachably lofty ethical character. The personality of God was pressed to the verge of extreme anthropomorphism, the language employed to describe it being popular, not scholastic; but it is not easy to determine how far the ascription to Jahweh of human limbs and organs—face, finger, arm, heart, and voice—was understood literally or symbolically. Dt 4¹²⁻¹⁵ shows at once the error into which the multitude were in danger of falling, and the corrective which, in the 7th cent., was supplied. Personality, implying a living Being, who thought, felt, and willed, and who possessed all the characteristics of personal life, is a distinctive feature of the God of the OT throughout. But this Being was spiritual, in the sense of being invisible to mortal eye and beyond all sensuous apprehension; while His power and operations were such as only a spirit could manifest, the living Will behind all being specially emphasized. Jahweh is proclaimed from the outset as sole and supreme; the ground of all other commandments is, 'Thou shalt have none other gods before me.' Other gods had but a relative existence, if they were thought of as existing at all; they possessed neither might nor right in comparison with Him who was the Creator and Sustainer of all that is.

The distinctive feature, however, of the OT doctrine of God is the emphasis that is laid on the moral character of Jahweh, who is unique, not in power only, but in wisdom, righteousness, goodness, and truth. An influential school of critics hold that the 'ethical monotheism' of the OT originated in the prophetic period which formed the golden age of Israel, from the 8th to the 6th cent. B.C. It would, however, probably be correct to say that the work of the prophets from Amos onwards was to define more clearly, and to enforce

¹ See also that art. for the occurrence of the name in Bab. documents.

more strenuously, a doctrine concerning God which was not then entirely new, though the current coin needed to be minted afresh, and distinct advance in conception was made in the prophetic period. The work of the prophets consisted mainly in two things: (1) they taught the unity and supremacy of Jahweh in relation to the whole world as well as to Israel; and (2) they proclaimed and pressed home the doctrine of His 'holiness,' in its full meaning and implications, as this had never been done before. Two names of God may be mentioned as more or less representative of these ideas—*Jahweh S'ba'oth* and 'the Holy One of Israel.' The first of these (= 'Lord of hosts') was not new, and difference of opinion exists as to its original meaning. But, whether earthly battalions or heavenly auxiliaries were intended, whether Jahweh was Lord of stars, or of angels, or of cosmic forces generally, the title in the time of the prophets certainly connotes world-wide supremacy. The name 'Holy One of Israel' emphasized the fact that the Lord of all power and might was Himself incomparably pure, and was prepared to sanctify from all evil His people who trusted and obeyed Him. 'This new name,' says Ewald, 'was the first kindling spark which showed that now the age of the Hagiocracy was beginning in Israel, in a sense altogether unexceptionable' (*Die Lehre der Bibel von Gott*, Leipzig, 1871-76, Eng. tr., *Old and New Testament Theology*, Edinburgh, 1888, p. 94).

2. Holiness.—It is not possible to consider in detail the moral qualities of which the word 'holiness' (*q.v.*) came to constitute the stem. No formal list of Divine 'attributes' is anywhere given; the qualities enumerated are not always the same, and the emphasis laid on each varied at different epochs. But substantially the same moral excellencies distinguish Jahweh from the first; compare Ex 34^{5, 6} with the latest Psalms. Almightyness is taken for granted; but stress is not laid on mere power, as was largely the case with the *ba'alm* (see BAAL). Wisdom, foresight, and purpose are distinctive features of the God of Israel throughout, though omniscience in the more complete sense of the term is not dwelt upon in earlier times, as it is, e.g., in Ps 139. The righteousness of Jahweh is a favourite theme with Amos and Micah and Isaiah, the attribute being explained throughout by its concrete bearing upon national life (cf. Is 5). In Deuteronomy, Jahweh is characterized by blended righteousness and love for His people, and the psalmists re-echo the description in verse. Mercy and tenderness are predominant Divine qualities in Hosea, as in Ps 103; lovingkindness and pity are not understood as contrasted with righteousness and justice, as the promise in Hos 2¹⁹ plainly shows. 'Jealousy' is a word used by writers of different periods to describe, not cruelty or harshness, but the uncompromising claims upon the allegiance of God's people made by His holy love. 'Faithfulness' and 'truth' are companion names, which indicate that God's words correspond with His nature, and His deeds with His words; that His present action is one with His past, and that He may be trusted as constant and unchanging in all that is to come. Finally, the word 'holy'—which in the first instance probably meant only 'divine,' that which belongs to God as such—came to stand for the whole sum of ethical excellency characteristic of Jahweh; righteousness, flawless purity, and utter antipathy to all evil being in the foreground of its significance.

3. Self-manifestation.—There is in the OT no indication of interior distinctions in the Godhead; it is an anachronism to find either the doctrine of Incarnation or that of the Trinity in its present

But the God of the OT is emphatically a self-communicating God, as opposed to a metaphysical abstraction, or a solitary, remote Deity. The forms of manifestation described, the various modes of self-revelation which mark off the God of Israel from the gods of the nations around, prepare the way for a clearer and more intimate revelation to come. The 'angel of Jahweh' or 'angel of God' spoken of in Gn 22, Ex 3, and many other passages, is not a mere messenger from God, a created being, neither is he strictly Jahweh, but Jahweh in a particular form of self-manifestation, a special revelation of the Divine presence. The 'Spirit of God,' whose name is found so constantly, and whose operations are so various and so vital in the religion of Israel, is not distinct from God, nor does the phrase imply a distinction in the Godhead. The Spirit of God is God Himself, breathing, living, active, energizing in the world—'God at work.' The Spirit is personal because God is personal; personal distinctions within the Deity find no place in the Old Covenant. As breath is the principle of human life and the source of human energy, so God possesses life in Himself, and is the spring of all life in the universe; and, when the fullness of His vital power as in any way communicating itself is dwelt upon, the Spirit of God is expressly named. There are a few passages in the later books—of which Is 63¹⁰, 'they vexed his Holy Spirit,' may serve as an example—which might seem to imply that the Spirit of God was thought of as a distinct person. But these are best understood in the light of prevailing usage, whilst they undoubtedly prepare the way for a doctrine which does not clearly appear within OT limits. See, further, art. HOLY SPIRIT.

4. Word and wisdom.—A history attaches to the two phrases, 'Word of God' and 'Wisdom of God,' which cannot here be traced out (see artt. LOGOS, WISDOM). God's word is viewed as the instrument of His working. 'He spake and it was done, he commanded and it stood fast' (Ps 33⁹; cf. Gn 1, Ps 33⁶ 147¹⁸). Also, the thought of God is mighty; His wisdom orders and controls all. But, by a natural transition, in later Jewish literature a tendency appears to personify both Word and Wisdom—notably the latter in Job 28 and Pr 8. Whether the grammatical figure of bold prosopopœia, viewing Wisdom as God's master-workman, had here passed in the mind of the writer into hypostatizing in the full sense of the term is doubtful; probably not. A distinction is discernible between the use in Job and in Proverbs, and further development is perceptible in Sirach and Wisdom of Solomon; but the poetical picture called up by the imagination had probably not given place to the idea of independent personal existence. Undoubtedly, however, in the use of these phrases a foundation was laid for the idea that the Thought or Will or Speech of God, going forth from God, might be conceived as an activity distinguished from God Himself, a manifestation of God in the world, distinct, though not separate, from His own proper Being.

5. Creation and Providence.—The relation of Jahweh to Israel is the main theme of teaching in the earlier periods; for, though He is thought of as supreme, only gradually did the idea of His relation to the world as a whole emerge. The notion of God as origin of all that exists is implicit from the first; but a doctrine of creation such as is developed in Gn 1 and embodied in many passages of 2 Isaiah and the Psalms is comparatively late. The problems of Providence dawned but slowly on the minds even of the teachers of Israel. In Job and in the later Psalms a few writers wrestle with these difficulties rather than

overcome them. The underlying postulate of religion was that Jahweh ruled and did all things well, punishing the wicked and rewarding His faithful servants. The presence and prevalence of evil were acknowledged as permitted or overruled by God, but no theodicy was constructed to account for its existence. The language employed is popular, the moral sense is keen and strong, the Divine hatred of evil is strenuously asserted, but the facts of life were accepted in a matter-of-fact, almost child-like fashion for centuries before the 'maddening riddle of the root' and a demand for an answer to it pressed upon the minds of an essentially practical people. Even in Is 45⁷ the prophet is content with describing both good and evil as forces so completely controlled by the Supreme Ruler that it may be said, 'I form the light and create evil: I am Jahweh that doeth all these things.'

6. The Exile.—The exile in Babylon was a fruitful epoch in many ways in the religion of Israel; it brought with it especially a widened horizon in the conception of God and the right way of worshipping and serving Him. Amongst the most notable changes may be mentioned the increased spiritualization of the idea of God, the purification of the ritual from doubtful elements, and a growing superiority to local and material considerations. Jahweh could manifest Himself to His people and be found a present help in time of trouble, independently of a sacred land and a consecrated temple. From this time onwards a certain universalism takes the place of earlier particularism. Jahweh is the God of the whole earth in a new sense; He has sworn that every knee shall bow to Him (Is 45²³). The destinies of the nations are in His hands, and He cares for all that His hands have made. Israel shall be the means of bringing the nations to a knowledge of Him. The captivity in Babylon, instead of weakening the attachment to Jahweh and leading to an increase in idolatry, sounded in reality its death-knell. Under the guidance of the prophets the people learned to see that the overthrow of the monarchy and the destruction of the Temple did not imply feebleness or apathy on the part of the God in whom they trusted, but were intended to be the means of leading them to loftier and more adequate views of Him. Their heart, while it trembled, would be enlarged (Is 60⁵); and they acknowledged, in the midst of their worst fears, that God's ways were higher than their ways, His thoughts than their thoughts (55⁶⁻⁷).

7. The Greek age.—In the Greek age and the following periods no change took place theoretically in the idea of God, but modifications passed imperceptibly over the spirit of Jewish religion and over the customary modes of acknowledging God, which reacted upon the very conception of Deity. There was no more any prophet in Israel (Ps 74⁹); the priest and the scribe took his place. The living God ceased to be realized as a present and active power, and the record in the Scriptures of His dealings in the past acquired a peculiar sacredness. In proportion as the Deity was conceived as transcendental, high above man, He became further off from man, and the 'pale cast of thought sicklied o'er' the simple, healthy realization of a present, gracious Friend and Protector, who was ever thinking of His people, caring for them, willing and working on their behalf. Greek culture partly roused Jewish national feeling to greater intensity and deepened devotion to the national God. But insensibly it affected habits of thought, especially among Jews of the Dispersion. The Hellenic philosophy of the period regarded God as pure Being, transcendental, impassive, inactive, existing out of relation to time and earthly

changes. The Jews were not philosophers and never precisely adopted these views, but Greek influence aided in promoting a change which had begun as early as Ezekiel, is marked in some of the later canonical books, and is still more fully illustrated in extra-canonical literature. Greater reverence is shown for God, His name, and His word; anthropomorphisms are shunned, and a sharper contrast comes to be drawn between the natural and the supernatural. 'God is in heaven and thou upon the earth; therefore let thy words be few' (Ec 5³) is a significant maxim of the 2nd cent. B.C. The LXX in its periphrases smooths away stumbling-blocks from the language used concerning God in the Hebrew Scriptures, but at the same time robs it of much force and significance. The hallowing of the Ineffable Name by never pronouncing it was at the same time a mark of superficial reverence and of diminution of religious earnestness.

The Targums bear witness to the same general tendency. Names indicating the loftiness of God—'Lord of the world,' 'the Mighty One,' 'the Glory,' and especially 'the Most High'—multiplied on the one hand, and on the other it was found necessary to introduce intermediate phrases into passages where God intervenes in human history, lest due reverence for the Highest should be impaired. Hence the use of *Memrā*, the Word of God; and later *Shekhināh*, the glorious Presence of God. In such passages as Gn 3⁸ the Targum of Onkelos reads, 'Adam heard the voice of the word of the Lord'; and in Dt 5⁵ 'I stood between the word of the Lord and you.' Later extra-canonical writings abound in illustrations. Such a passage as Wis 18¹⁵, 'Thine Almighty Word leaped down from heaven out of thy royal throne,' may be explained as a grammatical personification, but the literature of the period indicates a decided tendency to hypostatize the Word of God. The Philonian doctrine of the Logos (*q.v.*) does not come within the scope of this article, but it bears its part in a similar development of thought. Cf. art. GOD (Jewish).

The worship of God during this period underwent a corresponding change, which was partly effect and partly cause in relation to the altered conceptions of the Divine. The Temple still stood, and its ceremonial became more stately and elaborate, but comparatively few could join in it. The synagogue worship—without priest or sacrifice or formal ritual, its essence consisting in the reading of God's word to man and the offering to God of man's free and heartfelt prayers—effected a virtual revolution, and helped to perpetuate the prevailing conception of God as a spiritual Being who must be spiritually worshipped. Side by side with this the development of scribism, and an exaggerated and fanciful devotion to 'the Law' which almost deified it and put it in the place of God Himself, were the marks of a religion grown old and stiff, a formalism fanatical in its intense devotion to the letter, but impotent as a spiritual energy, because it had lost touch with the living God. The heart of the generations in the 1st cent. B.C. cried aloud for a regenerating and rejuvenating religious power which it was itself incompetent to produce.

II. *THE NEW TESTAMENT.*—An epoch was created by the appearance of Jesus of Nazareth. Himself an Israelite indeed, He had no entirely new God to announce; He begins with, takes altogether for granted, and proceeds to build upon the revelation of the one living and true God made through the generations to the Chosen People. But His teaching concerning that God and the personal manifestation of His life were such that the religious conception, which as a plant had already taken root and put forth green branches, burst into unexpected flower and brought forth new, un-

expected, and abundant fruit. Jesus assumes the fundamental conceptions of God already described. He is personal, spiritual (Jn 4²⁴ does but impressively declare what spiritually-minded Jews had long acknowledged), transcendent, yet draws very near to men in revelation and communion, unique in holiness, goodness, and the loftiest moral attributes. Thus the doctrine of God set forth in the discourses of Jesus exhibits the ethical monotheism of the prophets raised to its highest power. With this doctrine Jesus began; how far He travelled beyond it remains to be seen. The implications of His words and deeds were felt at the time to carry His hearers much further; in what direction and to what goal could not be immediately discerned.

1. *Christ's own teaching.*—The unity of God is taken for granted throughout Christ's discourses, and is explicitly dwelt on in Mk 12²⁹ as the basis of the first great commandment. The spirituality of God, emphasized in memorable words in Jn 4²⁴, also pervades the whole teaching of Jesus. The moral attributes which characterize the God of the OT all appear and reappear in the Gospels, though the emphasis is seen to lie differently, in view of the mission that Jesus had come to fulfil. Holiness and righteousness are fundamental characteristics of the Divine will; the subjects of the Kingdom are to seek righteousness above all (Mt 5^{6, 20, 6³³}). In the prayer recorded by the Fourth Evangelist, God is described as the holy and righteous Father (Jn 17^{11, 25}). The majesty of God is implied in the epithet 'heavenly' or 'in heaven' used in the Lord's Prayer and often in the Sermon on the Mount. Yet He cares for the lowliest (Mt 6³⁰); not even a sparrow falls to the ground without Him; He works everywhere and always (Jn 5¹⁷). The sunshine and the rain, the lily in its beauty, and the common grass of the field, all have their message to deliver concerning Him. He is 'good' with a goodness that far outdistances the highest standards of earth; it is such as even the teachers of Israel had not fully understood; in comparison with it no other goodness deserves the name (Mk 10¹⁸). Especially is God good as being merciful and ready to forgive. Man is most like to God when he has learned the lesson of mercy (Mt 5^{7, 18²¹}); the unforgiving cannot be forgiven (6¹⁵), but deserve severest punishment (18³⁵). God is gracious and long-suffering, but the judgment that is to come will prove that He is not slack or careless in His moral government of mankind, who are to learn reverently to fear Him in whose hands their whole destinies lie (Lk 12⁵).

These characteristic utterances, however, some of which might have come from the lips of a prophet of the Old Covenant, cannot be rightly understood without placing the emphasis where Jesus Himself placed it, and interpreting all in the light of the *Divine Fatherhood*. This doctrine appears in the OT, but it describes a relation which exists between God and Israel, not with mankind at large, or with individuals who are children of God in virtue of their personal character (see Ex 4²², Dt 8⁵, Hos 11¹). If the king is regarded as a son of God (2 S 7¹⁴), it is in virtue of his position as the head and representative of the nation. Christ's teaching on this subject differs fundamentally from that of the OT. It described three concentric circles. (1) The innermost contains One Person only. The Father occupies a peculiarly intimate relation to Jesus Himself, who, not as a Son, but as *the Son*, knows the Father as no other can (Mt 11²⁷), and has been sent specially to reveal Him (Jn 14^{6-11, 17^{4, 25, 26}}). Amongst the first recorded words of Jesus (Lk 2⁴⁹), and the last (23⁴⁶), the name 'Father' is on His lips. He used no language to describe God such as was familiar to scribes on

the one hand, or to philosophers on the other, but He often offended His hearers by the familiarity with which He claimed God as His own Father, in a sense shared by no others (Jn 5¹⁹). (2) The sense of sonship was to be enjoyed by all true disciples in their measure. 'Your heavenly Father' was the description of God which assured them that He might be trusted to supply all their needs (Mt 7¹¹, Lk 11¹³). But this conception widens out into (3) a universal Fatherhood, as of One who cares for the unthankful and the evil, and is ready to receive not only the lost sheep of the house of Israel, but all wanderers from the Father's home. It is true that the message of Jesus for Gentiles is not explicit as was His mission to the Jews, but the three parables in Lk 15 are evidently intended to illustrate a deep-seated compassion of God for the lost as such (Lk 19¹⁰)—yearnings of the Father's heart that go swiftly forth to meet all penitent children of men who arise and go to Him (Lk 15²⁰).

The characteristics that have been described have been drawn chiefly from the Synoptic Gospels. John does but emphasize the notes so clearly struck. The name 'Father' occurs far more frequently in the Fourth Gospel than in the other three put together, but all four Evangelists indicate that the word came always from the lips of Christ, not from His disciples, and the Master never ranks Himself and them together as sons. In the one passage that seems to do so He deliberately marks a distinction, saying, 'my Father and your Father, my God and your God' (Jn 20¹⁷). The universality of the Divine Fatherhood is made much more plain in the Fourth Gospel, and the word 'love' is seen to be the climactic word that describes the inmost nature of God. The unique character of the relationship between the Father and the Son is also much more fully brought out in this Gospel (Jn 5^{17a}). It must be added in a word that no quotation of the words of Christ, apart from a study of Himself, His person, and whole work in the world, can ever suffice to set forth the full meaning of His teaching concerning the Fatherhood of God.

The Son and the Spirit.—The special mission of Jesus was to announce the coming of the Kingdom of God, and Himself to lay its foundations in a Gospel message (Mk 1¹⁵). He did not at first formally claim Messiahship, though from His baptism onwards His unique Sonship was recognized (Mt 3¹⁷ 21²⁷). But the time came when His work as the Christ, who must through suffering and death accomplish the Father's will and establish His Kingdom on earth, was made clear, and His disciples began dimly to understand that He was not only the Christ, the King of Israel, but the Son of the living God in a deeper sense than the words had usually conveyed (Mt 16¹⁷). Further, Jesus had much to say, not only concerning Himself as 'only-begotten' Son,—to use John's characteristic word,—but concerning the Spirit of God (see Mk 3²⁹, Mt 10²⁰, Lk 11¹³; several other passages in the Synoptists, and especially the discourses recorded in Jn 14-16). The question, therefore, arises whether the manifestation of God in Christ was such that in His own lifetime the fundamental conception of God was modified by it, and whether a distinction of persons within the Godhead amounting to what afterwards came to be called the doctrine of the Trinity was taught by the Master and accepted by His disciples.

The question cannot here be discussed in detail (see art. TRINITY). If Mt 28¹⁹ contains the exact words of the Saviour, He did before His ascension virtually lay down this doctrine. But, quite apart from the special phraseology of this passage, it is safe to say that Christ's teaching contained the material elements out of which a doctrine of the

Trinity was formulated later. His claims for Himself, His authority, His power to forgive sins, His demands for absolute personal allegiance to Himself, and His assertions concerning His own knowledge and power and His coming to judge the world—not to speak of His miracles—were enough to show even before His death and resurrection that the new doctrine of the Saviour Christ could not but affect the old doctrine of the Ruler God. 'Who is this Son of Man?' was a question in the answer to which lay many more questions and answers, still latent. The main question, however, was not fully answered till Christ's work on earth was fully accomplished; and the full light shed on the doctrine of God by a clear doctrine of Christ was not revealed until some generations had passed away.

2. *The Apostolic doctrine of God.*—The position of the Apostles was wholly changed after the day of Pentecost. The death of their Master had greatly disconcerted them, and His resurrection formed the basis of their new message. Their early sermons and addresses were naturally not occupied with the mystery of His Person. Preaching to Jews with Calvary full in view, Peter urged that the crucifixion of Jesus was a crime, which God had overruled in raising Him from the dead, and that the meaning of both death and resurrection was to be found in the message of the Gospel. It promised remission of sins through faith in the Saviour; it heralded the establishment of the Kingdom of God with the Prince-Saviour at its head. The watchword of the whole was, 'Jesus is Lord; repent and believe in Him.' Salvation can come only through Him (Ac 4¹²); His work, now fully accomplished, forms the central theme of the new Gospel declared by Paul *en πρώτοις*, 'first of all' (1 Co 15³). The Acts faithfully reflects the gradual stages through which this position was gained, with far-reaching effects on religion as a whole.

A Christology was needed; the question, Who is this Jesus? must be answered. The theology, or doctrine of the Godhead, that followed turned upon the answer to this question. The teaching concerning the Holy Spirit did not raise the same difficulties, because the OT had so frequently used language which described the gift of the Spirit of God. But the experience of the new life in Christ, and the way in which the blessings of salvation were realized, pointed to a threefoldness in God's relation to man. Side by side with the belief in the God of the New as well as of the Old Covenant, and blending with it as a part of the same faith, was trust in a Divine Saviour and the consciousness of a Divine Spirit, Himself at work in the hearts of all believers. This experience found expression in the triple benediction of 2 Co 13¹⁴, and the baptismal formula of Mt 28¹⁹. Jesus the Christ was a manifestation of God to men, such as had never been known before; the Holy Spirit, after the Day of Pentecost, was a manifestation of God in men, such as had never before been possible. The Apostles realized that here was a richer revelation, an ampler Divine presence and blessing, which demanded fuller expression in their very definition of God, as the whole NT bears witness. The Synoptic Gospels in their measure (remembering the scope of their narratives), the Acts of the Apostles in continuing the history—Paul and John pre-eminently and at length, and other Apostles more briefly—all agree in representing the personal spiritual God, the righteous and loving Jahweh of the OT, as still believed in but displayed in a new light. God the Father *over* all, God the Son and Saviour *for* all, God the Holy Spirit operating *in* all, but especially in the believer, yet one God only, always and everywhere—this is the doctrine

of God, which, before the NT closes, has taken the place of the simpler 'ethical monotheism' of the prophets.

There is no 'doctrine' of the Trinity in the NT. But there are in it all the materials out of which such a doctrine came inevitably to be built up, together with evidence of the way in which that teaching arose out of certain central facts of history and experience, proclaimed by the Apostles and accepted by all believers as integral parts of the gospel. The intense monotheism of those who had been educated as Jews was never relinquished, but new modes of conceiving of God, of worshipping Him, and of realizing His relations to men as in some sense threefold, form an essential part of the doctrine of God in the NT. These were not so much theoretically adopted as felt to be indissolubly bound up with what believers had from the beginning held concerning Christ, and with what they themselves had enjoyed of His grace and salvation.

(1) *The Trinity*.—The testimony of Paul in 1 Co 8⁶ and elsewhere shows the process of advance. There may be, he says, 'those that are called gods'—gods many and lords many, but 'to us there is one God, the Father, of whom are all things and we unto him.' Yet, without prejudice to the unity of this one God, he adds, 'and one Lord, Jesus Christ, through whom are all things and we through him.' He also is creator and of cosmic significance; the doctrine of God henceforth is mediated through Christ. Lordship is the essential word. *Kύριος* renders the OT *Jahweh*, and in Ro 10⁹⁻¹³ the word is used of Christ in such a way as to show His essential Divinity. His standing name and title is 'the Lord Jesus Christ'; He is preached as Lord (2 Co 4⁵), and the characteristic watchwords of unbelievers and believers respectively are 'Anathema be Jesus!' and 'Jesus is Lord' (1 Co 12³). Nor is this Lordship a merely temporal office and honour. His pre-existence is implied in 2 Co 8⁹, Ph 2⁶, and Col 1^{15a}. All interpreters are not agreed that in Ro 9⁵ Christ is styled 'God over all, blessed for ever,' though this is the natural interpretation of the words; but few can doubt that in Tit 2¹³ the appearing in glory is expected of Jesus Christ, 'our great God and Saviour.' Paul's language concerning the Holy Spirit does not bear so immediately upon his doctrine of God, because the word 'Spirit' sometimes indicates a gift of God to men and sometimes God Himself working in men, as it did in the OT. A closer examination shows that the Holy Spirit is not a mere gift or influence; yet, while Divine, He is not the whole Godhead. The intensely personal language employed in such passages as 1 Co 2^{10, 11}, Ro 8^{15, 26}, and elsewhere, combined with the distinction maintained between the Spirit and Christ, the Spirit and the Father, makes the interpretation of the Holy Spirit in an OT or 'Unitarian' sense impossible. Again, apart from the phraseology of benediction in 2 Co 13¹⁴, the general tenor of description in such passages as 1 Co 12⁴⁻⁶ and Eph 2^{18, 22} shows that St. Paul thinks easily and naturally in terms of a Tri-unity in the Godhead, when speaking of Divine operations in the salvation of men and in the worship of the Church.

The author of the Fourth Gospel declares that his object in writing is that men may believe that 'Jesus is the Christ, the Son of God, and that believing they may have life in his name' (Jn 20³¹). The whole Gospel proves that the Sonship thus indicated was understood as one not merely of office, or mission, or ethical likeness, but of eternal and essential nature. He who shared the Father's glory before the world was is the one Saviour of men, the Way, the Truth, and the Life. The writer sometimes makes use of phraseology not

found elsewhere in the NT. His doctrine of the Logos in the prologue strikes the key-note of the whole Gospel, though the note itself is not repeated throughout its chapters, the name of the Son taking the place of the Word. There is no inconsistency in this, for in a narrative of the personal life of the Logos Incarnate the emphatically personal name 'Son' is obviously the more appropriate. *Logos* is a convenient name for summing up certain ideas concerning God, which are characteristic of Paul as well as of John, though the former never uses the word. Paul expresses the same thought when he speaks of *εικόν, πλήρωμα, μορφή θεού*, of One through whom are all things, in whom all things cohere, and in whom all are to be summed up (Col 1^{16a}). Similarly, the Logos is *θεός*, not *ὁ θεός*, God, not the Godhead. Thought and Speech, Reason and Utterance, *Sermo* and *Ratio* unite in the *λόγος, Verbum*, the Word. The Logos in Philo is not personal; but the prologue to the Fourth Gospel, beginning with the transcendent God, sets forth the Divine Word as personal, extra-temporal, in closest relation with God, and as so present and operative in creation, preservation, and the subsequent redemption of the world that all things are 'in and through him.' The same is He who became flesh, and who in the flesh spoke words and did works so symbolic of eternal reality that His whole life is one work of eternal significance, and that all man's duty may be summed up in the work of 'believing on Him.' The silent substitution of 'Son' for 'Word' in the Gospel and the absence of Logos from the first Epistle (1 Jn 1¹ notwithstanding) are significant. When the Word becomes flesh His name is 'Son,' and the various readings in Jn 1¹⁸ show how closely connected in Apostolic tradition were the ideas of 'only-begotten Son' and 'God only begotten.'

A modification is here implied in the OT idea of God, which might seem to necessitate a fundamental break in continuity. But in the teaching of both Paul and John concerning Christ there is nothing inconsistent with the unity of God, who for both of them remains still the One King, Eternal, Immortal, Invisible. It is significant that two writers occupying such different standpoints, and using such diverse phraseology, should unite so completely in what may seem a paradoxical position. Paul concentrates attention on redemption—sin, righteousness, and salvation through the death and resurrection of Christ; John's main theme is revelation—light, truth, and life eternal, the Incarnation rather than the Crucifixion being the centre of the whole. Yet both Apostles prove to demonstration that the Redeemer whom all Christians acknowledged and trusted, faith in whom constituted the very essence of the new religious life in the world, was Himself very God; and, whilst maintaining an intense monotheism as an unassailable axiom of religion, they worshipped in the one Godhead, as distinct yet inseparable, the Father, the Son, and the Holy Spirit.

(2) *God is Love*.—The ethical attributes distinctive of Jahweh in the OT are exhibited in the NT in an added light which, while it preserves, transforms them. Holiness and righteousness, faithfulness and truth, mercy and loving-kindness, are still characteristics of the one true God, but to each of the words is given a connotation so rich and deep that the use of the old words embodies a new gospel. One word, moreover, not entirely new, acquires so predominant, so consummate a place in the conception of God that henceforth it surpasses and encompasses all the rest—GOD IS LOVE. Not that love eclipses righteousness, still less is opposed to it. If with Paul the idea of righteousness seems to predominate, it is he who writes in 1 Co 13 the immortal hymn of love. If

it was left for John to expound the love of God in such a way as to mould Christianity all through history, it is he who makes the strongest and most uncompromising declarations of His righteousness that are to be found in the Bible. Neither of the Apostles can conceive of a God in whom the two attributes are not eternally and indissolubly blended; but only in Jesus Christ, Son of God and Son of Man, is to be found the abiding proof that God is both righteous and merciful in the deepest sense of the words; and only through Christ can man reach and maintain his true relation with a God of infinitely holy love.

Granted the premisses that the Son of God has come to earth, suffered, died, and risen again for man's salvation, then all previous Divine manifestations pale before this stupendous Light of the world. Paul's theme in his greatest Epistle, the one which contains the fullest account of his central preaching, is *δικαιοσύνη θεοῦ ἀποκαλύπτεται*, God's righteousness is revealed from faith unto faith (Ro 1¹⁷). Whether the righteousness of God means an attribute of His own nature, or a state or condition of man that is derived from and acceptable to Him, in either case much light is shed by the phrase upon the character of the God whom Paul preached. These two meanings are joined together later in the Epistle, where it is said that the object of the work and sacrifice of Christ was that God might be shown to be righteous Himself, whilst at the same time free to pardon and account as righteous every believer in Jesus (Ro 3²⁶). So far, therefore, as an exposition of the Divine nature is summed up in the phrase 'righteousness of God,' it is clearly not to be understood as bare and hard 'justice'; it combines flawless purity and perfect rectitude with a merciful provision by which a sinner may be freed from sin and obtain forgiveness in perfect accordance with the eternal law of righteousness. The climax of the argument, however, is not yet reached. Paul goes on to show that God commends His *love* towards men in that, while they were yet sinners, Christ died for them (Ro 5⁸), and the full revelation of the God in whom he trusts appears only when, in a burst of lyrical fervour, he exclaims that nothing in heaven or earth or under the earth can separate the believer from the love of God which is in Jesus Christ our Lord (8³⁹).

Whilst Paul's theme in these chapters seems to be the salvation of man, and his reasoning upon it has been described as narrowly 'forensic,' he is in truth setting forth what amounts to an entirely new revelation of the innermost nature of God. John does the same. Having declared that God is Spirit and God is Light, he leaves it on record twice, before the canon closes, that God is Love (1 Jn 4⁸⁻¹⁶). The meaning of this simply sublime utterance, which when it stands alone may easily be misunderstood, is found in v. 10 'Herein is love, not that we loved God, but that he loved us and sent his Son to be the propitiation for our sins.' Strike out this fact, and the significance of the teaching of both Apostles is entirely changed. Leaving out the Cross of Christ, the discussion whether God is Love or no sinks to the level of the question, 'Is the universe friendly?'—an interesting but altogether different question, in which premisses, methods of proof, conclusions, and the very meaning of words are altogether altered.

It is impossible adequately to define love, but the conception which prevails in the NT is that of goodness spending and imparting itself to others in self-sacrifice. And the cardinal characteristic of its doctrine of God is that love in this high and sacred sense is His very essence.

Each word in the definition must be raised to its highest power: goodness conceived of as consummate, incomparable, self-impartation beyond human power or conception, realized in self-sacrifice so complete that no word but 'infinite' describes it. Whilst some other religions may have risen to a part of this conception, that of the NT alone sets forth as its central feature a Holy God in uttermost self-sacrifice for the salvation of men. It declares the exaltation of God above the universe in His excellence and glory, but its Gospel is that He is also within the universe, and, especially in the history of man, loving, striving, suffering, agonizing, because only thus can His free and disobedient children be brought to love and to do His perfect will. The conviction that this doctrine—in itself stupendous and incredible—is true is based on certain facts of history and on the interpretation put upon them by those who lived nearest to Christ and understood Him best.

The light thus generated shines out on other aspects of the Divine nature and on all God's relations with the world, in ways which it is impossible to trace here. Providence is to be studied in the light of the Gospel. The dark places of personal, social, national, and racial history are illumined by the Cross. A theodicy is possible in the light of 'I, if I be lifted up from the earth, will draw all men unto me' (Jn 12³²), and 'He that spared not his own Son but delivered him up for us all, how shall he not with him also freely give us all things?' (Ro 8³²). Christ becomes the centre of human thought and the goal of human life if He is Himself accepted as the interpretation of human history. Christology is for the Christian the heart of all theology. The Eternal Word has relation to all the worlds, but for this world and for man's comprehension of the mind and heart and will of God, the Word of God is Christ. Such at least is the teaching of the NT at its highest point, and it claims to shine by its own light as the purest and loftiest revelation of the Divine known in the history of the world.

III. *THE FORMATION OF THE CHRISTIAN DOCTRINE OF GOD.*—The Apostolic writings attempt no metaphysical explanation of the new conceptions of God which unquestionably dominated the whole experience and life of the earliest Christians. The doctrine of Father, Son, and Spirit, as embodied in the baptismal formula, implied trinity. The threefoldness of the Divine manifestation and operations, as well as the underlying unity of the Divine essence, is recognized throughout the Epistles. That Jesus is Son of God as well as Son of Man, and that the Spirit is Divine and personal, closely related with Father and Son, is assumed, but no attempt is made to show how this is reconcilable with the monotheism which was an unquestioned and unquestionable axiom in the thought of the Apostles and their converts.

The next three centuries witnessed the unfolding of what lay implicit in this teaching. The relation between the earlier and later stages is usually described as 'development,' but that word does not necessarily indicate a process in which literally nothing is added but what was actually present in the germ. The more correct, though pedantic, biological term, 'epigenesis'—a progressive differentiation and integration—connotes more than the bare explicating of the implicit: it is rather the gradual organizing in one whole of elements which the separate constituents before organization did not possess. Unquestionably the changing environments of the Church through the centuries contributed largely to the shaping both of faith and of theology. Christianity furnishes an example of 'creative evolution' in which the energy of a new spiritual life adapts, assimilates, and utilizes, as

well as unfolds. From the standpoint of Christianity a believer in a living God can never resolve 'development' into a mechanical process governed by natural laws. For him the God who has revealed Himself in Christ is still the ever-to-be-known God who illumines His Church in all generations by His Spirit. The change from the heavenly Father of the Sermon on the Mount to the dogma of the Trinity in the creeds of Nicæa and Chalcedon has been described by Hatch and Harnack as a degeneration rather than a development, a corrupting of truth from its earliest simplicity, not an enrichment due to healthy and necessary growth. Such a conclusion is not lightly to be accepted. The formulation of partially realized faith is one thing; a tendency to desert the manifestation of the Triune God in experience and in history for abstract speculations concerning the interior relations of the Deity is quite another. Before the end of the 5th cent. illustrations of both processes appear in the Church, and it is necessary to keep in mind the distinction between them.

It is possible to test the legitimacy of development in the orthodox creed by means of a comparison. There were Christians in the primitive Church who took their stand on the OT and maintained its type of monotheism intact, except that Jesus of Nazareth—whether technically viewed as Messiah or not—was esteemed a prophet of exceptionally high and pure character, whose mission it was to conserve and purify the revelation of the Torah under a new covenant called the Gospel. Ebionites and Adoptianists (see EBIONISM, ADOPTIANISM) of various types preserved the OT conception of God, plus the acceptance of Jesus as a specially commissioned messenger from Him, one in kind with Moses and Isaiah, though far higher in spiritual degree. History has written its commentary on this doctrine, and proved that it was a specimen of arrested growth. Not along this line was it possible to carry on and carry out the teaching of Jesus Himself, of His interpreters Paul and John, and of the multitude of evangelists who in His name were beginning to regenerate the world. The Church of the 2nd and 3rd centuries, with the sacred traditions of the 1st held in trust, was called to fashion, under the guidance of the Divine Spirit, a conception of God such as would at the same time interpret Christian experience and mould Christian thought and life. That the Fathers of the Church were influenced by pre-Christian, especially Greek, thought, no one would attempt to deny. Probably pure Platonism exercised far less influence upon them than Alexandrian Hellenism, and some would rank the influence of Stoicism as still more potent. But it is in the use of philosophical terms, in forms of reasoning, and in general views of the relations between God and the world, not in essential views of God, that these influences are traceable. The vital germ of Christianity, implying a new conception of the relation between God and man in Christ—a conception not abstractly conceived in the intellect, but embodied in the experiences of thousands of devoted lives—was not lost or destroyed amidst the enveloping pressure of pagan ideas. On the contrary, the new religion assimilated some current views of the Divine nature that were not polytheistic, and made use of them for its own ends. Aristides, the first Christian apologist, illustrates this in the opening sentences of his defence:

'I say, then, that God is not born, not made, an ever abiding nature without beginning and without end, immortal, perfect, and incomprehensible.' Later he adds: 'The Christians know God the Creator and Fashioner of all things through the only-begotten Son and the Holy Ghost.'

Justin Martyr, philosopher as well as Christian, appealed to the idea of God innate in man (*εμφυτος*

τῆ φύσει τῶν ἀνθρώπων δόξα [Apol. ii. 6]); and Minucius Felix (in his *Octavius*), following in his own fashion the example of Paul at Athens, argues that the unity of the order of Nature proves the unity of God, who is infinite, almighty, eternal, and who before the world was to Himself in the place of the world (*ante mundum sibi ipse fuit pro mundo*). Athenagoras does but represent all other exponents of Christianity, when, having established the unity of the Godhead by a philosophical line of proof, he proceeds to unfold the doctrine of the Trinity as the Christian way of conceiving that unity.

Gnosticism (*q.v.*), 'the first comprehensive attempt to construct a philosophy of Christianity' (see Harnack, *Hist. of Dogma*, Eng. tr., i. 226 f.), teaches chiefly by its failures. Gnostics of various schools furnished what were for the most part honest attempts to interpret Christ; but they did so in the light of preconceived ideas, some of which were incompatible with essential Christianity, and others inconsistent with its characteristic spirit. At this stage evolution took place by antagonism. The representatives of the Church learned some of their most valuable lessons by resistance to ideas of God thrust on their attention by the most active thinkers of the time. Monarchianism (*q.v.*), a reaction against the Gnostic tendency to interpose numerous orders of being between God and the creation, taught the unity of God in a modalistic, *i.e.* really anti-Trinitarian, fashion. For it the Son and Spirit have no distinct, personal existence, but are only modes in which the one God reveals Himself. Some of the Fathers, especially in the East, whilst avoiding this extreme, taught the subordination of the Son and the Spirit to the Father; and a tendency in this direction was for a considerable time present within, as well as outside, the pale of recognized orthodoxy.

1. Church doctrine of the Logos.—Amidst these diverging tendencies the Church built up a constructive doctrine, first of the Logos, then of the Trinity. Justin, Irenæus, Clement, and Tertullian are representative names amongst those who contributed to the earlier structure. The prologue of the Fourth Gospel formed the foundation. The Logos was eternal, not created, not emanating, but begotten, the Sonship of the 'Word' seldom being lost sight of. The Logos was not a mere creating and ordering Reason of God, impersonally conceived. Rather was He the organ of Divine revelation and operation in creation and history, and pre-eminently in redemption. The eternal purpose of God was realized in the Word Incarnate; the personal Logos took upon Him human nature that men might be partakers of the Divine. For Clement the Logos is 'the highest principle in the religious explanation of the world,' as well as the centre of the work of redemption. In nature, as in grace, He is the interpreter of the Father's attributes, being first the educator, then the Redeemer, of the human race. The work of the Holy Spirit was not at this stage ignored, though it was not elucidated and dwelt upon to the same extent.

The ideas concerning God which the Church had drawn from history and experience were not easy to express; the very vocabulary had to be created, and East and West were apt to misunderstand each other. Thus, if we find that by Tertullian and Origen, for example, whilst Christian thought was slowly crystallizing, phrases were used inconsistent with one another, or with the exact forms ultimately adopted, it will occasion no surprise. Technical phraseology, whether drawn from Roman law or from Greek metaphysic, was inevitable; but a true instinct was at work, now accepting and now rejecting the same

phrase, as certain associations seemed to render it serviceable, or undesirable, for the expression of underlying faith. The Godhead is 'one substance in three persons,' said Tertullian, employing Roman juristic terms, but the threefoldness is *non statu sed gradu, nec substantia sed forma, nec potestate sed specie* (*adv. Prax.* 2). The Three are one in substance, condition, and power, but are three in relation, in mode of existence, and in special characteristics. The Father is one, the Son is another, the Spirit is yet another; but these three are one (*unum*, not *unus*); there is no division of the one substance, though each of the three is a substantial existence with characteristic properties. Origen believed in God as the One Self-existent Source of all that is, a living Person, but only relatively knowable through the mediation of the Logos, who has personal subsistence side by side with the Father, is of one essence with Him, His perfect image, and Himself God (*θεός*, not *ὁ θεός*). The Word-Son is eternally generated, the process being continuous, timeless, and real; He is co-eternal with the Father. The Father possesses pre-eminence, the Son is subordinate in His derived being. Difficulties were created by Origen's language concerning the subordination of the Son,—though it was not of essence, but of person and office,—the Father being described as *αὐτοθεός*, the Son as *δευτερός θεός*, whilst the Holy Spirit, who is recognized as Divine and above the category of creatures, has come into being through the Logos, and is described as inferior both to Father and to Son. Origen was a pioneer in a difficult region of thought, his own ideas had not worked themselves quite clear, and discrimination between them, with a just estimate of their relative value, was effected only by a process of controversy.

2. Nicene doctrine.—The rise of Arianism enabled the Church to distinguish between what it really held and what it might seem to hold. This heresy, which waged so long a war against orthodoxy, and at times appeared likely to gain the upper hand, was never strong in doctrine. It taught a Trinity consisting of one uncreated and two created beings—herein it was both illogical and irreligious, if creatures were to be worshipped. It represented Christ as a demi-god, and its whole doctrine implied retrogression towards paganism. The strength of Arianism lay in the fact that a large portion of Christendom was not yet Christianized, and that believers had not yet come to understand the real nature and implications of their own faith. The Nicene formulary, in insisting on *homoousios* to establish the Divinity of Christ, laid the foundation of the orthodox doctrine of God and His essential Tri-unity. The statement that in the one Godhead there are three Persons was never intended to mean three individuals, *i.e.* three self-conscious subjects and centres of personality as 'persons' are understood among men; nor merely three aspects (*πρόσωπα*) of one unitary Deity. As time went on, it was clearly laid down that there were three eternal subsistences (*ὑποστάσεις*), personal, distinct, but not separate, organic one to another and to the unity of the Triune God. Athanasius (*q.v.*) in his long and strenuous controversy was contending for real contact between God and men in a real redemption wrought out by a real Divine Saviour in the midst of the actual world. The philosopher, on the one hand, who taught that God operates continually in the world, could not preserve His personality distinct from the world, whilst, on the other hand, those who insisted on Divine personality tended to separate God from creation in transcendental isolation. If a historic Incarnation was to be preserved in the fullness of its actuality and redeeming power, it must be based on interior

distinctions within the unity of the Godhead—a unity which is the home of distinctions realized and overcome. Athanasius contributed to the formation of a doctrine of God, by establishing not only the *homoousia* of the Son but also that of the Spirit as a necessary inference. The Holy Spirit is the Spirit of the Son; He is not a creature; He is the Giver of life and of celestial gifts—Himself God. Athanasius, like other leading Fathers, protests against being compelled to define relations within the Deity which are beyond human comprehension; but, finding in Scripture the word 'proceeding' used to denote the relation of the Spirit to the Father, he says that he will retain it as the best. The Arian controversy (see *ARIANISM*), which practically ended at Constantinople in 381, affirmed the faith of Nicaea on the basis that, while in the Godhead there is but one essence or substance (*οὐσία*), in that unity there are three eternal modes of existence, now called *ὑποστάσεις*, though that word had originally been synonymous with *οὐσία*, and the ambiguity had naturally been the source of some confusion.

3. The Trinity.—It is impossible here to trace the detailed stages by which the doctrine of the Trinity was finally shaped. The three great Cappadocian Fathers, Basil and the two Gregorians (see *CAPPADOCIAN THEOLOGY*), contributed to a clearer discrimination of ideas and a more accurate use of words. It is to them that the theological use of *ὑπόστασις* as above defined was due. Neither Origen nor Athanasius had made it sufficiently clear that in relation to God 'person' meant more than mere aspect or manifestation, and less than the exclusive individual existence which the word implies among men. The subject of personality, Divine and human, was not discussed in the 4th cent. as it has been during the last hundred years; and even now a clear and definite vocabulary remains a desideratum. But there was no doubt in the mind of the Greek Fathers that the three *τρόποι ὑπαρξέως*, or modes of subsistence, of the undivided Godhead were not three *πρόσωπα*, or aspects of a bare unity, neither were they three *οὐσῆαι* which would imply three Gods; but all believed in *μία οὐσία ἐν τρισὶν ὑποστάσεσιν*, one Essence in three personal modes of subsistence, each with its characteristic properties, and each necessary to the One Indivisible Whole. The Godhead in itself and apart from the world is an inexhaustible living Being, neither a barren unity nor a divided multiplicity. The Father is the primal source, the Son the mediating power, the Spirit the executive energy; and every Divine act is to be understood as a working of the Father, through the Son, in and by the Holy Spirit.

4. Augustine.—The last stage is to be found in Augustine (*q.v.*). The East had throughout preserved an element of subordination in its theology, the Father being the sole Fount of Deity, the Son deriving His existence by generation, and the Spirit by procession. The equality of the Three was asserted, but a real meaning was attached to the idea of *τάξις*, rank or order; and the Greek Fathers resented any attempt at change which seemed to interfere with the *μία πηγή θεότητος*, the One Fount of Deity. Augustine, followed by the Western Church, taught that the Spirit proceeds from the Father and the Son, and made the co-equality complete. In the opening of the treatise he lays it down that 'the one and only and true God is a Trinity, and the Father, Son, and Holy Spirit are rightly said and believed to be of one and the same substance or essence.' Later on he explains that each Person is the undivided Deity, and that the three Persons are together the one God. Augustine destroyed what remained of subordination; but this was possible only by moving in the direction of

Modalism. The Father is conditioned by the Son and the Spirit, as the Son is by the Father. If the unity is conceived so that each Person is the undivided Deity, then the three appear merely as relations in the one Godhead. It is true that this differs from the older Modalism, which rested upon the idea of successive manifestations; from the very first, God is to be conceived as Triune. But this is possible only through a refining of the idea of personal existence, till it becomes a 'mode' only in the simplicity of the Godhead. Doubtless the Neo-Platonic element in Augustine's thought was responsible for some of the language he employed. But the analogies he used to illustrate the subject—especially his favourite one of intelligence, memory, and will in human self-consciousness—show in what direction his mind constantly moved. He preserved theoretically the tradition of three Persons in one substance; but himself emphasized, not the personality of each Person, but the personality of the One God, and he never overcame the contradictions more or less implied in his attempt to combine the philosophic and the religious standpoints. Harnack describes Augustine's speculations as an attempt to

'construe the most immanent of Immanent Trinities and to sublimate the Trinity into a unity; and, just because it does this, it discards everything in the way of a basis in historical religion and loses itself in paradoxical distinctions and speculations, while at the same time it is not able to give clear expression to its new and valuable thought' (*Hist. of Dogma*, Eng. tr., iv. 130).

It is surely harsh to say, as Harnack here does, that the *de Trinitate* 'can scarcely be said to have promoted piety anywhere or at any time,' but the speculative tendencies of Augustine did unquestionably tend to draw men's minds off from the living realities of historical Christianity. Augustine, more than any other teacher, prepared the way for the barren refinements of scholasticism; he almost occupied its standpoint and anticipated some of its methods.

The idea, however, which underlay Augustine's lofty meditations on the subject of the Trinity was not peculiar to him. It came to be defined later as *περιχώρησις*, the intercommunion, or mutual interpenetration, of the Three Persons in the Trinity. John of Damascus, last of the Fathers and first of the Schoolmen (c. A.D. 700), gave currency to the word, and the thought which it expressed prevailed in East and West alike, though with a different emphasis. The Latin equivalents of the Greek were *circumincessio*, which implies the activity of mutual permeation, and *circuminsessio*, which denotes a mutual rest or abiding of each Person in the others. 'Co-inherence' is perhaps the nearest English equivalent; but, whatever word be used, it represents the thought that the whole Trinity is present in each Person, that each is so complete that it includes the others—a mode of speech which destroys the very conception of 'personality.' The idea first appears in Gregory of Nyssa, it was most fully developed by Augustine, and came to be the basis of orthodoxy in Scholasticism; but it has never been fairly interwoven with religious thought and experience in the actual life of Christendom.

5. The Creeds.—There is no small danger of losing sight of the main theme in the midst of discussion concerning the views of individual thinkers, however eminent. Controversies in the Church did not arise over the fundamental belief in one God, which was never questioned by any; nor, strictly speaking, were they concerned with the new revelation of God in Christ and the gift of His Spirit, which were the common heritage of believers. Questions did arise—and they were but slowly and with difficulty settled—as to the mode in which the altered conceptions of God could be

ments of the Græco-Roman world of the 2nd to the 4th centuries. Faith in God the Father of all, in His Son Jesus Christ the Saviour of all, and in the Holy Spirit through whom Father and Son were revealed, formed the basis of all Christian creeds, and such trust was the animating principle of all Christian experience. It found very various expression, but it remains true that no Ecumenical formulation of the Christian conception of God was ever made. The chief records that have come down to us are as follows.

(1) *The Apostles' Creed*, an expansion of the baptismal *symbolum*, may be described as the creed of the catechumen. From the time when it consisted only of three or four clauses in the 2nd cent., down to its full development in its present shape in the 8th, this venerable Confession of Faith always retained its original character. It was never debated by authorities or adopted at a Council; slowly it grew as the expression of the working faith of the Western Church. It contains the statements, 'I believe in God the Father . . . and in Jesus Christ His only Son our Lord . . . I believe in the Holy Ghost'; but the inter-relation of these is not defined, and no doctrine of the Trinity, properly speaking, is attempted.

(2) *The Nicæno-Constantinopolitan Creed*, ratified at Chalcedon (451), is a theological document, shaped and re-shaped by successive Councils, its phraseology keenly debated and sharply defined. It was prepared for the purpose of excluding heretics, and its earliest form concludes with an anathema upon some of them. But in outline it consists of three parts that are not concatenated together. Its Christology forms its characteristic feature, and a doctrine of Christ undoubtedly implies a doctrine of God of a very significant kind; but here again no attempt at a definition of the mystery of the Trinity is attempted. It is otherwise with the Athanasian Creed.

(3) *The Athanasian Creed*—to use the modern misnomer for the anonymous *sermo* or exposition of Christian doctrine known as the *Quicumque vult*—emanated from the Western Church in the 6th century. It was a creed for the clergy, with accompanying comminatory clauses; and in its two parts it minutely defines the doctrine of the Trinity, and that of the two natures in Christ as intimately related to it. The teaching of Augustine and the phraseology of creeds in the 4th and 5th centuries are presupposed and adopted; but the document as a whole was never accepted by any Council, nor can it be described as an Ecumenical symbol.

(4) *The Te Deum*, on the other hand, was prepared for the purposes of worship, not to express nice metaphysical distinctions. Yet it embodies more adequately than any technical creed the faith of the Church, and the Christian conception of the God whom it adores—*lex orandi, lex credendi*. This lyric paraphrase of the Apostles' Creed, by whomsoever composed, is, as Luther said, a fine confession of the true faith of a Christian, as well as a hymn in which to praise God. The religious faith of the community, uttered by Paul in his solemn benediction, echoed by Clement of Rome and Ignatius, and repeated by every believer at his baptism, remained the same throughout, though only after the lapse of centuries were acceptable forms devised to express the deep convictions of the Christian heart. And throughout the generations the wisest teachers confessed with Augustine that the words that were used were at best inadequate for their purpose, and were uttered in reverence because, though speech was imperfect, silence was impossible. Scientific and speculative discussions have had their place, and metaphysical formulæ their value, in shaping the Christian doctrine of God; but it has never been forgotten that religious conceptions, when ex-

pressed at all, can only be uttered in the language of religious faith.

IV. MEDIÆVAL AND REFORMATION PERIODS.

—For more than a thousand years the doctrine of God in the Christian Church preserved its character, substantially unchanged and unassailed. From Augustine to Kant, or from the Athanasian Creed to the period of the *Aufklärung*, or Enlightenment (*q.v.*), orthodoxy remained stationary. The phrase does not necessarily imply theological stagnation, but such movement as took place was within lines carefully laid down and steadfastly maintained. The work done lay chiefly in the direction of elaborating the content of the idea of God, filling up gaps, and attempting to answer difficult questions. But the gradual modification thus effected tended to make doctrine more philosophical and less religious, more complete on the speculative side, but less potent and real in practical life.

The writer known as pseudo-Dionysius exercised a wide influence from the end of the 5th cent. onwards. He attempted to blend some of the chief ideas of Neo-Platonism with those of the NT. Accepted at the time as the Areopagite of Ac 17²⁴, the 'first bishop of Athens,' Dionysius influenced both the scholasticism and the mysticism of the Middle Ages. His philosophy distinguishes between 'affirmative theology'—which teaches truth concerning the nameless supra-essential Deity in the form of symbols, historical manifestations, and ecclesiastical dogmas—and 'abstracting theology,' by means of which the devotee may rise from these temporal forms to the direct contemplation of the transcendent inconceivable Infinite and Absolute Being. Dionysius appears to identify this highest principle of Deity with God the Father; and, while he believes in the Trinity, to him Jesus and the Holy Spirit are but branches or channels through which the Divine enters into relation with human life. A system of 'heavenly hierarchy' was constructed, of which the earthly hierarchy is the reflexion and continuation, but its author never succeeded in making clear the steps of ascent and descent in his speculative scale of being; and his name is preserved in history chiefly because of the lasting impression he produced upon mediæval theology. Scotus Erigena, who in the 9th cent. heralded the approach of scholasticism, interpreted Christian doctrine in the light of Dionysius' teaching. His system was essentially pantheistic, and professed to lead from God, through the ideal and the real worlds, back to God. He attempts in his own way to solve the philosophical problem of the One and the Many by means of Scriptural doctrines and phrases to which he gives a meaning of his own. God is the supreme unknowable Deity, who yet manifests Himself in the manifold of creation. This process of unfolding is to be followed by the return of all orders of being back to the primal Unity, so that God may be all in all. The fundamental difficulty found in the presence of sin is met by resolving evil into a necessary factor of development which in due course will be overcome. Christ is the centre in this stupendous cycle of movement from God and to God, and Trinitarian phraseology is from time to time employed; but Erigena's scheme of existence is essentially philosophical rather than Christian, and was never accepted by the Church, though it exercised considerable influence on mediæval thought.

1. Scholasticism.—Scholasticism (*q.v.*) has been described both as the reproduction of ancient philosophy under the forms of ecclesiastical doctrine, and as the inculcation of Christian truth under the forms of Aristotelian philosophy. As a matter of fact it passed through various stages

—ancient Greek metaphysics and orthodox Christian dogmas being blended in varying methods and proportions. But, at its best, scholasticism represents God as the origin, centre, and goal of all knowledge; all things are viewed in relation to Him; He is at the same time cause and end (*principium et finis*) of all thinking things, of all subjects, of all thought. Sacred science, *i.e.* theology, is pre-eminent in the teaching of the schoolmen; but close observation shows that, partly as regards their conception of God, partly through the methods adopted of reasoning about Him and His relations with men, and partly through the resultant views taken of human life, vanquished philosophy had at this time transformed, if not actually conquered, its conqueror. It is not possible, however, to generalize concerning scholasticism as a whole; for, during its rise, progress, and decay, from the 11th to the 15th cent., changes of various kinds are discernible. It is difficult for us now to estimate the influence upon the doctrine of God exercised first by Neo-Platonist and afterwards by Aristotelian principles, and by the prolonged philosophical discussion concerning universals and the Realist *v.* Nominalist controversy. But the names of Anselm (*q.v.*) and Abelard (*q.v.*) in the 11th cent. mark the rise of a movement of which Thomas Aquinas (*q.v.*) in the 13th constitutes the climax and crown, as Duns Scotus in the 14th represents its incipient decay.

Anselm's ontological argument in his *Monologium* for the existence of God was characteristic of the time, and the Christological argument of the *Cur Deus Homo?* sheds light upon the ideas entertained of the justice and goodness of God and the meaning of the Incarnation. Abelard's rationalism led him to interpret the Trinity in a Sabellian fashion and to explain the Atonement entirely in terms of the love of God and the impression made by Divine love in self-sacrifice upon the hearts of men. These two representative thinkers were not in reality so far apart as their respective mottoes *Credo ut intelligam* and *Intelligo ut credam* might seem to imply. Both argued *a priori* concerning the nature of God, their premisses being drawn nominally from Scripture, but in reality from quasi-philosophical ideas which belonged to their own time, and which had never passed through the searching fires of criticism. Abelard boldly challenged some assumptions of current orthodoxy, and his dialectic threatened to prove seriously destructive, but his fundamental ideas concerning the Deity did not seriously differ from those of his contemporaries. It may be said that Bernard the mystic and Abelard the rationalist presented complementary aspects of Christian thought, which were blended in different fashion in the philosophy of Aquinas and the poetry of Dante.

The general factors of development which prepared the way for Thomas's *Summa*, the standard theological monument of mediævalism, were such as follow. The pantheistic tendencies which have been described as characterizing the Neo-Platonism of Dionysius and Erigena produced a marked reaction. In time the genuine Platonism which had been handed on from Augustine to the earlier Schoolmen gave way before a revived Aristotelianism, the doctrines and methods of the Stagirite being used by Aquinas to establish and expand the truths of natural theology. God is defined as *primum movens immobile*, 'Mover of all, Himself unmoved the while,' and as *actus purus*, *i.e.* actuality without potentiality. The modes of proving the existence of God are chiefly deductive, being drawn from the nature of causality, the necessity of absolute being, and the need of intelligence in the great Designer. The metaphysical attributes

of the Deity—unity, infinity, self-existence, and the rest—are deduced in similar fashion. The proof furnished by Aquinas, that love necessarily constitutes the fundamental relation of God to the world which He has brought into being, stands in marked contrast to the idea and exposition of Divine love given in Jn 3¹⁶ and 1 Jn 4¹⁰. Thomas insisted on the distinction between the teachings of reason concerning the existence and nature of God and the teachings of revelation. These latter must be received by faith on authority, since they could neither be discovered nor proved by reasoning. The dualism thus introduced has influenced Catholic, and to a large extent Protestant, theology ever since. Thomas rejected the pantheistic teaching which represented God as the essence of all things; he viewed Him as creator of all things from nothing, i.e. without pre-existing material—not from all eternity, but at a definite moment, when time began. This relation of God to the world is discernible and provable by *a posteriori* arguments. Man has the knowledge of God *naturaliter*, if he does not by evil-doing stifle and destroy it. The doctrine of the Incarnation, however, must be received on the authority of revelation. It implies a union between the Divine and human natures in the One Person of the Logos, the human nature of Christ being impersonal. God's nature, including the combined attributes of justice and mercy, made necessary the 'satisfaction' rendered by the death of Christ on the cross, and from this fountain spring all the streams of salvation needed by guilty man in a sinful world. Thomas was essentially a Realist; for him the ideal was the real in a truly Platonic sense. But, in analyzing and expounding the fundamental truths of the Christian faith, he used the categories of Aristotelian philosophy. In many of his arguments concerning the persons of the Trinity, their properties and functions, and concerning God's ethical attributes, His relation to the world, and His operations in it, Aquinas seriously modified, from the standpoint of philosophy, the data of revelation which he professed only to state and interpret. Christian theology for six centuries past has been largely moulded—for better, but to some extent decidedly for worse—by the speculative reasonings of this *Doctor Angelicus*. Long after the technical fetters of scholasticism had been broken, the movements of Christian thought concerning God were still too largely confined within the limits which the Schoolman had laid down.

2. *Mysticism*.—The relation between Scholasticism and Mysticism (*q.v.*)—those twin forces in shaping mediæval thought concerning God—cannot be defined in a word. The view that Mysticism represented a reaction against the extreme subtleties and logical analyses of the Scholastic method represents but a fraction of the truth, characteristic only of a few teachers at one particular epoch. Harnack's view (*Dogmengesch.* pt. ii. bk. ii. ch. vii.) is that Scholasticism is 'nothing but scientific thought,' though the science is in fetters. Mysticism is the presupposition of Scholasticism, because mediæval science based itself on piety. Piety prompts to thought, and thought in turn promotes piety. Where the knowledge of God is pursued for the sake of the inner life of the soul, it may be termed mystical theology; but, where the knowledge of the world in relation to God possesses an independent objective interest, the term 'Scholastic theology' is used. The two, therefore, neither run parallel to one another nor are in conflict with each other, but 'Mystic theology and Scholastic theology are one and the same phenomenon, which only present themselves in manifold gradations, according as the subjective or objective interest

prevails' (Harnack, Eng. tr., vi. 27). 'Mysticism' is a word employed in such various senses that ambiguities are almost inseparable from the discussion of the subject. But Roman Catholic theologians distinguish between dogmatic, moral, and mystical theology, the last being essentially experimental and implying a pure and direct knowledge of God's inmost nature, obtainable only by a personal experience of the love of God as uniting the soul to Himself and transforming it in the process. In this sense, as Harnack says (*ib.*), 'Mysticism is the starting-point and practical application of Scholasticism'; but surely it is much more than this. In the Middle Ages, as always, it represents a transcendental method of attaining immediate spiritual knowledge, which leaves the dialectical methods of Scholasticism far behind. The mystical theology of Eckhart, for example, and of mediæval saints generally, whilst it was not theoretically in conflict with Scholastic theology, was in practice opposed to Scholastic methods because it professed to impart an intuitive knowledge of God as Absolute and Infinite by means of an intimate personal union with Him in self-surrender (see MYSTICISM [Christian]). This kind of knowledge could never be attained by the most elaborate processes of the logical understanding at work upon the data of revelation; and here the relation of Mysticism to the doctrine of God goes far beyond the results of Scholasticism. Harnack has, however, rendered the important service of showing that these and other apparent antagonisms in the mediæval doctrine of God are not ultimate. Anselm and his opponents, Bernard and Abelard, the German mystics of the 14th cent., and those who pronounced them heretics, were not inherently and fundamentally opposed to one another, but were travelling by different paths which led at last to the same goal.

3. *Schools of mystics*.—Mysticism is neither Catholic nor Protestant, though it took differing and characteristic forms in Latin and in Teutonic minds. The connexion between the idea of God and man's mode of attaining communion with Him is very close. Hugo of St. Victor in the 12th cent. unites two modes too often disjoined, of conceiving and approaching God, when he says:

'In two ways God dwells in the human heart, to wit, through knowledge and through love; yet the dwelling is one, since every one who knows Him loves, and no one can love without knowing. Knowledge, through cognition of the Faith, erects the structure; love, through virtue, paints the edifice with colour' (*de Arca Noe moralis*, i. 2 [PL clxxvi. 621]).

The contemplation of God on which the Victorine school, with its Platonizing tendencies, laid special stress stood midway between the logical analysis of Abelard and the emotional fervours of Bernard of Clairvaux (*q.v.*). Bonaventura later furnishes an excellent example of clear thinking concerning the Trinity and the Divine attributes on the lines accepted by the Church, combined with deep devotional feeling and an insistence on the necessity of religious experience for the attainment of any true knowledge of God.

'Through faith Christ dwells in our hearts. This is the knowledge of Jesus Christ, from which, as from a source, comes the certitude and understanding of the whole Scripture. Wherefore it is impossible that any one should advance in its knowledge, unless he first has Christ infused in him' (*Breviloquium*, Prologus, Quaracchi ed., v. 201. For these last two quotations, see Osborn Taylor, *The Mediæval Mind*, ii. 367 and 409).

The school of German mystics, represented mainly by Eckhart, also by Tauler, Ruysbroek, and others, exhibits the tendency—always more or less inherent in mysticism—to lose theological landmarks in unbridled and formless speculation. Eckhart was not a Pantheist, but he often writes like one. For him the Godhead is impersonal, for ever hidden and unknowable. God, however, reveals Himself in a trinity of persons, the subject of Divine knowledge being the Father, the object

being the Son, while the Spirit is the mutual bond of love whereby they are united. The world is in God, not God in the world; time, space, creaturely life are nothing in themselves. It is the duty of man by an act of intuition, which includes intellect, feeling, and will, to realize direct union with the Absolute; and so, in Origen's phrase, the end will be like the beginning, all will return to God, and the Many will be lost in the One, from whom (or from which) all have originally proceeded.

4. **The Reformation.**—At the time of the Reformation no controversy arose concerning the doctrine of God, so far as creeds and formularies were concerned. The Decrees of Trent reaffirm the Nicæno-Constantinopolitan Creed with Western additions; it is noteworthy that no attempt at reconstruction was made on the lines of Aquinas. The Confession of Faith then passes to the subjects of Original Sin, Justification, and the other points of immediate controversy, with which also the Reformed Confessions were mainly occupied. The first article of the Augsburg Confession, however, after reaffirming 'the decree of the Nicene Synod concerning the Divine essence as true and without doubt to be believed,' proceeds thus:

'To wit, that there is one Divine essence which is called and is God, eternal, without body, indivisible (*impartibilis*), of infinite power, wisdom, and goodness' . . . 'and that yet there are three persons of the same essence and power, who also are co-eternal, the Father, the Son, and the Holy Ghost. And they use the name of "person" in that signification in which the ecclesiastical writers have used it in this cause, to signify, not a part or quality in another, but that which properly subsists.'

The corresponding Anglican article runs:

'There is but one living and true God, everlasting, without body, parts, or passions (*impartibilis, impassibilis*): of infinite power, wisdom, and goodness; the Maker and Preserver of all things, both visible and invisible. And in unity of this Godhead there be three Persons, of one substance, power, and eternity: the Father, the Son, and the Holy Ghost' (Art. 1.).

None the less, the Reformers exhibited a change of tone and of emphasis, though not of definition, in their teaching concerning God. Luther in his Small Catechism lays the stress where Scripture lays it, and he was wont from time to time to criticize the use of the term 'Trinity' as a 'mathematical' word, saying: 'Since it is not in the Scriptures and sounds cold, we shall do much better to speak of God and not of the Trinity.' Luther dwells often upon God as a loving Father, ready to forgive and providing for men a free salvation. But he is careful to say that this means 'God in Christ'; all knowledge of God outside Christ reveals Him as a righteous Judge, wroth with sin and stern in punishing the guilty. It is the work of Christ as Redeemer that makes forgiveness possible, and opens up communion with the Father for His rebellious children. It is Christ as Saviour, not as Eternal Word, that Luther preaches, though his doctrine of salvation loses its meaning if the Eternal Word did not become flesh and dwell among us as Jesus Christ our Lord.

A distinction between Luther and Calvin is discernible—still more marked between Lutherans and Calvinists—in the conception of God which appealed to them respectively. Calvinism is a 'theology' indeed, a doctrine of God throughout the length and breadth of its teaching. The glory of God is exalted, all else is banished or abased. God is celebrated in His omnipotence and omniscience, in His sovereign and inscrutable will, in the grandeur of His eternal, unalterable decrees, God in His soleness and absoluteness, in the accomplishment of His will rather than in the manifestation of His character, a will that instantly silences opposition and irresistibly effectuates its own purposes. Lutheran Christology, on the other hand, admitted a closer approximation of God to man than orthodoxy had always allowed. It emphasized

the love of God manwards, the self-emptying on the part of the Eternal Son, the quasi-deification of His humanity in the doctrine of the *communicatio idiomatum*. The contrast between Lutheranism and Calvinism furnishes a striking example of the fact that theoretical identity of creed is consistent with almost incredible divergency of spirit and temper.

5. **Protestant theology.**—The 16th and 17th centuries are marked by the establishment of a kind of Protestant Scholasticism. The post-Reformation theologians in their doctrine of God fell back on Scholastic categories, and laid down laws in their definitions of Deity which have been observed by their followers ever since. The second chapter in the Westminster Confession of Faith, 'Of God and of the Holy Trinity,' is a standing illustration of this in its definition of the One Being who

'hath all life, glory, goodness, blessedness, in and of himself; and is alone in and unto himself all-sufficient, not standing in need of any creatures which he hath made, nor deriving any glory from them, but only manifesting his own glory in, by, unto, and upon them:—he hath most sovereign dominion over them, to do by them, for them, or upon them, whatsoever himself pleaseth.'

God in His essence is defined as an infinite and eternal Spirit, His metaphysical and moral attributes are carefully mapped out, and an exposition of the doctrine of the Trinity on orthodox Catholic lines follows. But in the systematized doctrines of God of the 16th and 17th centuries, there are indications of constituent elements not yet sufficiently harmonized. The idea of the philosophical Absolute, God as the ultimate reality in the universe, the self-sufficing Deity of abstract thought, appears in them. There is present also a metaphysical conception of the Trinity as it had been developed through centuries of Catholic teaching. But at the heart of the whole is the living God of the Bible, the revelation of the Father in the Son of His love, the ever present Friend and Saviour of mankind; and in the whole thus presented there are unresolved antinomies. The question how the philosophical and speculative elements in these definitions were to be harmonized with the purely religious teaching of the OT and NT had hardly emerged. In the passionate conflicts which shook Christendom to its foundations in the 16th cent., it was taken for granted that Catholics and Protestants alike worshipped the same God and accepted the same fundamental conceptions of Him.

V. **THE MODERN PERIOD.**—The date from which a 'modern' movement in thought is to be reckoned depends upon the subject handled and the standpoint occupied. For some purposes, in the study of theology the 16th cent. forms the watershed between mediæval and modern ideas; but the critical investigation into the foundations of Christian Theism begins with Kant and the 'Enlightenment' of the 18th cent., whilst the scientific and philosophic movements which have affected the Christian doctrine of God belong chiefly to the 19th century. The progressiveness of Christian Theism within its own lines is a marked feature of the period, and there can be little question that the ideas of God entertained by representative Christian thinkers during the last half century have been none the less profoundly, because silently, modified, without necessarily losing their essential Christian character.

1. **Deism.**—The Deistic movement in England, with which may be associated the revival of Arianism in the early years of the 18th cent., affected orthodox thought only indirectly. Deism (*q.v.*) was a philosophy of the universe rather than a religion; it taught the existence of a God, but, as Kant said, not of a living God. Essentially

rationalistic in their methods, the Deists recognized the Ultimate Being only as a transcendental cause of the universe. They criticized revelation if they did not entirely deny its reality, they rejected the supernatural and all claims of authority in religion, while they asserted the doctrines of Providence, moral government, and Divine rewards and punishments. Bishop Butler answered them by showing the unreasonableness of accepting a bald natural theology with an absentee Deity, whilst refusing to recognize the analogous and superior claims of revelation; and Paley contended that the cosmological argument on which the Deists relied to prove the existence of the Deity in whom they believed necessitated an advance to teleological and moral arguments in proof of a living God who had not left the mechanism of Nature to run by the mere operation of its own laws. But the full reply to Deism was not possible in the 18th century. That came later, with a deeper and more adequate understanding of the two terms, Nature and God.

2. German theology.—Kant promoted advance by criticism. His keen examination of the currently accepted 'proofs' of the Divine existence was carried out on the lines of a critical philosophy which denied all direct knowledge of ultimate realities. For him God was but one of the 'ideas' of pure reason, or postulates of the practical reason, whilst his strenuous assertion of the claims of the practical reason led to a permanent strengthening of the moral argument for the existence of a righteous Ruler of all. Kant's criticism of time-honoured traditional arguments was undoubtedly serviceable to Theists by leading them to test the soundness of their foundations, but the critical philosophy could not, any more than Deism, bring men into the presence of the living God. Kant's religion found no place for prayer, and resolved itself into a Divinely sanctioned morality. Hegel's epoch-making work in philosophy profoundly affected theology, especially his exposition of the relation between God and the world, and his claim to have rationalized the Christian religion and its doctrine of the Trinity. The Hegelian logical process of thesis, antithesis, and synthesis, as applied to religion, meant that the Absolute externalizes itself in Nature and comes to itself again in Spirit: that God in the process of historical development becomes self-conscious in finite spirits, and especially in Him whom Christians believe to be God manifest in the flesh. Hegelianism dissolves religion in metaphysics, and the terms used undergo a philosophical metamorphosis. Hegel's followers differed in their interpretation of his religious teaching, the right wing maintaining the personality of God in Himself apart from creation, and the doctrine of the Incarnation practically as taught by the Christian Church; the left wing—on the whole with more logical consistency—adopting a kind of evolutionary Pantheism. Schleiermacher's teaching blended philosophical and religious views of God without really reconciling them. He vindicated the place of religion as a fundamental and universal element in human experience, making its essence to consist in 'feeling'—in a wide and deep sense of the word. He helped to renew religion in Germany by his revival of the claims of devout consciousness as immediate, self-vindicating, and independent of the processes of reasoning on the one hand and the forms of morality on the other. But in the philosophy which underlay all his teaching, the explanation of religion is found in the infinite universe coming to self-consciousness in man. In Schleiermacher's earlier teaching the doctrine of the personality of God was conspicuous by its absence; personality

appeared to him a limitation; and his glowing and attractive exposition of Christian teaching, which he seeks to free from traditional accretions and excrescences, does not conceal the fact that in his view we have no objective knowledge of God as He is in Himself, whilst the revelation given in Christ implies only that in Him human God-consciousness found historically complete realization. The fundamental idea of Schleiermacher's theology is that in 'God,' not necessarily viewed as personal, is found the identity of the ideal and real, which in the world exist as opposites. He is Sabellian, if not Pantheistic, and mysticism is of the essence of his religion. The redemption which he proclaims as characteristic of Christianity does not imply God in self-sacrifice for the salvation of men, but a gradual perfecting of human nature through communion with the Christ in whom human God-consciousness has been attained in perfect and consummate measure.

Lotze as a philosopher largely influenced the theology of the later 19th century. He asserted the knowledge of reality in and through phenomena, and followed Leibniz in his affirmation of the personality of God. True reality according to him is

'not matter and is still less Idea, but is the living personal Spirit of God and the world of personal spirits which He has created. They only are the place in which Good and good things exist' (*Microcosmus*, Eng. tr., ii. 728).

Ritschl, on the other hand, who was in some respects a disciple of Lotze, based his theology upon a practically Kantian epistemology. He distrusted metaphysics, hated mysticism, rejected natural theology, and based his teaching on the NT, as inculcating a practical knowledge of God and a religion of redemption sufficient for man's needs. God in Himself is unknowable; but an objective knowledge of Him sufficient for salvation is revealed in Christ, who has for us the value of God. Accordingly, the Fatherhood of God, His love manifested in Christ, is determinative of His nature and of all His attributes. Love is, however, not set forth as in the doctrine of the Trinity, characteristic of God in His own essential being, for this is unknown, but it describes His relation to man as seen in Christ and as operative in the upbuilding of the Divine kingdom in the world. A religious agnosticism of a kindred type was inculcated in England by Mansel, following Sir W. Hamilton in his philosophical principle that 'to think is to condition.' Hence God cannot be known as He is by human thought, though specific doctrines of revelation, such as the Trinity and the Incarnation, have been granted for the guidance of men and may be defended as knowledge regulative but not real. A direct knowledge of God being impossible, the truths of revelation must be accepted as authoritative, in spite of the contradictions which they necessarily imply. But religion based on scepticism has never been far-reaching or long-lived.

3. Christology.—Every doctrine of Christ implies a corresponding doctrine of God. The chief feature of the Christologies of the 19th cent. has been their Kenotic character. A growing tendency has been discernible to adopt a humanitarian doctrine of Christ, with its correlative Unitarian doctrine of God. But, apart from this, many teachers within the pale of orthodoxy have shown a disposition to desert the Chalcedonian doctrine of the two natures in one Person; and, starting from the real humanity of the historic Jesus, have sought to combine with it a doctrine of His true Divinity by asserting such an exinanition, or self-emptying, on the part of the Eternal Word as made it possible for Him to exist within the measures of human nature. Kenotic theories differ considerably in detail, but they agree in insisting

upon the one Divine-human life of the Incarnate Word, the human not being raised to the level of the Divine, or absorbed in it, but the Divine strictly limiting itself within the bounds of the human. Thomasius, Gess, Martensen, and Dorner in Germany, Godet in Switzerland, and Fairbairn and Gore in England, represent varying shades of Kenotic doctrine. The self-emptying is sometimes understood as implying the entire abnegation of some Divine attributes, such as omnipotence or omniscience; sometimes it implies a virtual transformation of the Logos into a human soul. The doctrine as taught by Martensen is based upon a twofold existence of the Logos—in the bosom of God as Eternal Reason, and in the form of man as a holy redemptive Seed. In Dorner's exposition, Kenosis takes the form of a progressive Incarnation, such that the self-communication of the Logos gradually increased during the life of Jesus from His conception till His ascension. In any case the mystery of the Incarnation is not solved, though some types of Kenotic doctrine have helped to remove difficulties which had long hampered thoughtful believers. It is to be borne in mind that the 'emptying' of Ph 2^s is the laying aside of status, dignity, and glory, not of the essential nature of Deity implied in *μορφῆ*, which is retained throughout. Kenotists have impressed on the minds of recent generations certain fundamental Christian truths, such as that it is the glory of God to limit Himself in love for such a purpose as the salvation of the human race; also that the reality of the human nature of Christ must not be lost sight of, or overlaid, through a desire to honour the Divine in Him; and that it is safer and more truly Christian to rise from the historic Jesus to the Word Incarnate than to reason *a priori* from man's conceptions of what the Divine is likely to be, or must be. Every form of Kenotic doctrine, however, which weakens the belief that 'very God' was made flesh in Jesus Christ touches the living core of Christian faith, because it tends to undermine the work of redemption, whilst seeking to explain the inexplicable in the doctrine of the Incarnation.

4. Modern Theism.—The Christian doctrine of God is Theism raised to its highest power. Consequently it is affected by all current thought which bears upon Theism, as well as by Biblical criticism and investigations concerning the historical Christ. The two currents of thought that chiefly influenced theistic doctrine during the later 19th cent. were the remarkable development of physical science and the spread of idealistic philosophy. The Materialism, Naturalism, and Agnosticism which dominated Western civilization for some decades were simply foes to be resisted by all who believed in a living personal God. But in process of time it was seen that a mechanical explanation of the universe was incredible and impossible; whilst from an idealistic view of Nature, as well as from the wealth of knowledge concerning its phenomena and laws that has been amassed by science, Theists have naturally learned much, and Christian conceptions of Deity have been imperceptibly deepened and enriched, without losing their essential character. It is impossible in a paragraph even to enumerate the gains that have resulted from this lifting of veil after veil from the face of Nature and the consequent heightening and deepening of the vision of God. The dawning conception of the vast reign of law, with the new enlargement and confirmation given to it in every department of knowledge, the establishment of evolution as the mode by which Nature works, the relations between mind and matter as exhibited by modern psychology, the proved dominance of spirit in the operations of natural and material forces, the

scientific study of humanity, its genesis and history on the earth—these are but a few examples of the workings of the modern mind which have led to a wider and truer apprehension of the being and nature of God, as understood by the Christian Theist. Conflict between the conceptions of God as seen in Nature and in history, in law and in grace, in tradition and in fact, has inevitably arisen, and there have been periods when it appeared as if the two diverse points of view would be pronounced incompatible. But so it has always been during a period of assimilation of new knowledge, especially when it has been rapidly acquired. The process of separating between the abiding and the transitory in traditional ideas, between the sound and the speculative in new theorizings, cannot be readily carried out; and, whilst it lasts, a strife arises not between religion and science, but between mere time-honoured traditions of the past and mere hasty speculations in the present. The result thus far has been to lay the foundations of a truer and fuller belief in God, as the ultimate postulate of all thought, the ultimate ground of all existence, and the ultimate presupposition of all that makes our actual experience possible. Steering between the rocks of crude mechanical explanations of Nature on the one hand and the whirlpool of a Pantheism which would merge the very idea of God in the natural self-evolution of Absolute Being on the other, modern Theism has learned to set forth the living God as an ever-present Energy in a universe which in its origin and history has been always dependent on Him for existence. Herbert Spencer declared that amidst all the mystery of our inscrutable existence 'there remains the one absolute certainty that we are in the presence of an Infinite and Eternal Energy, from which all things proceed,' but that it is unknowable (*Eccles. Inst.* p. 843; cf. *First Principles*, pt. i. ch. 2 [ed. 1900, p. 34]). Contemporary Theism, accepting his premiss, has interpreted the unknowable 'actuality lying behind all appearances' as the living personal God with a fullness and richness never possible before. The very considerable literature that has appeared under the auspices of the Gifford Lectureship has borne witness to the activity of very various minds in this direction.

Modifications in the idea of God have taken place, which cannot be briefly described. They have affected what are known traditionally as 'proofs' of the Divine existence—really analyses of the processes by which human thought rises Godwards, unfoldings of what is rationally implied in all human experiences. Natural theology has been modified, including the ideas of creation, miracle, and the whole relation between the natural and the supernatural. The transcendence of God taught by the Jew and the Muslim, accepted by the Deist and by the orthodox Christian in the 18th cent., is combined by the Theist of the 19th with a belief in His immanence, stress being laid on the latter in all recent attempts to expound the relation between God and the universe which He has brought into being. The meaning of the words 'God' and 'man' has been re-examined, and the nature of personality in both has been more fully investigated, with the result that Biblical teaching concerning their mutual relations has been illumined with a new significance. Theodicy has necessarily been modified, as the facts underlying every attempt to justify the ways of God to man have multiplied and changed their shape. The old world-problems of pain and evil have not been solved; the methods and ends of Providence have not been fully explained, but they are better understood, and the reasons why, in the nature of things, they can never be com

pletely comprehended in this life have been brought home as never before. The result has been that many age-long enigmas represent now an 'overcome standpoint'; and the idea of God has been indefinitely widened and deepened by an inclusion of some of the standing antinomies of life in the order of His eternal purpose.

5. Divine immanence.—It does not lie within the scope of this article to dwell upon these modifications in detail. But no account of the doctrine of God in the modern period would be complete without a comment upon its most marked feature—the Divine immanence in the world. The phrase bears many meanings; it is here understood to refer to the newly emphasized belief that God is the ever-present, ever-active ground of all finite existence, that He is not only the cause and origin of all creatures and their powers and activities, but that always and everywhere He sustains and informs the universe, the whole world of things and of spirits being continually dependent on Him 'in whom they live and move and are.' The quotation of well-known words shows that the thought is old, but its application in the 19th cent. indicates that the theology of the 20th may not improbably be transformed by it. Instead of insisting upon a sharp opposition between God and Nature, God and the world, God and man, God and the history of finite spirits, the theology of the last half century has tended to trace the operation of God as seen in the ordinary workings of Nature, in the very constitution of man, and in the developments of nations and of the human race in its long and complex history. Dualism in all these departments is preparing the way for Monism, of one type or another.

It is clear that for the Theist this process is accompanied by dangers. If Theism is maintained in its purity, the transcendence of God as of One whose infinite Being and resources are not exhausted by, or identical with, the universe will never be lost sight of. The fundamental distinctions between the Infinite Spirit and all and each of the finite spirits dependent upon Him, and the eternal contradistinction between good and evil, moral light and moral darkness, must never be effaced or slighted. The philosophy which refuses to set the One over against the Many, and seeks to find the One only in the Many, is inconsistent with true Theism. Reality would thus be resolved into the organic unity of opposites, and individuals would become only elements, or factors, in one indivisible whole. Deism banishes God from the universe, but all forms of Pantheism imprison Him in it. If the Eternal Spirit only 'realizes Himself' in finite spirits, and the Absolute only 'comes to consciousness' in the facts of history, the essential meaning of the word 'God,' the significance of evil, and the nature of religion are alike completely altered. Neither pure Theism nor real Christianity can be erected upon this basis. But short of this, there is abundant room in the Theistic and Christian conception of God for a fuller stress to be laid upon the abiding, informing presence of God in the universe than was possible in the 18th century. The chief contribution of the 19th to the doctrine of God is the development of thought in this direction. Elements of crude anthropomorphism, ideas of externality, and a dualistic opposition between God and Nature, which had lingered in Theistic teaching, are now rapidly disappearing. Influences of various kinds lead the modern mind to find its rest in the thought of a Deity informing the universe from within, as well as ordering and controlling it from without. Creation, preservation, Providence, and all progress of human thought and civilization as directed by God are best understood from this standpoint. The supernatural is

intelligible in proportion as it is not severed from the order of Nature which it transcends, and revelation can be best understood when it is not opposed to that continuous operation of the Divine Spirit which guides and illumines the thoughts of all mankind.

6. Divine personality.—Religion is bound up with the doctrine of the Divine personality; philosophy has been for the most part opposed to it. But there need be no discrepancy between the idea of God viewed as the ultimate entity in philosophic thought and God as the ultimate ground of religious trust and hope. The philosophy of religion to-day, so far from accepting the position that to attribute personality to the Infinite limits and lowers the conception, rather lays stress on the category of personality as the only one that suffices for a worthy conception of Deity. Force and cause and substance are not ultimate in a true conception of essential being; only a Person represents existence by, in, and for itself. Personality must, of course, be rightly understood, not identified with the imperfect forms of it characteristic of finite spirits. Even amongst men it implies intelligence, feeling, and will; it is characterized by self-consciousness, and implies self-determination. As such it forms the highest category of existence that we know; even Herbert Spencer urges that the Infinite Energy on which all things depend cannot be less than personal. The Absolute must be Absolute Intelligence, and this carries with it, as implicate, Absolute Will. To assert this of the Infinite Deity is not to limit Him; to deny it constitutes the real limitation. A person knows; a thing 'is known. Such measure of personality as man possesses is the one source of infinitude within him; by virtue of it he grows in knowledge and power, and is *capax infiniti*. The unquestioned limitations amidst which human personality is realized arise from the conditions under which it is being developed, not from the vital principle itself. The God of Theism is not the Unconditioned, out of all relation with the universe, nor is He the Absolute, in the proper sense of that much abused term. But He is Infinite Spirit, possessed of personality in a sense that can be predicated only of the Infinite—consciousness, knowledge, feeling, will, each at its highest, and all indissolubly blended in the unity of immediate, inalienable Self-existence. Some of the speculations of Aquinas in the 13th cent. have taken more definite and abiding shape and become the assured possession of the philosophy of religion in recent years.

7. Christian doctrine.—Theism, however, is not Christianity. As interpreted by some, a bare theistic doctrine of God has even stood in the way of the acceptance of the Christian gospel. The God of some theistic philosophers could never become incarnate. Christian Theism, rightly understood, only carries to completeness the conception of Deity implied in the definition of an Infinite and Eternal Spirit, perfect in wisdom, righteousness, power, and love. Christianity is nothing if not a religion of redemption, and the Christian idea of God is inseparably bound up with the doctrine of Divine Incarnation for the salvation of men. Given a God of infinite compassion, and the existence of moral evil in man as dire and deep-rooted as the Bible declares sin to be, then grace is as necessary a part of Divine self-revelation as Nature. A God who humbles Himself and suffers in order to redeem, because only thus can the redemption of finite spirits be effected, becomes more than credible. A supreme manifestation of holy love in action is demanded alike by the needs of man and the nature of God. Theories as to the kind of mediation necessary to set right the disturbed relations between the Father of Spirit

and His children are still various, as they have been throughout the history of the Church. But new light is continually dawning upon the minds of men as to what is implied in a Redeemer-God, and the Christian doctrine of God is continually illumined by it. The study of history and of the facts of human life, the fuller understanding of human nature yielded by modern psychology, the development that has taken place in ethics and ethical standards, and the stress laid by such writers as Eucken upon the life of the Spirit have combined to confirm the Christian doctrine of a God who, as essential love, has proved the Divineness of His regard for men by giving Himself in uttermost self-sacrifice on their behalf. The kind of redemption set forth in Christianity is as different from the release from the Wheel of life in Buddhism as the fundamental idea of God differs in the two religions. A living, personal God of holy love delivers from sin in the cross of Christ, whilst a religion practically without belief in God and the soul can promise cessation from the four woes only by a long journey on an eightfold path leading to the happy absorption and disappearance of individual existence.

8. The Trinity.—Belief in an incarnate and redeeming God leads the mind beyond Unitarian Theism. In modern light it is seen to imply a richer and more adequate conception of God than that set forth in Judaism and Muhammadanism. The Christian doctrine of the Trinity cannot, however, be arrived at by philosophical reasoning, though a verification of it may be constructed from the standpoint of the higher Reason. In recent expositions the doctrine has chiefly been dwelt upon as the earliest Christians understood it, as one of revelation and personal experience. It best explains the facts of Gospel history, the teaching of the Apostles, and the religious experiences of believers in Christ from the first until now. Such a doctrine makes it easier to apprehend, however imperfectly, the meaning of personality in the Godhead and the true significance of thought, goodness, and love, as existing eternally in the Divine nature, by its indication of interior distinctions in the Godhead which do not impair unity. It avoids the extremes of Deism and Pantheism, preserving elements of truth in each with regard to the relation of God to the world. Trinitarian doctrine, however, did not originate in speculation, and it is not propounded to-day on *a priori* grounds arising from the nature of Deity. It commends itself to faith as the best expression of the fuller revelation of God which was given in Christ, and of the rich and many-sided communion with Him made possible in the gospel. In some important respects the phraseology of the 4th cent. does not express to men of the 20th what the Fathers of the Church intended to say more than a thousand years ago. 'Substance,' 'nature,' and 'person' do not mean precisely what *οὐσία*, *φύσις*, *ὑπόστασις*, and *πρόσωπον* meant to Athanasius, Nestorius, and Cyril, nor have the three English words always preserved the same meaning. The modern idea of personality would perhaps have been unintelligible to the Fathers at Chalcedon; and changes in that idea, subtle but significant, have taken place even within the last half-century. The theological phraseology employed to describe religious truth may well be varied as the generations pass. But the simple, untechnical language of the NT concerning Father, Son, and Spirit, Three in One and One in Three, whatever various comment it may receive, remains the highest and the best, as it was the earliest, expression of what the sacred name GOD means in the Christian religion.

LITERATURE.—*OT Theologies* of G. F. Oehler (Eng. tr., Edinb. 1874), H. Schultz (1892), R. Smend (Tübingen, 1899), A. B.

Davidson (Edinb. 1904); *NT Theologies* of H. Holtzmann (Tübingen, 1911), W. Beyschlag (Eng. tr., Edinb. 1895), G. B. Stevens (Edinb. 1899); art. 'Gott,' in *PRE³* (Köstlin), 'Trinität,' *ib.* (Kirn); art. 'God,' in *HDB* ii. 196 and 205 (Davidson and Sanday), 'Religion of Israel,' *ib.* v. 612 (Kautzsch); artt. 'Theism,' 'Theology,' in *EBR¹¹* (R. Mackintosh). See also R. Kittel, *Hist. of the Hebrews*, Eng. tr., London, 1895-6; C. G. Montefiore, *Religion of the Ancient Hebrews²*, do. 1893; E. Schürer, *HJP*, Edinb. 1886-90, *passim*; F. Weber, *Jüd. Theol.²*, Leipzig, 1897; O. Pfeiderer, *Philosophy of Religion²*, Eng. tr., Edinb. 1886-8; M. de Wulf, *Hist. Medieval Philosophy*, Eng. tr., London, 1909; H. Osborn Taylor, *The Medieval Mind*, do. 1911; E. Hatch, *Influence of Greek Ideas and Usages upon the Christian Church*, do. 1890; E. Caird, *Evolution of Religion²*, Glasgow, 1894, *Evolution of Theology in the Greek Philosophers*, do. 1904; Goblet D'Alviella, *Origin and Growth of the Conception of God*, London, 1892; I. A. Dorner, *Doctr. of the Person of Christ*, Eng. tr., Edinb. 1861-63; A. Harnack, *Hist. of Dogma*, Eng. tr., London, 1894 ff., *What is Christianity?* do. 1901; A. B. Bruce, *Humiliation of Christ²*, Edinb. 1881; R. L. Ottley, *Doctrines of Incarnation*, London, 1896; C. Gore, *Incarnation*, do. 1891; A. M. Fairbairn, *Christ in Modern Theology*, do. 1896, *Philosophy of Chr. Religion*, do. 1902; H. R. Mackintosh, *Person of Christ*, Edinb. 1912; K. v. Lechler, *Biblische Lehre vom heil. Geiste*, Gütersloh, 1899; H. B. Swete, *The Holy Spirit in NT*, London, 1909, *The Holy Spirit in the Ancient Church*, do. 1912; Augustine, *de Trinitate*; F. C. Baur, *Christliche Lehre von der Dreieinigkeit und Menschwerdung Gottes*, Tübingen, 1843; G. A. Meier, *Die Lehre von der Trinität*, Hamburg, 1844; J. R. Illingworth, *Doctrines of Trinity*, London, 1907.

Amongst modern books on Theism and the Christian Doctrine of God may be mentioned I. A. Dorner, *System of Christian Doctrine*, Eng. tr., Edinb. 1880-82; J. Orr, *Christian View of God and the World*, do. 1893; J. R. Illingworth, *Personality Human and Divine*, London, 1894, *Divine Immanence*, do. 1898, *Divine Transcendence*, do. 1911; R. Flint, *Theism²*, Edinb., 1878, and *Antitheistic Theories*, do. 1896 and 1897; J. Martineau, *Study of Religion*, Oxford, 1888; S. Harris, *God the Creator and Lord of All*, Edinb. 1897; J. Royce, G. H. Howison, etc., *Conception of God*, London, 1897; A. C. Fraser, *Philosophy of Theism²*, Edinb. and London, 1899; A. Caldecott, *Philosophy of Religion*, London, 1901; H. M. Gwatkin, *Knowledge of God*, Edinb. 1906; W. Adams Brown, *Christian Theology in Outline*, do. 1907; W. N. Clarke, *Christian Doctrine of God*, do. 1909; R. Eucken, *The Truth of Religion*, Eng. tr., London, 1911; J. Ward, *Naturalism and Agnosticism²*, do. 1903, *The Realm of Ends, or Pluralism and Theism*, Cambridge, 1911. The various series of Gifford Lectures, only a few of which are mentioned above, are well known.

W. T. DAVISON.

GOD (Buddhist).—A general statement of Buddhist belief with regard to the Divine, and of the conception which Buddhists generally have formed of God, presents considerable difficulties—less on account of the complexities of the belief in itself than by reason of its many-sided character, and of the very various views that are held in the many Schools of Buddhism. The sects of the Hinayāna and the Mahāyāna are as far apart in their doctrine of God as in any other article of their loosely-knit, respective creeds, and perhaps further. Both have departed widely from the position of primitive Buddhism, as formulated by Gautama Buddha himself, according to the usual interpretation of his teaching on this subject. There is, indeed, little evidence that that teaching was ever actually put into practice beyond a narrow circle, or the generation of his immediate followers and disciples. By its philosophic detachment and refusal to make concession to the natural desire of the human heart for some external support and supernatural aid in the conflicts of life, it set itself in opposition to the universal tendencies of religious thought and the cravings of the religious life, and—probably inevitably—while appealing to the few, lost the support of the majority of mankind, whose needs it thus failed to meet.

It is probably an erroneous view of the original teaching of Gautama Buddha which explains his attitude as entirely and of set purpose atheistic; as construing the universe in a materialistic sense, and denying the existence of a God. That he interpreted the universe in the sense indicated is in all probability true; and his views in this respect were derived from the ancient doctrine of the Sāṅkhya philosophy, which in India professed to explain everything in terms of soul and matter (*puruṣa* and *prakṛiti*), and to have no need for the

intervention of a Divine power. The latter view, however—that the founder of Buddhism intended to give expression to distinctly atheistic views—seems to be a mistaken inference from the response which he is recorded in the Buddhist books to have given to the questioning of his disciples with regard to another world, and his refusal to offer any definite instruction on the spiritual and unseen, or to illuminate, with any ray of light which he was competent to give, the uncertainty and darkness of the unknown realm that lay beyond the touch of sense. To all requests for enlightenment and teaching on the subject of the supernatural he steadily, if the record of the sacred books may be trusted, opposed a negative. The redaction of these books is, of course, many centuries later than the period at which Gautama lived. There is no reason, however, to doubt that in this respect they correctly report his views.

The inference, however, that he intended to imply personal disbelief in the supernatural and in the existence of a God, and to urge or enjoin this upon his disciples, is certainly mistaken. As 'enlightened' and in possession of the true and perfect *bodhi*, which he had gained after so many years of strife and endeavour, it is most unlikely that he meant to indicate that in this one particular—a subject of so transcendent importance—his insight was defective, and that he was unable of his own personal knowledge to satisfy inquiries as to the other world and its Ruler. Such a disclaimer would be entirely out of harmony with the attribute of omniscience, to which as *Tathāgata* and *Buddha* he laid claim, and which in other respects his teaching seems to have uniformly implied. Neither apparently did his hearers understand him in any such sense. The significance of his reply was rather this, that his disciples were to rely upon their own unaided efforts for deliverance from the misery of the world and of existence, not upon possible external aid; and that the question whether there were a God and a hereafter was of no moment for the obligation and duty of the present. The position which it was his purpose to adopt was neither atheistic, nor, in the strict sense of the term, agnostic. But for his hearers it was immaterial whether the reply were in the affirmative or negative; and speculation on the subject was discouraged or forbidden, lest it should impair or destroy that firm spirit of self-reliance which it was his object to arouse in their hearts. A declaration of ignorance on so momentous a subject would have been entirely at variance with his claims as a teacher of the truth, enlightened in regard to all the secrets of the universe, and of man's course and destiny therein. He simply refuses to communicate to his disciples knowledge which he judges to be needless for practical life, and the consideration of which would only minister to a harmful curiosity anxious to speculate on matters beyond human ken. In all probability he himself shared the ordinary views of his contemporaries with regard to the being and nature of God, and philosophically found himself in sympathy with the negative doctrines of the Sāṅkhya school of thought, which ignored the question of His existence, and constructed its scheme of the universe without reference to any possible interposition of the Divine (see AGNOSTICISM [Buddhist]).

The presentation of the doctrine of God in the Buddhist books of the Hinayāna school is entirely in harmony with this interpretation of the mind and purpose of Gautama himself. There is, indeed, no exposition of set or formal doctrine on the subject, or any definite and consistent body of teaching. It is assumed that the hearer or reader is in possession of certain general views, which are neither atheistic nor agnostic, but entirely theistic.

And a strongly anthropomorphic conception is elaborated with the utmost possible freedom, presenting a rich and even extravagant mythology, which is based ultimately, in all essentials, upon the popular polytheism of the Indian peoples, and reproduces the two main currents of thought of its original—that, namely, which exalted the object of its reverent worship as the supreme Author and Creator of all; and that which was content with an innumerable company of deities, of varied attributes and power, often deficient and liable to err, as frail and incompetent as men.

Thus a more or less complete enumeration is presented of the various classes of gods. There are Sakka and Yāma gods, gods of the Tuṣita and other heavens, Brahmā and Mahābrahmā gods, etc.;¹ and of the thirty-one grades of being or sentient existence, the divine or that of the gods is one.² Elsewhere reference is made to the gods of the Thirty-Three, i.e. subordinate classes or varieties of gods, who approached Sakka the ruler of the gods with questions or complaints.³ And, entirely after the manner of Indian mystical conceptions and rules, of the ten subjects of meditation or 'reflexion' (which include the physical body and death, as well as the three 'gems'—the Buddha, Dharma, and Saṅgha) meditation upon the gods is one.⁴ The infirmities and disabilities of men are all predicated of the gods, e.g. they are liable to old age, decay, and death,⁵ and are not exempt from the law of transmigration or the control of *karma*;⁶ they are subject to desire or passion with all its evil consequences;⁷ and even the greatest of them, Brahmā himself, has to confess to ignorance of the nature and constitution of things which he might be expected to know.⁸ As they are not omniscient, so also they are not omnipotent;⁹ and it is further explained that not even a god, but only one who is born a man, can by resolution and perseverance attain the highest state of a Buddha.¹⁰

Apparently also the abstract and philosophical conception of Brahmā as the First Cause, the Creator and Ruler of all, was taken over by Buddhism, but made no impression upon the disciples of the Hinayāna, and was too much out of harmony with the general prepossessions of the Southern School of thought to influence their system of doctrine. It appears in the *sūtras* of the Mahāyāna, sometimes only to be controverted; especially in the Chinese version of *Aśvaghōṣa's Life of the Buddha*.¹¹

The most striking and for Buddhist doctrine important conception of the Divine was the uniform exaltation of the Buddha himself above the highest god. In the Northern School this thought found expression in the conception of the Adibuddha, supreme and alone, the first of all the

¹ The *Dhamma-cakka-ppavattana Sutta*, 27, enumerates seven of these heavens, each with its appropriate company of gods.

² *Abhidhammattha-Saṅgaha*, v.; *Kevaddha Sutta*, xi.; *Jātaka*, i. 47, 68, etc.

³ *Samyutta-Nikāya*, xi.; *Buddhaghōṣa on Dhammapada*, 48.

⁴ *Visuddhi-Magga*, iii.

⁵ *Mahā-Parinibbāna Sutta*, vi. 16.

⁶ *Ib.* 19 ff., etc.

⁷ *Sutta-Nipāta*, iii. 6.

⁸ *Kevaddha Sutta*, 81; cf. the wisdom of the true Brāhman contrasted with the ignorance of others, including the gods (*Dhammapada*, 419 f.; *Sutta-Nipāta*, iii. 9).

⁹ 'Not even a god . . . could change into defeat the victory of a man who has vanquished himself' (*Dhammapada*, viii. 106; cf. *ib.* iv. 44 f., xvii. 224 f., *Sutta-Nipāta*, iii. 35, and *Dhamma-cakka-ppavattana Sutta*, 25 ff.: the wheel of the empire of Truth, which the Buddha has set on its course, cannot be turned back by any god).

¹⁰ *Jātaka*, i. 14.

¹¹ See S. Beal, *Fo-sho-hing-tsan-king*, Oxford, 1883, pp. 106, 195, 206-208, etc.; *SBE* xlix. [1894] 176, etc.; cf. *Brahmajāla Sutta*, ii. 5 f., where the titles of Creator, Ruler, Father, etc., are applied to the great Brahmā. An atheistic or semi-atheistic view is expressed, *ib.* iii. 14.

Buddhas, without companion or peer.¹ But the religious thought of the Hīnayāna, moving on different lines, glorified the historical Buddha, Gautama himself, and finally satisfied its need for an object of reverence and worship by practically deifying its Founder. At his birth and death the gods come to pay him homage; they strew flowers and garlands before the corpse, and worship the relics after cremation. On more than one occasion during his lifetime they appear and offer him reverence; but especially when Gautama gains perfect insight and enlightenment under the Bo Tree.² He also is their teacher and guide into the Truth;³ and they are by him converted to a knowledge of and obedience to the right way.⁴ Elsewhere the same worship is extended to all the Buddhas and even to the *muni*, the sage, the man who has vanquished his passions and has entered on the path that leads to Buddhahood. Significantly also the perfect wisdom of the Buddha is contrasted with the imperfect and limited knowledge which the gods possess. He is god over all gods, supreme in knowledge as in power. And thus in the doctrinal system no less than in the actual practice of the Southern School, which in most respects is undoubtedly more true than its great rival to the teaching of Gautama himself, the deistic theories of the founder, or at least his prohibition of speculation and dogmatism on the nature of the unseen and the being of a god, have been ignored or transcended; and the faith and practice which he inculcated, and which bade his disciple look to himself and by virtue of his own strength and resolution win for himself deliverance from the bondage of existence and misery, have had superadded to them a practical deification of his person and a theistic belief in his supremacy and power.

Historically therefore, at least in its expansion and development within the area in which the Hīnayāna school of thought has prevailed, Buddhist experience has been marked by the growth and strengthening of a theistic movement which has found its centre in Śākyamuni himself.

It is probably right to regard the Buddhist teaching of the Hīnayāna as the truest exponent of Gautama's own doctrine and belief; and philosophically and in theory it has always remained loyal to the principles, deistic and agnostic, which he is understood to have commended and enforced. In practice, however, outside of the circle of the more metaphysically minded and capable of the monks themselves, and certainly to the laity, the process referred to has restored to Buddhism the personal centre and object of adoration which was lacking in the impersonal self-centred doctrines of the primitive teaching. The earliest Buddhist thought, as expressed and formulated by the Master himself, was consistently agnostic, if the representation of the Pāli books may be trusted; professed its ability to secure the highest and most desirable aims without requisitioning external aid; and from its world-scheme omitted the superhuman and the Divine. That, however, was not a position in which the followers of Gautama Buddha were satisfied to rest. The human craving for an ideal or idealized object of love and homage was too strong for the remote aloofness and somewhat cold philosophy of the doctrine. The desire was met, and found its satisfaction, in the deification of Śākyamuni himself; and this tendency manifested itself, to all appearance, at or very soon after his death. With him were reintroduced the Hindu deities, or the more important and popular of them. But they were always subordinated in attributes and power

¹ See art. ĀDIBUDDHA, vol. I. p. 93.

² *Mahāparinibbāna Sutta*, *passim*.

³ *Ib.* II. 9, III. 49, etc.; *Fo-sho-hing-tsan-king*, v. 28.

⁴ *Ib.* IV. 20; *Buddhacharita*, xvi. 48, etc.

to the Buddha. And thus a system in theory deistic became a practical polytheism.

It was far otherwise, apparently from the very beginning, in the Mahāyāna system. There is no indication that the deistic type of thought ever found a place in the Northern School. Indian in its origin, it retained the rich, even extravagant, features of Oriental fancy and speculation which the Buddhist reform rejected; amplified its mythology, and elaborated a complete and extensive hierarchy of divine beings, of many grades and capacities, at the head of which, remote and altogether abstracted from practical life or experience, was the Ādibuddha (*q.v.*), a metaphysical conception but not an active force in touch with the universe which he was supposed to have brought into being. The deities, moreover, so far from remaining unconcerned, interested themselves purposefully and actively in the affairs of their worshippers, and rendered them effective aid in all their most pressing needs (see BODHISATTVA).

Mahāyāna Buddhism, therefore, was always theistic, and even monotheistic, not denying the existence of other deities, but subordinating them to a single Head. It differed remarkably, however, from the more colourless theism of the South in that among the innumerable Buddhas, who held the most exalted rank in the celestial hierarchy, Śākyamuni, the historical Buddha, occupied an entirely subordinate position. The process of deification had been applied to all the Buddhas; and all, having been human teachers upon earth, had by virtue of their own insight and effort won for themselves an abiding place in the highest heaven. Vows were made to them, prayers offered, and their favour and assistance sought in the ordinary no less than in the extraordinary events of life. Gautama, however, was only one among the rest, by no means the most distinguished or important. The first place was taken by Amitābha (Amida), a deity whose origin and history are altogether obscure,¹ but who was invested in the popular thought with every attribute that could attract devotion or win homage, and on the delights of whose paradise Mahāyānist writers expatiate with unrestrained delight. To be received thither after death and to see Amida in his glory was the longing desire of every pious believer. The Indian founder of Buddhism was hardly more than a figure and a name. In Amida every wish was centred. Grace, mercy, and beneficence, as well as wisdom and power, were his attributes. Homage might be and was given to others. But to Amida every heart went out in loving adoration with the assurance that he would hear and heed the prayers of his worshippers. A reform movement was initiated in Japan in the 13th cent., the object of which was to reinstate Śākyamuni in the supreme place. It proved, however, an entire failure. Amida has almost universally retained the position, which he has held from a very early period, the embodiment of every Divine grace, the all-wise and all-powerful guide and friend of all who call upon him.

From the speculative and metaphysical point of view also the Buddhism of the Mahāyāna, in formulating its conception of the Divine, gave expression to the familiar thought of a first principle, the primeval and essential cause of all that is. By the Buddhist thinkers of Japan in particular this result was attained. This determining principle and cause was known as the *Dharmakāya*,

¹ In one form of the legend he is born spontaneously from a lotus, without father or mother. In all probability the conception and worship of Amida were introduced into China from the West in the early centuries of the Christian era, and were of Indian origin. Other authorities, however, would connect his worship and cult with Persian Mithraism. His paradise is always conceived to be in the West.

the 'body of righteousness' or 'of the law' (cf. art. *ĀDIBUDDHA*, vol. i. p. 97 f.); and was in theory identical with the Buddha, one of his three bodies, his essential and permanent nature, by virtue of which he was one with all existing beings and all existing beings were one in him. The *Dharmakāya* represented, in fact, the ancient Indian conception of Brahman, but with a very important difference. The Buddhist philosophers and thinkers never lost their hold of the personal element or attribution in the *Dharmakāya*. So far from being a blind or impersonal force, the *Dharmakāya* was conceived as endowed in the highest degree with the most distinctive attributes of personality, especially will, intelligence, and love. It is in Amitābha Buddha that the *Dharmakāya* has chiefly manifested himself, and Amitābha therefore is the supreme object of religious homage and worship. The whole creation, however, is a manifestation of the *Dharmakāya*; all are really now one in him, their union being darkened and obscured by ignorance, prejudice, and sin. In the final issue they will in the *Dharmakāya* find the light and their own true nature, and be delivered from the bondage of present evil and suffering.

Accordingly this was the crown and completion in the Northern School of Buddhist teaching with regard to the nature of God and man's relation to him from the metaphysical standpoint. It differed from the Hindu view in that it so strongly maintained and emphasized the personal element. In this respect it had not a little affinity with Christian thought. Necessarily, however, it was and remained the conception of the thoughtful few; and, although truly and faithfully representing Buddhist doctrine at its purest and best, it was of too abstract and mystical a nature for the apprehension of the many. Their faith and love centred in Amitābha with his paradise of perpetual bliss, and sought for nothing further. The philosophical reasoning and the popular aspiration and devotion met and were reconciled in the doctrine that these were one and the same, that Amitābha (*Amida*) was, indeed, the highest manifestation of the *Dharmakāya*.

The Buddhist doctrine of God, therefore, even in its most abstract and speculative form, never lost touch, as did the Vedāntic philosophy of India, with which it is most natural to compare it, with experience, feeling, and devotion. It personified the highest attributes of man—mercy, gentleness, and love; and conceived these in a truly noble and generous spirit. In India its similarity is most marked to some forms of the so-called sectarian religions, and especially the Bhāgavata faith, which inculcated devotion to the one Supreme Lord, and self-sacrificing love in His service (see art. *BHAKTI-MĀRGA*, vol. ii. p. 540 ff.). Its accord in many respects with Christian teaching is not improbably to be explained on the hypothesis that at some period in the course of a long history and development it came under Christian influence, and borrowed elements from Western teaching; and that in part at least the similarity is due to the assimilation of Christian doctrine and forms of belief conveyed more or less directly in the early centuries of our era by missionaries from Europe. The theory is incapable of proof in the present state of knowledge, and may be altogether devoid of foundation. Under any circumstances, however, the development of the doctrine has proceeded on altogether natural and Oriental lines. Whether historical contact has at any point taken place and a mutual influence been exerted, or whether doctrinal growth has been altogether spontaneous and independent, it remains true that, of all non-Christian conceptions of God, the Buddhist theory of the *Dharmakāya*, the Divine Ruler immanent

in the universe and manifesting Himself in His creation, is perhaps the nearest to the New Testament teaching and ideal.

LITERATURE.—The literature is sufficiently indicated in the articles to which reference is made, especially those on *BUDDHA* and *ĀDIBUDDHA*. For the Mahāyāna, see also D. T. Suzuki, *Outlines of Mahāyāna Buddhism*, London, 1907; Arthur Lloyd, *The Creed of Half Japan*, do. 1911; K. J. Saunders, *Buddhist Ideals*, Madras, London, and Colombo, 1912. The last-named work has regard mainly to the Buddhism of Ceylon, but is well worthy of study. A. S. GEDEN.

GOD (Chinese).—The Chinese language possesses two terms which, as far as etymology goes, seem adequate to stand for 'God.' The former of the two is *Shang Ti*, or 'Sovereign (*Ti*) Above (*Shang*)'; the second is *T'ien*, or 'Heaven,' often used in later centuries for the visible heavens, but explained in the ancient Han dynasty dictionary (the *Shuo Wên*, largely quoted in the Imperial Dictionary of Kang Hsi) as 'the Exalted in the highest, being formed of signs meaning the One who is great.' Some famous Chinese scholars have explained the common substitution of the latter for the former by saying: 'It is not lawful to use the name of *Shang Ti* lightly, and therefore we name Him by His residence, which is *T'ien*, or heaven'—on the principle that 'the Court' stands for 'the Emperor.' *T'ien*, however, probably seemed to the Chinese mind the more appropriate term for general literary use, after the early ages, standing, as it does, for an unfocused God.

The earliest reference to *Shang Ti*, or indeed to any religion whatever, in the ancient history of China, is found in the words: 'The Yellow Emperor (2697-2598 B.C.) sacrificed to *Shang Ti*, gathered the whole populace together, and diffused among them (the principles of) government and religion.'¹ We seem to have here a brief note of the worship of a patriarchal priest-king, somewhat 'after the order of Melchizedek,' in the days before that branch of the Turanian race now called Chinese had continued their eastward migrations to the bend of the Yellow River, to occupy the territory which formed the nucleus of present-day China. For the palace of the Yellow Emperor is said (in a work 'probably of the 2nd or 3rd cent. B.C.' [Wylie] and universally since) to have been on the Kun-lun mountain, over a thousand miles westward from the capital of the Chow dynasty sovereigns (1122 B.C. onwards).

The next historical reference to *Shang Ti* is in the reign of the emperor K'u (2435-2366 B.C.), father of the much-quoted emperor Yao: 'Chiang Yuan (his consort) together with the emperor sacrificed to *Shang Ti*, and bore Ch'i' (or Hou Chi), afterwards Director of Husbandry under the emperor Yao. The *Book of Odes* celebrates the birth in the words: 'Shang Ti regarded her with favour; and without hurt or injury, immediately her months were fulfilled, she gave birth to Hou Chi.' Then, in the unimportant reign of Wu Tin (1324-1266), that ruler, wishing to obtain an able counsellor, 'reverently meditated upon moral matters, and in a dream *Shang Ti* bestowed upon him an able and virtuous helper,' whom he afterwards sought and found in reality. From this point, as far as the Historical Annals are concerned, we find the term *T'ien* substituted for *Shang Ti*. Thus the 'flood-regulator' Yü (2205-2198 B.C.), on assuming the throne, said: 'I have received the decree of Heaven, and will devote my whole energies to comfort the myriad populace in

¹ This quotation is found in the 'Easy Edition of History,' published in 1711, and ranking second only to the 'Imperially edited' edition, published in 1767. It is an abbreviation of an edition drawn up by Chü Hsi (1130-1200), which was itself a condensation of the great work of Ssu Ma-kuang (1019-1036). The tendency has always been to omit, never to add, references to spiritual matters, and we may take the quotation as an ancient one.

their labours.' And to the tyrant Chieh (1818-1767 B.C.) a memorialist said: 'The hearts of the people are lost, and Heaven's decree no longer aids'; while of the model monarchs of antiquity an early commentator says: 'They enjoyed (the favour of) Heaven's heart, and received Heaven's manifest appointment.' But that the two terms *Shang Ti* and *T'ien* were interchangeable is strikingly shown in the *History Classic* (v. 23): 'Thus did they (Wên and Wu Wang) receive the true appointment of Shang Ti; thus did Imperial Heaven approve of their ways and give them the four quarters (of the empire).'

A prominent topic in the *History Classic* is the reverence with which a ruler should carry on his government. The object of that reverence would seem to be the Supreme, whether quoted by the term *Shang Ti* or by *T'ien*. But that the former term was in frequent use down to the 12th cent. B.C., and still current much later, is evident from the passages about to be cited. The earliest reference to Shang Ti in the *History Classic* does not give us a picture of absolute monotheism: 'The emperor Shun sacrificed specially to Shang Ti, offering lesser sacrifices to the Six Honoured Ones, to the hills and rivers also, and extended his regard to the multitude of spirits.' On the whole subject a memorialist of the Sung dynasty (Hu Hung, 12th cent. A.D.) says: 'The ritual of the Chou dynasty (1122-222 B.C.) consisted in the solitary sacrifice to Shang Ti, and in offering of heaped-up faggots to sun, moon, and stars, and of bundles of reeds (as in later ceremonial homage to Confucius) to the household and kitchen spirits, and to the wind and rain spirits.'¹ In a memorial to the emperor T'ai Chia (1753-1721 B.C.), his aged minister gives us an interesting glimpse of the religious opinions of the times, which prompted a secondary worship to 'the spirits of heaven and earth, of the land and grain, and of the ancestral temple'; for the former sovereign is said to have 'served and obeyed' all these, 'keeping his eye all the while upon the lustrous requirements of Heaven.' The 'spirits of heaven and earth' were destined in after years to loom larger in the popular imagination than Shang Ti; and in six hundred years' time we find a model ruler, who ousted the last tyrant of the Shang dynasty (1122 B.C.), announcing 'heaven and earth' (perhaps in those early days an equivalent to our modern word 'Nature') as the 'parent(s) of all things.'

Yet Shang Ti was still recognized as the one King of kings—often in a very literal sense. 'Now Heaven, to protect the populace, made for them rulers and instructors, able to assist Shang Ti, and to secure the tranquillity of the (realm in all its) four quarters.' And so, returning to the earlier passages in the *History Classic*, we find Yü (afterwards emperor), while yet a minister of the emperor Shun, counselling him saying: 'Abide in your resting-point, attend to the springs of things, study stability, employ upright assistants,—then will your every action evoke a large response from a submissive populace, you will receive in brightness (the bounty of) Shang Ti, and Heaven will surely renew its appointment, dealing out blessing.'

The dynasty of Hsia, founded by Yü the Great, lasted four hundred years, and, like all the succeeding dynasties, grew rotten towards the close. A new start was needed, and T'ang the Completer was the man for the crisis. Arousing the populace

to revolution, he addressed them saying: 'The (present) sovereign of the Hsia dynasty is an offender, and, as I fear Shang Ti, I dare not but rectify (the situation, by punishing him).' In a later chapter of the *History Classic* the case is represented in the words: 'I have heard that Shang Ti guideth to rest,' but (the sovereign of) Hsia would not enter into His rest, whereupon Shang Ti visited him with corrections. Then, as history repeated itself at the end of the dynasty founded by T'ang the Completer, it is recorded of the last ruler of the series that he 'was much abandoned to dissolute idleness, regarding neither the manifest (will of) Heaven nor the importance of the people, so that Shang Ti no longer protected him, but sent down the great ruin which we have seen.' For, as another passage expresses it: 'The favour of Shang Ti is not (unconditionally) settled; it is upon the good that He sends down manifold blessings, but upon the evil-doer manifold calamities.' Also 'The Majestic Shang Ti has conferred (even) upon the ordinary populace a moral sense, to comply with which would give them a right and constant spirit.' Then, passing over some fifteen other quotations in the not very massive *History Classic*, we find a glowing recognition of the goodness as well as the righteousness of Shang Ti in the ancient *Book of Odes*.

'Great is Shang Ti! Descending (or down-bending) in majesty, surveying all regions, seeking the repose of the populace.'

'How vast is Shang Ti, the Ruler of the populace below! How awful is Shang Ti! How irregular are many of His dealings! . . . (yet) it is not Shang Ti that has caused this evil time, but Yin, in not following the (good) old (ways).'

'There is the majestic Shang Ti. Does He hate any one? [Nay, He gives rain and fruitful seasons.] How beautiful are the wheat and barley! What shining produce we shall receive! The bright and glorious Shang Ti will give us a good year.'

In another ode there is the exhortation, 'Have no doubts nor anxieties. Shang Ti is with you.' This message occurs in other language, a thousand years later, in the *Annals of Ssu-ma Ch'ien*, addressed to the emperor (Han) Wu Ti (140-87 B.C.): 'Shang Ti bends down in grace and manifold blessing, bringing (the enterprise) to a commendable conclusion.'

The great essentials of the devout life are described as having been fulfilled in the case of Prince Wên (father of the founder of the Chow dynasty): 'This Prince Wên, with the carefulness of a fluttering bird, served Shang Ti intelligently, and secured abounding blessing.' This passage is the more interesting as marking the non-Imperial worship of Shang Ti, for the title 'Prince (or King) Wên' is merely the 'title of canonization' given to duke Ch'ang of the State of Chow, otherwise called 'Marquis of the West.'

The special ceremonies of worship, in yet earlier days, on the part of T'ang the Completer, before he ascended the throne, are thus described by the worshipper himself: 'I, the little child . . . presume to use a dark-coloured victim, making clear announcement to the spiritual Sovereign of the high heavens.' Such is the version in the *History Classic*, and in the *Analecfs of Confucius*: 'I, the little child Li (the child-name of T'ang), presume to use a dark-coloured victim and presume to announce to thee, O most majestic and imperial Shang Ti.' And the consciousness of priesthood on the part of the sacrificer, not yet 'Son of Heaven' or special representative of Heaven, is expressed in the rest of the invocation: 'If in my own person I commit offences, they are not to be attributed to the populace of the land. If the populace commit offences, they must rest on my person.'

Leaving unnoticed about seventeen other references to Shang Ti in the *Book of Odes*, we find the requirements of kingly worship described by a statesman of the Sung dynasty (Li Kang, 1085-1140): 'Heaven is to the sovereign as father and mother to a son, loving him with an extreme love.'

¹ Traces of the worship of the heavenly bodies occur in the early history of China, in a memorial to the emperor Ku (1101-947 B.C.), and references are found in other works, amounting to some two hundred and seventy characters—such worship being described as extremely ancient. Traces of ancient altars to wind-spirits have also been found on an unfrequented hill-top in Kiangsi, and doubtless might be found in other parts.

and therefore giving him extreme admonition. Thus a ruler of men, admonished by Heaven, must be fearful and careful to the point of sincerest awe.' To this a statesman of the 12th cent. (Hu Hung) adds: 'The sovereign serves Heaven as (a son serves his) father. He must do so with settled sincerity, and the most refined unity of virtue. He selects a spot of rural land to the south of the city, sweeps the ground, and sacrifices to "Shang Ti of the vast Heaven," the word "Heaven" pointing to His disposition, and the word "(Shang) Ti" referring to His essential nature.' An emperor of that dynasty (Hsiao Tsung, 1163-1189) replies to this: 'I sincerely and reverently serve Heaven, and Heaven continues to me happiness and blessing.'

That some of the ceremonies of Imperial worship were originally undertaken by way of example to the populace seems clear from their connexion with the annual handling of the plough by the sovereign and local officials—a ceremony continued every spring-time until the Revolution of 1911. The *Book of Rites* says: 'In the first month of spring the Son of Heaven prays to Shang Ti for a good harvest . . . and himself handles the plough.'

An emperor with an otherwise fair name set a very different example to the populace in after years by identifying Shang Ti with the visible sky, and raising Earth to a position of equality with Shang Ti as an object of worship—calling forth the condemnations of the best scholars ever since in connexion with his adoption of five *Ti's* at the same time. That emperor was (Han) Wên Ti (179-157 B.C.). The story begins with the accession of 'The First Emperor,' as he termed himself, in the year 221 B.C., who for the time abolished the ancient worship of Shang Ti, setting up as objects of worship eight new deities, Heaven-lord, Earth-lord, War-lord, Yang-lord, Yin-lord, Moon-lord, Sun-lord, Four-seasons-lord; and so great was the resulting disorganization of Imperial worship that Wên Ti, coming to the throne fifty-two years later, passed fourteen years of his reign without attending to any religious rites at all. Then, in the fifteenth year of his reign, he was informed by the Master of Ceremonies that 'of old the Son of Heaven every summer [he should have said 'every spring and autumn'] personally offered ceremonial worship to Shang Ti,' and the emperor, awaking to his duty in the matter, went forth to do so. But, wishing to improve on the ancient custom, he said: 'I now personally offer sacrifice to Shang Ti, but Regal Earth is without a sacrifice, and so the ceremony is one-sided'; whereupon he erected an altar to Regal Earth, and offered similar sacrifices thereon. Thus the historian Ssu-ma Ch'ien relates in his 'Sacrificial Records.' And in his 'Historical Records' proper he says that altars to the 'Five Imperial Ones' were also erected. The emperor King Hsi, of the last dynasty, in his 'Imperial Annotations,' criticizes these serious public innovations by saying: 'Those who know the true constitution of the universe may not allow themselves to be thus deluded by spirits and bogeys.' And the editor of the 'Easy Edition of History' in 1711 exclaims: 'Heaven is one! And to talk of Five Imperial Ones! Such is not following antiquity! Sick-minded Emperor!'

The action of Wên Ti, however, was to be outdone by the weak emperor Hui Tsung (A.D. 1101-1125), who deified a favourite court magician as the 'Precious Shang Ti,' literally 'Gemmous or Jade Shang Ti'—still the chief idol of decadent Taoism.

Under the term 'Heaven,' as used of the Supreme, there are many fine utterances. In the works of Yang-Tzu (53 B.C. to A.D. 18) we read:

'Heaven is spiritual, Heaven is intelligent, with an enlightened knowledge of all regions; Heaven is refined, Heaven is subtle, and all things do homage thereto.' Heaven is claimed by Confucius as the source of all that was good in him; and of the task of national renovation the *History Classic* declares: 'The work is Heaven's work; men are (but) deputies.' A work ascribed to Chiang T'ai-kung (12th cent. B.C.), and on sale at the official libraries, contains the words: 'Heaven's extreme partiality in practice is really extreme justice.' The erratic philosopher Chuang-Tzu (3rd and 4th cents. B.C.) exclaims: 'Partiality is human, but a large completeness belongs to Heaven.' And, in Lao-Tzu's much-quoted words, 'The net of Heaven stretches everywhere; its meshes are wide, but nothing escapes them.'

Pan Ku, a notable historian (died A.D. 92) says: 'Heaven has a disposition (capable) of pleasure and anger, a heart of sorrow and joy, answering to that of humanity, so that Heaven and man may be at one.' And the work known under the name of 'Kuan-Tzu' says: 'When a man's deeds accord with Heaven, Heaven aids him; when his deeds are opposed to Heaven, Heaven disregards him. Those whom Heaven aids, though small, become great; those whom Heaven disregards, though successful, must suffer defeat.'

'Heaven is most high, yet listens to the lowliest,' says a work of the 3rd cent. A.D. In the *Book of Odes* some one suffering from slander exclaims: 'O vast and distant Heaven, who art called our Father-Mother!' And the statesman Ch'ü Yuan (332-295 B.C.), under stress of calumny, says in one of his essays: 'Heaven is man's Origin; and when oppressed with poverty he recalls his Source. For when men are overwrought and worn out, who is there that does not cry to Heaven?' The latter remark applies to China of to-day.

LITERATURE.—J. Legge, *The Notions of the Chinese concerning God and Spirits*, London, 1852; J. H. Plath, *Die Religion und der Cultus der alten Chinesen*, Munich, 1862; J. Legge, *The Religions of China*, London, 1880; C. de Harlez, *Les Religions de la Chine*, Paris, 1891; P. D. Chantepie de la Saussaye, *Manual of the Science of Religion*, London, 1891; H. A. Giles, *Religions of Ancient China*, do. 1905; J. Ross, *The Original Religion of China*, do. 1909; J. J. M. de Groot, *Religion in China*, New York and London, 1912; see also art. COSMOGONY AND COSMOLOGY (Chinese), iv. 141.

W. A. CORNABY.

GOD (Egyptian).—I. Name and ideograms.—It is quite in accordance with the lack of the systematic faculty among the ancient Egyptians that, in all the vast profusion of their religious literature which has come down to us, no definition of the term 'god' has ever been found. For our knowledge of the conception we have to fall back upon discrepant allusions in the extant texts. The conditions of the earliest age of Egyptian civilization are indicated by ideograms which retained their ancient form in the script even when the objects for which they stood changed their shape. Of the ideograms used for the term 'god,' the subsequently rather frequent figure of the star (★) was derived from the occasional, but never altogether systematic, identification of the gods with the stars. The figures of the hawk or falcon¹ for 'god,' and of the *Uraeus*-serpent for 'goddess,' recall the incarnation of the sun-gods (with which a large number of other gods were subsequently assimilated) as falcons, and of goddesses as serpents. The late usage of figures of the three most sacred birds—hawk, ibis, and heron—instead of three hawks, as the symbol of 'gods,' is mere

¹ According to Loret, *Bulletin de l'Inst. français d'Archéol. du Caire*, iii. [1903] 1 ff., the *Falco peregrinus*. In the animal sepulchres, the most diverse kinds of predatory birds are mingled together (Lortet and Gaillard, *La Faune momifiée de l'ancienne Egypte*, Lyons, 1903, i. 124 ff.), and thus can hardly have been precisely distinguished by the Egyptians.

pictorial play.¹ A much more frequent figure is the short axe (𓂏), similar to that used by soldiers.²

The axe-head was let into a wooden helve and fixed with cords, and was painted yellow or white to suggest the polished stone used for such tools in the earliest age, and superseded later by copper or bronze. In the Nagada period, instead of the single axe-head, we sometimes find two such—thin and almost nail-like—attached to the handle. This symbol always represents a weapon, and in the inscriptions the standard, with which some have sought to identify it,³ is normally depicted in a different way. A cult of weapons is certainly met with on Egyptian soil. In the semi-Libyan Saïs a shield and two arrows served as a sacred symbol of the nome, while an armlet with its straps formed the ideogram of the goddess Neith. Implements of war were worshipped in the Upper Egyptian city of Pa-ahā, 'the house of conflict,' and are specified in a list from the reign of Pepi,⁴ while a duplicate of this list, dating from the reign of Seti I.,⁵ enumerates the weapons as sling (?), Amesceptre, club, harpoon, and two arrows. But the weapon-cult was, on the whole, of so limited a range that, while the derivation of the symbol for 'god' therefrom may seem probable, we are unable to trace the connexion with certainty.

The regular term for 'god' has the sound *ntr*, but from the time of the XVIIIth dynasty the final *r*, as in many other Egyptian words, tends to be dropped, and the Copt. *NOTTE* begins to come into use. Besides signifying 'natron'—a denotation which, in view of the fact that this substance was used in embalming bodies, might well arise from the meaning of 'divine'—the word *ntr* may be applied in two senses, viz. (1) to 'strike,' 'knock down,' 'throw,' and their derivatives (𓂏),

which, while it is written, not with the symbol for 'god,' but with another syllabic sign, would nevertheless accord with the figure of the axe; and (2) to 'grow,' 'thrive,' 'be young' (𓂏) —not, however, in the special sense of 'to come periodically and to be renewed,' as Loret (*REg* xi. 86 f.) supposed; nor can the meaning 'to be vigorous' or 'powerful' be decisively made out. The crenellated rampart with which the symbol is sometimes surrounded was intended, like the cartouche enclosing the king's name, to safeguard the term and its correlative concept against malefic magic.

The frequently recurring group 𓂏, *neter neter*, 'the youthfully fresh god,' is to be understood in the sense of 'being and becoming fresh, like a plant.' But this does not involve the wider sense of 'the god who by being renewed creates everlasting life for himself,'⁷ as such personal immortality was not an attribute of the Egyptian deities, who, as a matter of fact, grew old and were mortal. It is also doubtful whether the idea of vegetative youthfulness is really equivalent to the fundamental conception of deity, as, apart from the isolated figure of the sprouting Osiris,⁸ the distinctive character of which must not be regarded as general, plant-cults play but a small

¹ J. Dümichen, *Resultate der archäolog. Expedition*, Berlin, 1869-71, i. 21, 34.

² As in N. de G. Davies, *El Amarna*, London, 1903-08, i. pl. 15, iii. pl. 31; E. Naville, *The Temple of Deir el-Bahari*, London, 1898-1901, iv. pl. 90 and 91; cf. Wilkinson-Birch, *Manners and Customs of the Ancient Egyptians*, London, 1878, i. 214.

³ Loret, *REg* x. [1902] 101, xi. [1904] 69 ff.

⁴ *TSBA* iii. [1874] 110 ff., pl. 1-3, O 13.

⁵ Mariette, *Abydos*, Paris, 1869-80, i. pl. 44, 45, Z 45.

⁶ Renouf, *TSBA* viii. [1885] 198 ff. = *Life Work*, ii. 251 ff.; *Lectures*, p. 93 ff.

⁷ So Pierret, *Essai sur la mythol. égypt.*, Paris, 1879, p. 3.

⁸ Wiedemann, *Muséon*, new ser., iv. [1903] 111 ff.

part in Egypt. A reliable derivation of the term *neter* is, therefore, still to seek.

2. Monotheism or henotheism?—The earlier Egyptologists believed that a species of monotheism must have existed in the Valley of the Nile. As a primitive revelation, this, it was supposed, would mark the starting-point of the religious development, and was afterwards overgrown by polytheism, so that it is now traceable only in vestiges.¹ Other scholars were of opinion that monotheism existed side by side with polytheism, but that it was known only to the learned, i.e. the priests and the initiated. The theory of an Egyptian monotheism was often combined with the hypothesis that a doctrine of mysteries likewise prevailed here, though this finds no support in the religious texts. Moret,² arguing from the mystery plays of the Middle Ages, applies the term 'mysteries' to the Egyptian doctrines of immortality and of the ritual necessary for the attainment of the life beyond; but, as the texts show, these doctrines were in no sense esoteric. Greek writers who treat of the Egyptian mysteries speak of the belief in immortality—which formed an element in the secret mystery cults of Greece—as being an esoteric doctrine also in the Nile Valley, but here they are undoubtedly in error. In Egypt the only mysteries were magic words and ceremonies. Nor does the statement that certain chambers of the temples could be entered, and certain ritual performances witnessed, only by the initiated find any support in the extant texts.

From the Egyptian texts scholars have laboriously collected such passages as would imply a higher conception of deity, or such as attribute to the deity the qualities appropriate to a god regarded as One. They have also found passages which speak of a god as the creator of all life and all existing things, as one who traverses eternity, the lord of infinite time, one who cannot be grasped by the hand, whose evolutions are a miracle, the outstretch of whose being knows no limits, and who is king in Thebes, and, simultaneously, prince in Heliopolis, and the 'great of crowns' in Memphis. He cannot be seen; he listens to prayers; he turns his countenance to men according to their conduct; he is hidden, and his form is not known; he is alone, and there is none beside him.³ These attributes, however, were not all ascribed to the same deity, but now one now another of them was regarded as the special property of Amon, of Rā, of Ptah, or of some other member of the pantheon. Even when the texts refer to the One deity, they speak also of other independent figures. The One god is at most described, in a purely material sense, as the begetter,⁴ father, builder, conciliator, or king of the other higher powers. He is then, as such, the sovereign of the world of gods and men—one who, corresponding for the time being to the earthly Pharaoh, reveals his will to his subjects by decrees.⁵ In all this, however, he is never more than *primus inter pares*.

Nor is this relation essentially altered when it

¹ De Rougé, *Annales de la philos. chrétienne*, xx. [1869] 327 ff.; Chabas, *Calendrier des jours fastes et néfastes*, Paris, 1870, p. 110; Renouf, *Lectures*, p. 89 ff.; Pierret, *Essai sur la mythol. égypt.*, p. 6 ff.; more cautiously, Brugsch and Ebers, *Aegypt. Studien*, Stuttgart, 1900, p. 139 ff. Virey (*La Religion de l'ancienne Égypte*, Paris, 1910) would ascribe an almost Christian character to the primitive Egyptian ideas of deity.

² *Mystères égyptiennes*, Chalón-sur-Saône, 1911.

³ Pierret, *Essai*, 8 ff. (cf. in opposition, Maspero, *Études de mythol.* i. [1893] 115 ff.), and the same author, *Les Interprétations de la rel. égypt.*, Paris, 1912.

⁴ Cf. Wiedemann, 'Ein altägypt. Schöpfungsmythus,' in *Der Urquell*, viii. [Leyden, 1898] 57-75.

⁵ For such decrees of the deity, cf. Maspero, in *RTr* ii. [1880] 13 ff., *Mémoires de la mission archéologique française au Caire*, i. [1889] 594 ff.; for decrees in favour of the dead upon stelæ, see Wiedemann, in *Muséon*, x. [1891] 199 ff.

comes under the operation of syncretistic modes of thought, for in that case the other deities are defined as the various existences or phases (*ren-u*, 'names') assumed in other localities by the One god, whose 'names' are many. The tendency to such syncretism was specially active in the later period. The highest place is given in turn to Amon-Rā, Ptah, Hathor, Khnuphis, Isis, and others. The practice finds expression more particularly in hymns, which ascribe the supreme, all-dominating position to the deity who happens to be invoked for the time, as, *e.g.*, to Amon-Rā,¹ to other deities in the Oasis of Chargeh,² in Esneh,³ and so on. At a much later day, Apuleius (*Metam.* xi.) states that the true name of the goddess who was worshipped with various ceremonies, and under various forms and names, was Isis. How artificial the procedure might be in such cases may be seen from an inscription of the reign of Sabako, the aim of which was to assign, by syncretistic methods, the highest place to Ptah of Memphis.⁴ Such texts, however, just because of the prominence they give to the one deity invoked, are of little value for a proper estimate of the Egyptian religion as a whole. Notwithstanding textual data of this kind, the One god holds his dominating position only at a particular place, and even there the other gods are not absorbed in him, but maintain their own functions and individualities.

Once only in the history of Egypt was an attempt made, with the aid of the civil power, to invest a deity with a more comprehensive sway. About 1450 B.C. Amenophis IV. tried to secure a wider range for the cult of Aten, the solar disk—understood in a purely material sense, and hitherto but little regarded. To this deity the king dedicated his residence, on the site of the present Tell el-Amarna, and erected temples in his honour at Thebes, Memphis, and Heliopolis. He set himself vigorously against the cult of Amon, whose name he caused, as far as possible, to be erased from the inscriptions. He manifested no such hostility towards other deities, such as Ptah and Osiris; and, though their worship was thrown into the background, it was not abolished. What is said by king Tut-ānch-Amen (on a stele published and translated by Legrain, *RT* xxix. [1907] 162 ff.) regarding the gods who had suffered wrong at the hands of Amenophis IV. is really intended to extol the merits of the former in restoring the sanctuaries, and is not to be taken too literally.

The theory that Amenophis IV. engaged in a thoroughgoing campaign against all the traditional deities of his country is refuted, for one thing, by the character of the reaction against the cult of Aten which took effect after his death. It is true that the temples of Aten in Thebes, and perhaps also in Memphis, were destroyed, that the name of Amenophis was sometimes obliterated, and that he was designated as the blasphemer of the city of Khut-aten;⁵ but the monuments of his reign are, for the most part, left uninjured. As a matter of fact, a considerable number of these monuments survived till a late period in the temple of Amon himself at Thebes.⁶ Amenophis IV., in his religious reforms, did not in any sense deny the existence of Amon. His erasure of the latter's name rather proves the opposite, indicating simply that the king hoped thereby to damage and impair the god's prestige. While he seems to have held that Aten was the only deity with whom he and his kingdom had any concern, he was no monotheist in the strict sense of the word. It is to be regretted that his reforming movement cannot be distinctly traced in detail, as our only real information regarding the cult of Aten is derived chiefly from hymns,⁷ upon whose extravagant language we cannot safely rely.

The apparently monotheistic expressions on Egyptian monuments rest in reality upon henotheistic modes of thought. Each nome found its supreme Divine authority in its special deity. The god of the nome from which the Pharaoh had

¹ Papyrus Bulaq, no. 17; tr. Wiedemann (*Rel. of the Ancient Egyptians*, 111 ff.) and others.

² Tr. in Renouf, *Lectures*, p. 231 ff.

³ Daressy, in *RT* xxvii. [1905] 82 ff.

⁴ For the most recent discussion of this, see Erman, *SBAW*, 1911, p. 916 ff.

⁵ *Inscription of Mes*, ed. Gardiner, Leipzig, 1905, p. 54. It is very doubtful whether the hymn to Amon, in *Inscriptions in the Hieratic Character*, London, 1868, pl. 26, refers, as is believed by Erman (*ZÄ* xlii. [1905] 108 ff.), to Amenophis IV. at all. The hymn draws a contrast between the adherent and the opponent of Amon—the one prospers, while the other fares ill; but we need not regard this as alluding to any particular episode.

⁶ Legrain, *Annales du Service des Antiquités*, vii. [1906] 228 ff.

⁷ A long hymn addressed to him was first published by Bouriant, *Mém. du Caire*, I. [1884] 2 ff., tr. Wiedemann, *op. cit.* p. 40 ff.

sprung was always regarded for the time as the most important of the nome-gods. The very fact that he had raised his devotees to the throne of Egypt showed that he surpassed the other nome-gods in might. But his prestige lasted only so long as his chosen dynasty held the reins of power. If his favoured dynasty was supplanted by another whose members worshipped a different deity, he himself had to give place to the latter. Thus, on merely political grounds, the supreme position was held in the Old Empire by Ptah, under the Theban dynasty by Amon, and in the Saitic period by Neith.

As a rule, however, the supreme position of the nome-god did not remain unchallenged even in his own nome. Here also he had to tolerate the cult of other deities, who, like the sun-god Rā, or Osiris, the god of the dead, were venerated by all Egyptians, or were concerned in some special way with certain localities, occupations, families, or private individuals. The lower classes in particular took but little cognizance of the nome-god, or of other gods worshipped by people of higher rank. They preferred to worship deities whose sphere of action was believed to be relatively narrow. Some of the popular deities could exercise their power at any time; others had special functions, as, *e.g.*, that of affording security against demons in general (Bes), at birth (Thueris), on entering the under world (Amenthes, a form of Hathor), or that of protecting the corn (Nepera), etc.

This class also includes the special and temporary deities (Germ. *Sondergötter* and *Augenblicksgötter*), *i.e.* the numerous by-forms in which the great gods were invested with independent personalities, and which sometimes attained to an important position in the pantheon. This took place, for example, in the case of Imhotep, 'he who comes in peace,' and Sechmet, 'the mighty,' a secondary form of Sechet of Memphis. Probably Amon, 'the hidden one,' was likewise a special form of Min of Koptos, the god of fertility. To the same class belong, in particular, the numerous animals which might be regarded as animal-deities or as sacred animals.¹ Though the worship of such animals declined in the great temples, a wide range of power was frequently still ascribed to them. In many cases the penalty of killing one of these animals, even unintentionally, was death. Such an occurrence demanded an atonement, in order to protect the country from the vengeance of the slain animal and the ruler of its species—a vengeance which not even the greater deities would otherwise be able to avert.²

The existence of monotheism in ancient Egypt has been inferred, finally, from certain expressions in the so-called 'moral papyri.'³ In these we read that certain acts are desired, or rewarded, or punished, by 'god' (*netjer*), no particular deity being mentioned by name. In point of fact, however, the reference in such expressions is not to a mysterious, all-ruling God, in whom, as contrasted with the other deities of the country, the authors of the papyri believed. Any such inference would run counter to the established fact that these texts were designed for the general mass of a polytheistic people. In the passages in question the writer simply left the persons using the texts to supply the name of their particular nome- or family-deity. In certain cases he may himself have been in doubt as to which deity would be concerned with a particular act. Thus the use of the term 'god' in

¹ For both groups (already noted by Strabo, xvii. 802), cf. Wiedemann, *Muséon*, viii. [1889] 211 ff., 309 ff., and also his *Der Tierkult d. alten Ägypter*, Leipzig, 1912, p. 22 ff.

² Wiedemann, *Muséon*, new ser., vi. [1905] 113 ff., *ARW* xiv. [1911] 640 f.

³ Most recently Budge, *Osiris*, I. [London, 1911] 348 ff.; similarly Renouf, *Lectures*, p. 100 ff.

these passages may be traced to the same vein of thought as finds expression in the celebrated dedication *ἀγνώστῳ θεῷ*, found by St. Paul in Athens (Ac 17²²), or the *sei deo sei deivæ sacrum* upon the altar re-erected c. 100 B.C. at the foot of the Palatine in Rome.

The foregoing considerations warrant the inference that monotheism had no place among the Egyptians, but that they had a leaning towards henotheistic conceptions, which, though they were never consistently applied, yet readily combined with syncretistic tendencies.

3. Systems of deities.—With a view to introducing some kind of order among the vast multitude of deities, the Egyptians attempted from a very early period to arrange them in groups. One such group after another was believed to have reigned as Pharaohs;¹ or, again, a particular deity was regarded as the king, or as the father and lord, of others, as in the enneads of Heliopolis.² In other instances we find certain smaller groups, as the ogdoad of Hermopolis;³ sometimes also in the form of triads, which might appear as families (father, mother, and son, in Thebes), usually very loosely connected, or in even less coherent unions (god and two goddesses, in Elephantinê) which never developed into trinities. Alongside of these we also find larger families (the Osiris cycle), and various other arrangements. But none of these systems comprised more than a relatively small number of deities, or had in general more than a local vogue. Moreover, the deities of a certain cycle in one locality might belong to an entirely different group in another. There was no single system embracing a majority of the pantheon, and, consequently, the functions of the individual deities were not everywhere defined in the same way. All the divine attributes might for the time be concentrated in a single deity, and, if occasionally some special function is ascribed pre-eminently to a certain deity, such as making war to Month, creation to Ptah, sovereignty among the gods to Râ, and procreation to the goat-deities, this arose from fortuitous and, for the most part, spasmodically operative causes, which were nowhere permanently recognized.

4. The anthropomorphic character of the deities.—The gods, while they might assume the external form of men, animals, plants, or even the products of human art, were always represented as having the feelings and needs of men. They required sustenance; and food and drink were accordingly offered to them in sacrifice. Even the obelisks, the embodiments of the sun-god, received oblations of loaves and beer.⁴ In the daily worship, moreover, articles of clothing, ornaments, fumigations of incense as a protection against evil spirits, and the like, were consecrated to the deity in a fixed order of sequence.⁵ Attention was paid also to the housing of deities in temples and chapels, and to making these acceptable to them by such accessories as groves, lakes, ships, attendants, slaves, etc.

In all this the relation between the deity and man rested upon the idea of reciprocity. The worshipper attended to the needs of the god, and the god was expected to requite the worshipper with divine gifts—life, prosperity, health, happiness, victory. In the temple-reliefs we see king and deity facing each other as parties to a con-

¹ Turin Royal Papyrus: Manetho; cf. Maspero, 'Sur les Dynasties divines de l'ancienne Égypte,' in *Études de mythol.* ii. [1893] 279 ff. Chassinat, 'Les Névées de Manéthon,' in *RT* xix. [1897] 23 ff.

² Maspero, *op. cit.* ii. 337 ff.

³ Capart, *RT* xxxiii. [1911] 64 ff.

⁴ Lepsius, *Denkmäler aus Ägypten u. Äthiopien*, Berlin, 1849–58, iii. 306, l. 16.

⁵ Moret, *Le Rituel du culte divin journalier en Égypte*, Paris, 1902.

tract, and promising or actually bestowing their mutual gifts. In the inscriptions commemorating the dead the survivors are said to have given the 'royal offerings' to the gods of death. The gods, however, do not receive such gifts for their own use; they are under obligation to supply the divine personality (*ka*) of the deceased with food and drink. Should a man, and especially a king, fail in his duty towards the gods, the latter do not further befriend him, and may bring calamity upon the whole country;¹ while, if the deity does not perform his part, the man does not need to trouble any more about him, and, by way of punishing and injuring him, ceases to offer sacrifice.² The deity made known his wish and will, first of all, by sending adversity to his enemies and prosperity to his votaries. He also revealed his mind in the behaviour of certain animals—whether they turned towards the man or away from him, whether or not they took food from his hand, bellowed, entered certain chambers, and the like.³ The theophanies of Amon, and the movements of his head, mention of which is frequently made,⁴ are probably to be referred to the action of a sacred animal, rather than to the mechanically devised movements of a statue (cf. art. DIVINATION [Egyp.]). The theory of mechanism would really imply that the priests deceived one another intentionally, and this is not at all likely to have been the case in the most flourishing period of the Amon cult. Finally, the gods intimated their will by words and acts in dreams,⁵ and in various other ways. Even at a much later date we find Apuleius (*Metam.* x.) stating that Isis appears and gives counsel in dreams.

Besides hunger and thirst, however, the Egyptian deities were supposed also to experience joy, pain, and fear, and to be liable to sickness, senile decay, and death. Such ideas, it is true, find expression more particularly in legends,⁶ which were never reduced to a homogeneous system. An excellent instance is found in the contradictory traditions regarding the introduction of Tefnut into Egypt.⁷ The Egyptian sagas of the gods were not regarded as mere inventions or fabulous tales; on the contrary, they form an essential element in the religion. Some are found recorded in temples (*e.g.*, the story of the winged sun-disk of Edfu), or on the walls of tombs (*e.g.*, the narrative regarding the destruction of the human race). Numerous examples are preserved in magic texts, the underlying idea being that a relation of occurrences from the lives of the gods would make an impression on the gods themselves—and hence the narrator must have believed that the stories contained religious truth. They are, accordingly, not mere poetic transfigurations, like the Greek myths in Herodotus (cf. Wiedemann, *Herodots Zweites*

¹ Cf. *e.g.* a stele of Tut-Anch-Amen, in *RT* xxix. [1907] 162 ff.

² Wiedemann, 'Observations sur quelques stèles funéraires égyptiennes,' in *Muséon*, x. [1891] 42 ff.

³ Favorinus, frag. 16; Plin. *H.N.* viii. 185; Solinus, cap. 32; Ammian. Marc. xxii. 14. 8; Dio Cass. li. 17; cf. Wiedemann, *Muséon*, viii. [1889] 218 f.

⁴ Cf. Naville, *Inscription historique de Pinodjem III.*, Paris, 1883.

⁵ Sphinx-Stele of Thutmosis III. (Lepsius, *Denkmäler*, iii. 63; tr. Brugsch, *ZA* xiv. [1876] 89 ff., and Maspero, in *Cat. du Caire: Tomb of Thoutmosis IV.* [Westminster, 1904] p. xvi ff.); Bentrescht-Stele (Lit. in Maspero, *Contes populaires de l'Égypte ancienne*, Paris, 1911, p. 182 ff.); Dream-stele of Nut-Anien (publ. Mariette, *Mon. div.*, Paris, 1872–81, pls. 7 and 8, and Schäfer, *Urkunden der älteren Äthiopienkönige*, Leipzig, 1906, p. 57 ff., tr. Maspero, *Études de mythol.*, iii. [1898] 217 ff.) Setna-legend (cf. Maspero in *Mélanges Nicole*, Geneva, 1906, p. 349 ff., *Contes pop.*, p. 156).

⁶ Collected in Budge, *Legends of the Gods (Egyptian Literature, I.)*, London, 1912; cf. the same writer, *Gods of the Egyptians*, l. 372 ff.; Wiedemann, *Religion of the Ancient Egyptians*, p. 52 ff. and Naville, *La Religion des anciens Égyptiens*, p. 177 f.

⁷ H. Junker, 'Der Auszug der Hathor-Tefnut aus Nubien,' in *BAW*, 1911. Supplement.

Buch, Leipzig, 1890, p. 238 ff.), but really represent the official priestly conceptions of deity.

The fullest list of human attributes is met with in the case of the sun-god Rā. The centre of Rā's cult was Heliopolis, but the kings of the Vth dynasty had erected great sanctuaries to him in the neighbourhood of Memphis.¹ Thenceforward the Pharaohs regularly designated themselves as sons of Rā, who, assuming the personal form of the reigning monarch, begot his successor, as is depicted by Queen Hātšepsut in Deir el-Bahri, and Amenophis III. in Luxor.² Rā is accounted the king of gods and men; he is decrepit with age; his spittle drips from his mouth; his limbs have become silver, gold, and lapis lazuli; he prevails over mutinous deities only by the aid of the sun-god Horus of Edfu. Incensed at the refractory race of man, he issues to the goddess Sechet an order for its annihilation, but presently repents, and can thereafter deal with the destroying goddess only by wiles. He suffers agonies as the result of a snake-bite, and is cured by Isis. Nor are things any better in the case of other gods. Thus the sun-god Horus receives an injury in his eye.³ Osiris is slain and cut in pieces by his hostile brother Set. His son Horus suffers from headache and internal pains;⁴ he is stung by a scorpion,⁵ and, especially in his youth, has other afflictions to endure. The goddess Sechet becomes intoxicated with a mixture of beer and blood (legend of the annihilation of mankind); and there are many other incidents of similar character. Popular tales,⁶ in representing the gods as altogether human, were really quite in the spirit of the temple-religion. According to these stories, the gods move about the world as a band of musicians (*Papyrus Westcar*); Rā-Harmachis comes with the company of the gods to earth, and presents his favourites with gifts which afterwards work injury to their recipients (*Papyrus d'Orbiney*).

When any of the gods fell ill, they had to apply to others for help, as was done, e.g., by Horus and Set in Heliopolis (*Pap. Ebers*, ii. 3-6). Like human beings, they found their chief source of succour in Isis, who composed the healing spells. Nor was it any Divine power that operated in such cases; the healing was effected solely in virtue of the magic. The superiority of magic to the principle of divinity was a primordial element in the religion of Egypt, and was permanently retained.⁷ The oldest surviving religious texts of any extent—the inscriptions on the royal pyramids of the Vth and VIth dynasties⁸—are collections of magic formulæ designed to compel the gods to secure for the deceased a life of bliss in the world beyond. The so-called Books of the Dead, dating from the Middle⁹ and the New Kingdom,¹⁰ and the numerous

¹ Von Bissing, *Das Re-Heiligtum des Königs Ne-Woser-Re*, Berlin, 1906, I.; Borchardt, *Der Bau*, Berlin, 1906.

² Wiedemann, in *Muséon*, xiii. [1894] 372 f.; Moret, *Du Caractère relig. de la royauté pharaonique*, Paris, 1902, p. 48 ff. The Alexander-legend (his being the son of Amon) emanates from the same sphere of thought: cf. Maspero, *Études de mythol.* vi. [1912] 263 ff.

³ *Book of the Dead*, ch. 111; Naville, *Études dédiées à Leemans*, Leyden, 1885, p. 75 ff.

⁴ *Magie Papyrus Leiden*, ed. Pleyte, *Études sur un rouleau magique du Musée de Leyde (Études égyptol., Leyden, 1866)*.

⁵ Metternich-Stein, publ. by Golenischeff, Leipzig, 1877, tr. Brugsch, *Ägypt. Ztschr.* xvii. [1879] 1 ff.

⁶ Tr. Maspero, *Contes pop.*; Flinders Petrie, *Egyptian Tales*, London, 1895; Wiedemann, *Allägypt. Sagen u. Märchen*, Leipzig, 1906.

⁷ Wiedemann, *Magie u. Zauberei im alten Ägypten*, Leipzig, 1906; Moret, *La Magie dans l'Égypte ancienne*, Paris, 1907.

⁸ Publ. and tr. Maspero, *Les Inscriptions des Pyramides de Saqqarah*, Paris, 1894 (from *RTr* iii. [1882]-xv. [1893]; new ed. by Sethe, *Die altägypt. Pyramidentexte*, Leipzig, 1908 ff. [without the translation]).

⁹ E.g., Lepsius, *Alteste Texte des Tottenbuchs*, Berlin, 1867; Lacau in *RTr* xxvi. [1904] ff.; Quibell, *Excavations at Saqqara, 1906-1907*, Cairo, 1908, p. 21 ff., and *Cat. du Caire: Sarcophages, antérieurs au Nouvel Empire*, Cairo, 1904-06.

¹⁰ For the older stratum, Naville, *Das ägypt. Tottenbuch der*

texts of a kindred type, have the same end in view as the so-called magic papyri. In the healing of diseases believed to be due to demons the right magic formulæ were the essential thing. These formulæ were annexed to the collections of medical recipes,¹ but they could be quite effectively used by themselves.² Hence the *cher-heb*, who knew the spells by heart, or recited them from a book, became a person of outstanding importance in Egypt, and it was essential for each Egyptian, more especially in view of his life after death, to be a *mad-cher*,³ i.e. one who could recite the proper formulæ in the proper way. The doctrine of amulets rests on a similar belief.⁴ The possession of certain objects enabled a man to compel the gods to protect him, or prevented evil spirits from injuring him in any way. Malevolent deities were helpless against the virtues of apotropaic symbols, such as the winged solar disk, the bull's head, the Bes-mask, the Ut'a-eye, etc. The idea that the gods could resist the correct employment of magic was never entertained. If the magician sometimes claimed to be a god demanding obedience, it was always for the purpose of enhancing his magic powers, never of providing a basis for them. Nor was this equality with deity imparted to him by the will of the higher beings; he had it in virtue of his own magical gifts, to which the gods themselves were subject.

5. Deities influenced by entreaties.—Reference must be made, finally, to a series of Theban inscriptions dating from c. 1200 B.C.,⁵ the contents of which seem at the first glance to form an exception to the above. These inscriptions make appeal, with praise or thanksgiving, mainly to minor, and, in particular, to specialized, deities, as, e.g., to Amon-Rā the hearer of supplication, Hor-ur the hearer of supplication, Mer-seker, the mountain-dome of the West, the Moon, the mistress of the West, Amenophis I., and the god who hears supplications. In these inscriptions we also find—though more rarely—the greater deities, e.g. the Sun, Khunsu, and Ptah, as independent figures. Here there is no reference to the power of magic; the desired boon comes simply by the favour which the gods manifest in response to urgent entreaty. Essentially similar ideas lie at the root of what we find in the stelæ from Memphis bearing the figures of the ear in large numbers, and sometimes speaking of Ptah as the hearer of petitions.⁶ A list of the deities who thus manifest themselves as hearers of petitions has been drawn up by Spiegelberg.⁷ The idea of ascribing to a deity a large number of ears is also met with elsewhere in Egypt. Thus a certain very powerful deity is alleged to have seventy-seven eyes and the like number of ears;⁸ and in a hymn to the king—regarded as equal to the God—we find the words: 'When thou takest rest in thy palace, thou hearest the words of all lands, for thou art endowed with innumerable XVIII.-XX. *Dynastie*, Berlin, 1886, tr. Renouf and Naville in *Le Page Renouf, Life Work*, iv. (from *PSBA* xiv. [1892]-xxvi. [1904]), and by Budge, *The Book of the Dead*, London, 1898; Naville, *Papyrus funéraires de la xxie Dynastie*, Paris, 1912. For the later stratum see Lepsius, *Das Tottenbuch der Ägypter*, Berlin, 1842; the tr. of Pierret, *Le Livre des Morts*, Paris, 1882 (new print, 1907), is now out of date.

¹ *Pap. Ebers*, ed. Ebers, Leipzig, 1875, and the *Hearst Medical Papyrus* (which is derived from the same source), ed. G. A. Reisner, Leipzig, 1905.

² The Great Medical Papyrus in the Berlin Museum, ed. Wreszinski, Leipzig, 1909.

³ Cf. Maspero, *Études de mythol.* i. [1893] 93 ff.

⁴ Wiedemann, *Die Amulette der alten Ägypter*, Leipzig, 1910.

⁵ Maspero, *Études de mythol.* ii. [1893] 402 ff.; Erman, in *SBAW*, 1911, p. 1086 ff.

⁶ Cf. Maspero, *RTr* ii. [1880] 118 f.; Petrie, *Memphis*, London, 1900, i. 7 f., pls. 9, 11; Valdemar Schmidt, *Choix de monuments égyptiens*, Brussels, 1910, ii. figs. 31, 32.

⁷ *RTr* xxvi. [1904] 56 f., and *ZÄ* xiv. [1908-09] 89 f.

⁸ *Magie Papyrus Harris*, vii. 6. ed. Budge, *Facsimiles of Egyptian Hieratic Papyri*, London, 1910, pl. 26.

ears.¹ The multiplicity of ears was supposed to make the anthropomorphically conceived deity able, in a material sense, to listen simultaneously to the numerous and varied petitions of many individuals.

But the texts in question do not present, as has been surmised, a higher conception of deity. Those who erected the monuments containing them were people of lower rank, and could, therefore, make no pretensions to possess magic powers. In the world they were not of those who dictate or demand, but of those who entreat, and, accordingly, they were not in a position to extort, but could at best only try by submissive humility to win, the favour of the higher powers. Hence, too, they paid homage to the popular deities, and especially to the sacred animals,² as those who would be more likely to be interested in them than the greater and more august gods. The utterances, in a like submissive tone, which sometimes emanate from persons of higher rank³ are to be regarded as mere cajolery, since in other parts of the same texts it is assumed that the deity is subject to the power of human magic and dependent upon human goodwill.

Conclusion.—The conception of deity among the ancient Egyptians thus never got beyond the primitive stage, and there is no evidence to show that it attained to any highly developed or refined form. Whenever such more exalted conception seems about to emerge, as in certain utterances in the hymns to the gods, it is at once repressed by the ascendancy of magical doctrines, and by the all-dominating idea of the reciprocal relation of deity and humanity which rests upon the assumption of their essential equality. Cf. also art. EGYPTIAN RELIGION.

LITERATURE.—H. Brugsch, *Rel. u. Mythol. der alten Ägypter*, Leipzig, 1884-88; Le Page Renouf, *Lectures on the Origin and Growth of Religion as illustrated by the Religion of Ancient Egypt* (Hibbert Lectures, 1879), London, 1880 (Germ. tr., *Vorlesungen über Ursprung u. Entwickl. d. Rel. d. alten Ägypter*, Leipzig, 1882); A. Wiedemann, *Die Rel. d. alten Ägypter*, Münster, 1890 (Eng. ed., *Religion of the Ancient Egyptians*, London, 1897); G. Maspero, *Études de mythol. et d'archéol.*, 6 vols., Paris, 1893-1912; A. Wiedemann, art. 'Religion of Egypt,' in *HDB* v. 175-97; E. A. Wallis Budge, *The Gods of the Egyptians, or Studies in Egyptian Mythology*, 2 vols., London, 1904; G. Steindorff, 'Rel. u. Kultus im alten Ägypten,' in *Jahrb. des Freien Deutschen Hochstifts zu Frankfurt a. M.*, 1904, pp. 131-79 (enlarged Eng. ed., *The Religion of the Ancient Egyptians*, New York, 1906); E. Naville, *La Rel. des anciens Égyptiens*, Paris, 1906; W. M. Flinders Petrie, *The Religion of Ancient Egypt*, London, 1906; A. Erman, *Die ägypt. Rel.*, Berlin, 1909 (Eng. tr. of 1st ed., *A Handbook of Egyptian Religion*, London, 1907); Ph. Virey, *La Rel. de l'ancienne Égypte*, Paris, 1910. Cf. also Lit. cited in art. EGYPTIAN RELIGION, vol. v. p. 236^b.

A. WIEDEMANN.

GOD (Greek).—The words most nearly corresponding to 'God' in the Greek language are *θεός* and *δαίμων*,—both hitherto of unknown origin,—the former rather conveying the sense of an individual personality, the latter of a spiritual power. Minor differences and changes of meaning will appear in the sequel. The purpose of the present article is to trace the gradual development of the characteristically Hellenic conception of the Divine.

1. We are met at the outset with the prevalence of a multiplicity of gods. One who undertakes to unravel the tangled web of Greek polytheism is described by Plato as 'a laborious, and not very fortunate man' (*Phædr.* 229 D, *ἐπιπρόνου καὶ οὐ πάνυ εὐτυχούς ἀνδρός*). The former epithet remains, and will long remain, most apposite. But recent discoveries in archaeology and the comparative study

¹ *Pap. Anastasi*, ii. 6. 3 ff., iv. 5. 6 ff. With this should be compared the directly opposite mode of thought in Greek speculation (as seen in *Plut. de Isid.* 78), conformably to which a statue of Zeus in Crete had no ears at all—for it is not meet that the Lord of all things should listen to any one.

² Maspero, *Études de mythol.* ii. (1893) 296 ff.

³ Passages in Erman, *SBAW*, 1911, p. 1109 ff.

of religions have removed some part of the obscurity. The earlier communities, whether they lived by hunting, pasture, or some primitive agriculture, could not but feel their dependence on powers over which they had only a limited control. Wild animals, their own flocks and herds, the seasons of the year, rivers, fountains, wind, and rain were all-important to them; vague fears of spirits, hostile or benign, were also inspired by the gloom of the forest and the darkness of the cavern, suggesting to the imagination the existence of subterranean powers into whose keeping the souls that disappeared from earth departed. It is sometimes assumed that primitive worship was wholly inspired by terror, but there must also have been in it the germs of hope and of affection. On this subject the words of Auguste Sabatier are worth considering (*Philosophie de la religion*, Paris, 1897, p. 13):

'En elle même et toute seule, la peur n'est pas religieuse; elle paralyse, elle rend stupide, elle écrase. Pour que la peur devienne religieusement féconde, il faut qu'il s'y mêle, dès l'origine, un sentiment contraire, un élan d'espérance; il faut que l'homme, en proie à la peur, conçoive d'une manière ou d'une autre la possibilité de la surmonter, c'est-à-dire de trouver au-dessus de lui une aide, un secours pour conjurer les dangers qui le menacent.'

The god of the family or tribe, perhaps an ancestor who had passed into the Unseen, was looked up to as the protector of his race from hostile powers, and from those spirits of evil which the primitive imagination was always ready to suspect as dangerously near. Immigrants by land or sea must have found existing aboriginal worships, of which probably that of some earth-goddess and of a heavenly rain-giver were most widely spread. The new-comers applied to powers worshipped by the conquered tribes names already familiar to themselves. The Aryan warriors may have found on certain mountain-heights the worship of a cloud-compelling deity, giver of the rain, whom they identified with their God of the Sky (*Dyaus=Zeus*); just as the word which signified the beech in northern climes was now applied to the oak, or as the Greek in later times recognized the objects of his familiar reverence in the gods of Egypt or of Persia. Thus the power that dwelt in the forest of Dodona now took the name of Zeus, and his female counterpart became Dione, while on Mount Lycæus the wolf-god that ravaged or spared the flock was likewise Zeus in the new nomenclature. Apollo, perhaps a sun-god, was blended with the protector of the herd, while Athene (perhaps a lightning-goddess), Artemis, Hera, Demeter, were names applied, whether by the Aryans or by some earlier immigrants, to female powers previously worshipped in different localities. Aphrodite, Heracles, perhaps Poseidon, owed their existence to Phœnician or other colonists by sea. Already those hospitable shores were sensitive to foreign influences. Ares was a Thracian; Dionysus partly Thracian, partly Cretan. Yet even he, though confessedly a late-comer, must have found in primeval village-festivals a congenial soil.

The Aryans also brought with them their own patriarchal system, involving the organized worship of ancestors, whence each family had its peculiar cult; and, when the family had grown into the tribe, there followed an amalgamation of such cults under one presiding power. Hence came a grouping of divinities differing in each central district, until in certain regions an *amphictyony* (*q.v.*), or federation of neighbouring communities, was loosely combined under the presidency of one chief god—as Apollo at Thermopylæ, Poseidon at Calauria, Zeus at Olympia, Artemis in Ætolia; and, as tribes were gathered into cities, one worship in each place tended to become supreme,

e.g. Zeus at Dodona, Poseidon at Corinth, Hera in Argolis, Athene in the Acropolis of Attica. The attributes of such divinities were modified by the character and history of each city. Athene had different attributes at Athens, Sparta, Thebes, etc., Zeus in Thessaly and Caria, Nemesis at Rhamnus and at Smyrna. Powers once supreme, as the Graces (vegetative powers) at Orchomenos, became subordinated to more prevailing deities. Colonies on the Asiatic seaboard, or elsewhere on the Mediterranean coast, and the several island communities were subject to special conditions. Apollo was the same and not the same at Delphi, in the Troad, and at Branchidæ; Athene at Athens, in the Troad, and on the shores of Africa. The worships thus locally established were further modified in various ways. One potent cause was the love of story-telling which created mythology. When Hellenic worshippers were asked, 'What mean ye by this service?' their ready imagination furnished copious replies. Hence came an almost endless multiplication of divinities; for each attribute of a god or goddess tended to become a separate personality. Thus to Artemis were added Callisto, Iphigenia, Dictynna, etc.; to Aphrodite, Peitho, Harmonia, Helen, Ariadne; to Athene, Aglauros and her sisters; to Hera, Eilithyia—and so forth. Such conceptions were further developed in literature and art.

2. *The Homeric poems* show this development already at an advanced stage. They present us with a special grouping of the chief divinities, embodying possibly the acme of Achæan culture. Zeus is above all, but his nominal omnipotence is limited in reality. And the so-called trinity of Zeus, Athene, and Apollo is the usual sanction for an oath. By this time the power of divination, once vaguely attributed to an earth-goddess or some deified ancestor, and still imagined to be accessible at many local shrines, was concentrated first at Dodona, and afterwards at Delphi, where the priesthood had secured a predominating and widespread influence.

Beneath the many-coloured veil of mythology there is evidence of the unconscious working of the human mind, endeavouring to form a general notion of that which is higher and mightier than man. All manner of mortal weaknesses are attributed to individual gods; yet there are grave moments in which essential deity is not unworthily conceived, and in times of exceptional emotion not an individual god is present to the mind, but the gods collectively. This becomes more frequent in the *Odyssey*, where the gods, both as *theoi* and as *δαίμονες*, are more often spoken of without particular mention of Zeus. What, then, are the general attributes of the Homeric gods? (1) They are immortal. This privilege is shared by some who are not dwellers on Olympus. (2) They live at ease (*βῆτα ζώοντες*), exempt from pain and sorrow. (3) They feed not on the produce of the ground, but on ambrosia and nectar. (4) They are in their nature invisible, but have the power of appearing to men in various disguises (sometimes as birds). (5) They are the givers of all good, but (6) they are ever ready to punish the breach of an oath, the oppression of the stranger, and other acts of wrong. The mortal who contends with them is doomed to perdition. They visit cities in the guise of strangers, to observe the just and unjust deeds of men.

3. *The poetry of Hesiod* reflects a parallel and partly independent growth of the religious consciousness. The Muses of Mount Helicon are imagined as revealing to their devotee the realities of the superhuman world. A crude form of reflexion comes in aid of poetic fancy, and is associated with a strong though simple ethical conviction.

Such abstract notions as justice, mercy or reverence, persuasion, rumour, contention, are personified. Fanciful affinities lead to genealogical description and narrative. The distinction emerges between divine and semi-divine (*θεοί, δαίμονες, ἥρωες*), nor is it always possible to discriminate between the cases in which an heroic ancestor is deified and those in which some power originally worshipped as divine or some attribute of a worshipped deity comes to be regarded as a demi-god.

4. *The development of art*, always in association with religion, is later than that of epic poetry, and it reaches an expression of more advanced conceptions. There are distinct traces indeed of an aniconic stage, in which the Divine presence was realized through some striking natural form or some rude symbol—a tree, a cave, a boulder, a cone, a pillar. Then came the *xoanon*, a block of wood or stone rudely carved in human form either partially or completely. The Trojan Athene in *Il. vi.* was probably of this nature. Such idols retained a special sanctity in historic times notwithstanding the advance in artistic skill. Athene Polias of the Erechtheum still claimed the offering of the embroidered robe in preference to the Parthenos, the Promachus, or the Lemnian statue. Until about the 6th cent. B.C. little was attempted in the way of denoting attributes through form and feature. Symbolic treatment came before expression. Hermes was known by his *caduceus*, Artemis by her bow, etc. But the pious artist, in meditating on the special worship which he sought to adorn, began by and by not merely to mould in bronze or marble with wonderful perception the human form, but to breathe into his creations 'the attributes to awe and majesty,' which worshippers hitherto had but vaguely imagined. Even in work of the 4th cent. B.C., the art critic has no difficulty in discerning, from feature and expression apart from symbols (such as the *ægis*, *calathus*, *polos*, etc.), whether the person represented by a statue is human or Divine. This implies a remarkable elevation of religious feeling. It shows that, amongst all the vagaries of polytheism, there was a growing sense of something 'far more deeply interfused,' a power exalted infinitely above humanity, yet interpenetrating human life in all its aspects. It proves that the conception of divinity, while recognizing a great variety of manifestation, was becoming generalized and unified. The Pheidian Zeus at Olympia, a work of the 5th cent. B.C., was felt by those who saw it, even in the latest period of paganism, to be a complete embodiment of the Divine ideal.

5. Epic poetry had an undoubted effect in moulding subsequent modes of literature and art. But side by side with Homer it is important to recognize independent and parallel orders of religious consciousness. Ceremonials once established remained for ages, as every page of Pausanias shows, little affected by the progress of religious thought. Some popular worships, on the other hand, such as those of Demeter and Dionysus, became the nucleus for the growth of a new body of mythology. Such movements were encouraged by influences from Egypt and the East that shot across the national worships and gave rise to a strange blending of religious ideas. In this connexion it may be well to quote the following passage from W. M. Ramsay's *Cities and Bishoprics of Phrygia* (vol. i. [Oxford, 1895] p. 87) on 'Anatolian Religion':

'Its essence lies in the adoration of the life of Nature—that life subject apparently to death, yet never dying but reproducing itself in new forms, different and yet the same. This perpetual self-identity under varying forms, this annihilation of death through the power of self-reproduction, was the object of an enthusiastic worship, characterized by remarkable self-abandonment and immersion in the divine, by a mixture of obscene symbolism and sublime truths, by negation of the moral distinctions and family ties that exist in a more developed

society, but do not exist in the free life of Nature. The mystery of self-reproduction, of eternal unity amid temporary diversity, is the key to explain all the repulsive legends and ceremonies that cluster round that worship, and all the manifold manifestations or diverse embodiments of the ultimate single divine life that are carved on the rocks of Asia Minor.'

That religion had some elements essentially alien to the Greek spirit, which, however, like all strange things, possessed a powerful fascination for individual minds. Obtaining a footing at seaports, these cults found their way into the cities, bringing with them some impurities for which the earlier Greek cults were not responsible, but also diffusing a spirit of mystical devotion which in the Orphic and Pythagorean schools was associated with ascetic strictness of conduct.

6. Excesses, however, whether of impurity or asceticism, found little response until the decline of Hellenism, except on the outer fringe of Hellas. Corybantic wildness remained a peculiarity of semi-barbarous lands. The *Atys* of Catullus has nothing corresponding to it in classical Greek. Laments for Adonis were confined to women. Dionysiac exuberance, in Athens at least, had been tamed and regulated through the institution of the drama. To some such influx of foreign ideas, in which Egyptian, Oriental, and Thracian ingredients mingled, may be traced the origin of Orphism. A crude theosophy had already appeared in Hesiod. The tendency to Pantheism and blending of divinities (theocracy) had shown itself here and there, and in the worship of Dionysus the notion of a god who suffers, dies, and lives again was already present in germ. There was a tomb of Dionysus at Delphi, as probably in Crete. The founders of the Orphic mysteries wove these several threads together in a new mythology. Dionysus Zagreus, torn in pieces by the Titans, lives again as Phanes (see article ORPHISM). This was, after all, one phase in the general process by which the Greek mind was brought through generalization and inference towards the conception of a divine unity.

7. *Philosophy* in its earliest form stood aloof from common life, and involved a reaction from ordinary belief and custom. Xenophanes despised anthropomorphism, and Heraclitus could not tolerate the absurdities of piacular sacrifice. Yet each great speculative effort was in effect a 'seeking after God.' The Heraclitean law of Change, the Perfect Sphere of Parmenides, the Thought of Anaxagoras, Pythagorean Number, were modes of expression for a new vision of the Supreme Being. Meanwhile, apart from philosophy, and from Orphic innovation, there were significant changes both in popular worship and in literary expression. The grouping of divine powers was symbolized by a common altar-place (*κοινοβώμιον*), either for the eight or for the twelve greatest gods, at Athens and in Argolis; and the generalizing tendency already noticed becomes more distinct. In Herodotus, for example (i. 32, vii. 46, viii. 13, 60), the idea of God which is present to the historian is at once impersonal and personal. All exceptionally striking events and extraordinary phenomena are accounted for by a supernatural providence above and beyond the action of individual gods (see especially the curious bit of teleology in Herod. iii. 108). The stage of reflexion which appears in his histories probably dates from an earlier time than that of their publication, representing a spirit which may be described as Ionian pessimism. The old suspicion of Divine malignity was confirmed by the sad uncertainty of life amongst those who lived beneath the ever-threatening shadow of Persia (*ὅτι επικίνδυνός ἐστι αἰεὶ κορε ἡ Ἰωνία*, Herod. vi. 86).

The idea of Fate (*q.v.*) as distinct from Divine volition at the same time acquires increasing prominence

(*ἔδει, τὸ χροῖον*, Herod. *passim*). The hope of immortality, which in Homer had grown dim, was revived in the Eleusinian worship, and found poetical expression in Pindar. This poet has sublime conceptions of the Divine nature as exalted, irresistible, swift, etc., and he refuses to accept fables that seem to him degrading to the gods. But his ethical standard, that of the Hellenic aristocracy of birth, though noble in many ways, has not the human breadth and depth of the great tragic poets.

8. *Æschylus* absorbed and carried further the theosophic speculations which were prevalent in the early 5th cent. B.C. For him they centred in meditation upon human things. The idea of Divine righteousness striking a harmony amidst a clash and confusion of events and bringing into order the moral chaos of the primitive world is the dominant note in him. He reserves the word 'God' (*θεός*) principally for the supramundane powers, and sometimes makes express opposition between the gods and the subterranean deities (see EUMENIDES). The mythopœic faculty is still strong in him. But his mythology is not fixed into a system. It is an elastic medium for the expression of his thoughts. Apollo is the prophet of Zeus; Athene represents the glory, the freedom, and wise equity of Athens. In speculating on the Divine attributes he came to see clearly the necessity of combining power with beneficence and wisdom (*Prometheus Vincetus*).

9. In *Sophocles* the idea of justice is identified with the righteous but inscrutable will of Zeus, and destiny becomes the symbol of the mysterious, unaccountable element in human life,

'The burden and the mystery
Of all this unintelligible world';

δαίμων is used of any superhuman power directly acting on the life of man.

The 'eternal laws' (probably an Eleusinian notion—see Lysias, *adv. Andocid.* p. 104) may not be broken with impunity either consciously or unconsciously, but the noble spirit, though overclouded for a time, is ultimately justified. Some notes of sadness here and there, chiefly in late plays, prepare us for the scepticism and newer pessimism which find frequent utterance in Euripides. This belongs to the period of the *Sophists* (*q.v.*), in which earlier beliefs and positive speculations gave way before obstinate questionings about the meaning of experience. Another aspect of the same time of transition is perceptible beneath the silence of Thucydides, who limits his vision to the facts of life—what has been and will be again while human nature remains. Sophocles, Euripides, and Thucydides had lived through the experiences of the Peloponnesian war.

10. It is observable that in the later tragedies the word for 'God' (*θεός*) is used with increasing laxity—for instance, for Niobe in Soph. *El.* 150—and is predicated for mere abstractions, such as Time (*χρόνος γὰρ εὐμαρῆς θεός*, Soph. *El.* 179), Thought (*ἡ φρόνησις ἀγαθὴ θεός μέγας*, Soph. frag. 837), Caution (*τῆ δ' εὐλαβείᾳ, χρησιμωτάτῃ θεῶν*, Eur. *Phœn.* 782), Wealth (*μὴ πλοῦτον εἶπη· οὐχὶ θαυμάζω θεόν | ὅν χῶ κάκιστος ῥαδίως ἐκτήσατο*, Eur. frag. 20; cf. Aristoph. *Plutus*), Shamefastness (*αἰδώς μ' ἔχει:—ὅ τάρᾳ πράξεις οὐδέν' ἀργός ἡ θεός*, Eur. *Ion*, 336, 337), Poverty (*οὐκ ἔστι πένιαν ἰερὸν ἐχθίστην θεοῦ*, Eur. frag. 250), and even Recognition (*θεός γὰρ καὶ τὸ γινώσκειν φίλους*, Eur. *Hel.* 560). Hesiod had anticipated this mode of speaking in saying of Rumour (*φήμη*): 'She also is a god' (*θεός νύ τις ἐστὶ καὶ αὐτή*, *Op. et Dies*, 762). How conventional Athenian religion had become, although as custom it had still a powerful hold, appears from the light treatment of Dionysus and other deities by Aristophanes.

11. With the career of *Socrates* (q.v.) a new era of reflexion, at once religious and ethical, begins. Plato is probably justified in representing him as accounting for his self-devoted pursuit of truth by the command and inspiration of Apollo, and the Divine intimation (τὸ δαιμόνιον) which checked him when on the point of undertaking some new enterprise was likewise regarded by him as supernatural. While conforming to the religion of his countrymen, he rejected fables which attributed immoral actions to the gods. The simple teleology which we have already noted in Herodotus was carried by him somewhat further in recognizing the adaptation of organ to function in the human frame, and he warned his hearers against praying for blessings which the gods had placed within human power.

12. In *Plato* it is necessary to distinguish between his allusions to popular conceptions and his own original thoughts. In one place the ordinary notion of God is spoken of as the figment of a 'non-natural man' (*Phædr.* 246 C). In another the gods who exist through custom and convention are contrasted with the heavenly bodies to whom he attributes real divinity (*Tim.* 41 A). But, when he speaks most seriously, he expresses theological principles which are of permanent value. God is the author of all good, but never of evil. If He chastises men, it is that He may make them better. He cannot lie or deceive. God is the measure of truth, not man, as Protagoras had said. The world is ordered not by chance, but according to the mind of God. God is free from envy (here Plato contradicts his predecessors), and He would have His creature to be as like Himself as possible. In these and other passages God is imagined as a living personality. Elsewhere the place of God is taken by the impersonal idea of good. That is the Atlas on which the universe rests, and which 'preserves the stars from wrong.' It is this which gives validity to the highest principles of truth and being, and without which the fabric of the universe would collapse. Plato speaks with some reserve on theological questions, and in his *Laws* the most sacred rites are to be performed in the temple of the Sun. Yet above and beyond all such rules of worship, there are unmistakable indications of a true monotheism. God is virtually identical with the good mind or soul, which in the end prevails over the evil or imperfect soul. That is the prime cause of motion and becoming—itsself eternal, unchanging, and unmoved. The unity of the supreme will is expressly recognized in the *Statesman*. Lastly, God is not to be cajoled by rites of atonement, or by prayer and sacrifice; and only a less dangerous error is to suppose that He takes no interest in human things.

13. In the system of *Aristotle*, the spheres of theology, ethics, and politics, though not unrelated, are distinct. The life of action and of moral choice is human; the life of contemplation is alone divine. God causes motion, but is Himself unmoved. His unceasing, uninterrupted energy is the thought of thought (νόησις νοησῶν). This metaphysical notion, seemingly cold and unimpassioned, is yet informed with a strain of philosophical enthusiasm which occasionally breaks forth (*Eth. Nic.* x., cf. *Met.* xi.), and it has had an influence on Christian theology (both Scholastic and Reformed) more persistently effective than Platonism as later understood. Even in Aristotle the perfection of the Divine nature as immanent in the universe is not wholly abstracted from the symbolism of the circle and the sphere. But these shadows of Pythagoreanism are not essential to the philosopher's thought. God, the prime mover, Himself unmoved, is at once the first and the final

cause of all things. All Nature, from the lowest to the highest, is potentially Divine. From God it has received the seeds of being, and yearns to realize itself in higher forms. Hence the final cause is also at once the efficient and the formal cause. Particular ends, such as beauty, goodness, wisdom, truth, are all subordinate to the supreme energy which is the realization of the thought of God. At this point Greek religion has travelled far away from 'the gods of custom and convention,' and may be said to have reached its apogee.

14. *Epicurus*, following the Cyrenaic school in ethics, and Democritus in physics, and adopting one of the heresies denounced by Plato, taught that the gods, living happily in eternal calm, cannot be supposed to interest themselves in the affairs of men. The *Stoic*, on the other hand, while adopting Heraclitean cosmology, deified the moral ideal, and looked for God within the human mind and will.

15. By the end of the 1st cent. A.D. it had become impossible for persons at once religious and thoughtful to accept the old mythologies in a literal sense. Meanwhile other worships, especially those of Egypt and Persia, had met and mingled with the Greek and found wide acceptance in the Roman world. The blending of divinities (*θεοκρασία*, 'syncretism') had gone far. In this welter of superstitions, those who clung affectionately to ancient ritual and tradition had recourse to allegory and symbolism. Plutarch's treatise concerning *Isis and Osiris*, addressed to a pious and intelligent lady, is very instructive in this regard. He is strongly imbued with Platonism, and quotes largely from the *Timæus* and *Laws*. His own thoughts point clearly to monotheism. Yet he assumes that the religion of Egypt, however it is to be interpreted, is authoritative and lasting. He cannot imagine that it will ever be supplanted or done away. His explanation of the worship of the crocodile may serve as an example of his method: 'This animal's eyes are so arranged that he can see while himself unseen, a power which is justly attributable to the Supreme Being.' By accepting Plato's distinction between gods and demons (*θεοί* and *δαίμονες*), Plutarch is enabled to effect a superficial reconciliation between monotheism and polytheism. The same antithesis was adopted and emphasized by the Christian Fathers, when they followed St. Paul in saying that the heathen prayed and sacrificed to demons and not to God (1 Co 10²⁰).

See also GREEK RELIGION.

LITERATURE.—F. G. Welcker, *Griechische Götterlehre*, Göttingen, 1858-60; L. F. A. Maury, *Hist. des religions de la Grèce antique*, Paris, 1857-59; C. O. Müller, *Scientific System of Mythology* (tr. Leitch, 1844); E. Maass, *Orpheus*, Munich, 1895; L. R. Farnell, *Cults of the Greek States*, Oxford, 1896-1909; E. Caird, *Evolution of Theology in the Greek Philosophers*, London, 1896; F. B. Jevons, *Introduction to the History of Religion*, Glasgow, 1904; L. Campbell, *Religion in Greek Literature*, London, 1898; Theodor Gomperz, *Greek Thinkers*, do. 1901 (tr. of *Griechische Denker*); L. Dyer, *Studies of the Gods in Greece*, London, 1891; E. Reisch, *Entstehung und Wandel griechischer Göttergestalten*, Vienna, 1909; F. M. Cornford, *From Religion to Philosophy*, Cambridge, 1912, i.; G. Murray, *Four Stages of Greek Religion*, New York, 1912, including Sallustius, 'On the Gods and the World.' LEWIS CAMPBELL.

GOD (Hindu).—At the foundation of all the religious life and thought of India lie her sacred books. The literary element, inspired and controlled by a dominant class and largely accommodated to their own ends, has exercised an influence the breadth and comprehensive nature of which finds few if any parallels outside of Christianity. Among no other peoples is the appeal to what is traditional more absolute and decisive; and tradition appeals in turn to the written word. If it may be said that custom in the East regulates and fetters social relationships to a degree unknown among Western nations, Indian life, on the other

hand, in its religious aspect is, broadly speaking, no less determined by the teaching of the Indian Scriptures. Every leader of thought, every reformer of doctrine, takes his stand upon these, and claims to be their true interpreter. Any survey, therefore, of the forms and developments of religious thought naturally and necessarily begins here; and an inquiry into the nature of the conception or conceptions which the Indian peoples have formed of the Divine must take account in the first instance of the evidence and teaching of the authoritative books.

1. The Vedas.—The earliest illustrations of primitive doctrine and belief as they existed in north-west India are found in the Rig-Veda; and the chronological uncertainties of this literature hardly detract from its supreme importance as a witness to the origin and development of 'theology' in the narrower sense of the word, the doctrine of God, as formulated and held by the Indian peoples. The *succession* of the literary strata, generally speaking, is not doubtful; and it is upon this that the history of doctrine rests. Behind it lies the Indo-Iranian period, whose ideas with regard to the unseen form matter of more or less well-founded conjecture, but hardly as yet of secure inference. That these early hymns reflect the higher and serious beliefs of the people is not doubtful—as on another plane of thought the Atharva-Veda reflects the superstitions, the craving for unnatural or supernatural power, the cunning and greed of primitive man on his guard against demoniacal influences, seeking to overreach his fellow-man, and fearful lest his fellow-man should overreach him. Of both tendencies account must be taken in any attempt to trace the genesis and history of theistic belief. As a whole the Rig-Veda is the older collection, and has been most influential upon later thought. The Atharva-Veda, however, contains elements of very great, probably of not less antiquity.

It has often been pointed out that the conceptions upon which these ancient hymns are based are those of a primitive Nature-worship—a Nature-worship, moreover, which is sufficiently frank and inartificial to enable us to watch the process of personification, and to trace its development from the scarcely-disguised natural phenomenon, where the god is hardly differentiated from the physical appearance, to the idealized and abstract personality, clothed with moral attributes, and endowed with a character wholly divine. To the former belong *Dyaus*, the broad bright sky, perhaps the only one of the great gods of the Veda who carries us back to pre-Vedic times; the *Maruts*, the deities of the storm; *Indra*, the god of the rain-cloud, who became the mighty warrior and champion of heaven; *Agni*, the god of fire, as regards some of his attributes and functions; and others, all of whom are in process of becoming detached from those phenomena of Nature which they represent, and obtaining an individual and abstract existence. The rich personification of the Veda extends over the whole realm of inanimate Nature. The heavens, the earth, the waters, the air are all laid under contribution; and there is a constant tendency to assimilation and interchange of attributes, so that not only are the same qualities ascribed to different deities, but the same actions are performed, and they thus tend to become indistinguishable in character from one another. The *sameness* of many of the Vedic divinities is no less noticeable than their derivation from the physical universe.

Abstract personifications are more characteristic of the later hymns, though they are not confined to these. *Aditi*, the immensity; *Prajapati*, the lord of creatures; *Hiranya-garbha*, the golden germ, are illustrations of a tendency, which seems

to have become more marked with the progress of time, towards a mystical, contemplative attitude of mind, which sought to dissociate the objects of its worship from the visible and tangible, and to assign to them a position of greater independence and exaltation. Hence especially the gods originally mortal become immortal, and cease to be moved by passions like men. They wrap themselves up in distance and mystery; and the worshipper cannot come crudely with a gift in his hand, hoping to receive an equal or a greater return, but needs to inquire the way, and reverently to approach one whose nature and being he cannot fully know. In the later Rig-Vedic hymns there is a distinct approximation to the speculative and pantheistic spirit of philosophic Hinduism.

A further and noticeable feature of the Vedic gods is their predominantly beneficent character. Malevolent deities, at least of the higher order, are absent; and the demons, malicious and hurtful, in their perpetual conflict with the gods are uniformly worsted. The great gods themselves are either neutral and indifferent, or interfere actively for the suppression of wrong and the punishment of the sinner. Ethically regarded, their power was conceived as making for righteousness; and, though subject to gusts of passion, and open to external inducements and cajolery like men, the gods stood on the whole for justice and right as against deceit, fraud, and wrong. There can be little doubt that in the lofty character of their deities a comparatively high moral tone of the worshippers found expression.

That behind some of these personifications lies a deification of the heroic and honoured dead is sufficiently probable, though it can hardly be said to be demonstrated. Traces of totemism also have been found in the names of tribes derived from the cow, goat, fish, etc. These indications, however, are obscure and indecisive, and at the most are readily explicable on other principles. It remains that the leading motive of the theology of the Rig-Veda is Nature-worship, the attribution of a personal and divine character to the objects and phenomena of the external universe.

It is not of so great importance as at first sight it might appear to be that the poets of the Rig-Veda ascribe omnipotence and supremacy to the individual deity whom for the moment they are addressing; that, in other words, the religion of these hymns is henotheistic. Each divinity in turn so fully engages the thought and attention of the seer that there seems to be no room for any other, or at least for any equal. To him attributes of majesty and greatness are assigned which can be the possession of but one alone, unique and without a peer. But, as he ceases to be invoked and passes out of sight, another comes forward, who is invested with precisely the same powers and dignified with the same titles. This is the essential feature of *henotheism*, the worship of one god at a time, who for the time is regarded as supreme, to the exclusion or subordination of all others. In no other primitive religion is this character so marked as in that of early Aryan India. The logical conclusion and development of a henotheistic creed is monotheism, and from this forward movement Indian thinkers turned aside. The East cares little for logic or consistency in the strict Western sense of the term. And the Vedic religion fell back into a luxuriant polytheism, which on the one hand fettered itself with the most uncompromising system of rites and ceremonies that the world has ever known, and on the other allowed the freest scope to a speculative daring which resolved the idea of God into a vague and mystical pantheism.

2. The Brāhmanas.—In the thought that char-

acterized the period of literary development which followed, from the 6th or 7th cent. B.C. and onwards, it seems that to the active invocation of the gods by hymn and prayer had succeeded a ceremonial type of worship, which deadened all spiritual life, or at least drove it beneath the surface. The priest intervened, and demanded with growing insistence a rigorous precision in the observance of the niceties of rite and sacrifice, a strictness which in turn had the effect of making his own services the more indispensable. The gods needed placating, and none could placate them aright save the priest who knew the formulæ and was able to carry out the ritual. Myth and story, precedent and custom ruled. It was an epoch of order and commandment, of method crystallizing into principle, of elaboration of the minutiae of service, like to nothing so much as to the stringent demands of the later Judaic code, when beneath the weight of the letter of the law the spirit was almost crushed. Doubtless, however, the reality was not so entirely spiritless and formal as the extant literature would suggest. True progress was made, in doctrine as well as in the ritual and modes of the sacrifice. But the doctrinal changes hardly affected, broadly speaking, the people's conception of God. They were eschatological, extending the retribution which might be required of the sinner into a future life; building up a more ordered and settled theory of the constitution and government of the world; but leaving the idea of God still essentially that of one with whom a bargain might be made, and who for value received would forgo his wrath, acquit the transgressor, or bestow unnumbered benefits. This tendency found exaggerated and morbid expression in the practices of the hermits and ascetics, for whose use special books of rule and doctrine were framed (see art. *ĀRANYAKAS*), and who by intense meditation and prolonged self-mortification believed themselves able not only to wring from the gods any gift at will, but to supersede them in their dignity and sway, and to take possession of their throne (see artt. *ASCETICISM*, *RENUNCIATION* [*Hindu*]). On the other hand, a reaction against the formality and religiousness of the times seems to have given birth to a materialistic or atheistic movement, which has left its traces in the literature, though naturally not allowed to assume a prominent place there; which scoffed at all things human and divine, denied the existence of a God, and, quite after the approved manner, sought to make the best of the enjoyments and opportunities of the present.

3. A line of thought essentially opposed to that of the Brāhmanas is developed with great subtlety and power in the Upaniṣads (*q.v.*). Here the trend of thought on the nature and being of God is speculative and mystical, as contrasted with the practical and propitiatory view of the books of ritual. In germ there can be little doubt that the former is of at least equal antiquity; the human mind pondered and scrutinized certainly not later than it worshipped. But, in the form in which they have been preserved, the Upaniṣads present us with the final result of a long period of inquiry, discussion, and speculation, during which the ritualistic and the philosophical or speculative elements moved and were developed upon parallel lines, without in the main clashing with one another; until under Brāhman influence they were brought together, and in some sort harmonized and made to agree. The leading doctrine or doctrines of the Upaniṣads seem to have originated among the royal or warrior caste; by whom in the East, not in India alone, respite from arms and strife was devoted to eager inquiry, and to the conducting of religious and philosophical disputations. Later, the Brāhmanas adopted and welcomed

the new modes of thought, interpreting their own ritual as type and symbol of higher truths, which in themselves indeed transcended the type, but were thus set forth by way of accommodation to the needs of the unlettered multitude, whose minds were incapable of rising to the conception of abstract or spiritual realities, and needed a concrete image of the true. Hence there were two ways of arriving at a knowledge of the truth, of Brahma, or of God—the *jñānakāṇḍa*, the sphere of knowledge, in which he alone moves and by which he ascends who is gifted with purer, clearer insight than the common crowd; and the *karmakāṇḍa*, the department of works, designed for ordinary men, who thereby may win a proportion of merit and reach forth painfully to a higher state. It is in the former that the kernel and essence of Upaniṣad teaching is to be sought.

The thought or thoughts, then, of the Upaniṣads and of the great systems of Indian philosophy which are more or less completely based upon, and find expression in them have penetrated and rule the Indian conception of the unseen and the divine to an extent to which an adequate parallel can hardly be found elsewhere, unless it be the influence of St. Paul's Epistles, and of Augustine his interpreter, on the development of Christian theology. Thinking India is dominated by the Upaniṣads. And, owing to the presence and authority of the Brāhmanas, who had constituted themselves the custodians of doctrine, the conceptions of the Upaniṣads made their way to the lowest strata of society, gradually modifying and humanizing religious belief. It is true that outside even of these there was always a wide circle of non-Hindu aboriginal peoples; of whose creed Nature-worship, fetishism, and the like were the characteristic features. In mere numbers these last formed the majority; as, apart from the looseness and elasticity of the term Hinduism, which has thrown its wide net over very many who have the most shadowy of rights to be called Hindus, they constitute the majority to-day. Moreover, peoples so diverse and distinct as those who inhabit India can hardly be said to have one only thought upon any subject, least of all upon the highest, the nature and being of God. In so far, however, as there is a common tendency of thought, an accepted principle, disavowed by few or none, and leading naturally, and in most instances by virtue of the meditative and introspective character of the people themselves, to a definite form or type of belief, the articles of that creed, and especially the first and greatest—the Divine character and essential attributes—are laid down in the Upaniṣads, and have been thence derived, expounded, and promulgated.

Interwoven in all this literature there are two main strands of thought, which issued forth in the form of the two greatest and most influential systems of Indian philosophy. These are the idealistic and the materialistic. But the latter never developed into a religion, or gave birth to religious conceptions, and was perhaps incapable of so doing. It is true that, as a system, it admitted theistic ideas, and was largely modified in a theistic direction—under the uncontrollable natural impulse to worship, which seems at all times and among all peoples to have been ultimately too strong for abstract materialistic theory. But, though at one time widely prevalent, it so completely yielded place and popularity to the idealistic view that the latter has been justly described not only as the fundamental principle of the Upaniṣads, but as the almost universal presupposition of all Indian thought.

In regard to the nature of the deity and the being of God, idealism, if it ventures on any state-

ment whatever, is almost of necessity pantheistic. And, if a single term is sought by which to describe the leading principle of the many and various ramifications of Indian speculation on this theme, it could be none other than 'pantheism.' With the doctrines or conceptions associated with this term the thought of India's sons from the highest to the lowest is saturated. The pantheism of the East, however, as represented in the Sanskrit books and adopted in the belief of the people, differed from that of the West, assuming different premisses and arriving at different conclusions. Western pantheism, broadly speaking, has regarded God as immanent in Nature and the natural universe. To the Indian, Nature is immanent in God. European pantheism is hardly wronged, if it be said to have its eye first on the natural world, into which it introduces God. Indian pantheism makes God all in all, and introduces Nature only because the insistent demands of practical everyday experience compel it to do so, and to endeavour thus to reconcile theory with apparent fact; while at the same time it saves the unity and absoluteness of the Divine by denying to the natural universe any true existence or reality at all. The latter is always and only *māyā*, deceivableness and illusion. Only of God may being, existence, reality be predicated, not of the material world. There is one only, not another. Hence Indian pantheism, as far as its conception of the deity is concerned, would be more strictly and correctly described as 'pantheistic monism.'

4. The great systems of Indian philosophy carry forward, reiterate, and develop the thoughts which are found more or less fully expressed in the Upaniṣads. But of the six recognized systems (see sep. artt.), two, the Vaiśeṣika and the Nyāya, possess no significance from a religious point of view. Of the others, the materialism of the Sāṅkhya leaves no room for the spiritual or divine; and the decline of its influence, in the presence of its great rival, has been very marked. The Yoga, which philosophically is closely allied to the Sāṅkhya, has grafted upon the materialistic creed of the latter enough of theism to give reality to its doctrine of union (*yoga*) with the divine. It is upon the completeness of this union that in theory the success or failure of its ascetic practices depends; and the penances and religious exercises for which Indian ascetics have ever been remarkable are designed by virtue of this fusion to secure prospective benefits or the immediate possession of miraculous powers. The *yoḡin*, therefore, is a real theist, whose theistic doctrines are nevertheless scientifically irreconcilable with the philosophy with which they are combined. Although, however, the genuine *sannyāsin* still commands great respect in India, the popularity and influence of the class are declining with the spread of European ideas and education. And there can be little doubt that, like the asceticism of the early centuries in the West, the Yoga also will finally disappear, leaving behind it, nevertheless, the memory of a marvellous self-control, of many a pure and simple life, and of an entire, if often useless and misdirected, devotion to one single aim.

Of the two remaining systems, the Mīmāṃsā and the Vedānta, which are mutually related, and which seem to have originally formed parts of one whole, the former, which devotes itself to the exposition of the ritual, contains nothing which enlarges or interprets the conception of God. It is concerned with practical observance, not with theological doctrine. The latter, the Vedānta, is the dominant philosophy of India, where philosophy and religion, more than in any other country, go hand in hand. Its estimates and definitions of God have swayed the minds at least of the more

thoughtful classes of the people almost as far back as the records will carry us; and have determined the trend and character of the general belief of all, from the highest to the lowest, to a degree perhaps unparalleled elsewhere. The great majority of Hindus, with more or less acknowledgment and consciousness of the fact, are Vedāntists; and Vedāntism is but the theoretical development and expansion of the governing conception of the Upaniṣads. Creed and practice, however, are not of necessity adjusted to one another. A complete adjustment would indeed, on Vedāntic principles, be an impossibility in experience. And not infrequently the man who in theory is a pantheist and idealist will in practical life repeat his prayers and perform ritual service to many gods with as much outward fervency as his unphilosophical neighbour.

So far from denying that there is a God, the Vedānta identifies everything with Him. All that is not mere *māyā*, unreality and illusion, is God. Brahman (God) is one—one being, one soul, one mind, one only without a second. This universal soul, moreover, is one with the individual soul, and therefore each soul is complete and perfect Brahman; there is no distinction of persons, for all is one. Brahman is also of necessity indefinable, since every predicate, even the most general and indefinite, implies a contrary, an opposite, and besides Brahman there is none else; he is all-pervading, all-comprising, thought without an object of thought, the thinker absolute and alone. Strange as such reasonings may appear, they were built up with consistent and unshrinking logic from the premisses which the authors of the Vedānta laid down. And, if from these heights of refined fancy and speculation, where definition fails, where 'I am Brahman' and 'Brahman is I,' and where idealism strains itself in the effort to reach the ultimate reality, thought was soon compelled to return and to endeavour to find a way to harmonize pure abstract thinking with the demands of experience and practical life, it remains true that in theory the Indian idealist is the most thoroughgoing and consistent in the world. His idealism, however, remains almost necessarily a mere creed, which he will expound with earnestness and fervour, but which under ordinary circumstances hardly affects his conduct and life.

5. Epic poetry.—The importance of the great epic poems of India, the *Mahābhārata* and the *Rāmāyana*, for the history of religious thought in its bearing upon the Hindu conception of God, is second only, if indeed it is second, to that of the Upaniṣads and the orthodox systems of philosophy. The latter have been the property and study of the thoughtful and learned, and their influence has only indirectly touched the lower strata of the population; but the epic stories are the popular possession of the inhabitants of every village and hamlet, as well as of the great towns and centres of pilgrimage. The names of their heroes and heroines are household words throughout the length and breadth of the land. *Sitā Rām* is the most frequently heard sound on the lips of the devotee, whether in the open air or at one of the many shrines consecrated to the worship of the god. *Hanumān*, *Bhīma*, *Rādhā*, and others occupy a position second to none in the affection and reverence of the villagers. And, while each district has its own store of folk-tales, and its own gods and godlings, whose name and influence extend more or less widely into the region beyond, the great historical epics have penetrated the whole land. To use a somewhat hackneyed comparison, they are to India what Homer has been to Greece. Their heroes are known everywhere, and in many instances have become identified with

local or tribal divinities, whose attributes they have more or less adopted, and whose worship they have absorbed.

Many of the elements, the episodes, and the characters of this poetry may be traced back to a great antiquity, equal if not superior to that of the Upaniṣads themselves. Its thought, however, has moved on different lines, and the points of contact, of action and interaction, have not been numerous. But, while the tone and tendency of the philosophical literature has been pantheistic, mystical, and symbolical, that of the epic poetry has been uniformly in the direction of theism—not monotheism, but a rich polytheism, which has flooded the land with gods and goddesses innumerable. It is an illustration, moreover, of a bent of mind that has been noticed before, that from among this crowd of divinities there has always tended to emerge one or more with greater power and wider sway than the rest, whose vengeance is more to be feared and his anger deprecated, and whose aid it is more desirable to secure in times of need. The Indian pantheon is always a more or less stable monarchy, not a republic.

More or less dependent upon the epics proper is the secondary romantic and mythological literature, still imperfectly explored, and extant not in Sanskrit but in the various vernaculars, embodying material much of which has come down from a considerable antiquity. While the tone of a great part of this literature, as far as it is known, is sufficiently demoralizing and coarse, there breathes in some of the works a true religious spirit, which seeks to cast off that which is sensual and degrading, and to know and hold communion with a higher power that makes for righteousness.

6. A characteristically strange combination of theistic and ethical teaching with dreamy speculation is found in the *Bhagavad-Gītā*, the Song of the Blessed—the New Testament, as it has often been called, of Hinduism. To the European reader its many repetitions, its frank opportunism, its digressions, and the framework and presuppositions of unfamiliar ideas, fail to present an attractive whole; but upon Hindu thought there is no book which has exercised so fascinating and elevating an influence. 'When my heart is lonely,' said an Indian *sādhu* recently, 'I read in the *Bhagavad-Gītā*; and I like that better than any other book, because it makes my heart glad.'¹ The very features which condemn it to Western taste are beauties and excellencies in Indian eyes. But with all its difficulties and inconsistencies, characteristics which it only shares with nearly all Eastern literature, it cannot be denied that the *Bhagavad-Gītā* has been a moral force, and that on the whole it has promoted simplicity and purity of life.

The poem has suffered interpolation (see art. BHAGAVAD-GĪTĀ), and is no longer in its original form. To this cause undoubtedly are due some of the contradictions which meet us in the poet's view of God and the chief good. Action and devotion are the two themes upon which he insists. Nothing is better than faith in God, reliance upon Him, and obedience to His will; and this is the whole duty of man. The doctrine of Brahman, moreover, the soul of the universe, everlasting and changeless, is set forth in the manner, and even in the very phraseology of the Upaniṣads; and the entire poem, as it exists at the present time, moves in the atmosphere of Vedāntic idealism. It has been usual to suppose that this idealistic teaching represents the view of the original *Bhagavad-Gītā*, and that the theistic and practical doctrines are a later accretion. In a recent monograph, however, R. Garbe argues strongly for the primitive character of the theistic element, holding that the basis of the poem was a monotheistic treatise or hymn designed to commend the worship of Kṛṣṇa as supreme god; and that this was worked over and supplemented more than once in the interests of Brāhman orthodoxy and the ascendant idealistic views. The last word upon the past of the *Gītā* has

¹ Quoted in T. L. Pennell, *Among the Wild Tribes of the Afghan Frontier*, London, 1909, p. 235.

certainly not been said. But, however its tangled history may be unravelled, there can be no doubt that its monotheistic and spiritual teaching, modified as it may have been and contaminated by other tendencies, has been a most potent factor, perhaps the most potent factor, in the religious life of India.

7. Sects.—By the side of the philosophic doctrines and systems there exist and have existed from the earliest times innumerable sects, over all of which has been thrown the loose cloak of the Hindu name, but which differ widely from one another in belief and practice. Of these the larger number accept more or less fully the ancient Vedic divinities, recognize the supremacy of the Brāhman rules and caste, and adhere to one or other of the philosophical systems above named. Cross currents, however, run everywhere; the sects and the systems are rarely or never conterminous. And it can only be said in general terms, which admit of numerous exceptions, that this or that form of religious belief is allied with a particular trend of philosophical speculation. The tenacity and conservatism of the Hindu, moreover, has led to the result that the circumstances of the origin and rise of a creed or sect, the environment and history of the founder and his immediate disciples, have exercised a more permanent influence on the character of the faith they have professed than is usual in the West. The sects that have rejected Vedic and Brāhmanical traditions have been comparatively few, and in most, perhaps all, instances, the impulse to such rejection has come from without. Historically also they have ordinarily assumed the shape of a reform of existing usages, and a purification of doctrine and religious belief; and in relation to the dominant orthodoxy have run a more or less prolonged course of successive antagonism, toleration, and decay, sinking back into the all-absorbing and inert mass of Hinduism by which they found themselves surrounded. A broad and general classification of the sects on these lines may be made according as they owe their inspiration mainly to internal sources, Hindu or Buddhist, as Śāktism, Rāmānuja, Chaitanya, etc., and the Ārya Samāj; to Muhammadanism, as Kabir, Nānak, and the Sikhs; or to Christianity, as the Brāhma Samāj and kindred societies. But the originating causes of all are manifold and complex, and no such classification is exhaustive, or in details unexceptionable.

The greatest and most enduring revolt from Brāhmanical assumption and claims was raised in Buddhism, which has left marked traces of its influence in many of the sects, and, though in general extinct in India, lingers obscurely to the present day in some of the villages of Bengal.

The sectarian or popular religions of India are thus essentially theistic. The two chief forms of religious creed and life, *Vaiṣṇavism* and *Saivism*, which recognize Viṣṇu in one or other of his forms and Śiva respectively as supreme, can both be traced back to a great antiquity, and contain elements which it is impossible now fully to disentangle, derived from the ancient beliefs and practices of the aboriginal tribes, and from the perhaps loftier faiths of the incoming Aryans. Of the two, Saivism is the older, and has preserved most of primitive ideas, customs, and tendencies. Vaiṣṇavism has come more entirely under the influence of Aryan thought, and has submitted more completely, as far as speculation is concerned, to Brāhman ascendancy, following in its development the lead of Brāhman advance. Saivism, on the other hand, has hardly passed beyond a material and sensual view of things. Philosophically, the latter approaches nearest to the Sāṅkhya; but on the religious or emotional side has allied itself with Śāktism, the worship of the vital principle in Nature, and with the cult of the

Mātris or Mahāmātris, the 'mothers' or 'great mothers,' who are the source of all fertility and life, and on the other hand deal out disease and death. Kālī, the black goddess, whose temples are stained with blood, and whose ferocity reflects, no doubt, the traits of primitive savage life, has been identified with the wife of Śiva; and thus to her rites has been given the sanction of official recognition. Together with other deities throughout the land, of kindred nature and probably similar origin, though less widely popular and influential, this goddess and her worship have therefore become responsible for a degradation of the idea of God, which has made of the divine power a capricious tyrant, or a monster that needs to be propitiated with the best that his worshippers can provide. Early in our era and for many centuries Śaivism was apparently the dominant cult in India; but it has long been losing ground steadily to its great rival.

The second idea closely associated with the Śaivite form of faith was that of *asceticism*. Śiva was the great patron of ascetics, and himself strenuously practised self-mortification. And the *sannyāsin* or Indian devotee, who divested himself of all his possessions, was a *yogin* who sought, thus disencumbered, the final aim of union with God. To him the rejection of family ties and the abandonment of home and friends, together with the affliction of the body, were but means to an end—the securing of release from individual existence with all its pains and penalties, and becoming absorbed at last in the divine. The ascetic ideal therefore was not only inconsistent with the prevailing pantheistic mode of thought, but directly contradicted it. To the true Vedāntist there could be no question of absorption into a higher power, whether personally conceived or not. He was already essentially and altogether one with Brahman, and the only change necessary or possible was enlightenment, the opening of his eyes to a pre-existing fact, an eternal truth. The ascetic principle, however, as worked out in India, tacitly assumed the contrary. The quest for union, on whatever lines it was pursued, implied belief in a supreme power with which the union was sought; and that power was logically personal, though even here Hindu thought did not always accept or recognize its personality. The tendency therefore of the *yoga* conception and practice was all in the direction of theism.

It may be doubted, however, whether in ancient times any more than at the present day the ascetic ideal ever exercised really a great influence on the mass of the people of India, or modified to any appreciable extent their attitude towards the spirit world. They were vaguely conscious of its excellence, admired it in theory, and were ever ready in practice to bring their gifts. But they neither imitated nor desired to imitate the manner of life therein exemplified.

Of far greater immediate influence than the Śaivite faith or ideal is Vaiṣṇavism in one or other of its many forms and sects. Allied with the philosophy of the Vedānta, the Vaiṣṇavite creed has commanded the allegiance of three-fourths of the thoughtful minds of India, and has deeply, if not always consciously or professedly, permeated the life and moulded the conduct of the great mass of the people. It can hardly be disputed that Vaiṣṇavism is the truest *general* presentation of the religious tendencies and conceptions of the Hindus; and, apart from its theoretical idealism, it is more decisively theistic in practice than Śaivism itself. In its higher, purer forms the henotheism of the Vaiṣṇavite worshipper approaches closely to monotheism; and of all the so-called heathen cults, including Buddhism, this

faith in its creed and in many of its forms has most affinity with Christianity. In particular, the ascetic ideal presents no attractions to the true Vaiṣṇavite, and to him the ferocious character of the Śaivite divinities is especially abhorrent. In his temples no bloody sacrifices are offered, self-torture and self-immolation are unknown, and are indeed opposed to his religious principles. His entire conception of God is gentler and more humane, and is, moreover, deeply impressed at every point with anthropomorphic tendencies. The Deity is present to man, converses with him, walks by his side, sees and hears, knows and feels, and perpetually reincarnates Himself for the deliverance of suffering, helpless humanity. The similarity to Christian doctrines is often indeed merely verbal and superficial, as is the case with the Hindu theory of incarnation (see article INCARNATION [Hindu]). But the purpose is broadly the same, the rescue of man from the baleful dominion of a foreign and hostile power. Such 'descents' or incarnations take place continually, more or less of the deity being present under the bodily form. And every great ruler or teacher is thus regarded by his followers as divine, with a just claim not only to respect, but to formal reverence and worship.

8. Reforming movements.—Upon this theistic or monotheistic conception, as distinguished on the one hand from the vague idealistic monism of the philosophers and *yogins*, and on the other from the polytheistic beliefs of the common people, the reforming movements that have arisen within Hinduism itself have usually laid stress. In most instances a comparatively lofty moral and spiritual tone has characterized the teaching of the founders of these systems, and they have pointed the way not only to an amendment of life and manners, but to a purer faith.

(a) Perhaps the greatest and most influential of the reformers was *Rāmānuja*, who was born near Madras probably in the early part of the 12th cent., and took up the position of opponent of Śaṅkara in his interpretation of the Vedānta sūtras. He expounded and enforced the doctrine of a Supreme Deity, endowed with all the attributes of graciousness, wisdom, and love; of the separateness of the souls of individual men, who are capable of knowing and attaining unto God; and of the reality of the external universe. His teaching also has been supposed, without any sufficient justification, to owe its inspiration to Christian influence.

(b) The impulse which Rāmānuja gave to a higher, purer faith was effective mainly in the south of India, where his followers and disciples carried and still carry on his work. In the 15th cent., however, it became a power in the Panjāb and the north through the influence of *Rāmānanda*, an adherent of the principles and doctrine of Rāmānuja, who abandoned the narrow practices of the successors of the latter with regard to caste, and proclaimed the natural equality of all men, of whatever race, religion, or birth they might be. All that was best and most tolerant in his system was then taken up by *Kabīr* in the Panjāb in the 16th cent., who is said to have been a personal disciple of Rāmānanda. Himself of Muslim origin, Kabīr united in his teaching the strict uncompromising monotheism of Islām with the broader outlook and more generous views of the Vaiṣṇavite faith as represented by Rāmānuja and his school. The sayings attributed to him breathe a high moral tone, but are deeply penetrated by the mysticism characteristic of Indian thought. With him and with his great disciple *Nānak* originated the reforming movement of the Sikhs, which, taking cohesion and national life under the pressure

of external persecution, developed into a strong military society and kingdom, offering curious contrasts as well as resemblances to the militant orders of the Middle Ages in Europe; but which, while maintaining its own exclusive ceremonial and forms of worship, has ceased to possess a distinct religious significance, or to preserve its doctrinal and ethical superiority to the Hinduism by which it is surrounded. See, further, under art. SIKHS.

(c) In another direction, all the more interesting and instructive because it seems to draw its inspiration from purely native sources, the teaching of Rāmānanda and his school was taken up in the work and writings of *Tulasī Dās*, perhaps the greatest as well as the best-known and most popular of India's poets. Literature in India is, almost without exception, whatever its immediate theme, religious and philosophical in tone. And the poems of *Tulasī Dās* convey instruction in religious doctrine and embody a system of cult and creed, which by virtue of their popularity has been carried into every hamlet and almost every household where the Hindi tongue is spoken. 'Fully ninety millions of people base their theories of moral and religious conduct upon his writings.'¹ In adopting and giving literary expression to the teachings of Rāmānanda, *Tulasī Dās* imparted to them a tenderness and directness of application to human needs which constituted their irresistible appeal to the hearts of the common people. There is one Supreme Being, who in love and pity became incarnate for the relief of man from his sin. In His sight all men are equal, without distinction of birth and position; all are alike involved in ruin irretrievable save by the grace of the Creator, and thus all stand in need of a deliverance which in and by themselves they are incapable of achieving. *Tulasī Dās* further declared that it was in Rāma, the blameless king, that the Deity became thus incarnate; so linking his teaching with the most popular hero and exemplar of bygone days. The justly celebrated and much-honoured poet died early in the 17th century. He also has been freely credited with having borrowed his doctrines from Christian sources; but there seems to be no real ground for the charge, at least so far as direct derivation is concerned. His creed is the outcome and highest expression of all that was best in Hindu thought, controlled and guided by a pure heart searching after wisdom. There have been many like-minded among the sons of India.

(d) The later and more modern reform movements within Hinduism owe at least as much to the ferment of Christian thought and ideals as the earlier movements of the Panjāb to Muhammadanism. Of these the *Ārya Samāj* (*q.v.*) claims to find a pure monotheism in the four Vedas, which alone it accepts as inspired and authoritative Scripture. The adherents of this sect, while intensely hostile to Christianity, ascribe to the Deity attributes of mercifulness and grace, which have their nearest parallel in the God of the New Testament. They deny the possibility of an incarnation, and in this respect approximate most to the teachings of Islām. Their professed aim, however, is to restore the ancient unblemished faith of Vedic times, which they declare has been corrupted from without, at the same time maintaining strongly the doctrine of transmigration, although this is, strictly speaking, foreign to Vedic teaching. The influence of the *Ārya Samāj* is neither very deep nor far-reaching, and it has spread mainly in the ultra-conservative circles of those Brāhmins who have kept themselves aloof from Western ideas and education; its position

¹ G. A. Grierson, in *JRAS*, 1903, p. 455; cf. his art. in *JA*, vol. xxii. 1893, pp. 89, 122. *cf.*: and art. *TULASĪ DĀS*.

and tenets nevertheless bear strong testimony to the real tendency of Hindu thought in relation to its conception of the Divine.

(e) The *Brāhma Samāj* (*q.v.*) and kindred societies have been more deeply affected by Christian example and teaching, and more frankly acknowledge their indebtedness to Christian books. Their leaders have moved to the very border-line of Christian belief and confession, and have often been thought to have passed over it. They have, however, uniformly rejected the doctrine of incarnation, and with it the Christian conceptions of the Trinity and of the Divinity of Christ. They preach and teach a pure monotheism, and in this respect hold the same position as the adherents of the *Ārya Samāj*. Their views, however, are undoubtedly broader and more liberal, and in their public services passages are read not only from the Vedas, but from the New Testament and the Qur'ān. The reverence which the followers of the *Brāhma Samāj* profess for Christ and His teaching is deep and sincere, and the language they employ is not seldom such as would readily lend itself to a Christian interpretation, and has indeed frequently been so regarded. They do not, however, intend it in this sense. Their creed, so far as it concerns the nature and being of God, is limited to confession of faith in one only God, infinite in wisdom and goodness and power, whom Jews and Christians, Hindus and Muhammadans, Parsis and Buddhists alike worship, though under different names.

The members of the *Brāhma Samāj* and of sects allied to it by origin and creed are few in number compared with the total population of India; and their propaganda, though at one time zealous and earnest, has never been very successful. There can be no doubt, however, that the ideas which they represent commend themselves generally to the Indian mind, and are widely influential among the more thoughtful of the people at the present day.

9. By the side of all these sects, which by comparison may be termed orthodox, there have existed in India from the very beginning innumerable forms of *Nature-worship*, *demonolatry*, *polytheistic beliefs*, which vary from province to province, and almost from village to village. Of the origin and subjective history of such beliefs very different accounts have been given (see artt. ANIMISM, and NATURE, NATURE-GODS). In practice in India they present themselves under the form of an almost universal belief in spirits or demons, who pervade and manifest themselves in all the forces and phenomena of Nature. It is only the higher and educated classes, and not always or all of these, who have emancipated themselves from the thralldom of the fear of invisible beings, ghosts, and imps, the spirits of fever and pestilence and mischief in general, that haunt their imagination, and render their lives a perpetual attempt at the conciliation of powers of the unseen. *Ancestor-worship* also has played its part, chiefly under the form of a propitiation of the spirits of the dead, to secure that they shall not return to injure or torment the living. Men and women, conspicuous for piety or iniquity, from whom favours may be expected or whose wrath is to be deprecated, draw to themselves the worship of multitudes, stirred by hope or fear. *Totemism*, again, has left broad traces on the superstitious beliefs and practices of the people, and lingers in hardly diminished vigour in country districts. No river or hill, no tree or rock or spring, is without its inhabiting divinity. Every malady is attributed to an evil genius, every misfortune wrought by a devil. The house, the temple, the road, the field, each has its guardian spirit—with the result that the thirty-

three lacs of deities, with which India is popularly credited, might easily be multiplied many times, if the reckoning were to take account of every way-side image and to enumerate every village sprite.

The truth is, however, that among all these variant forms and practices of worship there is a very great likeness. It is more often a matter of name than of nature; and the underlying conceptions and principles may easily be reduced to two or three. The vast majority, moreover, of the singularly monotonous and recurrent impersonations to which the Hindu villager does reverence, from the extreme north to the farthest south of the peninsula, are not gods in any real sense of the term. At the best they are godlings, miniature deities with restricted interests and powers; at the worst, spiteful and malevolent demons, whose immediate sphere of influence is comparatively circumscribed, and who reappear under different names but with almost identical attributes and functions in every part of the country. The great gods of Hinduism are few, and are mostly the descendants or survivals of the divinities of Vedic times. The supernatural powers of lower rank are without number, an ever-changing crowd, who push and jostle one another in the struggle for pre-eminence, and pass out of sight and out of mind like any mere man. The stable element among them is usually of ancient aboriginal derivation—deities of the woods and streams and fields, that have maintained their place in the affections and reverence of the people in spite of the pressure of invading Hinduism. India is full of the spirit of religious toleration and compromise; and the assimilation of rites and divinities and worship is proceeding at the present day probably more rapidly than at any earlier time.

10. Amid so great and endless a variety it would seem almost hopeless to attempt to frame a definition of the Indian conception of God which should be at once simple and sufficiently comprehensive to include all that passes under the name of Hinduism, and which at the same time should adequately distinguish her creed in this respect from the other great religions of the world. And indeed such a broad and general definition, except in the vaguest and most catholic terms, is impracticable. For it must be remembered that throughout the course of her early and late history Hinduism, by virtue of her very elasticity and open-mindedness, has been profoundly affected by the thought and practice of Buddhism, Muhammadanism, and Christianity, to say nothing of the numerous sects to which she has given birth and which she has nurtured within her own bosom. These last have contributed no insignificant share to the sum-total of her beliefs. In no respect, in regard to her faith, is Hinduism a complete articulated whole, but rather a loosely congested mass of materials, held together by the fascination of a common name, and the imposed bondage of prevalent social customs. It would seem possible nevertheless, even if the nature and history of Hindu thought forbid rigorous definition, to indicate certain broad tendencies of mind which have almost crystallized into articles of universal faith; which have, on the whole, maintained their ground throughout the centuries; and which combine to make up no unfaithful picture of the essential creed of the ordinary Hindu, as it concerns his belief in the unseen power that he knows as *Īvara*, or God.

Whatever measure of internal unity—unity of thought and conception, of outlook on the facts of life and interpretation of its issues—the Indian peoples possess is due to their religion. Politically and socially they have never been one. Nor are they such religiously, save in the general tendencies above indicated. But, on the other hand, Hinduism

has been so broadly comprehensive, gathering into its net the most diverse races and absorbing the most unlike and even contradictory modes of thought and worship, constraining them all to pass under one name and to recognize the advantages of one social order, that many have despaired of a definition on religious lines, and have affirmed that the common bond consists merely of external conformity to certain social usages, combined with a practical recognition of the supremacy of the Brāhman caste. This denial to Hinduism of the status of a religion ignores the intensely religious character and tendency of the Hindu mind. Whatever else it may imply or concede, the essential indispensable element, without which there is no religion, is *belief in a higher power*, whether one or many. It may be doubted whether there has ever been a people among whom this belief has been more deeply engrained, or, to put the same thing in other words, who are more religiously inclined than the inhabitants of India. The definition, therefore, of Hinduism cannot be entirely secular; it will be simple, its articles few and broad, its terms of subscription wide and generously interpreted; but it will be distinctly a religious definition, not one of mere outward form or social conformity. With such a definition we have no further concern here than as it contains and gives expression to the Indian conception of the Divine, of God. It must be borne in mind also that general statements can never be other than subject to numerous exceptions and deductions.

(1) Hindu thought shows a marked inclination towards theism. It would, perhaps, be more correct to describe its speculative theory as henotheism, the occasional or opportunist worship of one divinity, the supreme object for the time being of the worshipper's devotion. Atheism has never found a congenial home on Hindu soil. Alien, like agnosticism, to Hindu nature and sympathies, it seems to have been almost always an exotic which has required delicate nurturing to bring it to even a stunted maturity. The philosophic pantheism of Śāṅkara, on the contrary, has proved itself to be in harmony with the tendencies and dispositions of the people; and his interpretation of the Vedānta on these lines, although not unchallenged, has become the accepted metaphysical belief of the great majority of those who call themselves Hindus. The philosophical theory, however, does not interfere with the practical religious faith. In actual life Brahma, the All-One, with the doctrines of non-dualism, reality and unreality, illusion and the like that are associated with the Vedantic creed, remains theory and theory only. The living potent force to which the man turns in need is not his philosophy, but the personal God, who, by whatever name He is called, as Rāma, Viṣṇu, Kṛṣṇa, or many another, is conceived as the sovereign dispenser of favours and the ultimate source of power.

(2) Together with this henotheistic and, as it were, ultimate though unformulated creed, there exists an indescribable wealth of polytheistic beliefs, godlings, male and female, without number, imps and elves, ghosts and demons, the vast crowd of whom not seldom obscures, and for immediate purposes puts out of sight, the loftier and more stable power in the background. Among the more primitive races and tribes of India also, as so frequently is the case among peoples low in the scale of civilization, there are found traces of a belief in a higher beneficent power, supreme and unchanging, seldom addressed, who has become a shadowy recollection rather than an active force or an object of worship, discarded from memory and regard in favour of spirits, whose malicious

designs it is the pressing necessity of the moment to frustrate. Hindu belief, therefore, is not wrongly described as polytheism. A better term would be 'polydæmonism.' But the description does not cover the whole ground. It leaves out of account a higher and more significant element, in which the lower and more primitive is embraced, and by which in the more thoughtful minds it is superseded.

(3) To the Indian, religion and philosophy are inseparable. His thinking is essentially spiritual and idealistic. The imperious demands of a hard daily life leave, indeed, to the ordinary Indian peasant, no opportunity for leisured or speculative thought; but amongst the higher classes the trend is distinctly in a spiritual direction. The ever recurrent puzzle of the relation of mind to matter is solved, as far as the Indian is concerned. Matter is the shadow; mind is the reality; and mind is God. His philosophy, therefore, is cast into the scale, not on the side of materialistic views or dogmas, but on that of an idealistic and reasoned theism.

(4) Hindu beliefs, finally, are coloured by the universal, or almost universal, acceptance of the doctrine of transmigration. Obscure and uncertain as the origin and early history of this doctrine in India may be, it has become a part of the most intimate faith of the people, and has profoundly influenced their outlook upon life. And, inasmuch as the gods themselves are, theoretically at least, involved in the *samsāra*, and subject to the perpetual flux and change of all things living, it has tended to make the outlines of these indistinct, their character and functions interchangeable. The dividing line between men and gods is not so firmly drawn as in the West, or the place and features of the latter so clearly conceived. Logically, a doctrine of transmigration assumes and necessitates a doctrine of the separateness of individual souls, and is as incompatible with the extreme idealistic theories of the Vedānta as with Christian theism. But the two conceptions lie side by side in the Indian mind without interfering with one another, or carrying on the mutually destructive war which to the European would appear inevitable. His thoughts concerning the Divine adapt themselves, or remain unadapted, to a view of life which opens out to him a vista of recurrent mundane existences practically without end.

Cf. also HINDUISM, VEDĀNTA, VEDIC RELIGION.

LITERATURE.—For the literature of the several periods of religious development, the sects, etc., consult the separate articles. All the works dealing with the religion and philosophy of India in general discuss with more or less fullness the Hindu conception of God; cf. esp. A. Barth, *Religions of India*², London, 1891, *passim*; E. W. Hopkins, *Religions of India*, London, 1896, ch. xi.; M. Monier-Williams, *Brāhmanism and Hinduism*⁴, London, 1891; *Census of India*, General Report, Calcutta, 1903, ch. viii. 'Religion,' with a valuable Appendix on the 'Religious Ideas of some Animistic Tribes in Bengal'; P. Deussen, *Philosophy of the Upanishads*, pt. i. 'Theology,' Eng. tr., Edin. 1906. A. S. GEDEN.

GOD (Iranian).—1. The idea of God during the Early Iranian period.—For ascertaining the conception of God entertained by the Iranians during the earlier period of their history we possess neither direct records¹ of their religious practices nor any form of sacred text crystallizing their religious experiences at that stage in the development of their God-consciousness. Nevertheless, the indirect

¹ In the year 1907, H. Winckler announced in the *Mittheil. d. deutsch. Orientgesellschaft* (no. 85) that he had found a number of names of Aryan gods in a Hittite inscription, of about 1400 a.c., at Boghaz-keul. Should the reading be finally confirmed, and especially their origin proved to be Iranian—a view defended by Oldenberg and other scholars—the above statement would, to that extent, require modification. On the significance of the discovery, see an article by E. Meyer in *Sitzungsber. d. königl. preuss. Akad. der Wissensch.*, 1908, p. 14 ff.; also several articles in the *JRAS* for 1909-10.

evidence bearing upon even this part of the subject is neither meagre nor wanting in significance, so that comparative science has succeeded in reconstructing what can be confidently regarded as the main content of the early Iranian pantheon.

In his well-known account of the divinities worshipped by the Persians in the middle of the 5th cent. B.C., Herodotus (i. 131) claims for the first part of his description an application to the conditions of a much higher antiquity:

'They are in the habit of ascending the highest mountains and offering sacrifices to Zeus—they give the name Zeus to the whole celestial circle. Moreover, they sacrifice to the sun, moon, earth, fire, water, and winds. To these alone,' he adds, 'they were accustomed originally (*ἀρχαίως*) to sacrifice.'

According to this account, therefore, the early Persian idea of God was that of worshippers of the great forces of Nature—reserving for special veneration the sky with its associated phenomena. Although this description lacks completeness in one vital respect, as will appear later, yet, so far as it goes, it accords perfectly, as we shall now proceed to show, with what our other available evidence leads us to believe of the Iranians generally at that period.

Schrader has already shown very fully (see art. ARYAN RELIGION, vol. ii. p. 31) that the worship of the elements enumerated by Herodotus always formed an essential and characteristic part of the religion of all the Indo-European peoples. That religious regard for the same Nature-powers should survive amongst the early Iranians is, therefore, in the absence of any known great disturbing influence, what was naturally to be expected.¹

The Iranians, however, shared with one Indo-European people a common religion and culture for a much longer time than they did with any of the others; and this common life continued until the commencement of the period of which we are treating. That people was the Aryan sept which ultimately settled on the banks of the Indus, and are known to us as Indians. Of necessity, therefore, the earliest religious ideas and customs of those tribes have the highest significance for the study of the early Iranian ideas of God. It must not be forgotten that there were, as later developments strikingly prove, very marked differences between the two peoples in concept and custom, dating in some cases probably from Aryan, i.e. Indo-Iranian, times. Hence the necessity for caution in attributing Vedic ideas to the early Iranians. But, when we find the same religious beliefs and usages reflected in the Vedas as are attributed by other independent authorities, such as Herodotus, to the contemporary Iranians, we may feel fairly certain that we are dealing with phenomena that were common to both peoples.

Now, the Vedas reveal the same general stage in the development of the consciousness of God among the dwellers beyond the Indus, especially during early Vedic times, as we have postulated for the Iranians during, partly, the same period. The mighty Nature-powers that inspired the awe and reverence of the Vedic poets also compelled the sacrifices of the devoted Iranians. Comparative philology has shown that the two peoples from the period of unity employed the same two general terms for a god, thus indicating that the character of the objects of their worship was the same. One of these was *asura* (Skr. *asura*, Av. *ahura*); the other was *daiva* (Skr. *deva*, Av. *daēva*), from Indo-European *deivo*, pl. *deivōs* (connected with *dyāus*, 'sky'), 'heavenly ones,' meaning the sky and the great physical phenomena connected with it.

The premier position amongst early Persian

¹ Agathias (ii. 24)—on the authority of Berosus, Athenocles, and Symmachus—says that previous to Zoroaster's reform the Persian religion closely resembled that of the Greeks (see Jackson, *GIP* II. [1896-1900] 618).

divinities assigned by Herodotus to the sky is in perfect consonance with the supremacy which the sky-god enjoyed amongst the Indians, whether in the oldest time under the name *Dyāus* or later under that of *Varuna*.

What was the name and what the exact connotation of the term the Persians employed in addressing themselves to the sky-god are moot questions. Our indebtedness and gratitude to the Greek historian would have been still deeper had he on this occasion departed from his countrymen's usual custom and abstained from converting the Persian term into its Greek equivalent.¹ That Herodotus had in mind the name *Ahura Mazda* is improbable,² for we have no evidence that he was acquainted with Mazdaism, as such, in any form, much less in its Zarathushtrian development. Spiegel suggests *thwāsha* (Mod. Pers. *sipihr*) as the probable term by which the Persians invoked the vault of heaven. It seems not improbable that the old term *dyāus* had been handed down as part of the tradition upon which Herodotus relied for his account of the earlier period.³

If the evidence of the Iranian sun- and moon-worship is somewhat less abundant, it is scarcely any the less clear or certain. In Vedic times the Indians worshipped the sun under the name *Sūrya* and the moon as *Mās*. The former is cognate with the Avesta *hvar* (Mod. Pers. *خورشید*, *خور*, 'sun'); the latter with Avestan *Māh* (Mod. Pers. *ماه*, 'moon,' and 'month'). The re-appearance of the sun and moon in the post-Zarathushtrian pantheon is highly suggestive of their earlier worship.

In this connexion mention should be made of another very important divinity, who, if not himself a sun-god, was still intimately connected with the chief luminary and gave modern Persian its usual term (☉) for 'sun.' We mean, of course, *Mithra*, Vedic *Mitra*. Perhaps the best opinion is that which regards him as the god of the luminous ether (cf. C. de Harlez, *Avesta*, Paris, 1881, p. 53; also Moulton, *op. cit.* 36 f.). The prominence of this deity in Vedic religion, and his almost unique position among post-Zarathushtrian *Yazatas*, leave no room to doubt his existence in the early Iranian pantheon.

Although the Earth did not properly come within the category of the 'Heavenly Ones,' yet the widespread mythological conception of the Earth as one of the divine pair, the wife of the sky, is sufficient ground for accepting her as an Indo-European divinity. In the Vedas her name, *Prthivi*, is, with four exceptions, invariably coupled as a dyad with that of the sky, *Dyāus*, in the form *Dyāvāprthivi*.

Moreover, we have the testimony of Herodotus (iv. 59) that at least one branch of the Iranian peoples—the Scythians—worshipped the Earth as the wife of Zeus.

There can scarcely be any doubt that the Earth or Earth-Spirit, under the name *Aramaiti*, was worshipped by the main body of the Iranians during the early period (see Spiegel, *Die arische Periode*, pp. 198-203; Moulton, *op. cit.* 36).

The most characteristically Iranian divinities, perhaps, are those that come next for mention, namely, fire and water. When Strabo says (xv. iii. 14) that it was to fire and water especially that the Persians offered sacrifices, he was indicating no new emphasis in Persian worship. That they were part of the Indo-European heritage is well known. And the new physical conditions in

¹ Hesychius maintained that *Δία* in Herodotus' account is not the accus. of the Gr. *Zeus*, but the Persian form of the term for 'sky,' derived from the Aryan *dyāus* (cf. Spiegel, *Erän. Alterthumskunde*, Leipzig, 1878, ii. 190).

² Spiegel observes that *Ahura Mazda* was not specially connected with the orb of heaven, and in later epochs he was identified rather with the planet Jupiter (*op. cit.* ii. 141, 190; also *Die arische Periode*, Leipzig, 1877, pp. 128-134).

³ See, however, Moulton, *Early Religious Poetry of Persia*, Cambridge, 1911, p. 86 (a small volume, but bristling with penetrating thoughts and pregnant suggestions on the whole subject of this article).

which the Iranians found themselves in consequence of their eastward migration served only to enhance the use and value of the two elements, and consequently to intensify their reverence for them or for the spirits which were associated with them. In India the chief fire-god was *Agni* (Lat. *ignis*); but in Iran he was venerated under another old name, *Atar*.

Another circumstance which substantially contributed to the prestige and pre-eminence of these two elements was their association with the thunderstorm—a phenomenon that specially excited the awe and reverence of primitive peoples, and for the Indo-European peoples it was not only a *deus*, but it proved to be a *fons multorum deorum*. We find among both branches of the Indo-Iranian people one very important and exceptionally interesting divinity, whose origin is to be traced to that great physical phenomenon, namely, *Apām Napāt*, or 'offspring of waters' (i.e. 'fire that resides in water' [Tiele]). In the Vedas he is a god of fire—the lightning flash; and even in the Avesta he is once associated with another god of fire, *Nairosangha*. But usually in the Avesta he is a god of waters. In the later books he is frequently invoked. In *Yast* 19⁵² he is even said to have made and shaped man. As Spiegel observes (*Die arische Periode*, p. 313), we have in *Apām Napāt* a very ancient and highly venerated divinity.

The presence of another divinity in Vedas and Avesta and the functions assigned to him point clearly to his existence in early Iranian times. *Vritrahan* in India is Indra, the slayer of the imaginary demon of drought; whereas his counterpart *Verethraghna* was regarded by the Iranians as the god of victory in general.

The wind was worshipped by the early Iranians under the name *Vayu* (Vedic *Vāyu*). It was specially revered for the supposed help rendered to bring to the earth the fertilizing rain from the clouds. Nor should *Haoma* (Vedic *Soma*) be omitted from the list of early Iranian divinities. It may not, as Tiele observes (*Rel. of the Iranian Peoples*, Eng. tr., Bombay, 1912, p. 54), have been materially the identical *Haoma* plant of the Later Avesta, but that an immortalizing drink was deified at that epoch is fairly certain. Cf. art. HAOMA.

The prominence of the custom of ancestor-worship amongst Indo-European peoples generally, taken in conjunction with the cult of the *Pitaras* in the Vedas, and particularly the lavish adoration of the *fravashis* (q.v.) in Later Avestan ritual, points inevitably to the conclusion that only during the strictly Zarathushtrian régime had this ancient custom been discontinued among the Iranians.

A more difficult question confronts us when we inquire how the early Iranians regarded their gods; what precise character they attributed to them; to what point in conception and feeling they had attained at this time. Whatever vestiges of Animism there may still have been in their religious notions, we are certainly justified in asserting that in pre-Zarathushtrian days in Iran, just as in India, some of the gods were credited with a tolerably high moral character (cf. Indian *Varuna*). Moreover, the two classes of gods, *ahuras* and *daēvas*, were even from Aryan times viewed in some respects as rivals in their claims upon the adoration of those tribes. In India, as is well known, even in early Vedic times, the *devas* are in the ascendancy, although it is not until the later Atharva Veda that we find the *asuras* regarded as demons.

In Iran the opposite course prevailed. The *ahuras*, who from Indo-Iranian times were the more feared and awe-inspiring, seem to have gradually gained in prestige, and, apparently at a very early epoch, one of them had become the *Ahura*

par excellence. And it is in relation to this Ahura that the religious consciousness of the Iranians has since been primarily developed and exercised. Moreover, evidence seems to be accumulating¹ to show that even the epithet *Mazdā*, 'wise,' or 'wisdom,' was, so early as the middle of the second millennium B.C., applied as the special cult-epithet of the great *Ahura*.

In consonance with this opinion is the fact that in the *Gāthās* Zarathushtra professed to reveal no new god to his countrymen, but only to bring a new revelation from one who was supposed to have been already well known. At this period, of course, even if supreme, he finds himself a member of a very extensive and miscellaneous pantheon.

2. The Gathic or Zarathushtrian conception of God.—It is the five *Gāthās* of Zarathushtra and his immediate followers that enshrine the oldest as well as the highest and purest form of the idea of God to which the Mazdayasnian religion attained. Ahura Mazda, or Mazda Ahura, which is the more usual order in the *Gāthās*,² is already not only supreme, but sole God. The whole Nature-pantheon has fallen from heaven to hell.

And, if Mazda himself was at any period a Nature-god,³ the last vestiges of his ancient associations have been completely obliterated to the minds of the inspired writers of these spiritual hymns. Not that Mazda any more than Jahweh, the God of Israel, was praised in linguistic forms free from anthropomorphism or material imagery. The God of the *Gāthās* also puts on the solid heavens as a garment (*Ys.* 30³) and covers himself with flames of fire. But still in substance he is *mainyu*, 'spirit,' as his faithful ones are never weary of repeating.

His most characteristic attribute is *spenta*, 'beneficent,' or 'holy,' in the etymological and wider sense of that English word;⁴ and this Beneficent Spirit is, in the *Gāthās*, the great and sole creator. He made not only the light, but darkness as well; not merely the dawn and noontide, but midnight just as truly (*Ys.* 44⁵). He is omniscient and omnipresent, the all-viewing Lord who cannot be deceived (46⁶ 45⁴ 29⁴), the immutable, who remains evermore the same (31⁷). Nevertheless, in one important respect he is limited: he is not omnipotent, or at least for the present that attribute is only potential, for there is another self-existent spirit, coeval with Ahura Mazda, fundamentally opposed to him in his very nature, and having for a period the power of thwarting the purposes of the Beneficent God and working evil and suffering among his saints.

From the principal passages in the *Gāthās* in which this doctrine is expounded, it would appear that Zarathushtra did not conceive of the Evil Spirit as gifted with positive creative power, such as is attributed to him in the post-Zarathushtrian portions of the Avesta. The truth that seems to emerge from the *locus classicus* of this doctrine in the *Gāthās* (*Ys.* 30³⁻⁵) is the self-determination of the rival Spirit for evil in harmony with his inherent nature, and his choice of wrong and death as the principle of his actions and influence. So far as the doctrine is developed in these hymns, *Angra Mainyu* or *Aka Mana* is conceived of as exercising his destructive and malicious power in

bringing about in the creation of Mazda an issue and culmination the very opposite of that destined for it by the Beneficent Spirit. In perfect keeping with this consciousness of a mighty, malicious, unjust, and death-causing Spirit ever bent upon defeating the Divine purposes, is the emphasis placed upon certain attributes and blessings of Mazda which are the absorbing theme of the *Gāthās*. That idea of Angra Mainyu is the dark background against which this conception of Ahura Mazda with his six (or seven, if Sraosha is included) ever-recurring attributes and blessings must be placed.

The minds of the Gathic poets are not so much concerned with the essence of Mazda's nature as with the endeavour to realize his true relationship to his saints and to the world as a whole. It is not theology proper that we find in the *Gāthās*, but the soteriological aspect of the doctrine of God. It is not his transcendence and absoluteness, but his immanence and relativity, which are here emphasized. These moral attributes, through which the ideal relationship is to be realized together with the blessings resulting therefrom, are conceived of in such a vivid manner that they are constantly personified and addressed as if they were distinct from their source and ground in Ahura Mazda. Still the words are so often used as common abstract nouns, that in these hymns there need be no mistaking them for separate personalities in the essence of Mazda. Perhaps Ps 43⁸ in the OT serves as a good illustration of this sustained personification of abstract ideas. The precise attributes emphasized, as well as their number, may have been determined in some degree by considerations dictated by the earlier history of Iranian religion.¹ Still the nature of the case would have been sufficient of itself to account for the facts as we find them, and perhaps this has not always been duly considered by the expounders of this part of the Gathic doctrine. The two most frequently mentioned of these abstract qualities or attributes are *Vohu Mana*, 'the good or best mind or spirit,' and *Asha* or *Asha Vahishta*, 'rightness,' 'perfect order.' The former connotes the idea of good will or benevolence, that attribute of Mazda which desires and seeks his people's good in opposition to that spirit which meditates harm to them; and in *Ys.* 45² these two are thus placed in opposition. The other concept is that expressed by *Asha*, which has as its root-idea that of fitness, appropriateness; hence order, rightness, and other shades of meaning. It means that ideal relationship in which all would receive their due and highest good in conformity with their nature and destiny. The next is *Khshathra* or *Khshathra Vairya*, 'power,' 'dominion,' 'kingdom,' or 'wished-for-kingdom,' and indicates that condition or state of things in which the power of Mazda completely avails, and in which his will is done, and where the two former concepts are fully realized. The fourth abstract attribute is *Armaiti*, 'piety' or 'devotion,' which Mazda produces in the soul of his saints, and is the subjective attitude corresponding to Mazda's benevolence and justice. The last two of the six conceptions are always mentioned together, namely, *Haurvatāt*, 'health,' 'weal'; and *Ameretāt*, or 'immortality.' They are equivalent to complete present and future salvation. This is the certain, if as yet distant, Divine event towards which the whole purpose and power of the Beneficent Spirit are ever directed.

Briefly this is the idea of God presented in the *Gāthās*, and the spirituality of their conception of

¹ See Moulton, *op. cit.* pp. 57, 63, where Hommel's discovery is referred to and apparently accepted as genuine. See also, in this connexion, Mills, *Zend-Avesta*, pt. lii. (=SBE, vol. xxxi. [1887]), *Introd.* p. xxxii, and note 1.

² The Gathic writers always write and decline the words separately, and were evidently conscious of the meaning of each part: *Ahura* meaning 'Lord,' and *Mazdā*, 'wise' or 'wisdom.'

³ Tiele strongly combats the idea. But many Vedic scholars and some Iranists regard Mazda as the counterpart of the Vedic Varuna.

⁴ See Jackson in *Monist* for Jan. 1899 (an excellent monograph on Ahura Mazda).

¹ The concepts underlying the words *asha* and *armaiti* go back even to Indo-Iranian times, Vedic *ṛta* being the equivalent of *asha*, and connoting the idea of moral as well as physical order.

God is reflected in the inwardness of their ethic; for Mazda demands truth and purity, not in word and deed alone, but also in mind and heart.

The apparent materialism of coupling *Ātar*, 'fire,' with the Spirit of Mazda does not mar this spiritual presentation. That it has a merely symbolical significance is certain. It typifies the power and purity of the exalted Mazda. In a beautiful psalm the Hebrew poet also couples with Jahweh's name the 'ark of his strength' (Ps 132^o). Nor is the name of the holy fire more incongruous with the Spirit of Ahura Mazda than is the mention of water with the regenerating Spirit in the NT (Jn 3^s).

3. The Mazdaism of the Later Avesta.—Ahura Mazda is still supreme, but he is no more the sole object of worship in the Later Avesta than he was in pre-Zarathushtrian days. By this time the six abstract ideas or attributes which were frequently personified, but never really regarded as distinct persons in the *Gāthās*, had become separate personalities, and were called *Amesha Spentas*, or 'Immortal Holy Ones,' and accorded Divine worship.

It must have been in this later form that the Greeks learnt of the doctrine, for Plutarch refers to them as six gods (εἴθε θεοὶς [*de Is. et Osir.* 47]); and Strabo speaks of a temple of Omanus (Vohu Mana), and a wooden statue of the god carried in procession (XV. iii. 15). Moreover, a distinct domain in creation is assigned to each, over which they preside (see AMESHA SPENTAS). The sacred fire, too, of whose symbolical and instrumental character the *Gāthās* are never unconscious, is now the son of Ahura Mazda, and shares his praise and adoration (cf. above, p. 30^a).

But the outstanding feature of the contrast between the Gathic and the Later Avestan divine circle is the re-enthronement of practically the whole of the pre-Zarathushtrian Nature-gods as *Yazatas*,¹ or beings meet to be worshipped side by side with Ahura Mazda and his archangels. The number of the *Yazatas* is really unlimited. At this time practically the whole of the good creation was stamped as Mazda-made, and worshipped. Still Plutarch (*loc. cit.*) was right when he mentioned twenty-four as the number of important *Yazatas*. The foremost amongst them is undoubtedly the god *Mithra*. His name is joined with that of Mazda, just as it was with that of Varuna in the Vedas. In the Zarathushtrian system, *Mithra* naturally found no place. It would have been inconsistent with its strong monotheistic tendency to admit so serious a rival of Mazda. His character in the later doctrine is that of protector and guardian of truth and veracity, the avenger of violated faith and compact (see MITHRAISM). Closely associated with the god *Mithra* at this period, we find a goddess who appears for the first time in the Iranian pantheon, namely, *Anāhita*, or *Ardvi Sūra Anāhita*, the high, powerful, undefiled one. She is the genius of fertilizing waters, and Herodotus is right when he assigns to her a Semitic origin (see ANĀHITA). Reference has already been made to the worship of the *Fravashis*, or guardian spirits of good men and women. Moulton attributes the extension of this belief and custom in the Later Avesta to the influence of the Magian element in the Mazdaism of the time (see *Thinker*, vol. ii. [1892] 495). This, perhaps, is the only contribution of Magism that concerns our subject.

4. The Mazdaism of the Achæmenian Inscriptions.—Whatever may be the fact as to the historical relationship of the Mazdaism of the Inscriptions, its general divergences from the religion of the Avesta are sufficiently marked to justify our treating their teaching on the idea of

¹ Cf. mod. Persian term *Izad* or *Yazdān*, meaning 'God.'

God in a separate section of the present article (cf. Moulton, *Thinker*, *loc. cit.*). Whether the religion of the Inscriptions is the direct and independent descendant of pre-Zarathushtrian Mazdaism, or a modified form either of Gathic or Later Avestan Zarathushtrianism, there can be no doubt that the Auramazdā¹ praised and confessed by the Achæmenian kings in these Inscriptions is identical with the Mazda Ahura or Ahura Mazda of the *Gāthās* and the later books of the Avesta. But the position assigned to him is distinct in each of the three cases. In the *Gāthās*, Mazda Ahura alone is recognized as God. He only is invoked for aid and deliverance, either directly or indirectly, his attributes and blessings being poetically personified and besought to come to his people's succour. In the Younger Avesta, although a great host of divinities are prayed to and acknowledged as worthy of worship, still, formally at least, they are accorded that dignity as the creation of Ahura Mazda. Even *Mithra*, 'the lord of wide pastures,' was created by the great Ahura (*Yt.* 10¹), and *Anāhita* also 'proceeded from the Maker Mazda' (5⁷).

In the Inscriptions, on the other hand, there are associated with Auramazdā, in the prayers of the kings, 'clan-gods' (perhaps the words should be rendered 'all the gods'), and 'the other gods that are' (cf. Xenophon's *τοῖς ἄλλοις θεοῖς*). And, even when Auramazdā is said to be 'the greatest of the gods' (*mathishta bagānām*²), there is a tacit admission that he is only supreme, but not sole God. There is no suggestion that they are his creatures. *Mithra* is co-ordinated with Auramazdā in the Inscription of Ochus: 'May Auramazdā and the god *Mithra* protect me and my kingdom and the work I have accomplished.' His predecessor, Artaxerxes Mnemon, not only addressed his prayers to *Mithra* and *Anāhita* with Auramazdā, but, according to Berosus (*frag.* 16, *apud* Clem. Alex.), he erected statues to *Anāhita* at Persepolis (see his Inscription), Ecbatana, Bactria, Susa, and Babylon. Nevertheless, the whole of the Inscriptions of Darius and Xerxes breathe a spirit more akin to that of monotheism than that of most parts of the Younger Avesta. The recognition of the other gods in these Inscriptions impresses us as being, very largely, formal; for the number of times they are mentioned in conjunction with Auramazdā is very small, compared with the instances in which he is prayed to alone. The character of Auramazdā as creator is constantly emphasized in all except the Inscriptions of Mnemon.

¹ A great god (*bagā vazarka*) is Auramazdā, who created this earth, who created yonder heaven, who created man, who created peace or prosperity or delight (*shiyāti*) for man, who made Darius [Xerxes, Artaxerxes] king.'

Not even in the *Gāthās* is the creator conceived of as being more distinct from his creation than these words show him to be. As for his government and providence, he is more unfettered according to the Inscriptions. He has created peace (*shiyāti*) for man, a state of happiness and prosperity of which even the *Gāthās* have no more than a promise.

5. The history of the later development of the idea of God amongst the Iranians is practically identical with that of certain sects in Sasanian times, whose views have also largely determined those of modern Parsiism on this subject. The treatment of this period will, therefore, come more properly under SECTS (Persian).

LITERATURE.—In addition to works already referred to, see, on the earlier period, O. Schrader, *Prehistoric Antiquities of the Aryan Peoples* (tr. Jevons, London, 1890); A. Rapp, 'Die

¹ Always, with one exception, written as one word.

² *Bagā* is the general term for a god in the Inscriptions. It is found a few times in the Avesta in the form *bagā*, and applied to Ahura Mazda in *Ys.* 10¹⁰ 70¹. In the Vedas it is the name of a particular god—Bhaga. Its cognate *bagu* (*bag*) is used in Slav as a general term for 'god' (see below, p. 302^b).

Religion und Sitte der Perser und übrigen Iranier,' *ZDMG*, vols. xix.-xx. (1866); A. A. Macdonell, 'Vedic Mythology,' in Bühler's *UIAP*, Strassburg, 1897. On the Avesta and teaching arising therefrom, see K. F. Geldner, *Avesta*, Stuttgart, 1898-96, also art. 'Zoroaster,' in *EBR*¹¹; L. H. Mills, *The Five Zarathushtrian Gāthās*, Erlangen, 1894; C. Bartholomae, *Die Gāthās des Avesta*, Strassburg, 1906; F. Spiegel, *Commentar über das Avesta*, Leipzig, 1865-69; J. Darmesteter, *Ormazd et Ahriman*, Paris, 1877. A more general treatise is C. P. Tiele, *Gesch. der Religion im Altertum*, vol. II., 'Die Religion bei den iranischen Völkern,' Gotha, 1898, pp. 1-187. On the Old Persian Inscriptions, see F. Spiegel, *Die altpers. Keilschriften*², Leipzig, 1881; *The Inscription of Darius the Great at Behistūn*, printed by Trustees of British Museum; A. V. W. Jackson and L. H. Gray, 'Religion of the Achaemenian Kings,' *JASO* xxi. (1900) 160-184; L. C. Casartelli, *La Religion des rois achéménides d'après leurs inscriptions*, Brussels, 1895, and *Philosophy of the Mazdaean Religion under the Sasanids*, Bombay, 1889, dealing with later developments, which this article has merely mentioned for future treatment.

E. EDWARDS.

GOD (Japanese).—The Japanese word for 'god' is *kami*. Its derivation is uncertain. Some see in it an abbreviation of *kangami*, meaning 'to look at,' 'to judge,' 'to decide'; others, a form of *kimi*, or 'lord'; while still others propose *kabi*, 'the mysterious,' as its origin. A comparatively modern theory traces it to an Ainu word, *kamui*, meaning 'he who or that which covers or overshadows,' and so representing divinity. The generally accepted derivation, however, is that to be traced in modified meanings of the same word *kami*, signifying that which is 'above' or 'superior,' in contrast to *shimo*, signifying that which is 'below' or 'inferior.' The upper part of the body is *kami*, while the lower part is *shimo*. A man of superior rank is *kami*, while an inferior is *shimo*. Heaven is *kami*, earth is *shimo*. So general is the term that it lends itself readily as an appellation of that which is looked upon with fear or respect, as above man in power or superior in any attribute. Motoori, an eminent Shinto scholar (1730-1801), says:

'The term *kami* is applied in the first place to the various deities of Heaven and Earth who are mentioned in the ancient records, as well as to their spirits which reside in the shrines where they are worshipped. Moreover, not only human beings, but birds and beasts, plants and trees, seas and mountains, and all other things whatsoever which deserve to be dreaded and revered for the extraordinary and pre-eminent powers which they possess, are called *kami*. They need not be eminent for surpassing nobleness, goodness, or serviceableness alone. Malignant and uncanny beings are also called *kami*, if only they are objects of general dread' (*Kojikiden*, ed. 1901, III. 150).

The primitive faith of the Japanese was Naturism, in which various natural phenomena, awakening awe and reverence, such as the sun and moon, fire and water, wind and storm, were worshipped, and in which various Divine names were given to the powers controlling the more noticeable manifestations of Nature. To this limited body of divinity others were added; and not a few from foreign countries were recognized, until the number was generously stated as 'eight myriads,' and the country was called 'the Land of the Gods.' According to an official record, compiled in A.D. 901, the number of shrines at that time was 2861, while the number of deities worshipped therein was given as 3132. This multiplication of deities has continued until the present time; and the latest official statistics give the number of Shinto shrines of all grades as 190,436. These shrines are sacred to: (1) mythical gods, (2) patriots and heroes, (3) phenomena and objects of Nature, and (4) various animals and objects. Among the shrines recognized as governmental and national, those under the special supervision of the provincial or national government are classified as follows: sacred to mythical gods, 100; to emperors and members of the Royal Family, 25; to patriots and heroes, 30; to sacred swords and dragons, etc., 6. The deities worshipped by the Japanese might be roughly grouped as: (1) stellar bodies; (2) the elements of earth, air, fire, and water; (3) natural phenomena; (4) prominent natural objects, as mountains, rocks,

trees, and caverns; (5) men; (6) animals; and (7) manufactured objects.

In short, anything conspicuous or exalted may have become an object of worship. Not infrequently the people worship *kami* of which they know absolutely nothing as to nature, origin, or being. 'What god we know not, yet a god there dwells.'

It does not follow that these manifold gods have been regarded as of equal importance, nor have they all been revered by the mass of the people. According to the *Kojiki*, which for the Japanese embodies the sacred story of beginnings and of the founding of their nation, the gods of heaven are the primal, chief divinities; and it is said that Jimmu, the first Emperor, worshipped the deities of Heaven and Earth. In the opening chapters of the *Kojiki* marked distinction is given to three deities: Ame-no-minaka-nushino-mikoto (the Deity-master-of-the-august-centre-heaven), Takami-musubi-no-kami (the high-august-producing-wondrous-deity), and Kami-musubi-no-kami (the Divine-producing-wondrous-deity), who are said to have been 'born in the plain of High Heaven when the heaven and the earth began.' To them alone certain modern Shinto sects pay reverence.

Atsutane Hirata, a modern Shinto scholar (1776-1843), says:

'The object of fear and worship in foreign countries is known by several names, the Supreme Being, Sovereign Ruler, Imperial Heaven, or Heaven. He is none other than our Heavenly *Kami* who dwells in Heaven and governs all the affairs of the world.'

This clearly shows the tendency of Shinto scholars to a monotheistic belief.

G. Kato, in a monograph in *TASJ* for 1908, on 'the Chief god of Shinto,' concludes that the deity 'shows in its origin a clear trace of primitive monotheism, when viewed in the light of the modern study of the science of religion.'

It is true that a strict monotheism has never found congenial soil in Japan, yet there is not infrequently to be noticed the idea of a unitary force behind the manifold exhibitions of what are called *kami*. Moreover, the introduction of Chinese thought modified earlier Japanese conceptions; and *Shang-ti*, the Supreme Being, or *Tien*, the Heaven, of the Chinese, became identified with *Kami*, and was worshipped, often supremely, though not exclusively by many. Shuntai Dazai (1681-1747), a Chinese scholar, said:

'All the fortunes of man, whether prosperity or calamity, happiness or sorrow, are in accordance with the will of Heaven. . . . Among all so-called *Kami* there is none so lofty and mighty as Heaven.'

Belief in Heaven as the Supreme Force, the Providence over all, and the criterion of all, to whom is due allegiance to the uttermost, may be said to be universal among the Japanese, while individuals and classes reverence also in particular certain other subordinate *kami*. Among the most popular individual *kami* may be mentioned the Sun, associated with Amaterasu Omikami, as a sun-goddess, with whom is identified the prehistoric ancestress of the ruling house of Japan; Hachiman, an old-time hero; Ten-jin, a great scholar, now revered as the god of learning; Inari, the god of rice; Kompira, revered by sailors, as in Yebisu by the seekers for good luck. In recent years Emperor-worship has been advocated by not a few as a unifying substitute for vaguer religious faith.

The rendering of the English word 'God' by Jap. *Kami* is not entirely satisfactory; but, in spite of the polytheistic ideas long associated with the term, it has been in a remarkable degree filled with the content of the English word as limited in Western religious and philosophic thought. The confusion becomes daily less; and the idea of a unitary Supreme Being is now one of the first conveyed to the educated Japanese mind by the

word *Kami*. The definition of the word in modern Japanese dictionaries is significant: (1) a spirit which is thought to exist invisibly, with unlimited supernatural power of good or ill, to punish crime and reward virtue in human beings; an object of religious trust or fear; (2) the honorific name given to rulers previous to the reign of Jimmu; (3) the name applied to spirits enshrined in Shinto shrines; (4) the Christian God, the almighty and omnipresent creator and ruler; the Heavenly Ruler; (5) the spirits of the dead in Shinto funeral ceremonies; (6) that which transcends human understanding (the *Jirin* by S. Kanazawa, 1907). Or, again; (1) God; a deity; supernatural being; (2) the consecrated spirit of the dead, especially of an emperor, sage, or hero; (3) that which cannot be conceived by the human mind; a miracle (*Jap.-Eng. Dict.*, by F. Brinkley and others, 1896).

LITERATURE.—W. G. Aston, *Shinto: the Way of the Gods*, London, 1906; W. E. Griffis, *The Religions of Japan*, New York, 1896.

TASUKU HARADA.

GOD (Jewish).—Whatever had still lingered in Israel of the ancient conception of Jahweh as a territorial God (which rendered a lapse into idolatry easy whenever interest urged a prior or collateral claim of some other local god) was largely eradicated during the Exile; and after Nehemiah's time the Jews were uncompromising monotheists. This faith Judaism preserved and confessed before the world by liturgical expression, by legal observances, and by dissociation from every appearance of idolatry. The secret of its power to hold its own against an opposing world lay in the conviction that the Jewish race was the favourite of Heaven. Indeed, Israel's election is an integral part of the Jewish conception of God. The Jews are monotheist because Jahweh is monolalic. They have not chosen Him, but He chose them first.

'One God, one Israel, one Temple,' says Josephus (*c. Apion.* esp. li. 24); and in the *Amida* for Sabbath vespers every Jew repeats: 'Thou art one, Thy Name is one, who is one (unique) in the world as Thy people Israel' (*cf. Suk. 55b יחידה אחד, and 2 Es 6²⁰ 'Thy only one people'*).

1. Anthropomorphism.—The anthropomorphic expressions of the OT are linguistic relics of an age when the Hebrews attributed to Jahweh a human form and human passions (*HDB* v. 627). The Prophets retained these expressions as conscious anthropomorphisms and convenient terms to describe the personality and activity of the Deity. We doubt, however, whether the popular conception of Jahweh was other than of a gigantic warrior in human shape. The Exile brought the Jews into contact with the gross idolatry of the Babylonians; and, viewing their captivity as a punishment for disloyalty to Jahweh, they became the more averse to the gods and religion of their conquerors. The Exile became to the Jews a means of spiritual development. Jahweh ceased to be regarded as a territorial God, though the tribal conception remained. He was the God of the universe, but father of Israel—the God of Nature and revelation. Efforts began to be made to explain and remove anthropomorphisms.

The first step we read of was taken by the *Sopherim*—the early scribes and immediate successors of Ezra (I. H. Weiss, *Zur Gesch. d. jüd. Tradition*, Vienna, 1871-91, vii. xxiii.). In the Apocrypha, anthropomorphisms are used rarely and with caution. An important step was taken in the versions of the Bible. The artful manner in which the LXX softens down many anthropomorphic expressions is well known. And yet the version was viewed with distrust by the Palestinian Jews, for fear it might convey to the heathen world wrong impressions of the nature of the God of Israel. Versions in the Aramaic vernacular (see art. 'Targum,' in *HDB*) circulated orally in Pales-

tine from the days of Ezra (*Meg. 3*). Children received their first instruction in the Law in Aramaic. At the public reading of the Law a *methurgeman* (dragoman or interpreter) stood by the side of the reader, and rendered into Aramaic each verse as it was read in Hebrew. The frequent repetition must have produced in a very short time a stereotyped version, and we may safely assume that it is embodied in our editions of the Targum, and that they represent the oldest form of Judaism. In these all anthropomorphisms, with few exceptions, are paraphrased and spiritualized. Thus, *e.g.*, by the eyes and ears of God are understood His omniscience, by the hand His omnipotence, by the mouth of God His immediate communication with man, or inspiration (*e.g. Nu 12⁸*). The finger of God in *Ex 8¹⁹* is rendered 'this is a plague from before Jahweh.' Peculiar to the Targums is the use of the Memra (*g.v.*), the executive word of God. The existence of this intermediate being was deduced from passages like *Ps 33⁶*, *Is 55^{10c}*. Although not regarded as an emanation of the Deity, like Philo's Logos, the Memra was conceived as apart from God; and to it, and not to God, all anthropomorphisms and anthropopathisms were ascribed.

Turning to the Rabbinic literature, we find that anthropomorphisms were removed in several ways. (a) The particle *כאלו*, 'as it were,' or *כאלוּ*, 'as though it were possible,' was placed before anthropomorphic assertions. (b) Such appearances and actions as seemed inconsistent with an absolute Deity were attributed to intermediate beings and to angels. (c) Convenient explanations got rid of many anthropomorphisms. Thus 'a jealous God' (*Ex 20⁵*) is explained in the *Mechilta* as 'the God who rules over jealousy.' The same Midrash comments on *Ex 12¹³*:

'Is not everything revealed before Him? Why then does He say, "When I shall see the blood"? Ans. "As a reward for executing My command I will reveal myself and protect them."'

In the same section it is asserted that anthropomorphisms are used *לשון נסתר*, 'to sink it into the ear,' *i.e.* to assist a person's perception. R. Judah said: 'Bold, indeed, were the Prophets to liken the Creator to the creature' (*Gen. R. 27¹*; see also *Pesikta*, 36b). Another Rabbi went so far as to deny that the Shekhinah ever descended on earth, or that Moses or Elijah ever went up to heaven (*Suk. 5*; *Mechilta Jethro*, 4).

When we turn to the Rabbinic writings from about the 3rd cent. A.D. onwards, however, we meet with gross anthropomorphisms. There is no special event in Jewish history to which we should ascribe the reaction. No doubt Essenism, the fertile imagination of Alexandrianism, the cessation of the sacrificial cult, the rise and progress of Christianity, with its offshoots of speculative Gnostics, directly and indirectly influenced the Rabbis in favour of mysticism. But the reaction was rather the gradual outcome of legalism, according to which Israel's sole mission in the world was to keep the Divine Law. Israel's election was never lost sight of since the Exile, and ultimately developed a Judaized conception of God. The Halakha laid the foundation, and the superstructure was raised by the Haggada. The latter, originally with a few traditions in stock more or less based on facts or curiously deduced from them, might have been a good handmaid of homiletics, but in time it mounted the heights of imagination and spake of everything. It not only wrote human history as it ought or ought not to have happened, but explored the seven heavens and revealed the Deity.

Putting together the passages from the Talmud and Midrashim, we find in plain prose that on the highest heaven is the throne of Glory, on the back of which is engraved the image

of Jacob (*Targ. Jon. Gn 28¹⁵*). Metatron is close to the Deity. A *Ma'at*, a consultative body, assists God in government (*Jerus. Ber. ix. 5*). Satan accuses Israel, and Michael silences him by recounting their merits (*Ez. R. 18*). On God's seal is engraved *אמת*, 'truth,' the first, middle, and last letters of the Hebrew alphabet, indicating that He was, is, and is to be (*Shab. 64; Cant. R.*). In the heavenly Jerusalem there is an altar on which Michael offers up the souls of the righteous (*Hag. 13*). Behind the throne stands Sandalphon, whose height is a distance of a walk of 500 years, and who binds chaplets for the Deity (*ib. 13*). God is occupied with studying the 24 books of the Bible by day, and the six *sedarim* of the Mishna by night (*Targ. Cant. v. 10*). There are schools in heaven after the Rabbinic model, where Rabbis in their order discuss the Halakha, and God studies with them (*Bab. Meg. 86*). Every day He promulgates a new Halakha (*Gen. R. 49*). He wears phylacteries (*Ber. 6*), of which Moses saw the knot (*ib. 7*). At the Exodus from Egypt every servant girl saw God bodily and could point Him out with her finger. When God descended on Sinai, He was wrapped in the Rabbinic *talith* (*R. Hash. 17*). He has His own synagogue. He prays to Himself that His mercy should overcome His wrath (*Ber. 7*). He weeps daily over Jerusalem (*ib. 69*). The last three hours of the day He sports with Leviathan (*Ab. zara, 8*).

A more hideous form of anthropomorphism meets us in the period of the *Gaonim* (7th-10th cent.). The success of Muhammadanism, with its disastrous effect on the Eastern Jews, revived Messianic hopes. Several false Messiahs appeared. Old traditions about the nature of the Messiah were searched out. Mysticism, which hitherto lurked only in dark corners, crawled to the light. The study of the Talmud was neglected in favour of this new theosophy. The experts were called *ba'dle 'emanoth*, 'men of faith,' who by means of charms and the recitation of senseless formulæ worked miracles, healed the sick, assuaged the raging sea, and revealed the secrets of the Deity. The most monstrous book of this period was the *Shi'ur Koma*, 'Estimation of the Height,' of which we possess only two fragments—a greater one in the book of *Raziel*, and a lesser in the Alphabet of R. Akiba. In it the Deity is described as a huge being in human shape and out of all proportion. The measurement of each member, such as the neck, the beard, the right and left eyes, the upper and lower lips, the ankles, etc., is given in parasangs.

Only 'those parasangs are not like ours, for a heavenly parasang measures a million cubits, each cubit four spans, and each span reaches from one end of the world to the other.' 'And,' says the book of *Raziel*, 'blessed is he who knows these measurements, for he has a share in the world to come.'

The Karaites were the first to ridicule the *Shi'ur Koma*. The most learned orthodox Jews also, among whom were the Gaonim Saadya, Sherira, and Hai, vigorously opposed mystic anthropomorphism. But Maimonides gave the most effectual blow. In his *More Nebuchim* he asserts in philosophic language the spirituality of God, and explains the Biblical anthropomorphisms as figurative terms.

2. The names of God.—Evidence of a transition to a new conception of God after the Exile is found in the manner in which God is spoken of. (1) The covenant name Jahweh, originally a proper name necessary in polytheistic and henotheistic periods to distinguish Him from other gods, gradually vanished from the consciousness of the people as a personal name of the Deity, until, at the time of the Christian era (and probably considerably earlier) it was entirely forgotten. *Gen. R. 33* states that, whenever *Jahweh* is used, it signifies God in His attribute of mercy, while *Elohim* stands for His attribute of judgment (see also *Ez. R. 3*). To guard against an irreverent use of the sacred name the laity ceased to pronounce it. Only the priests at the benediction, and, after the death of Simon the Just, only the high priest, and he with bated breath, so as to render it inaudible even to his colleagues, pronounced the 'unutterable' name. The correct pronunciation of the name was delivered only to the pious and humble (*Kid. 71a*). According to Philo (*Vita Mos. iii. 14*),

it was breathed by holy lips into holy ears in a holy place.¹ The cruel death which R. Hanina b. Teradion suffered in the Hadrian persecution was accounted for as a punishment for pronouncing the name (*Ab. zara, 18a*). A *קיני* (*kinui*), or substituted word, was used, the oldest of which was probably *שם*, 'the name.' The Samaritans still use *שם* except when, in taking an oath, they pronounce the tetragrammaton *Yawe*. The name is sometimes spoken of as *שם המיוחד* (*Sanh. 60*), 'the distinguished or proper name,' and more frequently *שם המפורש*, 'the name pronounced' (in the Temple). It is also called *אזכרה*, 'remembrance,' 'mention' (*Cant. R. ii. 4*); 'the name of four letters' (*Kid. 71*); 'the great name' (*Onk. Targ.*); 'the great and precious name' (*Jerus. Targ.*); 'the great and holy name' (*Targ. on Ps 47⁴*); in post-Talmudic writings 'the name' *הוי"ה*; and in the mediæval philosophers we find *השם העצום*, 'the proper, the great, the wonderful, the hidden, the excellent name, the written-but-not-read name.' In the later Halakha all the names of God are styled *שמות*. But the usual substitute is *Adonai* (the plural form of *Adon*), *אדני*, the pointing of which is supplied to the tetragrammaton as a *memoria technica* (*Kid. 71*). The LXX renders *Jahweh* by *δ κύριος*, or the anarthrous *Κύριος*. This, without a proper name to follow, must have been the origin of the charge of *atheōtēs* laid to the Jews of the Diaspora.

Adonai came to be styled the chief of the *kinuim*, and was invested with an awe similar almost to the name *Jahweh*. 'Abraham called God *Adon*' (*Ber. 7*), and taught Him as such to mankind (*Soḥ. 10*).

The name *El Elyon* or *Elyon*, 'Most High,' originally with a relative meaning, used in the OT by non-Jews, and in the Psalms absolutely of *Jahweh*, came into more frequent use after the Exile (G. Dalman, *Die Worte Jesu*, Leipzig, 1898, p. 162). H. J. Holtzmann sees in the revival of this name a transition to an abstract conception of the Deity (*Lehrb. der neutest. Theol.*, Tübingen, 1896-97, i. 49). The official title of the Hasmonæan princes seems to have been 'high priests of El Elyon.' *Rosh. Hash. 18b* records that, after the victory of the Maccabæans, it was ordained that in dates of documents the name *El Elyon* should be added after the reigning high priest's name. The practice did not please the wise men, because of the irreverence to the Divine name when the documents are rendered useless and thrown away. It was accordingly abolished, and the day and its anniversary were observed as a festival. *El Elyon*, though occurring in the liturgy (e.g. first petition of the *Amida*), is seldom met with in the Talmudic literature.

Analogous to this conception of God as having His residence in the most elevated spot of the universe is 'Heaven' (*שמים*). That this term frequently stands for 'God' in the Talmudic literature, but never in the liturgies, indicates that it was a popular appellation borrowed from surrounding phraseology. Ahura Mazda was the ancient god of the vault of heaven. *Bel-Shamin*, 'the Bel of Heaven,' was worshipped throughout Syria, like *Zeus Ouranios* and *Caelus* in the Roman Empire.

The Divine Majesty, conceived as located in a special region in the heavens, was called *קדום*, 'the place' (e.g. *הקדום יהיה בעוורו*, 'God help him' [*Nidd. 49b*]; *ברוך הקדום*, 'blessed be God' [*Ab. zara, 40*, and in the liturgies]; cf. response in the *קריעה*, 'Blessed be *Jahweh* from His place,' *Ezk 3¹³*). From Palestinian usage and not *vice versa*, Philo took his *τόπος*, although Philo's idea made its way back

¹ Josephus already makes a mystery of the tetragrammaton (*Ant. ii. xii. 4*).

into the Talmudic literature, e.g. 'Why do they call the Holy One, blessed be He, *אֱלֹהִים*?' Because He is the place for the world, and not the world His place (*Pesik. R.* 21).

The usual expression by which God is spoken of is 'the Holy One,' with the doxological addition, 'Blessed be He.'

(2) *God as 'King.'*—The practice of uttering a benediction on various occasions is probably in imitation of Zoroastrianism. Copies of these benedictions were current in the Tanaïtic period (*Shab.* 115b). Their composition and institution are traced back to the 'Men of the Great Synagogue' (*Ber.* 33). Every such benediction is invalid unless it contains *אֱלֹהִים* and *מַלְכוּת*, i.e. the name of God and acknowledgment of His Sovereignty.¹ Likewise the response of the laity in the temple when the high priest uttered the tetragrammaton was, 'Blessed be the name of the Glory of His Kingdom.' It is also the response after the *Sh'ma*. As King, God is repeatedly confessed and invoked in the Prayer-book. The phraseology is borrowed from the OT, but the model is not the Hebrew king, to whom the humblest of subjects can have access, but, as Holtzmann insists (*NTZG* 364), the Persian monarch. The 'Great King' lives in solemn seclusion from his subjects. Only the favoured few may see his face. Access to him without his grace is punished with death. Officials execute his will. Often he is not the author of his edicts, but government is carried on by his consent before him rather than through him. Books of remembrance are kept. Analogous to this is the Jewish conception of the court of heaven. God is transcendent. No one has seen His face at any time. 'To Moses He only showed the knot of His phylacteries (resting on His back)' (*Ber.* 7a). He is surrounded by angelic hosts in military array, who execute His will. Around His immediate presence are the Princes of the Countenance, of whom Suriel is one (*Ber.* 51); and so is Metatron (*Sanh.* 38). The latter is also called the Prince of the World (*Yeb.* 16b; *Hal.* 60a), and enters the deeds of men in a book (*Hag.* 15). The seventy nations have each a representative in the court of heaven, of whom the greatest is Michael (*Yom.* 36). The forces of Nature are presided over by viceroys. Rahab is the Prince of the Sea (*Baba bathra.* 74), Yurkami the Prince of Hail (*Pes.* 118), Dumah the angel of Spirits (*Baba bathra.* 94), and Lailah the angel of conception (*Nid.* 15). The angels intercede for men; and, as they know only Hebrew, prayers should not be said in Aramaic. Sandalphon presents the petitions to God (*Hag.* 13). Elijah is a kind of Mercury, making known God's plans to the pious and sometimes solving their doubts (*Ber.* 3; *Pes.* 70). He travels from city to city (*Baba kamma.* 60), is a frequent visitant among the Rabbis (*Sanh.* 113), is familiarly known as 'that aged man' (*Hul.* 6), and assumes various shapes in accordance with the commission with which he is entrusted (*Ber.* 6; *Ab. zara.* 77, etc.). God's statute book is the Law, which existed before creation, according to which He created, governs, and finally will judge the world. To keep this Law, and to sacrifice to Him at Jerusalem, God chose to Himself the Jewish race. Hence a right standing before God is procured by adherence to the Law. Judaism is not a faith but a system of observance, the obedience of a slave to his master. The very word in late Hebrew for 'religion,' *חַיִּים* (occurring only in Esther), is borrowed from Old Persian and signifies 'law' (*Oxf. Heb. Lex.* s.v.). Forensic knowledge itself is a piece of piety. The *חַיִּים*, or he who understands how to apply to and fulfil the Law under all circumstances, is

¹ The formula is, 'Blessed art thou, Jahweh our God, King of the universe, who,' etc.

accounted of higher merit than even an illiterate high priest. It was a saying of the 'gentle' Hillel: 'An empty-headed man cannot be a sin-fearing man, nor can an ignorant person be pious' (*Pirke Aboth.* ii. 6).

(3) *God as 'Father.'*—Sometimes the epithet 'Father' precedes the word 'King,' as in the '*Abinu Malkenu*, four verses of which were known and used by Rabbi Akiba, or in a parallelism, as in the sixth petition of the '*Amida*: 'Forgive us, O our Father, for we have sinned; pardon us, O our King, for we have transgressed.' 'Our Father, who art in Heaven,' is frequently used in the Mishna (*Yoma.* viii. 9; *Sota.* ix. 15), and in the Liturgy. The appellation, however, signifies nothing more than that Israel is God's property.

'To a deeper penetration into the essence of God as Love it never led in Jewish theology' (F. Weber, *Jüdische Theologie*, Leipzig, 1897, p. 154). 'The address of God as Father gives one the impression of a lost word in a strange world. The manner in which Jesus imparted intensity and depth to the spiritual life from the faith in a Father-God, such as in the Parable of the Prodigal Son, or when speaking of the birds under heaven, is peculiar to Him' (W. Bousset, *Relig. des Judentums*, Berlin, 1906, p. 434).

(4) *God as 'Creator.'*—To the contact of Judaism with Mazdaism under Persian rule is probably due the institution of the *Yōšēr*, in which universal creation is ascribed to God, with which the second part or morning prayer proper commences. Its original form consisted probably of *Is* 45^{7a}, in which God is styled 'Former,' 'Creator,' 'Maker.' A later epithet, savouring of polemics against Gnosticism, is 'He-who-spoke-and-the-world-came-into-being.' It occurs in *Siphre* on *Dt* 11²² 'Wilt thou know Him who, etc., study the Haggada'; and frequently in the Talmud, and is the invocation in the collect of the first half of morning prayer. In the various phenomena of Nature the Jew saw the operations of the Creator and the 'King of the Universe,' and uttered a blessing. Not only is there an elaborate grace after each substantial meal, but different blessings (many of which are referred to in the Mishna as known) on every conceivable occasion, such as at the partaking of wine, of water, of fruit; at the scent of spices, of fruit trees, of precious ointment; in a storm; at the sight of lightning, of the rainbow, of the sea, of spring-buds, of a king, of a wise man, of a monstrosity.

Fine, indeed, are the very few sentiments of the Rabbis on Divine immanence.

R. Hanina said: 'Sometimes the Universe and the fullness thereof cannot contain the glory of His Deity, and sometimes He converses with man through the hair of his head' (*Gen. R.* 4). To R. Yosi is attributed a dispute with a lady who was a serpent-worshipper. When she maintained that her god was the greater because Moses at the sight of the burning bush hid his face (*Ex* 3⁶) but from the serpent he fled (*4²*), the Rabbi replied that in two or three steps he could escape from the serpent, but from God nowhere (*Sam. R.* 8). 'As no one knows where the soul is situated in the human body, so no creature knows the exact place of the Holy One, blessed be He; not even the Holy Beasts who carry the Throne of glory know it' (*Midr. Shochar Tob.* 108).

(5) Peculiar to post-Biblical addresses to God is a lengthy enumeration of His attributes. Yet R. Hanina silenced a reader for saying 'O God, the Great, the Strong, the Awful, the Mighty, the Powerful, the Bold,' it being as derogatory to the Deity as praising a millionaire for possessing only a hundred thousand (*Meg.* 25a).

The tendency was to avoid the use of the name of God altogether. Already the Book of Esther, which records a providential deliverance of the chosen race, does not contain it, but only once alludes to it (*4¹⁴*). A similar reserve is observed in the first Book of Maccabees, where 'Heaven,' rarely 'Lord,' is substituted for 'God.' This is the more remarkable in a book of Sadducean authorship (Holtzmann, 363). In the Rabbinic literature the usual surrogates are one of the above-mentioned epithets or an attribute. Some-

times the third person plural is used, e.g. 'Who-soever has pity on mankind, they show pity on him from heaven' (*Shab.* 151a).

Of the use of a Divine name in exclamations we know of only one instance in the Talmud: 'Lord of Abraham!' (*Keth.* 1).

3. The solity of God.—A God who is Creator and absolute Monarch of the universe can have no rival. Jewish monotheism, therefore, denotes belief in the existence of one God, and connotes denial of Divine attributes to any other being. This the Jew has confessed by creed and conduct since post-exilic times: the former by the double, daily recitation of the *Shema*, Dt 6⁴ 'Hear, O Israel, Jahweh our God is One Jahweh'; the latter by repudiation of the remotest approach to idolatry. It is, however, incorrect to speak of 'faith' in Judaism, which is a religion of mere observance. The Hebrew *אמון* does not signify an active principle, but is only an expression for strong confidence in God's help, a reliance on His faithfulness, His willingness to answer prayer, and the like (see art. 'Faith,' in *HDB* and *EB*). Sirach still uses *πίστις* in this sense (2¹⁰ 11²¹ 40¹²). It was applied also as trust in the saving power of the Divine precepts (Ps 119⁶⁸; cf. Dn 6²²).

The persecution of Judaism under Antiochus Epiphanes produced martyrs and confessors of faith. *אמנה* came to stand for 'knowledge of Jahweh' and trust in Him, based not only on Israel's election, but also on individual conviction. To become a believer meant to be converted to a form of religion (Jth 14¹⁰). To be a believer involved adherence to the essentials of that religion and steadfastness under persecution (Enoch 61⁴ 63²², He 11). It is possible that in this period was instituted the morning and evening recitation of the *Shema* as a confession of faith. That it was so used in early pre-Christian times is attested by Josephus (*Ant.* iv. viii. 13), to whom the practice seemed so ancient that he ascribed it to Moses. It formed part of the Temple liturgy (*Tam.* v. i.). In the Mishna and the early Midrashim the recitation of the *Shema* is styled 'taking upon oneself the yoke of the Kingdom of Heaven' (*קבלה על סלכות שמים*).

'A traveller who recites the *Shema* walking must halt when he takes upon himself the yoke of the Kingdom of Heaven. Which is the Kingdom of Heaven? The Lord our God is one Lord' (*Deut. Rab.* 6⁴).

Women, slaves, and children are exempt from reciting it (*Ber.* iii. 3), which indicates its use as a confession of faith such as an adult and a responsible member of the race could make. It is not surprising that the Rabbis made much of the *Shema*. Minute directions are given about the time, the posture, and manner of its recitation. It must be read with the utmost exactness. A slight pause must be made between words separated by dittographical letters, such as *בכל לבנך*. The first verse is read louder and with greater emphasis on the last word, *אמר*, and with 'intention' that God is ruling above, below, and in all the four corners of heaven. Hence the *Shema* is sometimes spoken of as *יכילך ר'*, 'to cause God to reign.' The omission of the 'intention' would frustrate the process and require a repetition of the *Shema*. After the first verse the *gloria* is said *sotto voce*: 'Blessed be the name of the glory of his kingdom for ever and ever.'

'The Gehenna will be cooled for him who recites the *Shema* carefully' (*Ber.* 15). 'Greater is he who recites the *Shema* in season than he who is occupied in the study of the Law' (*ib.* 10). 'He is worthy that Shekhina should rest on him' (*ib.* 57), and 'is sure of a share in the world to come' (*Shab.* 119). It is accepted by God in the place of the daily sacrifice (*Siphre* on Dt 6⁵). The omission of the Ten Commandments from the daily liturgy is ingeniously explained by R. Simeon on the ground that they are not needed because they are contained in the *Shema* (*Jerus. Ber.* 1). A further recitation of one

Shema arms one with a two-edged sword against demons (*Ber.* 5). In sudden fear of an apparition, let him say the *Shema* (*Meg.* 8). It is inscribed on the door-post of every habitable room and saluted reverently. It forms one of the texts encased in the phylacteries. It is the first spiritual lesson a Jewish child should be taught (*Suk.* 42) and the last words uttered by, or breathed into the ear of, the dying. R. Akiba, expiring under torture, breathed his last while accentuating the word *one* (*Ber.* 61). Many a time has it sounded from amidst the burning crosses of an *auto da fé*.

To the mystics the confession of the Divine Unity in the *Shema* was fraught with meaning.

To quote one instance from Abudarham (c. 1350), a commentator on the liturgies, *שמו כרום* is an acrostic for: *שחרית בנחה ערביים*, 'Lift up your eyes to heaven.' When? *שחרית בנחה ערביים*, 'Morning, evening, and vesper.' To whom? *שמי כולך*, 'The Almighty, the Most High King.' Doing so one takes upon himself *עול סלכות שמים*, 'The yoke of the Kingdom of heaven.'

The Divine Unity insisted on in the *Shema* is re-echoed throughout the Jewish liturgy. Every office ends with the *Alenu*, which is a repudiation of idolatry and an acknowledgment of the Divine Unity and Sovereignty.

The prayer is ascribed by Zunz to Rab (c. 230), against Mendelssohn, who places its origin at a much earlier date. Its triple daily recitation dates from the Middle Ages. Whether it was intended to be used as a protest against Christianity or not (see *JE*, art. 'Alenu'), it is less damnatory than the prayer against the Minim composed by Samuel the Wool-merchant (see Schürer, *GJV* ii. 463). The *Min* is distinguished from a Gentile and Samaritan. He quotes Scripture, but believes in a plurality in the Godhead. He is, therefore, originally a Jew, and can be no one else but a Hebrew Christian. M. Friedländer, in his *Relig. Bewegungen* (Berlin, 1905), has failed to convince any one that the *Minim* did not include Hebrew Christians. The petition is for their utter destruction (for text of the *Amida*, see Dalman, *Worte Jesu*, 299-304). Simeon b. Yochai, also a disciple of Gamaliel II. and contemporary of Samuel the Wool-merchant, says: 'Whosoever couples with the name of God any other thing is exterminated from the world' (*Sanh.* 68). The point at issue between the Rabbis and the *Minim* was the Divine Unity (see Weber², 152f.; and J. Bergmann, *Jüd. Apologetik*, Berlin, 1908, p. 81ff.).

The spread of Greek philosophy, through Arabic culture, in the Middle Ages encouraged many Rabbis to devote themselves to the new learning. Foremost among them was the Gaon Saadya (892-942). In his book, better known by the Hebrew title, *Emunoth W'deoth*, he proves the Divine Unity. In ii. 5 he attacks the doctrine of the Trinity, addressing himself not to the vulgar, but to those whose faith is supported by speculative knowledge. He was followed by other Rabbis, who were influenced by Aristotelian philosophy and wrote philosophical treatises on traditional monotheism, such as Bahya (1270-1340) in his *Choboth Ha-l'baboth*, ch. vii., Chasdai Crescas (1340-1410) in his *Or Yahweh*, Joseph Albo (1380-1444) in *Ikkarim*, the Great Maimonides both in his *Yad* (*Yesode Ha-torah*, i. 6, 7) and in the *Moreh*. But, whatever the value of their labours, they had not materially altered the Rabbinico-liturgical conception of God. Maimonides, in imitation of Muhammadan and Christian confessions, formulated a Creed in his commentary on the Mishna. It consists of thirteen essentials of the faith, each commencing 'I believe with perfect faith.' The second asserts that 'the Creator, blessed be His name, is a unity' (*יהוה יחיד*; *solus*), and that 'there is no unity (*יהוה יחיד*) in any manner like unto His,' etc. The Creed has never been favourably accepted; and, although it is printed in some prayer-books, it is never recited publicly. But it was versified in the *Yigdal* and the *Adon Olam*, with which the introductory part of morning prayer begins. The two poems are also read in the death-chamber before life is extinct.

As a system of observances restricted to a race, Judaism demanded of every member a confession of its faith not so much in words as in conduct, consisting in conforming to the requirements of that system positively and negatively. The former was called *Kiddush ha-Shem*, 'the hallowing of God's name'; the latter, the avoidance of *Hillul*

ha-Shem, 'profanation of God's name.' God's name is hallowed when His elect keep His precepts. No distinction, however, is made between moral and ceremonial precepts. The prayer in the *Kaddish*, which runs,

'Magnified and hallowed be the Great Name in the world which He has created according to His Will, and may He establish His Kingdom,' etc.,

would imply that it is a prayer for the conversion of the world to legalism. To hallow God's Name stood for keeping any commandment in the face of opposition (see, e.g., *Ber.* 20, and *Rashi*). To transgress the Law, however, when under compulsion, was considered permissible except in the case of idolatry, murder, and incest (*Sanh.* 74). *Kiddush ha-Shem* came to stand for confessing Judaism by martyrdom. The negative side of this precept is *Hillul ha-Shem*. The name of God is profaned or blasphemed among the Gentiles when the Jew exhibits in conduct a lower standard of morality than what the Law prescribes, or does or omits to observe anything that will bring Judaism into ill repute. But the act must be a public one.

'When one perceives that his evil passion has the better of him, let him go where he is unknown, disguise himself, and do what his heart desires rather than profane the Name of God in public' (*Kid.* 40). 'Whoever has no regard to the honour of his Creator—it were better for him not to have come into the world' (*ib.*). On the other hand, R. Jochanan b. Beroqah said: 'Whoever profanes the Name of God in secret will suffer the penalty for it in public' (*Ab.* iv. 5).

Thus the central point of Judaism was Law. A knowledge of God and keeping commandments were convertible terms. Rabbinic legalism was finally codified in the *Turim*. Ponderous are the commentaries and super-commentaries of the Rabbis on that code, to carry out which involved utter dissociation from non-Jewish elements. This isolation rather than his faith was the exciting cause of many a persecution of the Jew. Heinrich Heine well said that Judaism was not a religion but a misfortune. The emancipation of the Jews in many lands was also an incentive to them to have access to the fund of historical and philosophical knowledge accumulated by Christians through centuries. But the new status and new learning produced a rocking and upheaval in the Jewish camp. On the one hand, Rabbinism is fast dying out. The misanthropic code of the *Turim* cannot be carried out by citizens of enlightened countries. On the other hand, no other system can save Judaism from dissolution.

LITERATURE.—Art. 'God,' in *HDB*, *PRE³*, Hamburger, and *JE*, and literature given there; also S. Bernfeld, *Da'ath Elohim*, Warsaw, 1897; N. Krochmal, *Mors Nebuché Ha-zman*, Warsaw, 1894; Morris Joseph, *Judaism as Creed and Life*, London, 1910, pp. 40-71.

A. E. SUFFRIN.

GOD (Muslim).—1. The name for 'God' in common use amongst Muhammadans is *Allāh*, a word which, according to their theologians, denotes a 'Being who exists necessarily by Himself, comprising all the attributes of perfection' (cf., further, 'Arabian, pre-Islāmic' section of this art.). Another Qur'anic word is *ar-Rabb*, 'the Lord.' There are also many names which express the various attributes of God. These are called the *Asmā' aṣ-Ṣifāt*, names of qualities in contradistinction to the *Ism adh-dhāt* (*Allāh*), the name of the essence of God.

It is said that, when Muhammad and his Companions addressed God as *ar-Rahmān*, 'the Merciful,' Abū Jahl said: 'Muhammad and his Companions bid us worship one God, why, then, do they call upon another God?' On this the following verse was revealed: 'Most excellent titles hath God; by these call upon Him, and stand aloof from those who pervert His titles' (*Qur.* vii. 179). Those who perverted His titles were the pagan Arabs who were alleged to derive the names of their idols from names of God, as

al-Lāt from *Allāh*, *al-Uzzā* from *al-'Azīz*, 'the Mighty' (cf. *Qur.* liii. 19), which is now considered a grievous sin, and even infidelity.

In a much earlier Sūra also, in a verse which emphasizes the unity of God, these names are referred to, as if to show that their existence did not impair the idea of unity: 'There is no God but He: His are the excellent titles [*Asmā' al-ḥusnā*]' (*xx.* 7). Again, a tradition recorded by Abū Huraira states that Muhammad said: 'Verily there are ninety-nine names of God, and whosoever recites them shall enter Paradise.' These names all express some quality of God, and are such as *ar-Rahmān*, 'the Merciful'; *al-Khāliq*, 'the Creator'; *al-Ḥalīm*, 'the Clement'; *al-Jalīl*, 'the Majestic'; *al-Hādī*, 'the Guide,' etc. (see full list in Hughes' *DI*, p. 141). The reason given for this large number is that God may always be addressed by a name suited to the need of His petitioner. Thus, if a man confesses sin, he calls on God as *al-Ghaffār*, 'the Forgiving,' or *al-Tawwāb*, 'the Acceptor of repentance'; is he in need of bodily sustenance, he prays to *ar-Razzāq*, 'the Provider'; is he in doubt as to a course of action, he addresses God as *ar-Rashīd*, 'the Director,' etc. To assist in the repetition of these names, a rosary of one hundred beads is used. The Wahhābites, however, use their fingers, believing that to have been the custom of Muhammad. The name *Allāh* is recited first or last to make up the hundred.

All Muhammadans agree that such names as 'the Living,' 'the Wise,' 'the Powerful,' can be applied to God, but they must be *tauqīfī*, i.e. authorized in some revelation—Qur'ān or tradition; e.g. God can be called *ash-Shāfī*, 'the Healer,' but He cannot be called *at-Ṭabīb*, 'the Physician,' because that word is not applied to Him either in the Qur'ān or by Muhammad. Some authorities are less strict and say that, though the exact word may not have been so applied, yet, if an attribute of the Deity has been praised, an adjective expressive of that attribute can be used; but, if names not so given are used of Him, such use must be looked upon as expressive only of His attributes and not of His nature. Such a term is *Musabbib al-ʿasbāb*, 'the Causer of causes.' To the Persian word *Khudā* objection also has been taken; but, as it means 'one who exists in himself,' it is equivalent to the Arabic title *Wājib al-wujūd*, 'one who has necessary existence,' and, therefore, may be used. Of names taken from a language of the infidels, such as 'God,' 'Dieu,' 'Gott,' the general opinion is that they ought not to be used at all.

Among the many names of God is the *Ism al-A'zam*, 'the exalted name.' According to one tradition, it occurs in *Qur.* ii. 158 and iii. 1. The names there are *ar-Rahmān*, 'the Merciful,' *al-Qayyūm*, 'the Self-subsistent,' and *al-Hayy*, 'the Living'; but, according to 'Ā'isha, the *Ism al-A'zam* is known only to prophets and saints. As it is believed that those who call upon God by this name will obtain all they desire, Ṣūfīs and dervishes profess to spend much time in the search for it, and, when they claim to have found it, they gain great influence over the common people. The desire to attain this knowledge has been a powerful incentive to enter on the long novitiate and discipline of the Dervish Orders.

2. The doctrine of God may be considered with reference to His essence, His attributes, and His works.

(a) Muhammad laid great stress on the Divine unity. His creed, 'There is no god but God,' contains the negation of false gods and the affirmation of the unity of the one true God. The principal passages in the Qur'ān referring to this are:

'Say: "He is God alone; God the eternal; He begetteth not, and He is not begotten; And there is none like unto Him"' (*cxli.* 1-4). 'Truly your God is but one; Lord of the heavens and of the earth' (*xxxvii.* 4 f.). 'God, there is no God but He; most excellent His titles' (*xx.* 7). 'This is God your Lord; there is no God but He, the Creator of all things; therefore, worship Him alone' (*vi.* 102). In a Medina Sūra, a verse which is probably Meccan occurs: 'Your God is one God; there is no God but He, the Compassionate, the Merciful' (*ii.* 158). In the same Sūra (*ii.* 256) we have one of the most beautiful passages in the Qur'ān, the 'verse of the throne': 'God, there is no God but He, the Living, the Eternal; nor slumber seizeth Him, nor sleep; His, whatsoever is in the heavens and whatsoever is in the earth, who is he that can intercede with Him but by His own permission? He knoweth what hath been before them and

what shall be after them; yet nought of His knowledge shall they grasp, save what He willeth. His throne reacheth over the heavens and the earth, and the upholding of both burdeneth Him not; and He is the High, the Great. 'There is no God but He, the Living, the Merciful.' 'There is no God but He, the Mighty, the Wise' (iii. 1 and 4).

This strong conception of the unity of God led Muhammad to denounce what he considered to be the Christian doctrine of the Trinity. At Medina, when all hope of winning the Christians to his side had passed away, he thus appealed to them:

'O ye people of the Book, overstep not bounds in your religion: and of God speak only truth. The Messiah, Jesus son of Mary, is only an apostle of God and His word, which He conveyed into Mary and a spirit proceeding from Him. Believe, therefore, in God and His apostles, and say not, "Three"; forbear; it will be better for you. God is only one God. Far be it from His glory that He should have a son' (iv. 169).

In the last Sūra revealed we read: 'They surely are infidels who say, "God is a third of three," for there is no God but one God' (v. 77). 'And when God shall say: "O Jesus, son of Mary, hast thou said unto mankind, Take me and my mother as two Gods beside God?" He shall say: "Glory be unto Thee; it is not for me to say that which I know to be not the truth"' (v. 116).

Muhammad's idea was that the Christian Trinity consisted of God, Mary, and Jesus. He considered the Holy Spirit to be Gabriel, and, accordingly, not a person in the Trinity.

From a Muslim philosophic point of view, as nothing exists without a cause, it must be assumed that there is a Being, the first cause of all things, existing of necessity and self-sufficing. This Being must be one, and one only. This unity, or *tawhīd*, is said to be either *tawhīd ar-rubūbiya* or *tawhīd al-'ulūhiya*. The former means that God creates and sustains all things, but belief in this does not necessarily make a man a believer; belief in the latter does, for he who accepts it worships the one God only.

(b) Muslim theologians divide their definitions of God under the seven attributes of Life (*hayāh*), Knowledge (*ilm*), Power, (*qudra*), Will (*irāda*), Hearing (*sam'*), Seeing (*baṣar*), and Speech (*kalām*).

Life.—God has neither associate nor equal. 'Had there been in either heaven or earth gods beside God, both surely had gone to ruin' (xxi. 22). He is immutable, invisible, without figure, form, colour, or parts. His existence has neither beginning nor end. He is not a body composed of substances or elements. He is not an accident inherent in a body or dwelling in a place.

Knowledge.—God knows all things, whether in the present, past, or future, whether hidden or manifest, whether in heaven or on earth. He knows the thoughts of the heart of man, and the words which proceed from his mouth. He is free from forgetfulness, negligence, and error. His knowledge is eternal; it is not posterior to His essence. 'Dost thou not see that God knoweth all things that are in the heavens and all that is on the earth' (lviii. 8). 'With Him are the keys of the secret things; none knoweth them but He: He knoweth whatever is on the land and in the sea; and no leaf falleth but He knoweth it; neither is there a grain in the darkness of the earth, nor a thing green or sere, but it is noted in a distinct writing' (vi. 59).

Power.—God is almighty. He can raise the dead, make stones talk, trees walk, annihilate the heavens and the earth, and recreate them. His power is eternal *a priori* and *a posteriori*. It is not posterior to His essence. 'Is He not powerful enough to quicken the dead?' (lxxv. 35). 'If God pleased, of their ears and of their eyes would He surely deprive them' (ii. 19). 'God hath power over all things' (iii. 169).

Will.—God can do what He wills, and whatever He wills comes to pass. His will comprises everything possible, whether good or evil. He wills the faith of the believer and the unbelief of the infidel. His will is eternal, and is not posterior to His essence. 'God is worker of that He willeth' (lxxxv. 16). 'God misleadeth whom He will, and whom He will He guideth.' 'God doeth His pleasure' (xiv. 4, 32). 'If God pleased, He would surely bring them, one and all, to guidance' (vi. 35).

Hearing.—God hears all sounds without an ear, for His attributes are not like those of a man. 'He truly heareth and knoweth all things' (xliv. 5).

Seeing.—God sees all things, however small, yet He has no eye as men have. 'No vision taketh Him in, but He taketh in all vision' (vi. 103).

Speech.—God speaks, but not with a tongue as men do. Speech, the word of God, is one; but it has various modes, as command, prohibition, promises, and threats. To some of His servants He speaks directly, as He did to Moses on the Mount and to Muhammad on the night of the Ascension to heaven. To others He speaks by the instrumentality of Gabriel. This is the way He speaks to the Prophets. The Qur'ān is the speech (*kalām*) of God, and is therefore eternal.

There is agreement as to the number of the attributes, but not as to their nature and the

extent of the knowledge concerning them to which men can attain. The differences with regard to the mode of their existence and operation may be brought under three heads: the ancient Šifārite doctrine that the attributes are eternal and of the essence of God, the Mu'tazilite theory that they are not eternal, and the Ash'arite dogma that they are eternal but distinct from His essence. The first four of the attributes are called 'essential,' for without them the others could not exist. They can have no opposite in God. Thus, death, the opposite of life, cannot be predicated of God; life in Him is an essential attribute. They are also called *ṣifāt ath-thubūtiya*, affirmative attributes, the privation of which would imply loss; there are also *ṣifāt as-salbīya*, or privative attributes, such as that God has no form, no equal, is not limited by place, etc. Some difficulty has arisen over the expressions 'sitting,' 'rising,' 'descending,' and the references to face, hands, eyes, for, being connected with the idea of corporeal existence, these actions and references seem to imply imperfection and contradict the doctrine of removal (*tanẓīh*), according to which, in virtue of His essence, God is not like the creatures He has made. The four leading theologians, Abū Ḥanīfa, ash-Shāfi'i, Aḥmad ibn Ḥanbal, and Mālik ibn Anas, taught that discussions on such subjects were unlawful. They believed in the Qur'ān and in the traditions regarding Muhammad, and accepted these without disputing on such abstract questions.

The Prophet himself said: 'Think of God's gifts, not of His nature; certainly you have no power for that.' Ibn Ḥanbal said: 'Whosoever moves his hand when he reads in the Qur'ān (xxxviii. 75) the words, "I have created with my hands," ought to have his hand cut off; and whosoever stretches forth his finger in repeating the saying of Muhammad, "The heart of the believer is between two fingers of the Merciful," deserves to have his fingers cut off' (ash-Shahrastāni's *Milāl wa'n-Nihāl*, Cureton's ed., London, 1842, p. 76). The commentator at-Tirmidhī said concerning the statement that God had descended to the lowest of the seven heavens: 'The descent is intelligible; the manner of it is unknown; the belief in it is obligatory; the discussion of it a blamable innovation.' Al-Baiḏāwī says: 'Certainly sitting on the throne is an attribute of God, its manner is not known.' Ibn Ḥanbal keeps to the literal meaning: "'God sits on His throne" means that He has the power of sitting.' He held, with most of the orthodox, that to allow a figurative interpretation was to introduce a dangerous principle. No explanation could be given, for it is written, 'There is none like unto Him' (cxii. 4), 'Nought is there like Him' (xlii. 9), 'Unworthy the estimate they form of God' (xxii. 78). One day a slave-woman was brought into the presence of Muhammad with a view to the granting of freedom to her. Muhammad said to her, 'Where is God?' 'In heaven,' was her reply. 'Set her at liberty; she is a true believer,' said Muhammad. The commentators explain that the Prophet was pleased with her, because she took the words 'in heaven' in their literal signification.

The orthodox position may be summed up in the saying, 'Just as the eye, turning to the brightness of the sun, finds darkness intervene which prevents all observation, so the understanding finds itself bewildered in its attempts to pry into the nature of God.' The attributes of God are beyond explanation, and so cannot be understood by man. Men should, therefore, mistrust their own notions, simply accept what Muhammad taught, and not exercise their reason in the consideration of the Divine attributes. This is not, Ibn Khaldūn explains, meant to depreciate the use of reason in all human matters, but it is an absurdity to employ it on things Divine (de Slane, *Prolegomènes d'Ibn Khaldūn*, iii. 45). The orthodox supported their position by the verse:

'He it is who hath sent down to thee the Book. Some of its signs are of themselves perspicuous [*muḥkam*]; these are the basis of the book, and others are ambiguous [*mutashābih*]. But they whose hearts are given to err follow its ambiguities, craving discord, craving an interpretation; yet none knoweth its interpretation but God. And the stable in knowledge say, "We believe in it, it is all from our Lord." But none will bear this in mind, save men endued with understanding' (iii. 5).

The difference between *muḥkam* and *mutashābih* verses has been thus defined: 'The verses which

give orders and prohibitions are *muhkam*; all others are *mutashābih*.' This ruling brings all verses which speak of God and His attributes under the term 'ambiguous.' That being the case, the orthodox say that this verse clearly shows that the interpretation of such is known only to God. There must not be any discussion on the ambiguous terms. This was the ancient rule (de Slane, *Prolegomenes d'Ibn Khaldūn*, iii. 67). A tradition records that 'Ā'isha said: 'One day the Prophet recited the fifth verse and said to me, "When thou seest those who follow its ambiguities, these are they whom God has named, avoid them."'

This apparently closes the door to any freedom of discussion, but men arose who altogether disputed the right of the orthodox thus to set aside the use of reason. They, too, based their position on this very verse by insisting on a different punctuation, which ran: 'None knoweth its interpretation but God and the stable in knowledge. They say, "We believe in it."' Here God and the wise are said to be able to investigate all those matters which come under ambiguous expressions, and this use of reason then leads them to say, 'We believe in it.' The first reading is the orthodox one; the scholastic theologians generally adopt the second.

When the latter asked, 'How can men believe what they do not know?' the reply was ready, 'The act of belief in the unknown is the very thing praised by God.' Or, 'Why, if the Qur'ān is a guide to man, are not all its verses plain?' The answer was: 'There are two kinds of eloquence, one the arrangement of words in a plain style, the other is figurative language. The Qur'ān, as a perfect book, must contain both (az-Zamakhshari reads the verse as 'except God and his servants who are established in knowledge,' Com. on iii. 5; see also Fleischer's edition of Balḍāwī, Leipzig, 1846-48, vol. I. p. 146, and footnote in Sell's *Faith of Islām*, p. 191).

This controversy, however, dealt chiefly with the questions whether the attributes of God were internal or external, were part of His essence or not, were eternal or not. The orthodox party, called the *Ṣifātites* (*ṣifāt* = 'qualities,' 'attributes'), held that the attributes of God are eternally inherent in His essence without separation or change. All the attributes are conjoined with Him, as life with knowledge, or knowledge with power. The ambiguous verses in the Qur'ān were not to be explained. The *Mu'tazilites* opposed this, and rejected the idea of eternal attributes, saying that to accept the orthodox view would be to admit a multiplicity of eternal existences. The attributes of hearing, seeing, and speech they rejected; they were accidents peculiar to corporeal existence. They looked upon such an expression as 'the hand of God' as a figurative way of speaking of His power. Ash-Shahrastānī in the *Mīlāl wa'n-Nihāl* (Cureton's ed. p. 30) thus puts the *Mu'tazilite* view:

'They say that God is eternal, that eternity is the peculiar property of His essence; but they deny the existence of any eternal attribute (as distinct from His nature); they say that He is omniscient as to His nature; living as to His nature; almighty as to His nature; but not through any knowledge, power, or life existing in Him as eternal attributes; for knowledge, life, power are part of His essence; otherwise, if they were looked upon as eternal attributes of the Deity, it would give rise to a multiplicity of eternal entities. They maintained also that the knowledge of God is within the province of reason, for knowledge is obtained only through reason.'

To the *Mu'tazilites* a plurality of co-eternal attributes, such as those involved in the Beautiful Names described above, seemed to conflict with the idea of absolute unity. They, therefore, apprehended them as states of the Divine essence, or identified them with the essence itself. The significance of the attributes thus, indeed, ran the risk of being lost. It is said that a philosopher who denied entirely the existence of any attribute said: 'God is by His essence a Being who knows.' A *Mu'tazilite* who denied the existence of an

eternal attribute did believe in attributes, and so far differed from the philosopher. His way of putting the case would be: 'God is a Being who knows, but by means of a knowledge which He Himself is.'

For the rise of the Ash'arite school, see art. AL-ASH'ARI. It is enough now to say that Abū al-Hasan al-Ash'ari (A.H. 260-324) was for a time a *Mu'tazilite*, but returned to the orthodox views. His defection was a serious blow to the progress of liberal thought in Islām. On the question of the attributes of God, the views of his disciples, the Ash'arites, are opposed to those of the *Mu'tazilites*, and are slightly different from those of the *Ṣifātites*. They say that the attributes of God are not of His essence; they are distinct from the latter, yet in such a way as to forbid any comparison between God and His creatures. The great dispute ranged round the attributes of will and speech (see FATE and INSPIRATION [Muslim]).

There are other small sects which hold peculiar views, such as the *Mushabbihites*, 'Assimilators' (ash-Shahrastānī, p. 76), who, taking figurative expressions literally, hold that there is a resemblance between God and His creatures; and the *Mujassimites*, 'Corporealizers,' who say that God has a self-subsisting body; but both of these views are considered heretical.

The question whether in the future world God will be seen with the physical eye has been a subject of much discussion. The orthodox quote the words to Moses: 'Look towards the Mount, and, if it abide firm in its place, then shalt thou see me' (vii. 139). It is argued that, as the standing firm of the mountain was possible, and, indeed, probable, so that which was connected with it—the seeing of God—must be possible also. The *Mu'tazilites*, however, held that He cannot be beheld with the corporeal sight (ash-Shahrastānī, p. 30). One day, a man was brought before the Khalīf al-Wāthiq and questioned regarding the Vision of God on the Day of Judgment. He repeated the tradition recorded by al-Bukhārī.

'We were sitting on the fourteenth night of the month [the night of the full moon] with the Prophet, who said, "Certainly, you will see your Lord, just as you see this moon"' (Ṣaḥīḥ al-Bukhārī, ch. on 'Sūra Qāf'), and declared his assent to it. The Khalīf called him a liar, and the man retorted the same. On this, the Khalīf became angry, and said: "What, will He be seen as a circumscribed and corporeal form which space can contain and the eye see? Verily, I deny a God with such attributes. What say ye?"

The *Mu'tazilites*, thus appealed to, gave it as their opinion that the man should be put to death—which was done. Some *Mu'tazilite* teachers tried to explain away this tradition by saying that Muhammad did not refer to Allāh, but to the 'primary intelligence' or the 'primary reason,' which, in the cosmogony of the mystics, was the first thing created, and is the manifestation of the Supreme. Still, the *Mu'tazilite* doctrine was definite—God cannot be seen. The orthodox view is that Muslims, at least, will see God, though the manner thereof cannot be described.

As-Suyūṭī, a famous theologian († A.D. 1505), classified the attributes of God thus:

(1) Attributes which must necessarily be ascribed to God: existence, eternity past, eternity future, self-existence, unity. The first is the attribute of essence; the other four are privative attributes. Then, there are the attributes of ideas (*ṣifāt al-ma'ānī*): power, will, knowledge, life, hearing, seeing, speaking. These are all necessary (*wājib*).

(2) Attributes which cannot be applied to God: non-existence, disappearance, similarity to created things, dependent existence, plurality in His nature, absence of power, of will, ignorance, deafness, dumbness, blindness, liability to death.

(3) Attributes which it is possible to ascribe to God: these may be summed up in the saying that to God can be ascribed the doing or the not doing of any thing possible.

Muhammad ibn ash-Shāfi'ī al-Fudāli puts the case somewhat differently. He says that there are twenty necessary qualities in God: existence (*wujūd*), the proof of which is the origin of

the world, which must have had an originator; priority (*qidam*), that is, there was never a time when He was not; continuance (*baqd*), or lack of termination to His existence; difference (*mukhalafa*) from things created; self-subsistence (*qidam bin-nafs*), independence of anything; unity; power; will; knowledge; life; hearing; seeing; speech; being powerful, which is thus distinguished from the attribute of power—'when power exists in an essence, the quality called "being powerful" is in that essence; being a willer, a knower, a living one, a hearer, a seer, a speaker.' These are said to be qualities subsisting in His essence, and are states (*had*); they are not the attributes of will, knowledge, etc.; but between them and the attributes concerned there is a reciprocal inseparability.

God is described as Merciful and Gracious, the Guardian over all, the Provider of daily bread, the Reviver of His people and their Deliverer, and many similar terms; but all that the Qur'an says of the loving-kindness of God is overshadowed by the teaching of Muhammad in the Qur'an and the tradition as to His Power. This is the prominent element in the conception of God as taught by the Prophet; it has ruled the Muslim world, and still rules it. The 'most excellent names,' ninety and nine in number, do not contain any term which denotes the relation of God as a Father to His people. The idea is repugnant to the Muslim mind, and so in Islām the relation of man to God must ever be that of a slave, who lacks the freedom and dignity of a son.

The Prophet's Semitic origin is apparent in his rigorous assertion of the unity of God. Allāh, the God, the absolute ruler of Nature and of man, was to him the truest and noblest conception of the Divine Being. Whether, if he had not been brought into contact with Jews, his monotheism would have been so strong is perhaps doubtful. It has been well said that there is no 'charm in the abstract doctrine of the unity of God to elevate mankind,' and the general idea that has grown out of this dogma—that God cannot be known, and that inquiries into His nature are wrong—has tended to put the God of the Muslim afar off. The prevailing conception of God as the All-Powerful is not far removed from the idea of a despot, and fear, thus separate from love, is either the incentive to all effort or leads to the repression of all energy in the Muslim. The idea of unlimited, arbitrary power, unrestrained by any law of holiness, has so filled the Muslim mind that sin is regarded less as a breach of moral law than as a violation of some arbitrary decree. Certain actions of the Prophet were evil according to any law of righteousness; but no Muslim would admit that in doing them Muhammad committed a sin, for he acted under the command of God. Thus, salvation has come to be regarded not as the moral elevation of a man, but as safety from punishment. It is attained not by spiritual regeneration of the man's evil nature, but by the punctilious performance of certain religious rites, submission to the will of God regarding them being the essential characteristic of a good Muslim.

The Wahhābites, the most fanatical of all Muslim sects, have so emphasized this idea of the unity and power of God that, from their point of view, 'Islām may be called the Deification of Power, just as Hinduism deifies the productive and generative principles of Nature' (see the description which Palgrave gives in his *Central and Eastern Arabia*, i. 365 [reproduced in Hughes' *DI*, art. 'God,' and Sell's *Faith of Islām*², p. 181 f.], of the Wahhābite idea of God; it is more or less true of what men of the other Muslim sects believe). Their conception of God realizes the greatness and grandeur of His power, but it does not tend to call forth the deep love of the human soul; and, as it retards the growth of spiritual life in the individual, so also it hinders progress in the community, and prevents the formation of a

national life. A practical fatalism settles sooner or later on all Muslim communities.

LITERATURE.—The translations of the Qur'an by Sale, Lane, Rodwell, Palmer; biographies of Muhammad and systems of Qur'anic theology, esp. by A. Sprenger (Berlin, 1861-69), L. Krehl (Leipzig, 1884), H. Grimme (Munster, 1892-95); W. M. Patten, *Ahmad ibn Hanbal and the Miḥna*, Leyden, 1897; M. T. Houtsma, *De Strijd over het Dogma*, Leyden, 1876; I. Goldziher, *Die Zahiriten*, Leipzig, 1884; A. von Kremer, *Gesch. der herrschenden Ideen des Islams*, Leipzig, 1868; T. P. Hughes, *DI*; E. Sell, *Faith of Islām*², London and Madras, 1907; D. B. Macdonald, *Development of Muslim Theology*, London, 1908; T. Haarbrücker, *Asch-Schahrastāni's Religionsparteien . . . übers.*, Halle, 1850-51; Houdas-Marçais, *El-Bokhari: les traditions islamiques trad.*, Paris, 1903-08; Ibn Khaldūn's *Prolegomenes*, tr. de Slane, Paris, 1862-68; W. Spitta, *Zur Gesch. al-Ash'aris*, Leipzig, 1876; M. Schreiner, 'Zur Gesch. des Ash'aritentums,' *8th Internat. Congress of Orientalists*, i. (1891), 'Beitr. zur Gesch. der theol. Bewegungen in Islām,' *ZDMG* lli. (1898) 463-510, 513-563, llii. (1899) 51-88; M. A. F. Mehren, 'Exposé de la réforme par el-Ash'ari,' *3rd Internat. Congress of Orientalists*, i. (1878); Garcin de Tassy, *L'Islamisme*, Paris, 1874; W. G. Palgrave, *Central and Eastern Arabia*, London, 1908; W. St. C. Tisdall, *Religion of the Crescent*, London, 1906; S. M. Zwemer, *The Moslem Doctrine of God*, New York, 1908; 'Abdu'r-Rahim, *Muhammadan Jurisprudence*, Madras, 1911.

EDWARD SELL.

GOD (Slavic).—The word for 'God' in the Slavic languages is *Bog*. It is found in the names of primitive pagan deities mentioned in the ancient chronicles (e.g. *Stribog*, *Dashbog*), and by Helmold (i. 2, *Zcerneboh*, i.e. *deum nigrum*). It is the same word as the Skr. *bhaga* (Old Pers. *baga*), which means 'good,' 'blessing'; and this meaning is found in derivatives from the root *bog* (e.g. *bogaty*, 'rich'; *ubog*, 'poor,' etc.).

Procopius of Cæsarea (11th cent.) seems to think it possible (*de Bello Gothico*, iii. 14) that the ancient Slavs had a supreme God dominating their pantheon, as Zeus dominated the Greek pantheon.

'The Slavs,' he says, speaking of those bordering on the Byzantine Empire, 'believe in a God who causes thunder, and is the sole master of the universe.'

Helmold (*Chronicon Slavorum*, i. 83) makes the same assertion in regard to the Slavs of the Baltic and the Elbe:

'Among the various gods to whom they attribute the fields and forests, sorrows and joys, they are all agreed that one God rules over the others from the heights of heaven. This all-powerful God attends only to celestial affairs. The others have each their separate functions and obey Him; they are the offspring of His blood, and take precedence in rank according to their nearness to this God of gods.'

Unfortunately, we have no text to confirm what Helmold says of the filiation of the Slavic gods. A biographer of the missionary Otto of Bamberg tells us that the Slavs regarded their supreme God as 'glorious and filled with all riches' (Ebbo, ii. 1). In the treaty concluded in 945 between the Slavs and Greeks it is said (supposed Russian chronicle of Nestor):

'May the Christian Russians who violate this treaty be abandoned by the all-powerful God; may those who have not been baptized get no help from God or Perun.'

But no other text mentions this anonymous god.

LITERATURE.—L. Leger, *Mythol. slave*, Paris, 1901, pp. 47-51; G. Krek, *Einleit. in die slav. Literaturgesch.*², Graz, 1887, p. 878 ff. L. LEGER.

GOD (Teutonic).—1. The term 'god.'—The term 'god,' as used to denote anthropomorphic beings of a higher order, is found in all the Teutonic languages (Goth. *gup*, O.N. *goð*, A.S. and O.S. *god*, O.H.G. *got*), but in no other branch of the Indogermanic family. After the conversion of the Teutons to Christianity the word came to be applied also to the Christian Deity. In the heathen period it was a neuter; in Christian times, a masculine. Its etymology and its original meaning are obscure, and have been much debated (cf. O. Schade, *Altdeutsches Wörterbuch*², Halle, 1872-1882, i. 342; L. K. Weigand, *Deutsches Wörterbuch*³, Giessen, 1909, i. 751); but, as in Norse

sources *goð* signifies 'image of a deity,' and as the word is philologically connected with Germ. *Götze* ('idol'), its original meaning was perhaps 'image,' 'figure' (Osthoff, in *Bezenberger's Beiträge zur Kunde der indogerm. Spr.* xxiv. [1900] 177). The higher being was believed to be present in the image, and so the term was transferred from the latter to the former.

2. The four pan-Teutonic deities.—The worship of anthropomorphic deities constitutes the final stage in the religious evolution of the heathen Teutons. It was, in the main, a development from the belief in souls and spirits. One of these innumerable creatures of the imagination was singled out as representative of a whole group, and became the central object of the cultus; it was worshipped by prayer and sacrifice, and gradually extended its sphere of influence, in harmony with the interests of the confederation whose members paid homage to it. Such was the origin of the deities worshipped by the Teutons and regarded as holy either by single communities or by whole nations. It sometimes happened that other deities surrendered their province to the god thus worshipped, became incorporated with him, and were then recognized as mere epithets of the chief deity; while, on the other hand, certain attributes of the latter were detached from him and became independent deities. There was no uniform cult common to all the Teutons. In many instances a cult migrated from one tribe to another, and so either superseded, or became amalgamated with, the indigenous cult (religious syncretism). We, nevertheless, find among the Teutons three specially prominent gods, who, moreover, are met with in all the different tribes, and must, accordingly, have come down from a period when the Teutons were still an undivided people. These three are **Wōðanaz*, the god of the dead and of the wind; **þonaraz*, the god of thunder and of the sky; and **Tiwaz*, the god of war. With these is associated a female figure who appears in the O.H.G. sources as *Fria*, in the O.N. as *Frigg* ('the beloved,' 'the wife'), and is always regarded as the consort of *Wōðan*. Roman writers identify *Wōðan* with Mercury; *Donar*—in the earlier period—with Hercules, and subsequently with Juppiter; *Ziu-Týr* with Mars; and *Fria-Frigg* with Venus; and thus, when the Roman calendar was introduced among the Teutons, the *dies Martis* was rendered 'Tuesday,' the *dies Mercurii* 'Wednesday,' the *dies Jovis* 'Thursday' (Norse *Þórsdagr*), and the *dies Veneris* 'Friday.'

(a) *Wōðan-Óðin*.—From the host of souls which continue to exist in the wind—the spirit-army still known in popular legend as the raging host, the wild hunt, the Asgard chase (in Norway), and the like—was evolved *Wōðan* as the leader of the host. This leader of departed souls then became the lord of the dead and of the dead-realm, and at length also the lord of life and death. The attributes of all soul-like beings are engrafted upon him: like the dead, he is ruthless, and deprives men of life; he is the swift traveller or rider through the air; he has the protean nature, and is able at any time to assume at will the form of man or animal; magic and divination are under his sway. In N.W. Germany, probably in pre-historic times, he had come to be worshipped in various Teutonic tribes, and here, accordingly, he became the god of war, and finally the god of the sky, or, in other words, the supreme god of a tribe or people. Thus, for example, he was worshipped as the supreme deity by the Anglo-Saxons at the time of their occupation of Britain (Geoffrey of Monmouth, 6); as the lord of battles by the Langobards, who, as legend tells, owed to him their name, and also their victory over the neighbouring peoples (Paulus Diaconus, *de Gest.*

Langob. i. 7, 8); thus, too, his cult migrated by way of Denmark to Scandinavia, gained a footing there, more especially at the royal courts, and, in Norway, frequently superseded the earlier cult of Thor. In the kings' courts, however—the residences of the skalds—he became also the god of poetry and poets. But his chthonic character still adheres to him; he had found admission to the courts as the head of the *Asas*, i.e. the ancestral spirits worshipped as divine; he is the lord of *Valholl*, the Norse paradise of fallen warriors; he is waited upon by the Valkyrs, who bring to him those slain in battle. His demand for human sacrifice is also known elsewhere. He has the power of changing his shape, and may show himself in a variety of human forms or as an animal. As the demonic wind-spirit of popular legend, he has a liking for amatory exploits. He presides over magic and spells. It was probably owing to this aspect of his character that he became the god of the poetic art, and then also of all higher wisdom—the one who, in particular, was aware of all that takes place in the life of gods and men. This knowledge, according to Norse mythology, he acquired by drinking the poetic mead, which was originally in the keeping of the dwarfs and then passed into the possession of the giants. In the form of a serpent, *Óðin* crawled into the mountain within which *Gunnloð*, daughter of the giant *Suttung*, kept watch over the mead, outwitted her, and stole away with the precious liquor. He gave draughts of the mead to such men as he destined to become poets.

Óðin's chthonic nature shows itself also in his external form. He is depicted as an old man with a long grey beard, and is therefore called *Hárbarðr*; he is one-eyed, like the man-eating demons of other myths; he wears a slouched hat pressed far down over his face, and is thus also named *Síðhottr*. He is sometimes the tireless traveller ('viator indefessus' [Saxo Gram. i. 128]), sometimes the swift rider who is borne through the air by his eight-footed steed *Sleipnir*. He appears also as the god of war in full armour ('armatus sicut Mars' [Adam of Bremen, iv. 26]), wearing the helmet upon his head, and holding in his hand the spear *Gungrir*, with which he stirs up war, and smites down those whom he has destined for his ghostly army. To his immediate retinue belong his two wolves, *Geri* ('the greedy') and *Freki* ('the voracious'), and his ravens, *Hugin* ('thought') and *Munin* ('memory'), which bring him tidings from all quarters. His abode during his times of rest was originally the mountain *Valholl*, the ancient realm of the dead, and, accordingly, he speaks of himself as the 'ancient of the mountain' (*Reginsmál* 18), while the skalds call him *fjallgautr* ('fell-god'). But, when he had been raised to the position of the supreme god among the Norsemen, *Valholl* became his citadel, where he sat enthroned as a king, exercising sway over the *einherjar*, the host of fallen warriors, and sending forth the Valkyrs, his wish-maidens, to bestow victory on his protégés, and convey the slain warriors to his castle. At their banquets there, the Valkyrs serve the *einherjar* with mead. *Óðin*, having thus attained the supreme place, becomes lord over all other deities, most of whom, in fact—e.g. Thor and Balder—now become his sons. This final stage of his development was attained more fully than elsewhere at the courts of the Norwegian kings, and was the work of the skalds resident there (cf. H. M. Chadwick, *The Cult of Othin*, London, 1899).

(b) *Donar-Thor*.—A second deity acknowledged by all the Teutons was *Donar* (O.N. *þorr*), who was in a special sense the god worshipped by the Norwegians. His name is connected with the root *tan*, 'to sound,' and the Lat. *tonare*, and means the 'thunderer.' He is properly the Teutonic god

of the upper regions, who manifests himself in the thunder. In this capacity he bears the axe or hammer, which he hurls from the sky, and with which he makes the earth fruitful (Adam of Bremen, iv. 26). He is depicted as a strong man in the prime of life and with a ruddy beard, and he is accordingly met with on the votive stones of Teutonic mercenaries as 'Hercules magusanus' or 'Hercules barbatus' (W. Brambach, *Corp. Inscr. Rhen.*, Elberfeld, 1867, no. 130 ff., 653). During the thunderstorm he travels through the air in a chariot, which, according to Norse mythology, is drawn by two goats. The saga also tells us that his hammer, which he grasps with gauntlets of iron, is called *Mjollnir*, and, further, that he wears a peculiar girdle, which increases his strength when his anger is roused. By virtue of his hammer he is also the god of human fecundity, using it to bless the rite of marriage. He is attended sometimes by the youthful *þjálfi*, pre-eminent in swiftness, and sometimes by *Loki* the cunning. His mother is *Jorð*, 'the earth,' whom the skalds identify with *Fjorgyn* or with *Hlóðyn* (O.H.G. *Hludana*). In the North, certain of his attributes are personified as his sons, *Magni* ('power') and *Móði* ('courage'), or as his daughter *þrúðr* ('strength'), and his abode is called *þrúðheimr* ('realm of strength') or *þrúðvangr* ('land of strength'). His consort is *Sif*, i.e. simply 'the wife.' In certain districts *Thor* came to be regarded as the son of *Óðin*, but this took place only after the latter had advanced to the position of supreme deity. He, nevertheless, maintained his prerogative as the chief object of belief and worship among the peasantry of Norway and Iceland till the downfall of paganism. In all the Norse countries he is the friend of man, succouring him in his conflict with demonic powers. The latter being represented mainly as giants, *Thor's* battles with giants form the theme of numerous myths, the materials of which were to a large extent furnished by widely diffused legends. In both Norway and Iceland temples were erected to him in large numbers; his cult has left traces in many place-names, while the numerous proper names formed with *Thor* are a further testimony to the prevalence of his worship among the Northern Teutons. It is true that outside this area we find but few data bearing upon his cult; but such as we have are in complete agreement with the evidence of the Norse sources. *Thor's* sacred tree was the oak (cf. L. Uhland, 'Der Mythos von *Thor*,' in *Schriften*, vi., Stuttgart, 1868).

(c) *Ziu-Týr*.—The third pan-Teutonic god was the war-god—the O.H.G. *Zio*, A.S. *Týw*, O.N. *Týr*, whose name appears in the O.H.G. *Ziestag*, A.S. *Tiwesdag*, O.N. *Týrsdagr*. He has often been regarded as a survival of **Tiwaz*, the Teutonic sky-god of pre-historic times, but in our extant sources he is never anything else than the god of war. His worship was specially prevalent among the Western Teutons. Thus he is met with on the Rhine as 'praecipuus deorum Mars' (Tac. *Hist.* iv. 64); the Alemanni, in virtue of their being devoted to his cult, were also called *Cyuarari*, i.e. 'worshippers of *Ziu*'; Batavian mercenaries stationed near Hadrian's wall dedicated altars to him as *Mars Thingsus* (*Things*, another appellation of *Zio*; cf. *Dien-* in Germ. *Dienstag*, 'Tuesday'), the god of the popular assembly (cf. Dan. *Ting*, 'parliament'). Among the Saxons he was known also as *Sahsnót*, and *Er* or *Ear*. His symbolic weapon was the sword. Norse myths depict him as having one arm, and tell how he lost his right arm by a stratagem of the *Fenris* wolf.

(d) *Frija-Frigg*.—In addition to these three male deities, all the Teutonic tribes recognized the goddess *Frija* (A.S. *Fri*, O.N. *Frigg*), the wife of *Wōdan-Óðin*. Her name (akin to Skr. *priya*)

means simply 'the beloved,' 'consort,' 'wife,' and she was, accordingly, the goddess of married women, and the bestower of children. She shared with *Óðin* his growing prestige, and became the mother of the gods; but she had no such position in the cultus as was enjoyed by her husband or by *Thor*.

3. Local deities.—Beyond the four mentioned above, no other deity was acknowledged by all the Teutonic peoples. Among the Southern Teutons and the Norwegians we meet with the indefinite figure of *Frija's* sister, who is called *Volla* by the former, and *Fulla* by the latter—a name signifying the dispenser of wealth. But we find a large number of deities belonging to particular districts—in Germany chiefly female, in Scandinavia both male and female—and known to us mainly from legendary sources. The great profusion of such local deities is shown by the votive stones erected by German mercenaries and inscribed with the names of goddesses. One of the most prominent of these was the *Nehalennia* worshipped in the Rhine delta—the tutelary deity of fishermen and the bestower of fruitfulness. The *Marsi* accorded a tribal worship to *Tanfana*, whose festival was celebrated in autumn (Tac. *Ann.* i. 51). A goddess of seafaring, whom *Tacitus* (*Germ.* 9) identifies with the Egyptian *Isis*, was worshipped by the *Suevi*. A confederation of seven tribes on the coast of the Baltic or the North Sea offered sacrifice and worship to *Nerthus*, who had her seat in a sacred grove, and travelled through the various territories in the beginning of spring (*ib.* 40; cf. *Mannhardt, Wald- u. Feldkulte*, Berlin, 1877, i. 567 ff.).

4. Deities peculiar to the Northern Teutons.—The deities of the Southern Teutons cannot compare in point of numbers with those met with in the Scandinavian sources. These Northern deities, moreover, are associated with mythology rather than with the cultus. The *Eddas* speak of two different classes of deities—the *Asas* and the *Vans*. We are told in a certain saga that these two groups were once at war, but ended their mutual hostility by a treaty, and thereafter became merged in one (*Ynglinga Saga*, cap. 4; cf. *Weinhold, Der Mythos vom Wanenkrieg*, Berlin, 1890). Here we can also trace the growth of the *Wōdan-Óðin* cult, and its eventual triumph over the Norse cult of *Frey*. In the North, accordingly, the more outstanding figures among the *Vans* were also objects of worship.

(a) *Frey, Njorð, and Freyja*.—At their head was *Frey*, whose principal sphere of worship was in the fertile plains of Sweden, his chief temple being at *Upsala*. His cult found its way thence to Norway (*Trondhjem*), and was then carried to Iceland by Norwegian colonists. The name *Frey* means simply 'the lord.' He was regarded as the god of the fertility of the soil, and thus also as the dispenser of wealth and prosperity—the deity from whose hand came sunshine, rain, and favourable winds. In the *Eddas* he is represented as travelling in a carriage drawn by a boar with bristles of gold. He possessed a marvellous sword, able of itself to fight, and also the ship *Skiðblaðnir*, in which he travelled through the air. His father is *Njorð*; his sister is *Freyja*. *Njorð* is really the Norse form of the *Nerthus* found in *Tacitus*. If *Nerthus* was, as *Tacitus* says, 'mother-earth' (*terra mater*), *Frey* was her consort, and then, when the female *Nerthus* became in the North the male *Njorð*, the latter became the father of the older god *Frey*, and, like him, also the bestower of wealth—wealth, however, more in keeping with Norwegian conditions, i.e. as acquired by seafaring. In Norway, wherever *Frey* was worshipped, *Njorð* also was worshipped, and their names appear side

by side in the Norwegian form of oath. The female Nerthus, on the other hand, survived in Frey's sister Freyja, whose name may have been derived from her brother's. A Norse myth speaks of Nóatún ('place of ships') as the abode of Njorð, and says that his wife, Skaði, the daughter of a giant, stays with him only three nights in Nóatún, while he spends nine nights with her in his mountain home. In Freyja, who appears only in the Norwego-Icelandic sources, are combined attributes of her brother and of Frigg. She was the goddess of fecundity and love. As a chthonic deity she has a share in the slain. She has the elf-like power of flying through the air in the form of a falcon, while legend endows her also with a resplendent breast-ornament, the *Brisingamen* ('the sparkling jewel').

(b) *Balder*.—Of the other Norse deities the most prominent was Balder, whose name signifies 'light,' 'the bright one.' Nothing is known of a Balder-cult, and what is told of him by Saxo Grammaticus and the Eddas consists of mythical narratives which group themselves round the subject of his death. The *Snorra Edda* says that he was noted for his lustrous appearance and his gentleness of nature. It is clear that, in the latest form of the myth, Balder has been endowed with certain attributes of Christ. His death, according to Saxo, was due to Hotherus (Hoðr), who for the occasion availed himself of a magic sword; the object of the conflict was the winning of the beautiful Nanna, who was the lady-love of Hotherus and to whom Balder also had paid court (*Hist. Dan.* i. 110). In the Edda, on the other hand, Nanna is Balder's wife, and Balder is the favourite of the gods, who were forewarned of his doom by evil dreams. His mother Frigg, accordingly, made all animate and inanimate things take an oath that they would not injure Balder, and only the mistletoe remained unsworn. In this form of the myth, however, it is not Hoðr, but Loki, who perpetrates the deed, Hoðr being a blind *Asa* who acts merely as the instrument of Loki. Thus, when the *Asas* cast stones and other missiles at Balder, as they were wont to do in play, Loki thrusts the mistletoe bough into Hoðr's hand and so instigates the throw which kills Balder (*Snorra Edda*, i. 172 ff.). In both forms of the myth Balder was avenged by a brother, whom Óðin begot for the purpose; this brother appears in Saxo as Bous, and in the Edda as Vali, of whom the *Voluspá* says that he will share the sovereignty in the new world. According to the Norse saga, Balder had a son named Forseti ('president'), who was the best of all judges, and is probably to be traced to the Frisian Fosite (cf. S. Bugge, *Studien über d. Entstehung der nord. Götter- u. Heldensagen*, Munich, 1889; Frazer, *GB*², London, 1900, iii. 236 ff.; F. Kauffmann, *Balder*, Strassburg, 1902; Schück, *Studier i nordisk Litteratur- och Religionshistoria*, Stockholm, 1904, ii. 1 ff.).

(c) *Heimdallr*.—Another of the *Asas* named in the Norse sources is Heimdallr, i.e. 'world-gleam,' 'he who shines over the world,' the sentinel of the *Asas* on the border of the Divine world, and as such provided with the *Gjallarhorn*, on which he sounds a blast at the outbreak of the last great battle between the gods and the demonic powers. In his capacity of watchman he requires less sleep than a bird, and sees equally well by day and by night. His ears are so acute that he hears the grass growing on the earth, and the wool on the sheep's back. According to a saga in the Edda, he is the son of nine sisters, daughters of the female sea-demon Rán, and derives his enormous strength from earth-force, the ice-cold sea, and boar's blood. Night after night upon the foaming cliff he wrestles with Loki for the possession of Freyja's

Brisingamen, and wrests from him the stolen jewel.

(d) *Minor and later deities: Ullr, Hoenir, Viðar, Bragi*.—(1) Still another figure numbered amongst the gods by the *Snorra Edda* is Ullr, whom Saxo calls Ollerus, making him the vicegerent of Óðin during the latter's absence (i. 130 f.). Ullr is highly skilled in fishing and ski-running, and is conspicuous for his beauty of form. (2) The figure of Hoenir, as regards both his name and his character, is difficult to explain. In the sagas he is often found in alliance with Óðin and Loki, the three being repeatedly associated in tales of adventure. So, too, the *Voluspá* represents them as having created the human race, but here Hoenir never becomes prominent. He fills a peculiar rôle in the legend of the war with the *Vans*. After the treaty of peace he was given as a hostage to the latter, amongst whom he became notorious for his mental incapacity, leaving everything in the hands of his fellow-hostage Mimir. The only quality in which he excels is swiftness. (3) In the Eddas we read also of Viðar, the son of Óðin and the giantess Gríð, as one of the gods. He is the taciturn *Asa*, and bears a striking resemblance to Vali. Like the latter, he is destined by birth to be an avenger. He avenges his father Óðin by thrusting his sword through the heart of the Fenris wolf, and wrenching apart the creature's upper and under jaws. He shares with Vali the sovereignty of the renewed world (*Voluspá*, 53). (4) The latest group of Norse deities includes Bragi, who with Óðin is the god of poetic art. He was really the skald Bragi, who lived in the 9th cent. and was accorded a place among the *einherjar*. In Valholl he acts as Óðin's counsellor, and, with other *einherjar*, receives the kings who die in battle. As an *Asa* he becomes a son of Óðin. He was noted for his long beard, and, according to the later sagas, was the husband of Iðun, who bestowed the gift of youth.

(e) *Loki*.—A peculiar position among the Norse deities is assigned to Loki. He is the *Asa* who sometimes succours, sometimes works injury; he is sometimes an ally of Óðin and Thór, and their comrade in travel, while, again, he seeks to overreach and deceive them. His double character makes him a favourite theme of poetic legend, and he became the nucleus of mythical incidents and Christian stories about Satan. Loki is in reality evolved from the chthonic elves, and in his original form he still survives in Scandinavian superstition as a domestic spirit. His chthonic character shows itself also in the blood-covenant which he makes with Óðin, while his elfish nature is seen in his power of assuming at will the form of a woman or an animal, in his artistic skill, his dexterity in theft, and his malicious cunning. His beautiful and graceful appearance and his lameness are characteristics also found among elfish beings. After the process of development by which the elfish appellation *loki* (related to *lúka*, 'to lock in,' as *holda* to *helan*, 'to hide') had become personified as Loki the *Asa*, the latter joins with Óðin and Hoenir in the creation of man; he wanders with these gods in quest of adventures; he brings the apples of Iðun to the giants, and in the form of an eagle takes them away again; in the shape of a mare, after union with the stallion of the architect of Asgard, he gives birth to Óðin's eight-footed steed Sleipnir; he cuts off Sif's hair, and then brings hair of gold for her from the dwarfs; he accompanies Thór upon the expedition in which the latter recovered his hammer from the land of the giants, and also upon his journey to Útgarðaloki. But Loki also brings about the death of Balder, and it was on this account that Norse poetry fastened upon him

the saga of the chained monster, telling how he was fettered by the *Asas*. Among the latter his wife is Sigyn, and their son Narfi.

In consequence of his destructive propensities, Loki became the enemy of the gods, and thus also the giant who at the head of the demonic powers has a share in bringing about the dissolution of the gods and the world. In this, the latest, phase of the myth, his wife is the giantess Angrboða, 'the worker of calamity,' while his children are the Miðgarð serpent, the Fenris wolf, and Hel, the queen of the under world (cf. A. Olrik, 'Loke i nyere folkeoverlevering,' in *Danske Studier*, v. [1908] 193 ff., vi. [1909] 69 ff.; *Festskrift til Feilberg*, 1911, p. 548 ff.; Celander, *Lokes mytiska ursprung*, Upsala, 1911).

(f) *Female deities*.—In the Norse poetic literature, moreover, we find the names of numerous female beings, the *gyðjur*, but in most cases the name is all we learn of them. In addition to Freyja, the sister of Frey (see above), the Norse peoples recognized Gefjon, who was at one time regarded as the goddess of the fruit-yielding earth, and was even worshipped as such (cf. A. Olrik, in *Danske Studier*, vii. [1910] 1 ff.), and to whom the Danes ascribed the present position of the Island of Zealand. Iðun typified eternal youth, and was the guardian of the apples which rejuvenated the gods. Later tradition made her the wife of Bragi. Female deities having special functions are found in Gná, the messenger of Frigg; Sága, the goddess of wisdom, who in company with Óðin drank wisdom from vessels of gold at Sökkvabekk; Snotra, who imparts wisdom to women; Sjöfn, who unites lovers; Lofn, who acts as intermediary between gods and men; Hlin, protectress in times of danger; Sýn, custodian of domestic peace; and Vor, guardian of oaths and treaties.

LITERATURE.—J. Grimm, *Deutsche Mythol.* 1., Göttingen, 1875, p. 81 ff.; E. H. Meyer, *Germ. Mythol.*, Berlin, 1891, p. 181 ff., also *Mythol. d. Germanen*, Strassburg, 1903, p. 283 ff.; E. Mogk, *Germ. Mythol.*, in Paul's *Grundriss d. Germ. Philol.* 2, Strassburg, 1898, iii. 312 ff.; W. Golther, *Handb. d. germ. Mythol.*, Leipzig, 1895, p. 192 ff.; Chantepie de la Saussaye, *The Religion of the Teutons*, Boston and London, 1902, p. 221 ff.; R. M. Meyer, *Allgerm. Religionsgesch.*, Leipzig, 1910, p. 168 ff.; L. Uhland, 'Odin,' in vol. vi. of *Schriften*, Stuttgart, 1868, p. 129 ff.; Th. Wisén, *Oden och Loke*, Stockholm, 1873; H. Petersen, *Om Nordboernes Gudedyrkelse og Gudetro i Hedenold*, Copenhagen, 1876; R. Much, *Der german. Himelsgott*, Halle, 1898.

E. MOGK.

GODS, DRESS OF.—See DRESS, vol. v. p. 66.

GODĀVARI (Skr. *godāvari*, 'granting water or kine'; but the name is more probably a Sanskritized form of the original Dravidian name *Goda* [Telugu *godē*], 'limit,' 'boundary,' in the sense that it divided two regions of the Dakkhin).—The great river of the central part of India, rising near Nāsik (q.v.), thence flowing E., and forming the boundary between the British District of Ahmadnagar and the Dominions of the Nizām of Haidarābād; thence through part of the latter territory, and finally falling into the Bay of Bengal in two branches—the E. or Gautamī Godāvari, and the W. or Vasiṣṭa. Its total length is 898 miles. The Godāvari ranks high among the twelve sacred rivers of India, its chief rivals being the Ganges and the Narmadā. It is associated with the story of the wanderings of Rāma, who is said to have lived for a long time at a place called Pañchavati, which is by some identified with Nāsik, but was probably lower down the course of the river. The chief sanctity attaches to the E. or Gautamī branch, based on the legend that it was revealed by Rāma to the ṛṣi Gautama. Another story tells that it flows from the same source as the Ganges, and this connexion is shown by its name, *Vṛddha-gāngā*, 'old lady Ganges.' Every part of its course is

sacred, and bathing in its waters washes away the foulest sin. Every twelve years the great Pushkara bathing-festival is held on its banks. One of the chief holy places is Trimbak (Skr. *Tryambaka*, 'three-eyed,' a title of Siva), which contains one of the great *lingas* of India. This is the reputed, but not the real, source. Here a place is shown under the name of Gaumukh, 'cow's mouth,' where the water drips from a lofty cliff through a stone cow's mouth, which the attendant priest decorates with leaves and flowers. Here the god is paraded in a litter every Monday; and every twelfth year, when the sun enters the sign of Leo, a great bathing-festival is held, the reputation of which is so great that the word *godāvari* is commonly used in Gujarāt to express the number twelve (*BG* viii. 649 ff.). Nāsik, close by, is held to be one of the sacred places of India. Lower down the course of the river comes Bhadrāchalam (Skr. *bhadra-achala*, 'lovely hill'), also known as Rāmatīrtha, the sacred ford where Rāma is said to have crossed the river. It contains a famous temple dedicated to the god, which is a place of pilgrimage. As the river approaches the sea, the chief holy places are Rājahmundry (Telugu *Rājamahendravarama*), which takes its name from the king Mahendradeva of the Orissa dynasty, and the village of Kotipali on the left bank of the E. mouth of the river.

LITERATURE.—*IGI* xii. [1908] 297 ff.; *Madras Manual of Administration*, 1898, iii. 312; Syed Hossain Bilgrami and C. Willmott, *Historical and Descriptive Sketch of H.H. the Nizam's Dominions*, Bombay, 1883, i. 7 ff.; F. R. Hemingway, *Godavari Gazetteer*, 1907, i. 4 ff.

W. CROOKE.

GODDESS.—See GOD, DEÆ MATRES, FEMALE PRINCIPLE.

GOETHE. — I. Life. — Goethe was born at Frankfort-on-the-Main on 28th August 1749. The place was good and the time was great. For his was the generation of Herder, Voss, Bürger, and Schiller—a generation succeeding that of Klopstock, Wieland, Winckelmann, Kant, and Lessing. His father was a man of firm will and serious purpose; his mother a woman of warm, noble, and imaginative nature. He was trained in law studies at the University of Leipzig, though his likings all the while were for poetry and classical antiquity. Later, he pursued his law studies at the University of Strassburg. Here, at the age of 21, he met the gifted and unfortunate Lenz; also the clear-headed Lerse and the strangely dreaming Jung-Stillung; and, most important of all, Herder, who, amid much interchange of thought, introduced him to the beauties of Shakespeare, and read with him certain other English works (1770–1771). Significant of Goethe's intellectual development is his writing to Salzmann in 1771: 'My *nisus* forwards is so strong that I can seldom compel myself to take breath and look backwards.' From Strassburg he returned for a short time to Frankfort, whence he went to Wetzlar. It was while practising at lawyer-work, which he greatly disliked, that his *Götz* was produced, and met with the most enthusiastic praise.

In 1775, Goethe went to Weimar, by invitation of the Duke Charles Augustus, and there began those years of active service that ran on till 1786. To his friend Merck he wrote: 'We are playing the devil here; we hold together, the Duke and I, and go our own way.' The Duke's doings were boisterous enough, and Goethe did not fail to share them. Wieland soon became the fast friend of Goethe. For years the latter was now actively engaged in State duties, having been promoted to the work of the Privy Council, through the Duke's favour. His influence upon the Duke was beneficial. Of Goethe's relations with women, such as

his romance, earlier, with Lotte, and his Weimar relations with Fran von Stein, there is neither space nor call to speak here, as we are concerned with his life mainly in its intellectual developments. Amid multiplying cares and distractions, Goethe maintained his interest in literary activities and plastic art; his official duties deepened his studies in science. Then came the years 1786-1788, wherein his life was made up of Italian sojourning, of which more will be said later.

After an absence of nearly two years in Italy, Goethe returned, and soon afterwards married a humble but winsome maiden, named Christiane Sophie Vulpius, in whose love he was happy. The years 1794-1805 were marked by the truly beautiful, and extremely striking, friendship of Goethe with Schiller. For the men were opposites, and did not readily draw to each other. Each was at first adversely critical of the other's work. In 1789, Schiller wrote that it would make him unhappy to be much with Goethe, who seemed egoistic; and for five years their friendship saw no advance. But, once an interesting start was gained, it remained faithful and fruitful to the end. Their despicable detractors they scourged in the *Xenien*, which varied very much in their quality. Goethe wrote to Schiller that their first cordial intercourse had been an epoch in his life; Schiller wrote of Goethe to the Countess Schimmelmann, in 1800, that 'there are in his nature a lofty integrity and truth, together with the highest earnestness on behalf of what is right and good.' Their correspondence shows how each was the complement of the other, and how each reinforced the other. When their union of hearts was broken by Schiller's death in May, 1805, it was an irreparable loss to Goethe, and his grief was great. A time of political troubles and distresses followed, until the peace that was concluded between France and Prussia in July 1807. Goethe's activities continued—official, literary, scientific, artistic. Years of revived life passed, but at length, in 1823, he had a serious illness, with slow recovery. Once recovered, however, he spent the years 1824-1830 in ceaseless activities, but 1830 was saddened by the death of his son, August. In 1831, however, his marvellous literary industry was proceeding. When he had put the finishing touches to *Faust*, he said to Eckermann that he considered the rest of his life a free gift. In the following year (22nd March 1832) he gently passed away. His dust was laid beside that of Schiller—in death not divided.

2. Works and characteristics.—With Goethe's relations to religion and ethics we are here concerned in a particular manner, without in any way overlooking literary aspects. It may be remarked that his religion took the pantheistic form of a world-spirit unfolding itself into the whole and various forms of life and being. But the most characteristic thing in his pantheism is its sense of the cohesiveness of Nature—its universal unity. Nature is to him self-renewing, self-multiplying, self-loving, and self-revealing—a unity coherent, and growingly conscious of itself. His grasp of Nature proceeds from no casual mechanism, but from a unity, revealing itself in manifold ways. Anything like a machine-like conception was entirely foreign to his point of view. Nature was to him an infinite ocean, restless and heaving, or a boundless tide of ceaseless, glowing life. He would have none of the skilled analyses sought to be imposed on what was to him the all-and-ever-living, exempt from application of mechanical and mathematical categories. Nature was to him God, and God Nature; man was a monad living in this God-Nature, enjoying it to the full, however many might be the metamorphoses through which he should be called to pass. In the spirit of man

Goethe found the same unity which for him marked the world of Nature. In these two worlds—the Nature-world and the Spirit-world—the Divine was for him the source of all harmony, pantheistic as the foundation of such a union might be. Faust's development is an instructive illustration. Goethe represents Faust as yearning for an inner comprehension of the secrets of Nature; he shows him as longing for a sense of oneness with her life, such that the intellectual and the sensuous spheres alike shall be transcended; he depicts him as demanding to be set above the limitations of human nature, and to share, though still as man, the inmost life of Nature. To Goethe the whole vesture of man's thought was but a parable or likeness of the eternal infinity of Nature—that *unendliche Natur* at whose breasts all things are nourished.

The philosophic thought which underlay Goethe's Nature outbursts was that of endless transformations of eternal substance in a universal activity, for the spell of the Spinozan ethics never ceased for him. But his Nature-contemplation was touched to joyous strength by Leibnizian optimism. In his indomitable study of Nature as one whole, he was led to anticipate organic unity, and to reject everything of the nature of final discrepancy or perfect isolation. His evolutionary instincts led him, in his studies of organic Nature, to lay fundamental stress on the type. Indeed, his aim was precisely for final unity, and he expressly said that the harmony of the whole makes every creature what it is.

In the literary work of Goethe, the creative and the critical functions were conjoined in a conspicuous manner, even if we should be obliged to hold that his creative spirit suffered in its results from the chill reflectiveness of the critical mind—from the prevalence of philosophic thought over the passional springs of nature. He distinctly recognized that there is a destructive criticism, and also a criticism creative or constructive; and he took the poet's aim, and the measure of its fulfilment, to be the supreme tests in criticism. His was the well-known and felicitous summarizing of criticism in the formula *im Ganzen, Guten, Schönen resolut zu leben*—'to live resolutely in the Whole, the Good, the Beautiful.' Great as was Goethe's literary achievement, it must not for an instant be supposed that he reached the highest level of excellence in all the various kinds of work which he attempted, for that was by no means the case. Everywhere in his work there is high literary distinction, but not always, or perhaps anywhere, supreme excellence. The real ground of the profound impression which he made as a literary figure we shall see later. Meantime, we take critical account of many of his more important literary efforts. His *Götz von Berlichingen*, a juvenile but captivating drama, attracted the attention of Scott, and was not without influence on *Ivanhoe*. It sets before us the ideal of freedom, in rude and natural forms of active and heroic will, battling against circumstance, and asserting its independence, under a native sense of justice. A like cry for freedom—the freedom of the artist—marks Goethe's *Prometheus*, which contains passages of living interest.

Of Goethe's superb power as a writer of ballads, instances are seen in his 'Bride of Corinth' (*Die Braut von Korinth*), 'The Erl-King' (*Der Erlkönig*), and 'The God and the Bayadere' (*Der Gott und die Bajadere*), which witness to his wide-reaching insight and subtle charm of expression, and abound in elements of beauty and mystery.

Goethe's sojourn in Italy, passed in rapt contemplation of Art and Nature, developed in him the spectatorial attitude rather than that of practical activity. This attitude, with its own ethical conception of the world, is reflected in his exquisite

drama *Iphigenia*, his refined play *Torquato Tasso*—neither of which, however, proceeded from a Shakespeare—and in his serious work, *Wilhelm Meister*. Of the last we shall presently speak, but meantime remark of his *Tasso* that he found it hard to complete this fine and penetrative piece of work. But he said to Eckermann that the play was bone of his bone and flesh of his flesh. The *Tasso* of the drama, it should be said, is in certain respects not at all like the *Tasso* of historic fame. In the same way, Goethe's *Egmont* differs in many respects from the *Egmont* of history, and is ruined by his inability to read hostility where it exists. There is something not quite admirable in Goethe's treating a noble figure of history, not only without any idealizing, but with positive reduction of moral stature. For all that, there are many fine things in the work. His *Iphigenia*, already mentioned, is a figure admirable and pathetic, drawn by Goethe's Hellenism with characteristically Greek reserve. Not less delicately drawn are the figures in his *Hermann und Dorothea*, which, while truly individual, are significant of the typical. Redolent of the Greek spirit they may be, but they remain genuinely German. Artistically, the piece is perfect.

Goethe's ethical attitude, to which reference has already been made, is a rather difficult subject, as is seen in his resolving morality into systematized self-expression and self-realization, even in the case of the self-development of *Faust*, wherein are incidents not easily brought within the ethical sphere. But Goethe's own moments of aggressive paganism are not to be forgotten, and they cast a significant light on his rather absurd impatience with what he regarded as Christianity's ascetic chastisement of the senses. This is not to overlook the fact that he felt the force of Kant's thought with respect to practical problems of ethics. It was in one of his later stages that he took Christianity to be a religion inculcating reverence in three kinds—for what is above us, for what is below us, and for equals—and this Neo-Christianism, if it may be so termed, consisted in the fusion of these three elements.

The artistic view of life finds expression in Goethe's *Wilhelm Meister*, which has no lack of wealth of life and thought, though wanting in artistic finality. Culture, or *Bildung*, sums up his aim, and the work has been aptly styled an *Odyssey* of culture. The world is for him harmonized in cultured society. In spite of ethical and artistic drawbacks not difficult to find, many have been able to learn much from it. It presents the world as a 'vast quarry' of materials, which it is for us to reduce to an ideal form in virtue of the creative power within us. Thus a vague and formless idealism will be supplanted, under life's disciplinary processes, by definite and well-chosen activity. It is as a philosophical realist that Goethe so speaks, his own happiness being, in some sort, a religion to him. But the work insists that man shall develop his sentient and perceptive powers, no less than his powers of moral culture, in order to the harmonious working of all the powers of his nature. All these teachings, as to the wisdom and strength of life, are set forth in a manner as far as possible removed from didactic or moralistic presentations, in the rich and varied guise, indeed, of animated description and thrilling romance. This is not to say, however, that the work is not dull and prosaic enough in places.

In 'The Sufferings of Young Werther' (*Die Leiden des jungen Werthers*), Goethe gave utterance to that reaction against the domination of the understanding which marked the 18th century. He made the work expressive of the high sensibility, and the feeling for Nature, which were

being in new ways developed. But his *Werther* was too given over to the sway of sensibility to have it, as in Goethe himself, controlled and regulated by reflective reason. Hence the work has little healthiness of tone, and is infected with the malady of the age—the excessive sentimentalism of the closing 18th century.

Goethe's 'Elective Affinities' (*Die Wahlverwandtschaften*) is a fine prose work, telling of the tragic significance of the relations which he calls 'elective affinities,' under given circumstances. The book is marked by great feeling, high imagination, and deep knowledge of man and the world.

As in *Wilhelm Meister*, so in the 'Poetry and Truth' (*Dichtung und Wahrheit*), the culture idea is emphasized. The work is an autobiographic record of somewhat unusual and informal character, but it presents, in light and graceful style, more than personal experiences of his early life; it even reflects the national currents of thought and feeling. Friend as Goethe was of world-literature, he here complains that national subjects had practically no treatment from the friends of his early days. It contains, too, in a noteworthy way, his scorn of the 'melancholy, atheistical twilight,' wherein Nature is viewed as mere eternal and unaided movement of matter.

On the development of *Faust* we have already touched, but it remains to remark that *Faust*, as a work, is unique and incommensurable. It may be said to be philosophic for the way in which it embodies criticisms of life. The power and prestige of Goethe as a critic of life are extraordinarily great. In Germany itself *Faust* has been styled a world-epic, or *Welt-epos*, because of its vast range and wondrous universality. Great, however, as it is, it is scarcely to be taken as the most characteristic product of Goethe's genius, so marked by factual tendency and breadth, as of an inductive philosopher. But even in this work, knowledge of a true sort is to come, in its author's view, through direct, living, and wondering contemplation of Nature—looking 'into her breast as into the bosom of a friend'—and not through dry thinking or analysis. To know life in its concrete variety, pressure, and fullness is to be able to appreciate *Faust*. Here Goethe's religion is 'the religion of the deed,' which, in his pagan moods, he elsewhere describes as a kind of religion of healthy-mindedness, if that may be so termed which consists in sheer absorption in the world and its joys. But his religious attachments are characteristically vague. In an advanced part of *Faust* we find the 'religion of the deed' reappear, when it is announced that we have power to redeem 'him who labours ceaselessly striving.' It is to be noted that in *Faust* the problem of evil was what engrossed Goethe—whether to be regarded as an essential element of the universe or as a merely negative thing, a transient appearance to be overpassed. The attitude of *Faust* is that two souls dwell within his breast, the one fain to separate itself from the other. Should evil be destined to be overcome, Goethe would take *Faust* to represent the triumphant process. This is where the ethical worth of *Faust* is to be found, in its manner of typifying or embodying the modern spirit or tendency: in *Faust* is set forth the essential man—bold in aspiration, all-consuming in desire, hopeless in fallen condition, and exultant in ultimate salvation—so as to foreshadow the destiny of the human race. He expressly aspires to take up into himself what is portioned among the whole of humanity. The whole drama has profound symbolic significance. In its course the claims of the individual and the social spirit will mayhap be harmonized in an ideal of practical culture. Its basal thought is that evil is not a positive power, but merely some-

thing negative—an interpretation of moral evil, it must be said, of too optimistic a character, and one which is not quite clearly and satisfactorily wrought out, so far as the *Läuterung* (the purification or rectification) of Faust's character and development is concerned. The progress is wanting in inwardness of character. It is in the Second Part of *Faust*—often partially misconceived and greatly undervalued—that we see the triumph of humanity in Faust, mounting the heavens after his soaring ideal. The Second Part lacks, of course, the passion of the First; its erudite air is more felt; its philosophic intent and prolonged manipulation are more evident; its thought is less sapid and spontaneous; but, in spite of these and other defects, it has abundant genius, and does not fail to prove itself the completion of the First, as the present writer has elsewhere shown ('The Philosophy of Faust,' in *Essays Literary and Philosophical*). Goethe has contrived to introduce geology, optics, and chemistry into *Faust*; but such didactic attempts to combine science with poetry must always remain hazardous, if only because science cares nothing for the individual, while individuality is of the essence of art. *Faust* has, at any rate, given the world a supreme, unforgettable lesson as to progressive development being the essential mode whereby such conditioned beings as we are may hope to reach the ideal—the perfection of love.

The famous *Zueignung*, or dedication, now used as Introduction to Goethe's poems, is of unsurpassed loveliness in German literature, impressing one, it has been said, as a lofty vestibule, with the awe-inspiring grandeur of the temple to be entered. Its lovely message leads up to the self-revealing of the Divine form of poetic Truth, who gives him a veil, and tells him how to use it.

Goethe's 'Italian Journey' (*Italianische Reise*) was worked up thirty years after the journey itself, from journals and letters belonging to that time. The book presents, in a most vivid form, the features of delight and charm that mark Italian travel; but it is even more interesting for its psychic experiences and revelations. On 6th September 1787 we find Goethe writing from Rome:

'So much is certain: the old artists had as great a knowledge of Nature, and as certain a notion (*Begriff*) of what can be represented, as Homer had.' And, further: 'These high works of Art have been, at the same time, supreme works of Nature, produced by men according to true and natural laws; all that is arbitrary or imaginary falls away; here is necessity, here is God' (*Ital. Reise*, ed. Düntzer, Berlin, 1877, p. 396).

The way to perfect Art, in form and content, seems to have lain for Goethe through looking into the deeps of Nature and Man. He held that in Art and Poesy personality is everything, and that the artist, to create something fit and capable, must be himself fit and capable. The comprehensive character of Goethe's interests and powers of observation needs no mention, but his strange limitations are not always clearly known and understood. His intense dislike of Byzantine and Gothic architecture; his huge indifference to the early art of Italy; his lack of interest in Mediæval and Christian Rome; his supreme neglect of historical associations, as outside the realm of *Anschauung*, or intuition—all, in diverse ways, mark limitations due to a sense of form which kept from him the power of appreciation. Greek sculpture, Renaissance painting, architectural Rome—these were things that caught up, in significant fashion, his sense of artistic form. The Classicism to be found in Goethe was, it seems warrantable to say, more the result of this Italian journey and his study of antique Art than of direct contact with the ancient Classical Literatures. It is not meant, in saying this, that his Hellenism had in it any-

thing of the nature of a literary pose. The chief result of his Italian sojourning on Goethe's work was the plastic quality imparted to it. When he says that Art and Nature are only one, that is because Art is for him the highest manifestation of the working of Nature. Goethe's world is the world of the eye. His evolutionary instincts led him to view the single specimen in its relation to the organic whole. We find him writing to Herder from Naples on 17th May 1787, that the *Urpflanze*—or grand type of all plants—is the most marvellous thing in the world, 'which Nature herself might envy me' (*Ital. Reise*, 308).

The 'West-Eastern Divan' (*West-östlicher Divan*) is concerned with the life of the East, and is not now to be dwelt upon; it must suffice to say that the work was largely a fruit of his study of the Persian poets, and is rich in its own varied metres, and wise, beautiful poems. It proved a well of inspiration to Rückert, Platen, and other poets.

3. Influence.—We cannot now pursue the study of Goethe's works further, but must be content to appraise his genius, work, and character in more general and comprehensive terms. The vitality of his ideas is very striking; the range of his activities was certainly extraordinary. Activity was to him life. The great principle of activity was woven into his philosophical conception of the universe. For he raised himself to contemplate the whole range and scope of man's existence, and pierced by his insight to the central core of reality. Thus he came to fashion the *Weltanschauung* which was his own (see the present writer's 'Goethe as Philosopher,' in *Literary Essays*). Sane and discerning as a literary critic, pre-eminent in genius and gifts as romancer, dramatist, and lyrical poet, Goethe yet did not escape originality in science, and in the criticism of Art. Emerson quaintly said of him that 'the old Eternal Genius who built the world has confided himself more to this man than to any other' (*Works*, vol. i., London, 1899, 'Goethe, or The Writer'). It seems to be just in the totality of his achievement that Goethe's power and fascination lie; his career embodied a deeper synthesis of life—more of his own ideal of life in the Whole, the Good, and the Beautiful—than men had before seen; and all this, in spite of those limitations, shortcomings, mistakes, futilities, and pessimisms, which are, even in his case, not at all to be denied. Striking as is the influence of Goethe on the whole German nation, he exerts an influence hardly less strong on the cultivated classes of Britain and America. Still, his aims were too intellectualized; and his striving was really too restless. He thinks restless activity proves the man—*nur rastlos bethätigt sich der Mann*. One might almost apply to him what Marmontel said of Voltaire, that repose was unknown to him. Not even the calming power of Spinozism greatly helped him here. His will was not sufficiently invigorated by moral affections. He also lacked spiritualized unity of conception. But, in the sphere of intellect, he towers sublime, with amazing vigour and persistency in his intellectual performances. His ideal is *reine Menschlichkeit*, or humanity purified of every hampering element. In his latest years, at any rate, he cherished a belief in immortality; and it seems in some ways rather a fine thing that he declared the weightiest ground for that belief to be the fact that we cannot do without it.

LITERATURE.—The following selected list may be consulted: J. Lindsay, *Literary Essays*, Edinb. 1912, also *Essays, Literary and Philosophical*, do. 1896; E. Dowden, *New Studies in Literature*, Lond. 1895; J. R. Seeley, *Goethe, reviewed after Sixty Years*, do. 1894; J. Gostwick, *German Culture and Christianity, 1770-1880*, do. 1882; A. H. Japp, *German Life*

and Literature, do. 1890; H. Düntzer, *Life of Goethe*, Eng. tr., New York, 1884; H. H. Boyesen, *Goethe and Schiller*, do. 1879; R. H. Hutton, *Essays, Theological and Literary*, Lond. 1877; K. Fischer, *Goethe's Faust*, Stuttgart, 1893; J. Minor, *Goethe's Faust*, do. 1901.

JAMES LINDSAY.

GOKARN (Skr. *gokarna*, 'cow's ear').—A famous place of pilgrimage on the W. coast of India, in the N. Kanara District of the Bombay Presidency; lat. 14° 32' N., long. 74° 19' E. The name is based on a legend that Brahmā produced four sages to carry on the work of creation, which they refused to undertake. He then formed Śiva from his forehead. Śiva hesitated to create the universe until he could devise measures to render it imperishable. So he dived into the ocean and remained for many ages in meditation. Brahmā, weary of the delay, moulded the earth and filled it with life. When Śiva heard of this creation, he was wroth, and, rising through the water, struck the land. He attempted to force his way through it with his trident, when the earth-goddess, taking the form of a cow, begged the angry god, instead of destroying her, to rise to the surface through her ear. Śiva accordingly passed through her ear, and rose on the Gokarn beach, where a cave, known as the *Rudrayoni*, or 'Rudra's passage,' marks the spot. A story of the same type tells how the hero Paraśurāma, 'Rāma with the axe,' by severe penances and propitiation of Varuṇa the sea-god and Bhūmī Devī the earth-goddess, was allowed to claim as his own as much land as could be covered by his axe when flung from Gokarn, which was then the Land's End, into the southern ocean. Thus was created the land of Kerala, reaching from Gokarn to Cape Comorin, which now stands at the S. of the Peninsula. These legends seem to embody a tradition of land elevation in pre-historic times, which is confirmed by modern geological researches (*Manual of Travancore*, 1906, i. 212 ff.).

The chief temple at Gokarn is that dedicated to Śiva under the title of Mahābalesvara, 'the very powerful Lord,' built of granite in the Dravidian style. It contains the famous *linga* known as *Ātma*, or 'self,' which, in his wrath at the creation of the world by Brahmā, Śiva created out of his own essence, and long wore round his neck. There are also numerous shrines named after various gods and saints who visited the place and performed austerities here, including Brahmā, Viṣṇu, Śiva, the ṛṣi Agastya, Rāma, and Rāvaṇa. The place is visited by hosts of pilgrims and religious mendicants, as well as by those who bring the bones and ashes of deceased relatives, which they consign to the waters, believing that this ensures for them eternal felicity. Bathing here cleanses from all sin, even that of murdering a Brāhman. The mention of the place by Kālidāsa carries back its sanctity to the beginning of the 7th cent. A.D. (*IGI* ii. [1908] 17). It is also mentioned in the *Mahābhārata* and *Rāmāyaṇa* (J. Muir, *Original Sanskrit Texts*, 1873, iv. 285; R. T. H. Griffith, *The Rāmāyaṇ of Vālmiki*, 1895, p. 54), the sacred books declaring that he who spends three nights here and worships Śiva gains as much merit as if he performed the horse-sacrifice; while he who remains twelve nights becomes pure in heart. Dr. John Fryer, one of the early travellers to India, visited Gokarn in 1675, and has left an interesting account of the place.

LITERATURE.—*BG*, vol. xv. pt. i. p. 283 ff.; J. Fryer, *A New Account of E. India and Persia*, London, 1698, p. 158 ff., ed. 1912 (Hakluyt Society), ii. 80 ff.

W. CROOKE.

GOKUL (Skr. *gokula*, 'a herd of kine,' 'a cow-house').—A sacred town and place of pilgrimage situated on the left bank of the river Jumnā, in the Muttra (Mathura) District of the United Provinces of Agra and Oudh; lat. 27° 28' N., long.

77° 46' E.; sacred as the scene of many legends connected with Kṛṣṇa. It is in reality only the waterside suburb of Mahāban (*q.v.*); and all the traditional sites of Kṛṣṇa's adventures which the *Purāṇas* fix at Gokul are also shown at Mahāban, which is the place alluded to whenever Gokul is mentioned in Skr. literature. But, as it retains its ancient name, this suburb is considered much more sacred than the original town. It is specially important as the headquarters of the Vallabhāchārya or Gokulastha Gosāins,

'the Epicureans of the East, who are not ashamed to avow their belief that the ideal life consists rather in social enjoyment than in solitude and mortification. Such a creed is naturally destructive of all self-restraint, even in matters where indulgence is by common consent held criminal; and the profligacy to which it has given rise is so notorious that the late Mahārājā of Jaypur was moved to expel from his capital the ancient image of Gokul Chandrama, for which the sect entertained a special veneration. He further conceived such a prejudice against Vaiṣṇavas in general, that all his subjects were compelled, before they appeared in his presence, to mark their forehead with the three horizontal lines that indicate a votary of Śiva. The scandalous practices of the Gosāins and the unnatural subserviency of the people in ministering to their gratification received a crushing *exposé* in a *cause célèbre* for libel tried before the Supreme Court of Bombay in 1861' (Growse, p. 284).

LITERATURE.—F. S. Growse, *Mathura, a District Memoir*, Allahabad, 1883, p. 282 ff.; *JASB* xli. 313 ff.; A. Führer, *Monumental Antiquities and Inscriptions of the North-west Provinces and Oudh*, do. 1891, p. 101. For the practices of the Vallabhāchārya Gosāins, see [Karsandās Mūlji] *Hist. of the Sect of the Mahārājas or Vallabhāchāryas in W. India*, London, 1865, *Report of the Maharaj Libel Case, and of the Bhattia Conspiracy Case connected with it*, Bombay, 1862.

W. CROOKE.

GOLDEN AGE.—See AGES OF THE WORLD, FALL (Ethnic).

GOLDEN RULE.—The Golden Rule, as it is often called, is found in two different connexions, and in slightly differing forms, in Mt 7¹² and Lk 6³¹. In Mt. it occurs in the Sermon on the Mount in the form:

'All things therefore whatsoever ye would that men should do unto you, even so do ye also unto them: for this is the law and the prophets.'

In Lk. the saying runs:

'And as ye would that men should do unto you, do ye also to them likewise.'

While in Lk. the maxim is found in immediate connexion with other sayings bearing on conduct towards our neighbours, in Mt. this is not equally the case; it follows on directions relating to instancy in prayer and on the promise that God will give good things to those that ask Him. It has, therefore, been argued that, while the saying formed part of the original *Logia* on which, in this portion of his Gospel, the Evangelist is drawing, St. Matthew must have wrongly inserted it in this particular connexion; and that it would more appropriately find a place among the precepts relating to our conduct to our neighbour in 5³⁰⁻⁴⁰, or should follow on vv. 1.² and v. 6 of the 7th chapter. In the latter case it would seem, however, that the intermediate verses and not the saying itself have been wrongly inserted. The argument that the saying has got into a wrong place in Mt. is not very convincing; the connexion between it and the immediately preceding verses is not really very forced or unnatural. The train of thought would seem to be that, as God gives good gifts to those who ask Him, so we as Christians ought to render to others the sort of service, the good things, which we should wish them to render to us. That this is the connexion of thought which the earlier translators recognized in the passage is made probable by the fact that most of the early Latin versions, though not the Vulgate itself, render: 'Whatever good things, therefore, you wish that others should do unto you, even such do unto them; for this is the law and the prophets.'

We may observe that both St. Matthew and St.

Luke, though they differ as to the precise context in which the words occur, equally regard them as a summary of the principles by which the conduct of Christians in respect to their neighbours is to be governed. And this is the position which the maxim holds in the earliest quotations of it which are to be found in Christian literature outside the Gospels. The earliest of them occurs in the well-known passage in the Western (Cod. D) recension of the decree of the Council of Jerusalem, in Ac 15²⁸. It runs as follows:

'It has seemed good to the Holy Spirit and to us to lay upon you no greater burden than these necessary things: to abstain from meats offered to idols, and from blood, and from fornication, and whatsoever ye do not wish should be done unto you not to do (or do not do) to others—from which if ye keep yourselves ye shall do well, being borne along in the Holy Spirit—Fare ye well.'

Now, there has arisen a considerable controversy between Blass and Harnack whether the Western or the text of other great uncial MSS represents the earlier form of text in the Acts, and the controversy has especially ranged itself about this particular passage. Blass holds that Cod. D, originally composed probably at Rome, represents the first rough draft of the Acts put forth by St. Luke; while the ordinary text gives us the more polished and elaborated recension which he ultimately dedicated to Theophilus. Harnack, on the other hand, maintains that the text preserved in the non-Western MSS embodies St. Luke's original recension, and that Cod. D represents a later and comparatively ignorant recension, dating probably from early in the 2nd century. This, on the whole, is the view taken also by W. M. Ramsay. The question, however answered, is not, for our present purpose, of first-rate importance; for those who regard the insertion of the Golden Rule in this passage as the work of a later editor still assign to that editor a very early date—not later than the opening years of the 2nd cent.—so that in any case the appearance of the saying in this connexion is a proof of the wide acceptance which the Rule, in this negative form at least, obtained in the early Church. And that, in spite of its absence from the received text, it continued to hold a place in this passage of the Acts down to a comparatively late date, we have interesting evidence from the 'Dooms of King Alfred.' One of them, quoting this passage, runs as follows:

'It seemed good to the Holy Ghost, and to us, that we should set no burden upon you above that which it was needful for you to bear, now, that is, that you forbear from worshipping idols, and from tasting blood, or things strangled, and from fornication, and that which ye will that other men should not do unto you, do ye not that to other men.'

On this last precept the king observes:

'From this one doom a man may remember that he judge every man righteously; he need heed no other doom book. Let him remember that he adjudge to no man that which he would not that he adjudge to him, if he sought judgment against him.'

Thus emphatically, but reverently, does the king enforce our Lord's own comment on the principle 'This is the Law and the Prophets' (see *Expt* x. [1899] 395 ff., on Ac 15²⁸); and, for the reference to King Alfred's 'Dooms,' Estlin Carpenter and G. Harford's *Composition of the Hexateuch*, ed. 1902, p. 10).

We observe, further, that in this earliest quotation the form in which the saying is presented is not the positive form in which it appears in both Mt. and Lk., but the negative form, i.e. as a prohibition, and not as a command: 'Do not do to others that which you would not they should do to you.' We note that the same characteristic is observable also in the two earliest quotations in which the phrase is to be found in post-Biblical Christian writings. The first of them is at the opening of 'The Way of Life' as presented in the *Didache*:

'First of all, thou shalt love the Lord thy God who made thee. Secondly, thou shalt love thy neighbour as thyself. All

things, then, whatsoever thou wouldst not wish to be done to thee, do thou also not do to another.'

The second reference occurs in the recently recovered *Apology of Aristides*. Towards the close (ch. 15), in giving a summary of Christian belief and practice, Aristides uses the following words:

'They [i.e. the Christians] do not commit adultery, do not commit fornication, do not bear false witness, do not covet their neighbour's goods, honour their father and their mother, love their neighbours, judge justly, whatever they do not wish to be done to them they do not do to another; they exhort those who injure them and make them friendly to themselves.'

Harnack considers that both these passages may very likely be taken from an early Christian catechism in wide use in different Churches; but, whether they are so or not, the appearance of the Golden Rule in two distinct summaries of Christian practice testifies to the importance attached to it in the early Church.

But the precept, at least in its negative form, is by no means confined to Christianity; it is to be found in the earlier Judaism, and on the lips of philosophers outside both Judaism and Christianity. For the first we may refer to To 4^{1a}, which runs: 'Take heed to thyself, my child, in all thy works, and be discreet in all thy behaviour; and what thou thyself hatest, do to no man.' Hillel, the famous Jewish Rabbi, when asked for a short summary of the Law in relation to a man's neighbour, is reported to have given it in this form: 'Whatsoever thou wouldst that men should not do to thee, do not do that to them' (cf. Bab. *Shabb.* 31a). For other parallels, see C. Taylor, *Sayings of the Jewish Fathers*², Cambridge, 1897, p. 142 f., and cf. Hirsch, 'Golden Rule,' in *JE* vi. (1904) 21 f.

Among the Greeks, Isocrates is mentioned as enunciating the maxim, 'Do not do to others that at which you would be angry if you suffered it from others' (*Niccles*, 61b). Plato, in more than one passage in the *Republic* (e.g. iv. 443), lays down a rule of a similar purport. Aristotle, when questioned how we should behave to our friends, is quoted by Diog. Laert. (v. 21) as saying: 'Exactly as we would they should behave to us' (cf. *Nic. Eth.* ix. 8). See also Epictetus, fr. 42.

In the wider world outside we find two further enunciations of the precept—one in a precise, the other in a less definite, form. Confucius, drawing, as he said, the maxim from the study of man's mental constitution, laid it down in the following terms: 'What you do not like if done to yourself, do not do to others' (cf. J. Legge, *Chinese Classics*, Hongkong, 1861-72, i. 191 f.). This is the Golden Rule in its negative form, but he expressed it also in the positive shape of 'reciprocity' or 'as heart to heart.' This was embodied by him in a characteristic Chinese symbol, and is given in places as the ultimate rule of life (*EBr*¹¹, art. 'Confucius,' p. 912). Something like the same thought appears in the writings of his older contemporary Buddha; but here no precise words give expression to the apothegm; his principle more nearly approaches to the maxim of St. Paul, 'Rejoice with them that rejoice; weep with them that weep' (Ro 12¹⁰); and a certain self-centredness in his system, which makes the doing of kindnesses to others valuable mainly on account of the merit thus earned for a man's self, makes it clear that such a principle as our Lord enjoins was not altogether cognate to his thought (Copleston, *Buddhism Primitive and Present*, London, 1902; but cf. A. J. Edmunds, *Buddhist and Christian Gospels*⁴, Philad. 1908, § 12).

It would appear, then, that as a negative or limiting principle, a principle of justice, the maxim obtained a wide acceptance among the best and most enlightened intellects of the ancient world; but it was for them a restraining principle, a guide of what they ought not to do rather than of what

they ought. With our Lord, however, it has a wider sweep than this: with Him it is a rule of universal application, a rule of benevolence embracing all our relations to our fellow-men: 'All things therefore whatsoever ye would that men should do unto you, even so do ye also unto them: for this is the law and the prophets.' As such it has been accepted, and acted upon, by Christians ever since. But, as thus interpreted, it is obvious that the principle needs explanation and some limitation. Almost from the outset this seems to have been felt. We have already noticed that in some of the early Latin versions the words 'good things' were inserted after the word 'whatsoever.' This implies clearly that those who made the insertion recognized that it was not everything that we might be said, or thought, or fancy ourselves to wish for ourselves that we are bound to do for others. We might wish for ourselves, for instance, some form of illicit or undesirable pleasure; and we certainly are not bound to provide for others such pleasures or to assist them in obtaining them for themselves. Common sense clearly suggests such a limitation as this. Augustine, in his Commentary on St. Matthew, gets over the difficulty in another way. He draws a distinction between 'desire' and 'wish,' and will not admit that a man, however much he may desire, can really *will* or *wish* for himself that which is not good. This explanation precludes the possibility of our ever doing anything which is not good to others, since we cannot *wish* anything which is not good for ourselves.

Secondly, the maxim does not imply that we should always do to others exactly that which we should wish under our own present circumstances (which may be quite different from theirs) to be done to us. What the maxim implies is that we are, as far as possible, to put ourselves in the place of others; to consider what we would wish to be done to us, *were we in their circumstances*; to adopt the rôle, as Adam Smith puts it, of impartial spectators; and then, having made up our minds what in the circumstances, as so viewed, we should wish to be done to us, to act accordingly.

LITERATURE.—In addition to the authorities cited in the art., see J. G. Tasker, art. 'Golden Rule,' in Hastings' *DCG*.

W. A. SPOONER.

GONDS.—I. Origin, names, and physical characteristics.—The Gonds are an important forest-tribe found in the central parts of the Indian peninsula, at the census of 1901 numbering 2,286,913, of whom the great majority, 1,926,556, are found in the Central Provinces, and smaller numbers in Bengal, Berar, Haidarâbâd, and Madras.

The origin of the name is disputed. They call themselves *Kôitôr* or *Kôitûr*, a plural appellative regularly formed from *Kôî*; in Chhatisgarh they call themselves *Kôyâ*, and high-class members of the tribe object to being called *Gond*, as this name implies that they are cow-killers and beef-eaters (Brett, *Gazetteer Chhatisgarh*, 47; Oppert, *Original Inhabitants*, 109, 145; *IA* viii. 24; Caldwell, *Dravid. Gram.*, 38). Hislop, the best authority on the tribe, derives the name *Gond* from Telugu *gonḍa*, 'a mountain,' in the sense that they are a hill-tribe (*Papers*, 2; Oppert, 13), which is more probable than the theory of Ounningham, that the name is a corruption of *Gauḍa*, the ancient term to designate Central Bengal.

Though the Gonds, probably under Hindu influence, trace a legendary connexion with N. India, which they exhibit by burying their dead with the feet of the corpse towards the Himâlaya, the supposed original home of their race, their physical appearance and speech connect them with the so-called Dravidian races of S. India. They include at the present time a group of tribes with a general physical uniformity, but differing according as they have been more or less exposed to Hindu or to other foreign influences.

Capt. J. Forsyth, who was well acquainted with them, writes: 'Most of the chiefs possess the tall, well-proportioned figure and light complexion of the Hindu, but allied with more or less of the thickness of lip and animal type of countenance of the

pure aborigine. The mass of the tribes, on the other hand, are marked by the black skin, short squat figure, and features of the negretto (*sic*) race of humanity. Between them are found certain sections of the tribes, who would also seem to have been imbued with something of the foreign blood, though in a less degree than the chiefs. Like the latter, they affect much Hindu manners and customs; and it is probable that they, too, are the result of some connection in long past times between immigrant Aryans and the indigenous tribes' (*Highlands of Central India*, 9, 156). Some of the women are 'more like monkeys than human beings'; others 'finer animals by far than the men, and here Hindu blood may be fairly suspected.' Hislop (p. 1) says: 'They have a roundish head, distended nostrils, wide mouth, thickish lips, straight black hair, and scanty beard and moustache; a few have curly hair, but not of the Negro type.'

The same conclusion is reached from a study of their language.

There are some Gonds who speak their own Dravidian language, others a broken Aryan dialect—both known as *Gonḍi*. The Dravidian form of speech has a common ancestor with Tamil and Kanarese, but shows little connexion with Telugu, appearing in various dialects, such as *Mârî* or *Marîâ*, and *Parjî*, both spoken in the Bastar State; and *Gattu* or *Gotte*, the dialect of the Hill Kôia. The true *Gonḍi* speech is known in Ohanda and the Nizâm's Dominions as *Nâiki*, and in Berar as *Kôlâmi* and *Ladhâdhi*, the latter closely connected and differing from other dialects. *Gonḍi* has no literature, except translations of the Gospels and the Book of Genesis (G. A. Grierson, *Census of India*, 1901, i. 279, 287 f.; cf. Caldwell, 518 f.).

2. The tribal legends.—The legends of the tribe have been considerably modified by Hindu influence; but some are original.

They believe that the sky once lay close upon the earth; an old woman, while sweeping, knocked her head against the sky and pushed it away; since then it has remained separate from the earth (Russell, *Census Rep. Central Provinces*, 1901, i. 94; cf. Tylor, *PC*⁴, 1903, i. 322 f.; Lang, *Myth, Rit., and Rel.*, Lond. 1899, i. 291). Eclipses are accounted for by a myth of the earth being turned upside down, and nobody being left alive save one *Dom* (q.v.); the gods, wishing to re-people the earth, borrowed seed-grain from the *Dom*; this was never repaid, and eclipses are caused when he, now king of the *Doms* in the other world, demands it from the sun and moon—a story which seems to be the basis of the myth of *Râhu* in the *Purânas* (Russell, i. 94; cf. Crooke, *PR*², 1896, i. 20 f.). A more elaborate story is that of *Lingo*, a name by some connected with the *liṅga*, or phallic emblem. It tells, in order, of the creation of the world and of the Gonds; how they were driven into a cave by *Śiva-Mahâdeva*; of the birth, death, and life of *Lingo*, the tribal hero; of his revival and how he delivered the Gonds; and how he instituted marriage rites among them. Forsyth (p. 188 f.), who versified the version recorded by Hislop (pt. iii. 1 f.), justly regards it as largely due to Hindu inspiration.

3. History of the tribe.—The early history of the Gonds, except so far as it can be gathered from the tribal legends, is a blank.

They have been identified with the *Kandaloi* of Ptolemy (vii. i. 66; J. W. McCrindle, *Ancient India as described by Ptolemy*, Calcutta, 1885, p. 159 f.), and the *Phyllitæ*, with whom they are connected, are supposed to be either *Bhils* (q.v.), or *Pulindas*—a term applied to various aboriginal races (but see Oppert, 82 n.). The Gonds are remarkable as being the only Indian forest-tribe which has established flourishing monarchies. Of these, four dynasties ruled the greater part of the present Central Provinces from about the 14th down to the 18th cent. of the Christian era (A. E. Nelson, *Gazetteer Jubbulpore*, 47 f.; O. Grant, *Gazetteer Central Provinces*, 1901, p. 281 f.). These kingdoms gained power on the destruction of Hindu authority in N. India by the Muhammadans, and on the disruption of the independent Muhammadan powers of S. India by the Mughal Empire. They attained a fairly high type of civilization, as is shown by the great irrigation works constructed by them. They finally fell before the *Marâthâs* (Grant, *op. cit.*, *Introd.* lxxiii f.).

4. Social position.—It is remarkable that the Gonds, who are now a subject race, have never fallen into a state of degradation, like the menial castes in other parts of the country.

The explanation is that they were protected by the inaccessibility of their country from conquest such as overtook the other aboriginal races; they long held the place of rulers, and were not ousted from possession of their lands by the new race, which appeared as colonists rather than conquerors (Russell, i. 179 f.; Grant, *Introd.* cxii, cxxvi). At present several of the feudatory States in the Central Provinces are ruled by *Gonḍ* chiefs, who belong to the aristocratic branch of the tribe, and call themselves *Râj*, or 'royal,' Gonds. These are gradually asserting their claims to be regarded as *Râjputs*; and one great *Râjput* sept, the *Chandel*, is believed to be of *Gonḍ* origin (Sleeman, *Rambles and Recollections*, London, 1893, i. 231; Smith, *Early Hist. of India*², Oxford, 1908, pp. 360 f., 379 f.). In the plains the lower class, known as *Nâik*, *Dhur*, or *Dhurvê* Gonds, are in a state of serfage, making their living by labour. Between these two groups come the really wild Gonds, of whom the most primitive are the *Marîyâ*, or 'tree,' Gonds, who serve no master, and who subsist by hunting or by a rude system of burning the

jungle and sowing seed in the ashes—a process known as *dahya*—and collecting various kinds of jungle produce. All the authorities believe that these are a peaceable, truthful, law-abiding people when they have not been corrupted by contact with the Hindus of the plains. Under British rule over-indulgence in intoxicating liquors, one of their chief vices, has been greatly checked (Forsyth, 159 ff.; Grant, 84 ff., 187 f.; Hislop, 7).

5. Domestic rites.—The rites of birth, marriage, and death are of the normal Dravidian type (see artt. CENTRAL PROVINCES, vol. iii. p. 311 ff., DRAVIDIANS [North], vol. v. p. 1 ff.).

6. Religion.—‘In religion,’ says Forsyth (p. 148), ‘the Gond tribes have passed through all the earlier stages of belief, and are now entering on that of idolatry pure and simple.’ Every prominent mountain has a spirit, which must be satisfied before its slopes can be cleared. When a field is sown, the field-god, Kodopen, said to represent the god of the *kodo* millet (*Paspalum scrobiculatum*), but more probably a hill-god, is propitiated. The tiger-god has a hut built for him in the jungle so that he may not approach their dwellings. Their worship is chiefly devoted to the propitiation of the malignant Mother-goddess, known as Mātā Devi, the goddess of smallpox, or Mari, who presides over cholera. In her more awful form she is known as Dantesvari, ‘the goddess with teeth,’ at whose shrine in the Bastar State human sacrifices are said to have been performed in early days (Grant, 181, 327; Brett, 39). Her consort is Budhā or Būrhāpen, sometimes known as Thākur, ‘lord,’ who is worshipped as a house-deity. In Seoni he lives in a *sāj* tree (*Terminalia tomentosa*), which is held sacred (Russell, *Seoni Gazetteer*, 58). He has now come to be identified with the Hindu Śiva, and his spouse with Kālī. Animism is represented by the cult of objects supposed to be the abode of spirits. Pharsapen is represented by an iron spear-head (Skr. *paraśu*). The trident said to have been received by the ancestors of the Bastar family from the goddess Bhuvanesvari at Maṭhurā, and the sword given by Mānikyā Devi or Dantesvari, their family-goddess, are still worshipped—a record of the impression made upon a tribe in the Stone Age by the introduction of iron (Brett, 36 f.). Pharsapen is supported by Ghāghrāpen, the bell-god, the bell being sacred, as among the Todas (Rivers, *The Todas*, London, 1906, p. 424; cf. *PR*² i. 168); and by the chain-god, Sānkarpēn, represented by a few links of a chain supposed to be endowed with powers of motion, but really the *gurdā*, or magical chain of the allied tribes, with which hysterical patients are beaten to drive evil spirits from them (Grant, 275; *PR*² i. 99, 155). A favourite household-god is Dūlhādeo, the spirit of a bridegroom who died in a tragical way at his wedding (Sleeman, i. 123 f.; *PR*² i. 119 ff.). Tree-worship is found in that of the bamboo and *sāj* tree (Hislop, iii. 47). The spirits of the dead are propitiated, at least for a year after death; those of distinguished persons are worshipped for some years or generations at earthen shrines, on which sacrifices are yearly offered—a cult which, among the more advanced branches of the tribe, takes the Hindu form (Hislop, 17, 20; Kitts, *Census Rep. Berar*, 1881, p. 79). In Sambalpur the ancestors are represented by small pebbles kept in the holiest part of the house, the kitchen, and periodically worshipped (L. S. S. O’Malley, *Sambalpur Gazetteer*, 75). Many of the exogamous septs are of totemic origin; but totemism seems to be a purely social institution (Russell, *Census Rep.*, 1901, i. 189 f.). Like all secluded races, the Gonds are reputed sorcerers, and witchcraft in a cruel form is sometimes found among the jungle groups (Grant, *Introd.* cxxx ff., 110, 156). Serpent-worship appears, but it is done in secret (*ib.* lxvi). At the beginning of the sowing season, the Gāiti branch set up a line of stones represent-

ing the gods, daub them with vermilion, and make offerings to them; at harvest Būrhādeo is worshipped in the form of a small copper coin; and sacrifices, which in former days included that of a cow, are made to him (Hislop, 22). Among the allied tribes, like the Majhwārs and Kōyis, the beliefs and usages are of a similar type (Crooke, *TC* iii. 413 ff.; Thurston, *Castes and Tribes*, iv. 37 ff.; Bilgrami-Willmott, *Sketch of the Nizam’s Dominions*, i. 325 f.; Risley, *TC*, 1891, i. 292 f.; Dalton, *Descrip. Ethnol. of Bengal*, 275 ff.). For the *baigā* priests of the tribe, see *ERE* ii. 333.

LITERATURE.—S. H. Bilgrami and C. Willmott, *Histor. and Descrip. Sketch of H.H. the Nizam’s Dominions*, Bombay, 1883; J. T. Blunt, ‘Narrative,’ *Asiatic Researches*, vii. (Calcutta, 1803); P. N. Bose, ‘Chhatisgar: Notes on its Tribes, Sects, and Castes,’ *JASB* lix. (1890), no. 3; E. A. de Brett, *Gazetteer Chhatisgarh Feudatory States*, Bombay, 1900; R. Caldwell, *Compar. Gram. of the Dravidian Languages*², London, 1875; A. D. D. Chitroy, *Census Report, Berar*, Allahabad, 1901; W. Crooke, *TC*, Calcutta, 1896; E. T. Dalton, *Descrip. Ethnol. of Bengal*, Calcutta, 1872; C. A. Elliott, *Settlement Report, Hoshungabad*, Allahabad, 1867; J. Forsyth, *The Highlands of Central India*², London, 1859; A. Grant, *Gazetteer of the Central Provinces*, Nagpur, 1870; G. A. Grierson, *Linguistic Survey of India*, iv. (Calcutta, 1906) 472 ff.; S. Hislop, *Papers Relating to the Aboriginal Tribes of the Central Provinces*, Nagpur, 1866; E. J. Kitts, *Census Report, Berar*, Bombay, 1881; A. C. Lyall, *Gazetteer of the Haidarabad Assigned Districts*, Bombay, 1870; L. S. S. O’Malley, *Gazetteer of Sambalpur*, Calcutta, 1900; A. E. Nelson, *Gazetteers of Jubbulpore, Raipur, Bilaspur*, Allahabad, 1900-10; G. Oppert, *The Original Inhabitants of Bharatavarsa or India*, London, 1893; R. V. Russell, *Census Report, Central Provinces*, Nagpur, 1901, *Gazetteers of Seoni, Allahabad, and Nagpur*, Bombay, 1907-08; E. Thurston, *Castes and Tribes of S. India*, Madras, 1909.

W. CROOKE.

GONGS AND BELLS.—I. Scope of the present article.—Among instruments of percussion the bell and the gong hold the first place, either one or other being found among most races of mankind. To define the difference between bell and gong is not easy. A bell is a hollow cup-shaped body made of cast metal, giving a sonorous vibration throughout its entire circumference when struck by a metal clapper usually hung inside. A gong, on the other hand, is usually made of hammered malleable metal, flat or approximately flat in form, and is struck by hand with a soft mallet. Many of the Chinese ‘bells’ are made without an internal clapper, and are struck on the outside edge with wood. Presumably they are gongs, although bell-shaped. The essential differences, then, are that a bell is struck by a metal clapper, while a gong has a hammer of material other than metal, and that the sound of a bell is usually obtained by the movement of the bell, while the gong remains stationary. The small crotal bells and bells made of riveted plates, which are used for religious purposes by some peoples, are included in this article.

Onomatopœia plays a large part in the title of bells. The Lat. *tintinnabulum* suggests the tinkling of the hand-bell. The bellow of the large mass suggests ‘bell,’ from Lat. *bellare*, O.E. *bellan*. ‘Gong’ is suggested by γογγύζειν, ‘to murmur.’ *Campana* is used in later writers for a large bell, and *nola* for the small hand-bell.

The object of the present article is to give by typical examples some idea of the significance of the religious use of bells.

2. Origin of bells and gongs.—As to the origin, there is considerable difficulty. Wide search among encyclopædias and books dealing with campanology meets with an almost unvarying intimation that ‘the origin of bells is lost in antiquity; they probably came from the East.’ Such a statement is unsatisfactory enough. Some bolder writers refer to the bells on Aaron’s high-priestly clothing (Ex 28³³) as the earliest mention. But these probably were not really bells but merely jingles—small carved pieces of metal which emitted sound by striking against the metal pomegranate, and not by a clapper. The two formed an ornamental design similar to the lotus and bud border

used in Egypt (*HDB*, art. 'Bell'). Then, too, there is evidence of the art of bell-making being practised in Japan during the 8th cent. B.C., at the time when large bronzes were cast for the temples of Buddha.¹

Such evidence, however, does not help us to find out the origin of these instruments of percussion, and we are reduced to conjecture. Quite probably bells may date from the Iron Age. Fairies and witches were creatures belonging to the more ancient Stone Age which was passing away; and the new metal, iron, was considered hateful and harmful to them.² The metal itself was a powerful prophylactic, but the sound of metal had even greater virtue for restraining their evil influence. It would soon be found that by striking the edge of metal pots a more resonant note could be obtained than from an iron bar; and from this it is but a small advance to turn an iron basin upside down and fasten some sort of a clapper inside. Armed thus, man would feel himself fairly safe from the attacks of his spiritual foes. Such a possible explanation of the origin of bells and gongs has at least the merit of being simple and of complying with the stereotyped phrase, 'the origin of bells is lost in antiquity.'

3. Early uses of bells.—Probably the earliest use of bells was, as has been said, prophylactic. Man, who believed the air to be crowded with demons eager to destroy him, used the most efficacious safeguards that came to hand. Among all peoples we find the bell used for this purpose, and even in the Christian era this superstition has survived.

The gong of Dodona³ mentioned by Aristotle (*Suidas*, s.v. χαλκείον Δωδωναίων) seems to have consisted of two pillars supporting respectively a cauldron (λάβηρα) and the figure of a boy (παῖδα) grasping a whip, whose bronze lashes, when swayed by the wind, struck the inside of the bronze cauldron and produced a resonant sound which was considered to have oracular intent. Theocritus (ii. 36) refers to bronze as employed in all kinds of purificatory ritual. Moreover, it was considered as itself pure, while the sound of it was an averter of pollution. From many Latin sources we know that bronze was beaten at eclipses to avert the evil. Bells were sometimes placed in tombs. A bas-relief in the Louvre (*Fröhner, Cat.* 545; *S. Reinach, Répertoire de la statuaire grecque et rom.*, Paris, 1897-98, i. 101) represents the sacrifice of a ram to Attis, from an old oak whereon are suspended two bells. On a coin representing Cybele enthroned with Attis at her side two bells are seen in the foreground. P. Gusman (*Pompeii*, Paris, 1899, p. 146) gives illustrations of many little bells found at Pompeii, and speaks of them as used 'comme moyen de protection.' The British Museum possesses a small bronze bell (*Cat.* 318, fig. 11) from the temple of the Kabiri at Thebes. The attendants of Dionysus are frequently represented as carrying tympana edged with a row of small bells. A small bell of gold found on the Esquiline has an inscription referring to the evil eye. Moreover, to avert evil influences, bells were attached to the heads of horses used in a procession of criminals led to execution.

Possibly the gongs or bells attached to the façade of the second temple of Jupiter Capitolinus have this prophylactic object. Triumphant generals hung bells on their horses' heads to avert the evil eye. This is found not only in Greece but also on sculptures in Assyria.⁴

¹ J. L. Bowes, *Japanese Marks and Seals*, Liverpool, 1882, p. 275.

² Tylor, *PC* i. [1903] 140.

³ A. B. Cook, *JHS* xxii. [1902] pt. 1, p. 5 ff.

⁴ For further illustrations of such usage, see *Smith's Dict. of Gr. and Rom. Ant.*, London, 1890, s.v. 'Tintinnabulum.'

Among the Greeks a bell was used at funerals to keep off the crowd and warn the *flamen Dialis* lest he be polluted by sight or sound of funeral music. But there is evidence of usage other than as a prophylaxis. Bells were used for the opening of market or the baths, and by sentries on night duty. The priests of Proserpine at Athens rang bells when calling the people to worship. Small bells were similarly used in the mysteries of Bacchus. But for the most part the Greeks had wooden rattles, such as are now used by Muslims. The use of bells for summoning to worship arose in the Far East, and was not customary in countries bordering the Mediterranean till late Roman times.¹ In Egypt, Palestine, and Assyria, people were summoned to worship by the sound of the trumpet. The precise purpose of the bells attached to high-priestly robes seems debatable. Arabian princesses have bells on their garments to announce their movements and warn people to keep out of the way. No one was allowed to enter the Persian court without giving audible warning, and perhaps the bells on Aaron's robe were intended to announce his movements to Jahweh. An alternative suggestion is that the stillness of the Holy Place was full of peril to intruders. The air became charged, as it were, with the Divine influence, and this was dangerous to mortals. In order to dissipate this noxious condition, the high priest's robe was decked with bells, which, by stirring the laden air, made it possible for man to enter the Holy Place. More obviously the jingles are explained as useful to let the people know how the high priest was progressing with his ministrations. The horse-bells in *Zec 14*²⁰ are inscribed 'Holy unto the Lord.' The object is not clear. It may have been intended to add efficiency to any magical powers the bells possessed, or else the bells may have been thought of as sending far and wide the message of holiness.

4. Christian use of bells.—At the dawn of the Christian era bells were used, but the Greek and Roman style of architecture did not readily lend itself to the use of large bells in buildings. During the first three centuries the use of bells for summoning the faithful to worship was impossible, owing to the certainty of persecution; but it is probable that soon after the Edict of Milan (A.D. 313) the Christian Church availed itself of this obvious means of calling to worship. The introduction of large bells is attributed to Paulinus, Bishop of Nola in Italy, about A.D. 400; but, as he omits any reference to bells in his letter giving a very full description of his church, the claim made for him seems to be doubtful. St. Jerome (*In Joel.* 2¹². [*PL* xxv. 964 f.]) speaks of musical instruments used in religious worship under the generic name *tuba*; and, although his description is not clear, it appears that small peals of bells were used in conjunction with trumpets.² Certainly, however, by the 6th cent. bells were used in the Western Church. Gregory, Bishop of Tours (573), speaks of bells as *signa*. This takes us back to Sidonius Apollinaris. Rather later the *Gregorian Sacramentary* (590) contains a formula of benediction which came from Rheims. The *campaniles* give fairly strong evidence of the use of bells before the end of the 6th century. That of Ravenna dates from the 6th century.

Quite early in the Celtic Church bells were used by the bishops as part of their episcopal insignia. In the *Life* of St. Patrick the office of *campanarius* is mentioned, and in an illustration, given by de Fleury, in *La Messe*, St. Patrick is depicted as

¹ K. Sittl, *Archdologia der Kunst*, Munich, 1895, p. 246. A few small bells have been found at Gezer (*PEPSt*, 1904).

² Paul Lacroix, *The Arts in the Middle Ages and at the Renaissance*, Eng. tr., London, 1870.

handing a bell in a box to a bishop consecrated by him. The probable object of the bell was to command silence when the bishop was about to speak. In the museum of the Royal Academy of Ireland a Celtic bell is preserved which on fairly good evidence is attributed to St. Patrick. Small hand-bells were often engraved with the name of a saint, and in later years were venerated as relics.¹ Bede (*HE* iv. 23) mentions a bell rung after the death of Hilda at Whitby (680). Adamnan (*Vita S. Columbæ*) has references to a *clocca* which was used to call the brethren to prayer. Egbert, Archbishop of York (740), in his 'Excerptions' ordered his clergy to toll bells at the hours of service. We first hear of a peal of bells at Croyland Abbey in 960; but, as Ingulphus compares the tone of it with others, it seems clear that many other churches had more than a single bell for summoning to worship. Early in the reign of King Edgar (960) the new canons provided for bell-ringing as preliminary to prayer in church, and the clergy of the Church of England are still required to toll a bell daily before service.

Another use for bells is indicated in the Bayeux tapestry.² In the illustration of the funeral of Edward the Confessor the corpse is accompanied by two boys, each ringing a pair of hand-bells. This was a practice taken from paganism, but with altered intentions. The ringing of bells at funerals called the faithful to pray for the departed soul. Still, however, the supposed power of driving away evil spirits was commonly believed in, and the ringing of hand-bells at funerals was carried to such excess during the 14th cent. that the abuse called for the attention of the bishops. Not only were bells carried by the funeral officers, but the people used to open their doors and ring vigorously any bell they had while the cortège passed by. The 'lych' bell is still rung at Oxford before the body of any University official is carried to burial.

Distinct from this is the custom dating from the 7th cent. and enjoined by Canon 67: when 'any is passing out of this life, a bell shall be tolled, and the minister shall not then slack to do his last duty.' This is the 'passing bell.' During the ages of superstition men lost sight of this call to pray for the 'passing' soul, and thought of the bell as a means of scaring away the evil spirits lying in wait for the dying man's soul. After death the 'soul' bell was knelled in order that all might give thanks for the deceased's deliverance from this vale of misery. This custom was carried to such excess that Elizabeth forbade more than one short peal, lest it should be an annoyance to the living and injurious to the fabric and the bells themselves. In later times the varied uses of bells in funerals have been curtailed; the 'passing' bell has become merged in the 'soul' bell, and, being knelled some time after death, serves as an intimation of the age and sex of the departed.

Indisputably, during the Middle Ages bells were chiefly valued for their prophylactic powers in scaring the evil spirits from doing harm ghostly and bodily. Most wide-spread was the idea that bells could dispel storm and lightning. Originally the object was to call the people to church to pray for deliverance from the danger. Then the devil was thought of as hating the sound of bells, because they called the faithful to prayer; and, later, the original idea was lost sight of, and the mere ringing of bells was considered efficacious of itself. Largely owing to their popularity, bells escaped the destruction of things 'Romanish' at the Reformation. In order to increase their supposed

¹ O. Rohault de Fleury, *La Messe*, Paris, 1883, vol. i.; see also Joyce, *Soc. Hist. of Anc. Ireland*, London, 1903, i. 372-378.

² G. S. Tyack's *A Book about Bells* (London, 1898) contains much fairly reliable information about English customs. It is probably the best book on the subject.

efficacy, bells were 'christened' with elaborate ceremonial. Originally the bells were thought of as heathen, and were baptized to make them converts; but, later, the object was clearly to strengthen their powers over the spirits of the air. Charlemagne in 789 protested against this 'baptism,' but the rite found a place in most pontificals until the Reformation, and is still used on the Continent.

In pre-Reformation times it was rare to find fewer than two or three bells in one tower. Frequently a small bell was hung in a bell-cote over the chancel and rung at the Elevation of the Host. This 'sacring bell' gave intimation to sick folk of the consecration of the elements. Distinct from this was the *sanctus* bell, a small hand-bell tinkled within the church at the 'Ter Sanctus,' and necessary in large churches, where the musicians were at a distance from the high altar. In the Middle Ages bells were often embroidered on bed-curtains and other hangings, as well as on ecclesiastical vestments.¹ The fundamental idea was probably superstitious. For the many other religious and quasi-religious uses reference should be made to some of the excellent books mentioned in the Literature. The same underlying ideas seem to inspire the Continental use of bells, the real difference being the method of ringing large bells. Change-ringing is confined to Great Britain; abroad the carillon takes its place. It is a mechanical contrivance by means of which a number of elaborate tunes can be played by one performer on the bells by hammers which strike the edge of the bell. In England bells are chimed in this way and also rung. In ringing, the bell is made to swing round through a complete circle so that the clapper strikes twice in each revolution.

5. Non-Christian uses.—To the Far East we must look for the earliest use of bells, but there is little evidence before the 8th cent. B.C. At that time large bells and gongs are found to have a definite part in ceremonial. One dating 677 B.C. is inscribed: 'We will everlastingly prize this bell and use it in our ritual worship.'² This bell would be hung in the temple, its purpose being to call the shades to the funeral meats prepared for them.

In Buddhistic ceremonial, bells and gongs play a large part. The noise made during certain rites is quite deafening,³ the object being to call the attention of the divinity to the prayers and ceremonies of the devotees. The pagoda style of architecture lends itself to the suspension of a number of bells which are made to tinkle by the wind. This is considered by many to be prophylactic, and to scare away the demons. The Buddhistic theogony is practically identical with the Brāhmanical, and a bell is invariably connected with every Buddha as part of the insignia. The opening up of Tibet has given us several books upon the Buddhistic ceremonial. In Lhasa the more saintly of the lamas wear a tinkling bell on the crown of their hats. Before their devotions the chief lamas cross themselves, touching their foreheads with a bell; and they hold a special service for one who is sick, in which tinkling bells are used.⁴ Hand-bells are placed upon the very altar itself. The probable use in these cases is to attract the god's attention.

The supposed influence of the bell on the spirit world is further illustrated by the attempts to expel the death-demon by the aid of bells. In India we find these usages supplemented by others.

¹ Several examples in M. E. O. Walcott, *Sacred Archaeology*, London, 1868.

² Bushell, *Chinese Art*, London, 1909, i. 84.

³ I. L. Bird (Mrs. Bishop), *Unbeaten Tracks in Japan*, London, 1890.

⁴ L. A. Waddell, *Lhasa and its Mysteries*, London, 1906, and *The Buddhism of Tibet*, London, 1895.

According to the Brāhmins, two things are indispensable to the sacrificer—several lighted lamps and a bell to wake the divinity from sleep so that he may consume the offering, while the vagrant ghost is scared away by the same sound.¹ The *patāri* priest in Mirzapur and many classes of ascetics carry bells and rattles of iron which move as they walk, the object being to protect the wearer from evil spirits. The Gonds have elevated the bell into a deity, in the form of Ghāghrāpen, or 'bell-god'; and one special class of their devil-priests, the *maṛiā ojhyāls*, devote themselves to making bells; and they themselves wear them continually. The Todas of Madras worship Hiriya Deva, whose representative is the sacred buffalo-bell which hangs from the neck of the finest buffalo of the herd (Crooke, i. 168). The goddess Pārvati, as Durgā (q.v.), has certain insignia which are invoked in this manner: 'Om to the bell (*ghanṭā*) striking terror by thy world-wide sound into our enemies. Drive out from us all our iniquities. Defend and bless us, O Lord.' In Burma great bells are found at most of the shrines. The worshipper takes a large deer antler and strikes first the ground and then the bell, to summon as witnesses beings under and above ground, and further to make them join in the act of worship.²

In West Africa some witch-doctors have a custom, when going their rounds, of ringing a bell before the house of the guilty. Bells are often hung over doorways, probably for prophylaxis.³ Very few bells are found in the rest of Africa, except among the Masai and tribes of similar culture. They hang bells around the necks of animals, but there is no evidence to show that these were worshipped, or that the bells were used to scare evil spirits. Probably they are merely utilitarian.

In Egypt there is little evidence. The *sistrum* was invariably used in the worship of Isis. Possibly small crotal jingles were attached. In later times bells were used as charms, but with no real musical purpose, and they are very rarely found in Egyptian religion proper. The same may be said of bells among the Assyrians. They had no religious use and very little in magic. Clappers took the place of bells. Layard (*Monuments of Nineveh*, London, 1849-53) illustrates some horse-bells, possibly importations for magical purposes.

Bells and instruments of percussion are not found in New Zealand. In the Tonga and Fiji Islands a *lali* is used. It is a form of gong made out of a tree-trunk.⁴ It is the favourite instrument at Tonga and is named in the same way that we give names to our bells. It is chiefly used to summon worshippers to their religious exercises. In many parts of the world babies are given rattles to which jingle bells are attached. The underlying object is probably prophylactic.

Although the religious value of bells varies considerably in different parts of the world, in Turkey alone is there found an aversion to their sound. The Muhammadans do not use them, because of their associations with Christianity, and the Pañjābī Muslims have a prejudice against gongs, as they are supposed to disturb the dead, who awake, thinking the Day of Judgment has arrived.

LITERATURE.—In addition to books mentioned in the footnotes, see H. T. Ellacombe's list of books in *NQ*, 5th ser., vol. iii. pp. 42, 82, 163. See also Hieronymus Magius, *de Tintinnabulis*, Hague, 1724; M. E. C. Walcott, *Parish Churches before the Reformation*, Lincoln, 1879; W. W. Rockhill, *Land of the Lamas*, London, 1891. Most modern encyclopedias contain

¹ J. Lubbock, *The Origin of Civilisation*, London, 1902; T. H. Lewin, *Hill Tracts of Chittagong*, Calcutta, 1869; G. Oppert, *Original Inhabitants of India*, London, 1893; J. A. Dubois, *Descr. of the People of India*, London, 1817.

² Max Ferrars, *Burma*, London, 1900.

³ M. H. Kinguley, *Travels in West Africa*, London, 1897, pp. 464, 460.

⁴ *Annales de la Propagation de la Foi*, 1860.

information of little value. S. Madge, *Moulton Church and its Bells*, London, 1895, has a bibliography of 204 books. For Scottish bells, see D. Wilson, *Archæology and Prehistoric Annals of Scotland*, Edinburgh, 1851; for Irish bells, M. Stokes, *Early Christian Art in Ireland*, London, 1875; for bells of England, J. J. Raven, *Bells of England*, London, 1906; H. B. Walters, *Church Bells of England*, Oxford, 1913 (with an admirable bibliography; the latest and best book on the subject). For a good account of change-ringing and bell-manufacture, see art. 'Campanology' in *EBR*¹⁰. For a manual H. B. Walters, *The Arts of the Church: Church Bells*, London, 1908, is of value.

ADDISON J. WHEELER.

6. American bells.—(1) Bells of metal were in use in certain regions of America long before the Columbian discovery. They were natural developments from, or modifications of, previously existing rattles and like implements of clay, shell, gourds, and other materials. According to W. H. Holmes (*Bull. 3 BE* 22-24), metal bells were in common use in Middle America in pre-Columbian times, but they are rarely found north of the Rio Grande, either in possession of the tribes or on ancient sites; but bells were certainly known to the Pueblos and possibly to the mound-builders before the arrival of the Whites. The copper bells occasionally found in the south-eastern part of the United States may, some of them at least, have been introduced by way of trade (like certain varieties of tobacco-pipe and tomahawk) with the Indian tribes, since specimens of undoubtedly European origin have been discovered in mounds and other burial-places that are distinctly post-Columbian. Others of the metal bells from this region may, however, have been brought to the north by way of Florida, etc., from Central America and Mexico as incidents of inter-tribal commerce or the like. Metal bells are also known in large numbers from the remains of the civilizations of the Pacific coast of South America and from the area of so-called 'Calchaqui culture' in the Catamarcan country of Argentina, etc. Bells of other materials, such as clay, are, of course, more widely distributed among aboriginal peoples of a type less civilized than the Aztecs, Mayas, Peruvians, and others very close to them in matters of art and religion. Many wooden bells have also been found, e.g., in the Atacaman region of Pacific South America (*Boman, Antiq.*).

(2) Some investigators were formerly of the opinion that the bells found in the New World were all imitations of European models, and that no such thing as a genuine pre-Columbian bell of aboriginal manufacture existed. But for the Pueblo region, as well as for Mexico, Central and South America, the existence of bells of Indian make long prior to the coming of the Whites has been demonstrated. The variety in the forms of the bells of primitive America, their presence as ornaments on statues, figures of the gods (Mayan MSS and monuments; Aztec deities, etc.), their utilization as decorative *motifs* (e.g. eyes in the golden figures of reptiles from ancient Chiriqui), the situation and circumstances of their discovery in ruins of great age in different parts of the continent—all these facts make the theory of European origins impossible, and it has now been abandoned by the best authorities. The existence of bells of wood, clay, copper, and gold testifies to the evolution of a bell in primitive America from the rattle. According to Holmes, the genealogy of the bell is first a nut-shell or gourd, then a clay model, and, finally, metal forms cast upon models, like those of the ancient Chiriquians. Doubtless some of the less civilized tribes imitated in clay or wood the metal bells of their neighbours of higher culture, which sometimes came to them in the way of trade, or in some other incidental fashion. The more or less civilized peoples, upon whom the Europeans intruded, may have also, at times, imitated bells of

Old World origin. There seems no doubt, however, that bells, used for several different purposes, were in existence in pre-historic times in various regions of North, Central, and South America.

(3) Both metal and clay bells seem pre-Columbian in several parts of the ancient Pueblo region of New Mexico and Arizona. The small copper hawk-bells obtained from ruins in southern Arizona are said by Fewkes to be 'identical in form and make with those used by the ancient Nahuatl [Aztec] people' (17 *RBEW*, pt. 2, p. 629). A clay bell found in the oldest part of the old pueblo of Awatobi, and in all probability pre-historic, is regarded by Fewkes as 'made in exact imitation of one of the copper bells that have been reported from several southern ruins' (*op. cit.* p. 629). In this case the Pueblo clay bell would be modelled upon the copper bell, and not *vice versa*. In Awatobi was also discovered a fragment of a copper bell of Spanish origin, such objects coming into the Pueblo country with the Catholic priests and their churches. In the Tusayan ruins immediately about the inhabited towns, Fewkes found no copper bells of such great age that they could be called pre-historic. A fragment of one of the old Spanish or Mexican church-bells 'was used for many years as a paint-grinder by a Walpi Indian priest' (*op. cit.* p. 609). Hough found that bells of clay, like those from Awatobi described by Fewkes, were somewhat numerous in the great ruin of Kawaiokuh. They are undoubtedly pre-historic, and earlier than the bells, similar in form, used in trade. In ancient Mexico bells (*tzilinilli*) of copper were in general use before the Spanish Conquest, and from the Aztecs the knowledge of them passed northward to some of the less cultured peoples of the southern United States. The characteristic Mexican bell has rather marked and peculiar differences of form and structure which indicate its aboriginal origin. The ancient Aztecs had also large numbers of little golden bells, employed chiefly for ornament, and for use in dances and other ceremonial observances, sacrifices, etc. Metal bells were known also to the semi-civilized races of Central America, the copper bells of the ancient Chiriquians of the Panama region being especially noteworthy. Spinden (*Mem. Peab. Mus., Harv. Univ.*, 1913, vi. 146) states that copper bells, 'similar to the common sleigh-bell,' were well-known in the Maya country; a few gold bells have also been found there. Some of them, after having been cast, were 'plated' or 'washed' with gold. One of these Chiriquian bells is very interesting as having upon it the features of a human face. Others are surmounted by rude figures of animals, through the bodies of which, or under them, are apertures for cords, etc. Some have holes for such purposes at the top. Most remarkable, and suggestive of the intimate relationship between the bell and the rattle, is a triple bell or rattle of gold found on the Rio Grande near Panama. This instrument consists of 'three very neatly shaped and gracefully ornamented bells mounted upon a circular plate, to which a short handle is attached' (Holmes, *op. cit.* p. 23 f.). On the handle is the figure of a bird. In the case of the bell with human features, 'double coils of wire take the place of the ears, and the other features are formed by setting on bits of the material used in modelling' (*ib.* p. 23). Many bells more elaborate in character than this are reported from Chiriqui. The Pacific coast area of South America, with its several different 'civilizations,' has furnished many examples of the bell. Capitan has recently described some bronze and copper *tintinnabula* with movable rings and hollow spaces to contain pebbles, bits of metal, etc., from ancient Peru. One is of an entirely new type. Some re-

call certain Buddhist *tintinnabula*, and likewise those of the lake-dwellings of the Bronze Age.

The bronze and copper bells of the Calchaqui region, especially those from the province of Salta in Argentina, have a very characteristic form, slightly resembling, according to Ambrosetti, certain ancient Chinese bells. The mouth is a sort of compressed ellipse, the sides flat, falling in as they reach the narrow top. No bells of this shape seem to have been discovered in the ancient Peruvian sites. These Calchaquian bells are perforated, for suspension, at the top, and they are ornamented with figures whose nature is much the same as those occurring on certain bronze disks from the same region. One bell from Curtiembre has on each face the outlines of five human countenances; others have three, two, one, in like manner. Other ornamentations are triangles, vertical lines, zigzags, animal figures, etc. Besides these, another sort of bell from the Calchaqui region is described by Ambrosetti, which is also prior to the Spanish Conquest. The form is that which would be produced by making four folds in a very thin lamina of metal, so as to shape it somewhat after the fashion of certain hats or fancy dishes. There are some more modern bells of this type which have been modified through Spanish influence (in the clapper, the tang, etc.). But the general form of the ancient bell has been preserved. These bells, Ambrosetti thinks, were used by the Indians to attach to the domestic llamas, or to suspend from their clothes or belts in dances and festivals, as the Indians of the Gran Chaco still do with fruit-shells, the ancestors of the bell. In the pre-historic necropolis of Calama (Chilian province of Antofagasta), in the area of Atacaman culture, Count G. de Créqui-Montfort discovered in 1904 a wooden bell similar in form to the Calchaquian copper bells of the first sort described above (Boman, *op. cit.*).

(4) The uses to which bells were put in aboriginal America were various. Concerning the Pueblo Indians, Fewkes informs us: 'Copper bells are said to be used in the secret ceremonials of the modern Tusayan villages, and in certain of the ceremonial foot races metal bells of great age and antique pattern are sometimes tied about the waists of the runners' (*op. cit.* p. 628). Many of the small clay bells from the Pueblo region and elsewhere were also used as pendant ornaments of some sort, as were doubtless also some of the smaller metal bells from various parts of the continent. The nature of many of these, which are provided with holes or with perforated tangs, indicates their suspension to a cord or some similar object, and their attachment to articles of dress or ornament. One of the clay bells from Pueblo ruins still contained its pellet of clay, and 'on being shaken, produced an agreeable tinkling sound'; it was evidently used as a bell to produce musical sounds—a purpose likewise served by many other bells of metal and clay in ancient America. Here the bell lies close to the rattle. On ancient sites in New Mexico and Arizona, besides clay bells of this sort, copper bells with stone tinklers have been discovered. In various parts of Mexico and Central America little bells of gold were employed as ornaments, as the devices for suspension and attachment prove. In ancient Mexico such bells were attached to the ankles of important warriors and other prominent participants in ceremonial dances. They were also attached to the feet and wrists of victims of sacrifice, those who represented deities, etc. The gods Tezcatlipoca, Tlaloc, and Huitzilopochtli, in particular, were represented with little golden bells at their ankles (in the case of the first, to the number of twenty). According to Cogolludo, copper bells were to be found in the houses of the

nobles among the Mayas. The Mayas also used bells as ornaments for their gods, etc., represented in the hieroglyphic writings. Brinton mentions the fact that Ah-Puch, the god of death, occasionally has bells attached to his ankles and clothing. One of the Mayan signs usually interpreted as 'eye' may really represent sometimes the small bells used for ornament. Holmes found that 'the eyes of the golden figures of reptiles [ancient Chiriqui] are in many cases minute hawk-bells' (*op. cit.* p. 24). According to Ximenes de la Espada, some of the ancient Peruvian rattles and bells were used in religious ceremonies 'to call the devil' (Capitan). In some parts of Central America little bells are said to have been in use as a sort of currency.

LITERATURE.—J. B. Ambrosetti, 'El bronce en la region Calchaqui,' *Anales del Mus. Nac., Buenos Aires*, xi. (1904) 183-314, esp. 229-230, 257-264; H. H. Bancroft, *Native Races*, San Francisco, 1876, i. 705, 765, ii. 290, 319, 324-325, 706-737, 749-750, 787, iii. 238, 324, iv. 556; E. Boman, *Antiquités de la région andine de la république argentine*, 2 vols., Paris, 1908; D. G. Brinton, *A Primer of Mayan Hieroglyphics*, Boston, 1895, pp. 64, 83; Capitan, *Décades américaines*, 1st ser., Paris, 1907, pl. v. (Sonnailles péruviennes); J. W. Fewkes, 'Archeol. Exped. to Arizona in 1895,' *17 RBEW*, pt. 2 (1898), esp. 609, 628, 631; W. H. Holmes, 'The Use of Gold and other Metals among the Ancient Inhabitants of Chiriqui, Isthmus of Darien,' *Bull. S BE*, 1887, esp. pp. 22-24; W. Hough, 'Archeol. Field-Work in N.E. Arizona,' *Rep. U.S. Nat. Mus.* 1901, Washington, 1903, esp. p. 342; H. J. Spinden, 'A Study of Maya Art,' *Mem. Peab. Mus., Harv. Univ.*, 1913, vi. 1-285; R. Wallaschek, *Primitive Music*, London, 1893, esp. pp. 47, 106-107; T. Wilson, 'Prehistoric Art,' *Rep. U.S. Nat. Mus.* 1896, esp. p. 594.

ALEXANDER F. CHAMBERLAIN.

GOOD.—See GOOD AND EVIL, SUMMUM BONUM.

GOOD AND EVIL.—I. GENERAL DEFINITION.—When we collate instances of their usage, we find that the meaning and implications of 'good' and its opposites are most varied. Let us take at random 'good measure,' 'a good beating' (which, curiously, is synonymous with a bad beating), 'a good dinner,' 'good music,' 'a good knife,' 'a good soldier,' 'a good intention,' 'a good man.' In the series scarcely two will be found wherein 'good' means in the one precisely what it means in the other. In all cases, in pronouncing a thing good we are judging its value, and the meaning of 'good' or its opposite in any particular case depends on the point of view from which we judge. It may be almost a purely quantitative judgment, e.g. 'a good ten miles.' It may be a judgment of sensuous value, in which case 'good' = 'pleasant' or 'agreeable,' e.g. 'it tastes good,' 'a vile odour.' It may be an æsthetic judgment, e.g. 'a good view,' 'bad music.' It may be expressive of the suitability or efficiency of tools, instruments, implements, etc., as means to particular ends, e.g. 'a good knife.' It may be a judgment of skill, e.g. 'a good marksman.' Then come the senses of 'good' and 'evil' of most importance, and almost exclusive importance for our present purpose, good as well-being, good as well-doing, evil as the opposite of both.

It is possible to frame a broad general definition of 'good' and 'evil' which shall include all the above varieties of meaning. Such a definition is given by Naville (*Problem of Evil*, ch. i.), who puts it: 'Good is what ought to be, evil is what ought not to be.' To this two objections may be raised. (1) There is no valid application of 'ought' to unthinking non-moral objects. In strictness of language, to say that an instrument such as a pen ought to be of a particular quality is absurd. (2) 'What ought to be' seems to apply better as a description of what is right. And, though the right and the good may largely be identical, the implications of the two are different, and the difference is worth marking and conserving. 'Right' means according to rule. 'Good' means valuable

for some end, therefore desirable. Both in 'right' and in 'good' there is reference to a standard or ideal; but, while 'right' emphasizes the compelling, prescribing power of that ideal, 'good' emphasizes its attractive power. Hence, if we wish such a broad general definition, we should say that the good in all its senses is the desirable, and the evil is the undesirable (cf. Sidgwick, *Methods of Ethics*, London, 1901, p. 110 f.). This seems to be the summary of Royce's statement:

'By good, as we mortals experience it, we mean something that, when it comes or is expected, we actively welcome, try to attain or keep, and regard with content. By evil in general as it is in our experience, we mean whatever we find in any sense repugnant and intolerable. . . . We mean [by evil] precisely whatever we regard as something to be gotten rid of, shrunk from, put out of sight, of hearing, of memory, eschewed, expelled, assailed, or otherwise directly or indirectly resisted. By good we mean whatever we regard as something to be welcomed, pursued, won, grasped, held, persisted in, preserved. And we show all this in our acts in presence of any grade of good or evil, sensuous, æsthetic, ideal, or moral . . . whether you regard us as animals or as moralists, whether it is a sweet taste, a poem, a virtue or God that we look to as good; or whether it is a burn or a temptation, an outward physical foe or a stealthy, inward, ideal enemy that we regard as evil' (*Studies of Good and Evil*, 18).

It may be noted that, in defining the good as the desirable and evil as the undesirable, we are not committing ourselves to a hedonistic view. It is a false psychology which maintains that the only object of desire, therefore the only desirable, is pleasure.

II. GOOD AND EVIL ACTIVE AND PASSIVE.—While the definition of good and evil as the desirable and the undesirable respectively would probably be universally accepted, it is certain that, as soon as individuals begin to fill in the definite content of the general notion, there will be nothing approaching unanimity; and this fact constitutes one problem with which we must deal. But, before approaching it, it is best to draw a distinction between two kinds of good and evil. There is good which comes to us, and good which starts from us. There is evil which befalls us, which we suffer and endure; on the other hand, there is evil which we do. This is not represented as an absolute distinction; the two kinds are inter-related in a variety of ways; still it is a convenient distinction. It is not easy to find appropriate names for the two kinds. Fairbairn designates them *physical* and *moral* (*Philos. of Christian Religion*, 134), but 'physical' must be used in a somewhat unusual and perhaps scarcely justifiable sense.

'Physical evil means all the sufferings he may have to endure, whether bodily or mental, nervous or sympathetic, alike as a distinct individual and a social unit, alike as a natural being, fleshly and mortal, and as a human being, sharing in the special history of a people and in the collective fortunes and immortality of the race' (*op. cit.* 134 f.).

Now, as regards the good and evil that befall men there will be little lack of unanimity. Health, strength, abundance of food, gifts of fortune or of friends, and a multitude of such like things will be classed as good universally. Sickness, accident, death, penury, destructive forces of Nature, and a host of other ills to which men are exposed will be as universally acknowledged to be ills. With regard to this kind of good and evil, men differ only in the number of goods and ills they know, and in the degree of importance which they attach to this or that particular good or ill. When we turn, however, to consider moral good and evil, the good or evil that men do, we find an altogether different situation. Here we find endless variety in the beliefs of men as to what is good and what evil.

It does not lie within the scope of this article to set forth and discuss the various ways in which at different times and by different individuals the good has been more particularly defined. For that the art. ETHICS and articles dealing with various schools of ethical speculation must be consulted. But here it is necessary to try to gather the signifi-

cance of the fact that there is no universal agreement among men as to what conduct is good and what evil. That is plain from consideration of the variety of view maintained in different systems of ethics. It is still plainer and becomes a problem when we consider the contrariety of opinion and practice among mankind in general. What in one place is esteemed as virtue, in another is held to be vice; for what some men approve most highly others cannot find words to express their abhorrence.

'We hardly know of anything just or unjust which does not change its character with a change of climate. Three degrees of polar elevation overturn the whole system of jurisprudence. A meridian determines what is truth. . . . There is not a single law which is universal' (Pascal, *Pensées*, ed. P. Faugère, Paris, 1844, ii. 1261.).

This raises the problem, Are good and evil purely relative? Are we to say *homo mensura*? If 'somewhere east of Suez there ain't no ten commandments,' have we simply to acquiesce in the fact, because others may be as right in their notions as we?

III. OBJECTIVITY OF MORAL LAW.—If we answer the foregoing questions in the affirmative, it is obvious that all moral effort has lost its spring and inspiration. Further, morality which should be purely subjective and individualistic would not be morality at all. The ineradicable belief of every moral being is that the law he obeys, the ideal he strives to realize, are something of universal validity: valid for and binding on him not as *ἀνθρώπου τις*, but as *ἀνθρώπος*; binding on him not because of the differences which distinguish him from all others, but in virtue of his *oneness* with all others.

'The Moral Law has a real existence, there is such a thing as an absolute Morality, there is something absolutely true or false in ethical judgments, whether we or any number of human beings at any given time actually think so or not. Such a belief is distinctly implied in what we mean by Morality. The idea of such an unconditional, objectively valid, Moral Law or ideal undoubtedly exists as a psychological fact' (Rashdall, *Theory of Good and Evil*, ii. 211).

It is to be noted that, in most statements made to demonstrate the relativity of morality, we find manifest exaggeration both of facts and of the significance of them, and an ignoring of considerations such as profoundly modify the problem presented by the indubitable facts. Is it really the case, as is alleged in the passage by Pascal part of which has been quoted, that 'truth on this side of the Pyrenees is error on the other'? If so, it can be only a very trivial truth or error that is in view, a difference of etiquette or such like. The theory of relativity of morality is in sore need of support if it requires and uses such support as that. The theory, indeed, makes out its case largely by pointing to the fact that the *customs* and *institutions* of different peoples vary. And it can bring out striking differences only by contrasting savage or semi-savage peoples with the civilized and cultured. That such difference should exist is no wonder, and constitutes no problem, granted that moral knowledge, like knowledge in general, is capable of growth. When customary morality has given place to reflective morality, and when we compare peoples that have reached approximately the same degree of development, we find that differences in moral belief and practice are not so pronounced, not so much of a problem after all. And, so far as such difference actually exists, we have to remember that customs and institutions are, at the best, imperfect revelations and embodiments of ideas and ideals. They are, from the nature of the case, conservative. The public 'conscience' is usually ahead of them. The most 'enlightened' members of the community are usually in open protest against and conflict with them. Hence, in comparing two communities, a difference in custom and institutions is not safely interpreted as the exponent of a like difference of moral ideas

and ideals; between the two differences there may be no relation of strict proportion.

Or, again, customs and institutions may be regarded as means to moral ends, means of realizing ideals. And, plainly, difference of view as to appropriateness of means does not necessarily imply divergence of ends and ideals. Two individuals may identify themselves with the same end; but, because one has more power of insight and foresight, they may differ to any degree in their choice of means. Through lack of insight or foresight, one may adopt means which in reality more or less defeat the end in view—a fact of which all are painfully aware from their own experience. This is shown, too, by the degree to which, and the facility with which, individuals fall in with a more excellent way when it is represented to them. After all, there is so much ground as to what constitutes goodness common to the South Sea Islander and the missionary of a vastly higher morality.

It is not here being argued that moral ideas and ideals as actually held by men do not vary after all. The point is that, in considering the significance of the manifold variety of moral belief and practice on which the theory of relativity of good and evil bases itself, we have to bear in mind such considerations as have been adduced, which go to show that great varieties are possible without anything like the same divergence of idea or ideal.

Coming now to differences as to moral idea and ideal, the existence of which we have no concern to deny, we may hold that a sufficient explanation of them also has been indicated above. The fact that men differ in power of insight and foresight explains not only why they adopt different means as appropriate to the like ends, but also why they identify themselves with quite different ends, and define their desirable in very different ways. This is just what truth there is in the Socratic identification of virtue with knowledge, and vice with ignorance. It does not require the genius of an Aristotle to perceive that the good man is not merely one who knows what is good, or that the problem of moral evil is far from solution when ignorance is abolished. The statement of Socrates is no adequate explanation of the fact that men do evil, but it is an explanation of the fact that they differ in their views as to what goodness is. To know what is really desirable requires insight and foresight, and men differ in their conception of what is desirable because they possess these powers in varying degree.

If thus the relativity of moral conceptions resolves itself into a relativity of moral knowledge, it may seem that the problem of the relativity of morality is on all fours with, is indeed simply part of, the problem of the relativity of knowledge, into which it is not our place to enter. There appears, indeed, to be an important difference between the two questions. A moral ideal, it may be argued, is not a real thing in the way that the world of fact with which physical science deals is real. It seems easy to hold that a certain scientific fact is true, whether any individual or any number of individuals deny it or not. About a moral ideal there is not the same objective constraint. On the other hand, it may be replied that the scientist will be puzzled to give an account of an 'independent' world, of a fact which is anything save a fact for his mind, of a "correspondence" between experience and a Reality whose *esse* is something other than to be experienced' (Rashdall, *op. cit.* 211).

The stages on the path of progress of science are marked by the derelicts of abandoned—because, as advancing knowledge proved, erroneous—hypotheses, views which were held for truth at the time, and served their purpose for a time. There lie,

with all reality now denied them, 'caloric,' 'epicycles,' various 'corpuscles' and 'vortices,' and the like. Yet their presence does not daunt the scientist in his pursuit of truth. But it is as easy for a sceptic, by adducing them, to adopt *homo mensura* as the answer to the question, What is truth? as it is for another to argue the pure relativity of moral conceptions from a comparison and contrast of views held in various quarters. To *homo mensura* we reply: Beyond the truth and the good so regarded by any individual there is Truth and Good absolute; otherwise there is no meaning in speaking of progress; what you call progress is but change; and you will have difficulty in adducing any rational ground for any one desiring to change the views in virtue of which he is already the standard of true and good for himself.

We come back to the psychological fact already referred to, viz. that we have an idea that an unconditional objectively valid moral Law or Ideal exists. We must ask, Is this idea capable of justification? What are its implications?

IV. *IMPLICATIONS.*—1. *God as Mind.*—We have the idea that an absolute moral ideal exists. Where does it exist? Very plainly, a moral ideal can exist only in some mind. It is as plain also that it is to be found complete in no human mind. We admit, with whatever criticism we pass on a tendency which we think exists to exaggerate the facts or their significance, that men do think differently on moral questions. We may also admit with Rashdall that 'there is no empirical reason for supposing that they will ever do otherwise' (*loc. cit.*). The conclusion to which we are led, then, is that we must postulate a *Mind* in which the absolute Moral Law or ideal exists. God as Mind is implied in the existence of an absolute standard.

'Only if we believe in the existence of a Mind for which the true moral ideal is already in some sense real, a Mind which is the source of whatever is true in our own moral judgments, can we rationally think of the moral ideal as no less real than the world itself. Only so can we believe in an absolute standard of right and wrong, which is as independent of this or that man's actual ideas and actual desires as the facts of material nature. . . . Our moral ideal can only claim objective validity in so far as it can rationally be regarded as the revelation of a moral ideal eternally existing in the mind of God. . . . The existence of God . . . is essential to that belief which vaguely and implicitly underlies all moral beliefs, and which forms the very heart of Morality in its highest forms. . . . Moral obligation means moral objectivity. That at least seems to be implied in any legitimate use of the term. . . . Such a belief we have seen imperatively to demand an explanation of the Universe . . . which shall recognize the existence of a Mind whose thoughts are the standard of truth and falsehood alike in Morality and in respect of all other existence. . . . The belief in God . . . is still a postulate of a Morality which shall be able fully to satisfy the demands of the moral consciousness' (Rashdall, *op. cit.* ii. 212f.).

An alternative to this view is, of course, possible. It is to deny the validity of the idea of an absolute moral distinction. This is the only course open to those holding materialistic and naturalistic views of the Universe. The idea in question must be classed as an illusion, or set down as meaningless and inexplicable, the mere freak of a mindless, purposeless Nature, which somehow has superimposed on material phenomena consciousness as an epiphenomenon. This is not the place to offer a criticism of Materialism (*q.v.*) or Naturalism (*q.v.*). We must hold it sufficient to say that, in our view, the Universe and morality require far other theories adequately to account for and explain them. It is a short and easy way with ideas to set them aside as illusions. But, if one thinks the matter out, one will find that, after all, it is not an easy view to take that an idea is an illusion, though it is implicit in every moral judgment. Hence we hold that it is not to be set aside, but accepted with all its implications, all the postulates it can be shown to require. Thus we postulate God as the Mind, in which exists the absolute moral Ideal.

2. *God as Will.*—This is not a postulate in the

same immediate sense as that of God as Thought. It is not at once apparent that, if there be an absolute ideal, there must be also a Will active in realizing it. As we shall soon see, when one contemplates the world, one might be excused for coming to the conclusion that nothing is so certain as that there is no superhuman Will active in realizing an Ideal of absolute Good. Nevertheless we hold that God as Will is an implication of our first postulate, God as Thought—and for this reason, that thought apart from will does not seem to be a thinkable conception. To distinguish between Thought and Will is convenient and necessary enough. To regard them as really separate or separable is a very different matter. As we know them, the one always involves the other. To suppose that anywhere there exists Thought without Will is to hypostatize an abstraction. So, if we are to postulate a Mind in and for which the absolute Law or Ideal exists, it must be a Mind which wills as well as thinks. As nothing can be said to be willed which is not thought of as good, it follows that God must will the absolute Good, the Ideal of which exists in His Mind; and the Universe must have a purpose, an end conceived of as good by the Mind which wills it.

It may be noted in passing that we do not regard the above considerations as a demonstration of a Theistic position or set them forth with that aim. It is possible for one to hold that there is a rational principle in or behind Nature, a fundamental rationality in the Universe, while coming more or less short of Theism. Thus in Buddhism we find a profound belief in *karma* (*q.v.*), an inexorable, intelligible, impersonal principle, combined with an explicit denial of anything like Theism. We are not concerned here to justify Theism. We justify our use of terms which seem to have theistic implications, by saying that they seem the best terms to use, if not, indeed, the only terms that can be used. We are not coming nearer adequate expression of the truth of things in proportion as our thought and language become vague.

Now, if there be a superhuman Mind which thinks and wills absolute Good, the question arises, Is that Good realized? If we admit that such a Good must be realized—and we cannot do otherwise—we are immediately confronted with some of the most perplexing and painful problems that have occupied the mind of man, and we must now consider them.

V. *PROBLEM OF EVIL.*—It is common to speak of the problem of evil, and there is no objection to that, provided we understand that under the name are grouped a number of separable problems; for evils are of different kinds and raise different questions; and of all kinds two questions may be asked, What is the *terminus a quo*, and what the *terminus ad quem*?

It is to be noted that the problem of evil of any kind exists in most acute perplexing form only for those holding a Theistic view. Just in proportion as God is held to be omnipotent, all-wise, all-loving, the 'blessed and only Potentate,' the Creator, the Disposer of events, and so on, does the existence of evil become an ever deeper mystery. Only if there be a God, and a God in some sense outside of, superior to, and responsible for the world, can any complaint against what is be entertained. It is meaningless to criticize and protest against the scheme of things as we find it, if there is no One responsible for it, who, we conceive rightly or wrongly, might or should have made it other than it is. Of this Job, to whom the problem of evil was acute, has clear perception. 'O that I knew where I might find him! that I might come even to his seat! I would order my

cause before him, and fill my mouth with arguments. I would know the words which he would answer me, and understand what he would say unto me' (Job 23²⁻⁵). In this way, indeed, all problems of evil merge into one—the problem of *theodicy*: 'si Deus bonus est, unde malum?'

VI. *REALITY OF EVIL*.—As men survey the facts of experience and the world about them, they come to varied views as to the extent of evil. So little do ills and evil bulk in the view of *one* that he regards all the talk of evil as a gross exaggeration, and for the evils that he is compelled to admit he finds simple and adequate explanation lying on the very surface; and he is prepared to pronounce all things very good. *Another* finds everywhere evil in one or other of its manifold forms triumphant: the world is full of misery; Nature is blind, reckless, indiscriminating; human life with all its pains, sorrows, defeated hopes, thwarted aims, and brief span, which indeed is, after all, too long considering what it brings, seems not worth the living.

'Life which ye prize is long-drawn agony.'

To the optimist who says 'no world *could* be better,' the pessimist replies 'no world *would* be better; better that no world should exist than that there should be such a world as we have.'

On the question as to the extent of evil, men will give different answers. Something has to be allowed for temperament and personal experience. But it is clear that, if any one takes anything more than the merest superficial and the most contracted view, it will be impossible for him to take the optimistic view that, as a matter of fact, all things are very good and quite as they should be. Take no more than external Nature as we find it. We have Wordsworth's stanza:

'One impulse from a vernal wood
May teach you more of man,
Of moral evil and of good
Than all the sages can.'

On the other hand, we have J. S. Mill's violent indictment of Nature:

'In sober truth, nearly all the things which men are hanged or imprisoned for doing to one another, are nature's everyday performances. . . . Nature impales men, . . . and has hundreds of other hideous deaths in reserve, such as the cruelty of a . . . Domitian never surpassed. All this, Nature does with the most supercilious disregard both of mercy and of justice' (*Essay on Nature*).

In Mill's statement there is an element of rhetorical exaggeration, but for all that we may feel that it does more justice to the facts as we know them than the verse quoted.

Pessimism is an advance on optimism, and is nearer truth, since it recognizes the facts of the case, that there is disorder in Nature, and that there are seeming irrationalities in the external world, and in human experience ills which, by their number and the extent to which they can blight happiness and maim and stunt life, constitute an almost overwhelming perplexity. Reviewing the facts of life, we may say with Schopenhauer:

'To me optimism, when it is not merely the thoughtless talk of such as harbour nothing but words under their low foreheads, appears not merely as an absurd, but also as a really wicked way of thinking, as a bitter mockery of the unspeakable suffering of humanity' (*The World as Will and Idea*, Eng. tr., i. 420).

Yet it has to be observed that, as there may be a shallow, self-centred optimism, which spreads a rosy light over all because of personal well-being, so there is such a thing as a no less shallow, insincere pessimism, a megalomania not uncommon to youth, a pose deliberately adopted, a morbid sentimentalism—a pessimism which is certainly as absurd as, and probably more wicked than, the optimism referred to. The *Weltschmerz*, so frequent at the stage of adolescence and not unconnected with physiological changes, represents only the difficulty felt by an individuality taking

its first independent steps, and normally soon passes.

Optimism and Pessimism, however, are not merely estimates of the extent to which evils exist; they are theories of the origin, significance, and final issue of evil. One who can adopt the pessimist's estimate of the extent of evil may yet be an optimist as holding that 'Good is the final goal of ill'; that

'Good shall fall
At last, far off, at last to all,
And every winter change to Spring.'

To accept the pessimistic estimate of the magnitude of the problem does not involve the acceptance of a pessimistic solution of the problem.

The problem as noted is, If God is good, whence comes evil? and we must consider—

VII. *THE MAIN TYPES OF SOLUTION THAT HAVE BEEN OFFERED*.—It is easy to see how one might adopt the position: the world and life being what they are, either (1) God is not good; or (2) He is not omnipotent; or else (3) evil is not what it seems to be, it cannot be anything but good, and we must try so to interpret it. Each of those positions has been adopted as explanatory of evil, and we may so group the theories we consider.

1. The view that God is not good.—This is a convenient way of grouping some theories which have little enough in common save that all hold that God (using the term in a wider than the Theistic sense, to denote the fundamental Principle of the Universe, the World-ground, or howsoever else He or It may be named) is not good, or, what comes to the same thing, that the goodness of God is something essentially different from what we in every other case understand by goodness.

(i.) First we consider *Pessimism*. Its estimate of the extent of evil we have seen to be not unjustifiable. We must now look at its general account of evil. In brief, Pessimism holds that existence itself is evil, that non-existence is preferable to existence, that the root of all evil is the desire for existence. Pessimism, both as a temperamental attitude of mind towards the world and as a philosophy, is native to the East rather than to the West. In modern times, however, there has appeared in the West a popular and more or less vague pessimism in poetry, and even in the philosophy of the street corner; a political pessimism (Nihilism); and, what we are concerned with, a pessimistic philosophy.

(a) Eastern (or ancient) Pessimism has its best known and fullest expression in philosophic Buddhism. Buddhism grew out of the current Brahmanism, and so far accepted its teaching. In that system the old simple Theistic Aryan faith had given way to a belief in an impersonal Neuter (Brahma, Atman, or Paramatman), the source and goal of all existence, which in some dim way had willed existence in order to realize itself. A vast interval separates source and goal, and through it the wheel of existence turns, involving for souls incalculable changes till at last they escape back into Brahma whence they sprang. The soul passes through one incarnation after another, each state of being with its conditions being determined by merit or demerit acquired in the preceding state. It is easy to see how to Buddha it was only a making explicit of what was already implicit to say that the wheel of existence itself is an evil, *the* evil. The soul craves for rest, and will never find it so long as it is turning with the wheel. Rest means escape from the wheel. And every act is a thong which binds the soul to the wheel. Hence a good deed is only a less evil for the soul than a bad one, for it maintains the soul in being.

Existence, then, seemed to Buddha to be evil. Life means sorrow, and the only escape from

sorrow is to escape from life. There is no God, only an impersonal inexorable Law (*karma*), which attaches fitting consequences to merit and demerit. Escape from evil is possible just in proportion as we retire from the world and suppress the very desire to live, and stifle that will to act which by impelling us to action binds us, be it by merit or demerit, to the wheel of existence. When we have ceased to desire, we shall escape and attain Nirvāna.

In thus holding that escape is possible, Buddhism may be said to be, after all, an optimism. At the best it is a negative optimism. The final Good is one ever to be desired, never to be enjoyed; though it may be attained, never to be consciously attained. We are not concerned with practical Buddhism, which on the whole may be as optimistic a system as Christianity, or at least comparable with it (see the artt. on NIRVĀNA and KARMA).

(b) Western (or modern) Pessimism is represented in the systems of Schopenhauer and von Hartmann.

Schopenhauer (1788-1860) was a student of Oriental philosophy, and his pessimism is largely influenced by, if not borrowed from, Buddhism as we have outlined it. We find in his *Die Welt als Wille und Vorstellung* the same estimate of life and existence as evil, and the same doctrine that the desire to live must be mastered and destroyed by way of asceticism as we find in Buddhism. Instead of *karma*, Schopenhauer finds behind and causative of all existence *Will*. Will is the *Ding an Sich* which Kant regarded as unknowable. Will is the innermost essence of everything and of the totality of things. This Will is blind, stupid, and groping; hence a world of such misery as we find. If creation and life as we know them were the work of a conscious Creator, 'he would be the greatest of all wrong-doers. He must have been an ill-advised god, who could make no better sport than to change himself into so lean and hungry a world.' Hence Schopenhauer rejects Theism, and finds in the transition from Theism to Pantheism a progress from what is indemonstrable to what is absurd. In his view the world is so bad that non-existence would be preferable (*The World as Will and Idea*, Eng. tr., i. 493, et al.).

Von Hartmann is so far a disciple of Schopenhauer, though his originality is conspicuous. He develops more fully the *a posteriori* argument for the universal extent of evil. He comes to an 'indubitable conclusion' that pain is greatly in excess of happiness, even in the case of the most fortunately situated individuals. Nor is there any prospect of anything better in the future. Due to the development of human intelligence and sympathy there will come an ever keener sense of the predominance of pain. The practical conclusion is that we must aim at the extinction of the will to live, must work towards the end of the world-process. But von Hartmann's view is neither so simple nor so intelligible as that. Like Schopenhauer, he posits an unconscious Principle, but he differs from his predecessor in making it a Principle in which a dualism is inherent. There is not merely unconscious Will from which all existence with its miseries has sprung; there is an unconscious Intelligence which is striving to undo the mischief wrought by unconscious Will. The Universe then has an end, and the Absolute is good as seeking to realize it. And this end must be the end for us also. We are told that the only right course for us in the present time is to ratify the will to live, for only by surrender to life with all its pains, not through cowardly renunciation, can we play our part in the world-process (*Philosophie des Unbewussten*², p. 748). That act of universal suicide which seemed the only rational thing must be postponed, indefinitely it would

seem. For, if it took place, the Absolute which has produced the existing number of men would immediately produce other individuals to take their place (*Das sittliche Bewusstsein*, Berlin, 1879, p. 476). Hence von Hartmann's pessimism is the most absolute of all.

(ii.) The view has been expressed that evil largely at least disappears as a problem, if we hold that *the distinction of good and evil is different to God from what it is to us*. In various forms this view has been held by, e.g., H. L. Mansel, F. H. Bradley, A. E. Taylor, and in a sense by von Hartmann. And it has become a kind of fashion to talk of a super-moral sphere. The view in question is worked out in Bradley's *Appearance and Reality* (London, 1897), and Taylor's *Problem of Conduct* (do. 1901). (It has to be noted of the latter that to a great extent it has been disowned by the author.)

Without entering into detail, we may state the position shortly. The view is that the spheres of Religion and Morality are distinct. Morality, the lower, is concerned with human action alone. Moral distinctions applicable enough to men are inapplicable to God. Owing only to the limitations of human nature we present some things to ourselves as bad. Religious faith reveals a perfect world. There is ultimately nothing which ought not to be. Acts and principles of action which seem to us immoral are in God perfectly good. To some extent the human mind can see that it is so already, and, when it cannot see, it is the task of faith to trust that in all cases it is so.

Now there is considerable plausibility in such a view. It may seem to humble piety to be simply a comment on the text 'As the heavens are higher than the earth, so are my ways higher than your ways, and my thoughts than your thoughts' (Is 55⁹). We all realize that God's view of good and evil must differ in great measure from ours. But are we to say that this difference results in a *sharpening* or in an *obliteration* of the distinction of good and evil for God? Either view is possible; the former is the conviction on which all our moral striving is based; the latter is the view we are now considering. That we should be mistaken, as we often are, in our estimate of the degree to which any particular thing is good or bad is absolutely no ground for holding that to the Supreme Mind, with perfect knowledge, there is no real distinction between good and evil at all. To say that God is good and yet that to Him there exists nothing of our distinction between good and bad is contradictory and meaningless. If there is nothing bad to God, He is not good. If He does not feel about evil as we feel, only with far greater intensity, it is not obvious why we should trouble to worship or seek to serve Him, nor is it plain why we ourselves should draw distinctions which are not real in themselves, and have nothing in reality corresponding to them.

¹ It is of the essence of the moral consciousness, as it actually exists, to claim universal validity; if it possesses no such validity, it is not merely particular moral judgments that are false and delusive but the whole idea that there is such a thing as an end which absolutely ought to be promoted, and that we have a power (more or less adequate) of determining what that something is' (Rashdall, ii. 270). 'The word "good" means the same in him (God) and in us, else it means nothing to us' (W. N. Clarke, *Outline of Christian Theology*, Edin. 1898, p. 69).

(iii.) The conclusion, God is not good, follows logically from views which make *the will of God a capricious, inexplicable thing*, or which represent Him as *permitting (if not willing) evil in order primarily to reveal certain of His own attributes*. A God who wills the existence of persons as mere means towards an end in which they have no share, and which involves for them inexpressible suffering, can be called good only by affirming contradictories (cf. Kant, *Dialectic of Pure Practical Reason*, v.).

2. The view that God is not omnipotent.—The second group of theories is constituted by all that in various ways deny that God is omnipotent. They hold that God is absolutely good and means good, but cannot carry out His purpose of good immediately at least. There are obstacles which thwart and retard His purpose.

(i.) Here we have first various forms of *Dualism* (q.v.). We classify relevant dualistic theories thus:

(a) Those which postulate two equally original and eternal Principles which have been ever in rivalry and conflict. The evil principle can create, and throws his works among the creations of the Good Principle: hence all evil (Iranian dualism).

(b) Those which postulate the eternity of matter. God did not create matter. He made the world out of matter He found, and He made it as perfect as the intractable material would allow (e.g. *Timæus* of Plato). What imperfection exists, therefore, is due to the matter, not to the Maker, of the world. In various quarters this belief developed into the view that matter is inherently evil. In some Gnostic systems the world was represented as the outcome of the evil, originally subsisting in chaotic matter, organizing itself into a Kingdom. And man is a microcosm; the enemy of the highest principle within him is the material sensuous element, which is not merely, as we all hold, often the occasion or instrument of sin, but in itself is intrinsically evil. Cf. art. GNOSTICISM.

(c) Those which postulate an original dualism in God. We have noted this in von Hartmann's system. It appears also in the view of Boehme († 1624). Evil must have its root in God; this root is that in God which is not God, if we understand by God love only. Yet it is a Divine element, broken away from the original harmony to become 'God against God' (*Morgenröte*, xiv. 72). It appears also in certain Gnostic systems in which we have a representation of a fall within the Pleroma. A product of this fall is a Demiurge who is either ignorant of or hostile to the supreme God.

Dualism of type (a) is on the whole optimistic in outlook. The evil principle is destined to be at last vanquished and destroyed. Type (b), on the other hand, tends towards a pessimistic or at any rate a gloomy view. Existence in this world is evil; the body is the prison of the soul which must seek deliverance through asceticism (so notably the Essenes, Plotinus, many Gnostics), or vindicate its liberty by antinomianism (Ophites and other Gnostics).

Dualism is just the assertion that what we find now in the world has been there all along. The world is dualistic for each of us as we find it. Two streams of influence beat upon us. We feel the conflict of two tendencies within us. And Dualism explains the conflict by saying that it has always been so. It is an ultimate fact. Dualism in any of its forms cannot be expressive of the final truth of things, and thought cannot rest satisfied with it.

(ii.) We have next *Pluralism*, a philosophy which has in recent times come into great prominence, expounded by, e.g., W. James, Howison, and F. C. S. Schiller. Pluralism, when thoroughgoing, asserts that God is limited *ab initio* by other beings, among whom He is only *primus inter pares*. Souls are uncreated, eternally pre-existent. In the world-process God is striving to rid those souls of evil. Thus God is in no way, near or remote, responsible for evil. Pluralism (q.v.) is a *Weltanschauung*, and cannot be confuted in a sentence. As to pre-existence (q.v.), if we say with Rashdall,

* For one difficulty which the theory of Pre-existence removes it creates a hundred. . . The theory is certainly not capable

of positive disproof, but it is unsupported by the obvious and *prima facie* evidence of experience; and involves, the more it is worked out, a ramifying network of difficulties only to be disguised by some mythological structure which itself is the greatest difficulty of all' (*op. cit.* ii. 346 f.).

the Pluralist may reply in Ward's terms:

'[The theory of pre-existence] involves a "network" of assumptions unquestionably; but if it "is certainly not capable of positive disproof," the objector is bound to show that the result of the whole is worthless. As regards this particular hypothesis of pre-existence, its complexity is no advantage certainly; but even so the disadvantage is reduced in proportion as the separate assumptions are analogous with actual experience and consistent with each other' (*The Realm of Ends*, 'Pluralism and Theism,' p. 404 f.).

It is, however, a strange doctrine that the burden brought with any theory should be primarily a burden of disproof for the objector. The existence of a race of intelligent beings in the interior of the moon is a hypothesis not capable of positive disproof, its assumptions are all analogous with actual experience and quite consistent with each other, and the objector may be unable to show that the result of the whole is worthless. In spite of all that, the hypothesis is still in want of a single justifying consideration.

The theory of pre-existence must certainly be treated with respect. It is the belief of a large proportion of mankind. It has ever appealed to those who grapple with the problem of evil, and many names may be quoted in support—from Pythagoras, Plato, and Origen, to Kant and J. Müller. Admittedly no theory of the origin of souls is free from difficulty. But, obviously, to explain the taint of souls in this life by a 'fall' of created or emanated souls in a former life leaves the problem of evil exactly where it was. To gain anything we must hold that souls and evil are eternally pre-existent; and the gain, it seems to us, is small, balanced against the difficulty of the enormously complex problems that immediately confront us.

The metaphysical difficulty of Pluralism may be put thus: if the monads are absolutely separate, it is not obvious how a cosmos can arise; while, if they are inter-related, there is no intelligible sense in which they can be ultimate.

(iii.) That the omnipotence of God is *inherently* limited is implied in all theories which represent *evil as necessary*. In some sense the necessity of evil must be an element in every attempted solution of the problem; and hence in some sense it is true that evil exists because God, though perfectly good, is not omnipotent. What kind of limitation of omnipotence is compatible with an adequate Theism? Only the limitations necessary to make omnipotence a thinkable conception—limitations without which omnipotence is a totally absurd notion, meaning power not only to do all possible things, but to determine what is possible; an omnipotence which absolutely excludes impossibility. This is the foolish notion of omnipotence argued upon by, e.g., Schopenhauer and J. S. Mill.

'The Creator is the author not merely of the world, but of possibility too. He might accordingly have devised this in such a way as to admit of a better world' (Schopenhauer, *Parerga*, ii. 157; cf. Mill, *Theism*).

This meaningless omnipotence is denied as soon as God is conceived of as a definite Being at all, with any stability of intelligence or will. *Omnis determinatio est negatio*. To find that derogatory to God is to abuse language.

Plainly God is limited by His own Being (He cannot deny Himself), by His own purpose, and by His own works. It cannot be otherwise. We should else have a Being to whom no predicates could be attached, of whom nothing could be firmly hoped.

Hence in many quarters evil is represented as necessary; and, as noted, it must in some sense be so. The thought is not free from difficulty. For, if evil be necessary, is it not justifiable? Can we

condemn what must be? If a thing is necessary, is it not in a sense good? Even if we say, 'Evil must be, not in order that it may be for its own sake, but in order to be thwarted, fought with, destroyed, and to make good possible,' the evil-doer may still justify himself. If we say to him, with Royce,

'God's will is your will. Yes, but it is your will thwarted, scorned, overcome, defeated. . . . God wills you not to triumph. . . . And that is the use of you in the world . . . to be willed down in the very life of which you are a part' (*Studies*, p. 28), he may reply, 'Your argument is irrelevant. It remains true that on your own showing I am fulfilling a useful and necessary function in the scheme of things. Without me you can do nothing; your goodness were impossible without me to contend with. In your interest it is necessary for me to exist, and it is goodness in me to choose to constitute myself a round in the ladder of your ascent. Evil if justifiable in the abstract is justifiable in the concrete; in the abstract it does not exist. If there must be evil, there must be evil-doers.'

The possibility of evil is clearly necessary; it is no true limitation of omnipotence to affirm that. And, as Royce himself shows the possibility of evil (*Studies*, iv.), the presentation of moral choice is all we need for knowledge of good and evil. It is a delusion that we have more knowledge by yielding to temptation than we have in resisting it. Hence the difficulty remains, Why did not God prevent the actualization of evil? It is not an adequate answer to say, God cannot prevent moral beings from choosing evil rather than good. For, if God can govern moral beings now, as it must be admitted He can and does, He could have done so all along without damage to their moral freedom. Besides, the other difficulty remains as to why moral beings should will evil. After all, there is much to be said for Lotze's view:

'Of all imaginable assertions the most indemonstrable is that the evil of the world is due to the validity of eternal truth; on the contrary, to any unprejudiced view of Nature it appears to depend upon the definite arrangements of reality, beside which other arrangements are thinkable, also based upon the same eternal truth. If there were retained the separation . . . between necessary laws and the creative activity of God, in our view evil would undoubtedly belong not to that which must be, but to that which is freely created. Let us therefore . . . say that where there appears to be an irreconcilable contradiction between the omnipotence and the goodness of God, there our finite wisdom has come to the end of its tether, and that we do not understand the solution which yet we believe in' (*Microcosmus*⁴, Edin. 1894, li. 717).

3. The view that evil is not really evil.—The view that what is to us evil is not evil to God we have discussed above. Here we deal with various arguments which attempt to show that what at first sight seem evils are not, when better examined, evils to us. The characteristic formula of all such theories is, 'Partial evil is universal good.' And the most familiar expression of it is Pope's *Essay on Man*, which is a summary of Deistic optimism as represented by, e.g., Bolingbroke. The view is, 'Whatever is is right,' i.e. there is really no evil. Suffering is to be borne with content because the evil suffered is serving a great universal end. Nature is not to be rebuked for enforcing her laws at the expense of an individual.

'Respecting man, whatever wrong we call,
May, must be right, as relative to all.'

A similar view was to some extent accepted by the Stoics, who grappled earnestly with the problem of evil—not in Pope's dilettante manner—and in regard to the bearing of evil and the good that comes out of evil said nearly all that can be said. The Stoics, too, regarded the world as perfect. 'The nature of evil exists not in the Universe' (Epictetus, *Enchir.* 27). Evil is conducive to the best of the whole. Chrysippus and M. Aurelius compare evil to the coarse jest in the comedy, which, though offensive by itself, improves the

piece as a whole (*Aur. Med.* vi. 42). 'God has fitted all, evil with good, in one great whole, so that in all things reigns one reason everlastingly' (Cleanthes, *Hymn to Zeus*). In reply to this position that partial evil is universal good, we say that it does not make the evil any less or any less real. The individual afflicted for the good of the whole may well ask, Why select me? As Voltaire in *Candide* asks, Why should Lisbon perish while Paris escaped? Was not Paris sunk in evil too? However true it be that evil leads to good and to greater good, the problem remains as to its distribution. And, whatsoever its effects, near or remote, evil is still evil.

'It may be said that evil appears only in particulars, and that when we take a comprehensive view of the great whole it disappears; but of what use is a consolation the power of which depends upon the arrangement of clauses in a sentence? For what becomes of our consolation if we convert the sentence which contains it thus—The world is indeed harmonious as a whole, but if we look nearer it is full of misery?' (Lotze, *Microcosmus*⁴, li. 716).

Another point emphasized by the Stoics, and in many quarters since, is that evil is good as a *disciplinary agent*. On this point Seneca writes in almost a Christian strain in his *de Providentia*: 'Fragile are the plants that grow in a sunny valley.' And so Epictetus (*Diss.* iii. 24): 'God sends me hither and thither, shows me to men as poor, without authority, and sick . . . not because He hates me . . . but with the view of exercising me and of using me as a witness to others.' This is all fine and true, but the problem of evil remains. For this does not explain the suffering which destroys the very possibility of moral improvement, e.g. by reducing a mind to imbecility, or the fact that the evil inflicted seems utterly disproportionate; the old question is, in fact, raised in acute form, Is God not good to His own, or is He powerless, that this is the only way in which He can educate them?

Still another consideration is urged by the Stoics which has also played a great part in explanations of evil, viz. Evil is the necessary condition, the correlate, without which good is not conceivable. *No evil, no good*. This gives rise to different views. (a) Evil is a merely negative or privative conception, meaning only the absence of good; (b) evil is the condition of knowing or doing good. In answer it is easy to point out that evil is no mere negative. It is something quite positive which attempts to usurp good. Evil is not merely *good-less*, but *anti-good*, if we may use the words. A man may fail to exhibit a virtue without being guilty of the contrary vice, or, as we say, have only negative virtue. As to our knowledge of good:

'Things are known to us only in relation to their opposites. . . . But the law need not be so interpreted as to require that these opposites must be absolute contrasts. In order to consciousness, we must have change. . . . But *change* does not necessarily mean transition to the entirely opposite state. . . . We should be conscious of good without experience of positive sin or evil, if there were within good itself change from one degree to another, or if there were varieties of good' (Davidson, *Stoic Creed*, p. 227).

The position that evil is necessary if moral beings are to be good and do good has been in our view already.

VIII. *CONCLUSIONS*.—We have seen that every proposed solution either leaves the old question unanswered or raises new ones. The problem is for the human mind insoluble. However far we may get with an answer, ultimately

'There is a veil past which we cannot see,' and the final and complete answer to 'Si Deus bonus, unde malum?' lies within. There are, however, considerations which so far lighten the problem.

1. *Metaphysical evil* (the fact that we are finite) is no evil at all. 'To be finite is unsatisfactory,' says Royce, but it is scarcely a thing to complain

about, if, as we actually find, the finitude is capable of indefinite expansion, and if, as we have ground for hoping, this is destined to be immortal. When knowledge cannot be extended, when possibilities of discovery and invention have been exhausted, it may be time to find our finitude an evil. When our world is conquered, we may weep.

2. Physical evil, the evil we suffer.—(a) If one argues, We can conceive the world and the conditions of life as better than they are, why are they not better? the answer is: As a matter of fact they are becoming better, our demand for a better world is God's demand, our purpose to make it better is His purpose, our task in improving it is His task. To demand from God a better world, to complain that it is so imperfect, is to demand for man an easier task, that there shall be less which man has any share in producing. The demand for a perfect world is the demand that man shall have no task, no function in the world at all, and makes the creation of a world needless and unintelligible. As Iverach says, 'the world is not yet made, it is only in the making' (see also Fairbairn, *The Philosophy of the Christian Religion*, p. 59); and man himself is called to play a part in the making of it. He is not at home in the world as he finds it; by his labour he has to make it more of a home. Hence it seems inevitable that there should be suffering in various forms for him. Which is preferable—a world in which man has nothing to do in making it a better world, or a world which calls him to be a worker along with God?

(b) Physical evil has been the goad which has impelled men to most of those achievements which make the history of man so wonderful. Hardship is the stern but fecund parent of invention. Where life is easy, because physical ills are at a minimum, we find man degenerating in body, mind, and character. With a new world we must demand a being different from man as we know him, i.e. not man.

(c) This indicates that the demand that the world should be other than it is in this or that particular leads us whither we know not. It is not one thing which has to be changed when one change is proposed, but ultimately all things; and a world totally different from the world we know cannot be thought out. It is not possible to foresee all the changes necessitated by one change regarded as desirable. Could we foresee them, it is conceivable that we should find the last state worse than the first. Leibniz's formula, 'this is the best of all possible worlds,' does not admit of demonstration, but neither does its denial. We cannot prove that there is no more suffering in the world than is necessary for any good purpose, neither can we prove that there is more. And the burden of proof seems fairly to rest on the critic of Providence.

3. Moral evil.—There are ultimate questions that cannot be answered, e.g. the origin of sin, and its universality (see art. SIN). Here it is in place to state that we may hold that it was God's purpose to have in man not merely an intelligent fellow-worker, but a moral being who should be partly the architect of his own character and worth. Again we ask which is preferable—a being who cannot do evil, or a being who with full power to do evil abstains? a *non posse peccare*, or a *posse non peccare*? We note that Huxley answers that he would prefer the former:

'I protest that if some great Power would agree to make me always think what is true and do what is right, on condition of being turned into a sort of clock . . . I should instantly close with the offer' ('Method and Results,' *Collected Essays*, Lond. 1898-94, i. 192).

But it may be doubted if many will agree with

him. Once again it is a demand for no task, no battle; and what is the worth of such a character? The wine of life would be drawn under such conditions; man would have no share in working out God's plan. Which is preferable—a grim fight, with the possibility of splendid triumph, or no battle at all?

The possibility of evil is necessary for a moral being. And the actuality of evil is the only ground we can see on which there rises any need or any possibility for the manifestation and development of some human virtues, and the revelation of some Divine excellences, which we regard as among the best. Nor, though we might have knowledge of evil, could we have knowledge of the consequences of evil, were evil not actual.

It will appear that we might go on to say that God wills not merely the possibility, but the actuality of evil. If we admit that He has perfect foreknowledge and wills a possibility which He knows will be realized, manifestly it might seem His responsibility is not different from that of willing its realization (cf. Rashdall, ii. 343). We prefer to say that here we are in a difficulty which shows, in Lotze's phrase, that our thought is at the end of its tether.

4. Connexion of physical with moral evil.—The problem of evil would be far less acute if we saw that suffering was proportionate to wrong-doing. The greatest problem of all is the apparent indiscriminate with which good and evil fortune are assigned. Three considerations must be regarded.

(a) We see but in part. Could we see the whole, it is not inconceivable, to say the least, that the apparent disproportion would wear a very different aspect. As Royce puts it, we see things in the temporal series; the problem may be quite other *sub specie aeternitatis* (*World and Individual*, ii. 338 ff.).

(b) For then, in particular, we should see how God's government of the race modifies His government of the individual. God has the race to govern, and the race can be disciplined only in individuals. Hence there is vicarious suffering, and it is difficult to hold that what is reasonable in men, who in various circumstances must and do punish, causing vicarious suffering, is unreasonable in God.

(c) If we believe in immortality, the whole problem of evil, and this one in particular, is profoundly modified. And this problem is one point of view from which it may be shown that immortality is a postulate of morality. If we believe that the conflict with evil shall result in final victory for good, that evil shall at last find its place in Reality only as trampled on and triumphed over, and, further, that we who have striven and suffered and been perplexed shall see the triumph of what we fought for, and the good meaning of our burdens, and the explanation of our problems, then at the worst life is full of interest; it is good to be, worth while to suffer and to fight.

In brief, our view is: God is good and means only good, but His purpose is to realize His ends with our co-operation; and in some sense evil is necessary that they may be revealed to us, and striven after by us.

LITERATURE.—The main Biblical passages are Gn 3, Job, Ps 78, Ecclesiastes, 2 Co 4, Ja 13st. On these there is a vast expository and homiletical literature, details of which cannot be given here. See also Plato, *Protagoras*, *Gorgias*, *Republic*, *Timæus*; Aristotle, *Nicom. Ethics* (Peters' tr., Lond. 1886); for the Stoics, see W. L. Davidson, *The Stoic Creed*, Edinburgh, 1907; Cicero, *de Finibus* (Yonge's tr., Lond. 1883); for Plotinus, see B. A. G. Fuller, *The Problem of Evil in Plotinus*, Camb. 1912; Augustine, *de Civitate Dei*, A.D. 428 (tr. M. Dods, Edin. 1871); Boethius, *de Consolatione Philosophiae*, c. A.D. 526 (tr. King, Lond. 1897); Al-Fārābī, *Fontes Quæstionum*, c. A.D. 960 (see M. Steinschneider, *Alfarabi*, St. Petersburg and Leipzig, 1869);

M. Maimonides, *Dalalat al-Ha'irin (Moraḥ Nebuchim)*, A.D. 1190 (Paris, 1520; Fr. tr. 1866); G. Bruno, *Della Causa, Principio ed Uno*, Lond. 1584, *de Monads*, etc., Frankfurt, 1591; J. Boehme, *Aurora*, Amsterdam, 1656; N. Malebranche, *Entretiens sur la métaphysique*, Paris, 1687; P. Bayle, 'Réponse aux questions d'un provincial' (in *Œuvres*, The Hague, 1727-31), art. 'Manichéens,' in *Dict. histor. et critique*, Rotterdam, 1697 (Eng. tr., Lond. 1736-38); B. de Spinoza, *Ethics*, Amsterdam, 1677 (tr. R. Willa, Lond. 1870); G. W. v. Leibniz, *Theodicee*, Amsterdam, 1710; W. King, *An Essay on the Origin of Evil*, Lond. 1731; A. Pope, *Essay on Man*, do. 1732; J. Butler, *The Analogy of Religion*, do. 1736; J. Edwards, *Freedom of the Will*, Boston, 1754, *The Great Christian Doctrine of Original Sin*, do. 1788, *Dissertation concerning the End for which God created the World*, do. 1788.

Of more modern works, the following may be noted: I. Kant, *Kritik der Urtheilskraft*, Appendix, Berlin, 1704 (tr. J. H. Bernard, Lond. 1892), *Religion innerhalb d. Grenzen d. blossen Vernunft*, Königsberg, 1794 (tr. in T. K. Abbott's *Kant's Theory of Ethics*, Lond. 1883); F. W. J. Schelling, *Philosoph. Untersuchungen über d. Wesen d. menschlichen Freiheit*, Landsbut, 1809; G. W. F. Hegel (see J. M. E. MacTaggart, *Studies in Hegelian Cosmology*, Camb. 1901); S. T. Coleridge, *Aids to Reflection*, Lond. 1825 (many reprints); F. D. E. Schleiermacher, *Der christliche Glaube*, Berlin, 1830-31; A. Rosmini, *Teodicea*, Turin, 1828; B. H. Blasche, *Das Böse in Einklang mit der Weltordnung*, Leipzig, 1827; G. T. Fechner, *Über d. höchst Gut*, do. 1846; T. Reid, *Works*, Hamilton's ed., Edin. 1854, pp. 632-36; J. Young, *Evil and Good*, Lond. 1856; F. Rohmer, *Gott und seine Schöpfung*, Nördlingen, 1857; A. Schopenhauer, *Die Welt als Wille u. Vorstellung*, Berlin, 1859; W. H. Smith, *Gravenhurst, or Thoughts on Good and Evil*, Edin. 1862; H. Lotze, *Mikrokosmos*, Leipzig, 1856-64 (Eng. tr., Edin. 1899); E. Dühring, *Der Werth des Lebens*, Breslau, 1865; A. Conti, *Dio e il male*, Florence, 1865; J. McCosh, *The Method of Divine Government, Physical and Moral*, Lond. 1867; E. Baltzer, *Gott, Welt, u. Mensch*, Nordhausen, 1869; R. Rothe, *Theolog. Ethik*, Wittenberg, 1869; K. R. E. v. Hartmann, *Philos. des Unbewussten*, Berlin, 1871; H. Martens, *Die christliche Ethik (allgemeiner Theil)*, Gotha, 1871 (Eng. tr., Edin. 1899); E. Naville, *Le Problème du mal*, Lausanne, 1868 (Eng. tr., Edin. 1871); J. S. Mill, *Nature, Utility of Religion, and Theism*, Lond. 1874; A. Ott, *Le Problème du mal*, Paris, 1888; H. Bergson, *Essai sur les données immédiates de la conscience*, do. 1889; J. Sully, *Pessimism*, Lond. 1892; W. L. Davidson, *Theism*, do. 1893, lect. xii.; J. Royce, *The Religious Aspect of Philosophy*, Boston, 1897, *Studies of Good and Evil*, New York, 1898, *The World and the Individual*, do. 1901; F. R. Tennant, *The Origin and Propagation of Sin*, Camb. 1902; A. M. Fairbairn, *The Philosophy of the Christian Religion*, Lond. 1902; H. Rashdall, *The Theory of Good and Evil*, Oxford, 1907; G. T. Ladd, *Knowledge, Life, and Reality*, Lond. 1909; W. E. Orchard, *Modern Theories of Sin*, do. 1909; J. Ward, *The Realm of Ends, or Pluralism and Theism*, Camb. 1911; S. A. McDowell, *Evolution and the Need of Atonement*, do. 1912; J. Y. Simpson, *The Spiritual Interpretation of Nature*, Edin. 1912; J. Watson, *The Interpretation of Religious Experiences*, Glasgow, 1912, lect. xi., xii.; B. Bosanquet, *The Value and Destiny of the Individual*, Lond. 1913. Further, the subject is treated in nearly all Philosophies of Religion (Schopenhauer, Lotze, Pfleiderer, etc.), and Systems of Dogmatics (Aquinas, Oosterzee, Martensen, Hodge, etc.).

W. D. NIVEN.

GOOD NATURE.—That quality of temperament which is evinced, outwardly, in easy and agreeable accommodation to the social environment, and, inwardly, in aptness for adaptation without irritation or undue disturbance. Two types of good nature are to be distinguished.

(1) The first and more austere type consists in an attained orderliness of the sensibilities and a consciousness of harmony with nature. In its pagan interpretation it is the virtue of temperament sought in the Stoic ideal of wisdom as pious accord with natural law, to be attained by reasoned self-discipline; psychically it is marked by evenness of mood, avoiding both exuberance and depression, and it is generalized as right feeling (*εὐπάθεια*), at finer fortitude than mere patient endurance. In its Christian interpretation good nature is the native innocence and right inclination which are conceived to have been the original endowment of mankind; it is (to quote Jeremy Taylor) 'the relics and remains of that shipwreck which Adam made,' or, more precisely, 'the proper and immediate disposition to holiness.' Hence it is the source of natural morality and innate apprehension of the good.

(2) A second type of good nature, more lively and spontaneous, is a fact of elementary psychology—in no sense a product of discipline. Kindliness and easiness are its salient traits, health and sound

nerves its primary conditions. Over and above these is implied a mental constitution mobile and facile enough to meet change without friction or strain (ill nature is as likely to be a result of lax and sodden as of hypersensitive nerves). It is to be noted that such good nature is susceptible of cultivation, suggestion and auto-suggestion being capable agents for its inducement, and that it usually results in physical benefit. Many of the cures of 'Christian Science,' 'Mental Science,' etc. are primarily cures of temperament; the result is probably attained by inhibition (through suggestion) of irritations arising from local strains, and the process is, in effect, a centrally induced rest cure.

In its moral aspects good nature favours certain perils, such as over-readiness to be persuaded, or a too easy complaisance in abetting or condoning what should be morally repugnant. 'Weak good nature' is a manifestation of deficient will (cf. *ABOULIA*), shown either in extreme susceptibility to suggestion or in that temperamental laziness which appears in disinclination to fortify moral resolution in irksome directions. It is this aspect of good nature which has chiefly impressed itself upon the modern use of the term, where it is widely given a derogatory turn, as implying want of moral stamina. As a social virtue it should properly be cultivated between the extremes of hyper-conscientious scruple on the one hand and lax compliance with social expediency on the other.

H. B. ALEXANDER.

GOODNESS.—The story of the Fall has a profound truth embedded in it. Science regards it as the legend of the awakening of man from a merely animal state to the consciousness of good and evil, of his transition from thoughtless innocence to purposed virtue or deliberate vice, of the introduction of a new sense into the world, the sense which is named conscience. 'A fall it might seem, just as a vicious man sometimes seems degraded below the beasts, but in promise and potency a rise it really was' (O. Lodge, *Man and Nature*, London, 1905, p. 91). Later, for all peoples that have a history, there has, somehow or other, come a time of reflexion, and with it there has arisen 'a conception of good things of the soul, as having a value distinct from and independent of the good things of the body, if not as the only things truly good, to which other goodness is merely relative' (T. H. Green, *Prolegomena to Ethics*, Oxford, 1884, p. 261).

I. The Greek conception.—The 'good' (*τὸ ἀγαθόν*) was made the subject of reflexion in all the philosophical schools of Greece, and it is to Socrates and his successors that we owe our chief moral categories. The Platonic and Aristotelian conception of virtue is final in so far as it defines the good as goodness.

'It marks the great transition, whenever and however achieved, in the development of the idea of the true good from a state of mind in which it is conceived as a well-being more or less independent of what a man is in himself, to that in which it is conceived as a well-being constituted by character and action' (Green, *op. cit.* p. 300).

As a concrete ideal, however, the Greek conception of virtue, limited as it necessarily was by the moral progress of the nation, is inadequate. For us, as for Aristotle, the good is the realization of the powers of the human soul or the perfecting of man; for us, as for him, the good for the individual is to be good; but the idea of human brotherhood, which had no meaning for the philosophers of Greece, has achieved, and is destined to achieve, results of which they did not dream.

In opposition to the moral scepticism of the Sophists, some at least of whom reduced morality to a matter of private caprice, Socrates held that virtue is one and may be taught. Following out

this thought consistently, Plato was led to 'the Absolute Good,' or 'the Idea of Good' (ἡ τοῦ ἀγαθοῦ ἰδέα [*Rep.* bk. vi.]), which is the source of all truth, all goodness, and all beauty. Its apprehension by the soul is knowledge, its indwelling in the soul is virtue, its shining forth to the soul (it may be through the medium of sense) is beauty. It is the eternal and unchanging principle of goodness. Correcting the Pythagorean dictum, Plato asserted that God, not man, is the measure of all things. He believed that the ideal for each lower soul is to become dear to God and to grow like Him.

Socrates further taught that 'Virtue is knowledge.' Himself blessed with a will which obeyed all the behests of reason, he fell into the error of ignoring its operations. Assuming that all motives are rational, he held that practical wisdom (φρόνησις) is the sole condition of well-doing. No man, he was wont to say, knowingly chooses the evil and rejects the good—a statement which owed its plausibility to the double meaning of the word 'good,' virtue and interest. He taught that the various forms of goodness are wisdom in different spheres of action: to be pious is to know what is due to the gods; to be just is to know what is due to men; to be courageous is to know what is to be feared and what is not; to be temperate is to know how to use what is good and to avoid what is evil.

The principle that wisdom is the sole good and ignorance the sole evil became the basis of all subsequent discussions of the ethical problem. For Plato, the philosophic man is the good man. Plato was, indeed, too clear-sighted and fair-minded to suppose that virtue is the exclusive possession of a few choice spirits. He admits that there is much to commend in the lives of some men who are not philosophers. Ordinary citizens who are brave, temperate, and just must have certain true notions of good and evil; their right opinion comes partly from nature or 'divine allotment,' and partly from custom and practice. But for the perfecting of character and conduct, for the adequate preparation of men for good citizenship and especially good government, there is needed the discipline of philosophy. True knowledge, and with it true virtue, can be imparted only to the soul that has undergone a long course of training. Practical excellence of character is the finished product of a liberal education.

Aristotle's famous formula that virtue is a mean, or carefully chosen middle course, between two vices which are related to it as excess and defect makes goodness synonymous with prudence. The Epicurean sage, for whom pleasure was the sole good and pain the sole evil, counted all virtuous conduct empty and useless except in so far as it ministered to his happiness. He determined the only real (or reasonable) goodness by a careful mensuration of the pleasant or painful consequences of men's actions. The Stoical wise man was free from passion, unmoved by joy or grief, sufficient unto himself (αὐτάρκης), living in harmony with the all-controlling law of nature. The strength of Stoicism lay in the heroic severance of virtue from interest. This stern creed had a natural affinity with the Roman mind, and under the Empire almost every noble character, every effort in the cause of freedom, emanated from the ranks of Stoicism. But all the later Stoics sadly confess how great is the gulf between the ideal sage and the actual philosopher. 'Ah, show me a Stoic!' says Epictetus. 'By the gods, I long to see one. Show me at least one who lies in the crucible in order to be cast. Pray do me this kindness. Pray refuse not to an old man, from ill-will, the sight of a spectacle that I have not seen till now' (*Diatrib.* II. xix. 24 ff.). Experience proved that

this type of goodness could not be realized. It was too violently opposed to nature, and the passionless sage was nowhere to be found. The ethical code whose dominant notes were 'Endure' and 'Refrain' could not be the final law of life.

The philosophical endeavour to attain virtue or goodness by knowledge was prolonged for centuries, and enlisted many of the finest minds of Greece and Rome; but it was a *tour de force*, which was bound to fail for various reasons. Virtue was made too academic: the faint murmurs of the schools scarcely ever reached the dull ear of toiling humanity. It was too intellectual: after all, men 'live by admiration, hope, and love.' It was too secular: there never was any certainty that man's beautiful moral ideal had its source and sanction in the character and will of God. And it was too superficial: man cannot really be moralized and meliorized unless he is first regenerated. 'Genuine goodness is no necessary consequence of the enlightenment of the understanding; it can only dispel follies, but not vices' (Martensen, *Christian Ethics [Individual]*, Edinburgh, 1884, p. 39).

2. In the Old Testament.—The Hebrew prophets and poets do not analyze abstract ideas, but give impassioned utterance to the spiritual truths by which the moral life is generated, fostered, and perfected. For them the energy of goodness lies in the will, behind which is the immutable character, of God. They teach, exhort, and rebuke their nation with an authority which is justified by their inner assurance of being called to speak for a God of absolute righteousness. 'Good and upright is Jahweh' (Ps 25⁹), requiring men to depart from evil and do good (34¹⁴), condemning all who obliterate moral distinctions (Is 5²⁰). He deepens the sense of sin till men cry in anguish, 'There is none that doeth good, no, not one' (Ps 141³). But He is good and ready to forgive (86⁵). He is good to all (145⁹), and the moral ideal which He sets before men is beautifully simple: 'Trust in Jahweh, and do good' (37³); 'He hath showed thee, O man, what is good; and what doth Jahweh require of thee, but to do justly, and to love mercy, and to walk humbly with thy God?' (Mic 6⁸).

The Old Testament conception of goodness is vital and therefore progressive; dynamic, and not till after the Exile merely static. The morality of the Hebrews, like their religion, had a history. The ideal of conduct cherished by the prophets was very different from that of the rude nomads who swarmed from the desert into the land of the Canaanites. Under the discipline of events, interpreted by the genius of spiritual leaders, less and less importance came to be attached to outward righteousness, more and more attention was directed to the hidden springs of action in the soul. But the prophetic sense of the weakness of human nature stirred a longing for the inspiration of a new supernatural power. Jeremiah's hope of the triumph of goodness lay not in the self-amendment of Israel and Judah, but in Jahweh's making a new covenant with them, putting His law in men's inward parts, and writing it in their heart (Jer 31³¹⁻³³).

3. In the New Testament.—Jesus both extends and deepens the prophetic conception of goodness. Absolute faith in the goodness of God is the keynote of all His teaching. He refuses to be lightly called good (Mk 10¹⁸), not because He is conscious of any evil in Himself, but because He has still to be perfected by struggle and temptation. He has a sense of the immeasurable contents of human, as well as of Divine, goodness. For Him no action has value apart from motives and dispositions; He seeks the source of morality in the inner spirit of conduct; He goes back beyond the legalism of His time to the fundamental moral ideas of the Law and the Prophets, disengaging the principle upon

which they rest. To Him the only real good is the good self: make the tree good and the fruit will be good (Mt 7¹⁷). He has an optimistic assurance of the triumph of goodness, rejoicing even in revilings and persecutions as part of the process through which evil is to be vanquished. In His view nothing can permanently withstand the power of love. 'Man can only seek for truth and goodness, and if for a time he turns his energies against the good cause, it is not in the spirit of a being who desires evil—for man is not a devil, but in his real being "a son of God"—but in his confusion of the true with the false' (John Watson, *Christianity and Idealism*, Glasgow, 1897, p. 93). In the life of Jesus the image of goodness rises as a universal example. The moral ideal, which is latent in every man, is active and triumphant in Him. In contemplating Him men for the first time really 'feel how awful goodness is, and see virtue in her shape how lovely.'

* Religion cannot be said to have made a bad choice in pitching on this man as the ideal representative and guide of humanity; nor, even now, would it be easy, even for an unbeliever, to find a better translation of the rule of virtue from the abstract to the concrete than to endeavour so to live that Christ would approve our life' (J. S. Mill, *Three Essays on Religion*, pop. ed., London, 1904, p. 107).

His goodness is so far from being a possession to be enjoyed by Himself alone that it is communicated everywhere to faith; and, inasmuch as His followers are transfigured into His image (μεταμορφώματα [2 Co 3¹⁸]), He becomes the Founder of a new humanity, pledged to secure the ultimate victory of His Divine ideal of goodness.

4. In modern speculation.—The problem of the nature and sanction of goodness has, for three centuries, engaged many of the keenest minds of modern Europe. Every thinker has had the task of squaring his ethical conceptions with his general view of man's place in the cosmos. The school of Hume, for which the human mind is merely a bundle of states of consciousness, can recognize no higher motive than the agent's interest or happiness, so that the noblest character is merely a means to an end—the promotion of pleasure. Kant holds that there is nothing good but the good will, which is good in itself, not with reference to any external facts. He teaches that man, as a rational being, is bound to obey a categorical imperative, the content of which is given in the formula: 'Act only on that maxim (or principle) which thou canst at the same time will to become a universal law' (*Metaphysic of Morals*, sect. ii.). Character, which Novalis (*Schriften*, i. 242) defined as 'ein vollkommen gebildeter Wille,' is thus so far from existing for anything else that all other things rather exist for its sake. The pleasures and pains of life are but part of the raw material out of which character is created. Grant that 'the attempt to establish an absolute coincidence between virtue and happiness is in ethics what the attempting to square the circle or to discover perpetual motion is in geometry and mechanics' (L. Stephen, *Science of Ethics*, London, 1882, p. 430), this discrepancy, which so perplexed and troubled the ancient Hebrews, can now be calmly contemplated. The presence of suffering in all noble lives proves that there is a higher end than pleasure: here the Stoics were absolutely right. To inquire after the utility of goodness 'would be like inquiring after the utility of God' (Carlyle, *Miscellanies*, i. 48). What gives the moral life its Divine sanction 'is the discovery that your gleaming ideal is the everlasting real, no transient brush of a fancied angel's wing, but the abiding presence and persuasion of the Soul of souls' (J. Martineau, *Study of Religion*, Oxford, 1888, i. 12).

5. Relation to evolution.—The doctrine of evolution has shed a new and bewildering light upon the problem of the genesis and worth of goodness. It

has raised anew in the acutest form the old question whether the Soul of the world is just—whether goodness in man is, as Plato thought, a manifestation of the Absolute Good. Huxley was impressed by 'the unfathomable injustice of the nature of things'; he affirmed that 'the practice of that which is ethically the best—what we call goodness or virtue—involves a course of conduct which, in all respects, is opposed to that which leads to success in the cosmic struggle for existence'; he in fact denied the possibility of identifying 'the power which makes for righteousness' with 'the power behind natural evolution' (*Evolution and Ethics*, London, 1893, pp. 12, 33). Nietzsche, on the other hand, hailed the ethics of evolution as a kind of new gospel; he glorified brute strength, superior cunning, and all the qualities that secure success in the struggle for life; he demanded, in the name of development, a revaluation of all moral values, a demoralization of all ordinary current morality; and he thought he foresaw, as a new Messiah, the Superman who is *jenseits von Gut und Böse*.

It is probable that there is much more real goodness in Nature than either Huxley or Nietzsche allowed; that she is not so 'red in tooth and claw' as she has been painted; that there has, since the very beginning of life in our planet, been a principle of altruism (*q.v.*), a struggle for the life of others (H. Drummond, *The Ascent of Man*, London, 1894, p. 29 ff.). Science cannot disregard the principle of continuity, and the future evolution of humanity will be as much a part of the cosmic process as the past. But that which is natural is first, and afterward that which is spiritual. We are allied to that which is above us as well as to that which is beneath us. Nature is so imperfect that the Stoical doctrine of life in conformity with her—sentimentally accepted by Rousseau and fiercely by Nietzsche—is not enough for the moral guidance of man. As Matthew Arnold says in his sonnet 'In Harmony with Nature':

'Know, man hath all which Nature hath, but more,
And in that more lie all his hopes of good.'

LITERATURE.—P. Janet, *The Theory of Morals*, Eng. tr., Edinburgh, 1884; J. Martineau, *Types of Ethical Theory*, Oxford, 1885; W. Wallace, *Natural Theology and Ethics*, London, 1898; A. Seth Pringle-Pattison, *Man's Place in the Cosmos*², Edinburgh and London, 1902; H. Sidgwick, *Outlines of the History of Ethics*⁶, London, 1902; R. A. P. Rogers, *Short History of Ethics*, do. 1911; W. R. Sorley, *Recent Tendencies in Ethics*, do. 1904; R. Eucken, *Geistige Strömungen der Gegenwart*, Leipzig, 1904; E. Westermarck, *Origin and Development of the Moral Ideas*, 2 vols., London, 1906-08.

JAMES STRAHAN.

GOODWILL and its opposite, 'illwill,' denote by their etymology distinctively moral characteristics formed by voluntary effort in contrast to the instinctive disposition or temperament described as *good nature* or *ill nature*. But there is a certain fluidity in the use of the terms, so that, like their Latin equivalents, *benevolence* and *malevolence*, they are readily applied to the instinctive impulses of nature as well as to creations of will. Thus goodwill expresses one side of amiability (*q.v.*). It is the disposition or willingness to love, though it does not, like amiability, suggest that this is calculated to evoke a response of love in others.

J. CLARK MURRAY.

GOOD WORKS.—See MERIT.

GORAKHNATH.—The traditional founder of the Indian sect of Kānpaṭā, or split-eared, Yogis (see YOGIS). The name is a corruption of the older Skr. form *Gorakṣanātha*, 'Lord of cattle-herders,' or, possibly, 'Lord of Gorakṣa' (see below). His date is unknown, the three most circumstantial legends concerning him being so contradictory that nothing certain can be gathered from them. In Nepāl he is associated with King

Narendra Deva, who reigned in the 7th cent. A.D.;¹ in Northern India he is represented as a contemporary and opponent of the reformer Kabir, who flourished in the 15th cent.;² while, in Western India, one Dharamnāth, who is said to have been his fellow-disciple, appears to have introduced the Kānphaṭā doctrines into Kachchh at the end of the 14th century.³ If the traditional relationship between Dharamnāth and Gorakhnāth can be established as a fact, the last-mentioned date is the most probable one.

The Kānphaṭā Yogīs trace the origin of their tenets far beyond Gorakhnāth. All authorities agree in making him one of the twelve (or, according to some, twenty-two) disciples of Matsyendranāth, a disciple of Adināth and a Yogī saint whom the Nepalese identify as none other than the Buddhist deity Ārya Avalokiteśvara. Some make Adināth the founder of the Yogīs, while others carry the list much further back.⁴ All traditions state that the disciple Gorakhnāth was greater than his master, and that it was he who introduced the custom of splitting the ears of disciples and founded the sub-sect of the Kānphaṭās. The Kānphaṭās themselves fall into two groups—those of Hindustan proper, who trace their descent directly from Gorakhnāth, and those of Western India, who refer their immediate origin to his fellow-disciple Dharamnāth. Several Sanskrit works are attributed to Gorakhnāth,⁵ which may or may not be genuine; but the most authentic account of the tenets of the sub-sect will be found in the *Gorakhnāth-kī Goṣṭhī*, a modern Hindī work reporting a controversy between him and Kabir, and written by a partisan of the latter.⁶ These do not differ from those of other Śaiva ascetics; for an account of them, see art. YOGIS.

In Indian legend Gorakhnāth is ubiquitous and all-powerful. He was the patron saint of the State of Gorkhā (Skr. Gorakṣa), for many years the rival, and ultimately the conqueror, of the adjoining State of Nepāl, of which the protector was Matsyendranāth. It is from Gorkhā that our 'Gurkha' soldiers take their name. Tibetan tradition⁷ claims Gorakhnāth as a Buddhist magician, and states that his Kānphaṭā disciples were also originally Buddhists, but became followers of Śīvara (i.e. Śaivas) on the fall of the Sena dynasty at the end of the 12th cent., as they did not wish to oppose the Musalmān conquerors.⁸

Another Nepāl legend makes Gorakhnāth cause a drought lasting twelve years, by the simple expedient of collecting all the sources of water and sitting on them. Buddhist and Brahmanical traditions differ as to the method by which the water was released, but the episode is one of the most important in the cycle of old stories which forms a preface to the sober historical notices of the country.⁹

Gorakhnāth has long been deified in India proper, and legend gives him omnipotence. He can coerce even Brahmā, the god of Fate, and command him to alter a person's destiny.¹⁰ Sometimes he is shown as greater even than Śīva

¹ S. Lévi, *Le Népal*, Paris, 1906, i. 347 ff.

² H. H. Wilson, *Religious Sects of the Hindus*, London, 1861-62, i. 213.

³ *JA* vii. [1878] 50.

⁴ Cf. *PNQ* ii. [1884] 279, and Dalpatrām Prānjan Khakhar, in *JA* vii. 47.

⁵ The best known are the *Gorakṣasataka*, the *Chaturāṣṭya-sāna*, the *Jānāmṛta*, the *Yogachintāmaṇi*, the *Yogamahiman*, the *Yogasiddhāntapaddhati*, the *Vivekamārtanḍa*, and the *Siddhasiddhāntapaddhati*.

⁶ Wilson, i. 213.

⁷ Tāranātha, *Gesch. des Buddhismus in Indien*, tr. Schiefner, St. Petersburg, 1869, pp. 174, 256, 323.

⁸ Lévi, i. 355 ff.

⁹ For the Buddhist story, see D. Wright, *History of Nepal*, Cambridge, 1877, p. 140 ff.; and, for both, Lévi, i. 348 ff., 351 ff.

¹⁰ Cf. W. Crooke's note to the story of Gūgā, *JA* xxiv. [1896] 51.

himself.¹ His principal shrine is at Gorakhnāth in the district of Gorakhpur in the United Provinces. The best account of this is that given by Buchanan-Hamilton.² The local tradition is that Gorakhnāth is identical with the Supreme Being. In the Satya Yuga (or Golden Age) he lived in the Panjāb,³ in the Tretā Yuga (or Silver Age) at Gorakhpur, in the Dvāpara Yuga (Copper Age) at Hurmuj († Hormuz), and in the Kali Yuga (or present Age) at Gorakmadhī in Kāṭhīāwar.⁴ He also for some time resided in Nepāl.

In a cyclic poem, entitled *The Song of King Mānik Chandra*,⁵ current in the Rangpur District of Bengal, his immediate disciple, the Hādī Siddha, a magician of great power, was a kind of domestic chaplain to the terrible queen Mayanā, and induced her son, King Gopichandra, to abandon his kingdom and to become an ascetic for twelve⁶ years. During this time Gopichandra had to sink to the lowest depths and perform menial offices to a common harlot. The Hādī Siddha was himself a sweeper by caste—a fact which, in the locality in which the poem is current, implies nameless abomination. Rangpur lies outside the traditional Aryan pale, and the whole group of circumstances points to non-Aryan tradition. The poem, moreover, contains numerous traces of Buddhist influence.⁷

The legend of Gopichandra is also met with in other parts of India. A popular, and widely spread, version makes Gorakhnāth himself convert the famous King Bhartṛhari and induce him to adopt an ascetic career. According to others, the name of the hero is Gopichand, and sometimes Gopichand-Bhartṛhari.⁸ Indeed, the association of Gorakhnāth and Bhartṛhari forms the theme of a drama by Harihara, the *Bhartṛharinirveda* (tr. Gray, *JASOS* xxv. [1904] 197-230).

No legend is more popular in Northern India than that of Gūgā, of which several versions have been published.⁹ Here not only is Gorakhnāth the wonder-working saint who is responsible for the birth of the hero; he is also the *Deus ex machina* who ever and anon appears to help him. It is in this story that, as we have seen, with this object he bends even Fate to his will.

So also in other important folk-tales, such as those of Pūran Bhagat, and of Rājā Rasālū, he takes a most prominent part.¹⁰ In fact, in the popular religion of India he is the representative of Śīva, or even a form of that god himself—a character which is consonant with the literary tradition that he was a great teacher of the Śaiva religion, and an opponent of the mediæval Bhakti-mārga reformers of northern India.¹¹

¹ Cf. G. A. Grierson, *JASBe* xvii. pt. i. p. 139 ff.

² *Ap.* Montgomery Martin's *Eastern India*, London, 1838, ii. 484.

³ According to D. Ibbetson, *Outlines of Panjāb Ethnography*, Calcutta, 1883, § 528, the Kānphaṭā Yogīs are specially strong in the higher Panjāb Himālaya, where Śīva is worshipped. There they perform semi-sacerdotal functions.

⁴ Cf. *BG* viii. [1884] 155, 446.

⁵ Edited and translated by G. A. Grierson in *JASBe* xvii. pt. i. p. 135 ff.

⁶ So, Gorakhnāth shuts up the rain for twelve years, and was one of the twelve disciples of Matsyendranāth.

⁷ Cf. Dinesh Chandra Sen, *Hist. of Bengali Language and Literature*, Calcutta, 1911, p. 56 ff.

⁸ Cf. G. A. Grierson, 'Two Versions of the Song of Gopī Chand,' *JASBe* lvi. pt. i. p. 85 ff.; and W. Crooke, *TC*, Calcutta, 1896, iii. 153 ff.

⁹ E.g. W. Crooke, *PR* 2, London, 1896, ii. 211, and *JA* xxiv. 49 f. (in the latter there are references to other versions); J. M. Douie, *PNQ* i. [1883] 3; R. Temple, *Legends of the Panjāb*, Bombay, 1884-1900, i. 121 f. and iii. 261.

¹⁰ For these, and others, see R. Temple, *op. cit.*, Index, s.v. 'Gorakhnāth.' According to a tradition of the Nepāl Tarāī, during Yudhiṣṭhira's journey through the Himālaya to heaven his brethren fell behind and perished one by one. Only Bhīmasena survived. He was saved by Gorakhnāth, who made him king of Nepāl (Grierson, 133).

¹¹ Cf. G. S. Leonard, 'Notes on the Kānphaṭā Yogīs,' *JA* vii. 299. For Bhakti-mārga, see *ERE* ii. 539 ff.

It is difficult to sift any grains of truth from this heterogeneous mass of fable. If Gorakhnāth is not a purely mythical personage—a reflexion in the popular mind of the great Śaiva doctor Śaṅkarāchārya—it is probable that the literary account of him is correct, and that he did convert Nepāl from Mahāyāna Buddhism to Śaivism. He may himself have been a native of the Himālaya, where, alongside or in spite of Buddhism, the worship of Śiva has always been prevalent. We have seen that in the western Himālaya, north of the Panjāb, his followers, the Kānpaṭā Yogīs, still perform sacerdotal functions. If, on the other hand, his name merely means the 'Lord of Gorakṣa,' it may simply represent Śiva as the guardian deity of that State; and the conversion of Nepāl may refer to the historical fact of the Gorkhā conquest of the country, which was under the protection of the Buddhist Ārya Avalo-

GORGON (from Gr. γοργός, 'terrible,' 'wild,' 'fierce'; cf. O.Ir. *garg*, 'wild,' 'rough'; M.H.G. *karc*, 'strong,' 'violent'; Russ. *zarkij*, 'angry,' 'quarrelsome'; Slav. *groza*, 'horrid'; Ir. *grāin*, 'ugliness' [see Prellwitz, *Etymol. Wörterbuch*², Göttingen, 1905, and Boisacq, *Dict. etymol.*, Heidelberg, 1907 ff., *s.v.*]).—The Gorgons are to the modern mind three mythological beings of hideous form and evil character, one of whom, Medusa, was slain by Perseus. Her terrible face, later conceived of as beautiful, had power to turn men into stone. Her head, cut off by Perseus, was put by Athene in the centre of her shield; it was called the Gorgoneion. We now know that the Gorgons took their rise not in mythology but in ritual, and that they are expressions ('projections') of a very primitive religious emotion. It is unnecessary nowadays to spend time and space in examining bygone attempts at interpreting the



FIG. 1. Gorgon on Rhodian Plate.

kiteśvara (Matsyendranāth). Such an explanation, though well-suited to the state of affairs in Nepāl, will not account for the prominent position occupied by Gorakhnāth in the folk-religion of the plains of India.

No connected account of Gorakhnāth has hitherto been written. The subject is well worthy of further investigation, for it is of considerable importance in the religious history of India. But such a study must be undertaken on the spot, by a scholar conversant not only with Indian literature, but also with ethnology and folklore.

LITERATURE.—The authorities for the various statements contained in this article will be found in the footnotes.

G. A. GRIERSON.

GORAKHPANTHI.—A name sometimes used in Northern India for the Kānpaṭā Yogīs, as disciples of Gorakhnāth. See artt. GORAKHNĀTH and YOGĪS.

mythological Gorgons, as, *e.g.*, storm-clouds. Such attempts were possible only when it was supposed that the concept as well as the name of Gorgon was confined to the Greeks. We now know it to be world-wide. What the Greeks did here, as so often elsewhere, was by their fertile play of fancy to conceal a simple fact—the use of ritual masks for magical and especially for apotropæic purposes. The Gorgon as monster sprang from the Gorgoneion, the terrible face or head; not the Gorgoneion from the Gorgon.

The primitive Greek had, in his ritual, a grinning mask, with glaring eyes, protruding beast-like tusks, and pendent tongue. He called it *gorgoneion*. He used it, as the savage does today, to scare away evil things—his enemies in the flesh and his ghostly enemies. He wore it on his shield; he placed it over his house; he hung it on his oven; doubtless, though here precise evi-

dence fails us, he danced with it as a mask at his ritual dances. Most anthropological museums contain specimens of *gorgoneion*-like dancing-masks; the Museum für Völkerkunde at Berlin has excellent examples, with tusks and protruding tongue. The function of such masks is permanently to make an 'ugly face' for prophylactic purposes.

Ritual masks fell into disuse, but still the pictures of them went on, on pottery, as the blazon of shields; the traditional Athene not only wore the goat-skin *ægis* which had once been the ordinary dress of her people, but on her breast she wore the Gorgoneion, the beast's head, humanized by degrees, but always made frightful. The Greek, being always curious as to causes and a born story-teller, asked the question whence came the bodiless dreadful head: it must have been severed from the body of a monster, the monster must have been slain; a slayer was provided—the hero Perseus. The name Gorgoneion presupposes the Gorgon, but the conception of the monster rose out of the bodiless head, the mask.

Our earliest literary notice of the Gorgon bears out this interpretation—that the head is primary and essential, the monster begotten only to account for it. Odysseus in Hades (*Od.* xi. 633 ff.) desired to hold further converse with dead heroes, but,

'Ere that might be, the ghosts thronged round in myriads manifold,
Weird was the magic din they made, a pale-green fear gat hold

Of me, lest, for my daring, Persephone the dread

From Hades should send up an awful monster's grizzly head.'
It would have been more natural and efficacious for Persephone to send up the monster herself, but there was no monster, only a grizzly head (*γοργεῖν κεφαλήν*). In early representations in art the dreadful head is always prominent; and the body like a mere appendage tacked on. This is clearly seen in fig. 1 from an early Rhodian plate in the British Museum (*JHS* vi. [1885], pl. lix.). Here the 'ugly face' has been furnished with a body

—not a human monster. Art has been at work to make it more hideous: the staring eyes are surrounded by a pattern in spots; the upstanding hair, which sometimes develops into snakes, is well shown, and the tongue protruding from the wide grinning mouth; the mouth grins in order the better to show the teeth. The gesture of putting out the tongue to show aversion survives in the street-boy of to-day. The origin of the gesture seems to be not so much to show disgust as to eject some hurtful substance from the mouth. The religious content is the same as that of spitting—at first to get rid of evil, then to avert it. We may compare the Greek word for winnowing-fan, *πτύον*, or the spitter, i.e. the rejecter of chaff (see art. *FAN*, vol. v. p. 754). If we were to give such action a specialized name, we should have to call it not *apotropæic* but *apoptuic*.

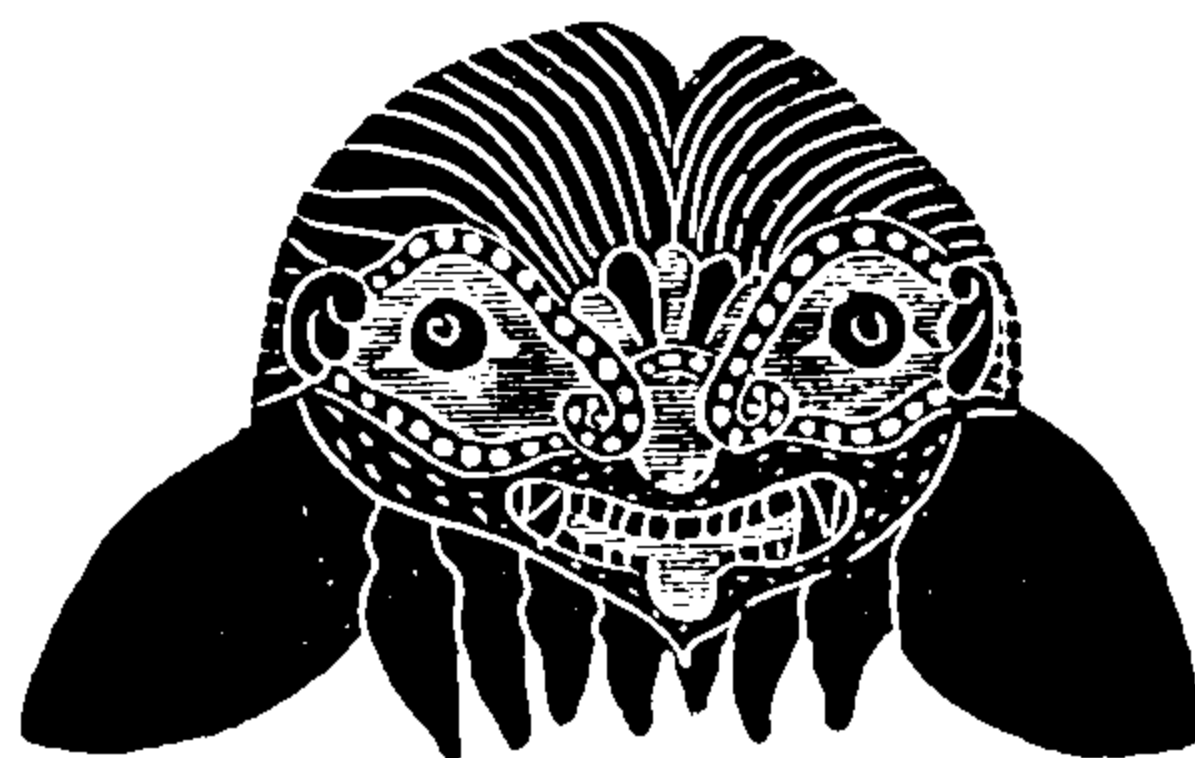

FIG. 2. Gorgon on Corinthian Vase.

In fig. 3 we have a Maori staff in the present writer's possession decorated with a Gorgoneion. With such staffs held horizontally, the Maori advance against their enemies to frighten them by showing the 'ugly face.' The protruding tongue forms the front of the staff; the tongue is elongated out of all proportion, and at first sight the Gorgon-head is not easy to recognize. But all the

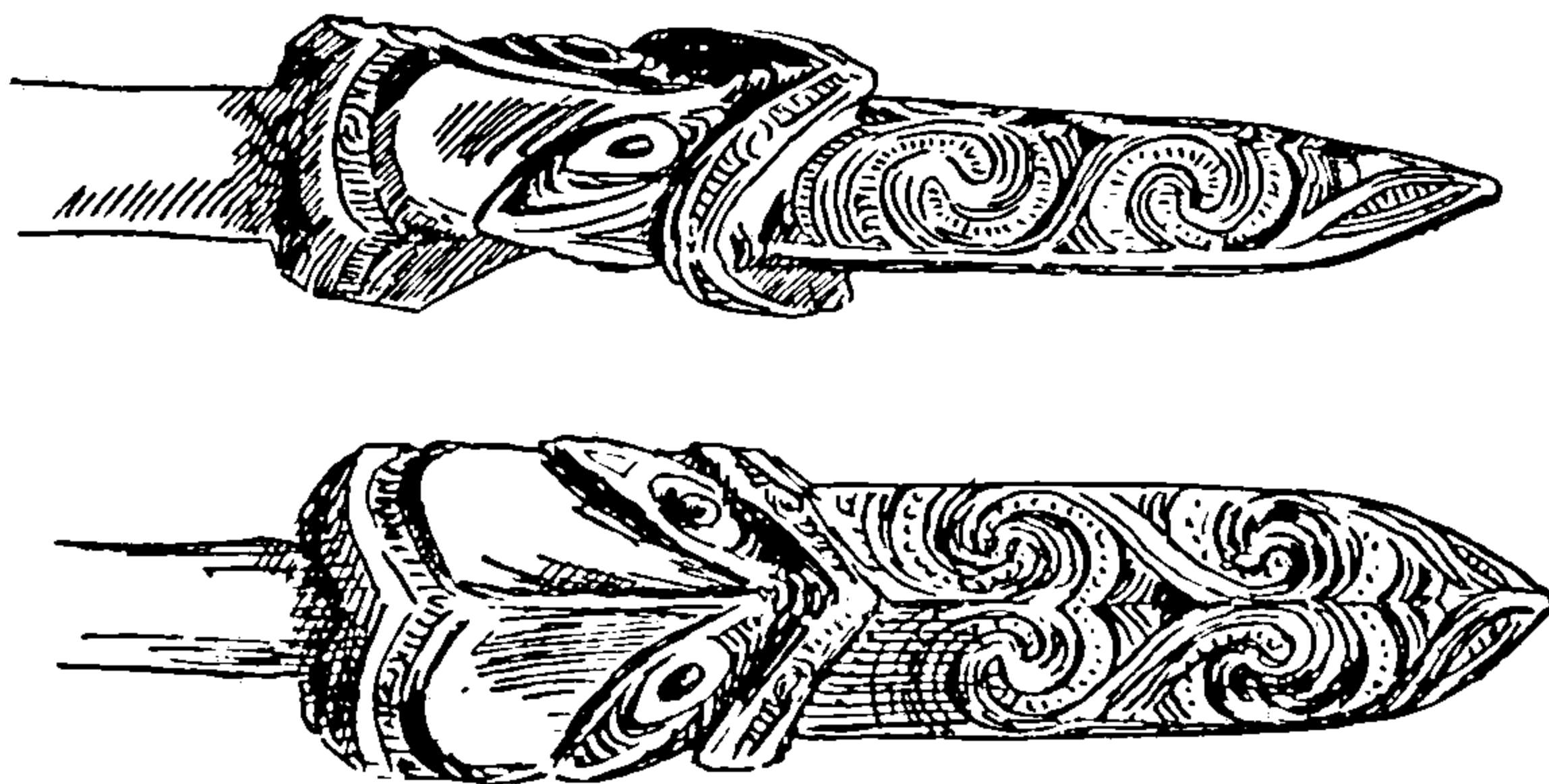

FIG. 3. A Maori Staff with a Gorgon-head.

and four wings; the monster thus compounded holds two birds in heraldic fashion like 'Lady-of-Wild-Creatures' (*πρόνια θηρών*). She has developed from an 'ugly face' into an evil demon.

In fig. 2 we have a Gorgon from a Corinthian vase at Munich. Here it is evident, from the long drooping ears, that the 'ugly face' is that of a beast

usual features are present: eyes filled in with enamel, overhanging brows, nose, mouth, and, inside the latter (invisible in fig. 3), a row of teeth. The face is, however, so subordinated to the long, highly decorated tongue that its meaning might easily be lost.

Finally, it is of interest to note that the the-

atrical masks of Dionysos retain the wide open mouth (see MASKS). The *gorgoneion* is, in fact, only one particular form of a dance-mask. It stands as a constant memorial of the religion of fear—it is Terror incarnate.

See also art. GRAIAI.

LITERATURE.—For Gorgon mythology, see Roscher and Daremberg-Saglio, s.v. 'Gorgonen'; for ritual origin: J. E. Harrison, *Proleg. to Study of Gr. Rel.*, Camb. 1903, pp. 187, 197; for Gorgons in modern Greece and their relation to Sirens: J. C. Lawson, *Modern Gr. Folk-Lore*, do. 1910, pp. 184-190; for an attempted interpretation of the combat of Perseus and Medusa as a fight between octopus and lobster: F. T. Elworthy, 'A Solution of the Gorgon Myth,' in *FL* xiv. [1903] 263, and *ERE* v. 609; for the Gorgoneion on Athene's *egis* as a beast's head: W. Ridgeway, in *JHS* xx. [1900] p. xlv.; for the Gorgon mask: M. Mayer, 'Mykenische Beiträge,' in *Jahrbuch d. arch. Inst.*, Berlin, 1892, p. 201. For a rich collection of material, see O. Gruppe, *Gr. Mythol. und Religionsgesch.*, Munich, 1906, Index, s.v. 'Gorgones.'

J. E. HARRISON.

GOSAIN.—1. Name and distribution.—The name in its varied forms (Gusāin, Goswāmi, Gosāmi, Swāmi, Sāmi) comes from Skr. *gosvāmin*, 'master of cows or herds,' with the secondary sense of 'one who has brought his passions into control.' It is used to designate an Order of Hindu ascetics or beggars, of whom 182,648 were recorded at the Census of 1901, being most numerous in Bombay, Rajputānā, Bengal, the Central Provinces, and Berar.

2. Classification.—The term is ill defined, and its import varies in different parts of India. The most convenient distinction is between the Śaiva, or worshippers of Śiva, and the Vaiṣṇava, or worshippers of Viṣṇu.

(a) *Śaiva Gosāins*.—The most respectable members of this Order are the spiritual descendants of the great South Indian teacher, Śaṅkarāchārya, the very incarnation of the strictest Brāhmanism, who lived in the beginning of the 8th cent. A.D. He is said to have had four principal disciples, from whom the ten divisions of the Order—hence called the 'ten-named,' or Daśnāmī Daṇḍis—originated. These are: Tīrtha, 'shrine'; Āśrama, 'order'; Vana, 'wood'; Aranya, 'forest,' 'desert'; Sarasvatī and Bhārati, the goddesses of learning and speech; Puri, 'city'; Giri and Pārvata, 'a hill'; and Sāgara, 'the ocean.' Each member adds to his own name that of the group to which he belongs—e.g. Ānanda-giri, Vidy-āraṇya, Rāma-āśrama.

There are but three, and part of a fourth mendicant class, or those called Tīrtha, or Indra, Āśrama, Sarasvatī, and Bhārati, who are still regarded as really Śaṅkara's Daṇḍis. These are sufficiently numerous, especially in and about Benares. They comprehend a variety of characters; but amongst the most respectable of them are to be found very able exponents of the Vedānta works. Other branches of Sanskrit literature owe important obligations to this religious sect. The most sturdy beggars are also members of this Order. . . . Their contributions are levied particularly upon the Brahmanical class, as, whenever a feast is given to the Brāhmins, the Daṇḍis of this description present themselves as unbidden guests. . . . Many of them practise the Yoga, and profess to work miracles. . . . The remaining six and a half members of the Daśnāmī class, although considered as having fallen from the purity of practice necessary to the Daṇḍi, are still, in general, denominated Atīti [Skr. *atīta*, "passed away, liberated from worldly cares and passions"] (H. H. Wilson, *Religious Sects of the Hindus*, i. 203 ff.). The Daṇḍi derives his name from the fact that he carries a small wand (*daṇḍa*) with several projections from it, and a piece of cloth dyed with red ochre, a colour which comes down as the garb of religious persons from the Brāhmaṇa and Epic periods (A. Weber, *Hist. of Indian Literature*, Eng. tr., London, 1882, p. 78). In this cloth his Brahmanical cord is supposed to be enshrined. He shaves his head and beard, wears only a patch of cloth round his loins, and rubs himself with ashes, probably in the first instance taken from the sacrificial fire, with which he purifies himself, repels evil spirits, and acquires *mana* (cf. J. E. Harrison, *Proleg. to the Study of Gr. Rel.*, Cambridge, 1903, p. 492 ff.; L. R. Farnell, *The Evolution of Religion*, Oxford, 1905, p. 100). He usually wears on his forehead, as a charm or amulet, and as a mark of his Order, a triple transverse line, made with sacred ashes. He subsists on food obtained ready dressed from the houses of Brāhmins once a day only, and this he receives in a small clay pot which he always carries. The main distinction between the Daṇḍi and the Atīti is that the latter does not carry the

staff, possesses clothes, money, and ornaments, prepares his own food, and admits associates from castes other than the Brāhman.

Śaiva Gosāins fall into two classes—monks, known as Maṭhdhāri (Hind. *maṭha*, 'a monastery,' *dhāri*, 'occupying'), as contrasted with the Gharbāri, or laymen (Hind. *gharbār*, 'house and home'). The true Daṇḍi should, in accordance with the precepts of Manu (*Laws*, vi. 41 ff.), live alone, near to, but not within, a city. Many of them, however, at the present time, particularly at holy places, like Benares and Hardwār (*qq.v.*), specially devoted to the cultus of Śiva, live in monasteries. The lay members of the Order follow trade and other secular occupations, marry, and have families. While the true Daṇḍi Order is recruited only from Brāhmins, the Gosāins receive not only children devoted by vow or those born to lay members of the Order, but all classes of Hindus, except the very lowest and most polluted castes. In the Deccan they are drawn chiefly from the Kunbī (cultivators) or Mālī (gardeners) (*BG* xvi. 490). In Benares, according to M. A. Sherring (*Hindu Tribes and Castes in Benares*, Calcutta, 1872-81, i. 256), the admission of a novice usually takes place at the festival known as the *Śiva-rātri*, or 'night of Śiva.' Water brought from a tank in which a *liṅga* has been deposited is poured over his head, which is then shaved. The *guru*, or head of the Order, whispers one of the usual Śaiva formulæ (*mantra*) into his ear—*nama Śivāya*, or *om nama Śivāya*, 'in the name of Śiva,' or *om so'ham*, 'I am He,' embodying the Smārta principles that man's spirit is identical with the One Spirit (*ātmā*, *Brahma*), which is the essence and substratum of the universe, and cognizable only through internal meditation and self-communion (M. Monier-Williams, *Brāhmanism and Hindūism*, London, 1891, p. 95). According to J. Grant Duff (*Hist. of the Mahrattas*, Bombay, 1873, p. 7 n.), in the Deccan those castes which wear the loin-string destroy it, and substitute a piece of cloth, if any covering be deemed necessary. Up to this stage the novice may change his mind; the irretrievable step by which he becomes a Gosāin for ever is the performance of the *homa*, or fire-sacrifice, when butter and milk are poured on the holy fire; and, while sacred texts are repeated, the candidate vows poverty, celibacy, and a life spent in constant pilgrimages to the holy places of Hinduism (cf. *BG* xv. pt. i. p. 350 ff., xix. 118).

(b) *Vaiṣṇava Gosāins*.—The term Gosāin is also applied to the heads of the Vaiṣṇava communities in Assam and Eastern Bengal (see *ERE* ii. 136 ff.; E. A. Gait, *Assam Census Report*, 1891, i. 80 ff.; B. C. Allen, *ib.*, 1901, i. 39). The adoration of the *guru* is the essence of Vaiṣṇavism in Bengal, and it has been extended among the Vallabhāchāryas, 'the Epicureans of the East,' until among the Bombay leaders, known as Mahārājā, 'great king,' it became a cause of shameful scandals (J. Wise, *Notes on the Races, Castes, and Tribes of Eastern Bengal*, 57; [Karsandās Mūlji], *Hist. of the Sect of the Mahārājas or Vallabhāchāryas*, London, 1865; *Report of the Maharaj Libel Case*, Bombay, 1862; F. S. Growse, *Mathura, a District Memoir*, Allahabad, 1883, p. 282 ff.). J. Wise writes:

'The Gosains are a comparatively pure stock, and fair specimens of the higher Bengali race. As a rule they are of a light brown, or wheaten, colour, tall and large-boned. Muscular they ought to be, but indolence and good living stamp them at an early age with a look of sensuality and listlessness, and they become large fat men, fond of sleep, their chief muscular exertion consisting in holding out the foot to be kissed by admiring followers. Their lives are passed in sensual pleasures, and the boundless influence they wield among thousands of the middle classes is, unhappily, not directed to their moral elevation. Satisfied with a blind and unquestioning adoration, they are quite content, if it lasts during their lifetime, to disregard the possibility of agitation and revolution' (*op. cit.* 159).

On the other hand, B. C. Allen thus writes of the class in Assam :

'The leading Vaishnavite Gosains, who live in their Sattras or colleges surrounded by their *bhakats* or monks, are men who exercise great authority over their numerous disciples, and on the whole exercise it wisely and well. . . . Unlike many priests, the powerful Gosains have always been conspicuous for their loyalty to Government, their freedom from bigotry, and the liberality of their views, and Hinduism is seldom presented in a more attractive form than that which is found in the Vaishnavite monasteries of the Majuli, the island which is formed by the confluence of the Brahmaputra and the Luhit' (*Census Report*, 1901, l. 41).

It is admitted on all sides that the wandering Gosains are a profligate class, who consort with prostitutes and women who have deserted their husbands (*BG* xiii. pt. i. p. 196, xx. 183 f. ; H. Risley, *TC* ii. 344 ff.). In former times they were notorious in many parts of the country for their violence and rapacity (see numerous references in *BG* xiv. 135 n.). Later they joined the Mahratta armies, garrisoned many hill forts, and were recruited in large numbers in the service of Mahādji Sindia (Grant Duff, 478 f. ; *BG* xviii. pt. i. p. 452).

LITERATURE.—Most of the chief authorities have been quoted in the article. The best general authority is still H. H. Wilson, *Religious Sects of the Hindus*, London, 1861-62. For the Panjāb, the *Census Reports*—1881 by D. C. J. Ibbetson, 1891 by E. D. MacLagan, 1901 by H. A. Rose; for the United Provinces, W. Crooke, *TC*, Calcutta, 1896; for Bengal, H. Risley, *TC*, do. 1891; J. Wise, *Notes on the Races, Castes, and Trades of Eastern Bengal*, London, 1883; Jogendra Nath Bhattacharya, *Hindu Castes and Sects*, Calcutta, 1896; for Bombay, *BG*, ed. J. Campbell, Bombay, 1877-1904; Govindbhai H. Desai, *Census Report Baroda*, 1911.

W. CROOKE.

GOSĀLA.—See ĀJIVIKĀ.

GOSPEL.—This word (from *Godspell*, i.e. 'God-story' or 'Divine word') has since Anglo-Sax. times been the translation of *εὐαγγέλιον*.¹ In Homer the Greek term denotes the reward given to a messenger for bringing good tidings: *εὐαγγέλιον δέ μοι ἔστω* (*Od.* xiv. 152; cf. 166). In Attic Greek, *εὐαγγέλια θύειν* means to present a thank-offering to the gods for good tidings. In the LXX the plur. denotes a messenger's reward for good news. David relates with grim irony that, when a man came to him to announce Saul's death, expecting to be welcomed as a bearer of glad tidings, his reward (*εὐαγγέλια*) was death (2 S 4¹⁰). In 2 S 18^{22, 23}, where the idea of a reward for good news is unsuitable, it is probable that *εὐαγγέλια* (noun fem. sing.), signifying 'tidings,' should be read instead of *εὐαγγέλια*.

The first explicit references to the preaching of Divine good tidings—a gospel intended for a whole people—occur in Deutero-Isaiah (40⁹ 41²⁷ 52⁷ 60⁶ 61¹). In 40⁹ *ὁ εὐαγγελισόμενος* (ἠγγεζ) represents an ideal band of heralds sent to announce to Zion and Jerusalem the glad tidings that, Israel's sin being now forgiven, the exiles are to be delivered from Babylon and restored to their own land. Is 52⁷—'How beautiful upon the mountains are the feet *τῶν εὐαγγελισομένων*,' κ.τ.λ.—is quoted in an abbreviated form (Ro 10¹⁵) by St. Paul, who adds, with thoughts of Israel's unbelief in his own day, 'but they did not all hearken to the glad tidings' (*τῶ εὐαγγελίῳ*). In Is 61¹ the speaker, who may be either the prophet himself or Israel idealized as the servant of Jahweh, announces that Jahweh has anointed him (*ἐχρίσε με*) to preach good tidings to the meek (*εὐαγγελισσάσθαι πτωχοῖς*), and Jesus appropriates the words as the text of His sermon in the synagogue of Nazareth (Lk 4¹⁸).

After the crises of the Baptism and the Temptation, 'Jesus came into Galilee preaching the gospel' (*κηρύσσων τὸ εὐαγγέλιον*, Mk 1⁴). He 'went about

¹ In the NT *εὐαγγέλιον* never denotes a Gospel in writing, or one of the Four Gospels, though Mk 1¹ prepares the way for this later usage, which is apparently, though not certainly, found in the *Didache* (ch. xv.). Justin Martyr (*Apol.* i. 66) is the first to make explicit reference to the Four Gospels as *εὐαγγέλια*.

in all Galilee' (Mt 4²³), 'all the cities and the villages' (9³⁵), publishing it. He sent His disciples to proclaim it (10⁷, Lk 9²). It was called 'the gospel of God' (Mk 1⁴), i.e. the good tidings sent from God to men through Jesus, and 'the gospel of the Kingdom' (Mt 4²³ 9³⁵ 24¹⁴), i.e. the gospel which prepared men for the immediate founding of the Heavenly Kingdom on earth. In the Apostolic Church it was known as 'the gospel of God' (Ro 1¹ 15¹⁶, 1 Th 2⁹), 'the gospel of the grace of God' (Ac 20²⁴), 'the gospel of Christ' (Ro 1¹⁶ etc.), simply 'the gospel' (Ro 10¹⁶ etc.), 'the gospel of the glory (manifested presence) of Christ' (2 Co 4⁴), 'the gospel of your salvation' (Eph 1¹³), 'the gospel of peace' (6¹⁶), 'an eternal gospel' (Rev 14⁶).

i. The content of the gospel.—Here two points have to be kept distinct. (1) What did the evangel signify for Jesus Himself, and for the disciples whom, in the course of His Galilæan ministry, He sent to preach it? (2) What did it mean, after His Passion, in the Church which was founded on the fact of, or at least the belief in, His resurrection?

Pursuing the historico-critical method of investigation, scholars have obtained a definite answer to the second of these questions. They agree in the conclusion that the good tidings preached in the very earliest Apostolic Church was a gospel regarding the incarnate, atoning, judging, redeeming, glorified Christ. It was the Church's first confession of faith that Jesus was declared (or determined, *δησιθελς*) to be the Son of God with power by the resurrection of the dead (Ro 1⁴, cf. Ac 2²⁴⁻³²). There never was a time when the Church merely honoured Him as prophet, hero, or saint; she always worshipped Him as Lord and Redeemer. There is no evidence of any consciousness of a transition from the subjective religion of Jesus to the objective gospel of Christ. The Church was not founded on a new doctrine of God the Father of which Jesus was the teacher; it was based on the faith of the Church in His own unique personality. He was not the discoverer of a fact which was independent of Himself; He *was* the gospel, the mystery hid from the ages and finally revealed. It is, indeed, one of the accepted results of NT criticism that the primitive Church was never anything else than 'evangelical.'

But the other question remains to be answered. What was the gospel according to Jesus? What was the substance of His own teaching? What were the glad tidings which He bade His disciples—'whom also he named apostles' (Lk 6¹³)—carry to the lost sheep of the house of Israel? In other words, What was the spiritual legacy which He personally wished to bequeath to mankind? To this question the most diverse answers are given by living scholars.

(a) Some say, with Harnack, that 'the whole of Jesus' message may be reduced to these two heads—God as the Father, and the human soul so ennobled that it can and does unite with Him' (*What is Christianity?*, p. 65).

'In the combination of these ideas—God the Father, Providence, the position of men as God's children, the infinite value of the human soul—the whole Gospel is expressed' (p. 70). 'The gospel, as Jesus proclaimed it, has to do with the Father only, and not with the Son' (p. 147). 'The sentence, "I am the Son of God," was not inserted in the Gospel by Jesus himself, and to put the sentence there side by side with the others is to make an addition to the Gospel' (p. 149). The gospel according to Jesus, it has to be admitted, is connected with 'an antiquated view of the world and history,' but Harnack contends that the connexion is not indissoluble. 'The man to whom the Gospel addresses itself is "timeless," that is, it addresses itself to *man*, who, in spite of all progress and development, never changes in his inmost constitution and in his fundamental relations with the eternal world. Since that is so, this Gospel remains in force for us too' (p. 152).

(b) Others follow Johannes Weiss, Loisy, and Schweitzer in identifying Jesus' gospel with the apocalyptic hope of the speedy coming of the

Heavenly Kingdom. The 'Weissian theory' is that the Kingdom of God was not, as has generally been supposed, partly present and partly future, but wholly future and wholly transcendental.

'It is in this hope or nowhere that the historian should set the essence of the gospel, as no other idea holds so prominent and so large a place in the teaching of Jesus' (Loisy, *The Gospel and the Church*, p. 59). 'The thought of Jesus was entirely dominated by apocalyptic conceptions of the end of the world' (*ib.* p. 54). All His injunctions to His followers bear the stamp of 'that supreme indifference to human interests which is, historically, the form taken by the gospel' (p. 81). 'Nowhere does He identify the kingdom with God, and God's power acting in the heart of the individual' (p. 66). The new order which the gospel announces 'is objective, and consists not only in the holiness of the believer, nor in the love that unites him to God, but implies all the conditions of a happy life, both the physical and the moral conditions, the external and the internal conditions, so that the coming of the kingdom can be spoken of as a fact that completes history, and is in no way confounded with the conversion of those who are called to it' (p. 59).

On this theory the moral teaching of Jesus was not so much the ethics of the Kingdom as teaching which prepares for the Kingdom. It is an *Interimselbst*, designed for an interval which is expected to be brief (Schweitzer, *Von Reimarus zu Wrede*, 362). Jesus 'does not found a Kingdom; He only announces it. He exercises no Messianic activity, but He waits, with the rest of the world, for God to bring in the kingdom supernaturally' (*ib.* 236).

(c) Others, like Wellhausen (*Einleit. in die drei ersten Evangelien*), prefer to say that what Jesus taught was not 'the gospel.' We must make a broad distinction between Him and the Christian conception of Him which has existed since the foundation of the Apostolic Church. What the actual Jesus was, and what He preached, we can now only surmise. Even in the earliest Christian record which has been preserved—the memoirs of Mark—He stands transfigured before us. The most Christian part of the narrative—Mk 8²⁷ to 10⁴⁶—is the least historical. The Christian Messiah does not represent Jesus' own conception of His Messiahship, but rather the idealized conception which the nascent Church threw back upon His lifetime after His Passion. Divested of the attributes in which dogmatism has clothed Him, Jesus would be a very different figure from the Christ of 'the gospel.' Could we get 'back to Christ,' we should probably find that He was not a Christian but a Jew, who *more prophetic* taught a new and better way of serving God. But He is the Great Unknown. It may be well that we can never discover the truth of what He was, as we should only be disillusioned. If He did not reveal and proclaim 'the gospel,' the Church dreamed it, and she cannot now abandon her dream. Jesus is irrecoverably lost, but the ideal Christ of Paul and John remains. With their evangel we must be satisfied. Wellhausen ends his investigation with these remarkable words:

'If it had not been for his death, Jesus would never have become a subject for history. The impression of his career depends upon the fact that it did not run to a conclusion, but was broken off short, when it had hardly begun.'

(d) Others maintain that the scientific study of the NT is bringing us more than ever face to face with the Founder of Christianity, and removing all suspicion of an antithesis between the religion of Jesus and the gospel of Christ. In the historical Jesus they see 'a Person, who is not only equal to the place which Christian faith assigns Him, but who assumes that place naturally and spontaneously as His own' (J. Denney, *Jesus and the Gospel*, 1908, p. 374). In many passages which the critical analysis leaves unimpaired, the Son of Man reveals His consciousness of Himself, of His vocation, and of His claims upon men in startling and unparalleled language. So far from being unknown, He is the best-known figure in history. Fragmentary as the records of His life confessedly

are, His portrait is singularly complete, and it is instinct with self-evidencing Divinity. It is from concrete historical facts that the great ideas of the gospel derive their value and force. The original impulse of Christianity, the motive-power which from the first ensured its success, did not emanate from the Church's 'will to believe,' but was communicated to the Church by His transcendent personality. The cause cannot have been less wonderful than the effect; the victorious ideal must have been supremely real. It is contended that the resurrection of Jesus, illuminating all His teaching and justifying all His claims, made the Christian faith inevitable. In that stupendous event God gave His Church a supernatural, super-historical Lord and Saviour, and in every age the inner testimony of the Holy Spirit, transmuting the faith once delivered to the saints into a vital, personal, irrefragable experience, establishes the conviction that the gospel of Christ, like the Christ of the gospel, is a Divine Fact, the same yesterday, to-day, and for ever.

While the gospel may be studied as a whole or in its parts, some conception of its entirety and immensity is needful for a due appreciation of any individual aspect of it. Du Bose (in *The Gospel in the Gospels*) analyzes it into the Gospel of the Earthly Life, or the Common Humanity; the Gospel of the Work, or the Resurrection; and the Gospel of the Person, or the Incarnation.

'The life of Jesus would not be a gospel to us if it were not a revelation and a promise of human blessedness' (*ib.* p. 86). 'No view of the gospel could dispense with the death of Jesus' (p. 119). And 'there is not one of the Gospels which would have been written, there would be no Gospel at all, if there had not been not only the death but the resurrection' (p. 137). The Easter faith of the Apostolic Church was inseparable from the Easter fact. 'No criticism can assail the essential fact that something happened, shortly after our Lord's death, which sufficed to convince His disciples that He had arisen and was still alive' (E. F. Scott, *The Apologetic of the NT*, p. 47). 'All the theological demonstration of the Divine significance of Jesus is grounded in the historical fact that He rose again from the dead' (*ib.*).

2. Gospel and Law.—It has always been felt that the charm and power of the Gospel lie in its antithesis to Law. From the beginning of His ministry, Jesus evoked the wonder of His hearers by His 'words of grace' (Lk 4²²). What makes His message to men 'glad tidings' is the forgiving love which differentiates it from the awful majesty of justice. Not that He ever spoke a word in disparagement of Law, whatever He might say of human traditions. His followers never imagined that He intended to relax their moral obligations; rather they felt that He immeasurably raised their ideal of duty to God and man. But Law could never be His last word. While the scribes counted the multitude who knew not the Law accursed, Jesus gave them glad news of forgiveness to make them blessed. In the Apostolic Church it was not the thunders of the Law, but the music of the Gospel which caught the ear of mankind. Paul knew from the hour of his conversion that he must 'testify the gospel of the grace of God' (Ac 20²⁴). 'Grace' and 'Gospel' were his inevitable words, the one occurring some 90 and the other some 60 times in his Epistles. To the 'hard pagan Roman world,' with its 'deep weariness and sated lust,' he published an evangel of grace abounding over sin (Ro 5²⁰). Having himself lived successively under Law and Gospel, and believing both to be Divine, he made it his theological task to harmonize them in thought, and to substitute for the tyranny of Judaism 'the law of the spirit of life in Christ Jesus' (Ro 8²). On the whole, it is probable that he has not misunderstood the yoke which Jesus called easy and the burden He deemed light, but that the Epistles 'are an interpretation only, and not a transforma-

tion or even an essential modification, of the Gospel of our Lord' (Du Bose, *op. cit.* vii.).

LITERATURE.—W. Baldensperger, *Das Selbstbewusstsein Jesu im Lichte der messian. Hoffnungen seiner Zeit*², Strassburg, 1903; A. Harnack, *Das Wesen des Christentums*², Berlin, 1901 (Eng. tr., *What is Christianity?* London, 1904); J. Weiss, *Die Predigt Jesu vom Reiche Gottes*², Göttingen, 1900, *Das älteste Evangelium*, do. 1903; W. Wrede, *Das Messiasgeheimnis in den Evangelien*, do. 1901; H. Weinel, *Jesu im neunzehnten Jahrhundert*, Tübingen and Leipzig, 1903; T. Steinmann, *Die geistige Offenbarung Gottes in der geschichtl. Person Jesu*, Göttingen, 1903; J. Wellhausen, *Einleit. in die drei ersten Evangelien*, Berlin, 1906; W. Bousset, *Jesus*, Halle, 1904 (Eng. tr., London, 1906); A. Schweitzer, *Von Reimarus zu Wrede*, Tübingen, 1906 (Eng. tr., *The Quest of the Historical Jesus*, London, 1910); H. J. Holtzmann, *Das messian. Bewusstsein Jesu*, Tübingen, 1907; H. von Soden, *Die wichtigsten Fragen im Leben Jesu*, Berlin, 1904; A. Loisy, *L'Évangile et l'Église*, Paris, 1902 (Eng. tr. 1903), *Les Évangiles synoptiques*, do. 1908; J. Halévy, *Études évangéliques*, do. 1908; W. Sanday, *The Life of Christ in Recent Research*, Oxford, 1907; J. Denney, *Jesus and the Gospel*, London, 1908; D. W. Forrest, *The Christ of History and of Experience*², Edinburgh, 1906; F. C. Burkitt, *The Gospel History and its Transmission*², do. 1907; W. P. Du Bose, *The Gospel in the Gospels*, New York and London, 1906; N. Schmidt, *The Prophet of Nazareth*, do. 1905; P. T. Forsyth, *The Person and Place of Christ*, London, 1909; W. W. Holdsworth, *The Christ of the Gospels*, do. 1911.

JAMES STRAHAN.

GOSPELS.—The justification for including an article on the Gospels in an Encyclopædia of Religion and Ethics must lie in the immense effect which the Four Canonical Gospels have had and still have in the development and maintenance of Christianity. In the past few years much has been done towards solving some of the preliminary problems connected with the Gospels themselves and the traditions which underlie them. Some assured results have emerged and, as a consequence, certain ways of regarding the Gospels and their contents are imposed on the historical and philosophical investigator, and certain other ways are excluded.

The problems connected with the Gospels may be grouped as (1) *literary*, (2) *dogmatic*, (3) *historical*; and at the end we have to consider (4) the *value* of the Gospels for present-day questions of ethics and religion. Or, to take the case of a single Gospel, we have to consider (1) the method of its composition and the sources used; (2) the theological and ecclesiastical standpoint of the writer; we may then estimate (3) the historical worth of the picture drawn in the Gospel, as a whole and in details; finally, we may ask (4) what religious value and authority this picture of a far-off drama has for our own age.

It is important to notice at the outset that (1) and (2) are indispensable for (3) and (4), and to a great extent can be studied independently of them; but no scientific study of the important subjects grouped under (3) and (4) can be prosecuted without some satisfactory solution of the preliminary questions connected with (1) and (2). To take the most obvious example, a discussion of the general historicity of the Evangelical tradition must start from Mark, and not from Matthew or Luke.

Before surveying the Gospels in detail, we should consider some inevitable features of any document of early Christianity. In the modern study of the Gospels one chief aim is to reconstruct an intelligible picture of the life and work of Jesus Christ. We want the strong lights thrown by the ardour of faith, but we should like also shadows to give individuality to the figure. We want to hear the Gospel story as told from various points of view, and not only from that of the convinced and uncritical believer. Whether we should be really in a better position to comprehend the genesis of Christianity if we had documents of this sort is a question which admits of argument; what is certain is that we have no such documents, and that we are not likely to get them. Even when we have isolated our 'original' authorities, we

shall not be able to regard them as so many independent witnesses such as were sought for by 18th cent. apologists—at least, to continue the metaphor, we must expect to find them agreed upon a tale. The scenes of the life of Jesus Christ on earth were indeed enacted in public, and the multitudes heard His words; but our knowledge of them is derived from the disciples. We cannot hope to know more than the collective memory of the first circle of the believers at Jerusalem. Without pressing the narrative of the Acts in all its details, we learn from St. Paul's Epistle to the Galatians (2¹⁴) that less than nine years after the Crucifixion St. Peter was living in Jerusalem, and it is there and not in Galilee that our authorities place the home of the infant Church. Galilee has never been a Christian land. From the very beginning the Christians lived at a distance from the country in which the Master had worked. Moreover, we are told that 'the multitude of them that believed were of one heart and soul: and not one of them said that aught of the things which he possessed was his own; but they had all things common' (Ac 4³²). This may be an ideal picture, and in any case the state of things was not permanent, but, if it be at all true of individuals in any one particular, we cannot doubt that it was specially true with regard to their reminiscences of the Lord. The memory of the words and deeds of Jesus Christ must have been thrown into the common stock: 'When he was raised from the dead, his disciples remembered that he spake this; and they believed the Scripture, and the word which Jesus had said' (Jn 2²²). Out of the bare reminiscences of the disciples those sayings and acts which in the light of later events were seen to be of significance were repeated to the younger generation that gradually took the place of the companions of the Ministry. The object of the Evangelists was not biography, but edification.

The Gospel record passed through a full generation of pious reflexion and meditation, before it began to be written down and so fixed for all time. This explains to some extent the selection of events and the method of treatment. Above all, it helps us to realize what we get when we come to the final results of the purely literary criticism of the Gospels. Our Second Gospel may be the work of John Mark, some time the companion of St. Peter, and it may embody some things which he had heard from St. Peter's mouth. But even so the narrative has lost much of the personal note; it is far too even to be mere personal reminiscence. The tale of St. Peter's denial, for example, may be substantially true, but the narrative in Mark does not read like St. Peter's own first confession of the story. It is not a tale told for the first time. We are not here suggesting that any written document in Greek or Aramaic underlies St. Mark: the narrative may have been written down for the first time by the author, but some of the tales which he is putting on paper had been repeated many times before by word of mouth.

It is not to be denied that all this lets in the opportunity for errors of detail. 'These things his disciples did not know (*οὐκ ἔγνωσαν*) at the first,' says the Fourth Evangelist; 'but when Jesus was glorified, then remembered they that these things were written of him, and that they had done these things unto him' (Jn 12¹⁶). The Gospels took their shape in an atmosphere of growing and unquestioning faith; they were compiled by men writing in the light of subsequent events. Under such circumstances it is hard for memories to be dryly accurate, it is easy to feel that the more obviously edifying form of a story or a saying must be the truer version. The eye-witnesses of the Word, of whom St. Luke speaks (1²), had

known Jesus the Nazarene for a friend, but they had learned to believe that He was the Only Son of God, and that He now was waiting until the fullness of the times at the right hand of His Father. He had lived among them as man with man, as a master with his disciples, and at the time they had not thoroughly realized the experience they were going through. Now they felt that they would be fools and blind if they failed to see the deep significance of occurrences to which they had paid so little attention, and words of which they had only half understood the meaning. The real wonder is that any intelligible picture of the events has been preserved to us.

1. The origins and literary sources of the several Gospels.—The four Gospels are not, even in a literary sense, four independent works. The Fourth Gospel is most conveniently treated apart. But the three Gospels, according to Matthew, Mark, and Luke, obviously have something in common; they must either copy one another or make use of a common source. The first question is whether this source (or sources) was written or oral. The opinion of the present writer, most unhesitatingly, is that it was a written source. In the first place, the common matter is not mere floating tradition, the property of all the Christian community. Had it been this, it is natural to think that the incidents identically related by Matthew, Mark, and Luke would have been to a larger extent the critical points of the Ministry, and not a capricious selection of anecdotes. The story of the Resurrection, the words from the Cross, the narrative of the Last Supper—in these we might have expected all our authorities to agree, even in detail; but they do not agree. On the other hand, the parenthesis explaining that Jesus turned from addressing the Pharisees to say to the sick of the palsy, 'Arise,' is found in all three Synoptic Gospels (Mt 9^c, Mk 2¹¹, Lk 5²⁴); all three insert at the same point the statement concerning Herod's alarm about Jesus (Mt 14¹², Mk 6^{16c}, Lk 9^{7c}), and Matthew and Mark go on to relate in a footnote, so to speak, the circumstances of John the Baptist's murder; all three inform us that the Pharisees, when they asked about the tribute-money, began by assuring our Lord that He taught the way of God in truth (Mt 22¹⁶, Mk 12¹⁴, Lk 20²¹). These points are matters of secondary detail; an oral tradition which contained them must be held to have had singular consistency, and, if our Evangelists had worked upon a fixed oral tradition of this definite sort, we cannot imagine how they dared to take such liberties with it. A definite oral tradition is authoritative; can we conceive of an oral tradition which accurately distinguishes between the *baskets* (*κέραια*, Mt 14²⁰ 16⁹, Mk 6⁴³ 8¹⁹, Lk 9¹⁷) of fragments taken up after the feeding of the 5000, and the *hampers* (*σφύριδες*, Mt 15²⁷ 16¹⁰, Mk 8²⁻²⁰) taken up after feeding the 4000, but which left the details of the Crucifixion and the Resurrection vague?

A written source, on the other hand, is perfectly definite, but not necessarily authoritative. Where the Evangelists simply copy their common source they agree, whether the point of agreement be important or not, while at the same time the existence of the written document did not prevent the use of other documents or any oral information which might come to hand. There was nothing to compel any of our Evangelists to reproduce the whole of the documents upon which they worked, or to follow them exactly; if they had had such respect for their predecessors' work as never to alter it, they would not have dared to supersede these documents or traditions by their own new Gospels. They would have been mere scribes, or, at the most, harmonists like Tatian.

But we can go one step further. In the parts common to Mark, Matthew, and Luke, there is a good deal in which all three verbally agree; there is also much common to Mark and Matthew, and much common to Mark and Luke, but hardly anything common to Matthew and Luke which Mark does not share. There is very little of Mark which is not more or less adequately represented either in Matthew or in Luke. Moreover, the common order is Mark's order; Matthew and Luke never agree against Mark in the transposition of a narrative.¹ In other words, Mark contains the whole of a document which Matthew and Luke have independently used, and very little else.

This conclusion is extremely important; it is the one solid contribution made by the scholarship of the 19th cent. towards the solution of the Synoptic problem. The present writer believes that we may go on, and claim the Gospel according to Mark as itself the common source. According to this view, no written document underlies our Second Gospel, and the document which the First and Third Evangelists have independently used to form the framework of their narrative is St. Mark's Gospel itself.

Those who do not accept this conclusion fall back upon the hypothesis of an *Ur-Marcus*, an earlier recension or edition of our Second Gospel. This hypothesis presupposes an interest in the biographical details of the public life of Jesus Christ of which there is little trace elsewhere. In the extant remains of very early Christian literature we find the doctrines of the Crucifixion and the Resurrection; we find the arguments from prophecy; we find the ethical teaching of the Sermon on the Mount; and as early as the middle of the 2nd cent. we find copious references to the stories of the Nativity. But the details of the Galilean Ministry are hardly mentioned. It is the peculiar merit of St. Mark's Gospel, from the point of view of the historical investigator, that it deals mainly with a cycle of events quite foreign to the life and interests of the growing Christian communities.

Nearly all the 'peculiarities' of Mark, i.e. those incidents and expressions which were not adopted into the compilations of Matthew and Luke, are of such a nature as to be unattractive or even offensive to the second and third generation of Christians.² And, in dealing with the irreducible remainder, it must never be forgotten that all our MSS of Mark go back to a single copy which breaks off at 16⁸. The so-called 'last twelve verses' (16⁹⁻²⁰) are a later Appendix, designed to supply the lacking conclusion. In other words, our MS tradition goes back to a single book or roll imperfect at the end, and not improbably torn or defaced elsewhere.³ But this mutilated copy was not the autograph, still less was it identical with the copies used by the First and Third Evangelists; and in a few cases the points where they agree against our Mark may represent the true texts of the Second Gospel. Yet it cannot be too strongly stated that such points are few and unimportant, and that the text, as we have it, appears to be unaltered in essentials. It should be remarked, however, that we do not know how much is lost at the end; it may have been much more than a

¹ First clearly formulated by the great classical scholar Lachmann in 1835, as Wellhausen has reminded a forgetful world in his *Einleitung in die drei ersten Evangelien*², p. 33. Lachmann's words are: 'Narrationum evangelicarum ordinis non tanta est quanta plerisque videtur diversitas; maxima sane si aut hos scriptores eadem complexione omnes aut Lucan cum Matthaeo composueris, exigua si Marcum cum utraque seorsim.' C. G. Wilke had independently come to the same conclusion (Wellhausen, p. 34).

² See Hawkins, *Horae Synopticae*², p. 117 ff.

³ e.g. 'Boanerges' and 'Dalmanutha' (Mk 3¹⁷ 8¹⁰) are surely primitive misreadings.

single leaf. Possibly a large part of Ac 1-12 (including the story of Rhoda, the servant at St. Mark's mother's house) may have been based upon the part now missing.

An estimate of the historical value of the Gospel according to St. Mark will be given below. All that has at present been alleged is that it is a main literary source for the other two Synoptic Gospels, and that it does not appear itself to be based on earlier written documents. It is important to notice that the establishment of the relative priority of Mark is based on the comparison of extant documents one with another, and is quite unaffected by the view we may take of the historicity of the Gospels or their ethical value.

2. Date and authorship of 'Luke' and 'Acts.'—The Third Gospel is not a book complete in itself. It is only the first portion of a larger historical work, which was apparently designed to be executed in three volumes. The third volume is not extant; in fact, there is very little reason to suppose that it was ever actually written; but the absence of an adequate peroration at the end of the Acts of the Apostles (which forms the second volume of the series) shows us that a further instalment must have been contemplated. The date of 'Luke' and 'Acts' can apparently be determined within narrow limits. On the one hand, both the Gospel and the Acts contain details drawn directly from the *Jewish Antiquities* of Josephus, a work published in A.D. 93 or 94; on the other hand, the literary evidence indicates that the author of the Gospel and of the Acts is none other than that companion of St. Paul whose travelling diaries are largely quoted in the latter portion of the work. The Gospel and the Acts may therefore be assigned to the decade 95-105; we shall not be far wrong if we say in round numbers about A.D. 100.

(a) The evidence which convicts the Third Evangelist of having used the *Antiquities* (not always with complete accuracy) is very well brought together by Schmiedel in *Encyc. Bibl.*, art. 'Theudas' and 'Lysanias'; see also Burkitt, *Gosp. Hist.* pp. 106-110. The main points are (1) that the mention of Theudas in Gamaliel's speech (Ac 5³⁴) is not only an anachronism, but further it is explicable if the author of Acts drew his information about Theudas from Josephus (*Ant.* xx. v. 1); (2) the introduction of Lysanias of Abilene in Lk 8¹ as contemporary with the 15th year of Tiberius (A.D. 29) appears to be due to a similarly inaccurate use of *Ant.* xx. vii. 1.

(b) The evidence which tends to show that the whole of Luke and Acts is the work of one author, including the travelling diaries in which the writer speaks in the first person plural (Ac 16¹⁰⁻¹⁷ 20⁵⁻¹⁸ 21¹⁻¹⁸ 27¹⁻²⁸), is very well marshalled in Sir J. Hawkins' *Horæ Synopticae* (see esp. p. 183; also Harnack's *Luke the Physician*, 1907, pp. 67-81). 'There is an immense balance of internal and linguistic evidence in favour of the view that the original writer of these sections (i.e. the We-sections) was the same person as the main author of the Acts and of the Third Gospel, and, consequently, that the date of those books lies within the lifetime of a companion of St. Paul' (Hawkins², p. 188).

The two conclusions here indicated are not incompatible. The traveller's diaries, of which the 'We-sections' in Acts consist, show that their author accompanied St. Paul from Troas to Philippi about A.D. 50; there is nothing to show that he was more than a young man of twenty. Thus he would have been born about A.D. 30. Consequently he would not be more than 70 years old when he published the two books dedicated to Theophilus which we possess. Is this really improbable? Does it not rather explain the very different degrees of accuracy which we find in the works of the accomplished writer, whom we shall still not hesitate to call St. Luke? Where he uses his own old diaries, made on the spot and at the time, he is full of information which surprises us now by its minute correctness. He gives the right title to the *Prætors* of Philippi and the *Politarchs* of Thessalonica. Yes; but he was actually there or in the immediate neighbourhood, and keeping a diary. When, on the other hand, he comes to describe the political situation in Palestine about

the time he himself was born, we find him falling into error—error none the less real for being excusable. We do not know under what conditions he had access to the works of Josephus; he may have had the opportunity for a rapid perusal only, with but little time to make notes or extracts for his future use. For the ordinary events of secular history a Christian writer at the end of the 1st cent. would be dependent on the ordinary channels of information. For the events connected with the rise of his own sect he might have special sources to draw upon. He may have conversed during the course of his life with those who had themselves seen the Lord. A comparison with Matthew makes it highly probable that St. Luke also used the document called Q (see below) in addition to the Gospel of Mark. At the same time, the fact that he uses Mark as his main source for the Gospel history seems to the present writer to make it unlikely that he had much personal intercourse with those who had been the companions of the Ministry, men who could themselves have supplied the skeleton of a narrative from their own reminiscences.

3. The composition of the Gospel according to Matthew.—The Gospel according to Matthew, unlike the Third Gospel, cannot be dated with precision, nor are we in a position to name the compiler. Something, however, can be gathered about the sources which he had at his disposal and the circle of ideas in which he moved. Like St. Luke, he was a competent writer; he treats the wording of his predecessors with entire freedom, rearranging and combining them into a well-fused whole. This makes the reconstruction of his lost hypothetical sources an extremely hazardous, if not impossible, task. There cannot be a greater error in Synoptic criticism than to treat the Evangelists as if they had worked like the harmonist Tatian, who made up a single narrative by piecing together the words of the several Gospels almost without alteration.

The happy circumstance that Mark, Matthew, and Luke have all survived, enables us to discover that Matthew and Luke are based on Mark; but, if Mark had not been actually extant, we very much doubt whether modern criticism would have been able to reconstruct it from the other Synoptics. This consideration should render us very cautious in making statements about the contents or arrangement of the other sources on which we may imagine Matthew (or Luke) to have been based. It is, indeed, practically certain that, besides Mark, another document was used in common by Matthew and Luke, of which the main contents were a collection of sayings of the Lord. This document is usually supposed to have been what Papias calls the *Logia* composed by St. Matthew; since Wellhausen (1905) it has been very generally called Q, i.e. *Quelle*.¹ But, before we attempt to reconstruct the lost materials out of which the Gospels according to Matthew and Luke may have been built, we ought to examine the demonstrable procedure of the First and Third Evangelists with regard to (a) the OT, and (b) St. Mark's Gospel.

(a) In the case of St. Luke the first part of the answer is simple. St. Luke uses the Septuagint, the ordinary Bible which the Church inherited from the Greek-speaking Jews. This is notably the case in Lk 1 and 2, where the LXX, and not some Hebrew or Aramaic document, has perceptibly coloured the style and language of the whole narrative.²

¹ About the same time Salmon and J. A. Robinson were also using the symbol Q. 'This notation binds us to nothing' (Salmon, *Human Element*, 1907, p. 24); possibly Salmon wished to regard it as short for *Query*.

² Compare the use of *ἀδυνατεῖν* in Lk 1²⁷ and Gn 18¹⁴. But this is only one instance out of many.

The quotations peculiar to the First Gospel have wholly different characteristics. They are mostly based on the Hebrew, some of them showing curious inaccuracies, arising from a misconception of the Hebrew text, yet a few are clearly taken direct from the LXX. The Hebrew basis is particularly clear in such passages as 'Out of Egypt have I called my son' (Mt 2¹⁵), a quotation of Hos 11¹ that differs both from the LXX, which has 'Out of Egypt I have called back his children,' and from the Targum, which has 'Out of Egypt I have called them sons.' The quotation in Mt 27^{9, 10}, alleged to be made from 'Jeremiah the prophet,' but really based on Zeo 11¹³, owes its presence to a confusion between the Hebrew words for 'potter' and for 'treasury.' This confusion exists in the MT, but the LXX has another reading, and the Targum turns the 'potter' into a Temple official. Thus the Evangelist must have derived his curious interpretation from the Hebrew, and not from the Greek Bible or from current Jewish exegesis. At the same time, seeing that in this passage (27^{9, 10}) he assigns words taken from Zechariah to Jeremiah, and that in 13³⁵ he appears to assign Ps 78² to Isaiah, it is improbable that he was quoting direct from a Hebrew copy of the Prophets. Equally clear is it that the words, 'In his name shall the nations hope' (Mt 12²¹), are taken from the LXX of Isaiah 42^{4b}, and that *κατηρτιστω αλφειω* (Mt 21^{16b}) is taken from the LXX of Ps 8². These last passages show that the Evangelist was after all not unfamiliar with the Greek Bible. This is not surprising; the surprising part is the influence of the Hebrew text in a Greek Gospel. This influence does not make the stories peculiar to this Gospel historical or even probable, but it does tend to show that they originated in Palestine.

(b) The way in which our First Evangelist has used the Gospel of Mark has been so carefully investigated that little more is needed here than a statement of results.

Mt. shortens the narrative of Mk., retaining the main features, but cutting down details and (like St. Luke) suppressing the mention of the various emotions of our Lord, e.g. anger, annoyance, amazement.

Mt. freely transposes the earlier parts of the story, which thereby becomes a series of disconnected anecdotes. The confusion is still further increased by the interpolation of long discourses into the framework of Mk.; however interesting and authentic these discourses are in themselves, they completely break up the unity of the narrative framework. But very little of the Markan narrative is altogether omitted.

Besides the long discourses, Mt. introduces into the Markan narrative certain stories not known to us from other sources, such as Peter walking on the water, Judas and the pieces of silver, the earthquake at the Crucifixion, the guard at the Tomb. There are grave difficulties in making out a claim for considering any of these stories as serious history. At the same time, it should be remarked that their tone and language suggest a Palestinian origin, e.g. the story of the earthquake speaks of Jerusalem as 'the Holy City' (Mt 27^{51b-52}).

In view of the Palestinian origin of the elements peculiar to Mt. it is worth while once more to emphasize the remarkable fact that the Passion narrative in the First Gospel, both in the selection of incidents and in their relative order, follows unquestioningly the corresponding narrative in Mark.

In striking contrast to all this is the procedure of St. Luke. He freely omits large portions of Mk., and in the Passion deserts Mk. for another

story of the last scenes. But the sections of Mk. which are found in Lk. are given in the same relative order; and, although (as in Mt.) much is curtailed, yet there is not the same tendency to interpolate fresh incidents into the Markan stories. There are fresh incidents in Lk., but they are kept separate.

Thus in general plan and arrangement the Gospel according to Matthew is a *fresh edition of Mark*, revised, rearranged, and enriched with new material; the Gospel according to Luke is a *new historical work*, made by combining parts of Mark with parts derived from other documents.

4. Attempted reconstructions of Q.—From the way in which Mt. and Lk. have treated Mk. we may reasonably infer the way in which they have severally treated the lost source Q. We shall expect to find many fragments of Q preserved by Mt. alone, but the general plan and sequence of the work we must gather from the position that the various sections occupy in Luke. If we find certain of these sections occupying the same relative order in Mt., there is a strong presumption that this order is really the order of Q.

(a) In Lk 6²⁰⁻²³, a non-Markan block, we find (1) Sayings of Jesus beginning with Beatitudes and ending with the House upon the Rock, (2) the Centurion's Lad, (3) the Widow of Nain, (4) Sayings about John the Baptist, (5) the Sinful Woman, (6) the women who ministered to Jesus. Of these (1), (2), and (4) occur in Mt., and in the same relative order (Mt 5³⁻⁷ 7⁷ 8¹⁻¹³ 11²⁻¹⁹). We may, therefore, assume that (1), (2), and (4) formed part of Q, and in that order. Starting from this (it is the one thing about Q with regard to which there is reasonable certainty), we may infer from (2) that Q contained not only Sayings of Jesus but also narratives of wonderful cures, etc., such as are found in Mk., and we may infer from (4) that Lk 3⁷⁻¹⁸ (= Mt 4⁷⁻¹²) also had a place in Q, and very probably an account of the Baptism of Jesus also. This makes it likely that the Temptation narrative (Lk 4²⁻¹³ = Mt 4²⁻¹¹) also comes from Q, and that it was followed by a mention of 'Nazara' (Lk 4¹⁶ = Mt 4¹³).

(b) But when we have said this we have said almost all that has high probability about Q as a literary whole. Simply to refer to Q every Saying of Jesus found in Mt. or Lk., or both, which we may consider genuine is not to reconstruct the lost work, but to repeat our opinion that the Saying is genuine. Above all, we cannot base any valid argument upon the supposed absence from Q of certain ideas or types of Sayings. At best, as conjecturally reconstructed out of Mt. and Lk., it resembles a composite photograph; and, like most composite photographs, it appears to us beautiful but unindividualized; if Q were really before us, it would probably show individual features, as individual as the Gospel of Mark—features which might surprise and even shock us. What do we know of Q? Simply this, that it was taken to pieces by Matthew and Luke, and the *disiecta membra* have been put together by modern scholars. It is not surprising that some of the individual features have suffered.¹

(c) Did Q contain a Passion narrative? We cannot tell. This is surely a more scientific answer than the confident assertion of Harnack and others, that it did *not* contain a Passion narrative. The theory of Harnack rests on the absence from Mt., in the story of the Passion, of any fresh material that has a place in Luke. But if we regard Mt. as our enlarged edition of Mk. rather than a new historical work, this is not so surprising. Many and important as are the additions which

¹ As Lk. usually resumes his use of Mk. at the place where he has dropped it, he probably did the same with Q; we venture to suggest that Lk 9⁵¹ may have followed Lk 8¹⁻⁴ directly.

Mt. makes to Mk., very few of them interrupt the actual course of the narrative. The 'Sermon on the Mount' occupies three whole chapters, but in time and place it merely corresponds to Mk 3¹³. Mt 10 corresponds to Mk 6⁷⁻¹¹. Mk 4³³ tells us that 'with such parables' Jesus spoke to them the word; Mt 13 exhibits half a dozen specimens. All through the Gospel the added Sayings and anecdotes are placed in the Markan framework: they have been torn from their original context and fitted into Matthew's revised edition of Mark, to serve as illustrations and enrichments. If Q did contain a Passion story, we need not be surprised to find that the fragments of it used by Mt. are to be found elsewhere than in Mt.'s Passion story, because Matthew is not so much combining Q with Mk. as enriching and illustrating Mk. with Q and other sources. The alternative view, that Q had a story of the Passion and that some of it is preserved in the peculiar sections of Lk 22-24 (notably in Lk 22^{13f. 24-25 25-26}), still remains open.

(d) A number of important Sayings and Parables are found only in Lk. or only in Mt., e.g. the Prodigal Son (Lk 15¹¹⁻²³) and the Labourers in the Vineyard (Mt 20¹⁻¹⁶). It is certainly difficult to see why the other Evangelist should not have incorporated them, on the supposition that they lay before him in a document which he otherwise valued. It seems better not to assign such pieces to Q and to suppose that the Evangelists derived them from some other source, written or oral, the contents and nature of which we are not in a position further to determine.

One very common misconception may be here conveniently noticed. Some writers speak of 'the Triple Synopsis' and 'the Double Synopsis,' meaning by the former phrase the incidents or sayings found in all three Synoptic Gospels, and by the latter those found in Matthew and Luke. The phrases are somewhat misleading, as they inevitably suggest that the portions comprised under the Triple or the Double Synopsis are better attested than those which are found in one document only. But to those who hold that Mt. and Lk. actually used our Mk. and another document besides, it is evident that the *consensus* of all three Synoptics resolves itself into the single witness of Mark; and the *consensus* of Mt. and Lk. is in many cases only to be regarded as the single witness of the lost document discussed in the preceding paragraphs.

Thus the story of the 'Gadarene' swine rests really on no more evidence than the story of the blind man at Bethsaida, i.e. upon the witness of the Second Gospel. And similarly the parable of the Seed growing secretly, related only by St. Mark, is really no worse attested than the parable of the Vineyard, which is given in all three Gospels. The only real double attestation is to be found in those few passages, mostly short striking Sayings, which appear to have found a place in the lost document as well as in St. Mark, e.g. Mk 3^{4 2-23 29 42-23 30-34 64 11 812 15 1011 1124 1230f. 22f. 1318f. 21. 22. 25}. To these we should probably add the parable of the Sower. But even here the double attestation is merely accidental, and some of the Sayings in the above list may very well have been spoken by Jesus on several occasions.

5. The historical worth of St. Mark's Gospel. —St. Mark's Gospel being our main source of information for the general course of the Ministry, it is important to determine its value as a historical document. It is obvious that what we have to rely on is internal evidence. If the picture presented in this Gospel be in essentials true, it will give an essentially reasonable account of the Ministry. But in this connexion 'reasonable' does not necessarily mean what is likely to happen at the present day. We must first become acquainted with the hopes and beliefs of the contemporaries of Jesus and His Apostles, before we are in a position to judge whether their reported sayings and doings fit into the history of the time.

It is only lately that the need of giving some demonstration of the general historical character of the picture of Jesus sketched in the Synoptic Gospels has begun to be recognized. Even now many professed theologians do not seem to realize how narrow is the channel by which the Gospel history has filtered down to us, or what the general rules are by which we may to a certain extent

discriminate between what belongs to the historical figure and what must rather be referred to the legendary clothing of it. A methodical discrimination is especially needed by the modern critical student of the Gospels. Such a man no longer receives them as history on the authority of the Church. Neither does he accept the narratives as they stand, for they are full of marvels which he thinks incredible. The Fourth Gospel, for various reasons, to be considered later, is put out of court as a narrative of fact. And literary criticism has shown that Matthew, Mark, and Luke, instead of attesting a general consensus of tradition, only go back, for the general framework of the narrative, to the single witness of Mark. What is there, we must ask, in the Gospel of Mark that compels us to regard the story there told as in any way historical?

P. W. Schmiedel, in his art. 'Gospels' in *EBI* (§§ 131, 139), answered this question by pointing out certain Sayings of Jesus which are at least superficially inconsistent with the beliefs about Him held by the Christians for whom the Gospels were written and by whom they were canonized. Schmiedel's method here is perfectly sound; the only question is whether some of his 'foundation-pillars' (as he calls them) are not rather insecure and whether others cannot be found more satisfactory to the historian.¹ We venture to suggest that sentences like Mk 9³⁰, mentioning the secret passage through Galilee (to be explained as a precaution against premature arrest by Antipas), and 11¹¹, which prosaically disconnects the Entry into Jerusalem from the Cleansing of the Temple, show even more clearly than any of Schmiedel's passages that in the Gospel of Mark we are dealing not only with a historical Personage but also with real reminiscences of His career.

More than this, however, is required. We want something more than a collection of fragments, even if they be genuine; we want to discover how far the Figure sketched in Mark may be taken for a historical portrait. Schmiedel's method shows us that Jesus was (as the Church also affirms) in some respects a man like ourselves. It is obvious, from the general course of history and the little space given by Josephus, that the public career of Jesus was not such as made a great impression upon unsympathetic contemporaries. If, then, the Gospel of Mark as a whole gives a historical view of this career, it will explain both the devotion of the few and the indifference of the many. If also this portrait of Jesus derives all its chief characteristics from the ideas and presuppositions of contemporary Palestinian Jewish life and thought, while the work itself belongs to the Greek-speaking Christianity of Europe, then we can hardly avoid regarding the portrait itself as in the main historical.

The great political event in Palestine during the first century of our era is that the Jewish nation dared to rise against the Roman dominion, and so was utterly crushed in A.D. 70. The Judaism which survived, and survives to this day, was able to do so only by organizing itself as a religious sect without direct political aims. To a philosophic or rationalistic observer the Jewish rebellion must have been from the first a hopeless enterprise. It is, therefore, certain that the ideas which swayed contemporary Palestinian Jewish life and thought were neither 'rational' nor 'philosophic,' as reason and philosophy were generally understood at the

¹ Schmiedel's 'pillars' are Mk 10^{17f.}, Mt 12^{31f.}, Mk 3^{21 1332 1534}; Mk 8¹², Mk 6^{5 814-21}, Mt 11⁵. Of these the second and fourth introduce technical terms of Jewish and Christian theology, and the last three are not convincing to those who on other grounds regard the Gospel history as mythical. The passages, indeed, seem to have been selected on theological rather than on strictly historical grounds: they would form, in fact, an admirable *catena* wherewith to confute the heresy of Apollinarius.

time. The Jews would never have gone to war, if they had not believed that the Kingdom of God would somehow be established for them; if the Gospel be historical, it should be dominated by the belief in the approaching Kingdom of God.

The special characteristic of the portrait of Jesus in Mark is His *secret* Messiahship. He comes before the world of Galileans and Jews in general as a herald of the approaching Kingdom of God, but He Himself is conscious that He will be the Christ or Messiah, i.e. God's anointed Vicegerent, when the Kingdom comes. This is avowed publicly for the first time when He is being tried before the high priest; the avowal at once seals His fate, and the title in a secularized form is placarded up above His cross. Previously to this, no one beyond the inner circle of disciples had taken Jesus to be, or as claiming to be, the Messiah. The Evangelist believed that the secret was known to the demons, but it was not known to men. If the Gospel of Mark is to be regarded as historical, then the idea of the secret Messiahship ought to be historical also.

To discuss this properly would need a separate article, and only the heads of the argument can be indicated here.¹ (1) The office of Messiah is essentially different from that of prophet or seer. Properly speaking, it cannot be 'claimed'; the Messiah, if he be Messiah, will be in some way evident King of Israel and Judge of the nations. Until Bar Cochba in A.D. 135, who lived in the full tide of Christianity, no Jew is known to have regarded himself as Messiah; when the crowds found out that Jesus, the Prophet of Galilee, had thought Himself to be Messiah, they lost interest and asked for Barabbas. (2) On the other hand, it is difficult to explain how the followers of Jesus ever came to think of Him as the Messiah, if He had not in some way so regarded Himself. The fact that Peter and others believed they had seen their Master alive again after the Crucifixion was no reason why they should draw the conclusion, for the first time, that He must have been the Messiah. It might very well have made them draw the conclusion that their Master was the Messiah *after all*, but that is a very different thing. It means that they, or some of them, had already regarded Him as Messiah, or, more accurately, as the destined Messiah. (3) But this exactly corresponds with Mk.'s presentation of Jesus as one who was to the people the Herald of the Kingdom of God, but to the inner circle of disciples the Christ—a secret they were expressly ordered not to divulge (8³⁰). This notion, though it is the only way in which the historian can really conceive the genesis of the doctrine of Jesus' Messiahship, was foreign to the thought of Gentile Christians, for whom the Lord Jesus was 'Christ' from the moment they first heard of Him. That it forms the leading feature of Mark's portrait is, therefore, a strong claim upon us to regard the portrait as historical, i.e. as derived from real reminiscence, and not from mythic fancy.

But this is all that can be claimed for the Gospel of Mark—that it gives us an impression of Jesus derived from one who had been with Him. As regards external events, the kind of information given varies in different parts. The scene in Gethsemane reads like the account of an eye-witness—possibly in this case the Evangelist himself (14^{51, 52}); hardly any one would say the same of the story of the Gerasene Demoniac (5¹⁻²⁰). Further, the first part (1^{1-8³⁰}) is little more than a string of anecdotes, loosely connected together, not always perhaps in relative chronological order. From 8^{27-10⁴²} the narrative is continuous, the only real break being at 10³². From 11¹ onwards the narra-

¹ See the present writer's *Earliest Sources*, pp. 58-76, and art. in *AJTA* xv. [1911] 180-193, esp. 183.

tive is divided into days, and we see very little reason to doubt the substantial accuracy of the reckoning, except that for some reason—possibly liturgical¹—the Last Supper is regarded as the Paschal Meal, against internal probability and all other strains of Christian tradition.

A feature of the Ministry which must rest on real reminiscence is the long period spent out of Galilee (6⁴⁵ 7^{24ff.} 8^{11, 22})—a period spent neither in controversy with Jews nor in evangelizing Gentiles, but in waiting in safe retirement till it was time to go up to Jerusalem for the Passover.²

A picture of Jesus as first having been the Herald of the Kingdom, and then choosing the time to go to Jerusalem in the full expectation of being killed there, and so being somehow an acceptable ransom to God (who will then be reconciled with His Elect and bring in His Kingdom), is more 'orthodox' than a view which regards Jesus as primarily an ethical teacher; but it is also more in accordance with what we know from elsewhere of Jewish contemporary ideas, and it explains better the enthusiasm and the devotion with which the inner circle of Jesus' disciples continued to regard Him. This is the view set forth in the Gospel of Mark; we may reasonably regard it as the historical view, and the Gospel as a document of historical value.

The Gospels of Matthew and Luke, taken by themselves, may also fairly be regarded as documents of historical value. If we derived our knowledge of the Gospel history from either of them alone, we should still possess in essentials a historical view of our Lord. But we find on investigation that this is the case, so far as the general outlines are concerned, only in proportion as Matthew or Luke has preserved the framework given by Mark. To this framework Mt. and Lk. have added many details, many of them no doubt genuine, drawn from Q and the other sources; but all these sources (including Q) are for us mere collections of fragments. Indeed, so far as any construction can still be traced in them, they seem inferior, and not superior, as historical documents, to Mark. Of course, if we really possessed Q, it might prove to be equal or superior to Mark; but we know Q only by the bits which Mt. and Lk. have selected for incorporation—often, it may be (especially in Mt.), out of their context and out of the order in which they were arranged in Q itself.³

6. The Fourth Gospel.—It will not be necessary here to investigate in detail the external evidence for the Fourth Gospel. The belief that it was written by the Apostle St. John was fully established as early as the decade A.D. 170-180, and clear indications of its use, especially among some of the Christian 'Gnostics,' can be traced back to a period some fifty years earlier. It is true that these indications are weak just where we might have expected them to be most precise.

¹ See B. W. Bacon, *Beginnings of Gospel Story*, p. 196.

² 'Ce que Marc raconte à ce sujet n'a guère pu être inventé' (Loisy, *Jésus et la tradition évangélique*, p. 45).

³ For instance, Albert Schweitzer lays great stress on Mt 10²³ ('Ye shall not have gone over the cities of Israel, till the Son of Man be come'). It is quite legitimate to argue that this remarkable saying must be genuine, and therefore, as it occurs in a Q-context, that it must have stood in Q. It is further arguable that it shows that Jesus at one time expected the public manifestation of the Messiah (possibly, therefore, not Himself) to take place during the first itinerant journeys of the 'apostles,' i.e. during the period indicated by Mk 6^{7ff.}. At the same time, when we remember that Q is for us a series of fragments, and that even in Mt 10 there is a section (vv. 17-22) taken from Mk 13, i.e. from sayings of the very latest period, it must remain equally, if not more, probable that Mt 10²³ belongs to the latest period, and that it refers to Jesus' own expected manifestation in glory after His Passion. What seems not quite legitimate is to assume that Mt 10 was spoken in historical sequence just before Mt 11 and before Mk 6³⁰ (Schweitzer, *Quest.*, 358-362)—because they occupy just this relative position in Matthew. Schweitzer (p. 360) actually quotes Mt 10²³ without warning his readers that this verse is Mk 13¹², torn out of its context.

Polycarp, according to tradition a disciple of St. John at Ephesus, does not quote at all from the Fourth Gospel, either in his Epistle or in the prayer which he is said to have offered at the stake; and the utmost that can be claimed is that certain phrases in a single passage in his Epistle are parallel to some leading phrases in 1 John.¹ This passage in Polycarp is certainly important as showing that Johannine watchwords, like 'antichrist' and 'confessing Jesus Christ to have come in the flesh,' were actually used by orthodox circles in Asia Minor. But it is remarkable that Polycarp should exhibit no further trace of the influence of the Johannine theology.

The external testimony to the traditional authorship of the Fourth Gospel is, in a word, indecisive. It is not absolutely unfavourable to the genuineness of the tradition, but it is quite insufficient to prove it. We may therefore go on to examine the internal evidence. And here the first question which must be asked is whether this Gospel is really a historical work. We have seen that St. Mark's Gospel has a very good claim to be so regarded: how does the Fourth Gospel compare with St. Mark?

The comparison of the Synoptic narrative with that of 'John' is an old and very simple study. The details are all familiar, and the problems do not depend upon the niceties of Hellenistic Greek or the various readings of MSS. It is a matter of historical discrepancy in two perfectly clear and definite accounts. The fact is that the narrative in 'Mark' and the narrative in 'John' cannot be made to agree, except on the supposition that one or the other is, as regards the objective facts, inaccurate and misleading.

To name the most striking single instance, it is impossible to insert the story of the raising of Lazarus into the historical framework preserved by St. Mark. It is not a question of the improbability or impossibility of the miracle, but of the time and place and the effect upon outsiders. And, if the narrative of the Passion in Mk. and of the events immediately leading up to it (Mk 9³⁰-12) be historical in its general outlines, as maintained in the previous section, then it is surely impossible to regard the story of the raising of Lazarus as in any way a narrative of facts.

The Crucifixion and Resurrection narratives in the Fourth Gospel do not differ essentially from the story as told in Mk. or Luke. There are many variations and discrepancies, but all four Gospels agree in the main facts, as may be realized by comparing them with the apocryphal *Acts of John*. But in other parts of the Gospel story the differences are acute. The Evangelist makes John the Baptist testify to the descent of the Spirit upon Jesus, but the central incident, the actual baptism of Jesus by John, he leaves out altogether (1²⁹⁻³⁴). He tells the story of the Last Supper without alluding to the words 'This is my body.' And yet it is not for want of sympathy with high Sacramental doctrine. In Jn 6, after the story of the Feeding of the Five Thousand, we read a long discourse of Jesus on this very subject. Jesus here says, 'I am the bread of life' (v. 35), and, 'Except ye eat the flesh of the Son of man, and drink his blood, ye have no life in you' (v. 53). It is true that a peculiar turn is given to these very strong expressions by the explanation made afterwards to the disciples that it is the spirit that gives life, and that it is the words of Jesus that are spirit and life (v. 63). But the Sacramental expressions are

¹ Polycarp, *ad Phl.* vii.: 'For whosoever doth not confess Jesus Christ to have come in the flesh is antichrist, and whosoever doth not confess the witness of the cross is of the devil, and whosoever perverteth the oracles of the Lord to his own desires and says there is neither resurrection nor judgment, he is the firstborn of Satan': cf. 1 Jn 4²⁻³.

not otherwise qualified. And, as regards Baptism the Evangelist tells us that the disciples of Jesus baptized their converts (4¹⁻²), and gives us the conversation with Nicodemus in which Jesus declares that except a man be born again he cannot see the Kingdom of God (3^{3a}). If we are to regard the Fourth Gospel as a narrative of events, we can only say that the Evangelist has given a false impression of what actually occurred.

It would be easy to go on to criticize the history and geography of the Fourth Gospel. As Matthew Arnold said, "'Bethany beyond Jordan" (1²⁸) is like "Willesden beyond Trent." But the most serious count against the work from the point of view of objective history is the attitude assigned to Jesus in His discussions with the 'Jews.' Taking the narratives as they stand, the sympathy of the non-Christian reader of the Synoptic Gospels naturally goes with Jesus against the Pharisees or the Sadducees. We feel that the adversaries of Jesus are narrow, unkind, unintelligent. To such an extent is this the case that protests have been raised by more than one distinguished and learned Jew, to the effect that the Synoptic Evangelists misrepresent the teachings of the Rabbinic religion. But in the Fourth Gospel it is quite different. Here the present writer cannot but think that the sympathy of the non-Christian reader must go with the Jews. To heal on the Sabbath was considered to be a breaking of the Sabbath. According to Mark (2²⁷), Jesus defends His action by saying that the Sabbath was made for man, not man for the Sabbath; but, according to John, He further exasperates the Jews by a disquisition about the Father and the Son, asserting to His adversaries that whosoever did not honour the Son (i.e. Himself) did not honour the Father (5²³). On a similar occasion, when accused of 'bearing witness of himself,' He is made to say that He has two witnesses in His favour, viz. Himself and the Father (8¹⁷⁻¹⁸). Can we wonder that the Jews replied, 'Where is thy Father?' It is quite inconceivable that the historical Jesus of the Synoptic Gospels could have argued and quibbled with opponents, as He is represented to have done in the Fourth Gospel. The only possible explanation is that the work is not history, but something else cast in a historical form.¹

From this point of view the question of the authorship of the Fourth Gospel is a matter of secondary importance. It is of the highest importance to ascertain the authorship and date of a chronicle, of a narrative of facts, because there the value of the work depends upon the nature of the traditions or sources to which the writer had access. But for a work of philosophy or philosophical history the qualifications required in the writer are mental, rather than local or temporal. We do not need to ask how near he stands to the events, but whether he sees them in their true proportions.²

For we have not done with the Fourth Gospel when we have made up our minds that neither the narrative nor the discourses are to be regarded as objective history, as matters of past fact. The question remains why the Church adopted this Gospel into the NT Canon, when so many rivals were excluded. In the answer to this question lies, we believe, the reason which gives a permanent value to the work. It was not the prestige of an Apostolic name that made it canonical, for the 'Gospel of Peter' was rejected. Great antiquity and respectful quotation by learned Church writers did not avail to include the 'Gospel ac

¹ See the admirable remarks of Loisy (*Jésus et la tradition évangélique*, p. 172) upon the difference between Lk 10² and Jn 4¹⁵⁻²⁰.

² See W. R. Inge's Essay on 'The Theology of the Fourth Gospel,' in *Cambridge Biblical Essays*, esp. p. 254.

ording to the Hebrews,' nor did philosophical thought avail the document commonly called the 'Oxyrhynchus Logia.' What was it that the 'Gospel according to St. John' had that these had not?

We believe the answer to be that the doctrine of the Person of Christ set forth in this Gospel expressed the general conviction of the Church adequately, while the Gospels which failed to become canonical failed mainly because the doctrine of the Person of Christ which they contained failed to satisfy the requirements of the Church. The Christ of the Fourth Gospel is not the Christ of history, but the Christ of Christian experience. Like St. Paul, the Fourth Evangelist did not care to know 'Christ after the flesh' (2 Co 5¹⁶), because he saw both his Lord and his Lord's adversaries *sub specie aeternitatis*.

It is because the Evangelist views the Gospel history from this subjective standpoint that he allows himself such freedom in remodelling the external events. 'The old disciple needs no documents. . . . The whole is present in his memory, shaped by years of reflection, illuminated by the experience of a lifetime. He knows the Christ far better now than he knew Him in Galilee or Jerusalem half a century before.'¹ The adversaries of Jesus have become his own doubts and unfaithful oppositions; the questioners of Jesus, such as 'Nicodemus' or 'the Woman of Samaria,' are his own questions, his own ignorances, which receive their solution at the hands of the Lord who has come with His Father to make an abode with him. He knows his Lord to be true, and the knowledge of Him to be Life eternal; and therefore all opposition, however specious, is unjustifiable and blind. The Son of God is a Lamp to him who beholds, a Mirror to him who perceives, a Door to him who knocks, a Way to the wayfarer. The true meaning of life could never have been revealed to man, if Jesus had not been sent as the Word from the Father. Who He was could only be seen after He had gone away; what He had been seen to be was nothing in comparison with the underlying reality. It was no mere man that the Evangelist was preaching, but God unchangeable, God invincible, God higher than all authority and all power, and elder and mightier than all angels and creatures that are spoken of, and than all ages. If those who heard would abide in this, and in this be builded up, they would possess their soul indestructible.² It is all a different order of thought from the Synoptic Gospels or objective history.

The substance of the last few sentences has been picked out of the work which above all other surviving fragments of early Christian literature has the closest similarity to the peculiar elements of the Fourth Gospel. This work is the apocryphal *Acts of John*, or rather, we should say, the doctrinal section of that unequal piece of writing. But near as the 'Gospel of John' and the 'Acts of John' are in many ways, their differences are also fundamental, and it is in great part because of these differences that the 'Acts of John' was condemned and forgotten, while the 'Gospel of John'

¹ J. A. Robinson, *The Study of the Gospels*, 1902, p. 148. It may be added that this way of envisaging the Evangelist is the best explanation of the inconsistencies and chasms that have been detected in the Fourth Gospel, notably by Wellhausen. [E.g. Jn 18 was intended originally to follow immediately after 14³¹, so 15-17 is a later addition.] No doubt the Gospel took many years to write, and the Evangelist may have inserted many additions and modifications from time to time. Every author knows how hard it is in such cases to avoid minor contradictions, and to cover up the sutures between new and old. Loisy (*Jésus et la trad. évangélique*, p. 25) pronounces much the same judgment on Wellhausen's always acute criticisms.

² See *Acta Ioannis*, ed. Bonnet, 1981ff. 17f. 20f. 202²⁸f. (or James, *Apocrypha Aneadota II.*, 1213-21 145f. 10f. 245f., from whom the English translation here given has been adapted).

survived to be the spiritual food of many generations.

For, although the Fourth Evangelist is no chronicler of events, although his Christ is the *Logos*, the Word of God, whom to know is eternal life, yet he firmly holds all the while that this Christ was manifested in time as a human being, a real man of flesh and blood, who really felt as we feel, and, above all, really suffered and really died, before He rose again from the dead. As we have seen, the Evangelist is careless of events; but to him the Death of Jesus on the Cross was not a mere event, but a something essential, a thing which really came to pass in the eternal order of things. The apocryphal 'Acts of John' sets forth the doctrine that the Crucifixion was a delusion—the Jews gather round the Cross and mock, but Christ is not really there; similarly also, the 'Gospel of Peter' tells us that Christ felt no pain, and apparently His Spirit is somehow caught up at the last. By a true instinct this specious teaching was rejected by the Church of the 2nd century. The Passion of Jesus Christ must be real, not a stage-play; and, if it was to be real, Jesus Christ must have been a real man.

In no early Christian document is the real humanity of Jesus so emphasized as in the Fourth Gospel. That Jesus was a real man is an obvious inference from the Synoptic narrative, but in the Fourth Gospel it is a dogma. It is the Fourth Gospel that tells us that Jesus was tired, and asked for water to drink (Jn 4^{6,7}); and that He wept at the tomb of Lazarus (11³⁵). If we ask what proof there is that Jesus really suffered, the answer is ready, that the Fourth Gospel declares Him to have said, 'I thirst' (19²⁸). Furthermore, we are told, with the most solemn protestations of accuracy to be found in the whole work, that the corpse of Jesus presented a truly human appearance (19^{34,35}).¹ It was no phantom.

This is the element which differentiates the Jesus of the Fourth Gospel from the Jesus of Gnostic speculation. It was the Fourth Gospel which pointed out the *via media* along which alone the Church could walk. On the one hand, the Church was not prepared to surrender historical reality to a philosophical speculation. The devotion of the first disciples had been kindled by Jesus of Nazareth. It was the belief that their dead Friend had become alive again, and that He had really appeared to them alive after death, which gave the earliest Christians the will and the power to combine on earth into a society, and afforded them enduring hope for the future. It was essential that the Living Christ whom they continued to serve and to wait for should have been a real man who had lived and died. Otherwise He was no firstfruits of the human race, but another species altogether. On the other hand, Christianity is essentially monotheistic, and it was so all the more consciously and passionately while the whole world outside was given over to the heathen cults and the deified Emperor. Whatever else Jesus Christ might be, the Church refused to make Him a demi-god. Here the various forms of speculation which we generally denominate 'Gnostic' were ready with terms and conceptions that should bridge the gulf. More than one school of thought, both Jewish and Greek, were teaching that the Word which proclaimed the truth to man was in the beginning with God and was Itself Divine, that it would come or had come to those

¹ According to 1 Jn 5⁶⁻⁸, the living personality has in it three elements, viz. spirit, water, blood. From the 'water' we are begotten, by the 'blood' we are sustained, and the 'spirit' or breath is the immaterial element that enters at birth and leaves at death. The spirit quitted Jesus when He died (Jn 19³⁰), leaving behind the water and blood of a human body, the existence of which was demonstrated to the onlookers by the spear-thrust of the soldier.

fitted to receive it. But the Fourth Evangelist alone makes this Word become an actual human being, one who really lived on earth and died under torture as other men would have died in similar circumstances. Whether this conception is really credible to us or not, it is a matter of history that it forms the central idea of the Fourth Evangelist's theology. We believe that it was by virtue of this central idea that the Fourth Gospel won its way to a position of permanent authority in the Christian Church.

Moreover, the doctrine of the Sacraments set forth in this Gospel is the doctrine of the Church. This has been so well expressed by Schweitzer in his *Gesch. der Paulin. Forschung* (1911, p. 159) that we need only quote his words :

'The naïve and unhistorical view that Jesus had instituted the Sacraments is not part of the Gnosis of the Johannine theology. According to this theology, He did not institute them, but He created them and prophesied them. . . . Through His incarnation came the possibility of the combination of human nature and spirit (*πνεῦμα*), the combination upon which the working of the Sacraments rests. By His actions with food and drink at the Feeding of the Five Thousand and by the words He used in connexion with those actions He indicated a Mystery which was to be manifested when the appropriate materials were ready : through Death, Resurrection, and Apotheosis He exalted His earthly nature, and set the Spirit free for the new method of operation, by virtue of which it was able to prepare men for resurrection. So Jesus came into the world to inaugurate the era of Effectual Sacraments. In virtue of this He is the Saviour. . . . The Johannine theology thus rests on the two dogmas : (1) that the Spirit can only act on men in conjunction with matter ; and (2) that, this being the case, it is only available on the ground of the Incarnation, and even then not until the glorification of the Lord had taken place. Whoever has once recognized these presuppositions will never attempt to search the Fourth Gospel for primitive elements which are to be explained from natural religions. But, on the other hand, it is clear that from this point of view Christianity exhibits itself as the most perfect Greek Mystery-religion that it is possible to conceive.'

7. The Gospel Canon.—The actual process by which our Four Gospels arrived at their present rank of pre-eminence is quite obscure. From about A.D. 170 onwards the Gospel Canon enjoys practically unchallenged supremacy, as we see from Tatian, from the Muratorian Canon, and from Irenæus. Somewhat earlier than Tatian must be placed an interpolated edition of the Four Gospels, which seems to have been set forth in Rome, and from which the greater 'Western Interpolations' in Greek and Latin Biblical MSS are ultimately derived. This brings us back to about A.D. 150 ; but the literary history of our Gospels during the first half of the 2nd cent. is unknown. Justin Martyr doubtless used all the Four in Rome about the middle of the century, and Marcion certainly used Luke about 130-140. Earlier still are the allusions which indicate a use of Matthew by Ignatius. But there is nothing to show that Marcion was acquainted with any other of the Canonical Gospels than Luke, and very little to show that Ignatius used any other Canonical Gospel than Matthew ; while the verbal inaccuracy of Justin's quotations suggests that even in his day the 'Memoirs of the Apostles' had hardly yet taken their place beside the Law and the Prophets as part of the written Word of God. At the same time Trypho, Justin's Jewish opponent, is quite aware that the way to become acquainted with Christian doctrine is to read what is written *ἐν τῷ λεγομένῳ εὐαγγελίῳ* (*Tryph.* § 10). Thus 'The Gospel' has already become the name of a book.

It is fairly certain that the formation of the Gospel Canon was a process rather of exclusion than of inclusion. Of the works of 'many who took in hand' to write of Jesus Christ (Lk 1¹), the Four Gospels alone remained in favour. The rest either failed altogether to attract, or were discovered to teach heresy. Whether the Church made the ideally best choice, from the point of view of the modern historical investigator, is a matter

that cannot be scientifically demonstrated, for the simple reason that the rivals of the canonical Four have not survived in full. But the abiding interest which each and all of the Four have excited during eighteen centuries is enough to show that the Church chose well. And it should not be forgotten that those of the non-canonical Gospels which we know enough of to pass judgment upon show a sensible inferiority. Marcion's Gospel is in every way inferior to Luke, and the Gospel of Peter is inferior to any of the Synoptic accounts of the Passion. It is, in fact, because the Canonical Gospels paint such an eternally fascinating Portrait that we welcome every scrap that may claim to give another view, however inadequate.

In one respect, we venture to think, the modern historical investigator is more fortunate than from general considerations he might have expected. It is fortunate indeed that the Gospel according to Mark should have been included in the official Canon. Many of the special ideas and tendencies of the First and Third Evangelists are in close touch with the ideas and tendencies of 2nd cent. literature. The theology of the Fourth Gospel met the wants of the Church ; it pointed out the way along which the conflicting currents of Christian thought and feeling might run together. In any case, the Fourth Gospel is unique. But it is difficult to understand what attraction was offered to Christians of the 2nd cent. by the Gospel of Mark which the Gospels according to Matthew and Luke did not offer, either singly or taken together, in a more eminent degree. Probably its traditional connexion with St. Peter may have had a determining share in recommending it, and the appeal of Irenæus to historical tradition against Gnostic theorizing may help us to understand how such an old-fashioned book as the Gospel of Mark, St. Peter's 'interpreter,' should have survived. It is, we find, very little quoted before it became part of the official fourfold Canon, that is, before the time of Irenæus, and it is certain that it ran a very serious risk of being forgotten altogether. As every one knows, the genuine text ends at Mk 16^b, in the middle of a sentence describing the terrified departure of the women from the empty tomb. There is no reason to doubt that the Gospel went on to describe some of the appearances of Jesus to the disciples after the Resurrection. The narrative is incomplete as it stands, and it is much more likely that the mutilation was accidental than that it was intentional. In the latter case, the break would never have been made where it is, at *ἐφοβοῦντο γὰρ* . . . ; even the sentence seems incomplete. But all our MSS ultimately go back to this mutilated text ; it is therefore evident that at one time no more than a single mutilated copy was in existence, or at least available. The work had dropped out of circulation, it had lost its public, and we can only guess at the reasons which led to its resuscitation.

The fact, however, remains. By its inclusion in the Canon we are to-day in possession of a document in warp and woof far more primitive than the Churches which adopted it. The fine instinct which reserved a place for the Gospel of Mark among the books of the NT shows the Catholic Church to have been wiser than her own writers, wiser than the heretics, wiser, finally, than most Biblical critics from St. Augustine to Ferdinand Christian Baur. It is only in the last half-century that scholars have come to recognize the pre-eminent historical value of that Gospel which once survived only in a single tattered copy.

8. Chronological summary. — From what has been said above, it will be evident that no very definite date can be assigned to any of the Gospels, except St. Luke's. The Destruction of Jerusalem

by Titus in A.D. 70 is an event that might have been expected to influence the language used in documents later than that date. Lk 21³⁰ does appear to allude to the siege. Mk 13¹⁴, of which Lk 21³⁰ is an adaptation, does *not* fit the historical details of the siege, nor indeed does anything in Mk. imply acquaintance with the Jewish War. We may therefore put Mk. before A.D. 70.

Mt. is difficult to date because of its dependence on Mark. Mt 27⁸ merely indicates the existence of a Christian community at Jerusalem, but Mt 17²⁴ might be held to imply the continued collection of the Temple-tax. Yet a Palestinian Gospel earlier than 70 would hardly have been based upon the Greek Gospel of Mark; Mt. was probably compiled when the Church of Jerusalem became a Greek-speaking community, i.e. in the generation that grew up after the war. Q is earlier than Mt.; it may have been compiled about the same time as Mk.

We may distinguish four periods of 30 or 40 years each, reckoning from the Crucifixion.

I. A.D. (80)-65. Oral Period. No written 'Gospel' appears during this period, nor any formal shaping of the Gospel history as a whole. St. Paul's accounts of the Lord's Supper (1 Co 11^{23ff.}) and of the Resurrection (15^{3ff.}) do not appear to have any literary connexion with what we read in our Gospels.

II. A.D. 65-110. Period of the writing of the Gospels.

Gospel of Mark, A.D. 65-70.

" " Luke (and Acts), A.D. 100.

" " Matthew, A.D. 80-100, in any case before A.D. 110.

" " John, A.D. 100-110.

III. A.D. 110-150. Period of the catholic reception of the Gospels.

IV. A.D. 150-190. Period of the canonization of the Gospels. By the end of this period the idea of the Fourfold Gospel (Iren. 192) is fully established.

9. The influence of the Gospels on the Church.

—The fact that the Church came to accept the Four Gospels is a proof that each of these works satisfied in a general way the Church's requirements. Had it been otherwise, the Gospel in question would never have attained to canonicity. At the same time, it would be absurd to regard the Church's requirements as being in any way occupied with details; these the Church has learned from what the Evangelists have supplied. The Church's picture of Jesus Christ is not unfairly summarized in the so-called Apostles' and Nicene Creeds; it is the written Gospels that have preserved for us the winning personality of the Son of Man.

The history of Christology was not a simple advance from an original unitarian 'psilanthropy' to the ultimate recognition of the Deity of Christ. Naturally it took many generations of Christian thought to evolve a form of words which should satisfactorily define the exceptional nature of the Founder of the new religion in terms of current philosophical conceptions. But from the first there existed the sentiment of devotion, the temper of mind which was assured that no title was too high to give, no homage too high to pay, to the Son of God, who had been sent from Heaven to overcome death and open the gates of everlasting life to those who believed on Him. For the first thirty years or so all Christians were converts; those who doubted how far the message was true did not become Christians at all. And, unless the extant literature gives a totally false impression of the general state of mind among Christians, the interest of the nascent Church was not in the least directed towards the past. In the words of the earliest written Christian document that we possess, the converts had 'turned unto God from idols to serve a living and true God, and to wait for his Son from heaven, whom he raised from the dead, even Jesus who delivereth us from the wrath to come' (1 Th 1^{9f.}). Those who had entered the Church by baptism were to set their mind on the things that are above, 'where Christ is, seated on the right hand of God' (Col 3¹). It was true

that the Christians, in consequence of their belief, submitted to new rules of conduct; and that these rules consisted in great part of reminiscences of the words of the Lord Jesus who had taught 'sweet reasonableness' and long-suffering (*επιεικείας και μακροθυμίας*), rules such as: 'Pity, that ye may be pitied; forgive, that ye may be forgiven.'¹ But the Gospel was not a formal code, still less a biography. No pictures of early Christianity have been conceived more fundamentally false, both to the spirit and to the letter of historical fact, than those which represent St. Matthew or St. Peter as delivering catechetical lectures on the 'Life of Christ.'

The actual course of events was very different from what the first generation of believers had anticipated. The End, so confidently awaited, was not yet. One by one the companions of the Ministry went to their graves, and, when the cataclysm of the Jewish War broke up for ever the one community in which there could have been common first-hand knowledge of how our Lord had lived and moved among men, the great majority of Christians were Greek-speaking inhabitants of the Levantine cities, a population far removed in spirit and in culture from the provincial Judaism of Galilee. What wonder that Christianity began to mix with alien elements and to appear in forms which alarmed the more conservative believers?

To the average Gentile Christian in the 1st cent., Christ was the *παῖς θεοῦ*, the messenger from God, who had come down to earth with tidings of immortality, and now was waiting till the appointed Day when He should appear in glory in the clouds of heaven. It is not surprising that to many a believer the melancholy story of Jesus the Nazarene was a stumbling-block, and that His sufferings were incredible. All the more was this the case among those who had attempted to find an appropriate place for Jesus Christ in the various philosophical theories of the Cosmos, which thoughtful men had devised and were devising. Christian sentiment and learned speculation alike welcomed what we call Docetic heresy. Docetism (*q.v.*) is not the name of a sect. It is a theory of the Person of Christ which takes many forms, and which has entered into the theology of many schools of thought. Some, like the writer of the *Acts of John*, denied that our Lord had any material existence; others were content to deny that He felt the pains of crucifixion; others, like Marcion, denied His birth; but all were alike in this, that they regarded Jesus as having been in no sense a real human being. It is a theory incredible, almost inconceivable, to us; but we have learned to know Jesus Christ through the written Gospels.

In the earlier sections of this article we have attempted to sketch what we conceive to be the literary origins of the several Gospels. What we wish to emphasize here is the private, individual character of the earlier documents. That St. Luke's Gospel was a private venture is sufficiently indicated by the Preface. That St. Mark's Gospel was so is sufficiently indicated by the narrow escape it ran of being lost altogether. The Gospel we call St. Matthew's has a more formal, official tone; and it bears marks of a Palestinian origin, i.e. it comes from the one region where we have a right to expect independent reminiscence. Yet in structure and much of its wording and material it is based on Mark—a clear proof that even in Palestine no regular effort had been made to hand down a summary of the outward events of the Ministry.²

¹ Clem. Rom. *ad Cor.* § 13.

² The lost 'Gospel according to the Hebrews' seems to have been very similar in general plan to our Matthew; in other words, it also had its ultimate basis in our Second Gospel.

To some pious Christians the biographical accounts of the life and words of the Lord may very likely have seemed unnecessary and unspiritual. But the rise of Docetic theories gave these 'Memoirs of the Apostles' a new and theological value. This is mirrored in the Ignatian Epistles. To Ignatius, writing in the middle of the first quarter of the 2nd cent., the Gospel history was immensely important, because it furnished the proof of the real humanity of Christ. If Christ was not really human, His sufferings were not real, or really akin to human suffering; and, if His sufferings were not real, why should Ignatius be willing to endure martyrdom? (*Trall.* § 10). But, to make the acquaintance of the human side of Jesus Christ, a biography was necessary.

Ignatius was 'fully persuaded as touching our Lord that He is truly of the race of David according to the flesh, but Son of God by the Divine will and power, truly born of a virgin and baptized by John that "all righteousness might be fulfilled" by Him, truly nailed up in the flesh for our sakes under Pontius Pilate and Herod the tetrarch,' and, further, that 'after His resurrection He both ate with them and drank with them [the Apostles] as one in the flesh, though spiritually He was united with the Father' (*Smyrn.* §§ 1, 3). Even this short summary of Christological doctrine goes beyond any known *Credo* in its literary dependence on a biographical Gospel, for the conception that Jesus was baptized by John, that all righteousness might be fulfilled by Him, is thoroughly characteristic of 'Matthew,' and, so far as we know, it is found in 'Matthew' alone of all the Gospels that ever were written. With this agrees the circumstance that Ignatius uses several phrases like *φύτελα πατρὸς*, 'the Father's planting,' which indicate the literary use of the Gospel according to Matthew. It seems likely also that he had read the Fourth Gospel, and it is almost certain that he once quotes from an 'apocryphal' work called the 'Preaching of Peter' (*Κήρυγμα Πέτρου*), a document which appears to have been a very early rival of the Canonical Acts of the Apostles. But we are not now concerned with the reconstruction of Ignatius' library; the important point is that this representative of the Catholic theology of the beginning of the 2nd cent. tends to base his doctrine of Christ on a Gospel which is biographical in form. This point of view was not at first accepted by all. 'If I find it not in the charter (*τὰ ἀρχεῖα*, the 'archives,' i.e. the OT), I believe it not in the Gospel,' said his opponents; and when he said, 'It is written,' they answered, 'That is the question' (*Smyrn.* § 8). But Ignatius had no doubt, and the Church was with him, that the Gospel record was necessary, as the guarantee of the real humanity of Jesus Christ.¹

The Church of Antioch, if we may judge from the Ignatian writings, took its knowledge of the Gospel history from our 'Matthew.' The Church in Pontus, a little later, if we may judge from Marcion, who left it in A.D. 138, used our 'Luke.' When and where our Four Gospels were gathered together into a Corpus, we do not know. Traces of it are first found in Rome, and, indeed, the conservative character of the early Roman Church makes it a little easier to understand how so ancient a document as the Gospel of Mark came to be included in the Canon. The process seems to have been very nearly complete in the time of Justin Martyr (*Apol.* i. 67; *Tryph.* 106), and it is certain that Justin's disciple Tatian constructed his *Harmony* out of the Canonical Four.

¹ One point deserves special notice in passing. Ignatius is the earliest witness to the belief that Jesus was born of a virgin. He is most emphatic in asserting this; but the importance of the doctrine for him is not that the miracle assures us that the man Jesus was Divine, but that the Christians' God was really born of woman (*Eph.* § 18).

Thus the Gospels fell into their place as the charter of the Christian religion, a fixed standard open to the inspection of friend and foe. And the earliest criticism on the Gospels from outside hits the mark from more than one point of view. 'I well know,' says Trypho, the Jewish opponent of Justin Martyr, 'that your Christian precepts out of what is called the *Gospel* are great and admirable, so admirable indeed that I doubt if any one can keep them—and I speak from personal knowledge of these writings. Moreover, we non-Christians specially wonder why you expect to get any favour from God when you set your hope on a man who was crucified' (*Tryph.* 10).

This simple and obvious piece of criticism touches the essential point. The real humanity of Jesus who was crucified in Judæa, and the soaring ethical principles that He taught, as it were by the way,—these are the obvious characteristics of the Gospels, and it is the Gospels which secure these things as an inalienable possession of the Christian Church. Moreover, Trypho's criticism is unanswerable, if the Gospels be regarded as mere law-books, as a code of morals. The Pentateuch is a law-book; it is possible to obey it to the letter, and those who compiled it intended it to be obeyed to the letter. But he who exchanges the Pentateuch for the Gospel does not exchange one code for another, as actually happens in the case of a Jew turning Muslim. He who reads the Gospel finds on the one hand that eternal life is promised for the observance of the Decalogue (Mk 10^{17, 19}), on the other that the renunciation of every earthly tie is demanded (Lk 14^{26, 27}), and that, unless the righteousness of the Christian exceeds the legal requirements, he cannot enter the Kingdom of Heaven (Mt 5²⁰). This discrepancy is not an affair of divergent 'sources' or of rival schools of Christian ethics; it is essentially characteristic. The Gospel is not intended to introduce us to a code by which all men should regulate their conduct; it is intended to introduce us to Jesus Christ, whose commands differ for each age and for each individual because He dealt with principles and not with rules. The love of God and the love of our neighbour were the ethical principles of Jesus; but to turn His sayings into a fixed code of rules would produce a course of life harmful to our neighbour and displeasing to God. We do not get rid of the real difficulties of the Gospel, if we make jettison of all the miracles but leave the Sermon on the Mount.

The Gospel ethics needs criticism more, not less, than the Gospel miracles; and for this reason, that it is more for the ethics than the miracles that the Gospels are permanently valuable. We need to put the Gospel morality into its due relation to time and place; if Christ said, 'Give to every one that asketh thee,' and, 'Unto him that smiteth thee on the one cheek, offer also the other' (Mt 5^{40, 42}, Lk 6²⁹), we need to understand the social conditions of Christ's day, and those of our own also, before we can turn these maxims into a rational command for fellow-believers. It has ever been a mark of true Christianity to seek to apply the words of the Gospel to the changing needs of the time—a task which is none the less incumbent upon the Church because it is always difficult.

But the Gospel morality is not the Gospel, any more than the *Didache* is the Gospel. Christianity stands or falls, lives or dies, with the personality of Jesus Christ; and the Gospel is our introduction to Jesus Christ. From the Gospel according to Mark we may learn who Jesus Christ was and what part He played on earth in human history. From the Gospels according to Luke and Matthew we may learn something of what Jesus Christ taught. From the Gospel according to John we

may learn what His followers declare to be the real significance of His life. It is the great charm of Christianity that its innermost doctrine is incarnate in the person of its Founder, rather than crystallized into a set of propositions or ordinances. The propositions and the ordinances may be necessary deductions; one of them, as we have seen, forms the ground idea of the Fourth Gospel. But they are exhibited in action; like the Laws of Nature themselves, the Doctrines of Christianity are human deductions from the course of events.

See also art. BIBLE, vol. ii. p. 574.

LITERATURE.—I. *THE LITERARY PRIORITY OF MARK*.—C. Lachmann in *SK*, 1835, p. 570 ff.; W. G. Rushbrooke, *Synopticon*, Lond. 1880; J. C. Hawkins, *Horæ Synopticae*², Oxf. 1909.

II. *ON THE RECONSTRUCTION OF Q*.—A. Harnack, *Sprüche und Reden Jesu*, Leipz. 1907 (Eng. tr., *The Sayings of Jesus*, Lond. and N.Y. 1908); V. H. Stanton, *The Gospels as Historical Documents*, pt. ii., Camb. 1909; B. H. Streeter, *Essays iv. and vi. in Studies in the Synoptic Problem*, Oxf. 1911; F. C. Burkitt, *The Earliest Sources for the Life of Jesus*, Lond. 1910, pp. 87-46.

III. *ON THE FOURTH GOSPEL*.—The best defence of a genuine element in the sayings of the Fourth Gospel still appears to the present writer to be that in Matthew Arnold, *God and the Bible*, chs. v. and vi., popular ed., Lond. 1884. For the modern view, see B. W. Bacon, *The Fourth Gospel in Research and Debate*, New York, 1910. For the theology, see W. R. Inge, in *Cambridge Biblical Essays*, Lond. 1909, pp. 251-288. On the literary unity of the Gospel, see J. Wellhausen, *Erweiterungen und Änderungen im vierten Evangelium*, Berl. 1907, and *Das Ev. Johannis*, do. 1908.

IV. *GENERAL MEANING AND HISTORICITY OF THE SYNOPTIC GOSPELS*.—Albert Schweitzer, *Von Reimarus zu Wrede*, Tüb. 1906 (Eng. tr. [by W. Montgomery], *The Quest of the Historical Jesus*, Lond. 1910), is, apart from Schweitzer's own very interesting views, the most instructive introduction to the general trend of Gospel criticism during the 19th century. See also A. Loisy, *Jésus et la tradition évangélique*, Paris, 1910 (an admirable short survey of the whole question from the 'eschatological' point of view); J. Wellhausen, *Einleit. in die drei ersten Evangelien*², Berl. 1911, *Das Evangelium Marci*², 1909, *Matthæi*, 1904, *Lucæ*, 1904 (four books forming one short Commentary on the Synoptic Gospels, with Introd. prefixed—'liberal' and stimulating); W. Wrede, *Das Messiasgeheimnis in den Evangelien*, Gött. 1901 (the book with which Schweitzer's survey closes, but well worth study for its own sake—anti-eschatological and historically sceptical of the outline given in Mk.); A. Drews, *The Christ Myth*, Eng. tr. by C. D. Burns, Lond. 1910 (the most noteworthy expression of historical disbelief in the historicity of Jesus, compelling the future investigator to examine the reasons for treating any part of the Gospels as actual history); B. W. Bacon, *The Beginnings of Gospel Story*, Yale, 1909 (a Commentary on Mk., the most scientific exposition in English of the anti-eschatological point of view); F. C. Burkitt, *Earliest Sources*, etc. (eschatological), also *The Gospel History and its Transmission*², Edinb. 1911 (this book, as first published in 1906, was an expansion of the first draft of the present article).

F. C. BURKITT.

GOSPELS (Apocryphal).—I. **Importance.**—The most important problem to the student of religion is the character and teaching of the Founder of Christianity. Since He wrote nothing, we can discover this only by reading what others, near to the events, wrote about Him. It was natural that many of His followers should 'take in hand to draw up accounts of their Lord'; on the face of it, it is improbable that the four Gospels 'received' by the Church contain the whole authentic tradition on the subject. Moreover, St. Luke in his preface (Luke 1¹⁻⁴) expressly declares that his work is based on many earlier writings, and implies the existence of others which he has not scrupled to pass by. Such fragments as remain to us, purporting to give an account of these events, claim to be judged on their own merits, without fear or favour derived from the decisions of Church Fathers in succeeding centuries, and the whole story can be rightly understood only when a searching study of these remains has taken place. See preceding article.

2. **Name.**—The name 'Apocryphal,' originally a title of honour given to writings for a select circle, 'hidden' from the multitude, is used in analogy with the OT Apocryphal books to describe these remains. It was only by degrees that it became a term of reproach, as implying exclusion from that public reading in churches which was reserved for the canonical books ('quidquid est extra hos, inter 'Αποκρύφα esse ponendum' [Jerome, *Prolog.*

Galeatus, end of 4th cent., after giving a list of the canon]). Down to the end of the 2nd cent. the process was not complete, for Serapion (A.D. 190) found the 'Gospel of Peter' (see below) used in public reading in the church at Rhossus near Antioch (Euseb. *HE* vi. xii. 2); and in 412-450, Bishop Rabbula of Edessa discovered more than two hundred copies of Tatian's *Diatessaron* taking the place of the Four Gospels in the churches of his diocese. But, once the exclusion was confirmed, it began to act more and more disastrously upon these books, and the name 'Apocryphal' came to possess a more and more ominous significance.

3. **Difficulty.**—The study of these pieces is still in its infancy, for fresh discoveries are continually being made which alter the whole horizon; e.g. the *Logia*, discovered in 1897 and 1903, and fragments of the 'Gospel of Peter,' unearthed in 1886, have overturned some old theories, while the translation of the Italian 'Gospel of Barnabas' (1907) has illuminated a forgotten corner of Church History. It is thus as hard to lay down conclusions as to write a history of the politics of the current year, for the scenery is always changing. Moreover, the evidence at present, both external and internal, is very fragmentary and must be used with caution. Though we know by name nearly fifty of these 'Apocryphal' Gospels, not one-tenth of their contents is extant.

4. **The evidence.**—The external evidence consists of statements of Church Fathers, and cannot rightly be regarded as impartial. To know its worth we must examine it in the light of the knowledge we possess concerning the special characteristics of the witnesses who give it. For instance, no one can read the works of Clement of Alexandria without perceiving at once his credulity and curiosity, his versatility and liberality. Unlike his contemporaries, he showed an almost modern striving after tolerance. In his search for truth he found it in most unlikely places. Nothing came amiss to his craving for knowledge and sunny optimistic outlook. Where Christ was not before, Clement's tender imagination translated Him. Papias' credulity was of a more naive and crude sort. It is strange to find those who would base their whole case for the existence of a Hebrew original of the First Gospel on one of his tales, rejecting, with hardly an apology, others like the prophecy which he ascribed to Christ (Iren. *adv. Hær.* v. xxxiii.), or the account of the martyrdom of 'James and John' (quoted by Georgios Hamartolos [see Moffatt, *Introd. to Lit. of NT*, 1911, p. 603 f.]). Jerome, inquisitive and inquiring as he was by nature, was ready to go to any length to avoid the suspicion of heresy, and to this he sacrificed his own reputation by his attack on Origen's memory. Origen's daring criticism and profound love of truth for its own sake are tempered, as a rule, with a scrupulous caution and desire to avoid offending 'weaker brethren,' or marring the splendid unity of the Church he lived to serve. Eusebius is the safest guide; but even he was writing from a later standpoint, and for a public to whom the canon of the Gospels was soon to be a sacred and established fact. If men object to the bias of 20th cent. critics, it is surely needful to remember that prejudice is not only of to-day, but played a large part in the estimates of the early Fathers and Councils of the Church, and nowhere more than in the subject under discussion. Some of the chief witnesses cited were plainly speaking from hearsay, and had no personal acquaintance with the facts related; e.g., there is no evidence that Irenæus of Lyons knew anything at first hand of Syrian Christianity; and all scholars admit that Epiphanius' zeal and curiosity were surpassed by his credulity and bigotry. (Epiph. *Hær.* xlv. 1

actually confuses Tatian's Syriac *Diatessaron* with the Hebrew Matthew; yet many would rely on his authority to discuss the nature of the latter Gospel.) To find the origin, date, and value of the Apocryphal Gospels, we are thrown back upon the internal evidence afforded by the extant fragments; and our estimate of this must depend largely on our view of the history in question, though we are able to correct our results by a critical view of the external evidence.

5. Value.—Even if it were proved that the Apocryphal Gospels have little claim to originality or antiquity, they would possess great negative value, as reflecting the excellence of the selection of which the NT is the result. They must also throw much light on the earliest notions of Christians, on the earliest history of the Church and Canon, and, most of all, on the intricate problems connected with the date and origin of the 'received' Gospels. Their contents are too fragmentary and their value too disputed to solve such problems; often they rather 'complicate them further' (Harnack, in *TU* ix. 2) by suggesting new possibilities and upsetting old conclusions.

6. Origin.—The Apocryphal Gospels embrace all writings claiming to describe the words and acts of Christ outside the canonical Four; they are a very mixed collection, and owe their existence to very various motives. Some writings, e.g. 'The Preaching of Peter' (see below), though containing words put into Christ's mouth, are hardly to be ranked as 'Gospels'; others, e.g. Tatian's *Diatessaron*, or Marcion's revised and abbreviated version of St. Luke, are hardly to be called 'Apocryphal.'

7. Classification.—The rest are divided for convenience into four classes: (A) Parallel Gospels, (B) Transition Gospels, (C) Supplementary Gospels, and (D) Lost and Hostile Gospels. But, in any classification, a cross division is inevitable; and, strictly speaking, no exact lines can be drawn between the four classes. The class D (see below) has always been the most numerous; and the tendency, ever since the canon was fixed and the living fount of tradition dried up, has been to assign all unauthorized writings to this class. Origen's 'Quattuor Evangelia habet ecclesia, haereses plurima' (in *Luc.* i. 1) has been the rough and ready verdict of many since his time; but, while tradition was fluid and Scripture meant 'the Law and the Prophets' (as in *Clem. Alex. Strom.* vi. xii. 58, from 'Preaching of Peter'), and while codices were still unknown (before A.D. 250)—since only separate rolls were used—many pieces were not reckoned 'Apocryphal' which subsequently were condemned. This came about the more readily at a time when 'heresy' had become a moral and spiritual menace to the existence of the Church, and walls had to be built to keep out the wolves in sheep's clothing who devoured the flock. Even when it became a definite practice to manufacture 'Gospels' in defence of particular tenets, the first essays were rather partial harmonies of earlier sources, written and oral, and quite unlike the barefaced forgeries of later days. Such are those belonging to class B. Class A, the earliest and most important, is parallel in time and object with our canonical Gospels, and akin to these we reckon the fragmentary sayings probably belonging to an authentic tradition, whether oral or written, and possibly the first stones on which some later Gospels, e.g. 'of the Egyptians' or 'of Thomas,' were built. Class C illustrates the difficulty of any division, for the Gospels belonging to it contain pieces of hostile Gnostic productions as extravagant as any in class D. This group is by far the best known, and, for a study of early Christianity, the least important. Between classes D and A the gap is far wider than between B and the earliest canonical sayings.

8. Contents.—(A) PARALLEL GOSPELS.—(a) Gospel according to the Hebrews=καθ' Ἑβραίων=Ἑβραϊκὸν=Ἰουδαϊκὸν (Cod. Tisch.) (Euseb. III. xxv. 3, 5, xxvii. 4, xxxix. 6, IV. xxii. 8, *Theoph.* in *Matt.* xxv. 14, and *Syriac Theophania* [IV. xiii. 234, ed. Lee, London, 1842]; Origen, in *Joh.* ii. 6, in *Matt.* xv. 14, in *Jer.* xv. 4; *Clem. Strom.* II. ix. 86 [PG viii. 982]=Jerome's 'Gospel of the Nazareans,' called by many the 'Authentic Matthew' [*authenticum Matthæi*, Jerome, *ad Matt.* xii. 17]; cited by Jerome, *de Vir. Illustr.* ii., iii. [A.D. 392], in *Isai.* xi. 1, xviii. 1, xl. 9, in *Ezech.* xviii. 7, in *Matt.* xii. 13, xxvii. 16, also *adv. Pelag.* iii. 2 [A.D. 413], and some ten other citations; perhaps also Ignatius, *Smyrn.* iii. 2).—It is ascribed by Jerome to orthodox Jewish Christians (Ναζαραιῶν = *Nazaræi*). It is said to have been written in Aramaic words and Hebrew letters (Hegesippus [A.D. 160], in Euseb. *HE* IV. xxii. 8; Euseb. *Theoph.* in *Matt.* xxv. 14; Jerome, *adv. Pelag.* iii. 1) and to have quoted the OT from the Hebrew text (Jerome, *de Vir. Illustr.* iii.). Probably a Greek translation was known to Origen and Eusebius, whence came its present name. Perhaps the original was anonymous, like so many of the Hebrew sacred writings (e.g. the Epistle to the 'Hebrews' in NT). Such a translation was probably confined to a few, and had disappeared in Jerome's time. He translated it himself from a copy at Beroëa, and he knew of another at Cæsarea, which 'Pamphilus had studied'—perhaps the same that was seen by Origen. Eusebius (III. xxv. 5) places it among the 'disputed' books. Like Origen, he implies that many reckon it 'canonical,' while Jewish Christians make use of this Gospel and 'take small account of the others.' The first saying in the Oxyrhynchus Papyrus, published by Grenfell and Hunt in 1903, contains a longer version of a saying (ὁ θαυμάσας βασιλεύσει, καὶ ὁ βασιλεύσας ἀναπαύσεται) derived by Clement (*Strom.* II. ix. [xlv. 4, ed. Stählin, Leipzig, 1906]) from this Gospel. Of some thirty fragments extant, Nicholson regards ten as independent of the canonical Gospels. Handmann thinks that twelve are nearest to St. Luke, eleven to St. Matthew, and six to St. Mark. This is against the view advocated by many since Lessing (1784)—the first to realize the importance of the Gospel of the Hebrews—who find here the original 'Hebrew Matthew' mentioned by Papias in A.D. 110 (Euseb. *HE* III. xxxix. 16) and the primal source of all the other Synoptic Gospels. The Gospel of the Hebrews has been described as a 'phantom ship' or a 'haunting shadow' ever dogging the footsteps of this primal Gospel, but it is not unlikely that the reverse is really the case, and that the 'Hebrew Matthew,' which is never quoted save as a name, is merely the orthodox reflexion of a confused report of the Gospel of the Hebrews, which was all that reached the ears of Western Christendom, through the agency of Papias in Phrygia, and his disciple Irenæus, Bishop of Lyons (cf. *Iren. adv. Hær.* i. 26 and Euseb. *HE* III. xxxix.). Hegesippus, Eusebius, Origen, and Jerome had all been in Palestine and had seen the Gospel according to the Hebrews, but none of them, even in their commentaries on St. Matthew, give any indication of knowing more than the name of the original 'Hebrew Matthew.' Jerome, who at first (A.D. 392) tried to identify the two, grew more sceptical as he proceeded, though the attacks of his enemies, who accused him of trying to bring in a fifth Gospel by translating the Gospel of the Hebrews, made him so cautious and ambiguous in his language that it is easy to mistake his meaning. Epiphanius (*Hær.* xxix. 9, xxx. 3), who regards the Ebionite Gospel as a forged and 'very full' (πληρέστατον) version of 'Hebrew Matthew,' had never seen either, and confused both with the Greek

'Gospel of the XII. Apostles.' Gospel criticism to-day leans steadily to a disbelief in a Hebrew Gospel underlying our St. Matthew, though admitting that one of the sources employed may have been a Greek collection of discourses (from the Aramaic) with narrative links. It is probable, then, that neither Hilgenfeld, who calls it the 'punctum Archimedis' of the whole Synoptic problem, taking the place usurped by St. Mark, nor Resch, who regards it as a 'tertiary' production several times removed from its original (the *Logia* of St. Matthew in Hebrew), is right.

Internal and external evidence alike point strongly to the view that the Gospel of the Hebrews is an independent parallel version of the events described in the Synoptics (esp. in St. Matthew), and possibly formed one of the sources in the hands of St. Luke. The style is lifelike, Jewish, and primitive. Sometimes the *naïveté* borders on the grotesque and draws near to the methods of current Jewish Apocalyptic, as in the famous saying ascribed to Christ, 'My Mother the Holy Spirit took me by one of my hairs to the great Mount Tabor' (Jerome, *de Vir. Illustr.* ii.; Origen, in *Joh.* ii. 6; cf. Bel and the Dragon²⁶), which is perhaps the foundation for the later unlikely story that Mt. Tabor was the scene of the Transfiguration. The words ascribed to Christ at His baptism, 'What have I sinned unless this be ignorance?' (Jerome, *adv. Pelag.* iii. 2; cf. *Jn* 8⁴⁶), are certainly very ancient. The context of the tale of the rich young man and the reference to Peter as 'Simon his disciple sitting near him' (Origen, in *Matt.* xv. 14) have all the marks of genuineness, and many of the sayings peculiar to this Gospel bear the proof of their origin on their face—*e.g.* 'Never be happy save when ye behold your brother in love' (Jerome, in *Eph.* v. 4). Even where the author seems to correct the tradition preserved in the canonical Gospels, it is often a moot point whether his version is not to be preferred; *e.g.*, in the Lord's Prayer, instead of Matthew's and Luke's obscure reading *ἐπιούσιον*, the Gospel of the Hebrews has *ἄρτος* = 'to-morrow's bread'; instead of the Parable of the Pounds, it has another parable in which the third servant does not bury his pound, but squanders it in riotous living, and is the only one punished by more than the loss of the share entrusted to him (Euseb. *Theoph. in Matt.* xxv. 14). Of the two Resurrection 'appearances,' that to Peter and his friends (Origen, *de Princ.*, Præf. viii.; quoted also in Ignatius, *Smyrn.* iii. 2, and 'Preaching of Peter' [see below]) is probably an older version (see Resch, *Agrapha*, 412-416) of that recorded in *Lk* 24³⁶. The other (Jerome, *de Vir. Illustr.* ii.), to 'James the Just,' treated as the first, contains a number of legendary details (*e.g.* giving the shroud to the priest's servant), and is probably secondary; but, in Harnack's view, its date must be before A.D. 100. This is the more probable since the title 'Son of Man' (used by Christ of Himself) appears here alone outside the NT. When Eusebius (*HE* III. xxxix. 17) says that the story of a woman taken in sin mentioned by Papias comes from the Gospel of the Hebrews, this does not prove that Papias knew that Gospel or took it from there.

The Gospel of the Hebrews contained, according to the Catalogue of Nicephorus (A.D. 599), 2200 *stichoi*, and was thus longer than Mk., but shorter than Mt.; but Zahn thinks it may have been written in a smaller hand. It dates undoubtedly from the 1st cent. and was known in Egypt, probably in a Greek translation, very early in the 2nd cent. (it is possible that Pantænus saw it in India [= Ethiopia] in A.D. 180 [Euseb. *HE* v. x. 3]). It is thus a late contemporary of Mk., and earlier than our Mt., although its author was neither so

critical nor so orderly in his use of the traditional material.

(b) *Gospel of Peter* (Origen, in *Matt.* x. 17; Euseb. *HE* III. xxv. 6, VI. xii. 2; Jerome, *de Vir. Illustr.* ii.; Theodoret, *Hær. Fab.* ii. 2; *Decret. Gelasii*).—For the story of Serapion's discovery of this Gospel, see § 2. Previous to 1893 our only knowledge of this work was derived from this story, and from a statement of Origen, who remarked that the Gospel of Peter, like the 'Book of James' (see 'Protevangelium' below), contained the information that the 'brethren of Jesus' were sons of Joseph by a former wife. Eusebius further informs us that it was generally condemned as the Apocryphal work of heretics, along with the Gospels of Thomas and Matthias. In 1886, Bouriant discovered a number of precious fragments (8th cent. MSS) in a monk's tomb at Akhmim (the ancient Panopolis), Upper Egypt; among these was a large torn piece of the Gospel of Peter, giving a continuous account of the Passion, Crucifixion, and Resurrection, but beginning and ending abruptly in the middle of a sentence. On the publication of this piece in 1893, a wholly new light was thrown on this mysterious Gospel and on the history of the literature of which it formed a part. The most remarkable feature is the strong anti-Jewish bias (which induces the author to make Herod 'judge' in place of Pilate). The strong Johannine flavour, and the absolutely unique version of the Resurrection appearances, present a startling contrast to all other accounts.

In these respects, as in many others, it closely resembles the narrative in the Gospel used by the author of the Syriac *Didascalia* (A.D. 215-260), with which Harnack identifies and Resch compares it. Though entirely parallel with the Synoptic accounts of the Passion, it contains no fewer than 29 additions to the Markan narrative (some of these are early attested in MSS of Mk.), and both in its verbal and in its historical variations it is largely (Harnack gives eight examples) influenced by the corrections found in the Fourth Gospel; *e.g.* the date of the Crucifixion is Nisan 14, as in *Jn* 19^{14, 31}. After Mk 16⁸ the author forsakes the Synoptic account altogether, and presents a version of the Resurrection which cannot be paralleled from any of our Gospels, though it has more in common with the scenery of the Fourth Gospel than with Mt. or Luke. The fragment ends with a story of an appearance to 'Peter, Andrew, and Levi, son of Alphæus,' who have gone fishing on the Sea of Tiberias; but this and all other appearances of the risen Christ are supposed to take place on one day, and that a week after Easter (Nisan 21), when all the disciples have gone to their own homes, disbelieving the news of an empty tomb, brought by Mary Magdalene and the other women. Save in the description of the first opening of the tomb in the 'garden of Joseph' and the preaching of Christ to the 'spirits in prison' (cf. 1 P 3^{19f.}) which is implied in a question addressed to 'the Cross,' which follows the risen Lord from the tomb, there is little fantastic or legendary matter in this work. The heretical, Docetic element, too, is in the background, though it appears in the remark concerning Christ's being 'silent, as having no pain,' and in the significant change in the only sentence ascribed to the crucified: 'Power, my Power, why hast thou forsaken me?' (but cf. 'at the right hand of power,' Mk 14⁶²). It contains the germ, but not the fruit, of the later Docetic heresy, as seen at the full in the Qur'an and the 'Gospel of Barnabas.' This is just what we should expect from Serapion's account of it.

Harnack seeks to prove, not only that the *Didascalia* uses this Gospel as the principal au-

thority and derives all its citations from its contents, but also that the story of the sinful woman in *Apost. Const.* ii. 14 (a work based on the *Didascalia*), now included in Jn 7⁶³-8¹¹, but found only in late MSS, and entirely unlike the style of the Fourth Gospel, is really taken from the Gospel of Peter—whence Papias, who had not seen the Gospel according to the Hebrews, where Eusebius found it, also borrowed it. The undoubted mixture of Johannine and Synoptic elements, which forms so marked a feature in the Gospel of Peter, the peculiar style of this fragment, and the Syrian origin both of the Gospel of Peter and of the *Didascalia*, undoubtedly lend a very strong testimony to the truth of this brilliant conjecture, especially if we accept Harnack's dictum that D gives us by far the best text of the Johannine passage, and that the glosses in D—e.g. to Lk 6⁴ (the story of a man working on the Sabbath)—are taken direct from our Gospel of Peter, hence their anti-Jewish tone. Certainly the style of Jn 7⁶³-8¹¹ is far more closely akin to that of the Gospel of Peter than to any other extant writing.

Whether this be so or not, the most interesting fact about the Gospel of Peter, as about the 'Logia of Jesus,' is undoubtedly the proof it gives that the so-called peculiar language and attitude of the Fourth Gospel were not so peculiar as is commonly believed. The author of the Gospel of Peter, writing in Syria during the first decade of the 2nd cent. (*ἡ κυριακή* = 'the Lord's day' twice in the Gospel of Peter [cf. Rev 1¹⁰] forbids a 1st cent. date), did not scruple to correct all four Gospels, and, while making no use of the Gospel according to the Hebrews, is constantly found employing terms far more akin to the Fourth Gospel than to any of the others, though he treats Mark always as his principal authority. He wrote, therefore, when the Gospel tradition was still fluid and the Canon by no means fixed, but already the special attitude and tone associated with our Fourth Gospel were well known and popular among his hearers. When Harnack supposes that Justin used the Gospel of Peter under the name 'Memoirs of Peter,' he is stating a view which cannot, in the present state of our knowledge, be disproved.

Two other writings ascribed to Peter must be carefully distinguished from this 'Gospel.' Neither is strictly a Gospel at all, though the first did place words in the mouth of the Master Himself. This is the 'Preaching of Peter,' quoted by Clement (*Strom.* i. xxix., ii. xv., vi. v. vi. viii.) and Origen (*de Princ. Præf.* viii., and in *Joh.* xiii. 17, as cited by the Gnostic Heracleon), and condemned by Eusebius (iii. iii. 2 and xxv. 6) and Nicephorus (*HE* ii. 46). Other quotations, as in Greg. Naz., *Orat.* i., are uncertain. This was the work of a cultured Gentile Christian of Alexandria, who wrote before Justin or Aristides composed their Apologies (A.D. 140-150). The attitude towards miracles is Alexandrian; that towards the Jews and the Scriptures, which include no NT, is akin to the *Ep. of Barnabas*; that towards 'faith' is Johannine, not Pauline. The book is thus a near contemporary of the Gospel of Peter, but it has no direct connexion with it. Here, as in the Gospel of Peter, the Apostle is made to speak in his own person. Von Dobschütz thinks it was written for mission preaching, as a supplement to Mark's Gospel, by one who did not know Mk 16⁸-end, and saw the need of completing it by carrying on the Memoirs of Peter, which Mark had been privileged to transcribe.

The *Judicium Petri* or *Duo Viæ* (described by Rufinus, *Symbol. Apost.* i. 36-38, and identified by Hilgenfeld with the ecclesiastical 'Canons of the Apostles' [3rd cent.] and by Harnack with the *Didache* [2nd cent.]) cannot be described from the

existing evidence, but it has no claim to be called a 'Gospel.'

(c) *The Sayings and Words of Jesus* (*Λόγια Ἰησοῦ* of Oxyrhynchus [1897]; *Λόγοι Ἰησοῦ* of Oxyrhynchus [1903]); *The New Fragment of a Gospel* (1903); and *The Fayum Gospel Fragment* (1885).—The first three were discovered and published by Grenfell and Hunt, from torn fragments of papyrus in the rubbish-heaps outside the city of Oxyrhynchus; the last from a MS in Archduke Rainer's collection at Vienna, first discovered and translated by Bickell (*ZKTh*, 1885).

The first has eight sayings, called by the discoverers 'Logia.' They have, on the whole, a mystic, ascetic tone, especially the famous 5th saying: 'Lift the stone, and there thou shalt find me—cleave the wood, and there am I.' Logion 3 has a very Johannine sound: 'I stood in the midst of the world, and in the flesh was seen of men. . . . ' Harnack ascribed these sayings to the Gospel of the Egyptians. Taylor, perhaps more plausibly, suggests a connexion with the Gospel of Thomas in its original Gnostic form; which is the more probable, since the new Fragment of 42 broken lines, found in 1903, has an introduction, describing its contents as 'The (Marvellous) Words (*Λόγοι*) which the Living Lord spake to . . . and to Thomas.'

The problem is further complicated by the fact that the first of these 'Words' (1903) appears to come direct from the Gospel according to the Hebrews; and a fragment of a Gospel found near by contains a passage, 'When wilt thou manifest thyself to us?' (cf. Jn 14¹⁹), followed by the answer, 'When ye shall be stripped and not be ashamed'—an idea dependent on Gn 2²¹⁻²⁴, and akin to, if not taken from, that in the Gospel of the Egyptians (see below), with which also the dialogue form here and in no. 5 of the Logoi of 1903 and in a new fragment of a conversation on purity between Jesus and a Pharisee (found in December 1905) corresponds. These and other indications, which give a Johannine colouring to several of the sayings, even in the verbal sense, seem to point strongly to the conclusion that the Logoi of 1903, and probably also the Logia of 1897, in spite of the 'Hebraic rhythm and sound,' which many have noted, belong to an anti-Jewish and ultra-spiritual Gospel or Gospels, related both to the original form of the Gospel of Thomas and to the Gospel of the Egyptians, the latter of which borrowed some of its material from the earlier 'Gospel according to the Hebrews.' This was already the view of Jewish critics (e.g. Joseph Jacobs) in 1897, and the evidence is greatly strengthened by the new finds. All are agreed in placing these collections in the 2nd cent., and it is quite probable that some of the remarkable 'Words of Jesus' therein contained may be genuine sayings of the Master.

The Fayum fragment contains a much mutilated version of Mt 26³¹, Mk 14²⁷, Lk 22³⁰⁻³⁴, Jn 13³⁷. 16³². The whole is well restored by Zahn, who thinks it a scrap of a homily on Lk 22³⁴. New words are introduced for 'cock' and 'crow.' Others ascribe it, with less reason, to the Gospel of the Egyptians. It may be dated with confidence before A.D. 230.

(B) *TRANSITION GOSPELS*.—(a) *The Gospel of the Egyptians* (Clem. *Strom.* iii. vi. 45, ix. 63, xiii. 91, 93, xv. 97; Origen, in *Luc.* i. 1; Hippol. *Philos.* v. 7; Epiph. *Hær.* lxii. 2; *Or. Sib.* ii. 1, 63; II Clement [Soter, A.D. 140], xii. 2, 6, perhaps also iii. 2, iv. 2, 5, v. 2, 4, vi. 1, 2, viii. 5, ix. 11, xi. 7: cf. Oxyrhynchus Log. 5 [1897]; New Gospel Fragment [1903]).—Despite confident assertions to the contrary, the state of our knowledge at present hardly justifies a decided conclusion concerning this mysterious writing. The history of its criticism is a study of the employment of the dangerous 'argu-

ment from silence.' It is regarded by Origen as the first of the heretical Gospels, and is treated by Clement apart from other Apocryphal Gospels, though it is true that he adds 'I suppose' (*οἶμαι*). This does not imply serious doubt. Hippolytus says that it was used by the Naassenes to support their speculations on the transmigration of souls. Epiphanius had only heard that it supported Sabellian erroneous notions concerning the essential unity of the Trinity. Clement found that Cassian's Enkratite and ascetic followers misinterpreted it to support their extreme views on the sinfulness of marriage. Lightfoot (*Apostolic Fathers*, London, 1890, I. ii. 238) and most other modern critics have concluded that Soter of Rome (A.D. 140) had this Gospel before him in writing our II Clement, and quoted largely from it. We have seen that the discoveries of 1902 and 1903 point strongly to a relationship between this Gospel and the Logoi of Oxyrhynchus. Clement's quotations imply that the Gospel was largely composed of dialogues, in which Salome took a large part; and Celsus (before A.D. 180), in jeering at Christian divisions, remarked on the existence of a sect which gave high honour to this otherwise secondary figure. Harnack seeks to prove it the earliest of all the Gospels. His chief argument lies in the name *κατὰ τοὺς Αἰγυπτίους*, which he regards as synonymous originally with 'the Gospel of Egypt,' only later superseded by the importation of the foreign Gospels of Mark, Matthew, and Luke. The other proof he finds in its use at Rome in A.D. 140. But it is not probable that the Alexandrian Fathers, who alone quote it, reckoned themselves as Egyptians at all; and this Greek Gospel was as foreign to the 'people of the land' as any of the others. Moreover, it is not certain that Lightfoot and others are right. It is quite possible that we may have to accept Resch's view that Soter quotes, as a rule, only the sources on which the Gospel of the Egyptians was based, which existed in the form either of oral tradition or of a written collection like the Egyptian 'Logia' to which we have referred. The stumbling-block to Harnack's view lies in the internal evidence of the fragments themselves. They bear no resemblance to the naive tales and clear-cut sayings of the Gospel of the Hebrews, but, on the contrary, have all the appearance of being the product of long reflexion upon the inner meaning of the Saviour's teaching, as read in the light of current Alexandrian speculation, revealing the unsubstantial nature of present differences and distinctions, which are to vanish in the larger world to come. It is incipient Gnosticism; and, if contemporary with any of the four Gospels, it is only with the Fourth. But, by the common consent of critics, it must have been written before A.D. 120.

(b) *Gospel according to the Apostles* ('*juxta Apostolos*'), or '*of the XII.*' (Origen, in *Luc.* i. 1; Theophylact., Proem. in *Luc.*; Jerome, *adv. Pelag.* iii. 2; Epiph. *Hær.* xxix. f.; cf. Zahn, *Gesch. NT Kan.* ii. 725).—It is only recently that portions of this Ebionite work, condemned by Origen and Jerome, have been recognized in the fragments of a Greek Gospel, confused by Epiphanius with the Aramaic Gospel of the Hebrews. The Venerable Bede (on Lk 1¹) and Fabricius (1719), 1000 years after, had differentiated the two; but modern criticism seemed at first inclined to injure itself by identifying and confusing them as Jerome once did. Nicholson, Harnack, and Zahn have all aided in averting this disaster. The Gospel known to Epiphanius was a Greek 'tendency writing,' put in the mouth of Matthew and the Apostles, and intended as a Gospel for the Judaizing Christians, who aimed at winning converts among the Gentiles. This party was nearly related to the ancient Essenes (q.v.), and the Gospel before us gives us an

idea of the Christ as Essenes would have pictured Him. He denounces sacrifice and the eating of flesh; even John the Baptist is made to eat 'honey cakes' in place of 'locusts' (*ἐγκρίδες* for *ἀκριδες* proves a Greek original). Christ is invested with the Spirit at His baptism, and tales of His early life and miraculous birth are passed over in silence. The Gospel uses all the Synoptics, especially Lk., and possibly also borrows words (e.g. 'Tiberias') from St. John, who appears at the head of the Twelve. It dates, probably, before A.D. 180, and uses some old traditions; it is the 'worst kind of Gospel harmony,' and has no relation with the Gospel of the Hebrews, which is unknown to the author.

(C) *SUPPLEMENTARY OR HAGGADIC GOSPELS* (condemned as a whole by Euseb. III. xxv., and *Decret. Gelasii*; also by Pope Leo XIII. in 1884).—These fall into two cycles: (1) those dealing with the Infancy; and (2) those dealing with the Trial, Death, and Resurrection of Christ.

None of these Gospels exists in its original form, but only in orthodox recensions of late date. Though most are of heretical origin or contain heretical tendencies and sources, they are not written to compete with orthodox Gospels, but to satisfy curiosity, where these are silent. They are not intended, therefore, primarily to mislead opinion, and are not rightly to be classed with the heretical Gospels, whose aim was to modify history in the interests of a theory. These Gospels, in various versions, are so much the best known that they have often been taken as the type of Apocryphal Gospels in general, and what applies to them only, or mostly, has been indiscriminately applied to the whole class. Eusebius (III. xxv. 7) spoke of them as 'altogether absurd and impious' (*ὡς ἄτοπα πάντη καὶ δωροειβή*); and his verdict has been re-echoed through the centuries down to our own times, and reappears in a violent attack by Bishop Ellicott (*Cambridge Essays*, 1856, p. 153) and many other orthodox divines, whose words apply well to such as the Gospel of Thomas, but are apt to be very misleading when used of the whole series of Apocryphal Gospels.

(1) *INFANCY CYCLE*.—The numerous versions of Infancy Gospels fall into two groups, which spring from two distinct sources—the first orthodox, the second Gnostic—while the two have been combined to produce a third.

(a) *The Protevangelium of James*, now extant in Greek and Syriac, has passed through many changes. The name is of the 16th cent. (M. R. James), but the original form of the work (chs. 1-17 = 'Book of James' [Origen, in *Matt.* x. 17]) was probably known to Clement of Alexandria and almost certainly to Justin (Tischendorf, Zahn, Harnack)—i.e. it was written before A.D. 140 by a Jew not of Palestine. To this was added the Gnostic *Apocryphum Josephi* (chs. 18-21), in which Joseph is the speaker. It was probably composed in A.D. 250 (Lipsius). A further addition was the *Apocryphum Zachariæ* (chs. 22-25) in A.D. 290-310. In A.D. 376 the whole book was probably known to Epiphanius (*Hær.* lxxix. 5, lxxviii. 7), and perhaps also to Gregory of Nyssa. The so-called Latin *Gospel of pseudo-Matthew* (1-17) is merely an orthodox edition of the 'Book of James,' which took its place in the West, probably about A.D. 450. The *de Nativitate Mariæ* is descended from this Latin Gospel; on this, too, the 'Golden Legend' of the 13th cent. is based, and a later recension of it, with many additions and Gnostic touches, appears in the Arabic *History of Joseph the Carpenter*, a translation of a 4th cent. Coptic original; while another version of this legend, transformed by the new doctrine of the efficacy of prayers to Mary and the teaching of the Assumption and Exaltation,

appears in the *Transitus Mariæ*, a Syriac Gnostic work of 290–350, recast by a Catholic Christian in 410, extant also in Greek, Latin, Arabic, Ethiopic, and Sahidic — ‘the firm foundation,’ as Ewald calls it, ‘of all the unhappy adoration of Mary.’

(b) *The Gospel of Thomas* (Origen, in *Luc.* i. 1; Euseb. iii. 25).—Cyril (*Catech.* iv. 36 [A.D. 380–386]) condemned this Gospel as heretical; he reckoned it Manichæan. Hippolytus gives quotations from it, not in our version. The catalogue of Nicephorus (A.D. 599) shows that it was a long piece of 1300 stichoi, which proves that our text is but ‘a meagre abstract of the original’ (Lipsius, art. ‘Gospels Apocryphal,’ in *DCB* ii. [1880] 704), from which Hippolytus quoted and which Cyril denounced. This Gospel was probably composed in 160–180, though it used some old traditions, one of which appears in Justin (*Dial.* 88), while another is referred to in Iren. (*adv. Hær.* i. xx. 1, xvi. 3 [A.D. 190]). The original was cut down and altered by Catholics in order to ‘enlist the miraculous stories of the Childhood on the Catholic side’ (Lipsius, p. 705); but very much remains to testify to its original character. The story deals with the Life of Christ only until He reaches the age of 12, and thus never runs parallel with the canonical narratives. The object is to show that Jesus was and knew Himself to be the Logos from His birth (in the dependent Arabic *Gospel of the Infancy* we find the Babe declaring this in His cradle; probably this comes from the original Gnostic *Gospel of Thomas*). Hence the need for miracles to show His power, hence the invention of such wonderful displays of sheer wilfulness as characterize the Child here and make His story so repellent to all reverent minds. Our *Gospel of Thomas*, a 4th cent. version, is extant in two Greek editions, and also in Latin and Syriac. The *Gospel of pseudo-Matthew* (chs. 18–end) is based upon it, and of this the Arabic *Gospel of the Infancy*, full of bizarre extravagances, is merely an expanded version of the 6th century.

(2) PASSION AND RESURRECTION CYCLE.—The second cycle of these Supplementary Gospels circles round the crisis of Christ’s departure from the world. Like the first, they have no historical value, and exist in many versions, in a much altered and very late form. The *Evangelium Nicodemi* (the 13th cent. title of a Latin version of the Greek *Ἐπομνήματα τοῦ κυρίου ἡμῶν Ἰησοῦ Χριστοῦ ἐπὶ Ποντίου Πιλάτου πραχθέντα*), like the Infancy Gospels, became very popular. Like the ‘Book of James,’ it is a composite work. All known texts go back to A.D. 425. The original was possibly a Christian reply to the forged *Gesta Pilati*, invented to slander the Christians by the Emperor Maximin Daza (A.D. 311–317). The idea was based on the Roman custom of drawing up official reports, and the first hint of the existence of such a record of Christ’s trial appears in Justin (*Apol.* i. xxxv., xxxviii.; cf. Tertull. *Apol.* v., xxi.). It was natural that an account purporting to fill this place should be drawn up, and the book in question appears first in Epiph. *Hær.* i. 1. The author was a Jewish Christian who knew some Hebrew; to his work was attached a Gnostic account of the *Descensus ad inferos*, added by the editor of A.D. 425 from an older collection ascribed to Leucius Charinus (? = Lucian of Antioch); also a forged letter of Pilate to the Emperor Claudius—probably of early date. The Coptic version dates from 361–363, and uses Eusebius. It exists also in Latin, Greek, and Armenian; and many other additions to this collection appeared in the Middle Ages—for instance, the *Mors Pilati* and *Ep. Herodis* (see R. Hofmann, in *PRE* i. 658–660).

(D) LOST AND HOSTILE GOSPELS.—These are ‘tendency writings’ of little historical value.

(a) *Gospel of Philip* (Epiph. *Hær.* xxvi. 13), referred to incidentally in *Pistis Sophia* (A.D. 150–200), and used later by the Manichæans (mentioned in Leontius of Byzantium [500–540]; cf. also F. W. K. Müller, *ABAW*, 1904, Anhang, p. 108).—It was the work of Egyptian Gnostics during the latter half of the 2nd century.

(b) *Gospel of Matthias* (Euseb. *HE* III. xxv. 6).—Hippolytus (*Refut.* vii. 8) says that Basilides (A.D. 140) appealed to *Λόγους Ἀποκρυφίους Μαθθίου*. Zahn identifies these with the *παράδοσεις* quoted by Clem. Alex. (*Strom.* vii.; cf. II. ix., III. iv.), and containing an identification of Matthias with Zacchæus (*Strom.* IV. vi. 35), who as *head-publican* is set up to counteract the authority of Matthew, his subordinate! Harnack doubts this ingenious theory.

(c) *Gospel of Basilides* (Origen, in *Luc.* i.; Jerome, Proem. in *Matt.*) was perhaps a Gospel-harmony in Docetic spirit (composed in Egypt 120–140).

(d) *Gospel of Valentinus* (Tertull. *de Præscript.* xlix.), possibly identical with *Evangelium Veritatis* (Iren. *adv. Hær.* III. xi.), was probably a treatise on the Gospels written in A.D. 140.

(e) *Gospel of Apelles* (Epiph. *Hær.* xlv. 2) contained Resch’s Logion 43 (cf. 1 Th 5²¹). Apelles was a friend of Marcion (140–160).

(f) *Gospel of Eve*, or ‘of Perfection’ (*τελειώσεως*) (Epiph. *Hær.* xxvi. 2; Philaster, *Hær.* xxxiii.), an Ophite, Gnostic, and pantheist Gospel. The scene here, as elsewhere in class D, is laid ‘after the Resurrection.’ Eve is described as seduced by Satan, the father of Cain.

(g) *Gospel of Judas Iscariot* (Iren. *adv. Hær.* i. xxxi.).—The betrayal is treated as a meritorious action, delivering man from the power of the Demiurge (Epiph. *Hær.* xxviii. 1). Judas is thus the ‘perfect Gnostic’!

(h) *Gospel of Cerinthus* (Epiph. *Hær.* li. 7).

(i) *Gospel of Thaddæus* (condemned with others in *Decret. Gelasii*).—Thaddæus is perhaps regarded as one of the 70 disciples, who went to Edessa.

(j) *Gospel of Bartholomew* (Jerome, Proem. in *Matt.*; *Decret. Gelasii*).

(k) *Gospel of Andrew* (*Decret. Gelasii*), perhaps identical with the Gnostic *Περίοδοι Ἀνδρέου*, attacked by Augustine (*de Adv. Leg. et Proph.* xx.).

(l) Augustine (*de Adv. Leg. et Proph.* ii. 14) quotes an unknown Marcionite Gospel as making Christ say to the Jews: ‘Ye have sent away the living who is before you, and ye prate (*fabulamini*) about the dead!’

(m) Besides these we possess a Muhammadan *Gospel of Barnabas*, based on a Gnostic Docetic Gospel (condemned in *Decret. Gelasii*), now extant in an Italian MS at Vienna. A Spanish version once existed, but is now lost. This book is mentioned by Toland (*Nazareus*, London, 1719); it was found by Cramer, and purchased by Prince Eugene of Savoy. The stories of an Arabic original are probably mythical. A wide spirit of tolerance and charity pervades this astonishing production of a Christian mystic who became a Muslim. It probably dates from 1300–1350. The death of Judas Iscariot, substituted for Christ on the cross, is described here in detail, and is probably a feature of the original Gnostic *Gospel of Barnabas*.

LITERATURE.—Only a selection of the most important works is given.—I. GENERAL.—J. A. Fabricius, *Cod. NT Apocr.*, Hamburg, 1703, 21719; J. C. Thilo, *Cod. NT Apocr.*, Leipzig, 1832; C. Tischendorf, *Evang. Apocr.*, do. 1876; A. Hilgenfeld, *NT extra Canonem Receptum*, do. 1876, 41884; E. Preuschen, *Antilegomena*, Giessen, 1901; T. Zahn, *Gesch. des NT Kanons*, i., ii., Leipzig, 1888–92; A. Harnack, *Gesch. d. altchristl. Litt.*, do. 1893–97; W. Wright, *Contrib. to Apocr. Lit. of NT*, Cambridge, 1865; Forbes Robinson, ‘Coptic Apocr. Gospels,’ in *TS* iv. ii. (Cambridge, 1890); J. Orr, *Apocr. NT* (Temple

Library, 1900)—brief and popular; G. Salmon, *Hist. Introd. to Study of NT's*, Dublin, 1890, Lect. xi.; B. F. Westcott, *Introd. to Study of the Gospels*, London, 1881, Appendices; B. Pick, *Life of Jesus according to Extra-canonical Sources*, New York, 1887; Ante-Nicene Library, esp. suppl. vol., Edinburgh, 1896; art. on 'Apocryphal Gospels,' in *HDB*, vol. v. (J. G. Tasker), *DCG* (A. Fyfe Findlay), *EBr*¹¹ (R. H. Charles), *EBi* (M. R. James), *PRK*² (R. Hofmann), and *DCB* (R. A. Lipsius); *TU*, Leipzig, 1884-1906; A. Resch, *Agrapha*, do. 1889; J. H. Ropes, *Sprüche Jesu* (= *TU* xiv. 2), do. 1896; A. Harnack, *Bruchstücke des Evang. u. d. Apokal. d. Petrus*² (= *TU* ix. 2), do. 1898; E. von Dobschütz, *Kerygma Petri* (= *TU* xl. 1), do. 1894; R. Handmann, *Das Hebräerevangelium* (= *TU* v. 8), do. 1888. (Handmann reviews all previous writings on the subject.)

II. *SPECIAL*.—On Gospel according to the Hebrews: J. Nicholson, London, 1879; W. Adeney, in *HJ* iii. [1904] 139; A. Menzies, art. in *HDB* v. [1904] 338; see also Harnack, Zahn, Handmann, as above.—On Gospel of Peter: J. A. Robinson, 1897; H. B. Swete, 1892; author of *Supernatural Religion*, ed. London, 1893—brilliant but biased.—On Logia Iesou: B. P. Grenfell and A. S. Hunt (1897, 1902); W. Lock and W. Sanday, *Two Lectures*, Oxford, 1897; Grenfell and Hunt, *New Fragment of a Gospel*, 1903; H. B. Swete, in *ExpT* xv. [1903] 488.—On Fayum Gospel Fragment: R. Bickell, in *ZKT* iii. [1885] 498 (cf. T. Zahn, *Gesch. des NT Kanons*, ii. 132, and A. Harnack, in *TU* v. 4).—On Lost and Hostile Gospels: S. Baring Gould, *The Lost and Hostile Gospels*, London, 1874—suggestive and interesting, though out of date.—On Gospel of Barnabas: J. White, *BL* (1784); W. H. Axon, in *JThSt* iii. [1902] 441, tr. by L. Ragg, Oxford, 1907.

L. ST. ALBAN WELLS.

GOSSIP.—The word in its original use indicated a person who had become related (*sib*) to another through a common relation in the service of God, as a sponsor, who answers for a child in baptism. It then broadened out to embrace those who were related to one another through common interests of some sort. It was next applied to the talk of those who were thus related, and finally to the speech of friends, neighbours, and acquaintances about persons and matters which were of common interest to them. Gossip is essentially a social function, and is as old and universal as society. It has existed *semper, ubique, et in omnibus*. It finds its material everywhere. Nothing is too high or too low for it. If we seek to gather the general sense of its moral character, there can be little doubt that it is condemnatory. Burns, in his *Address to the Unco Guid*, says:

'Ye've nought to do but mark and tell
Your neebours' fauts and folly.'

Tennyson numbers gossip among the 'sins of emptiness' (in *The Princess*, pt. ii. line 92). Coleridge may have had it in mind when (in *Christabel*, pt. ii. line 78) he wrote:

'But whispering tongues can poison truth.'

Most of the definitions or descriptions of gossip are in agreement with this judgment of it. It is a 'retailing of small talk,' 'the telling of idle tales,' 'women's tattle over tea.' It is 'generally concerned with evil things, and is rarely beneficent.' It is usually regarded as being inspired by an impertinent curiosity, and as having no interest but a selfish one. It tends to create ill-feeling, disturbs peaceful friendships, tempts to exaggeration, fosters a morbid love of prying, and is a fruitful source of evil imputations. It has little regard for the truth of what it repeats, inclines to add fiction to fact, exercises little or no discrimination or censorship, and aims chiefly at effect. It is characterized by a general pettiness of interest, and requires slight powers of thought. The mind that finds delight in gossip is prisoned in the lower interests of life. Though it is more genial and kindly than scandal, it is closely and dangerously allied to it, and often passes into it. The habitual gossip is almost always a scandal-monger.

However much it may be condemned, it must be admitted that gossip is exceedingly attractive. There is a certain pleasure in hearing and retailing it. The word suggests the frank and interested talk of neighbours and intimates about the sayings and doings of people whom they know. In the small world of private life there are incidents and

dramas as exciting and absorbing as those that take place on the larger and wider stage of the world's life. Social life has been called 'the drama of mankind'; and men and women find pleasure, relaxation, and perpetual interest in it. The girls of Newnham College, Cambridge, in their debating society once discussed the question 'Is Life worth living without gossip?' and unanimously decided that it was not. Miss Gladstone, Principal of North Hall, defended the vote. It is to be noted that gossip is most active in small communities. In the village or parish the interests are fewer and more personal, and the sense of kinship is more acute than in larger communities. Where every one knows his neighbour, gossip is rife. It is regarded as a practice to which women are specially prone. It is possible that the more restricted life which most women live, as compared with men, has led them to indulge in this social activity. In the same circumstances, as may be seen in individual instances, men would indulge in it as largely as women. In proportion as women enter into the larger life and interests of the world, their tendency to gossip declines. The massing of men and women in cities under the influences which have produced our modern civilization has weakened the sense of kinship, increased the feeling of individualism, and multiplied the larger interests of life. Gossip has, therefore, in some measure declined, but the instinct continues to exist, and satisfies itself with the personalities of the cheap or 'gutter' press, journals which report the sayings and doings of famous or infamous people, the details of divorce cases, and the articles which the 'lounger at the Clubs' can supply. Finer minds find satisfaction for the gossiping instinct in histories, biographies, autobiographies, memoirs, and reminiscences. Among the French this type of literature has been brought to a high state of perfection. In their *Mémoires*, gossip has almost attained the dignity of an art.

It is far from just to indulge in indiscriminate condemnation of the practice of gossip. It is a social product, and could be destroyed or brought to silence only by a universal and absolute individualism, in which no one cared for what concerned another. It is irrelevant to say that gossip should be confined to things and should not deal with persons. There is little interest in things, except what comes to them in relation to persons. Besides, persons are more interesting than things, and it is they who make up the social community out of whose relationships gossip arises. So long as men and women live in society, and have the power of speech, they will talk of the sayings and doings of others. It is surprising how much can be said in defence of gossip. Not only is it a necessary outcome of social life and social instincts, but, in spite of its occasional disruptive effects, it helps to vitalize social life, strengthens the links that keep society together, and lessens the arctic chill of a growing individualism. It is the school of social criticism, through which men and women form and express their judgments, and determine many of their social actions. It is the vehicle of the social conscience. It may err, and does err repeatedly, but its errors do not destroy its social helpfulness. It assists in forming and preserving the moral tone of a community. The practice of gossip also provides for the exercise of charity, magnanimity, and gentleness. The charity that 'taketh not account of evil; rejoiceth not in unrighteousness, but rejoiceth with the truth' (1 Co 13³⁴) would have few opportunities of showing itself, and of perfecting itself in a social world in which gossip was unknown. It may even be said that, in so far as Christianity has affected the alienations and separations of society, bridged the

gulfs that yawn between classes and nations, and increased the sense of kinship and brotherhood in the world, it has enlarged the sphere and powers of gossip. 'Not looking each of you to his own things, but each of you also to the things of others' (Ph 2^d) is a precept which encourages the spirit out of which the tendency to gossip comes. We must not forget the debt which literature owes to this social interest. In the essays of the *Spectator*, *Tatler*, and the like, the social criticism of the time is thrown into such vivid forms that the age lives before the reader in a more realistic and truthful way than any didactic history could produce.

Gossip resembles all the universal activities of humanity. It is like the power of thought or imagination. It is one manifestation of the power of speech. It may be used for good or for evil, for genial and kindly ends or for those that poison and embitter and degrade. To eradicate it is impossible so long as man remains a social animal. To use it rightly should be the aim of every one. 'If any stumbleth not in word, the same is a perfect man' (Ja 3^d).

LITERATURE.—A. K. H. Boyd, *Autumn Holidays*, London, 1866, p. 280; M. D. Babcock, *Thoughts for Every-Day Living*, New York, 1901; M. G. Conklin, *Conversation*, London, 1912; A. C. Benson, *Along the Road*, do. 1913, p. 200; *St. James' Magazine*, April 1861; *Fraser's Magazine*, 1891; *New England Magazine*, vol. vi.; *Spectator*, Sept. 1888; *The Month*, vol. c. p. 336.

JOHN REID.

GOTRA.—There exists as yet no competent history of the Indian *gotras*.¹ If, however, we take as our starting-point the Brāhmanical legend and theory regarding them, and compare therewith the references made to them, incidentally and apart from the influence of theory, in Indian literature, we may perhaps find ourselves able to form some approximate idea of the singular nature of these family communities, which, together with caste (*q.v.*), are of the utmost significance for the structure of Indian society. Nor can we in this investigation rely solely upon the Sanskrit literature; we must also take into account the Pali Canon of the Buddhists, and the books of the Jains. If we then compare with the results thus obtained the data furnished by the ethnological materials found in modern Anglo-Indian literature, we may venture to draw from these various sources some conclusions regarding the origin and character of the *gotras* in ancient times.

1. Brāhmanical legend and theory.—The Brāhman all pride themselves on their Divine origin.² Legend³ relates that once, when Brahmā was performing a sacrifice, there came forth from it the seven *ṛṣis*—Bṛhigu, Āngiras, Marichi, Atri, Pulaha, Pulastya, and Vasistha. The Brāhmanical septs were likewise supposed to derive their origin from seven *ṛṣis*, though not exactly the seven just named, of whom the fifth, Pulaha, brought forth demons (*rākṣasas*), and the sixth, Pulastya, devils (*piśāchas*), while the seventh, Vasistha, died, and appeared again as a descendant of Marichi. Then, as Bṛhigu and Āngiras, owing to their mythical character, could not properly be represented as

¹ The Indian lexicographers explain *gotra* as synonymous with: *santati* ('lineage'), *janana* ('race'), *kula* ('family'), *abhijana* ('descent'), *anvaya* ('progeny'), *varṣa* ('race'), *anvādyā* ('lineage'), *santāna* ('family, offspring') (Amarakośa, 2. 7. 1). The meaning *akhyā* ('name') has apparently been developed from that of 'family,' 'family name.' In the *Rigveda*, *gotra* means simply 'cow-stall,' 'stall.' Pāṇini (iv. 1. 162 f.) uses the word in a grammatical sense, with which the present article has nothing to do, its aim being to deal with *gotra* in its purely sociological aspect, i.e. as 'family' or 'race.' On the probable connexion of this meaning with the Vedic sense of 'cow-stall,' cf. G. Sarkar, *Hindu Law*, Calcutta, 1903, p. 49 f.

² *Taittirīya Brāhmaṇa*, 1. 2. 3, 9.

³ *Matsyapurāṇa*, cxv. 8 ff. For other versions of the legend regarding the origin of the Brāhman caste, cf. J. Muir, *Original Sanskrit Texts*, 1. (London, 1868) 7 ff., and the art. *BṚHIGU*, in vol. II. p. 658.

founders of families,¹ their place is taken in the Brāhmanical theory by other three ancestors, Bṛhigu being superseded by Jamadagni, and Āngiras by Gautama and Bharadvāja. In the *Satapatha Brāhmaṇa*,² accordingly, the seven *ṛṣis* enumerated as ancestors are: Gautama, Bharadvāja, Viśvāmitra, Jamadagni, Vasistha, Kāśyapa, and Atri. To these tradition adds an eighth, Agastya; and thus the Brāhmanical clans (*gotras*) are in reality traced to eight ancestors. These rank as *gotrakārins*—the founders of the numerous Brāhmanical families, and their descendants are the various *gotras*.³

The number of families descended from the eight *gotrakārins* is far from constant in the Brāhmanical tradition. According to *Āśvalāyana*,⁴ the total is forty-nine. Seven of these (Vatsas, Arṣiṣepas, Bidas, Yaskas, and others, Śyaltas Mitrāyus, Sunakas) trace their origin to Jamadagni; ten (Gotamas, Uchathyas, Rahūgaṇas, Somarājakis, Vāmadevas, Brihadukthas, Priṣadaśvas, Rikṣas, Kakṣivants, Dirghatamasas) to Gautama; nine (Bharadvājas and Āgniveśyas, Mudgalas, Viṣṇuvṛiddhas, Gargas, Haritas, and others, Śaṅkritis, and others, Kaṇvas, Kapls, Śauṅga-Śalsiris) to Bharadvāja; two (Atris, Gaviṣṭhīras) to Atri, twelve (Chikitas, and others, Śraumata-Kāmakāyānas, Dhanañjayas, Ajas, Rohipas, Aṣṭakas, Pūrapa-Vāridhāpayants, Kutas, Aghamarṣas, Renu, Vepus, Śālāṅkāyanas, and others) to Viśvāmitra; four (Kāśyapas, Nidhruvas, Rebhas, Saṅḍīlas) to Kāśyapa; four (Vasisthas, Upamanyus, Parāśaras, Kuṇḍīnas) to Vasistha; and, finally, a forty-ninth, the Agastis, to Agastya.

In a passage quoted by Rādhakānta⁵ the number is given as twenty-four, viz. the Śaṅḍīlya, Kāśyapa, Vātaya, Sāvarnaka, Bharadvāja, Gautama, Saukālina, Kalkiṣa, Āgniveśya, Kṛiṣṇātreya, Vasistha, Viśvāmitra, Kuśika, Kauśika, Ghṛitakauśika, Maudgalya, Alamyāna, Parāśara, Saupāyana, Atri, Vāsuki, Rohita, Valyāghrapadya, and Jāmadagnya *gotras*.

In a passage of the *Kuladīpikā*, also quoted by Rādhakānta, we find the names of thirty-two *gotrakārins*, corresponding in part with the above, but it states that the complete number of *gotras* is forty.

To fix the number of *gotras* at eighteen, as is done by a modern Hindu writer,⁶ cannot be considered as other than a hypothesis based upon Brāhmanical legends. Chentsal Rao, the writer in question, holds that the original eight families of *gotrakārins* were supplemented by ten more, and that the latter consisted of Brāhman who had for a time followed the vocation of Kṣatriyas, and had become Brāhman again, regarding themselves as descended either from Bṛhigu or from Āngiras. They rank as Kevala-Bhārgavas or Kevala-Āngirasas (*kevala* = 'separate,' 'isolated'), and may intermarry with any other family. Their names are: Vitahavya, Mitrāyu, Sunaka, Vepa, Rathitara, Mudgala, Viṣṇuvṛiddha, Harita, Kaṇva, and Śaṅkṛiti.⁷

Closely connected with the *gotra* is the *pravara*, i.e. the invocation of Agni by the name of the *ṛṣi*-ancestors of a Brāhman who consecrates the sacrificial fire. The officiating priest whose duty it was to call upon Agni Havyavāhana, the deity who carries the libations to heaven, pronounced the names of the *ṛṣi*-ancestors (*ārṣeya*) peculiar to his *gotra*, in order to show that he, as the offspring of worthy forbears, could fitly and worthily perform the sacred action. It was a law that the number of the *ārṣeyas* or *pravara-ṛṣis*, whose names were thus pronounced, might be one, two, three, or five, but no other.⁸ Thus, e.g., of the *gotras* specified as descendants of Jamadagni in the above list from

¹ Cf. Ludwig, *Die Mantralitteratur*, p. 178.

² xiv. 5. 2, 6. For the *saptarṣayas*, cf. also the passages quoted in Böhtlingk-Roth, *Sansk. Wörterb.*, St. Petersburg, 1856-75, s.v. 'Riṣi.'

³ *Āśvalāyana Śrauta Sūtra*, *pariśiṣṭabhāga* 8.

⁴ *Āśv. Śr. S.* xii. 10. 6 ff. Cf. Max Müller, *Hist. of Ancient Skr. Lit.*, London, 1860, p. 380 ff.

⁵ *Śabdakalpadrūma*, s.v. 'Gotra.'

⁶ Chentsal Rao, *The Principles of Pravara and Gotra*, p. iii.

⁷ According to the *Gotrapravaranirṇaya* (in Anantadeva, *Sanskṛatkaustubha*, Bombay, 1861), the Kevala-Bhārgus comprise the following six families: Vatsas, Arṣiṣepas, Yaskas, Mitrāyus, Valnyas, and Sunakas, while the Kevala-Āngirasas are also six in number, viz. Haritas, Kutas, Kaṇvas, Rathitaras, Viṣṇuvṛiddhas, and Mudgalas.

⁸ Cf. Gārgya Nārāyaṇa to *Āśv. Śr. S.* xii. 10. 5. The *dvigotras*, i.e. a person who belongs to two *gotras*, must, according to *Sāṅkh. Śr. S.* i. 4. 15, in performing the *pravara*, utter the names not of three, but of six ancestors; this is the case of the so-called *kṣetrāja*, the son lawfully begotten of the wife of a childless man, and therefore belonging to the *gotra* of his bodily as well as to that of his adoptive father. Cf. the section '*dvivāśyāḥ*' in the *Pravaraḍarṇaya* of *Kamalakara* (Chentsal Rao, *op. cit.* pp. 180-186); see, further, the *Kauṣīṭīya*, ed. Shama Śastri, Mysore, 1909, p. 164.

the *Āvalāyana Śrauta Sūtra*,¹ the Vatsas invoked Agni as Bhārgava, Chyāvana, Āpnavāna, Aurva, and Jāmadagna; the Arṣiṣeṇas, as Bhārgava, Chyāvana, Āpnavāna, Arṣiṣeṇa, and Ānūpa,² and so forth.

The Kṣatriyas and the Vaiśyas, according to the Brāhmanical theory, were required to pronounce the *pravara* of their *purohita* (domestic chaplain). Similarly, if sacrifice was offered by a king, the officiant named not the king's ancestors, but those of his *purohita*; though the king's *rājārṣi* forbears might also be named.³ According to other sources, however, the *pravara* was firmly established among both the Kṣatriyas and the Vaiśyas—Mānava, Aila, and Paurūravasa being named as the *arṣeyas* of the former, while Agni was invoked by the latter as Bhālandana, Vātsapri, and Mānkila.⁴

To the above-mentioned *pravara* lists are annexed specific discussions regarding the *gotras* between which intermarriage was permitted or forbidden. In general, persons belonging to the same *gotra*, or having the same *pravara*, are not allowed to marry one another. The recognized rule is that individuals are regarded as *sagotra*, i.e. belonging to the same *gotra*, if they have in common even one of the *ṛṣis* invoked in the *pravara*.⁵

A Kāśyapa, for instance, must not marry the daughter of another Kāśyapa; but he is likewise prohibited from marrying the daughter of a Śaṅḍila, as the *pravara* group of the Kāśyapas (Kāśyapa, Āvatsāra, and Asita) and that of the Śaṅḍilas (Śaṅḍila, Asita, and Daivala) contain a common ancestor, Asita. The *gotras* of the Bhṛigus and the Āngiras are in part exempt from this rule. Thus, of the seven *gotras* tracing their descent to Bhṛigu, the Śyaitas, Mitrāyus, and Sunakas may intermarry; and, similarly, the Pṛiṣadaśvas, Mudgalas, Viṣṇuvṛiddhas, Kapvas, Agastyas, Haritās, Saṅkṛitis, Kapis, and Yaskas may all marry with one another, as also with the Jāmadagnyas, etc.⁶

2. The data regarding the *gotras* in ancient India.—It is hardly possible to decide how far the legendary and theorizing traditions of the Brāhmanas, and more especially the *pravara* lists, contain historical elements corresponding with the actual facts of genealogy. The proto-ancestors of the *gotras* must be regarded, not indeed as real personalities, but certainly as eponyms whose existence was taken for granted, and to whom the entire spiritual heritage of the priestly tribe was ascribed. We must assume that the hereditary character of the priesthood was already recognized in the Vedic period; such songs, religious traditions, and sacrificial customs as had come to be linked with the name of a particular *ṛṣi* were in the post-Vedic age vested in the *gotra*.⁷ The determining condition of joint-membership in any given *gotra* was spiritual connexion and inheritance, mere physical descent being of less importance; for, though the *gotra* was transmitted from father to son, yet not all members of a *gotra* were blood-relations.

Many a Brāhman, when asked by his *guru* to what *gotra* he belonged,⁸ could only answer, like Satyakāma, the son of Jabālā: 'I know not, teacher, of what *gotra* I am.' In such cases the teacher gave his pupil a name taken either from a deity or from a constellation, and also, as some writers say, the name of a *gotra*,⁹ and we must suppose that the pupil thenceforward regarded himself as belonging to the *gotra* thus imposed.

The dubiety as to physical descent made it necessary to formulate the rule that, if the *pravara*

¹ *Āśv. Śr. S.* xii. 10. 61.

² A collection of the traditional *pravara* lists, differing considerably from one another, is given by Puruṣottama in his *Pravaramaṅgari* (reproduced in Chentsal Rao, *op. cit.* pp. 1-125); cf., further, the section *Gotrapravaranirpaya*, in Anantadeva, *Saṁskṛatavastuśāstra*, p. 179 ff.

³ As required, e.g., by *Āitareya-Brāhmaṇa*, vii. 25, and *Sākh. Śr. S.* i. 4. 17; cf. Weber, *Ind. Stud.* x. 79.

⁴ Baudhāyana, quoted by Puruṣottama, *Pravaramaṅgari* (ed. Chentsal Rao, *op. cit.* p. 126). See *Āśv. Śr. S.* xii. 15. 4, 6; but cf. the variations in *Āpastamba Śr. S.* xxiv. 10. 11-18.

⁵ *Āśv. Śr. S. Parīṣiṣṭabhāga*.

⁶ *Ib.*; cf. Max Müller, *op. cit.* p. 387 L.

⁷ Ludwig, *Mantrabīlitteratur*, p. 178.

⁸ *Chāndogyaopaniṣad*, iv. 4. 4.

⁹ *Godāliya Gṛihya Sūtra*, ii. 10. 23-25; cf. Weber, *op. cit.* p.

was not certain, then—even in the case of a Brāhman—the only ancestor to be named was Manu, the common progenitor of all.¹

But, although the purely spiritual relationship took precedence in the *gotras*, the system of relations based upon community of ancestors, whether assumed or real, was not without influence on practical life. The above-mentioned regulations of the Brāhmanical ritual literature, enjoining that the Brāhmanas, after completing their period of study, should, on kindling the sacred fire, perform the *pravara*—i.e. the rite of calling upon Agni under the name of three or five ancestors—doubtless correspond with actual practice. And, while many a mythical ancestor might be foisted into the *pravara*, yet those elements of the ritual in connexion with which father, grandfather, and great-grandfather had to be mentioned by name forced the members to keep alive the knowledge of their ancestors from generation to generation,² and thus tended to give a certain fixity to the genealogical relations of the various families. There were several other circumstances which intensified the exclusiveness of the families already fused into a unity by belonging to the same *gotra*, and thus separated the different *gotras* more or less rigorously from one another.

An external indication of membership in a particular *gotra* has been found in the mode of wearing the hair. The Bhārgavas had the head shaven; the Āngiras wore five braids, the Atris three curls, and the Vasiṣṭhas, according to the *Rigveda*, wore a plait on the right side of the head.³ An injunction referring to the ceremony of hair-cutting, found in the *Āvalāyana Gṛihya Sūtra*,⁴ viz. 'Let him have his hair dressed according to the custom of the family,' points to a family custom that was, no doubt, connected with the practice of distinguishing the *gotras* by the mode of dressing the hair. In other *Gṛihya Sūtras* it is stated that the style of wearing the hair is determined by (family) custom, or *yatharṣi*.⁵ The commentators explain the expression *yatharṣi* as signifying that the number of curls worn corresponds to the number of *ṛṣis* named in the *pravara*; thus, one for those who had one *ṛṣi* in their list of ancestors, two for those who had two, and so on.⁶

The deep-seated antagonism between the Vasiṣṭha and the Viśvāmitra septs, which, according to tradition, arose out of the famous conflicts between their respective ancestors, but which was in reality an expression of the struggle for supremacy between the nobility and the priesthood,⁷ is frequently referred to in the literature.

According to Kātyāyana, a Viśvāmitra and a true Vasiṣṭha cannot both take part in the same *sattra*, i.e. in a *soma*-sacrifice which has more than twelve days of *soma*-pressing.⁸ Similar differences with respect to the ritual are to be met with elsewhere; thus the Vasiṣṭhas and the Sunakas recognized Narāśameśa as their second *prayāja*-deity, while most of the septs invoked Tanūnapāt. The *āpṛisūktāni* ('propitiatory hymns') were different for each *gotra*; thus, e.g., that of the Sunakas was 'Agni is kindled,' that of the Vasiṣṭhas 'Enjoy our fuel,' etc.⁹ There was also diversity among the *gotras* as to the manner of cutting the sacrificial object (*havis*), the rice-cake. Among the Jāmadagnis the rule was to cut the cake in five pieces, among the other *gotras* in four. The practice of the Jāmadagnis was followed by the Vatsas, the Vidas, and the Arṣiṣeṇas, who are likewise referred to as *pañcāvatīnas*, 'making five cuts.'¹⁰

As to the question how far these differences among the *gotras* affected their participation in the sacrifice, the Brāhmanical tradition varies. According to one view¹¹—the more rigid—only those Brāhmanas who observed the same ritual, i.e. were *ekakalpa*, could take part together in a *sattra*.

¹ *Kātyāyana Śr. S.* iii. 2. 11; *Āśv. Śr. S.* i. 3. 5; *Āp. Śr. S.* xxiv. 10. 18; cf. Weber, p. 79.

² Weber, p. 82 ff.

³ Hillebrandt, *Rituallitteratur*, Strassburg, 1897 (*GIAP* iii. 2), p. 7.

⁴ i. 17. 18.

⁵ *Hiranyakeśin Gṛihya Sūtra*, ii. 6. 11; similarly, *Āpastamba*, vi. 16. 6, 7; *Vaikhānasa*, iii. 23.

⁶ Hillebrandt, p. 60.

⁷ Cf. R. Roth, *Zur Litteratur u. Gesch. d. Weda*, Stuttgart, 1846, p. 87 ff.; J. Muir, *Original Sanskrit Texts*, i. 2 317 ff.

⁸ *Kāty. Śr. S.* i. 6. 13, 14.

⁹ Devasvāmin to *Āśv. Śr. S.* xii. 10. 1; cf. Chentsal Rao, *op. cit.* p. 26.

¹⁰ Yāśhika Deva on *Kāty.* i. 9. 3; cf. Weber, *op. cit.* p. 96, and *SBE* xii. 192.

¹¹ *Āśv. Śr. S.* xii. 10. 1.

Since, as was noted above, each *gotra* had its own *āprīśūkta*, and since in the *prayāja*-formulæ some *gotras* recognized Tanūnapāt, others Narāsaṃsa, as the second *prayāja*-deity, then, if the partakers in the sacrifice should belong to different *gotras*, the appointed formulæ would not be in harmony with one another.¹ To this more stringent attitude, however, was opposed the view that the divergence of the *gotras* in such matters formed no obstacle to their joint performance of the sacrificial ceremony, inasmuch as the more important factor was community of rite,² and the minority must accommodate themselves to the majority; or else the participators simply follow the *kalpa* ('rule') of the *grihapati* ('householder').³

The gradual increase in the number of families laying claim to a common ancestor, and the uncertainty as to membership in a *gotra*, led with increasing frequency, as the present writer thinks, to a disregard of the condition that all participators in an *iṣṭi* ('sacrifice') should belong to the same *gotra*.⁴

The hypothesis that in an earlier age each *gotra* performed the religious rites by itself finds support in a passage of the *Maitrāyaṇī Saṃhitā*⁵ which refers to the preparations for a sacrificial assembly, and says explicitly that those taking part in the ceremony proceed by *gotras*: "Thou art a cover for every one"—with these words he sets up the roof; for they proceed *gotra* by *gotra*. Clear indications of the existence of a *sacrum gentilicium* may be discerned also in the fact that, in the *agnīṣoma*,⁶ the *samapīśvatas*, *amītyas* or *īśātis* ('relatives') of the person offering are invited to take part—his wife, sons, grandsons, and brothers: the Adhvaryu is grasped by the sacrificer, the latter by his wife, she by his sons, they by his grandsons, and these, finally, by the *īśātis*.⁷

As regards the *śrāddha*, the funeral rite performed in honour of the dead, likewise, it seems natural to suppose that joint-membership in a *gotra*—that of the dead—was a necessary condition of participation. The *Baudhāyana Gṛihya Sūtra*,⁸ in opposition to the *Dharmasūtra*, grants the possibility that the Brāhmins to be invited to the *śrāddha* might be connected by blood, *gotra*, learning, and virtuous conduct, and we may perhaps recognize here the older phase of the ritual.

In course of time there seems to have been evolved the regulation—given both in the *Grihyasūtras*⁹ and in the *Dharmasūtras*—that the Brāhmins to be invited should not be connected either by blood, or by *gotra*, or by *mantras*. It is nevertheless quite certain that the *gotra* was a far from unimportant factor in the *śrāddha*.

In the *śkoddiṣṭaśrāddha*, the funeral rite performed on behalf of a single individual, according to the *Śrāddhavidhi*¹⁰ a food-ball (*piṇḍa*) was offered to the departed, and his personal and *gotra* names were uttered along with the words, 'This food for thee!' According to the *Viṣṇu-Purāṇa*, the food offered by the proper persons to forefathers, with utterance of their names and *gotra*, became a meal for the *manes*.¹¹ Similarly, in the *udakakarman* ('libation of water') for the deceased, a handful of water was poured out, and his personal and *gotra* names were pronounced: e.g. 'Devadatta, of the Kāśyapa *gotra*, this is thy water.'¹²

But the diversity of *gotra* in relation to ritual had not so profound an influence upon practical life as had the rules prohibiting marriage between members of the same *gotra*, or intermarriage between certain groups of *gotras*. These singular and rigorous ordinances likewise seem to have been a growth of later times. In the *Rigveda* we find no prohibition of marriage between relatives. On the contrary, it would seem rather, as, e.g., from *Satapatha Brāhmaṇa*, i. 8. 3, 6, that marriages between members of the same family were of common occurrence in the ancient period. The union of men and women descended from the same ancestor, and

of blood-relations in the third and fourth degrees, is represented as being a general practice.¹ But even by the time of the *Grihyasūtras* we find that marriage outside one's own *gotra* had come to prevail: Gobhila² expressly says that a pupil who has completed his study of the Veda should, with his teacher's consent, take as a wife one who does not belong to his own *gotra*. Hīranyakeśin³ likewise recommends marriage with one of another *gotra*; and with this agrees the *Mānavagṛihya-sūtra*,⁴ which, however, expresses the regulation in different terms, requiring that the series of ancestors invoked in the sacrifices shall not be the same for both husband and wife.

The prohibition of marriage within one's own *gotra* had manifestly become the rule by the time of the *Dharmasūtras*: thus, in the code of Manu we find that a maiden who is not related by blood on her mother's side, and does not belong to the same *gotra* on her father's, is recommended to the twice-born as eligible for marriage and the community of the household ceremonies;⁵ Āpastamba⁶ forbids a father to give his daughter to a man of the same *gotra* as himself, while Gautama and Vasiṣṭha permit marriage only between those who have not the same *pravara*.⁷

Presumptive evidence to the effect that marriages within the *gotra* were prohibited in the 3rd cent. B.C. is found in the *Kauṭīliya*, the author of which, as we may assume on the ground of Jacobi's convincing elucidation, was the minister of Chandragupta, the founder of the Maurya dynasty.⁸ In that work the head of a house is charged to live by his calling, and to marry girls of his own caste, but of a different *gotra*.⁹

These requirements could not, of course, fail to affect the customs connected with marriage, and, more particularly, with courtship. According to *Sāṅkhāyana Gṛihya Sūtra*, i. 6. 4, the deputy-suitors when proposing marriage to a girl announced the *gotra* names of bridegroom and bride—obviously in order to show that there was no legal obstacle to the proposed union.

Nevertheless, it seems doubtful whether the regulations were strictly obeyed. It was at all events found necessary, even in theory, to grant exemptions: thus, certain *gotras* had the right to intermarry with all other families. These *gotras*, as we have seen, were above all the so-called Kevala (or separate) Bhārgavas and Āngirasas, belonging to the *gentes* said to be descended from Bhṛigu and Āngiras.

It was clearly no fortuitous or arbitrary circumstance that the right of exogamy should be conceded to the descendants of Bhṛigu and Āngiras in particular. The Bhārgavas and Āngirasas, in virtue of their relation to the *Atharvaveda*, were more closely allied to the warrior than to the Brāhman caste; even according to the Brāhmanical tradition they belong, together with the Kāśyapas and the Vasiṣṭhas, to the *mūla-gotrāṇi*, the original and truly ancient *gotras*; while the other *gotras*, as the *Mahābhārata* puts it, became great by the merit of their works.¹⁰ In this passage we light once more upon the antagonism that prevailed between certain *gotras*—an antagonism which was in no sense confined to the matters of ritual already referred to, but made itself felt also in political life. That rivalry for political supremacy was the main factor in the conflicts between the Vasiṣṭhas and the Viśvāmitras need hardly be doubted. The former were in possession of a secret doctrine, a *brāhmaṇam*—the twenty-nine *stomadhāga*-maxims—and it was on this account that the Bharatas always chose their *purohita* from among the Vasiṣṭhas.¹¹

The struggle for the influential and lucrative office of *purohita*,¹² the all-powerful adviser of the

¹ Devasyāmin on *Āśv. Śr. S.* (Chentsal Rao, p. 26).

² *Āśv. Śr. S.* xii. 10. 2.

³ *Sāṅkh. Śr. S.* xiii. 14. 5; *Lāṭyāyana Śr. S.* vi. 4. 15; cf. Weber, *op. cit.* p. 93 f.

⁴ For the opposite view, see Weber, *op. cit.* p. 94.

⁵ iii. 8. 9.

⁶ A sacrificial rite extending over several days in spring.

⁷ Cf. Hillebrandt, *op. cit.* p. 128.

⁸ W. Caland, *Altind. Ahnenkult*, Leyden, 1893, p. 20.

⁹ *Hiranyakeśin*, ii. 10. 2.

¹⁰ *Atharvaveda - Parīṣiṣṭa*, xlv. 1. 14 (ed. Bolling and v. Negelein, Leipzig, 1909, p. 280); cf. Caland, *op. cit.* p. 101.

¹¹ Cf. H. H. Wilson, *Works*, viii (London, 1866) 196 f.

¹² Gārgya Nārāyaṇa to *Āśv. Śr. S.* iv. 4. 10.

¹ Weber, p. 75 f.

² iii. 1-4.

³ i. 19. 2.

⁴ i. 7. 8.

⁵ Manu, iii. 5. For the divergent interpretations of the commentators, cf. G. Bühler, *SBE* xxv. 75, note.

⁶ ii. 11. 15.

⁷ Gautama, iv. 1-5; Vasiṣṭha, viii. 1.

⁸ H. Jacobi, 'Über die Echtheit des Kauṭīliya,' *SBAW*, 1912.

⁹ H. Jacobi, 'Kultur-, Sprach-, u. Literaturhist. aus d. Kauṭīliya,' *SBAW*, 1911, p. 956.

¹⁰ *Mahābh.* xii. 298. 17 f.

¹¹ Weber, p. 84.

¹² *Tāṇḍyamahābrāhmaṇa*, xii. 8. 6; Pischel and Geldner, *Ved. Studien*, iii. (Stuttgart, 1901) 6; cf., on the *purohita*, R. Fick,

monarch and the ruler of the national fortunes, seems to have intensified the mutual antagonism of the *gotras*. While the Vasiṣṭhas, by reason of their knowledge of the *stomabhāga*-maxims, seemed to the Bharatas the most eligible candidates for the office, other *gotras* also made the same claim on the ground of their distinctive scholarship, as, e.g., the Ātreyas¹ on account of their familiarity with the *Rigveda*, the Kāśyapas on account of their knowledge of the *Sāmaveda*, and so on. To each *gotra* pertained a particular deity and a particular Veda.² It is obvious that the followers of the *Atharvaveda*, the magic songs of which are in very many cases designed to meet the needs of kings, had the best chances in the competition for the post of *purohita*. As the *Atharvaveda* was associated in the closest way with the warrior caste,³ the *gotras* which adhered to that work stood in the most intimate relations with the king. In the *Parīṣiṣṭas* to the *Atharvaveda* the claim of these *gotras* to the office of *purohita* is vindicated in the most positive terms against the rivalry of the others:

Let the prince who would conquer the whole world in a just manner choose as his teacher (*guru* = *purohita*) a Bhārgava endowed with learning and good qualities. An adherent of the *Rigveda* (*bahurīcha*) surely destroys his kingdom; an adherent of the *Yajurveda* (*adhvaryu*) would bring his sons to ruin; an adherent of the *Sāmaveda* (*chhandoga*) would occasion loss of fortune; and therefore let the teacher (i.e. the king's *purohita*) be an adherent of the *Atharvaveda* (*ātharvaṇa*). Whosoever through ignorance or negligence has an adherent of the *Rigveda* as teacher suffers the loss of country, supremacy, city, and minister—of this there is no doubt; or, if a king appoints an adherent of the *Yajurveda* to be his *purohita*, then, when his money and his property are gone, he will be speedily killed by force of arms. As little as a palsied man [makes] his way, as little as a wingless bird [reaches] the ether, just as little does a king attain to power and honour by having as his teacher an adherent of the *Sāmaveda*. If the teacher be a Paippalāda,⁴ who knows the [*Atharva*]Veda, the kingdom will increase in money and corn: of this there is no doubt.⁵

If we may assume from the foregoing that the *gotras* tracing their descent to Bhṛigu and Āngiras were closely connected with the warrior caste, whether in virtue of their standing as *purohitas* or in virtue of blood-relationship, we have, on the other side, good reasons for supposing that the Kṣatriyas and, more particularly, the princely families of ancient India were regarded as belonging to the *mūlagotrāṇi*.

In accordance with the Brāhmanical theory, as already noted, the priest, when performing a sacrifice offered by a king, named either the *rājarṣi* ancestors of the king himself or the ancestors of his *purohita*. If sometimes the arrogance of the priests led them to regard their own ancestors as more worthy to be named than the king's, yet the inference that some have drawn from this, viz. that the *gotra* of the *purohita* was transferred to the king whom he served, must be rejected without qualification.⁶ When the Buddha, a scion of the Śākya family, called himself Gautama, it was not because among the Śākyas the office of the *purohita* was vested in the Gautama sept, but because the Śākyas traced their origin to Gautama, the descendant. *Die sociale Gliederung im nordöstl. Indien*, Kiel, 1897, pp. 107-117.

¹ The *gotra* of the Ātris was held in special honour; cf. Weber, p. 89.

² This is still the case at the present day. In a modern list (*Gotravali: A list of Brahman Gotras*, Allahabad, 1894) we find the following categories attached to each *gotra*: *veda*, *upaveda*, *śākhā*, *sūtra*, *pravara*, *śikhā*, *pāda*, *devatā*; thus, the Bhāradvāja *gotra* has as its *veda* the *Yajurveda*; as its *upaveda*, the *Dhānurveda*; as its *pravara*, Āngirasa, Bārhaspatya, Bhāradvāja; as its deity, Śiva.

³ Cf. M. Winternitz, *Gesch. der ind. Litteratur*, I. (Leipzig, 1908) 128.

⁴ A member of one of the nine schools into which, according to the *Charapanyūha* (xliv. 4. 1), the adherents of the *Atharvaveda* were subdivided.

⁵ *The Parīṣiṣṭas of the Atharvaveda*, II. 2. 5; 4. 2-5; 6. 1, ed. Bolling and v. Negelein, I. (Leipzig, 1909) 49 f.; cf. *ZDMG* lxx. (1911) 840 f.

⁶ Cf. Weber, pp. 78, 79; Oldenberg, *Buddha*, Berlin, 1881, p. 421; *Dialogues of the Buddha*, tr. T. W. Rhys Davids (*Sacred Books of the Buddhists*, II.), London, 1899, p. 195 f.

ant of Āngiras, and because they prided themselves on belonging to that *mūlagotra*, and in the fact that their family acted as custodians of the religious traditions connected with the name of Gautama. Not only the Buddha himself, but also his father, and even his cousin Ānanda, were addressed as Gotama; while Mahāpajāpati and her sister Māyā, both belonging to the Śākya family (*kula*), bore the name Gotami.¹ That it was customary, in addressing the individuals in question, to use, not the *kula* name (Śākya), but the *gotra* name (Gautama),² shows how high a value was set—precisely in the ranks of the *Khattiya* (*Kṣatriya*)—upon membership in one of the ancient *gotras*. This finds expression also in a verse which frequently recurs in Buddhist *Suttas*: 'The Khattiya is regarded as best among people who set a value on *gotta*.'³

For an adherent of Buddha's teaching, who chooses to renounce the world, the privilege of belonging to a *gotra* signifies, of course, as little as caste. When the Brāhman Sundārika of the Bhāradvāja *gotra* asked of the Blessed one a question regarding his *gotra*,⁴ the latter replied:

I am not a Brāhman, or the son of a king, or a Vessa (Skr. Vaiśya); having taken as [my] *gotra* [that] of common people, I wander about in the world, without possessions, meditating. Clad in a *saṅghāṭi*, I wander about houseless, with my hair shorn, tranquil, not consorting with men in this world. Inopportunistly, O Brāhman, dost thou make inquiry of me regarding my *gotra*.

Still, the disparagement thus cast upon the *gotta* does not in the least alter the fact that the followers of Buddha were for the most part of eminent lineage, springing from princely, Brāhmanical, and other distinguished families, and that accordingly such *gotra* names as Opamañña, Kanhāyana, Moggallāna, Kassapa, Kaṇḍarāyana, Kondañña, Vāseṭṭha, Vessāyana, Bhāradvāja, and Vachchhāyana occur in the Pali Canon with special frequency.⁵

That the *gotras* were in no sense a purely Brāhmanical institution is borne out, further, by the sacred writings of the Jains. Mahāvīra, the founder of this sect, and, like Buddha, a member of the *Kṣatriya* caste—the feudal aristocracy⁶—belonged to the Kāśyapa *gotra*; and, of course, Siddhārtha his father, Supārśva his paternal uncle, Nandivardhana his eldest brother, and Sudarśanā his eldest sister were all likewise Kāśyapas. On the other hand, Trīśālā, the mother of Mahāvīra, was of the Vasiṣṭha *gotra*, Yaśodā his wife a Kaundinyā, while his daughter, who, while still unmarried, was, of course, a Kāśyapa, passed by marriage into her husband's *gotra*, and her daughter, the grandchild of Mahāvīra, was of the Kauśika *gotra*.⁷ Thus the traditions of the Jains likewise lead us to infer that the Kṣatriya families set as high a value upon *gotra* as did the Brāhmins, and that they observed the injunction against marriage within the *gotra*;

¹ In the *Suttavibhaṅga*, Pācchittiya II. 2 (*Vinaya Piṭaka*, ed. Oldenberg, IV. 6 f.) the Gotama *gotra* (Pali; Skr. *gotra*) is ranked among the higher, and others, as, e.g., the Bhāradvāja *gotra*, among the lower (cf. Oldenberg, 'Zur Gesch. des ind. Kastensystems,' in *ZDMG* li. (1897) 281 f.). The fact that the *Sutta-Nipāta*, III. 1, line 423, gives Adichchā (=Skr. Āditya, the sun-god) as the *gotra* name of Buddha probably implies no more than the claim of a Divine origin for the Śākya family.

² On the use of the *gotra* (*gotra*) name instead of the personal name, cf. the examples quoted by Rhys Davids, *op. cit.* p. 195 f. Examples of the practice are found also in the *Jātakas*; thus, in the *Sarabhaṅgajātaka* (*Jāt.*, ed. Fausböll, v. 125 ff.), Sarabhaṅga the ascetic is addressed by his *gotra* name Koṇḍañña (=Skr. Kaundanya); and in the *Alambusajātaka* (*Jāt.*, ed. Fausböll, v. 152 ff.), Isisīṅga (=Skr. Rīśyaśīṅga) by his *gotra* name Kassapa (Skr. Kāśyapa). In Sanskrit poetry it is a favourite rhetorical device to let the husband or lover make the mistake of addressing his wife or sweetheart by the name of some other mistress; cf. *Kumārasambhava*, IV. 8. Similarly, *Raghuvamśa*, XIX. 24; *Vāsavadattā*, tr. Gray, New York, 1913, p. 66. These passages likewise seem to the present writer to imply that it was the custom to address a person by his *gotra* name.

³ Oldenberg, *Buddha*, p. 421; cf. B. Fick, *op. cit.* p. 58.

⁴ *Sutta-Nipāta*, III. 4, ed. Fausböll, pt. I. p. 80.

⁵ Rhys Davids, *op. cit.* p. 193.

⁶ Cf. *Jaina Sūtras*, tr. H. Jacobi, pt. I. (*SBE* xxii. (1884) p. xlii f.

⁷ *Id.* 193 f.

for the family of Mahāvira was connected neither by *gotra* nor by *pravara* with the two families with which, as just indicated, they intermarried.

In the list of the Sthavira,¹ the earliest adherents of Mahāvira, we find, of *gotras* known to us from the Brāhmanical literature, the following: Agnivesyāyana, Kāśyapa, Kātyāyana, Vatsa, Tuṅgikāyana, Māthara, Prāchīna, Gautama, Ailāpatya, Vasiṣṭha, Vyāghrapatya, Kauśika, Utkriṣṭa, Bharadvāja, Kuṇḍala, Hārīta, Kautsa, and Suvrata. Now it is certainly worthy of note that a large number of the *gotras* enumerated in this list, and in the list from the Pali Canon given above, belong by origin to the Aṅgīrasas, or else, *e.g.*, the Vatsas, trace their descent to Bhṛigu; while others, such as the Vasotthas (Vasiṣṭhas) and Kondañhas (Kaundīnyas), claim to be descendants of Vasiṣṭha, or—as the Kassapas (Kāśyapas), Opamañhas (Aupamanyas), Mogañānas (Maudgalyānas)—of Kāśyapa, so that the great majority of the *gotras* in question fall within the group of *mālagotrāṇi*. The Kauśikas alone trace their descent to Viśvāmitra, while descendants of Atri or Agastya, so far as the present writer has observed, are never mentioned among the followers of Buddha or Mahāvira, either in the Pali Canon or in the Jain literature.

In the inscriptions of the *stūpa* of Bhārhut, the donors of the various gateways and pillars are mentioned by name, and in their names we find the same linguistic elements as appear in the names given by the Pali Canon,² *i.e.* names of places, persons, and *gotras*, as also metronymics—the latter, again, being compounds of a *gotra* name with the word *putra* ('son').³ They are mainly names of kings, and the annexed metronymic serves, by means of the mother's *gotra* name, to distinguish a particular king from other sons of his father.⁴ The *gotra* names occurring in such metronymics are names like Gārgya, Kautsa, and Vatsa, and thus the *gotras* here concerned are those found, as we saw above, if not exclusively, yet with unusual frequency, in the ranks of the Kṣatriyas.

In addition to the Kṣatriyas, however, isolated members of the third caste—wealthy Buddhist laymen—are also mentioned in the inscriptions, as donors. But in these cases the *gotra* name is not added. Nevertheless, the present writer is inclined to think that even here the theory according to which, as we have seen, both *gotra* and *pravara* had a recognized place in the Vaiśya as in the higher castes corresponds with the actual facts. We must certainly not attach too much importance to the case of the potter with the *gotra* name Bhaggava mentioned in the *Kumbhākara-Jātaka*;⁵ but it is to be noted that the Kumhars, the modern potter caste of Bengal, Behār, and Orissa, have *gotras* with such Brāhmanical names as Kaundīnyā, Kāśyapa, etc.;⁶ and, further, when we read in the *Sutta-Nipāta* (ii. 7. 32) not only of the *Khattiya* and the *Brahmabandhu*, but also of others, as being protected by their *gotra*, we seem to be forced to the conclusion that these *gotra-rakkhita* were eminent middle-class families.⁷

3. *Gotra* in India at the present day.—Just as the system of caste, in its main features (endogamy and hereditary calling), survives unchanged to the present day, so the state of things in relation to *gotra* is, among the Brāhmins at least, the same to-day as it was in ancient times. The Brāhmanical *gotras* are still eponymous sections named after the Vedic *ṛiṣis*, and each section is exogamous. Among the Brāhmins, as in the inferior castes, blood-relationship is traced in the male line, and carefully constructed tables of the degrees of relationship have been prepared for the purpose of guarding against prohibited unions,⁸ while evidence is adduced at marriage to show that bride and bridegroom are not related within the forbidden degrees. It is obvious that the observance of the religious ceremonies in which the Brāhmin was required to pronounce the names of his ancestors must have tended to keep the *gotra* system essentially unchanged; as every Brāhmin repeats his *pravara* three times a day—at morning, noon, and evening prayer—the fact of his belonging to a certain *gotra* is constantly kept before him. How far the prohibitions of marriage which are based upon *gotra* and *pravara* are still observed among the Brāhmins would seem, how-

¹ *Ib.* p. 286 ff.

² Cf. Rhys Davids, *op. cit.* p. 193 f.

³ A. Cunningham, *The Stūpa of Bhārhut*, London, 1879, p. 128 ff.; cf. J. F. Fleet, *The Dynasties of the Kanarese Districts of the Bombay Presidency*, Bombay, 1882, p. 5 note 2, p. 9.

⁴ 'The usage of calling sons after their mothers was caused not by polyandry, but by the prevalence of polygamy, and it survives among the Rajputs to the present day' (Bühler, in a letter quoted by Cunningham, *op. cit.* 129).

⁵ *Jāt.*, ed. Fausbøll, iii. 382.

⁶ Cf. Frazer, *Totemism and Exogamy*, ii. 316 f.

⁷ On the *gahapati*, cf. R. Fick, *op. cit.* p. 164.

⁸ W. Crooke, *Natives of Northern India*, London, 1907, p. 207; J. Jolly, *RecAt u. Sitte*, p. 63.

ever, to be largely a matter of local distinctions.¹ P. Chentsal Rao, in the work already cited,² writes on this point as follows:

'No case has as yet come before the courts in which the question of the validity of a marriage between Brāhmins belonging to the same *Pravara* or *Gotra* is involved; but when a case of the kind does come before them, as no doubt it will sooner or later, they will have to consider whether by a too rigid enforcement of an ancient rule which has lost, by change of circumstances, much of its meaning, they will not be throwing obstacles in the way of the progress of the community.'

So far as the India of to-day is under the influence of Hinduism and dominated by Brāhman culture, so far likewise has the *gotra* system gained a footing, even in the non-Brāhman castes. The Rajputs, who claim to be the legitimate successors of the Aryan Kṣatriyas, are divided into a great many clans or tribes, each tracing its origin to some ancestor of renown; many of them even boast of a Divine origin, as, *e.g.*, the Suryavaṁśī, who trace their descent to the sun, and the Somvaṁśī, who similarly claim to be the offspring of the moon.³ The Rajputs, taken as a whole, *i.e.* a caste, marry only within their own ranks; no Rajput may marry a woman who is not of the Rajput class. In the several clans, however, the system of exogamy is so constituted that the males must find their wives in clans other than their own. Thus a man of the Rathore clan must not marry a woman of even the most distantly related families bearing the Rathore name; and, should he defy this ordinance, the children of the marriage are not accounted pure Rathores.⁴

The Jāts, who likewise consider themselves to be descendants of the Kṣatriyas, and in many respects stand on an equality with the Rajputs, are as a tribe strictly endogamous, but they resemble the Rajputs also in being divided into *gentes* or *gots*, and these, again, are exogamous. The Deswal, Man, Dalal, and Siwal *gentes* of the Jāts are of common descent, and must not intermarry; and the like holds good of the Mual, Sual, and Rekwā *gentes* of the Rajputs.⁵

The question whether the totemism that is so characteristic of the lower Indian *gots* prevails also among the superior races of the Panjāb, *i.e.* whether the latter also observe certain tabus regarding plants, animals, or other objects revered by them, is difficult to answer with absolute certainty. In reference to this point H. A. Rose writes as follows:

'A few instances have apparently survived among the Aroras, and there are possibly stray cases among the Jāts of the south-eastern plains, the Gujars, Rajputs, and other castes, even the Khātris, but the evidence is not conclusive, for little but the names remain, the instances of respect paid to the totem itself being few and uncertain.'⁶

Much more distinct traces of totemism are met with among the highly organized Vaiśya castes, as, *e.g.*, the Komāṭis, the great trading caste of Mysore. If an individual of this caste wishes to eat a fruit which is tabu for him, he may do so only on condition that he performs every year in Gayā (*g.v.*) the funeral ceremonies for his totemistic ancestor.⁷ The more highly developed—the more completely Hinduized—a caste is,⁸ the more do its *gotras* resemble the eponym *gotras* of the Brāhmins, and we may venture to believe that the resemblance is due not so much to an actual community of descent

¹ 'A Sakaldipi Brahman, *e.g.*, of South Behar, may marry within his Gotra.' 'A marriage may take place among the Saraswats of the Panjab within the Gotra' (Jogendra Nath Bhattacharya, *Hindu Castes and Sects*, Calcutta, 1896, pp. 48, 56).

² Preface.

³ Jogendra Nath Bhattacharya, *op. cit.* 186; cf. A. O. Lyall, 'The Rajput States of India,' in *Asiatic Studies*, London, 1882, p. 200: 'It does not follow because a tribe claims its descent from a god that the divine founder is a personage entirely mythical. He is quite as likely to be a real hero deified.'

⁴ A. O. Lyall, *op. cit.* p. 219.

⁵ Frazer, *op. cit.* p. 283.

⁶ *CJ*, 1901, xvii.; *Punjab, its Feudatories, and the North-West Frontier Provinces*, pt. I., Simla, 1902, p. 232; cf. Frazer, *op. cit.* p. 283.

⁷ Frazer, *op. cit.* p. 241.

⁸ As, *e.g.*, the Baniyās of North India, amongst whom the Agarwāls claim to be the true representatives of the Aryan Vaiśyas (cf. Jogendra Nath Bhattacharya, *op. cit.* p. 206).

as to the desire of complying with the rules formulated by the theory.

Among the lower Hindu castes and the indigenous hill-tribes, and especially among the Dravidian peoples of S. India, we find almost universally a system of subdivision into small exogamous groups—in part also known as *gots* (= *gotras*)—akin to that of the Brāhmanical *gotras*.¹ They resemble the Brāhmanical clans in recognizing descent in the male line, so that children belong to the father's *gotra*, not the mother's, while a woman passes by marriage into the *gens* of her husband, and persons of the same *gotra* cannot marry one another. These groups are distinguished from the *gotras* of the higher castes, however, by their undisguised adherence to totemism. Each of the exogamous clans bears the name of an animal, tree, plant, or some other natural or artificial object, and the members of the clan are not allowed to eat, to cultivate, to burn, to carry, or in any other way to make use of that particular object. Thus—to give a few specially characteristic examples—all the Bhils venerate totems, and avoid injuring or using them, and, when they pass their totem, they make a ceremonious bow, while the women veil their faces. Of the Bhils, the Ava clan takes its name from its totem, the moth, and its members do not injure moths. Among the Gollas, a large shepherd caste of the Telugu people, the members of the *gotra* called Raghindala (*Ficus religiosa*) are prohibited from using the leaves of the sacred fig-tree as plates for their food. Of the exogamous *gotras* of the Kurabas—a caste of peasants, shepherds, weavers, and masons—who are said to be of totemistic origin, and retain their totemistic character to the present day, the Arisāna *gotra* is of peculiar interest. The name 'Arisāna' means 'saffron' (turmeric), which was originally tabu to them; but, as this led to much inconvenience, they substituted the *korra* grain for saffron, though still retaining the original name of their *gotra*.²

4. Origin of the *gotras*.—The sociological sense of the term *gotra* has been derived from the Vedic usage ('cow-stall') as follows. In ancient times the Indian family, even when—in consequence of its numerical increase—its property had been greatly subdivided, would still continue to use and occupy jointly the land reserved for grazing cattle; and we may therefore conclude, it is said, that the Brāhmanical *gotra* was in its origin simply a community of this kind, i.e. a family whose members enjoyed joint-rights in a particular pasturage.³ But this hypothesis does not in any degree account for the most characteristic features of the *gotra*, which, in fact, can be explained only by comparison with the *gots* of the aboriginal tribes of India.

In view of the remarkable correspondence which, notwithstanding fundamental differences, exists between the eponymous Brāhmanical *gotras* and the totemistic *gots* of the inferior castes, the question naturally arises whether, as is the case with caste,⁴ the structure of the *gotra* system, too, is in some degree the result of an inner connexion, a process of reciprocal influence, between the higher and the lower races. It is certain, for one thing, that the Brāhmanical theory—the desire on the part of the lower races to observe its regulations, and in this way to invest a particular caste with a higher dignity—has tended to assimilate the *gots* of the lower castes and the native tribes to the Brāhmanical *gotras*. But, conversely, the latter seem to have acquired their peculiar character only by contact with the Dravidian tribes; for, as the practice of exogamy is the common

¹ The corresponding term in Telugu is *intiperu*; cf. Frazer, *op. cit.* p. 236.

² Frazer, *op. cit.* p. 245.

³ G. Sarkar, *Hindu Law*², p. 50.

⁴ R. Fick, *op. cit.* p. 215.

feature of all *gotras*, whether of the higher or of the lower castes, and as it finds no mention in the Veda,¹ it must have come to prevail only after centuries of development, and possibly as a result of the fusion of Aryan and Dravidian tribes. Now, exogamy is intimately related to totemism, and might gain ground even among the Brāhmanical *gotras* all the more easily because totemistic ideas, whether inherited from remote ages or adopted from the aboriginal peoples, were not unknown among the Brāhmins themselves. Among the names of peoples found in the Veda, a number are taken from animals and plants, as, e.g., the Matsya (fishes), the Aja (goats), Sigrū (horse-radish), etc. Of the Brāhmanical *gotras*, the Kāśyapas, whose name signifies 'tortoise,' trace their origin to a being closely connected, or even identified, with Prajāpati; their tribal ancestor was Kūrma—another word for 'tortoise'—in whose person Prajāpati formed all created things. The legendary progenitor of the Sagarid *gens*, King Ikṣvāku, whose name means 'gourd,'² and seems to point to a tabu relating to this fruit, is a descendant of Kāśyapa. The *gotra* of the Kaundinyas, which traces its descent from Vasiṣṭha, and to which belonged, as we saw above, the wife of Mahāvira, the founder of the Jain sect, takes its name, as does the *gotra* of the Kapis, from the ape; and in the passage of the *Kacchapa-jātaka*³ where it is said to the tortoise which had fastened upon the genital parts of an ape, 'Tortoises are Kāśyapas, apes are Kaundinyas; Kāśyapa, let go the Kaundinya, thou hast effected copulation,' we have an allusion—in terms of the beast-fable—to the matrimonial relations subsisting between the two human families.⁴ If, then, as seems probable from the foregoing, totemistic ideas were not unknown among the ancient Indian *gotras*, it becomes quite intelligible that ancestor-worship and exogamy, as found among the less civilized aborigines, should have come to prevail in these *gotras* as well. For, while the dissemination and pervasive influence of Brāhmanical culture in the conquered country is a fact beyond dispute, we must nevertheless not forget that, on the other hand, the primitive usages and ideas of the native races did not fail to operate profoundly upon the culture and development of the conquerors themselves.

LITERATURE.—F. Max Müller, *Hist. of Ancient Sanskrit Literature*², London, 1860, pp. 378–388; A. Weber, 'Collectanea über die Kastenverhältnisse in den Brāhmana u. Sūtra,' in *Indische Studien*, x. (Leipzig, 1868) 1–160; A. Ludwig, *Der Rigveda, ins Deutsche übersetzt*, iii. ('Die Mantralitteratur u. das alte Indien'), Prague, 1878; J. Jolly, *Recht u. Sitte*, Strassburg, 1896 (GIAP ii. 8); P. Chentsal Rao, *Gotrapravaranibandhakadambam: The Principles of Pravara and Gotra*², Mysore, 1900 (Gov. Orient. Libr. Ser. Bibliotheca Sanskrita, no. 25); G. Sarkar, *Hindu Law*², Calcutta, 1903; J. G. Frazer, *Totemism and Exogamy*, II. (London, 1910) 218–336, 'Totemism in India.'

R. FICK.

GOVERNMENT.—In the treatment of this subject, attention has usually been directed to three main problems: (1) What is the origin of government? (2) In whose hands may the authority be vested, and in what way may its machinery be best exercised? Or, more shortly, What are the forms of government, and which is the best? (3) What is the sphere of government, or when is State interference justifiable? The last of these is a question comparatively new in the history of political discussion.

1. The origin of government.—Since, in the light of modern historical criticism, men like Lycurgus, Solon, and Numa Pompilius appear, not as the inventors of new laws, but rather as the

¹ The passage of the *Satapatha Brāhmana* already cited, in fact, directly implies the practice of marriage between blood-relations.

² Cf. Böhtlingk-Roth, s.v. 'Ikṣvāku.'

³ *Jāt.*, ed. Fausböll, II. 360.

⁴ Cf. Oldenberg, *Relig. d. Veda*, Berlin, 1894, p. 86.

reformers and codifiers of laws and customs already existing, we may set aside as legendary the accounts which the celebrated States of antiquity have given of their constitutions (wherein they ascribe these to the work of a single individual); and we find that three main theories, not very rigidly separated from one another, have been suggested of the foundation of sovereignty and the origin of government, or, in more general terms, the establishment of civil society. Of these, the first (a) traces government to the Deity. Of a State created by God and under His direct supervision this theory obviously affords a complete explanation, but it also applies to States which were only in an indirect sense thought of as founded by the gods and governed by them. Another form of this theory bases temporal sovereignty on a Divine right. The second main theory (b) founds government and sovereignty on the consent of the people expressed in an unwritten contract between them and their chosen sovereign, wherein they have reserved to themselves the right of resistance should he abuse the authority they have entrusted to him. According to the third and more modern view, (c) government is based upon expediency, and may be traced through different stages of development.

(a) The typically theocratic State (the word 'theocracy' first appears in *Jos. c. Apion*, ii. 17) is that of the Jews, which in the narrowest sense was the work of God's hand, and, by the conditions of its existence, was wholly sacred and inviolate. Founded by Jahweh and directly governed by Him, its kings were no more than His servants, who, being guided by His prophets, enjoyed no personal right of initiative. In this attitude, however, to their Creator, and in respect of the covenant which they had made with Him, the Hebrew people stand practically alone in history,¹ so that theirs may be looked upon as a State of a unique kind. With the Greeks and Romans it was different. There seems to have been a tendency to ascribe a supernatural descent to kings in Hellas, while in Rome they were usually chosen by popular election; but the people of both races, while believing in a Divine guidance, and seeking habitually by various rites and sacrifices to know the will of the gods and to propitiate their favour, yet looked upon this government as indirect and the State as a human institution, which men had great power to make or to mar. It cannot be said to have been otherwise regarded in the Middle Ages, although the tendency of mediæval opinion was to trace all power to God. For this was done in a spirit of piety, with no suggestion of a political theory: Church and State were held to be separate as Christ had separated them. After the Reformation it became common to read into certain lines of the NT a glorification of temporal sovereignty (1 P 2¹³). St. Paul required that every soul should be subject to the higher powers, for these are ordained, he said, of God (Ro 13¹). Forgetting that the Apostle referred to Nero, an Emperor of Rome who owed his election to a section of the people, forgetting, too, the words of Christ Himself (Mt 22²¹), the theologians of the time based upon this and similar passages, which exhorted the converted to good citizenship, a doctrine that kings and rulers were the anointed representatives of God, divinely appointed and responsible to none. See art. DIVINE RIGHT.

(b) Political absolutism, in the form in which it brought sorrow and misfortune to the Stuart kings, was defended as a philosophical theory by Hobbes,

¹ This statement is not substantially affected by the analogies between the religious conceptions of the Hebrews and their Semitic neighbours which are pointed out by W. B. Smith (*Prophets of Israel*, London, 1882, p. 49 ff.).

who incorporates with these principles the celebrated doctrine that civil society owes its existence to a contract. The social compact theory was supported later by Locke and Rousseau, their version of the theory differing in some minor points from that expounded by Hobbes. The latter held that the covenant to form a society was between man and man, and not between the people and the sovereign they chose to govern them. This left the way open for the assertion of a Divine right in the king, which necessarily implies passive obedience in the people. But absolutism like this, said Locke, is no form of civil government at all (*On Government*, ii. § 90). 'No man in civil society can be exempted from the laws of it' (§ 94). The original contract was between sovereign and people, the latter giving up their natural liberty and submitting themselves to a chosen ruler, who, on his side, agreed to rule justly, and in accordance with fixed laws publicly established; only so long as he did his part were the subjects bound to give obedience and loyalty (§ 131). Finally, in the people there lay a supreme ultimate power to alter the legislature.¹ The principle of the contract is sometimes put in another way, as by Locke (§ 97), and in the general tenor of the *Contrat social*: every man on joining a society tacitly promises to submit to the determination of the majority—the only condition on which the original contract can have any meaning. Hooker puts it thus:

'Men knew that . . . strifes and troubles would be endless, except they gave their common consent all to be ordered by some whom they should agree upon: without which consent there were no reason that one man should take upon him to be lord or judge over another' (*Eccles. Pol.* i. x. 8).

The contract theory, in the form in which it asserts the sovereignty of the people, dominated political thought during the 18th cent., and has in its time furnished argument and backbone for several successful revolutions. No one would now attempt to claim for this contract any historical justification whatsoever. The compact is not a fact, but an idea of reason—one of those ideas which we read into things to explain them (Kant, *Werke*, ed. Rosenkranz, Leipzig, 1838–42, ix. 160). No State of whose history we have record is known to have been founded in any such manner; and the further back we go the less the consent of the people would seem to have been sought and their wishes regarded in questions of a political nature. Consent has, of course, rightly been called one of the most sacred foundations of government. Physical superiority being usually on the side of the numerical majority, the many are controlled by the few, only because public opinion supports the rulers. Without the consent of the people no government can stand; by force alone no society can be held together. 'The stronger is never strong enough to be always master, if he does not transform his force into right and obedience into duty' (Rousseau, *Contrat social*, I. iii.). In this sense society really does depend upon a contract of a kind.

(c) While neither the theory of Divine right nor the theory of contract affords in itself any satisfactory explanation of the origin of government, the second is built upon what seem to be facts concerning the beginning of society. On these facts is based also the third theory, which founds government on expediency. Whether we follow Aristotle in thinking that man is by nature a social being, or hold with Hobbes that his disposition is anti-social, whether we suppose that the state of nature was one of peace (as Rousseau asserts) or a war of all against all, in the fact of the establishment of society there seems to be sufficient proof that this state of nature was one

¹ On the question of a so-called right or a moral duty of resistance, see REVOLUTION.

not satisfying to primitive man. Where there is perfect freedom, all are equal and subject to nobody; one man is king as much as another (Locke, ii. § 123). But the individual stands alone against the world; his property and person can be ill defended. Thus, as Locke says, 'government is hardly to be avoided amongst men that live together' (§ 105); it arises, since no human being is self-sufficing, 'out of the needs of mankind' (Plato, *Rep.* ii. 369).

We find man, then, being drawn into union with his fellows either through love of his kind or through love of himself. Outside of society certain instincts of man's nature, good and bad, remain unsatisfied, and only within it can his various powers be developed and his love of approbation, his desire to excel, be gratified. Historical inquiry has made it clear that no proof can be brought forward of any contract having been drawn up at this time; on the other hand, its results throw some light on the beginning of government. The statement is found in Aristotle that primitive society shows us nothing but kings and monarchies, and that for this reason all nations represent the polity of their gods as monarchical (*Pol.* I. ii.). He tells us, too, that at an earlier period still, before the State was established, patriarchal government was universal, and that this institution was generally the result of military necessity. The first of the needs of primitive man is the means to defend himself against attack. Thus, we may conclude that the father of a family or head of a tribe was at first chosen by his kinsmen as a leader in battle against other tribes. In times of peace he was its judge, and at all times he acted as priest to discharge the religious duties of his tribe. People grew accustomed to this exercise of authority, and the office was made perpetual. The leader was now called king.

The course of this development has been observed in many savage tribes. Aristotle saw it even among his own race:

'Kings at Lacedaemon are merely military commanders in expeditions beyond the frontiers, and enjoy also as their prerogative the superintendence of religious observances. This form of kingship may be described as nothing more than an absolute and perpetual generalship' (*Pol.* III. xiv.).

It was not kingship at all according to mediæval ideas, for it conveyed the power of life and death only in the field. But, in this incomplete sovereignty of the Lacedæmonian State, and in the organization of other polities lower in the scale of civilization, we have historical proof that government, in the case of these States or tribes, was indeed a question of pure expediency, arising out of man's first necessity—that of defending himself against attack. It needs the exercise of no great credulity to conclude that, in the case of States of whose early existence we have no record, government has been evolved in a similar manner.

2. The form of government, or the manner in which the sovereign powers of the nation are vested and exercised.—On the question of the various forms of polity there has been comparatively little difference of opinion since the time of Plato and Aristotle. The latter (*Pol.* III. vii.) makes the following classification, based upon the discussions of his predecessor. There are, he says, three pure or normal forms of government—*kingship*, *aristocracy*, and *polity* (or, to adopt Sidgwick's tr. of the term *πολιτεία*, constitutional government)—all of which have regard to the good of the community, and use the sovereign power for that end. To these correspond three perverted forms, or corruptions of normal polities, viz. *tyranny*, *oligarchy*, and *democracy*, in which the power of the State is used in the private interest of the rulers. Thus, in oligarchy, the rich, usually a wealthy minority, rule in their own

interest; in democracy this is done by the poor (viii.). In like manner, a tyrant uses his power only for his own ends. The government of a State is called a monarchy, an oligarchy, or a democracy, according as the supreme authority is vested in one person, in a few persons, or in many (vii.).

A government, however, is not always consistently in spirit what it is in name. Frederick the Great regarded himself as a servant of the State; in democratic Athens, Pericles ruled as a king. Where the government of a republican country slips, as it often does, into the hands of some one leading man, or, perhaps, of a few leading men, we have no longer pure democracy, but rather an aristocracy or monarchy. Hobbes seems to deny the possibility of a pure democracy when he says (*de Corpore Politico*, ii. 5): 'A democracy in effect is no more than an aristocracy of orators interrupted sometimes with the temporary monarchy of one orator.' Indeed, in every polity it is in effect the strongest who rule. But the Aristotelian classification still holds good, although the further objection has been made to it that it takes for granted a distinction between governor and governed which has not always been very clearly marked. In a democratic State the power is constantly changing hands; in an aristocracy, too, the same men may now rule, now fall back into the ranks of those who obey. Considerations like these have caused several writers—Rousseau among them—to give to the word 'republic' a very wide meaning indeed. For Rousseau it signifies not 'an aristocracy or democracy only, but in general all governments directed by the public will which is the law,' the necessary condition being that government should be regarded, not as identical with the sovereign power, but as the administrator of that power, in which case monarchy itself becomes a republic (*Contrat social*, ii. 6, footnote). Distinctions are thus sometimes lost sight of, both in theory and in practice; still, the form of the supreme power does give a distinctive stamp to the political life of a State, because, if for no other reason, it determines to a great extent the limitations of a State's activity.

The familiar terms which are employed by Aristotle in classifying the various forms of government refer to conditions which have long ceased to exist—to the small city-States of Greece, and a society based upon the slavery of a large part of the population. But in other respects too they no longer bear precisely the same meaning which they had for early Greek writers on political philosophy. By monarchy, for example, we understand limited or constitutional monarchy—a conception, by the way, not wholly unfamiliar to Plato, who, in the *Statesman* (302), selects for special praise 'monarchy, when bound by good prescriptions or laws,' and also, in the *Laws* (693), says that it is wise to combine the monarchical and democratical. A monarchy not so limited by fixed laws we should call despotism; but despotism, again, we do not identify with tyranny. Then our modern representative democracy is something altogether different from the government of the whole people by the whole which Plato and Aristotle held in the strongest detestation, while seeing it to be the form of government towards which all systems at that time tended.

Plato thought that political knowledge must always be confined to a few (*Statesman*, 297). His favourite polity was monarchy, and the government of the philosopher-king is the ideal of the *Republic*. Tyranny he thought the worst government of all, and the tyrant the worst of human beings. Aristotle's discussion of this question differs little from what we find in Plato, as regards either the subject-matter or the opinions expressed. Kingship he too

considered 'the primary or most Divine form' of government (*Pol.* vi. ii.); aristocracy the next best. To an individual of pre-eminent virtue 'all should render willing obedience . . . he and his like should be perpetual kings within their States' (iii. xiii. and xvii.). But a person, and, still more, persons, of such virtue are rarely to be found; hence kingship and aristocracy, in its true sense of a government of the best people or for the best ends, are unrealizable ideals. Aristotle was alive to another difficulty in the greatly increasing size of States, in view of which he confessed that in his own time it was perhaps no longer easy to establish any form of polity but democracy (iii. xv.). As a practical substitute for the ideal State, he recommends constitutional government as the polity 'most generally attainable and most desirable' (vi. ii.). The true end of equality, he says, is that neither rich nor poor should have the supremacy (vii. ii.). Hence the best practical, political constitution is one in the hands of the middle class (vi. xi.). They are the arbitrators between rich and poor (vi. xii.), and they are more conformable to reason, more capable of constitutional action, than any other section of the population (vi. xi.). In this democracy, political privileges were to be given to men of moderate means, the poorest class in the community being excluded. But Aristotle did not see a polity of this kind fully put into practice. His was an age in which enormous power had got into the hands of demagogues, and all citizens were admitted to an absolute equality—a system resulting in the practical supremacy of the masses. In this state of affairs the commons were, he complains, 'superior even to the laws' (vi. xiv.); and he expresses himself by no means confidently with regard to the popular opinion that individual liberty is exclusively, or even necessarily, a fruit of these democratic institutions (vii. ii.).

We come now to the question, Which is the best form of government? Many persons hold with Samuel Johnson that forms of polity have little power to influence happiness, and that it does not matter a straw that we should live under one kind of constitution rather than another. On more philosophic grounds, Kant thought that the form of the State did not matter, if the spirit of right and freedom were there (*Perpetual Peace*). Pope's well-known solution of the difficulty—'Whatever is best administered is best'—is only verbally satisfactory, and leaves us still face to face with the problem, Which constitution is likely to be best administered? Which will be most helpful to progress? And to this question no cut and dried answer can be given, because the stages of political progress and degrees of intellectual and moral capacity depend upon varying conditions, and require institutions so different that in a primitive state of society even despotism can be, and has been, justified. There is, accordingly, no ideally best polity; but most writers on the subject think with Aristotle that the question is one which every statesman and student of practical politics ought to consider. It is his business not only to know the best constitution under actual conditions, but to ask what form of government most nearly approaches the ideal (*Pol.* vi. i.).

Monarchy came first in the history of politics, and has been the most widely recognized of all governments. Nor is it difficult to understand how this should be. The rule of one is obviously the most suitable form of polity in a rude state of society, where the political consciousness is undeveloped. Even under more advanced conditions, there is something to be said in favour of absolutism. The autocratic monarch is unhampered by the necessity of securing the assent of minister or people; under no other constitution can the execu-

tive act with such force, consistency, and rapidity. Unfortunately, however, as Aristotle pointed out, hereditary kingship is exposed to great peril, owing to the frequent incapacity of kings (viii. x.). Whatever powers the exigencies of ruder times may have called forth, it is certain that nowadays exceptional administrative skill or general capacity rarely shows itself in royal families. There are few States, however, at the present day in which this constitutes a danger. Modern monarchy is limited to such an extent as to tend, in the opinion of many observers, more and more in the direction of democracy. In those cases where the sovereign power remains autocratic, it is generally limited by a bureaucracy.

In *aristocracy*, if it be a true form of that polity, the government is in the hands of a class who are morally and intellectually superior to the rest of the community, and have the wealth and leisure to enable them to acquire special knowledge. They have been properly called governors by profession. Hence some of the most remarkable administrations in history have been aristocracies, at least in name. Looked at from our modern point of view, they are rather to be called bureaucracies, with the virtues and defects of bureaucracy—experience and a more or less mechanical energy on the part of the governors; on the side of the governed a certain passivity of the kind which is produced in a people by despotism.

John Stuart Mill criticizes aristocracy and monarchy from one point of view. A great minister, he remarks with some truth, is almost as rare a phenomenon in modern Europe as a great king (*Representative Government*, p. 46). This is, of course, the difficulty which confronted Aristotle, and was declared insuperable by him—the problem of finding persons pre-eminent in both talent and virtue. It is a difficulty which time has removed in its own way. The aristocratic classes have lost their former sovereign position in the State. In every country they are now subordinate either to monarch or to ruling people. No example of this polity has survived to the present day; still less do we see a modern government of the best people, in the old sense of a pure aristocracy.

As to the merits of *democracy* there is considerable difference of opinion. It suffered a good deal in reputation during the excesses of the French Revolution. So great a statesman as Burke stigmatized it as the most shameful thing in the world (*Reflections on the Revolution in France*, 1790). But, in the judgment of unbiased persons, there is no necessary connexion between democracy and violence, and popular government in its higher aspects is now generally admitted to exert a stimulating influence upon education, and to foster in a striking manner the growth of patriotic spirit. These results, indeed, were seen in ancient Greece, in the high intellectual standard attained by the average Athenian citizen, and the sacrifices he was willing to make for the State from a sense of duty. None the less, Plato decided against democracy, on the ground that such a polity was 'unable to do any great good or any great evil' (*Statesman*, 303). His criticism draws attention to a serious defect under which this form of government labours. Its executive is often weak, its conduct of foreign affairs timid, and, if there be frequent changes of administration, ever open to the charge of inconsistency. Indeed, on all questions the difficulty of pursuing a continuous policy results in a lack of vigour in republican authority, which has been ascribed partly to the absence of the pomp and splendour which surround royal thrones, and partly to the fact that presidents and ministers are regarded rather as servants than as heads of the republican State.

John Stuart Mill was so convinced that large assemblies are unfitted, not only for administration, but also for the direct work of legislation, that he advocated the formation of a legislative committee to which the business of drawing up bills might be entrusted. But a democratic government is not troubled by doubts of this kind; it goes to the task of making laws with zeal and self-confidence. Here its strength is supposed to lie. The chief defect of government by a majority of the people is not a paucity of laws but the danger of class legislation, or what is called the tyranny of the multitude. It is, of course, true that ill-considered legislation is not an evil peculiar to government by a majority, and that the numerous interests represented tend to counteract this danger in a democratic State. At the same time, in all large assemblies ignorance and incapacity are likely to be more common than knowledge and administrative skill, and self-interest will be found a more powerful motive force than the love of justice. For this and other reasons, Rousseau held that pure democracy was a government which might do for gods, but was too perfect a government for men.

It is agreed nowadays that enlightenment, education, and progress are not necessarily the fruit of popular government more than of other forms of polity. Aristotle too, many centuries ago, decided against the vulgar belief that liberty is to be enjoyed only under a democracy. Indeed, there is nothing to prevent freedom from existing in any State not despotic, although, in the nature of things, it is to be sought rather under a representative government than any other—a system, that is, in which the supreme authority lies with the representatives of the people. What is to be found here, and not under other forms of polity, is 'an open field for natural talent.' This, as has been well pointed out by D. G. Ritchie, is the true defence of democracy. Men being equal neither in capacities nor in character, and their respective merits being ascertainable only by actual trial, democratic institutions are defensible in so far as they offer the best means of obtaining a genuine aristocracy or government of the best (*Philosophical Studies*, p. 338).

To what extent may the form of government be said to be a matter of choice? According to the old dictum that constitutions are not made but grow, there is no choice at all. But the truth behind this dictum and its converse seems rather to be that constitutions *are* made, that they are the work of human reflexion and contrivance, and that at the same time they also grow, and in directions which men cannot always either influence or foresee. Institutions are, in fact, a matter of choice within the limits left by the circumstances and aptitudes of a people. Their permanence depends on the manner in which they are adapted to the requirements of the people, and continue with the lapse of time and the growth of the nation so to adapt themselves. Even within these limitations, however, the choice of the form of polity is not one wholly dependent upon human foresight; nor is the task of adapting it to peculiar needs entirely achieved by the skill of statesman or legislator. Not a little must be attributed to chance. Plato hits upon this truth in the *Laws* (709): 'Destinies and accidents happening in all sorts of ways legislate in all sorts of ways.'

The importance of the kind of polity has been differently estimated by various writers. Rousseau believed that institutions are all-important, and that, as men are naturally virtuous, they will show themselves to be so under just and suitable government. Montesquieu, while laying great stress on the necessity of institutions being in conformity

with the spirit of a nation, held, on the other hand, that these institutions are moulded by the character of the people and by such conditions as climate, employment, and general environment—influences upon which government, whether of one kind or another, can have little effect. On these views, which obviously represent opposite standpoints, little need be said by way of criticism. Rousseau's position will be generally characterized as extreme, while at the same time it must be admitted that there are few modern writers who would seek to minimize or ignore the influences which the *forms* of government undoubtedly has on a people.

Every polity, says Aristotle, comprises three departments (*μῆτρα*)—the *deliberative*, the *executive*, the *judicial* body (VI. xiv.). These three functions of the State were not kept distinct, save in name, until comparatively recent times. In Greece and Rome they were frequently exercised by the same persons, as, for instance, by the Athenian *ecclesia*; and the mediæval State was not more differentiated. Only in the 16th cent. did people begin to feel that at least the judicial function should be exercised independently, and that kings ought not to administer justice in person. This judiciary faculty does so stand apart in every carefully organized modern State. The name which it bears and the names given to the other two functions of the State are practically the same as those used by Aristotle. They are: (1) the legislative, which Locke calls 'the soul which gives form, life, and unity to the commonwealth' (ii. §212), and which stands above the other two functions, as laying down laws which they must obey; (2) the executive or administrative power; and (3) the judiciary faculty.

In early monarchical government the sovereign was entrusted with unlimited power, and it was in the interests of individual liberty that attempts were made from time to time to impose limitations on this authority. In modern times it is by the method of separation of functions that nations seek to put checks upon the supreme authority and establish a balance of power within the State—a device of which perhaps the best illustration may be seen in the constitution of the United States of America, where the legislature and executive are in a sense pitted against each other. Kant and other philosophers have held that, where there is not a complete separation of the legislative and executive functions, there must be despotism (*Perpetual Peace*). Executive functionaries are not usually appointed by popular vote, nor in the opinion of many authorities should they be so appointed. In the case of the Presidency of the United States of America, the effect of this manner of election is to make all questions party questions.

3. The sphere of government.—Within what limits is the exercise of governmental machinery legitimate? The Hellenic State is generally considered to have possessed too much power. Looked at from our modern standpoint, a State is not an end in itself; it can never be more than a means—the only means, it is true—by which the liberty and welfare of men can be secured. As an end in itself, however, the Hellenic spirit idealized the State. Its citizens endured, without murmur, interference of the most minute kind with their private life and liberty, the sacrifice often of their interest as individuals, the non-recognition of their rights as men. They accepted this condition of things willingly, without question or criticism, because they regarded themselves as a part of the corporate whole, as one with the State in spirit and in will. The Spencerian antithesis of man and State, or man and government, would have conveyed no meaning to the Athenian citizen. Moreover, the distinction had not yet been formulated between the sphere of law and that of morality or

private life, the region in which we can legislate, and that in which legislation is useless or pernicious. The standpoint with which the Greek was familiar was that of Plato's *Laws*, which is permeated by the principle that law can make people virtuous—the direct contrary of our modern maxim that one cannot make a man moral by Act of Parliament.

In Great Britain, political theory, owing to various causes, is strongly individualistic in character. It ignores our obvious debt to society. In the extreme form of individualism, found in Bentham, Mill, and Spencer, the State is regarded as nothing, the individual as everything. For these writers, for Spencer especially, all restraint is an evil, while the sole function by which government may justify its existence is that of protecting individuals from aggression and punishing criminals—of acting, as Huxley says, the part of chief policeman (*Administrative Nihilism*). This theory, which Ritchie traces to Lycophron, the sophist, we have in a somewhat similar form in Hobbes and Locke. The office of the sovereign power, says the former, is the procuring of the safety of the people and their enjoyment of the contentments of life (*Leviathan*, p. 322, Molesworth's ed.)—'contentments' being a very comprehensive word. At the beginning of the first *Letter on Toleration*, Locke defines the term 'commonwealth' in very similar language.

Nothing is suggested, in individualistic theory, of any action and reaction between the individual citizens and the State, or of any relation between sovereign and subject other than that of force and obedience—an external contractual relation in the opinion of Hobbes and Locke. According to Bentham, the principle of utility ought to govern society, whose business it should be to secure the greatest possible amount of happiness to men; law for him is a necessary evil, government a choice of evils (*Principles of Morals and Legislation*, p. 48). For Bentham, as for Mill and Spencer, society is no more than an aggregate of individuals, and the last of these writers says frankly that the liberty a citizen enjoys is to be measured, not by the nature of the governmental machinery, but by the relative paucity of the restraints it imposes (*Man versus State*, p. 15). From this point of view the presumption must always be that the government is in the wrong, and can be called upon to justify itself on every occasion where it actively interferes with the liberty of individuals. The cry of Emerson is not less unambiguous: 'The less government we have the better,' he says, 'the fewer laws, and the less confided power' (*Essay on Politics*). This is a fair conclusion from the premiss that all coercion is immoral and destructive to freedom; but the logical outcome of principles like this is a return to the struggle for existence—in other words, anarchy.

The reasoning of Mill and Spencer is based upon the hypothesis that every increase in the power of the State necessarily implies a corresponding decrease in the liberty of the individual citizen: State action, according to this view, being always opposed to the action of the individual. It is clear that any such statement of an inverse ratio as existing between governmental power and individual freedom depends upon an erroneous conception of liberty. Freedom from restraint and from the meddling of governments is not liberty. It may be more safely defined as the privilege of living under fixed standing laws, formed in the interest of the people, adapted to their needs, and capable of affording them the fullest opportunity of self-development and progress. The more just the constitution, as Kant saw, the greater the amount of freedom which can be left to the citizen. Formed to make life possible, the State exists, as

Aristotle said so long ago, to make life good. It is *not* characteristic of liberty that every citizen should act as he chooses. Rather 'the citizens should live, and live gladly, in the spirit of the polity'; such a life is not to be regarded as a bondage but as a means of preservation (*Pol.* VIII. x.).

This is sound doctrine. Aristotle saw that security and personal liberty were blessings which no man can conquer for himself; he saw that they were to be found only in the State, and that liberty is something different from licence. The distinction is one of which Locke, too, was fully aware; even the state of nature, he says, is not without law, having the law of nature to govern it (ii. § 6). Political power he defines as the right of legislating for the public good (*ib.* § 3): 'Where there is no law there is no freedom' (*ib.* § 57).

The theory was advanced by Mill that the liberty of an individual should be limited only by the equal liberty of every one else. This principle has been proved by Huxley and later writers to be absurd and incapable of application. By almost universal consent it is held that all desires harmful to society should be as much as possible stamped out; while, on the other hand, it should be the object of constant endeavour to encourage those favourable to progress. The question arises, however, how far this can be done, and here there is some difference of opinion. To-day, in the energy of legislatures, we are face to face with a new phenomenon in the history of politics. Looking back on the last fifty years, we find the sphere of governmental activity enormously extended. The State has interfered with matters concerning the preservation of health and the prevention of disease; it has made education and insurance compulsory, and striven to encourage the pursuit of the higher kinds of knowledge and the cultivation of art; through its picture galleries and public buildings it offers not only an intellectual but an æsthetic training to its citizens. In these endeavours, which have had the support of the people, its object has frankly been the public good. But there are no limits to the extent to which this well-intentioned interference could conceivably be carried. How far, then, given the most exalted motives, is State interference justifiable? Bentham gives an answer recommending caution, and so does T. H. Green. They are agreed that not every act beneficial to the individual is to be enforced by legislation (Bentham, *Principles of Morals and Legislation*, ch. XIX. viii.); or, as Green more definitely put it, only such acts should be made compulsory as had better take place from any motive than not take place at all (*Philosophical Works*, ii. 344). Well-meaning patriotic legislation is confronted by a real danger—that of deadening the sense of personal responsibility, and of causing that to be done through fear of legal consequences which ought to be done from a feeling of duty.

It is interesting to note that Locke, whose *Essays* contain the first systematic attempt to investigate the limits of State action, applied in a very broad-minded spirit his maxim that the end of government is the good of mankind. In the first *Letter on Toleration*, speaking of the washing of children, he uses these words: 'If the magistrate understand such washing to be profitable to the curing or preventing of any disease that children are subject to, and esteem the matter weighty enough to be taken care of by a law, in that case he may order it to be done.' The view expressed in this passage would justify modern laws of sanitation and other laws not justifiable on old-fashioned individualistic principles of liberty.

The functions of a government vary with differ-

ent stages of political development, its power being necessarily far-reaching in a backward State, which can often be best served by so-called paternal legislation. Hence, generally speaking, the sphere of government cannot be determined from theoretical considerations; nor can this administration or that be judged except by the results of its activity. In a well-ordered society it is not likely that State interference will be carried too far. As Samuel Johnson said of tyranny, 'mankind will not bear it.'

See also art. STATE.

LITERATURE.—Frequent reference has been made in this art. to the dialogues of Plato (especially the *Republic*, the *Statesman*, and the *Laws*) and to the *Politics* of Aristotle. The origin of government, the theory of contract, and such questions are discussed in the works of Hobbes; in Hooker's *Eccelesiastical Polity*; Locke's *Essay on Government*; Rousseau's *Contrat social*; Hume's *Essays*; and the political writings of Kant. Among theological works, Butler's *Analogy* must not be forgotten. On the Divine right of kings, see the *Mémoires historiques* of Louis XIV. (*Œuvres*, Paris, 1806, vol. I.); and Bossuet's *Politique tirée des propres paroles de l'Écriture sainte* (*Œuvres de Bossuet*, do. 1864, vols. xxiii, xxiv.); also B. L. Henri Martin's *Histoire de France* (various edd.). Among classical works mention must also be made of Montesquien's *Spirit of Laws* (Eng. tr., London, 1896-97). A book which is of great value to the student of politics is J. C. Bluntschli's *Theory of the State* (Eng. tr., Oxford, 1885). Another, bearing a similar title but treating the subject from a purely philosophic standpoint, is B. Bosanquet's *Philosophic Theory of the State* (London, 1910). Reference may be made, on general grounds, to H. Sidgwick's *Elements of Politics*, do. 1897. An admirable statement of the advantages and disadvantages of democracy is found in J. Bryce's *American Commonwealth*, do. 1888 (new ed. 1911). For a doctrine of sovereignty which has greatly influenced the standpoint of English jurists, see J. Austin's *Lectures on Jurisprudence* (do. 1863). This theory is examined in the *Early History of Institutions* (do. 1875) of H. S. Maine, whose treatise on *Popular Government* (do. 1885) may be also mentioned. A mass of literature has grown up round the question of the limits of State authority. Among the contributions of older writers to this subject are Wilhelm von Humboldt's *Sphere and Duties of Government* (Eng. tr., do. 1854); J. Bentham's *Principles of Morals and Legislation* (various edd.); J. S. Mill's *Liberty*, and *Representative Government* (various edd.); H. Spencer's *Man versus State* (do. 1884). In the first volume of his *Collected Essays* (do. 1893-94) are T. H. Huxley's *Administrative Nihilism*, and *Government: Anarchy or Regimentation*. T. H. Green's *Lectures on the Principles of Political Obligation* may be found in his *Works* (ed. Nettleship, do. 1885-88). See also the political writings of D. G. Ritchie, especially his *Principles of State Interference* (do. 1891) and some of the essays in the volume entitled *Darwin and Hegel, with other Philos. Studies* (do. 1893); F. C. Montague's *Limits of Individual Liberty* (do. 1885); an essay on 'Liberty and Legislation,' in B. Bosanquet's *Civilization of Christendom* (do. 1893). J. S. Mackenzie's *Introd. to Social Philosophy* (Glasgow, 1890) treats of the subject briefly.

M. CAMPBELL SMITH.

GRACE.¹—I. HISTORY.—I. Ethnic.—The Christian thought of grace is heralded in ethnic religions by the wide-spread feeling that the gods are kindred and friendly beings, guardians of morality, and, up to a certain point, able to help men. From the earliest times a corresponding confidence and trust—a few anthropologists even say love—differentiate religion from magic or sorcery. In Scandinavian, Egyptian, and Greek sources there are faint suggestions of a Divine representative sacrificed for human good, and this marked a positive advance beyond the mere culture-hero who averts peril and brings in civilization.

2. Jewish.—In the OT the relevant terms are mainly two—יָסַד, 'favour' (more general), and רַחֵם, 'lovingkindness' (mostly used of the Divine attitude to Israel). Such grace is the free outflow of Divine love, irrespective of the worth of its object. Grace at first relates to Jahweh's anger, often represented as a capricious and uncalculating passion, the effects of which grace removes. But, chiefly, grace is the fount of every blessing. The bond which unites Jahweh and Israel is one of grace *ab initio*, for He chose Israel freely, being influenced neither by its size nor by its righteous-

¹ This art. being written from the Protestant point of view, a full statement of the Roman Catholic doctrine of grace will be found in the following article.

ness (Dt 7⁹); and to this spontaneously selective love OT writers trace the promise to Abraham (Gn 12¹), the covenant of Sinai (Ex 33¹⁰), and the oath to David (Is 55³). The moralization of the idea—which to the end savoured of national privilege—owed much to Amos and Hosea; grace is *moral* love, and includes righteousness; yet for Hosea righteousness does not put God far away. He is the nation's tender Father, and 'His love is sovereign, pure, unselfish, free from all impatience and all variableness as the love of an earthly father can never be' (W. Robertson Smith, *Prophets*, Edin. 1882, p. 162). In their arraignment of the people, the prophets adduce Jahweh's acts of guidance and protection in the past. Prominent even in Deut. (7²³), grace is supreme in Deutero-Isaiah and the Psalms, the Exile having quickened a poignant sense of need. Then once for all the idea took an eschatological colour (Is 54⁵, Ps 89⁴, Jer 29¹¹). Jahweh's grace is sovereign and wonderful, His invincible power to pardon the guilty is mentioned in exulting tones, and it is anticipated that by a special gracious act He will gather His people from among the heathen. Towards the close of the OT literature, the relation of grace to the individual comes into view. But no trace exists of a material or quasi-material view of the Divine favour or its operation. Always it is an attitude or active disposition of Jahweh to persons. To those who keep His commandments and show loving consideration to their fellows, His grace is a possession for ever.

3. Christian.—(1) *In the NT*.—In the NT the two Heb. terms already mentioned are embraced in χάρις. Classical writers mean by χάρις that which gives pleasure or delight, and so loveliness or charm. Beauty in motion is very much the sense. The profounder meaning of the word in primitive Christianity—viz. the unmerited Divine love which stoops to pardon and bless the guilty—is, in part, a heritage from the OT, but it draws its characteristic intensity from the felt presence of redeeming love in Jesus Christ. The word is not found on Jesus' own lips, but His message and personality are laden with the thing. Thus in the Sermon on the Mount the Father makes His sun to rise on the evil and the good (Mt 5⁴⁵), the Kingdom is promised to the poor in spirit (v.³), comfort to the mourning (v.⁴), perfect satisfaction to those who long for righteousness (v.⁶). In the Lord's Prayer, the grace of the Father in heaven is assumed. Apart from very explicit utterances like the parables in Lk 15, the attitude of Jesus to the needy—to the paralytic (Mk 2), to the woman that was a sinner (Lk 7), to the dying malefactor (Lk 23)—conveyed to them and to bystanders the blessed sense of a Divine love mightier than sin. The Kingdom, into which He calls men, is not something they are to earn or make; it is a gift pure and simple, and with the conditions of entrance human wisdom or riches or righteousness have nothing to do. Even the conception of reward, though employed frankly, is placed in a light which reveals its inadequacy to set forth the principles of Divine action, for the reward is pictured as an hundredfold what men have sacrificed (Mk 10²⁹). Jesus is conscious of being the medium of grace, and in Mt 11²⁸ He puts Himself forward explicitly in this character. He must eventually die to ransom many (Mk 10⁴⁵). Thus to His mind the central fact of the world is the dying of the Christ of God in order to establish in a sinful world the great expected Kingdom—the new world-order which shall fully express Almighty Love.

Throughout the NT, grace is the first thought and the last—the atmosphere in which Christians live and move. Their message to the world is one of grace, and missionaries setting out to preach are

recommended to the grace of God (Ac 14²⁶). When believers pray, it is at the throne of grace (He 4¹⁶). As they survey the past or anticipate the glorious end, everywhere they see grace preparing, executing, and pervading all (1 P 1^{10, 18}).

It is especially by St. Paul that the conception of grace is elaborated. By grace he means the free love of God, visiting men even when unsought, more particularly as opposed to all demands of law or claims of merit. It was grace, as he is vividly aware, which called him personally, made him an apostle, and vouchsafed to him abundant missionary success (Gal 1⁶, Ro 12³, 1 Co 15¹⁰). But it is also the supreme causal agency by which Christian life everywhere is evoked, sustained, and augmented. The Apostle contemplates it for the most part from two points of view.—(a) Grace is the active disposition in God to which everything that can be called salvation is traceable (Ro 11⁶, Eph 1⁷, Gal 5⁴). The sending of God's Son and the acceptance of His obedience as availing for the guilty are both due to grace alone. Because of Christ's death, in which the Divine righteousness was manifested once for all—for grace contains wrath at evil as a subordinate element—God in His mercy is able to forgive freely. In St. Paul's view there is no antagonism between grace and righteousness. So far from making righteousness superfluous, grace actually bestows it by way of gift; for, if righteousness could be attained by the works of the Law, God were debtor to man, and grace were made of none effect. The gift of grace can be received only by faith (Ro 4¹⁶), i.e. by the willing and humble appropriation of the proffered boon, which places sinners in a right relation to God, and evokes an obedient love by which fear is banished. It is not that God has ceased to demand works and henceforth demands the believing temper as the price of salvation; faith is receptive, not meritorious, and grace is equally its received content and its producing cause. Since Jesus, indeed, grace and faith constitute an indissoluble unity. There is the closest bond between past historical events and the mercy of God thus apprehended by the believer. Grace is bound up with the person of Christ; apart from this reference to the historic Figure, and His experiences of life and death and resurrection, it would have no tangible or permanent significance for the Apostle's mind. The grace of which he speaks or writes is that of Christ as well as God; Christ is its eternal subject (2 Co 8⁹), its medium and pledge, and its present all-sufficient source (12⁹). There is no ground in St. Paul for describing grace as acting on the lines of a natural force in the production of the religious life; it is simply another name for the operation of the Spirit, and to him the Spirit, as it has been put, 'meant the gracious power of God which evoked faith in Jesus as the crucified and risen Christ and then mediated to the receptive, obedient life all that the Lord was and did for his own people' (J. Moffatt, *Paul and Paulinism*, London, 1910, p. 37 f.). The relationship of free access to the Father, into which men are thus introduced, is one which *ipso facto* can have no end; as grace is the basis of election (Ro 11⁶), so, too, it reigns through righteousness unto eternal life (Ro 5²¹).—(b) In a derived fashion, the word is also employed to designate the *fruit* of grace in redeemed lives, whether this be the spiritual status into which Divine love lifts men (Ro 5²), or particular gifts of an ethical or pneumatic character (cf. 2 Co 8⁷). Generally speaking, grace is felt to be the death of legal religion, for in trust responsive to God's bestowal of Christ men now serve Him not for wages, but in faith and love and hope. It is thus clear that in Jesus and Paul alike the thought of grace implies the complete fusion of the moral and the religious ideal. The writer

of the Fourth Gospel, while he prefers to speak of the Divine *love* (3¹⁶ 13¹; and Ep. *passim*), declares grace to be the new specific feature of the Christian religion as contrasted with Mosaism (1¹⁷). It is further noticeable that the NT does not fail to warn Christians of the unspeakably grave consequences of neglecting the Divine grace or receiving it in vain (2 Co 6¹, He 6⁴⁻⁵).

(2) *In the Early Church.*—The early centuries exhibit a marked process of tension between Eastern and Western thought. For the Greek Fathers, who took free will for granted, morality and religion lay parallel with each other—sin not abrogating freedom but expressing it, grace not displacing freedom but encouraging its independent activity; 'it consists not in an inner transformation, but in the objective facts, external to man, of providence, revelation, incarnation, and redemption' (O. Kirn, *PRE*³ vi. 719). Grace saves by illumining the intellect and reinforcing the resident and autonomous powers of human nature. The Western mind resumed the Hebrew thought of man's complete dependence on God; but, as early as Tertullian, we find predominant a view of grace which regards its action as the inspiration of a higher Divine quasi-physical energy or force, 'by which the *liberum arbitrium* is aided in a meritorious working for the rewards of eternal life' (F. Loofs, *Dogmengesch.*⁴, Halle, 1906, p. 164). The antagonism came to a head in the Pelagian controversy. It was argued optimistically by Pelagius and his group that free will is the inalienable prerogative of man; sinners are in no sort of bondage, but can choose either way. Sin is only a momentary self-determination, which leaves the nature intact and can always be successfully resisted. In religion it is useful to have our will guided, though renewal is not essential, and such guidance comes from the Law or from Christ's personal example or instruction. 'Grace, in short, is the external help which makes easier the realization of the natural possibility, together with the natural possibility itself' (Robinson, *Christian Doctrine of Man*, Edinburgh, 1911, p. 182). If Pelagius thus lowered grace to the plane of nature, Augustine (*q.v.*) held passionately that it liberates from a nature which is sinful through and through. Though no psychological determinist (man is free within the range of his ability), he taught that men have utterly lost the *liberum arbitrium* to good. Salvation, therefore, comes exclusively through grace—that replenishment with the Divine life which anew creates in us the good will—for Christ the God-man has brought down to earth the powers which give us back liberty to express freely the new nature. To grace, then, with the action of which in restoring moral power we cannot co-operate, or, in Augustine's significant phrase, to *gratia gratis data*, is due everything that can be called salvation—faith and love, freedom from concupiscence, the good will, and, very specially, the gift of perseverance (granted only to the elect). Grace is the effecting in time, and within the Church, of God's eternal predestinating will, whereby He resolved to save a certain (but to us unknown) number out of the 'mass of perdition.' It works *preveniently*, apprehending men and lifting them out of sin; *co-operantly*, producing in them good volitions and good action (this is justification, for the primary effect of grace is to make righteous); and *irresistibly*, for the Divine will is omnipotent. *Ut velimus, operatur incipiens, volentibus cooperatur perficiens*. Saving grace is distinguished from the *adjutorium gratiæ*, lost through the sin of Adam, by this quality of irresistible efficacy. This might seem to leave no room for merit, but Augustine teaches unequivocally that the final destiny of individuals is solely

dependent on their acquired merits, though it is added that these are gifts of God. He is undoubtedly true to experience in his conviction that man needs Divine salvation and cannot save himself. But a fundamental strain of Neo-Platonic mysticism renders him in the last resort unable to link salvation to the historic Christ by more than a loose connexion, so that the religious dynamic (grace as infused love) consists rather in a 'secret, wonderful, and ineffable' Divine energy than in the impression of Christ, living, dying, and risen for His people. The *gratia inspirationis* is really a communication of the Divine essence, and its ethical and personal character is still further overclouded by its being referred exclusively to the Divine omnipotence. See, further, the following article.

Augustine's doctrine of merit left a door open to Semi-Pelagian conceptions. Before his death, predestination and the bondage of the corrupt will had been rejected by those who feared their moral effect. The Semi-Pelagians (Loofs has pointed out that they might with nearly equal justice be called Semi-Augustinians, since they held that man requires Divine grace for good action) taught that God aids the will, sin having impaired freedom but not destroyed it. In 529 the Synod of Orange defined a position which is Augustinian on the whole; but it was silent as to the irresistibility of grace, and anathematized the defenders of predestination to evil. Unconditional predestination seemed to make the Church's means of grace superfluous, and this could not be borne. In the 9th cent., Gottschalk's advocacy of a logical Augustinianism was firmly put aside. Nor can we ignore the growing tendency to fix on sacraments as the proper vehicle of grace. Cf., further, artt. PELAGIANISM and SEMI-PELAGIANISM.

(3) *In the Middle Ages.*—In mediæval Scholasticism, no writer is so Augustinian in tone as St. Thomas Aquinas, who, however, combines the older thought of predestination with an Aristotelian and deterministic idea of God. God alone, he holds, can convert the sinner, as being the Prime Mover of all things. *Gratia increata* and *gratia creata* are distinguished, the first being the freely-imparted movement of God, the second a supernatural 'habit' infused into the soul's essence and constituting the new nature. Conversion comes through free will, which yet cannot turn to God except as, by the *auxilium gratiæ*, He turns it to Himself. *Gratia operans* is grace from the standpoint of Divine causation, *gratia co-operans* the same grace from the standpoint of human consent or volition (*Summa*, ii. 1, qu. 109-111). Acts are meritorious only as they issue from co-operating grace, in accordance with the secondary causation of the human will. What infused grace (*gratia gratum faciens*) does is to heal the soul, give power to will the good, grant perseverance, and finally conduct to eternal glory. The remission of sins follows on moral renovation. There is a sense in which man can prepare himself for grace, though not by merit; but, after the will has regained through grace the capacity of self-movement, it can acquire merit (*meritum de congruo* or *de condigno* according as it is considered as proceeding from free will or from the grace of the Holy Spirit). In this scheme the Augustinian conception of *sola gratia (infusa)* and the old Western idea of merit limit and supplement each other. Aquinas fails to bring out clearly any connexion between grace and Christ save that He exclusively merits for us the *gratia prima*, or original impartation; thus its action on the soul is in no sense psychologically mediated, and it appears most characteristically in the sacraments, as a Divine force impinging on or imparted to the soul.

Duns Scotus criticizes sharply the notion of a 'habit' produced in the soul by grace, and tends to evaporate grace as such into a co-operant principle which renders free moral action well-pleasing to God. The absolute freedom of God and man are placed in unconditional opposition. Grace heightens the privately achieved goodness of man; hence the scope of merit broadens out indefinitely. The Nominalists followed Duns in teaching that sin has left the natural freedom of man intact, and that merit is requisite even for the initial gift of grace. Bradwardine and Wyclif raised an Augustinian protest. The anthropology of the Council of Trent, on the other hand, may be described as 'the combination of a Thomist scheme of sin and grace with such modification of its statement as would allow a Scotist interpretation' (Robinson, p. 210). Contrary to the Augustinian and Thomist tradition, it is declared that the *gratia prima* does not justify, but only disposes to justification, so that justification is the fruit of a Divine and human co-operation. See, further, the following article.

(4) *From the Reformation.*—Luther (*q.v.*) broke definitely with the conception of grace as a quality of the soul, a Divinely caused inward 'habit,' and identified it for good and all with the mercy of God presented in Jesus Christ, which sinners experience primarily and essentially as forgiveness. To have faith is to have grace: *wer glaubt, der hat*. The Divine favour in Christ is brought home to us by the gift of the Holy Spirit, working in and through the Word or Gospel, in which God Himself deals with us and gives Himself in Christ to be our own. Grace is this loving will of God. The sacraments are efficacious signs of it. It is true that Luther's sacramental doctrine partially deserts this great conception, in so far as he teaches that sacraments present a peculiar additional grace over and above that which is made ours in Christ as the embodied love of God. At bottom, however, 'the certainty of forgiveness in Christ was for him the sum of religion' (Harnack, *Grundriss der Dogmengeschichte*, Freiburg, 1891, p. 366). For Calvin also (see CALVINISM) grace and faith are vitally correlative, although his underlying deterministic philosophy of unconditional predestination led him at times to equate grace with 'the good pleasure of God.' In both Reformers, an end is made of human merit as contributory to salvation. We cannot here discuss the later Calvinistic and Arminian controversy as to whether grace is or is not particular, irresistible, and inalienable (see, further, art. ARMINIANISM).

II. The NT message and its echo in Reformation preaching both imply a conception of Divine grace wholly drawn from and determined by the felt redeeming influence of Jesus Christ. Disregard of the fact of moral personality, as though religion could be passed into the soul like a stream of electricity, is invariably caused by or causes the thought of grace as a secret Divine energy, due solely to omnipotence, and acting on the human will with irresistible pressure—a quasi-physical force, stored within the Church, and applied to the soul-substance in its subconscious depths. But a coercive force, for which the will is only a medium of transmission, cannot ever be one with human experience, or fulfil itself in volition as our act and possession. We must seek, then, to regard grace as that which produces faith in accordance with the laws of an ethical and rational nature, and at the same time resolves the native tension and conflict of the moral life. 'Only by relating grace to personality and personality to grace is it possible to have a spiritual conception of either. Grace is grace and not a force precisely because it is the succour of our moral personality' (J. Oman, *Expositor*, 1912, p.

236). If our relation to God is to be moral, it must be also free.

Probably the best analogy to the unity found in life's actual movement between the dependence on grace asserted by faith and the moral dependence on which conscience insists is the experience of 'falling in love.' In both cases there is an impelling personal constraint to which it is liberty to yield. The whole fact is neither dependence by itself nor independence by itself, as alternating or rival phases, but each supported and constituted by the other. Similarly, religion begins when we encounter a Power or Reality which subdues us purely by its spiritual content, not destroying freedom but raising it to the highest point. In this experience, moral life is in principle made perfect, for a man is good not in so far as he shuts out all influences, but as he opens his nature to the highest. Submission to grace—i.e. to God's loving will, which is His essence—is thus the limiting case of an experience, of receptiveness and liberty fused in one, which is fundamental to all moral life. Only through grace do we become personalities in the highest and fullest sense. The taint of egoism and self-righteousness must cling to all life of which the finite self is centre.

This means that Catholic and Protestant conceptions of grace are eventually incapable of being merged in a higher unity. To the Catholic, grace is ethical in aim, yet at the same time hyper-physical in character and operation, dispensed through an infallible and hierarchical institution, and charged with a mysteriously sanctifying power which is manifest supremely in the Sacraments. To the evangelical Protestant, grace is the free active love of God to sinners, so personally present in Christ as to elicit faith by its intrinsically persuasive content. It is no mere supernatural force emitted by Deity—which might have no relation to Jesus, or only the barest—but the Father's will of saving mercy exhibited in the person of His Son. Grace, as seen in Christ, does not cause faith by any *vis a tergo*; it evokes faith by means of the felt significance of the Redeemer, working upon us through ethically qualified motives. All ideas of law or reward drop away. Nor are there two acts or forms of grace, one imparting remission of sins, the other by way of supplement changing the inward nature and inspiring power for goodness; on the contrary, the needed moral dynamic, rich in all true and triumphant morality, flows from the transforming apprehension of the fatherly grace held forth to us in Christ. Grace, therefore, is both a gift and a challenge. We cannot face and feel the saving power that is in Jesus, and know that in Him we are meeting God, without the uplifting consciousness that the righteous Father is summoning us to be one with Him in His righteousness and in the purposes of His kingdom. 'By the grace of God I am what I am' forms the heartfelt confession of all believers, of whatever school; and the words, read in the light of concrete experience, are an expression both of utter indebtedness to God, who by taking us to be His children has wrought whatever in us is good, and of complete ethical liberty. See also art. HOLY SPIRIT.

LITERATURE.—The NT Theologies; O. Kirn, 'Gnade,' in *PRE*³; D. A. Bertholet, A. Meyer, and E. Troeltsch, 'Gnade Gottes,' in Schiele's *Religion*, II. 1464 ff.; the *Histories of Dogma* by A. Harnack (Eng. tr., London, 1894-99); F. Loofs (4th ed., Halle, 1906), and R. Seeberg (Leipzig, 1907-08); Th. Häring, *Der christliche Glaube (Dogmatik)*, Calw, 1906; J. Oman, artt. 'Personality and Grace,' in *Expositor* for 1911 and 1912; H. Wheeler Robinson, *Christian Doctrine of Man*, Edinb. 1911.

H. R. MACKINTOSH.

GRACE, DOCTRINE OF (Roman Catholic).—The doctrine of grace, as understood and taught at present in the Roman Catholic Church, is the rational development of the principles contained in

the Scriptures, as interpreted by the traditions of the primitive Church, and worked out to its present form through a long series of theological controversies. For chief authorities it claims, among inspired writers, St. Paul; among the Fathers of the Church, St. Augustine; and foremost among the theologians, St. Thomas Aquinas. As it is based entirely on the traditional Catholic notion of the supernatural order, it is essential that we should, first of all, form a clear and accurate notion of that basal concept.

I. The supernatural order: sanctifying (or habitual) grace.—In agreement with tenets kindred to those of the Greek, mostly Platonic and Aristotelian, philosophy, the Christian revelation implicitly assumes that, whereas the human body is apparently doomed to decay and death, the human soul is naturally simple, incorruptible, and intellectual, and consequently made for all truth. Therefore, no other end may be considered as commensurate and proportionate to its natural aptitudes than a possession of the plenitude of truth, which is God Himself. Some kind of vision and possession of God after this life is, accordingly, the only destiny that may give plenary satisfaction to the aspirations and aptitudes of the human soul. But, while a purely natural vision and possession of the God of Nature (such as we may assume to be that of the souls consigned to Limbo) should suffice to satisfy the natural exigencies of the human soul, and whereas God could owe nothing more to the individual soul than the said natural possession of the Supreme truth (provided the soul should have proved itself worthy of it by its conduct in this earthly life), nevertheless the whole of the Christian revelation is based on the assumption that it was, from all eternity, the munificent and gratuitous decision of the Lord to call man to an even higher destiny, not only to a natural but to a supernatural and Divine reward. He was called upon to know, to possess, to enjoy his God in the contemplation face to face of His essence, of the revealed mysteries of His intimate selfhood, of His Deity—not only as Prime Maker and Prime Mover of the natural universe, but as God Trine and One of the Christian revelation. Man was, therefore, to be admitted into the sanctuary of the Divine Self, to become a partner and an associate of God Himself in His possession of Himself, to partake of the Divine and infinite beatitude, on the same footing and in exactly the same way as God Himself, viz. by enjoying, conjointly with Him, the very same infinitely beatifying object, the very same infinite perfections. The only difference should be that, whereas the enjoyment which God has of Himself is infinite, the enjoyment which man would have of God, on account of the inherent natural limitations of the human soul, would be necessarily finite in degree, although not less Divine in its kind, because not less Divine in its object.

As a consequence, according to the decision of the Creator of the universe, which we have just recounted, two orders, essentially different in kind, but mutually co-ordinated, should mingle their essences and unite their activities in this our world, for the working out of the salvation of the individual soul—the natural order to which man belongs as a natural being by his body and his soul, and the supernatural order to which he was called by God and into which he is introduced by the Divine efficacy of grace. For, since man was called to a Divine destiny, he must be made proportionate to it, he must be raised to the Divine plane, he must be somehow divinized; and that is why a 'permanent' and lasting Divine gift or quality must be infused in his soul, durably to abide there, until wilfully destroyed by mortal

sin—a supernatural and godlike perfection, the effect of which was to confer on the soul of man a kind of 'deiformity,' mysteriously aroused in it by the all-powerful agency of God. That permanent supernatural quality Divinely infused in the soul of man, to make him durably proportionate to his Divine destiny, by raising him permanently to the Divine plane, is called 'habitual' or 'sanctifying' grace.

Of course, it might have been in itself sufficient to grant to man a supernatural help, an 'actual grace,' whenever it was necessary for him to perform supernatural actions—to raise him 'each time' above his natural capacity, in order to make him produce Divine acts meritorious of the Divine reward; but it was more harmonious, more consistent, permanently to divinize man, to raise him, once for all, to the supernatural plane. The Scripture texts, as the Catholic Church always understood them, indicated that such had been the course selected by God, and so she always expressly held by the primitive traditions, from which the Church could not possibly recede. When, therefore, the early Protestant Reformers, making light of all traditions, and boldly sweeping aside all the theological development of the past ages, came forward, denying the existence of any internal supernatural quality infused by God, which should be called 'habitual' or 'sanctifying' grace, and maintaining that the state of grace was characterized by nothing but an 'external' imputation of justice, made by the Eternal Father, of the merits of the Redemption of Jesus Christ, the Church could not refrain from defining as a dogma of faith (Trid., sess. 6, can. 11) that habitual grace must be understood as an 'inherent' Divinely infused perfection.

2. The state of innocence (*status innocentie*).—Accordingly, when the first human couple were created, they were endowed, over and above their natural organism, with a second, a 'supernatural organism' made up of the following elements:

(1) *Sanctifying grace*, the Divinely infused supernatural quality which permanently divinizes the human nature to make it proportionate to its Divine end.

(2) But sanctifying grace does not come alone. Somewhat as the boughs of a tree will branch from its stem, from that fundamental and basal perfection, habitual grace, a number of complementary and dependent supernatural perfections concomitantly branch out, in the various faculties of the soul. They are the *virtues*: three 'theological,' viz. Faith, Hope, and Charity; four 'cardinal' or moral, viz. Prudence, Justice, Force, Temperance, together with their dependent subsidiary virtues, and the 'seven gifts' of the Holy Ghost.

(3) Besides those fundamental perfections, they had been endowed also with several gratuitous *privileges*, essentially distinct and separable from the foregoing, as a kind of supplementary dowry, destined to emphasize the munificence of the Lord. Those privileges were briefly: an infused and perfect knowledge of all things that pertained to the human sphere, freedom from any revolt of concupiscence, impassibility, and immortality of the body. It was commonly understood that the primitive plan of God was to let man live on earth a natural term of years, and, after having allowed him to perform some meritorious acts, without inflicting death on him to take him up to his infinite and Divine reward. Original sin destroyed the work of God; the effect of Redemption, on the other hand, was to restore it in a new form, by creating the state of reparation.

3. The state of reparation (*status naturæ reparatæ*).—In this new state of reparation, the

gratuitous privileges of omniscience, immortality, etc., remain irretrievably forfeited, but the whole of the supernatural 'organism' which we have described above is restored, through baptism, to infidels, and, through penance after mortal sin, to baptized Christians. This would be, therefore, the place to treat of the relation of sanctifying grace to the Sacraments, but we must refer the reader to the various articles on the Sacraments; it will be enough to say here that sanctifying grace is first generated in the soul by God through baptism, that it is mortified in it by mortal sin, restored through penance, and increased each time by each reception of the various Sacraments, especially the Holy Eucharist.

To sum up, therefore, in a few axioms the Catholic doctrine of sanctifying grace, we may say: sanctifying grace is an 'inherent' perfection (dogma of faith); it is understood to be 'subjected' (to inhere) in the essence of the soul; it is more commonly regarded as a 'physical' entity, not a moral participation in the Divine nature, in the sense expounded above; more probably, it must be regarded as distinct from charity (although Duns Scotus and several others hold the contrary view); from it the various complementary perfections which we call 'virtues' and 'gifts of the Holy Ghost' branch out in the various faculties of the soul, either, according to some, 'physically'—viz. as a kind of connatural excrescences or offshoots of it—or, according to others, 'morally' only, i.e. as purely necessary concomitants. Being of 'supernatural,' viz. 'Divine,' order, it can be produced primarily by God alone; it is generated in the soul through the instrumentality, either 'physical' (Aquinas) or 'moral' (Suarez and the Jesuit theologians), of the Sacraments, in and through which the Divine power acts as the primary cause.

4. Actual grace.—(1) *Its existence and nature*.—Besides the supernatural superadded 'organism' (habitual grace, virtues, and gifts) which we have described above, the human soul, in order to produce supernatural actions meritorious of life everlasting, requires, each time, the help of *actual grace*, viz. some internal, transient, supernatural impulse from God, which enables it to perform now a supernatural action. The existence and necessity of this actual grace are emphatically asserted both by Scripture and by the universal Christian tradition; it is, moreover, a logical necessity of the philosophical system in which primitive Christian thought was immersed, and under the influence of which it made its theological evolution. Active grace is rendered necessary by the existence of the supernatural organism of habitual grace and the virtues. 'Quantumcumque aliqua natura corporalis vel spiritualis ponatur perfecta, non potest in suum actum procedere, nisi moveatur a Deo' (Aquinas, *Sum. Theol. Prima Secundæ*, qu. 109, art. 1). At the same time, we understand also that, if the influx of actual grace is indispensable to the act of the free will, that influx must, if it is really meant to supplement, not to pervert, the nature of the will, be of such a nature as to leave the freedom of will unimpaired. In this way we are brought to formulate the two cardinal principles on which the whole problem *de Auxiliis* hinges: (a) the decree of God Almighty (in the present case, the decree of predestination) must ineluctably be fulfilled: anything decreed by God must come to pass; (b) even under the present influence of actual grace, the human will remains always essentially free in its action.

(2) *Sufficient and efficacious grace*.—The maintaining of those two exigencies—the unfailing efficacy of the decree of God and the perfect freedom of the human will from any necessitating

impulse—has ever been and remained the dominant preoccupation of the Church throughout all subsequent controversies. The Pelagian quarrel, the first important one on record on the present subject, gave occasion for the emphasizing of the distinction between 'sufficient' and 'efficacious' grace. That there are sufficient graces, offered by God to every human soul, may be termed, in fact, a Catholic dogma, and that some graces do prove efficacious may be said to be a fact of experience; nevertheless, that plain and obvious distinction was to acquire, through the discussion of the Pelagian tenets, a particular significance.

The real question at issue with the Pelagians was whether any internal grace of any description whatever ought to be considered as strictly or really necessary. God, who had called man to eternal happiness, had already, in the Pelagian view, given him, in his natural resources, as aided by the external graces of revelation and instruction, all that was essentially needed for that purpose. As original sin left in the soul no inherent blemish or unfitness, man, by making good use of his natural faculties, could work out for himself his own salvation. Internal graces (the habitual one perhaps, and the actual ones especially) might exist, did exist; but to assume more than their utility, viz. to assert their necessity, was to declare the will unfit for what it was given for, and consequently destroy its freedom. Those graces ought rather to be considered as favours occasionally conferred by God as rewards for the good deeds performed with the sole natural resources of the free will, but none of them was, at bottom, indispensably necessary.

The disputations aroused by those new doctrines brought forward the towering intellectual personality of St. Augustine, who was to remain henceforth the supreme authority, among the Fathers, on all questions *de Auxiliis*. As the mouthpiece of the Catholic tradition, and the interpreter of the doctrines of St. Paul, he definitively established, against both the Pelagians and that body of otherwise orthodox doctors called Semi-Pelagians, among several others, the following principles:

(1) Those only will be saved whom God has gratuitously predestined from all eternity. (2) Original sin is a hereditary blemish inherent in the human soul. (3) As a consequence of these facts, and owing to the infinite disproportion between the Divine and the natural order, no human being is capable, by his natural resources alone, of producing any supernatural action; or (4) of in any way meriting the first grace (so that the said first grace might in any manner be legitimately understood as being due to him). (5) Actual grace is absolutely necessary for every supernatural action. (6) The actual graces granted to man are the means by which God accomplishes the effect of His eternal predestination, some of them being sufficient only, while others are intrinsically efficacious. (7) Neither sufficient grace, which never carries the assent of the will, nor efficacious grace, which is never resisted, causes any prejudice to the freedom of the will.

Thus, in the idea of Augustine, as ever afterwards universally understood and interpreted in the Church, practically without controversy, until the days of the Reformation, God provided both for the fulfilment of His decree of predestination and for the preservation of the freedom of the will, by granting to the unpredestined only sufficient grace, which they were sure always freely to disobey by their own fault, and by providing for the predestined efficacious grace, which they were sure always freely to follow; for those efficacious graces worked, not by overpowering, but by mysteriously inclining, the will, and causing it to give spontaneously its free assent.

How could it be that, on the one hand, a grace, truly and really sufficient, should never in fact carry the assent of the will, and, on the other hand, that a grace, infallibly efficacious, should always determine the said assent, without, how-

ever, in any way infringing upon the freedom of the will? It was a mystery, which Augustine asserted in the name of tradition and on the basis of the doctrine of St. Paul (in particular, Ro 9), but which remained otherwise unexplained. The attempt to solve that mystery was, at a much later period, to give rise to the various conflicting opinions, and to the endless theological quarrels, many of which have remained undecided even to the present day.

(3) *The systems.*—(a) *Pre-Tridentine development.*

—It was long, however, before the controversy *de Auxiliis* was to be resumed again, when it had been once brought to a temporary conclusion, by the definitive condemnation of the Pelagians, at the Council of Ephesus (431). It was the task of the schoolmen of the Middle Ages to endow the Church with a full and organized theological system, the most perfect monument of which—in fact, the standard systematic exposition of the Catholic doctrine—is to be found in the works of St. Thomas Aquinas (1225–1274), the prince and 'sun' of Catholic theologians, and especially in his *Summa Theologica*. For those doctors, the problem of understanding how the unavoidable inefficacy of sufficient grace and, more especially, the unfailing efficacy of efficacious grace could be reconciled with a genuinely free will appears to have been no puzzle or no particular worry; accepting the mystery as it was, they would all have said quietly with Aquinas: 'As it behoves Divine Providence to preserve, not to pervert, the natures of things, God will move everything according to the requirements of its nature . . . so God moves the human will in such a manner that its motion remains contingent and not necessary' (*Sum.*, prima secundæ, qu. x. art. 4). God 'knew' how efficaciously to incline the will, without infringing on its liberty; that was enough. All He had decreed about man did find its realization; nevertheless, man was and remained, at all times, perfectly free. This, however, is just what the early Reformers, Luther and Calvin, three centuries afterwards, began by denying, maintaining that the human will had been so hopelessly perverted and weakened by original sin, that, having lost its freedom, it had not the power to resist any more, in any case, either the inclination of corrupt nature or the inspiration of grace, both being irresistible in their action. Hence the obedience of the will to concupiscence or to grace—passive, according to Luther; free from coercion only, according to Calvin—was necessary and irresistible in either alternative. As this doctrine involved the denial of the freedom of the will, it was condemned by the Council of Trent in its sess. 6, where it was declared (can. 4, 5, 6) that original sin had not destroyed the freedom of the will.

(b) *Post-Tridentine controversies.*—It had been the work of the Council of Trent to reassert the dogma of the freedom of the human will; it was, however, reserved to one of the most distinguished theologians of the same Council, Michel le Bay, or Baius (1513–1589), of the celebrated University of Louvain, to be the first to offer a solution of the mystery of the reconciliation of the freedom of the will with the infallible efficacy of the Divine decree, which, being in many of its propositions a kind of forerunner of the later Jansenistic tenets, was, after several reproofs, finally condemned in 1580. The effect of that condemnation, pronounced by Gregory XIII., was to stamp out the Baïan doctrines in their original form; but they were soon after revived, by the middle of the 17th cent., in the celebrated heresy which, from its posthumous originator, Bishop Jansen of Yperen (1585–1638), whose *Augustinus* was published in 1640, was to retain in history the name of 'Jansenism' (*q.v.*). The substance of the system, as it can be defini-

tively gathered from the writings of its parent and adherents, is as follows:

Sufficient grace, which would have been sufficient indeed in the state of innocence, before original sin, is now, owing to the fallen state of human nature, really insufficient; for, as it is the ineluctable law of the will, in its present fallen condition, necessarily to follow the more powerful delectation, if grace, in some cases, proves less attractive and delectable to the human soul, the will will necessarily follow the greater delectation of sin, and grace will here have been insufficient 'in fact'; although it may be called sufficient 'in name'; hence, in reality, there are only insufficient and efficacious irresistible graces.

This is not the place to dwell on the various phases of the quarrel, the substance of the system being what we are mostly concerned with; it is enough to say that, crushed, in spite of all evasions, by several successive condemnations, it was finally extinguished in its ultimate form by the bull *Unigenitus*, directed in 1713 against Paschasius Quesnel.

The two fundamental notions, among others, in the Jansenist doctrine of grace, those which distinguish it from the orthodox systems tolerated in the Catholic Church, are therefore: the denial of the real and actual sufficiency—practically of the existence—of sufficient grace, and the assertion of the impossibility of resisting efficacious grace, thereby acknowledging in man no other freedom but freedom from coercion, or forcible compulsion. As against those two cardinal assumptions, viz. insufficient and irresistible graces, the orthodox systems maintain, each in its own peculiar way, that sufficient grace is truly and really sufficient, so that it is intrinsically possible to obey it, although, in fact, man never follows its inspiration, and also that it is intrinsically possible not to obey the impulse of efficacious grace; although such a disobedience will never occur *de facto*.

In the interval of time which divides the condemnation of the Baïan propositions from the rise of the Jansenist controversy, a Jesuit theologian, Luis Molina (1535–1600), published, in the year 1588, a book entitled *Liberi arbitrii cum gratiæ donis, divina præscientia, providentia, prædestinatione et reprobatione concordia*, in which he proposes the following solution of the problem of sufficient and efficacious grace (qu. 14, art. 13, disp. 40):

Sufficient grace gives to man all that is necessary for a supernatural action; by assenting to or dissenting from its impulse, man makes it efficacious himself, God contributing to the determination of the free will nothing beyond a simultaneous concurrence, without which no action of any kind would be possible. Hence, in the Molinist system, the 'determining' cause of the election of the free will was, in each case, that will itself, God being merely a co-operator, working together with the will, 'like two workmen carrying the same stone, or pulling the same boat'—an example, by the way, long before rejected by St. Thomas Aquinas, in the very words afterwards used by Molina.

This doctrine was, from the start, received with marked disfavour by the older Jesuit theologians, and with an outburst of indignation by the Thomistic school—up to that time considered the foremost authority in theological matters.

The Thomists argued that in such a system, the principle of the acquiescence of the free will in the inspiration of grace being the spontaneous choice of the will itself, the efficacy of the decree of God was thereby rendered uncertain, as depending on the arbitrary choice of man; that, moreover, the First Mover was excluded from at least the initial determination, by which the will decided to accept grace and to co-operate with it, which was a metaphysical impossibility, since not even the slightest element of motion or determination could possibly come to existence but from the agency and impulse of God, the efficacy of which must extend to everything, even to the initial determination of the free will; so that otherwise God would not be the universal Prime Mover, and therefore no God. Insisting, as a consequence, that the motion of God, in the case of the free election of the will, must be not only concurrent (viz. subordinate) but predetermining, they clamoured for an examination and condemnation of those revived 'Semi-Pelagian errors,' as the Thomists called them.

At the instance of the Thomists was summoned the celebrated Congregation *de Auxiliis*, which sat from 1592 to 1607 without coming to any definite decision, the only result being a decree

of Pope Paul IV. in 1611, forbidding any further disputation on the subject. The Jesuits, however, who had come gradually to identify themselves, as a body, with the Molinist side in the quarrel, had been made to feel that the doctrine, in its primitive form, was neither safe nor sound enough to hold. Accordingly, in the year 1613 a decree of the General of the Company of Jesus, Claudius Acquaviva, ratified twice afterwards, in two congregations of the Company held in 1616 and 1651, forbade the teaching of sufficient grace as explained by Molina, the Jesuit theologians henceforth un-animously and officially adopting the modified form of Molinism expounded mostly by Suarez (1548–1617) and commonly known by the name of 'Congruism.'

According to this new presentation, what makes the difference between sufficient and efficacious grace is the fact that the former is incongruous, or inappropriate, the latter congruous, or appropriate. In any given case, owing to the dispositions and circumstances in which an individual soul will find itself, some form of grace is sure to be incongruous or sufficient only, some other is congruous or sure to be efficacious; if the Divine eternal decree requires that assent be given to grace, the congruous one will be provided, if not, the incongruous one only will be offered; which, being incongruous, although certainly sufficient, will, owing to the bad dispositions of the subject, remain inefficacious. Thus, the infallible efficacy of the Divine decree is preserved, and the freedom of the will remains safe, nothing happening but what God has decreed—and that through the spontaneous choice of the free will.

But, even in its new garb, the Molinist doctrine fared no better at the hands of the Thomists. They maintained the same objections to it as to the pure Molinist form.

(4) *The other divisions of actual grace* that are commonly proposed, viz. 'operative' and 'co-operative' (*operans* and *co-operans*), 'prevenient' and 'subsequent' (*præveniens* and *subsequens*), 'excitatory' and 'adjuvant' (*excitans* and *adjuvans*), are easily understood. They are merely designations based on the effect which the help of God is understood to exercise on the human soul, in the various different cases.

(5) *The cause of grace*, as being a quality of a Divine order, has always been understood in the Church to be the Deity alone, as first and principal Cause; although it has been the pleasure of God instrumentally to act through the human nature of Jesus Christ, or through the Sacraments, which, for that matter, are merely a prolongation of and a substitute for the said human nature. It is, however, understood also that 'virtus Dei non alligatur sacramentis,' that is to say, although God pledged Himself *always* to grant His grace through the Sacraments properly conferred and received in the right dispositions, nevertheless, He reserves to Himself the right to act and confer grace, even without them, for the benefit of those who are inculpably prevented from receiving the Sacraments. Ministerial causes of grace are the angels through good inspirations, or men through instruction, prayer, and the Sacraments.

(6) *The condition of the reception of habitual grace* (through which alone justification is effected) in the individual soul is, according to the definition of the Council of Trent (sess. 6, can. 6), a conversion or motion of the free will towards God, which, of course, is the effect of efficacious grace; and anathema is pronounced (can. 9) against any one asserting that faith alone, without such a movement of conversion of the free will toward God, is sufficient for justification.

As for the question whether any one may have the certainty of being in a state of justification, the Council of Trent (sess. 6, can. 13 and 14) anathematized the Calvinistic and Lutheran contentions that any one ought to persuade himself that he is in a state of justification, and that that sole and very persuasion is the only cause of the said justification. Hence it may be legitimately

inferred that from a Catholic point of view only a moral and human certainty can, ordinarily, be entertained of that fact.

(7) *Another class of graces*, the very improperly so-called *gratiæ gratis datæ* (gratuitous ones), embraces those supernatural privileges or 'charisms,' sometimes granted to a chosen few, to work miracles, to prophesy, to speak foreign languages, and exercise other miraculous powers of the same kind. With those graces we have nothing to do here, but merely remark that they are not more gratuitous than the ordinary graces (habitual and actual) with which we have been dealing thus far; any one of the latter, by the very fact that it is of a Divine order, is necessarily gratuitous and not due, at least as first grace; nevertheless it is always possible, by making good use of one grace to merit another, for, if Nature cannot, grace can merit grace. See art. CHARISMATA.

(8) *To what kind of acts* must the action of efficacious grace be understood to extend, or what kind of effects can be obtained only through grace? This is the last question that we must now answer, briefly mentioning the definition of the Church or the decisions of the Catholic theologians on the various points.

Grace is not necessary—as is commonly admitted—for acquiring even a vast and extensive knowledge of *natural* truths, as such a knowledge is within the natural capacity of the human mind; but a complete and exhaustive knowledge of all the truths pertaining to the natural order of things could obviously not be understood to exist in any human mind otherwise than through a special favour of God. As for supernatural truth, although it is intrinsically possible for any one to recognize the truth of any doctrine or dogma of faith which is properly expounded and proved to him, an acceptance of it, through a supernatural motive, can be the effect only of a double actual grace both in the mind and in the will (2nd Council of Orange, can. 5 and 6; and Trid., sess. 6, can. 3). It is a dogma of faith that man, even in a state of sin, can do some good works, and therefore that the actions of sinners are not necessarily all sins. This dogma has been repeatedly asserted, against Wyclif and John Hus, by the Council of Constance (sess. 15); against Luther and Calvin, by the Council of Trent (sess. 6, can. 7 and 8); against Baius, by Pius V., Gregory XIII., and Urban VIII. (prop. 35, 38, and 40 of Baius); and against Quesnel, the last of the exponents of Jansenism, who was condemned by Clement XI. (prop. 44, 45 ff.). The same authorities condemned also the assertions of Jansenius and Baius (prop. 25) that all the actions of infidels are sins.

By the condemnation of the 35th proposition of Baius, it became a doctrine of faith that it is intrinsically possible to love God above everything, as Author of the natural order of things by a natural love; such a supreme natural love of God, however, could not be so efficacious, in the present fallen condition of man, as to entail a perfect fulfilment of *all* the precepts of the natural law; for, although in the state of innocence such a thing would have been within the natural, unimpaired resources of human nature, after original sin only a special assistance of God can enable the fallen man to realize the supreme perfection of non-corrupted nature. If, at the same time, we remember that for any precept imposed on him man always receives a sufficient grace, we see that it cannot be inferred, from the above doctrine, that some of the precepts imposed by God are impossible to man—a doctrine condemned by the Council of Trent (sess. 6, can. 18), and by Innocent X., in the first of the celebrated 'five propositions' of Jansenius. Man, in a state of mortal sin, cannot for

ever resist all other temptations and avoid all other mortal sins without a special assistance of God, for the very same reason that he cannot fulfil all the precepts of the natural law, as we have just stated above.

In a state of justification, man is capable, through ordinary graces, of avoiding each venial sin individually; but only through a special and distinct privilege will he be capable of avoiding them *all* for all his life (Trid. sess. 6, can. 23); that special privilege, however, is universally understood, *propter honorem Domini*, to have been granted to the Blessed Virgin.

The Pelagian doctrine that man may merit the first grace by his good works, performed without the help of grace, and the Semi-Pelagian contention that he can prepare himself for it, so as to create, on the part of God, some kind of obligation to confer it on him, were both condemned by the 2nd Council of Orange (can. 3, 4, 6, 7, etc.)—a condemnation reiterated by the Council of Trent (sess. 6, can. 5 and 6)—because no one, except through the use of grace, can make himself in any way worthy of a gift of the Divine order, since by its very nature it infinitely exceeds every human capability. As a consequence, the only orthodox sense that can be attached to the axiom, 'Facienti quod in se est Deus non denegat gratiam,' is the following: to him that through the help of prevenient, supernatural grace does all he can God will not refuse the grace of justification. Impeccable, human, and natural honesty alone does not make any man, in any way, entitled to the gift of grace and of justification. That it should be impossible for man to rise without grace from a state of mortal sin is a doctrine that was denied by no one, not even by Pelagius; it was defined as a dogma of faith in the 2nd Council of Orange (can. 14 and 19).

Each supernatural action requires a corresponding natural motion of God on the free will, since no kind of motion can take place without the action of the Prime Mover; but, since the presence of grace, either habitual or actual, does not remove the inherent defectibility of the human will, a 'long' perseverance appears to be the effect of a special help from God (Orange, can. 10 and Trid. sess. 6, can. 2). Final perseverance, involving the conjunction of a state of justification with the last instant of life, is also certainly the effect of a very special favour of God, as the canons just quoted imply; in fact, it coincides with predestination itself, of which it is the necessary and inseparable effect; it does not, however, consist properly in a peculiar motion, or distinct impulse, but ought rather to be described as the result of an *ensemble* of circumstances brought about by the merciful Providence of God, as an effect of His Divine predestination—circumstances which, of course, will vary with each individual soul.

LITERATURE.—The Literature on the subject of Grace is well-nigh inexhaustible, and we shall therefore limit ourselves to the mention of the most prominent names and works only (cf. *Cath. Encyc.*).

St. Paul, *Epistle to the Romans*, chs. iii.-xi.; Augustine, *de Peccatorum meritis et remissione, de Spiritu et littera, de Perfectione justitiæ hominis, de Gestis Pelagii, de Gratia Christi et de peccato originali, de Correctionibus et gratia, de Prædestinatione sanctorum, de Dono perseverantiæ, de Natura et gratia, de Gratia et libero arbitrio, adversus Julianum*, etc.; Thomas Aquinas, *Sum. Theol.*, prima secundæ, qu. cix.-cxiv.

GENERAL LITERATURE.—The Commentators of Aquinas, in particular among Thomists: C. R. Billuart, *Summa Sancti Thomæ*, ed. Lequette, Arras, 1867-72, l. 'de Deo,' diss. vi.-viii., and ii., 'de Gratia'; 'de Gratia Del.' in *Collegii Salmant. Cursus theol.* ix. and x., Paris, 1870; de Lemos, *Panoplia Divinæ gratiæ*, Liège, 1676; P. de Soto, *de Natura et gratia*, Venice, 1660; A. M. Lépicière, *de Gratia*, Paris, 1907; among Molinists: Bellarmine, Suarez, Vasquez, Ripalda, *de Ente supernaturali*, Cologne, 1648; among later authors: F. Satollé, *de Gratia Christi*, Rome, 1886; C. Mazzella, *de Gratia Christi*, do. 1882; L. Billot, *de Gratia Christi et libero arbitrio*, do. 1908; Heinrich-Gatberlet, *Dogmat. Theologie*, viii., 'Von der

Gnade,' Mainz, 1897; J. Pohle, *Lehrbuch der Dogmatik*⁴, II. (Paderborn, 1909) 329-373, and in the *Catholic Encyclop.*, New York, 1909, vol. vi., artt. 'Grace,' and 'Controversies on Grace.' See also the various recent manuals on Dogmatic Theology, most of which are Molinistic. On the doctrine of the Fathers: J. Habert, *Theol. Græcorum Patrum vindicata circa universam materiam gratiæ*, Paris, 1646; E. Scholl, *Die Lehre des heil. Basilii von der Gnade*, Freiburg, 1881; F. K. Hümmer, *Des heil. Gregor von Naz. Lehre von der Gnade*, Kempten, 1890; E. Weigl, *Die Heilslehre des heil. Cyrill von Alex.*, Mainz, 1908.

ON SANCTIFYING GRACE.—R. Bellarmine, *de Justificatione impii*, ed. Fèvre, vi. (Paris, 1873) 149 ff.; J. Katschthaler, *de Gratia sanctificantis*², Salzburg, 1886; L. Hubert, *de Gratia sanctificantis*, Paris, 1902; W. Liese, *Der heiligmotivende Glaube*, Freiburg, 1902; H. S. Denifle, *Die abendländischen Schriftausleger über justitia Dei und justificatio*, Mainz, 1906; J. B. Terrien, *La Grâce et la gloire*, 2 vols., Paris, 1897; G. Labrousse, *de Virtutibus Theologicis*, Louvain, 1890, *de Gratia divina*, do. 1902; C. Mazzella, *de Virtutibus infusis*, Rome, 1894; F. Satolli, *de Habitibus*, do. 1897; T. J. Bouquillon, *de Virtutibus Theologicis*, Bruges, 1890; B. Froget, *De l'Inhabitation du Saint-Esprit dans les âmes justes*, new ed., Paris, 1901, etc.

ON ACTUAL GRACE.—For the literature pertaining to Pelagianism, Augustinianism, and Jansenism, see the particular articles on each subject; also on actual grace proper: G. Byonius, 'de Gratia auxiliis,' in Becanus, *Theologia Scholastica*, Rome, 1658; Boncat, *Theologia Patrum*, Paris, 1718; F. A. Zaccaria, 'Disa. de auxilio sine quo non,' in *Thesaurus theol.*, vol. v., Venice, 1762; J. Ernst, *Werke und Tugenden der Ungläubigen*, Freiburg, 1871; M. J. Scheeben, *Natur und Gnade*, Mainz, 1861; M. Glossner, *Lehre des heil. Thomas vom Wesen der göttl. Gnade*, do. 1871; A. Palmieri, *de Gratia divina actuali*, Gulpen, 1885; F. Wörter, *Die Geistesentwicklung des heil. Aurelius Augustinus*, Paderborn, 1892; O. Rottmanner, *Der Augustinismus*, Munich, 1892; C. Wolfsgruber, *Augustinus*, Paderborn, 1898.

Besides the authors already mentioned under 'General Literature,' we shall mention: (a) *Thomists*.—D. Bafiez, *Comment. in S. Thomam*, Salamanca, 1684; F. D. Alvarez (one of the theologians of the Congregation 'de Auxiliis'), *de Auxiliis Divina gratia*, Rome, 1612, and *Responsionum libri iv.*, Louvain, 1622; de Lamos, besides the *Panoplia* above mentioned, *Acta omnium Congregationum*, etc., do. 1702 (the history of the Congregation 'de Auxiliis' in which he was a prominent champion of the Thomistic doctrines); P. Ledesma, *de Divina gratia auxiliis*, Salamanca, 1611; J. P. Gonet, *Clypei theologiae Thomisticae*, 16 vols., Bordeaux, 1659-69; V. Contenson, *Theologia mentis et cordis*, Lyons, 1673; A. Goudin, *de Scientia et voluntate Dei*, new ed., Louvain, 1874; V. L. Gottl, *Theologia scholastico-dogmatica*, Venice, 1750; P. M. Gazzaniga, *Theologia dogmatica*, 2 vols., Vienna, 1776; C. R. Billuart, *Le Thomisme triomphant*, Paris, 1725; P. F. A. M. Dummermuth, *S. Thomas et doctrina præmotionis physicae*, do. 1886, and *Defensio doctrinae S. Thomæ*, do. 1896; J. A. Manser, *Possibilitas præmotionis physicae*, Freiburg, 1895; G. Feldner, *Die Lehre des heil. Thomas v. Aquin über die Willensfreiheit*, Graz, 1890; M. Papagni, *La Mente di S. Tommaso*, Benevento, 1901; I. Ude, *Doctrina Capreoli de infusu Dei*, Graz, 1904; Del Prado, *de Gratia Dei et libero arbitrio*, Freiburg, 1907.

(b) *Molinists*.—L. Molina, *Concordia*, new ed., Paris, 1876; F. Suarez, *de Concursu, motione et auxilio Dei*, new ed., do. 1856, 'de Auxilio efficaci,' *Opera*, do. 1856, xi., 'de Vera intelligentia auxilli efficaci,' *Opera posthum.* x., Append.; L. Lessius, 'de Gratia efficaci,' in *Opusc.* II., do. 1878; B. Jungmann, *de Gratia*, Regensburg, 1896; de San, *de Deo Uno: de Mente S. Thomæ circa prædeterminationes physicas*, Louvain, 1894; V. Frins, *S. Thomæ Aquinatis Doctrina de co-operatione Dei*, Paris, 1893; T. de Régnon, *Bafiez et Molina*, do. 1883; J. Pohle, *Lehrbuch der Dogmatik*⁴, II. (Paderborn, 1909) 452-483.

Belonging strictly to neither of the above schools may be mentioned: Bellarmine, 'de Gratia et libero arbitrio,' in *Opera*, ed. Fèvre, Paris, 1873, v. and vi.; F. Wörter, *Die christliche Lehre über Verhältniss von Gnade und Freiheit bis auf Augustinus*, Freiburg, 1856; A. M. de Liguori, *Op. dogmat.*, ed. Walter, New York, 1803, I. 517 f., II. 707 f.; H. Tournely, *de Gratia*, Venice, 1755; W. Herrmann, *de Divina gratia*, Rome, 1904; J. Pecci, *Sentenza di S. Tommaso*, do. 1885; A. Adeodatus, *J. Peccis Schrift*, Mainz, 1868.

E. L. VAN BECELAERE.

GRACE AT MEALS.—The Christian practice of grace at meals has its roots in the religious instincts of the human race. It consecrates even the simple meal. It is a witness to the religious solemnity which is attached to every meal as an act of maintaining human life, and as a means of devoting the fruits of the earth to their highest use. Grace at meals consecrates at once the meal itself, the gifts which are consumed, and those who consume them, to God's service. An invitation to dinner in the 2nd cent. A.D. runs:

'Chaeremon requests your company at dinner at the table of the Lord Saraps (sic) in the Sarapeum to-morrow, the 15th, at 9 o'clock' ('The Oxyrhynchus Papyri,' pt. I. p. 177, *Egypt. Explor. Fund.*, Graeco-Roman Branch, 1896).

Such a meal in the Serapeum witnesses to the religious character even of the social meal. And the custom of libations in pre-Christian times stamps the same religious character on every meal. The Homeric feast was not complete without the σπονδή or λοιβή, the drink-offering poured out either on the hearth, the floor, or the altar, to the gods: αὐτὰρ ἐπεὶ σπονδῆς τε καὶ εἴξας, ἣ θέμις ἐστίν (Hom. *Od.* iii. 45). It was a drink-offering and a prayer, in this case to Poseidon. The Romans practised similar rites. The *secunda mensa*, or dessert, was separated from the earlier part of the meal by the offering of the *mola salsa*, the meal-offering of spelt and salt, and the *libatio* either to the Lares or to some one of the gods. Pliny witnesses to the early origin of the rite: 'Numa instituit deos fruge colere, et mola salsa supplicare' (*HN* xviii. 2). Vergil refers to the libations at the feast before the tomb of Anchises:

'Hic duo rite mero libans carchesia Baccho
Fundit humi, duo lacte novo, duo sanguine sacro'

(*Æn.* v. 771.)

The Jews, like the Greeks and the Romans, consecrated their meals with the *brākḥāh*, or blessing (*EBi*, col. 2996). The sacrificial feast at the high place of the city in 1 S 9¹³ was delayed until the coming of Samuel to 'bless the sacrifice.' This is the earliest example of grace before meat. On the occasion of the reception of the Jewish scholars in Egypt by Ptolemy Philadelphus (285-247 B.C.), it is recorded in a letter of pseudo-Aristeas (c. 200 B.C.) that Elisha the priest, one of the delegates, was asked to say grace (ποιήσασθαι κατευχῆν), and that he said it standing. Josephus says of the Essenes:

'A priest says grace before meat, and it is unlawful for any one to taste of the food before grace be said (πρὶν τῆς εὐχῆς). The same priest, when he hath dined, says grace again after meat; and when they begin, and when they end, they praise God, as him that bestows their food upon them' (*BJ* II. viii. 5).

The treatise *Berākḥōth* proves that this custom was established by the end of the 2nd cent. A.D. Women, slaves, and children were to say grace, though they were free from other religious duties. The blessing of the bread reads:

'Blessed art Thou, O Lord our God, King of the Universe, who bringest forth bread from the earth.'

The blessing of the wine is:

'Blessed art Thou, O Lord our God, King of the Universe, who createst the fruit of the vine.'

Among the forms of grace after meat is:

'Blessed be the Lord our God, the God of Israel, the God of hosts, enthroned upon the Cherubim, for the food which we have eaten.'

The NT witnesses to the grace before meat. Our Lord in the miracle of the Feeding of the Five Thousand blessed the loaves and fishes: εὐλόγησεν καὶ κλάσας ἔδωκεν (Mt 14¹⁹; cf. Mk 6⁴¹, Lk 9¹⁶). In the miracle of the Four Thousand, He gave thanks: εὐχαριστήσας ἔκλασεν καὶ ἔδιδον (Mt 15³⁶, Mk 8⁶). St. John (8¹¹) uses the latter term, εὐχαριστήσας. St. Paul refers to the practice of grace, and states clearly its spiritual meaning:

'Meats, which God created to be received with thanksgiving (μετὰ εὐχαριστίας) by them that believe and know the truth. For every creature of God is good, and nothing to be rejected, if it be received with thanksgiving: for it is sanctified (ἁγιάζεται γὰρ) through the word of God and prayer' (1 Ti 4³⁻⁵).

The earliest witnesses to the practice in the 2nd cent. are Clement of Alexandria and Tertullian. Clement, in his *Pædagogus* (c. A.D. 190), referring to the matter of feasts, says:

'It is meet before we partake of food to bless (εὐλογεῖν) the maker of all things, and to sing (ψάλλειν) when drinking' (II. 4).

In the *Stromateis* (c. 200-202) he speaks of prayers and praises (εὐχαί τε καὶ αἶνοι), and readings (ἐντεύξεις τῶν γραφῶν) before eating; and psalms and hymns (ψαλμοὶ τε καὶ ὕμνοι) afterwards (vii. 7). Tertullian, in his *Apologeticum*, ch. 39 (A.D. 197), refers to prayer before and after meals:

'Non prius discumbitur quam oratio ad deum prægustetur . . . Aequè oratio convivium dirimit.'

St. Basil, writing c. 360, refers to the εὐχαί πρὸ

της τροφῆς and those μετὰ τροφῆς (*Ep. ii. ad Greg.*). And both Tertullian and St. Chrysostom witness to the use of the sign of the cross on such occasions. Tertullian, in his treatise *de Corona* (c. 211), writes: 'ad mensas . . . frontem signaculo terimus,' the sign being used on the forehead (ch. 3). St. Chrysostom says that even swine's flesh is not unclean when received with thanksgiving and marked with the sign of the cross (*in 1 Tim. 4. hom. xii.*).

Dom Paul Cagin (*L'Eucharistie primitive*, Rome, Paris, Tournai, 1912, pp. 252-288) has shown that the prayers for the blessing of the cup and the blessing of the bread in the *Didache* (ch. ix.) are not Eucharistic. They may, therefore, be noted as among the earliest forms of grace at meals.

The *Apostolic Constitutions* (c. 400) gives the first example of the form of words:

'Oratio in prandio: Benedictus es, Domine, qui nutris me a pueritia mea, qui das escas omni carni, imple gaudio et laetitia corda nostra ut . . . abundemus in omne opus bonum in Christo Jesu Domino nostro, per quem . . .' (vii. 49).

The Western practice appears in two monastic rules. The Rule of St. Benedict says:

'Ad mensam autem, qui ante versum non occurrerit, ut simul omnes dicant versum et orent . . . corripatur . . . Similiter autem patiat, qui ad illum versum non fuerit praesens, qui post cibum dicitur' (c. 43 [PL lvi. 676]).

And St. Columban says:

'Si quis non venerit ad orationem supra mensam et post cibum, duodecim psalmos cantet' (*in Poenit.* [PL lvi. 682]).

The earliest Western formularies are in the *Gelasian Sacramentary* (7th cent.). There are six 'orationes ante cibum,' and two 'orationes post cibum.' The first reads:

'Refice nos, Domine, donis tuis, et opulentiae tuae largitate sustenta. Per, etc.

The fourth reads:

'Benedic, Domine, dona tua, quae de tua largitate sumus sumpturi. Per, etc.

The sixth reads:

'Tua nos, Domine, dona reficiant, et tua gratia consoletur. Per Dominum nostrum.'

These appear also in the *Leofric Missal A* of the first half of the 10th century. The second form 'post cibos' reads:

'Satiati sumus, Domine, de tuis donis ac datis: reple nos de tua misericordia, qui es benedictus, qui cum Patre et Spiritu sancto vivis . . .' (*Gelas. Sacr.*, ed. Wilson, Oxford, 1894, p. 298 f.).

The *Leofric Missal* has forms also 'ad cibum benedicendum' and 'ad potum benedicendum.' Among the former is:

'Quod nobis est appositum dei filius benedicat';

among the latter:

'Nos deus et nostra benedicat pocula christus' (*Leofric Missal*, ed. Warren, Oxf. 1883, p. 8).

Two prayers for use at meals occur in the Bobbio MS of the *Sacramentum Gallicanum*. The 'Benedictio ad mensam' is similar to the fourth in the *Gelasian Sacramentary*:

'Benedicantur nobis, Domine, dona tua, quae de tua largitate sumpturi sumus, qui vivis et regnas.'

The 'Benedictio post mensam levatam' is the first example of the memento of the benefactors in the grace:

'Gratias tibi agimus, omnipotens, aeternae Deus, qui nos de tuis donis satiare dignatus es, per famulos ill. Redde illis Domine pro parvis magna, pro temporalibus praemia sempiterna, qui vivis et regnas' (*Muratori, Lit. Rom. Vetus*, Venice, 1748, li. 959).

The order of grace at meals is fully given in the Customaries of St. Augustine's, Canterbury, and St. Peter's, Westminster. The shorter form occurs in reference to the meal of the Lector and the four Servitors:

'Dicit unusquisque secrecius sub silencio "Benedicite"; et . . . istud saltem ad minus devote subjungat: "Cibum et potum servorum suorum Filius Dei benedicat," crucis signum faciendo' (*Henry Bradshaw Society*, vol. xxiii. p. 164; cf. vol. xxviii. p. 104). At the close: 'Versus: "adjutorium nostrum in nomine Domini." Versus: "Sit nomen benedictum." Oratio: "Retribuere" et cetera. "Benedicamus Domino." "Fidelium animae."

The fuller form of grace was used at the common meal in the refectory:

'Et unusquisque . . . in ordine suae conversionis stare debet, priusquam a cantore incipiatur "Benedicite." . . . Atque cantor vel succentor in eodem loco stabit post refeccionem, inchoando "Confiteantur," sive "Memoriam." . . . Incepto autem "Benedicite" ante refeccionem, stabit presidens, sicut et ceteri fratres, ad orientem intentus, atque ad "Gloria Patri," et dum Dominica dicitur oratio et (a) sacerdote profertur benedictio, stabit, sicut et alii, suppliciter inclinatus . . . Sed, prolata benedictione, quicumque eam (scillam) sonaverit, cum pronunciarit sacerdos "Spiritus sancti, Deus," eriget se, et ad mensam superius intrabit. Ceteri vero stabunt inclini, quousque dixerit sacerdos "Per omnia secula seculorum"; atque tunc se erigent omnes in respondendo "Amen" (ib. vol. xxiii. p. 164 f.; cf. vol. xxviii. p. 106 f.).

Grace after meals is referred to in the Customary of St. Peter's, Westminster:

'Incipient omnes pariter sub silencio "Confiteantur tibi, Domine," vel "Memoriam fecit," et, postquam ad "Gloria Patri" et "Sicut erat" se inclinaverint, eriget se sacerdos qui prior est in ordine et dicit: "Agimus tibi gratias," vel "Benedictus Deus in donis suis," ceteris interim inclinantibus' (vol. xxviii. p. 122).

The Canterbury text (Brit. Mus. Coll. MS Faustina C. xii.) is dated 1330-1340. The Westminster text (Brit. Mus. Coll. MS Otho C. xi.) is of the latter part of the 14th century. They represent the Benedictine use at that period. The full grace occurs among the 'Gratiarum actiones' of another Westminster MS, c. 1500, Bodl. MS Rawlinson Liturg., g. 10 [N.C. 15832]. It is printed in vol. iii. of the *Westminster Missal* (H. Bradshaw Soc., vol. xii. pp. 1377-1379).

'Ante prandium gratiam:—Benedicite. Oculi omnium in te sperant . . . et imple omne animal benedictione. Gloria patri. Kyrieleyson. . . . Et ne nos. Oremus. Benedic, domine, dona tua quae de tua largitate sumus sumpturi. Per dominum. . . . Jube, domine (sic), benedicere. Mensae coelestis participes faciat nos rex eterne glorie. Amen.'

'Post prandium:—Deus pacis et dilectionis maneat semper nobiscum. Tu autem domine. Confiteantur tibi domine omnia opera tua: Et sancti tui benedicant tibi. Gloria patri. . . . Laudate dominum. . . . Gloria patri. Agimus tibi gratias, omnipotens deus, pro universis beneficiis tuis qui vivis et regnas. Per omnia secula seculorum. Amen. Laudate dominum. . . . Gloria patri. Sicut erat. Kyrieleyson. . . . Pater noster. Et ne nos. . . . Sit nomen domini benedictum. Retribuere dignare, domine deus, omnibus nobis bona facientibus propter nomen tuum vitam eternam. Amen. Benedicamus domino. Mater ora filium. . . . Ave sancte rex edwarde inter celli lilia. . . . Pro defunctis:—De profundis. . . . Requiem eternam. . . .'

'Oratio:—Absolve, quesumus, domine, animas. . . . Amen.'

This grace after meals explains the order in the Customary of St. Peter's, Westminster, and the reference to founders and benefactors in the later College graces (H. Bradshaw Soc., vol. xii. p. 1378 f.).

Hearne, under date 17th Oct. 1712, refers to a grace written in an old Roman breviary of 1520, and belonging to Norwich, used probably in one of the religious houses of Norwich:

'Benedic, domine, creaturam istius (sic), sicut benedixisti quinque panes in deserto; ut omnes gustantes ex eo (sic) tam corpori quam animae recipiant sanitatem' (*Hearne's Collections*, vol. iii., Oxf. Hist. Soc., vol. xiii. [1888], p. 473; cf. 'Benedictio panis,' in *Rom. Miss. of 1515* [H. Bradshaw Soc., vol. xxxiii. p. 314]).

The College use may be illustrated by the Brasenose College Graces:

'Ante prandium:—Oculi omnium spectant in Te, Deus! Tu das illis escas tempore opportuno. Aperis manum Tuam et imple omne animal Tua benedictione. Mensae coelestis nos participes facias, Deus, Rex aeternae gloriae.'

'Post prandium:—Qui nos creavit, redemit, et pavit, sit benedictus in aeternum. Deus, exaudi orationem nostram. Agimus Tibi gratias, Pater coelestis, pro Gulielmo Smyth episcopo, et Ricardo Sutton milite, Fundatoribus nostris; pro Alexandro Novel et Jocosa Frankland, aliisque Benefactoribus nostris; humiliter Te precantes ut eorum numerum benignissime adaugeas. Ecclesiam Catholicam, et populum Christianum custodi. Haereses et errores omnes extirpa. Victoriis Reginam nostram et subditos ejus defende. Pacem da et conserva per Christum Dominum nostrum.'

¹ Wickham Legg (*Oxf. Hist. Soc.*, vol. liii. p. 212) compares this grace with those in the Sarum Manual of 1501, and with the Latin graces in the early primers and the English in the later primers.

² Wickham Legg writes (*loc. cit.*): 'The idea of the commemoration of benefactors may have arisen from the commemoration of the faithful departed in the Sarum Manual; the primers often have at end: "God save the Church, King, and Realm, and God have mercy on all Christian souls. Amen." But the practice is as early as the Bobbio *Sacramentum Gallicanum*, as quoted above.'

Ante coenam:—Omnipotens et sempiterna Deus, sine quo nihil est dulce nihil odoriferum, misericordiam Tuam humiliter imploramus, ut nos coenamque nostram benedicas; ut corda nostra exhilares; ut quae suscepturi sumus alimenta, Tuo honori, Tuasque beneficentiae accepta referamus: per Christum Dominum nostrum.

Post coenam:—Quod corpora nostra, Deus optime maxime, cibo potuque abunde refecisti, agimus Tibi gratias, quantas possumus maximas: simulque precamur, ut animas nostras verbo et spiritu deinde pascas; ut omnia mala fugiamus; ut quae sint Tibi placitura perfecte intelligamus, diligenter meditetur, et ad ea praestanda toto impetu feramur: per Christum Dominum nostrum.

The first of these, but for the *et* between *omnipotens* and *sempiterna*, has the liturgical stamp in its rhythm and its language. The second is probably of later date; the language is academic, and the *Deus optime maxime* is not liturgical. Wickham Legg says that these two graces stand almost alone (Oxf. Hist. Soc., vol. liii. [1909], 'Brasenose Quatercentenary Monograph,' p. 211 f.).

There is reference to the grace in a roll describing the feast at the enthronization of George Nevill, Archbishop of York, in the year 1466.

Before the feast, 'the minister of the Church doth after the olde custome, in synging of some proper or godly Caroll.' After the feast, and before the ale and wine are brought in, 'all the Chaplyns must say grace, and the Ministers do syng' (Leland's *Collectanea*, ed. Hearne, Lond. 1774, vol. vi. pp. 9, 18).

The French language has preserved the old name *bénédicté* for 'grace.' To say grace is *dire la bénédiction*, or *dire ses grâces*. The English phrase 'ask a blessing' seems a reminiscence of the *Jube, domne, benedicere* of the Church. The Italian has *benedizione della tavola*, the Spanish *bendecir la mesa*.

The English grace at meals in common use is this:

Before meals:—'For what we are about to receive the Lord make us truly thankful, for Christ's sake. Amen.'

After meals:—'For what we have received the Lord make us truly thankful, for Christ's sake. Amen.'

The grace before meals has an echo of the 'sumus sumpturi' of the fourth form in the *Gelasian Sacramentary*.

Another English grace is an echo of the older benediction:

Before meals:—'Bless, O Lord, these gifts to our use, and ourselves to Thy service, for Christ's sake. Amen.'

After meals:—'For these and all His mercies, God's holy name be praised, for Christ's sake. Amen.'

A short Latin grace also used in England is this:

Before meals:—'Benedictus benedicat, per Jesum Christum Dominum nostrum. Amen.'

After meals:—'Benedicto benedicatur, per Jesum Christum Dominum nostrum. Amen.'

French and English Roman Catholics have the following form:

Before meals:—'V. Benedicite. R. Dominus. Nos et ea quae sumus sumpturi benedicat dextera Christi in nomine Patris et Filii et Spiritus sancti. Amen.'

After meals:—'Agimus tibi gratias, omnipotens Deus, pro universis beneficiis tuis, qui vivis et regnas in secula seculorum. Amen. V. Benedicamus Domino. R. Deo gratias. Fidelium animae per misericordiam dei requiescant in pace. Amen' (*Catechisme, ou Abrégé de la Foi*, Rouen, 1878, p. 179).

The old College grace among English Roman Catholics is much the same:

Before meals:—'Benedic, Domine, nos et haec tua dona quae de tua largitate sumus sumpturi per Christum Dominum nostrum. Amen.'

After meals:—'Agimus tibi gratias, omnipotens Deus, pro universis beneficiis tuis, qui vivis et regnas in secula seculorum. Amen.'

These appear in English in the following forms of grace:

Before meals:—'Bless us, O Lord, and these thy gifts, which we are about to receive of thy bounty, through Christ our Lord. Amen.'

After meals:—'We give thee thanks, Almighty God, for all thy benefits, who livest and reignest world without end. Amen' (*The Garden of the Soul*, ed. c. 1862, p. 232).

It used to be regarded as the duty of the head of the house to say grace at his own table, as is illustrated by a statement of Addison in no. 458 of the *Spectator*, Friday, 15th August 1712,

where he censures the false modesty of the English gentleman:

'Our Excess of Modesty makes us shamefaced in all the Exercises of Piety and Devotion. This Humour prevails upon us daily; insomuch, that at many well-bred Tables, the Master of the House is so very Modest a Man, that he has not the Confidence to say Grace at his own Table: A Custom which is not only practised by all the Nations about us, but was never omitted by the Heathen themselves. English Gentlemen who travel into Roman Catholick Countries, are not a little surprised to meet with People of the best Quality kneeling in their Churches, and engaged in their private Devotions, tho' it is not at the Hours of Publick Worship. An officer of the Army, or a Man of Wit and Pleasure in those countries, would be afraid of passing not only for an Irreligious, but an ill-bred Man, should he be seen to go to Bed, or sit down at Table, without offering up his Devotions on such occasions.'

At a public dinner, the Chaplain or the Rector or Vicar of the parish, or some other clergyman, is called upon to say grace. This is also an old custom in some private houses. There is also the custom of the younger children saying grace on behalf of the family. Is it in reference to our Lord's words: 'Yea; have ye never read, Out of the mouth of babes and sucklings thou hast perfected praise' (Mt 21¹⁶)?

The metrical graces in general use in schools were written by John Cennick, a friend of the Wesleys. They were first published in 1741 in his *Sacred Hymns for the Children of God, in the Days of their Pilgrimage* (London, 1741, p. 198).

Hymn cxxx. *Before Meat*:—

'Be present at our Table, LORD;
Be Here, and Ev'rywhere ador'd;
Thy Creatures bless, and grant that we
May feast in PARADISE with Thee.'

Hymn cxxxi. *After Meat*:—

'We bless Thee, LORD, for this our Food;
But more for Jesu's Flesh and Blood;
The Manna to our Spirits giv'n,
The Living Bread sent down from Heav'n.'

There are four more lines in this latter grace, but they have not come into use. The Eucharistic character of Cennick's Grace after Meat is lost in the version published in Bickersteth's *Christian Psalmody* (c. 1833). This more modern form reads:

'We thank Thee, Lord, for this our food,
But bless Thee more for Jesu's blood;
May Manna to our souls be given,
The Bread of life sent down from heaven.'

These metrical graces in their original form breathe in every line the inspiration of the Benedictions of the old Service Books of the Western Church.

LITERATURE.—*DACL*, art. 'Bénédition de la Table'; *EBI*, art. 'Meals'; *DCA*, art. 'Grace at Meals'; H. A. Wilson, *Gelasian Sacramentary*, Oxford, 1894; Henry Bradshaw Society, vols. xii. (1897), xxiii. (1902), xxviii. (1904), xxxiii. (1907); J. Julian, *Dict. of Hymnology*, London, 1892, art. 'Graces, Metrical' (W. T. Brooke); Von der Goltz, *Tischgebete . . . in der altchr. und in der griech. Kirche*, Leipzig, 1906.

THOMAS BARNS.

GRACES.—See CHARITES.

GRÆCO-EGYPTIAN RELIGION.—I. Introductory.—The Macedonian conquest of Egypt is, for practical purposes, the starting-point for any account of Græco-Egyptian religion. Before that time there had been little, if any, interchange of religious ideas between the two countries: such knowledge as the Greeks possessed of Egyptian gods and worship was of the most superficial nature, while there is no evidence, and no likelihood, that the Egyptians cared to make any inquiry as to Greek theology. There had been a commercial intercourse across the Levant which, so far as can be judged from archaeological finds, extended back to the period of the earliest Egyptian dynasties; and at least four centuries before the time of Alexander the Great a factory for Greek merchants was definitely established near the mouth of the Nile. But those who sojourned at Naukratis, though they doubtless reported to their friends in Greece such information as they were able to collect about the customs of the strange country

which they had been privileged to enter, would have little chance of learning more of its religion than could be gathered from observation of the native quarter of the town, in such external details as the forms in which the gods were represented or the manner in which the festivals were conducted. A certain number of Greeks penetrated further into the country as mercenaries in the Egyptian army; but it could hardly be expected that these soldiers of fortune would furnish any reliable account of the theology of their employers. Even after the Persian conquest of Egypt, when the valley of the Nile became more open to foreigners, a Greek traveller with some pretensions to training in the collection of facts was unable to add to the existing stock of information on Egyptian religion anything more than what filtered to him through guides and interpreters; and, if a Greek student actually went to live in Egypt, in order to learn something of the wisdom of the Egyptians, his lessons would appear to have been confined to secular science. Neither Herodotus nor Plato displays any kind of acquaintance with the philosophy of Egyptian religion.

While the Greek visitors to Egypt gathered little knowledge of the Egyptian gods, the Egyptians do not appear to have taken any interest in the Greek gods whom they might have studied at Naukratis. There were, in the Greek quarter of that town, a number of temples; if there existed a strong contingent of merchants from some particular Greek State, they erected a building in which they could worship the protecting deity of their home. Thus the Samians had their temple of Hera in Naukratis, the Milesians theirs of Apollo, the Æginetans theirs of Zeus.¹ If the community was too small or too poor to maintain a separate temple, they could find a place in the precinct of the gods of the Greeks, and there make their dedications to their patron. But the very extensive series of objects connected with religious worship which has been found on the site of Naukratis yields no evidence whatever of Egyptian influence on the Greek cults which had been planted there, or of any notice of the Greek gods by the Egyptians.² So far as the Egyptians were concerned, Zeus, Hera, and Apollo remained as much strangers and foreigners in Naukratis as in their homes across the sea.

It is true that a few sporadic instances are recorded in which a member of one nation would appear to have recognized a god of the other. On the Egyptian side, however, the recognition is practically confined to cases in which a king of Egypt sent a gift to a Greek temple;³ and the motives of such actions were probably political rather than religious. The early Greek dedications to Egyptian gods—*e.g.* to Zeus Thebaïos (Ammon) or to Apis⁴—were probably more genuine acts of worship, but they are extremely rare. The names of Greek visitors which are to be found scratched on the walls of Egyptian temples, so far as they date before the time of Alexander, may safely be disregarded;⁵ there is nothing to show that in any instances they were inscribed as an act of homage to the deity who dwelt in the temple, and they probably testify to the absence, rather than to the presence, of any feeling of reverence in the writers.

The conquest of Egypt by Alexander and its settlement under a Macedonian government which

¹ Herod. ii. 178.

² For descriptions of the objects found at Naukratis, see *EEFM*, 'Naukratis I and II' (1886-88); *BSA* v. (1893-99) 26; *JHS* xv. (1906) 106.

³ Gifts of Amasis to Delphi (Herod. ii. 180); to Lindos and Samos (ii. 182).

⁴ Dedication to Zeus Thebaïos (*CIR* v. (1891) 77); to Apis (*BMCat.* 'Bronzes,' 3208).

⁵ See Sayce, in *PSEA* x. (1887-88) 378, on Greek graffiti at Abydos.

developed into the dynasty of the Ptolemies placed the Greeks in an entirely new relation to Egyptian religion. They were no longer visitors or sojourners in the country; they became domiciled throughout its length and breadth, not merely as officials or in garrisons, but in every rank and occupation. In a few centres they formed more or less cohesive groups, as in the case of the colonists of the Fayum; and the towns of Ptolemais and Alexandria were actually organized on Greek lines; but there were a very large number of Greeks, or at any rate men bearing Greek names, scattered about the Egyptian towns and country districts, probably in a manner and position generally similar to those of the modern Greek settlers in the Egyptian villages to-day. These Greeks would hardly anywhere be sufficiently numerous to establish a centre for the worship of their own gods; but, if they wished to find facilities for invoking divine help, there were temples ready to hand. It is true that the names and attributes of the deities were strange; but the one practical result of the inquiries by earlier Greek travellers into Egyptian religion had been the formation of a catalogue of identifications of Greek and Egyptian gods, which is preserved in the account of Herodotus. These identifications were based on very superficial evidence; still, such as they were, they supplied a sort of traditional connexion, which was rapidly accepted, as may be seen from the names given by the Greeks to the more important Egyptian towns: in nearly every instance these were known to the Greeks as the cities of the accepted Greek equivalents of the principal Egyptian deities worshipped in the respective towns. And there was nothing foreign to the general religious theories of the Greeks in a syncretism of gods; so that it was without difficulty that the Greek settlers entered the Egyptian temples and made their offerings to the native deities on the strength of an identification which would be more or less real according to the degree of culture of the individual worshipper. The more educated might reason out, to their own satisfaction, the similarity of attributes between two different gods; to the ignorant, names were of little account, and it was safest to secure the protection of the accepted lord of the district.

The Egyptian priests, on their side, were probably nothing loth to adopt these new followers of their gods. It was no more alien to the Egyptian than to the Greek religion to identify one of their own deities with a foreigner. Indeed, the Egyptian theology was already a fusion of many systems, drawn from all the nations which had occupied or influenced Egypt throughout its history. From time to time fresh gods had been introduced, only to be absorbed into the general medley of Egyptian religion; and the various rises and falls of the power of the priests had tended to increase the complexity. When the priests held a commanding position in the country, it was all to their advantage to multiply the number of gods and secure fresh endowments for their new creations; when an unsympathetic ruler crushed them and took away their property, they amalgamated gods so that one worship could be supported by the revenues which were no longer adequate for two. It was a small matter to add a fresh set of identifications to those which had been formulated in the past. And the adhesion of members of the conquering race would be welcome to the Egyptian priests, not only on account of the material value of their support, but also as some guarantee that the native religion would receive recognition from the new rulers.

The general result of these tendencies was to produce throughout Egypt a popular acceptance of native gods as the equivalents of Greek ones.

with a crude and imperfect fusion of religious ideas, which formed one, though not the most essentially important, element in Græco-Egyptian religion.

At one point, however, the circumstances were in every way different—at Alexandria. The old temples of the Egyptian village of Rakotis could not have been by any means adequate for the religious needs of the new capital, and fresh provision for worship was therefore necessary. The Greek population of the city would have been sufficient to maintain a cult of a distinctively Hellenic character; but it was drawn from sources too diverse to furnish a preponderating element in favour of any particular Hellenic deity. At the same time, there was too strong an intellectual element in Alexandria to permit of the crude equations which passed muster in the country being accepted for the capital. Above all, here was the residence of the king, who had to solve the problem of governing his mixed races of subjects without doing violence to the ideas of either Greek or Egyptian—to fit Hellenic improvements into the immemorial polity of the Pharaohs—and not the least difficult item in this problem was the religious question. Practically, it was imperative that a presiding deity for the new city and an official cult for the new dynasty should be found of a character which would be acceptable alike to Greek and to Egyptian. The genius of the first Ptolemy and his advisers was equal to the task: an effective solution was reached in the invention of Sarapis.

2. The triad of Alexandria.—(1) *Sarapis*.—The origin of the worship of Sarapis has been traced by different writers to various lands; and possibly every ascription is, in some degree, correct. As a matter of fact, Sarapis came into theological existence at Alexandria in an altogether unusual manner: he was virtually the result of the investigations of a body of philosophers and priests, who collected from all sources and fused together whatever ideas or attributes would be of service for their new conception; and the success which attended their work is shown not only by the wide acceptance of the deity whom they formed, but by the difficulty which subsequent students have experienced in discovering his origin.

The type under which Sarapis is represented is distinctively Hellenic; and there is no reason to doubt the statement of ancient historians that the great statue in the temple at Alexandria, which determined this type, and is well known from many copies, was imported from Sinope, and was originally a representation of Hades, made by Bryaxis.¹ There is more doubt as to the source from which the name of Sarapis was derived; probably it is not Egyptian, and it has been traced, on fairly strong evidence, to a Babylonian origin.² It is not necessary to suppose that it came, with the statue, from Sinope: the name, at any rate, would be learnt at Babylon by Ptolemy and his companions,³ and the statue certainly did not represent a Babylonian god, and would not have been thought by Ptolemy to do so. Ptolemy's committee may well have selected the Babylonian name and the Sinopian statue as suitable elements for their new eclectic deity, without the existence of any previous connexion between the two. Some of their reasons for the choice may be found. Though the name of Sarapis was not Egyptian, it had a superficial resemblance to Osorapis, the Greek form of the name under which the dead Apis-bull was wor-

¹ Tacitus, *Hist.* iv. 83; Plutarch, *de Is. et Osir.* 28.

² A full statement of the argument on this point is given by H. P. Weitz, in Roscher, s.v. 'Sarapis'; further articles in *Étude*, by H. P. Weitz (x. [1910] 120) and by E. Schmidt (xi. [1911] 127).

³ Arrian, *Anab.* vii. 26.

shipped at Memphis;¹ and the recognition of this resemblance influenced the acceptance of Sarapis by the Egyptians, as can be seen in the persistence of Apis-worship in association with temples of Sarapis, described below. This similarity of names may have been the starting-point for the identification of Sarapis with Hades, through the chthonic attributes of the Osirian deity, and have dictated the choice of a statue of Hades to represent the new god: and, again, the statue may have been obtained from Sinope on the suggestion given in the name of the town compared with the Egyptian *sen-api*, 'the house of Apis.' Trivial as these links may appear, they would be sufficient for their purpose of securing the common homage of Greek and Egyptian. Moreover, while the new god was presented to the Greek in an image fashioned according to a type with which he was familiar, and inherited the attributes of a member of the Homeric cycle, yet the chosen Greek divinity was one whose worship had been so little defined that there was no serious difficulty in the way of re-moulding the popular conception of him and enlarging the sphere of his powers. On the Egyptian side, the Osirian element brought into the Sarapis-worship through the medium of Osorapis rapidly led to the removal of Osiris himself from the commanding position he formerly occupied in Egyptian theology, and to his supersession by Sarapis. The summary of the chief records of Sarapis-worship in Egypt will illustrate the foregoing points.

According to the orator Aristides, there were in the 2nd cent. A.D. forty-two temples of Sarapis in Egypt.² This number, which is approximately that of the nomes known to have existed about the same period, suggests that there may have been such a temple in each nome, probably in the chief city, which was regarded as the official centre of worship. This supposition is, to some extent, borne out by the notices of the Sarapeion at Oxyrhynchus contained in papyri, which show, incidentally, that it was a building of considerable size, almost as large as the temple of the special local deity Thoeris, and larger than the theatre or the gymnasium, to judge from the number of guards assigned to each of these places.³ It is hardly likely that Aristides would include in his reckoning, or, indeed, be aware of, such out-of-the-way temples of Sarapis as that of which a dedication—later, indeed, than his time—has been preserved at Senskis near the emerald mines of the Eastern desert;⁴ many such local shrines may have existed. But, apart from Oxyrhynchus, the only nome-capital which has yet furnished any considerable body of documentary evidence concerning its temples in Græco-Roman times, there are only three places where Sarapis was worshipped, which are likely to have been included in the forty-two temples of Aristides, as to which any definite information exists. The most important of all was, of course, the temple at Alexandria, the first seat of the worship of Sarapis in Egypt, and the resting-place of the original image. It is unfortunate that excavations on what is unquestionably the site of the Sarapeion—the mound marked by the column of Diocletian, or 'Pompey's Pillar'—have failed to give any plan of the temple or of the surrounding buildings.⁵ If the representations on coins can be

¹ There may also have been a temple of Osorapis at Rakotis; an early Ptolemaic religious handbook (*Cairo Catalogue*, 'Demot. Papyrus,' no. 81169) mentions the House of Osiris at Rakotis. The name of Rakotis itself may have suggested a link in the chain of connexion, as Spiegelberg identifies the Rakotis of a Cairo inscription (*Cairo Catalogue*, 'Demot. Inschriften,' no. 81110) with the Sarapeion of Memphis.

² Aristides, xiv. (sic *Σαράπις*) 82.

³ *P. Oxy.* 43. li. 7.

⁴ *CIG* III. 4830.

⁵ A description of the work on the site of the temple at Alexandria is given by G. Botti, *L'Acropole d'Alexandrie et le Sérapéum*, Alexandria, 1895; additional details in *BSA* 4, 1899, vi.

trusted, the temple itself was of Greek architectural style;¹ and with this the scanty remains found on the spot agree. Besides the actual shrine, there must have been a great mass of other edifices round it, which were used for secular purposes, such as the library and the archives, though included under the general name of the Sarapeion.² The records of the worship have vanished with the walls; but one interesting discovery was made on the site, in the form of a statue of an Apis-bull dedicated to Sarapis in the reign of Hadrian,³ which shows that the connexion of ideas which had originally arisen from the similarity of the names of Sarapis and Osorapis still persisted. At Memphis, a second great centre of the cult of Sarapis, the persistence of the Apis-element was even more marked, as was only natural in the home of the worship of Apis: by the side of the funerary temple of the bulls there arose a Greek Sarapeion, which seems to have been the chief in a considerable group of religious or semi-religious buildings, and to which the older shrines, such as those of Apis and Ptah, became subordinate. In this case, also, excavation of the site has provided little evidence of the nature of the temple or of the worship; the architectural remains are of a very obscure character, and the minor objects found have little connexion with Sarapis. Papyri show, however, that the place harboured, besides the priests of the temples, a number of recluses,⁴ and provided an industry in dream-oracles; the sign-board of an interpreter of dreams was discovered.⁵ The cult of the sacred bull, however, lasted on until Roman times, and the name of Osiris Apis, or Osorapis, occurs regularly in demotic, and occasionally in Greek, documents.⁶ At the third great temple, that of Abydos, it was not Apis, but Osiris, that Sarapis had supplanted; and here, in fact, Sarapis almost became a Greek translation of Osiris. Thus the stelæ placed over the graves in the great cemetery of Abydos, which were commonly decorated with a scene of Osiris seated in state to receive the dead man in the lower world, according to Egyptian tradition, when inscribed in hieroglyphs or demotic are addressed to Osiris, when in Greek to Sarapis.⁷ Perhaps the clearest instance of the equation is to be found in a bilingual inscription, where not only is the name of Osiris in the Egyptian version rendered by Sarapis in the Greek, but the name of a man Psenusire is translated as Sarapion.⁸

On the Egyptian side, therefore, it may be taken that the worship of Sarapis to a certain extent absorbed or coalesced with that of Osiris and of Apis; and at the same time from the Greek point of view he was identified with several Hellenic gods. As the supreme deity of Alexandrian theology, he naturally took the place of Zeus; and the compound title of Zeus-Sarapis is a common one. This equation again reacted on Egyptian connexions, and through the old form of Zeus

¹ *BMCat.*, 'Gr. coins, Alexandria,' pl. xxviii. nos. 872, 1252; pl. xxix. nos. 637, 876; Dattari, *Numi Augg. Alexandrini*, pl. xxx. nos. 1142, 1150, 1967, 3060 bis.

² J. G. Milne, *Hist. of Egypt*, v. (London, 1898) 219.

³ Botti, in *BSAA*, 1899, iv.

⁴ The 'Sarapeum-papyri' are discussed by W. Otto, *Priester u. Tempel*, I. 115 ff.; a list of the papyri in question is given in note 6 on p. 115. See also R. Reitzenstein, *Die hellenistischen Mysterienreligionen*, Leipzig, 1910, p. 71 ff.

⁵ *Cairo Catalogue*, 'Greek Sculpture,' no. 27567.

⁶ Examples in demotic are *Cairo Catalogue*, 'Demot. Denkmäler,' nos. 23173, 23182, 31104, 31110; in Greek, *P. Leyd.* G, 10; H, 1; *P. Lond.* 18, 23.

⁷ Numerous examples of these stelæ exist in various museums. Typical specimens in the *Cairo Catalogue* are: hieroglyphic—'Stèles hiéroglyph. d'ép. ptol. et rom.' nos. 22122-40; demotic—'Demot. Inschriften,' nos. 31091, 31097, 31098; Greek—'Greek Inscriptions,' nos. 9208-11. Similar stelæ are found in other cemeteries besides that of Abydos, as far north as the Fayum and Sakkara; but Abydos is the home of the type.

⁸ *CIG* III. 4909.

Ammon brought in the attributes of Amen-Ra from native traditions. Amen-Ra being a sun-god, Zeus Ammon Sarapis was further united with Helios—a union which was probably strengthened by the solar elements present in the worships of Osiris and Apis. The traditional ascription of the type-statue of Sarapis linked him with Hades; and in this again the Osiris idea would be another point of contact, in view of the chthonic powers of Osiris. Finally, to emphasize the universal nature of his domain, over sea as well as over land, sky, and the lower world, Sarapis was joined with Poseidon. Assertions of these identifications are to be found not only in inscriptions bearing such titles as Zeus Helios Sarapis,¹ or, carrying translation further into the Roman cycle of gods, Jupiter Neptunus Sarapis;² or in types such as that found on Alexandrian coins, where Sarapis wears the horn of Ammon and the radiated diadem of Helios and carries the trident of Poseidon, to which attributes are added the staff of Asklepios and the cornucopiæ of Nilus;³ but, in the more emphatic statements of a graffito, *εἰς Ζεὺς Σαρᾶπις καὶ Ἡλίου Ἐρμανούβης*,⁴ and of the emperor Julian, *εἰς Ζεὺς, εἰς Ἄϊδης, εἰς Ἡλῖός ἐστι Σαρᾶπις*.⁵

There are two facts which appear to point to a marked individuality in the worship of Sarapis. Although he is addressed by compound names, it is very rare to find a distinctive epithet attached to these. Practically the only special title which is given to Sarapis is that of *Polieus*, which occurs in inscriptions at Xoïs⁶ and Koptos,⁷ and may be due to his identification with Zeus. This title recalls Julian's mention of him as *πολιεύχης θεός* of Alexandria. There is hardly any variation in the form under which he is represented; usually he appears in the type which is accepted as that of his statue at Alexandria, seated on a high throne, wearing on his head the modius, resting his left hand on a sceptre, and extending his right over a three-headed Kerberos before his feet; more rarely he is shown standing, with the same attributes. The only remarkable type, in addition to the compound one noted above, is one which is found on Alexandrian coins of the 2nd cent. A.D., and was also used on seal-rings, where a serpent is shown with the head of Sarapis, sometimes associated with a second serpent with the head of Isis.⁸ The popularity of this type may perhaps be ascribed to Gnostic influence; in origin it may be a reminiscence of the sacred serpent of Ra, or of the representations of some of the infernal deities as they appear in the royal tombs of the New Kingdom.

The wide-spread popularity of the worship of Sarapis may be deduced from records of many kinds. The official importance of his temple at Alexandria, as practically the centre of the State-religion, made it the home of the great library and the depository of the archives; and the neocorate of this temple was an honour accepted by Romans of high rank.⁹ A more interesting light on his position in the minds of the people generally is thrown by the papyri from Oxyrhynchus, in which are found invitations to banquets *εἰς κλίβην τοῦ κυρίου Σαρᾶπιδος* in the Sarapeion or elsewhere,¹⁰ with which may be compared the statement of Aristides, that men make Sarapis their companion at feasts and name him as guest and host:¹¹ the idea of banquet-

¹ e.g. *Alexandria Museum Catalogue*, 'Iscrizioni gr. e lat., nos. 87, 97, 100.

² *CIL* viii. 1002.

³ *BMCat.* pl. xv. no. 744; Dattari, pl. xxiv. nos. 2380, 3383, 2968.

⁴ *REG* II. (1889) 176.

⁵ Julian, *Or.* iv. 176, 23 H.

⁶ *JHS* xxi. (1901) 275.

⁷ *Annales du Service des Antiquités*, 1907, p. 49.

⁸ *BMCat.* pl. xiv. no. 1106; Dattari, pl. xxii. nos. 1827, 2931; *JHS* xxvi. (1906) 43.

⁹ A list of references to νεοκόροι of Sarapis is given in Otto, l. 118, note 8.

¹⁰ *P. Oxy.* 110; 523.

¹¹ Aristides, xiv. 27.

ing with the gods has a Homeric flavour, which may be explained by the fact that the Greek-speaking population of Egypt was thoroughly soaked in Homer. Another proof of the importance of Sarapis may be found in the frequency with which his image was used as a device on signet-rings; particulars of the seals of witnesses to documents at Oxyrhynchus show six instances of figures of Sarapis out of a total of thirty-five signets, and in a collection of one hundred and ten types of sealing found at Karanis in the Fayum, twenty-two bear representations of him: in each case, the only god who occurs nearly so frequently is Harpokrates.¹ Perhaps the most noteworthy evidence, however, is given by private letters; if the writer expressed a prayer for the welfare of a friend, it was almost invariably addressed to Sarapis; other gods are found only in sporadic instances.

But, despite these constant invocations of Sarapis, and despite the statements of Aristides, it may be doubted whether this deity was really regarded either by Egyptian or by Greek as one who took an intimate part in human affairs. To the multitude, he was probably the official supreme ruler of the universe, to whom prayers might be addressed and offerings made; but he was not a domestic god, in the sense of one whose image would be placed in a house as its immediate protector. Statuettes of Sarapis in terracotta or bronze—the cheapest materials available in Egypt, and therefore commonly used for the production of representations of gods for the mass of the population—are comparatively rare; in this respect he did not inherit the position of Osiris, bronze figures of whom, in all degrees of workmanship down to the very rudest, are found in profusion among the remains of the period of the New Empire. He might be equated by theologians with Osiris and with Apis; but the former, as a deified man, and the latter, as a deified animal, alike possessed connexions with the visible world from which Sarapis was far removed. And it would appear that the real importance of the worship of Sarapis was due to the express sanction of the State, and that it was mainly followed in the great temples without exercising much practical influence on the daily life of the people.

(2) *Isis*.—In accordance with the religious ideas of Greeks and Egyptians alike, Sarapis had to be supplied with a consort; and for this purpose the choice of the Ptolemaic god-makers fell on Isis. To some extent, no doubt, their selection was guided by the fact that Isis was associated with Osiris as his wife by native Egyptian theology: but there were more important considerations than this. Probably the determining factor was the extent to which the worship of Isis had absorbed or overshadowed that of all other female deities during the New Kingdom period; and a further reason for her selection may be found in her identification by Greek writers with Demeter,² which gave her a connexion with a very popular Greek divinity. But the Alexandrian conception of Isis developed on very different lines from that of Sarapis. There was, of course, in her case no need for a fresh definition of powers; she was sufficiently well known throughout the land of Egypt, and her temples existed everywhere. She accordingly remained far more distinctively Egyptian than Sarapis; her equation with Demeter had practically no influence on her cult, and the Greek attributes and Greek ideas which were attached to the worship of Sarapis find no parallel in that of Isis.

The most famous centre of the worship of Isis was at Philæ, where extensive buildings dedicated to her and the gods honoured with her, and erected

¹ *JHS* xxvi. [1906] 32 ff.

² Herod. ii. 59.

almost entirely in Ptolemaic and early Roman times, are still extant; and this was one of the last strongholds of the pagan religion in its struggle with Christianity. As late as the middle of the 5th cent. A.D. devotees still visited the shrine,¹ and the importance of the goddess is more definitely shown by the fact that she became the subject of a special clause in a treaty between the Roman emperor and the barbarian Nobatæ, whereby the latter secured access to Philæ at stated times for purposes of worship of Isis.² These temples must have possessed extensive property and revenue; the whole of the land bordering on the first cataract seems to have been dedicated to them, and it is probable that they also derived an income from the customs levied on goods passing the Egyptian frontier at Syene,³ while the priests collected offerings for Isis of Philæ at least as far away as Thebes.⁴ At the other end of Egypt, there seem to have been several temples of Isis at Alexandria and in the vicinity; probably her chief importance there, apart from her association with Sarapis, lay in her position as protecting deity of the Pharos, which brought her the homage of the sailors and others connected with the port. It is noteworthy that one temple of Isis represented on Alexandrian coins⁵ is of Egyptian style, whereas all the other religious buildings which appear in the coin-types are Greek in their architecture. Elsewhere in the Nile valley references to temples or shrines of Isis are numerous; but everywhere these temples, so far as can be judged, might be classed as secondary to those of the chief local divinities or of Sarapis. For instance, the temple of Isis at Tentyra, which was rebuilt under the Ptolemies and Augustus,⁶ is overshadowed by the neighbouring temple of Hathor-Aphrodite; at Oxyrhynchus the Isieion, which is mentioned on papyri, was assigned only one guard, as compared with seven for the temple of Thooris and six for that of Sarapis;⁷ and the frequent allusions to shrines of Isis in the villages of the Fayum suggest wayside chapels rather than important buildings.⁸

Isis was rarely identified in actual worship with any Greek goddess. It has already been remarked that her equation with Demeter, stated by Herodotus, had little influence on later belief, though it may perhaps be traced in some Alexandrian representations of her. Very occasionally, also, she was assimilated to Aphrodite: this was due to the fact that Hathor, who was regarded as the Egyptian representative of Aphrodite, had tended in earlier Egyptian theology to become identified with Isis.⁹ This is one respect in which the development of the worship of Isis presents a marked contrast to that of Sarapis, and another is in the matter of epithets. While Sarapis, as has been seen, scarcely ever received any special title, Isis was constantly localized by distinctive names.

Thus at Alexandria she was known as Isis Pharia,¹⁰ Isis Plousia,¹¹ Isis Sothis,¹² and Isis of Menuthis;¹³ at Memphis, Isis of Malalis is mentioned;¹⁴ in the Fayum, Isis Nepherses¹⁵ and

¹ *CIG* iii. 4945, 4946.

² Priscus, fr. 21.

³ The evidence as to the property and revenue of the temples of Philæ is collected in K. Sethe, *Dodekaschoinos*, Leipzig, 1901.

⁴ U. Wilcken, *Griech. Ostraka*, Leipzig, 1899, nos. 412-421.

⁵ *BMCat.* pl. xxviii. nos. 642, 879; Dattari, pl. xxx. nos. 1161, 1972.

⁶ *CIG* iii. 4715.

⁷ *P. Oxy.* 43. ii. 14.

⁸ e.g. *P. Tebt.* 5, 70; 62, 48; *Griech. Urk. aus den königl. Mus. zu Berlin*, 387, 3; *BCH*, 1902, p. 112.

⁹ Isis-Aphrodite appears to be represented in a class of figurines of the type of Aphrodite with the headdress of Isis; e.g. *Berlin Mus. Cat.* nos. 7763, 11892, 13791-2; *Cairo Cat.*, 'Greek Bronzes,' nos. 27652-4.

¹⁰ *CIG* iii. 4683b; a common coin-type, e.g. *BMCat.* pl. xvi. nos. 1113, 1119; Dattari, pl. xvii., nos. 1756, 1767.

¹¹ *Alexandria Mus. Cat.*, 'Inscr. gr. e rom.', no. 71.

¹² Coin-types—*BMCat.* pl. xvi. nos. 1121, 1389; Dattari, pl. xvii. nos. 929, 2681.

¹³ *CIG* iii. 4683b.

¹⁴ *JHS* xii. [1891] 384.

¹⁵ *Griech. Urk. Berl.* 1, 26; 719, 10; *P. Amh.* 35. 4; *P. Lond.* 353, 9; *GGN*, 1892, p. 532, *et scæpe*.

Isis Nephremmis¹ were associated with the cult of Soknopaios at Soknopaiou Nesos and Nilopolis, at the former of which a dedication to Isis Sononais² has also been found; and in the village of Nabilia there was a temple of Isis Nanaia;³ a dedication, the find-spot of which is not known, is addressed to Isis Esenchebis;⁴ there is a record of a priest of Isis Ophis at Hermopolis;⁵ at Akoris she is invoked as Isis Mochias;⁶ at Pathyris the names of Isis Pathyra,⁷ Isis Nemes,⁸ and Isis Rhesakemis⁹ occur; most fitly of all, at Philæ she was worshipped as Isis Myrionymos,¹⁰ a title also used in the neighbouring desert and in Nubia. The address of a magical papyrus to Isis as *ἡ ἀνώνυμος* was fully justified.¹¹

The form in which Isis was represented in art, while not so definitely fixed as in the case of Sarapis, shows little material variation, and naturally is more Egyptian in character. The crown of horns and disk and the vulture head-dress of the native goddess were usually reproduced in Græco-Roman figures; and, though the drapery often shows the influence of the Greek *chiton* and *peplos* in its treatment, it is not very different from that of older representations.¹² The ordinary types are a standing figure, fully draped, and Isis seated on a throne nursing the infant Harpokrates. On Alexandrian coins there are other types, which are more Greek than Egyptian in their conception, such as Isis Pharia holding a sail bellying in the wind, or Isis Sothis riding on a dog; as the city-goddess of Alexandria also Isis is shown holding the rudder of Tyche.¹³ Terracotta or bronze statuettes of a nude female figure wearing the crown of Isis are not uncommon; these may be referred to the compound form of Isis and Aphrodite.¹⁴

The name of Isis, with or without epithets, singly or in conjunction with other gods, occurs far more commonly than that of any other deity in the written records of Græco-Roman Egypt. But her hold on the minds of the people generally was probably hardly so great as might be inferred. Her temples, apart from the great centre of her worship at Philæ, and possibly at Alexandria, appear, as has been already noted, to have been of small size, though very numerous: thus in the village of Kerkeosiris in the Fayum there were two Isieia, but neither of them owned any land;¹⁵ and their general status may be judged from the terms of a decree of Ptolemy Euergetes II., in which Isieia are classed with animal-shrines as minor temples.¹⁶ So far as there is any mention made of resort to these village temples, it would appear to have been only for purposes of treatment in illness.¹⁷ At Alexandria, Isis Pharia was the protectress of sailors; but there is no evidence of her holding a like place anywhere in the Nile valley, unless the occurrence of a priest of Isis in the temple of the Dioskouroi at Oxyrhynchus is in this connexion.¹⁸ There are not many remains of monuments to testify to the worship of Isis; statues of her, of any size, belonging to this period are practically unknown; and, while Græco-Roman bronze and terracotta statuettes exist, they are by no means common, nor does her figure appear frequently on coins or signets. The most frequent type in these lesser representations is that of Isis suckling Harpokrates, and in this she may owe her popularity to the association with her child. The general impression derived from the references to Isis is that she retained a certain importance amongst the Egyptians as an old-established

deity, whose priests were much in evidence at her many wayside shrines, and who kept themselves before the public for the purpose of raising money, as was rendered necessary by their lack of endowments—in doing which they turned to practical use the traditional knowledge, especially of medicine, of which they were heirs; but that, so far as her personality actually appealed to the multitude, it was in virtue of her position as mother of another god—Harpokrates.

(3) *Harpokrates*.—Harpokrates, who was the deity selected to complete the Alexandrian triad, was, like Isis, distinctly Egyptian in origin; but the lines on which his worship developed were different from those taken in her case, as well as in that of Sarapis. Harpokrates did not, like Sarapis, absorb the powers and functions of other independent deities under one name and type; nor did he, like Isis, become localized by distinctive epithets. Originally he was a special form of Horus; and, starting from this point, he gradually took over not only the cult of Horus itself, but also those of all the other special forms which had been accepted in different districts.

There is no record of any temple in Egypt dedicated primarily to Harpokrates; where he is mentioned in connexion with any temple-worship, it is always in association with other gods, of whom Isis is normally one; for instance, at Philæ the group is Isis, Sarapis, and Harpokrates;¹ at Koptos: Isis, Harpokrates, and Pan (Min);² in the Fayum: Isis, Sarapis, Harpokrates, and some form of Souchos;³ although individual priests of Harpokrates occur, and offerings might be made to him alone.⁴ It would appear that, to the priests, he was pre-eminently, as his name implied, Horus the child, and was not to be separated from his mother Isis.

The equation of Harpokrates with other forms of Horus involved many ramifications, which illustrate the complication of later Egyptian theology. Under the New Empire, Amen-Ra, the predominant deity, had supplanted, by a nominal identification, many local gods; thus at Herakleopolis Magna he was regarded as the equivalent of Har-shofi; at Mendes and Heliopolis, of the sacred ram; at Sais, of Sebek, the son of Neith; at Memphis, of Ptah; at Koptos, of Min; at Thebes, of Month. And, in his turn, Amen-Ra had been ousted by Horus in almost every place; so that, in the Ptolemaic period, while Sarapis took the name of Ammon from Amen-Ra, Harpokrates, as successor of Horus, secured the local attributes of the gods with whom Amen-Ra had been identified.

Thus at Herakleopolis Magna, where Har-shofi had been translated by the earliest Greek visitors into Herakles, there appeared the compound Herakles-Harpokrates,⁵ who is represented on nome-coins with the club of the Greek hero surmounted by the hawk of Horus, and wearing a lion's skin and a modius.⁶ Another Alexandrian coin-type shows Harpokrates accompanied by a ram,⁷ which may refer to either the Mendesian or the Heliopolitan form; and terracotta figures of Harpokrates seated on a ram are not uncommon.⁸ On coins of the Menelaite nome there is a compound figure consisting of the head and shoulders of Harpokrates placed on the body of a crocodile,⁹ derived from the union of Harpokrates and Sebek. Ithyphallic statuettes of Harpokrates, common in terracotta, point to his equation with Min. The type of Harpokrates with the goose,¹⁰ formerly sacred to Amen-Ra at Thebes, shows that he had taken over the attributes of the older god in the centre of his worship. Other special forms are Harpokrates of Pelusium, whose emblem is a pomegranate,¹¹ and Harpokrates of

¹ *Griech. Urk. Berl.* 337, 3; 916; *P. Lond.* 358, 9.

² *Hermathena*, xxi. (1895) 243.

³ *APF* iii. (1906) 131, no. 8.

⁴ *CIG* iii. 4703.

⁵ *Griech. Urk. Berl.* 903.

⁶ *CIG* iii. 4915, 4922.

⁷ *Of. Edgar, Cairo Cat.*, 'Gr. Bronzes,' p. v.

⁸ For references to coin-types of Pharia and Sothis, see above, p. 378, notes 10 and 12; as city-goddess, Dattari, pl. xxiv. no. 8270.

⁹ *P. 378*, note 9.

¹⁰ *P. Tebt.* 88, 29-34.

¹¹ e.g. *P. Amh.* 35; *P. Tebt.* 44.

¹² *P. Lond.* 845, 3.

¹³ *P. Amh.* 128, 66.

¹⁴ *RTV* x. (1888) 140.

¹⁵ *REG* iv. (1891) 46.

¹⁶ *P. Lond.* 121, 492.

¹ *APF* i. (1901) 205, no. 17.

² *Milne, Hist. of Egypt*, v. 184.

³ *P. Tebt.* 298, 7; 302, 3; *P. Lond.* 345, 3.

⁴ e.g. *P. Lond.* 258, 315; *Milne, Hist. of Egypt*, v. 189.

⁵ *Berlin Mus. Cat.* no. 10231.

⁶ Dattari, pl. xxxiv. no. 6254; cf. pl. xiv. nos. 1717, 1718;

BM Cat. pl. xvii. no. 766.

⁷ *BM Cat.* pl. xvii. no. 769; Dattari, pl. xiv. nos. 1734-7.

⁸ e.g. *Berlin Mus. Cat.* 8794.

⁹ Dattari, pl. xxxiv. no. 6309, xxxvi. no. 6318.

¹⁰ e.g. *Berlin Mus. Cat.* nos. 9106, 9188, 9325, 10752, 12416.

¹¹ Dattari, pl. xiv. no. 1739; *BM Cat.* pl. xvii. no. 764.

Taus and of Buto, squatting on a lotus-flower,¹ or seated on a sphinx,² all of which are found as Alexandrian coin-types, while the two latter also occur on signets and in statuettes.

The rarity of any record of the worship of Harpokrates in temples is more than compensated by the evidence as to his popularity among the inhabitants of Egypt generally, which is given by the minor representations of him. As has already been noted, his image seems to have been almost as common a device for signet-rings as that of Sarapis; and the same may be said in respect of coin-types. Signets and coins, however, are mainly useful as records of the ideas of the trading classes; the religious preferences of the humbler ranks of the population can better be judged from the statuettes which supplied the household images and are found in the ruins of the Egyptian villages of the Græco-Roman period—more especially those of terracotta, the cheapest available material for such representations. Among the terracotta statuettes which occur in profusion on every Græco-Roman site in Egypt, those of Harpokrates, in all manner of attitudes, with varying attributes, and of every kind of execution, far outnumber those of any other god, showing him to have been pre-eminently the household god of the *fellahtn*.³ Harpokrates was, indeed, the nearest to men of the Alexandrian triad; not only the traditional humanity which he inherited from Horus, as one who had once reigned in Egypt, but the necessary anthropomorphism of the idea of a child-god, made him more readily understandable to the common people than an almighty and omnipotent ruler of the universe such as Sarapis; while there was none of the mystery attached to his worship which the priests, to magnify their position, had imported into that of Isis.

Briefly, the respective positions of the three Alexandrian deities may be summed up as follows: Sarapis was the official god of the ruling class and the central object of the State-worship in the chief temples; Isis was the special property of the old priestly class, to whom was attached the traditional religious lore, whose stronghold was the wayside shrine; Harpokrates was the god of the lower classes and of the home.

3. The fusion of Greek and Egyptian gods.—While the influence of the Alexandrian triad was predominant throughout Egypt from the Greek conquest till the general adoption of Christianity, other gods, both of the natives and of the invaders, were not wholly absorbed or forgotten. So far as the cults of these deities remained uninfluenced by foreign ideas—so far, that is, as the Egyptian gods continued to be worshipped under purely Egyptian forms, and the Greek under Greek—it hardly belongs to the history of Græco-Egyptian religion to discuss the records concerning them. But the nominal identification of gods of the two races, which had begun as soon as Egypt was opened to the Greeks, was carried further in some cases and resulted in a fusion, more or less logical and more or less complete, of Greek and Egyptian ideas into what were so far new forms as to deserve separate treatment.

(1) This process of fusion perhaps went furthest in the case of *Hermanubis*. The name was a Greek adaptation of the Egyptian Har-m-anup, a compound of Horus and Anubis, the latter of whom, in later Egyptian theology, had enjoyed considerable importance as the messenger of the gods who guided the souls of the dead into the presence of Osiris. The sound of the first part of the name,

¹ *BM Cat.* pl. xvii. no. 1130; Dattari, pl. xiv. nos. 1725, 2576, 2577, 4942; *Berlin Mus. Cat.* nos. 1908, 2414, 9099.

² *BM Cat.* pl. xvii. no. 460; Dattari, pl. xiv. nos. 1726, 2464.

³ Cf. Hogarth, *BSA* v. [1898-9] 86, on terracottas from Naukratis, and Petrie, 'Roman Ehnasya' (*EEFM*, 1904).

and the functions attaching to the second, would readily suggest to a Greek mind an identification with Hermes Psychopompos; and from this identification a type arose which represented Hermanubis in the form of a youth wearing Greek dress, crowned with a modius, and carrying a palm-branch and a caduceus.¹ This type was almost entirely Greek or Alexandrian; but it was occasionally varied by the importation of an Egyptian element, the jackal-head of Anubis being placed on the human body of Hermes.² Another variation was produced by the substitution of a radiated diadem for the modius, possibly with some recollection of the solar attributes of Horus derived from the original Egyptian name:³ this form is the Helios Hermanubis, whose identity with Zeus Sarapis is recorded in the graffito already mentioned. But Hermanubis did not absorb the worship of Anubis; the compound name is rarely found, while invocations of, and dedications to, Anubis are fairly frequent; and it was Anubis, not Hermanubis, whose fame spread from Alexandria throughout the Roman world, and who was worshipped with Isis and Osiris by Roman devotees.

The equation of Hermes with Anubis, and their union in Hermanubis, did not prevent the further identification of Hermes with other Egyptian deities. The early Greek travellers had regarded Thoth, the god of learning, as the Egyptian equivalent of Hermes, and it would appear that, at any rate as late as 100 B.C., this equation was preferred to that with Anubis in the Fayum, as in documents from Kerkeosiris *ἱερωαφεία καὶ Ἐρμῆα*—shrines where Hermes was associated with the sacred ibis of Thoth—are mentioned as distinct from *Ἀνουβεία*.⁴ The persistence of the same idea is seen in the later Hermes Trismegistus, the special depository of all magical knowledge;⁵ and in the magical papyri of the Roman period Hermes plays an important part in this connexion. It may, however, be noted that his identification with Anubis was remembered here also; the four shapes of Hermes in the four quarters of heaven are given as ibis, cynocephalus, snake, and wolf;⁶ and, while the first two of these are the sacred animals of Thoth, the wolf almost certainly represents the jackal of Anubis.

A further development resulted from the Hermes-Thoth equation. Thoth had been combined, in the local worship of some districts of Egypt, with Khonsu, in virtue of common lunar attributes; and, as Khonsu had been identified independently with Herakles, the Egyptian Thoth-Khonsu, or Khonsthout, as the name appears in use for a personal one, became to the Greeks Hermes-Herakles.⁷ Such a combination is obviously foreign to the Greek spirit; although the spheres of influence of Hermes and Herakles might touch at one point, in the gymnasium, the two gods could hardly have been fused by any one who regarded them simply from the Greek standpoint. The same idea is traceable in a dedication to Hermes and Herakles, as well as to other gods whose names are lost, with Ammon, the head of the solar group.⁸

It may also be noted that, at Elephantinē, Hermes was identified with Petensenis,⁹ and at Pselkis in Nubia with Pantnuphis;¹⁰ but, as both of these names are purely local titles, as to the connotation of which nothing further is known, it is useless to conjecture the reasons for the identification. The name of Hermopolis Parva in the Delta

¹ *BM Cat.* pl. xviii. nos. 1188, 1428, 2050; Dattari, pl. xvi. nos. 1387, 3866.

² *JHS* xxvi. [1906] 42.

³ *BM Cat.* pl. xviii. no. 1506; Dattari, pl. xvi. no. 4118.

⁴ *P. Tebt.* 88, 44, 52.

⁵ For the origin of Hermes Trismegistus, see F. Ll. Griffith, *Stories of the High Priests of Memphis*, Oxford, 1900, p. 68.

⁶ *P. Lond.* 122, 2.

⁷ *JHS* xxi. [1900] 281.

⁸ *BSA* I [1898] 42.

⁹ *CIG* iii. 4893.

¹⁰ *Ib.* iii. 5072.

also suggests that there Hermes was regarded as the representative of Horus, the old god of the city.

The case of Hermes is fairly typical of the confusion of names and ideas which arose from the mixture of Greek and Egyptian theology. As has already been seen, the identifications made between the gods of the two nations were based more on grounds of convenience and interest than on any carefully considered principle, and so they might vary locally according to the circumstances of the established cult of each district. It will suffice to summarize more briefly the principal equations which are recorded in the cases of other Greek gods.

(2) *Zeus* had been identified with Ammon by early Greek travellers in Egypt: both in the Libyan Oasis and at Thebes they became familiar with the god, whose priesthood, though declining in importance, still formed one of the most powerful corporations in the country; and, partly no doubt under the impression produced by this political influence, partly from the natural tendency to equate the god who seemed to be chief of the Egyptian deities with the one who held a corresponding position among the Greeks, Ammon was transformed into Zeus Thebais, to whom early Greek dedications have been found.¹ The type of Zeus wearing a ram's horn as Zeus Ammon is commonly found in Ptolemaic and Roman times, having been popularized by the local legend of the birth of Alexander. In a Latin inscription from a quarry near Philæ a third title is added, in the name Jupiter Ammon Chnubis,² the last obtained from the cataract-god Khnum, who had previously been identified with Ammon, and was similarly associated with the ram. The solar attributes of Amen-Ra of Thebes further led to the adoption of the form Zeus Helios in the Thebaid;³ and, as has already been seen, both Zeus Helios and Zeus Ammon were united with Sarapis.

(3) *Hera*, on the other hand, rarely appears in Egypt. Herodotus states that she was one of the Greek deities whose names did not come from Egypt;⁴ in other words, there was no Egyptian goddess with whom she was popularly identified. At the first cataract, however, she was equated with the local goddess Sati, whose temple seems to have been known to the Greeks as the Heraion.⁵ Another Heraion is mentioned at Thebes,⁶ which was probably the temple of Mut, the consort of Amen-Ra; the equation of Mut with Hera would naturally follow that of Amen-Ra with Zeus.

(4) *Kronos* was identified with Geb by the early Greek students of Egyptian religion; but there is little later evidence in support of this identification, which was probably derived from a comparison of the theogony of Heliopolis with that of Homer. There is, however, a stele from Koptos, on which the Greek inscription gives a dedication to Kronos, while the scene above shows the emperor Tiberius making offering to Geb and Nut.⁷ At Elephantinê, Kronos is called Petensetis⁸—obviously a purely local name; and at Tebtunis in the Fayum he was equated with Soknebtunis, the local form of the crocodile-god Sebek,⁹ who is known to have been identified elsewhere with Geb.

(5) *Apollo*, in the system of Herodotus, was the representative of Horus,¹⁰ the identification being

¹ *CIR* v. (1891) 77; *BEFM*, 'Naukratis,' 1886-88, I. 28.
² *CIL* iii. 76.
³ B. P. Grenfell, *Greek Papyri*, Oxford, 1896, II. 85; *APF* II. (1903) 664, no. 113.
⁴ Herod. II. 50.
⁵ M. L. Strack, *Dynastie d. Ptol.*, Berlin, 1897, p. 251, no. 95; *CIG* III. 4893; *PSBA* IX. (1886-87) 203.
⁶ *P. Tor.* 1^o 19.
⁷ *CIG* III. 4893.
⁸ Herod. II. 144.

doubtless based on the fact that both were sun-gods. In pursuance of this idea, the town of Harbehtet became Apollinopolis Magna, and that of Har-uer, Apollinopolis Parva; and to the same cause may be ascribed the great popularity of Ἀπολλώνιος as a personal name amongst the Greek-speaking inhabitants of Egypt, just as names derived from various forms of Horus were the commonest amongst those who adhered to the native language. The identification of Apollo with Haroeris occurs at Ombos¹ as well as at Apollinopolis Parva. An early Ptolemaic inscription from Naukratis gives an interesting triad in Sarapis, Isis, and Apollo,² in which Apollo seems to take the place of Harpokrates as an equivalent Horus-form.

(6) *Artemis* was equated with Bast (Bubastis), according to Herodotus;³ and, as Bast was a cat-deity, Artemis seems to have been taken by analogy as identical with another goddess, Pakhet, who was worshipped in cat-form at the spot known to the Greeks as Speos Artemidos. There are, however, no records on monuments to show that this identification had any practical recognition in actual worship.

(7) *Leto* is in much the same case: Herodotus states that she had an oracle at Buto in the Delta,⁴ which presumably means that she was identified with Uazt, the tutelary goddess of that town; but there is no further evidence as to this, nor as to her apparent equation with Hathor as presiding deity of the town known to the Greeks as Letopolis.⁵

(8) *Athene* was perhaps the one of all the Homeric gods as to whose Egyptian origin Greek writers were most certain. The town of Sais in the Delta was declared to be the mother-city of Athens, and Athene to be derived from Neith, the goddess of Sais. But, though Athene was certainly worshipped at Sais by the Greeks, it was, so far as any extant evidence shows, under her Greek name alone, and in purely Greek form.⁶ At Oxyrhynchus she was identified with the local goddess Thoeris (Taurt),⁷ probably in view of their common warlike attributes, but the identification does not seem to have been carried very far; in name, at any rate, the Egyptian goddess held her own, as the chief local temple was known as the Thoereion,⁸ and references in papyri are, with only one or two exceptions, to Thoeris simply.⁹ In art, however, it is the Greek type of Athene which is found on coins and signets of Oxyrhynchus;¹⁰ this is doubtless due to the fact that Thoeris was a hippopotamus goddess, and the representation of such a type would not appeal to the Greeks.

(9) *Ares* was another deity for whom the Greeks found an Egyptian equivalent at an early date in Onouris, a warrior-god;¹¹ but in this case also the identification seems to have been a literary one merely, without any practical effect.

(10) *Aphrodite* was much more important in the popular than in the official religion of Græco-Roman Egypt, so far as extant evidence proves. Statuettes of Aphrodite, sometimes of purely

¹ *CIG* III. 4859.

² *Amer. Journ. Arch.* II. (1886) 151.

³ Herod. II. 59, 137.

⁴ *Ib.* II. 155.

⁵ The name of Letopolis may come from a comparison with Greek genealogy; Har-uer, the chief god of the town in the Egyptian system, being identified with Apollo, his mother, Hathor, became Leto.

⁶ Coin-types of Sais—Dattari, pls. xxxiii. no. 6362, xxxiv. no. 6367, xxxv. nos. 6369-70, xxxvi. no. 6371; Panegyris at Sais—*P. Hib.* 27, 77, 166; late dedication to Tritogeneia at Sais, *APF* II. 569, no. 145.

⁷ *P. Oxy.* 579; 1117.

⁸ *P. Oxy.* 43, IV. 12.

⁹ e.g. *P. Oxy.* 46; 47; 241; 242.

¹⁰ Dattari, pls. xxxiii. nos. 6333-4, xxxiv. no. 6336, xxxv. no. 6339, xxxvi. no. 6340; *Nuimem. Chron.*, 1908, p. 296.

¹¹ Herod. II. 59.

Hellenic type, but more usually showing traces of Egyptian influence, are commonly found; and inventories of property suggest that these statuettes normally formed part of a lady's outfit.¹ Hathor, the Egyptian goddess of love, was the natural equivalent of Aphrodite, and at least two towns of Hathor—the modern Atfih and Gebelén—were re-named Aphroditopolis by the Greeks. At the latter, where Hathor was the consort of Sebek, Greek papyri mention priests of Aphrodite and Souchos,² and she was worshipped in the same connexion at Ombos.³ At Dendera also, in the chief centre of the Hathor cult, Aphrodite took the place of that goddess, and the Greek dedication of the temple, rebuilt in the early years of Roman rule, is in her name.⁴

(11) *Pan* was identified with the ithyphallic Min at Panopolis and Koptos, as appears from the Greek name of the former town and from dedications at both places.⁵ The functions of Min as guardian of the desert roads were naturally transferred to Pan, and graffiti addressed to him are found at many points in the deserts, scratched on rocks or walls by travellers and huntsmen, as well as more formal dedications.⁶

(12) *Dionysos* furnishes perhaps the best instance of the divergence between literary and popular equations of gods in Egypt. Herodotus states very elaborately the identification of Dionysos with Osiris,⁷ but there is hardly any evidence that Dionysos inherited any part of the worship of Osiris, or took his place in the minds of the Græco-Egyptian population. As a matter of fact, Osiris, from the Alexandrian point of view, was absorbed by Sarapis, as has already been shown, and the only religious records which mention Dionysos in Egypt refer to a purely Greek cult,⁸ except in one locality. At the first cataract, Dionysos is equated in inscriptions with Petem-pamentis,⁹ whose name suggests that he was a chthonic form of Osiris.

(13) *Demeter* similarly was identified by Herodotus with Isis;¹⁰ but the literary identification did not affect popular worship.¹¹ The position held by Isis in the Alexandrian triad rendered it both unnecessary and unlikely that she should take the name of any Greek deity.

(14) *Hephaistos* was commonly equated with Ptah, perhaps in view of the record of the latter as constructor of the universe; and the great temple of Ptah at Memphis is referred to in Greek documents as the Hephaisteion.¹² But this temple rapidly declined in importance. Ptah was worshipped there as Ptah-Sokar-Osiris; and, as Sarapis absorbed the attributes of Osiris, the Sarapeion grew at the expense of the Hephaisteion. It is therefore not remarkable that Hephaistos, not an important god in Greece itself, plays no part at all in Græco-Egyptian worship. A record of the mixed type is, however, given by a coin of Hadrian, on which the god is shown with Egyptian head-

dress and Greek robes, carrying the sceptre of Ptah and the tongs of Hephaistos.¹

(15) *Asklepios* was provided with an Egyptian equivalent in the deified sage Imhotep, whom later generations had claimed as a son of Ptah and a god of healing. A chapel dedicated to Imhotep seems to have been attached to his reputed father's temple at Memphis, and this was called the Asklepieion by the Greeks.² There was a similar chapel at Philæ;³ and the upper court of the temple of Hatshepsut at Deir el-Bahri, on the west of Thebes, was transformed in Ptolemaic times into a kind of sanatorium, whose walls are scribbled over with invocations of Asklepios in his Græco-Egyptian association.⁴

(16) *Hestia* was, according to Herodotus, not Egyptian.⁵ Like Hera, however, whom he placed in the same class, she was equated with one of the cataract-deities—Anukis—at Elephantinē;⁶ but the reason for this identification is not clear.

(17) *Herakles* shows more variation of form, due to his equation with two distinct Egyptian deities. It has been noted above that he was identified with the lunar god Khonsu at Hermopolis Magna and Apollinopolis Magna, and that in this connexion he was united with Hermes.⁷ At Herakleopolis, however, he was taken to represent the local form of Horus, Har-shefi, and gave his name to the town; and then, by another confusion which has already been mentioned, his attribute, the club, was transferred to a second form of Horus—Harpokrates—as shown on the nome-coins; and a compound Herakles-Harpokrates is mentioned in a Greek dedication.⁸

From a survey of the foregoing summary it will be seen that the identification of Greek and Egyptian gods proceeded on the most superficial lines, and was often purely academic. A certain amount of cross influence between the two systems of theology may perhaps be discerned in the cases of Zeus-Ammon, Apollo-Haroeris, Athene-Neith, Aphrodite-Hathor, Hermes-Thoth, Pan-Min, Hephaistos-Ptah, Asklepios-Imhotep, and Herakles-Khonsu; but the equations of Hera, Kronos, Artemis, Leto, Ares, Dionysos, Demeter, and Hestia with Egyptian deities do not appear to have been anything more than nominal so far as the actual worship either by Greeks or by Egyptians was concerned. In fact, the identification was practically a mere matter of convenience; the Greek section of the population, who clearly prided themselves on their race, and were soaked in Homer, preferred to address the gods whom they worshipped by familiar Olympian names rather than use the Egyptian titles even in a Hellenized shape, though the latter class of forms occur; and the priests of the Egyptian temples met the wishes of the Greek worshippers by the simple process of allowing their own gods to be invoked by the Greek names, which seemed at first sight most suitable. As this process was not based on any general agreement as to the identity of various gods, except in so far as accepted traditions, such as those recorded by Herodotus, were remembered, there arose cross-identifications according to local circumstances.

4. *Egyptian gods worshipped by Greeks without equation.*—There were a few Egyptian gods who had no recognized Greek equivalents, but were nevertheless so far accepted by the Greek settlers as to require mention in connexion with Græco-

¹ *Griech. Urk. Berl.* 717, 11; *Corp. Pap. Raineri*, 22, 7; 27, 10; *P. Oxy.* 921, 22.

² *P. Grenf.* 44², 1; II. 33, 3; 35, 4; *P. Lond.* 676, 8, 678, 5, 1206², 22, 1208, 14.

³ *BCH* xx. [1896] 167.

⁴ *CIG* III. 4716.

⁵ *RTr* xi. [1889] 149; Milne, *Hist. of Egypt*, v. 184.

⁶ *Sitzungsberichte d. k. Preuss. Akademie*, 1887, p. 419; *Ath. Mitt.* xix. [1894] 229; *CIG* III. 4835^b, 4836^c, 4838, 4716^d; *RTr* xi. [1889] 148.

⁷ Herod. II. 42.

⁸ Greek cult of Dionysos at Oxyrhynchus (*P. Oxy.* 171, 10, 917, 3); at Ptolemais (*BCH* ix. [1885] 132, 140).

⁹ *CIG* III. 4893; Strack, *Dyn. d. Ptol.* 251, no. 95.

¹⁰ Herod. II. 69.

¹¹ Some of the coin-types may be intended to represent Isis-Demeter; but Alexandrian coin-types were not much influenced by popular beliefs; they were rather academic. In this connexion the occurrence of Triptolemos on coins may be noted; he is certainly not a person who had any worshippers in Egypt.

¹² *P. Leyd.* K. 13.

¹ *BMCat.* pl. xxiii. no. 636; Dattari, pl. xxi. no. 1448. This is a good instance of the academical treatment of coin-types at the Alexandrian mint mentioned in note 11 on preceding column.

² e.g. *P. Louvre*, 26, 7, 27, 21; *P. Lond.* 35, 23, 41¹, 1.

³ *APF* I. [1901] 206, nos. 14, 17.

⁴ *JHS* xix. [1899] 13.

⁵ Herod. II. 50.

⁶ *CIG* III. 4893; Strack, *Dyn. d. Ptol.* 251, no. 95.

⁷ For ref. see p. 380^b, notes 7, 8. ⁸ *P.* 379^b, notes 5, 6.

Egyptian religion. These were such as offered no traits for ready identification with the Homeric gods, but possessed so much popularity among the natives that they attracted the attention and the worship of the Greeks.

(1) The most noteworthy example of this class of deity is to be found in the case of *Bes*, who, though he may have been introduced into the Egyptian pantheon at a fairly early period, did not attain a position of any importance until the time of the New Kingdom. Even then he does not seem to have received any official recognition, such as would be expressed by the dedication of a temple to him; but he was a prominent figure in popular magic. Similarly, in the earlier part of the Græco-Roman period, *Bes* is not mentioned in religious inscriptions or represented on the walls of temples;¹ but he must have been widely worshipped among the lower classes, as terracotta statuettes of him are common, and bronze figures not infrequent.² Later, with the recrudescence of magic, he grew in importance, and even seems to have ousted *Sarapis* from the chief place in the temple of Abydos, where an oracle of *Bes* was established and flourished till its suppression in the reign of Constantius II:³ graffiti of homage to him still exist on the walls of the temple beside the earlier inscriptions to *Osiris* and *Sarapis*.⁴ At Memphis also *Bes* seems to have obtained a footing in the *Sarapeion* in Roman times, as a room has been found there decorated with figures of him and his worshippers.⁵ The graffiti of Abydos and magical papyri suggest that the oracles of *Bes* were given through dreams,⁶ and this may have smoothed his way into the *Sarapeion* of Memphis, where there was an old-established system of incubatory divination.

(2) The crocodile-god *Sebek* was also usually worshipped without equation to any Greek deity, at any rate in his chief seat, the Fayum. At *Ombois* he had been previously identified by the Egyptians with *Geb*; and so the equation of *Geb* with *Kronos* by the Greeks involved that of *Sebek* with *Kronos*, which is found at one spot in the Fayum—at *Tebtunis*.⁷ In the great majority of the references to *Sebek* which occur in the Fayum papyri, however, there is no trace of any Greek connexion; and the representations of him in the Græco-Roman period are always in purely animal form. There was no lack of Greek settlers in the Fayum, but they seem to have been perfectly content to offer their homage to this god in his Egyptian form, only softening his name to *Souchos*. How closely associated his worship might be with Hellenic ideas is shown by two late Ptolemaic dedications to him, probably from *Crocodilopolis-Arsinoë*, which were set up to mark the enclosures appropriated to schools of *ephebi* of certain years.⁸ The temple of *Sebek* at *Arsinoë* was the chief one of the nome, and in its precincts was a lake where the sacred crocodiles, his embodiment, were kept, and worshipped, providing one of the regular sights for tourists;⁹ and there were numerous other temples or colleges of priests of *Sebek* in the surrounding villages, such as *Euhemereia*,¹⁰ *Nabla*,¹¹ *Tebtunis*,¹² and *Kerkeosiris*.¹³ Moreover, he was worshipped in many local forms in these villages.

Thus at *Soknopaiou Nesos* there was a great temple of *Soknopaios-Sebek*, lord of the island—in which he was associated

with *Isis-Neferes*: the papyri from this town have furnished many references to his priests and his feasts,¹ while inscriptions record grants of corn by Ptolemaic officials² and of privileges by a Roman prefect:³ he is represented as a crocodile with a hawk's head,⁴ which shows him to have been a solar deity connected with *Horus*, as in Upper Egypt *Sebek* had formerly been united with *Ra*. At the same town of *Soknopaiou Nesos* there was a second, apparently subordinate, form of *Sebek* worshipped as *Sokopaios* or *Sokopieios*.⁵ *Soknebtunis* was the local type of *Sebek* as lord of *Tebtunis*, in the neighbourhood of which village his temple seems to have owned extensive property.⁶ In the same district another variant occurs in *Sokeabouthis*; ⁷ at *Bacchias* he appears as *Sokanobkonneus* or *Sokonnokonnis*; ⁸ and at *Crocodilopolis-Arsinoë* and *Tebtunis* as *Sokopichonsis*.⁹ At *Karanis*, where the temple has been excavated, and has yielded building dedications under a late Ptolemy, *Nero*, *Vespasian*, and *Commodus*, *Sebek* was known as *Petesouchos*,¹⁰ a name found also at *Kerkeosiris*,¹¹ and possibly applied to the god at his chief temple at *Arsinoë*.¹² The crocodile-god might also be addressed by other titles than that of *Sebek* or compounds of it; for instance, *Pheunoeris* or *Pheunoeris* is described as belonging to this group,¹³ and similarly *Pnepheros* of *Karanis* and *Theadelphia*;¹⁴ but the catalogue of his local names does not throw light on his worship.

(3) The position of *Sebek* as regards the Greeks may be paralleled by that of the hippopotamus-goddess *Taurt*. As has been mentioned above, this goddess was nominally identified with the Greek *Athene*; but in actual practice she seems to have been worshipped independently. No Greek would be likely to associate *Athene* with a hippopotamus; and, if it seemed advantageous to him to pay homage to *Taurt*, he addressed her as *Thoeris*.

It is very doubtful, however, whether in such cases as those of *Bes*, *Sebek*, and *Taurt* there was any influence exercised on the Egyptian worship by the Greek worshippers which would produce a result described as Græco-Egyptian. The utmost that can be traced is in the modification of the Egyptian names to suit the ear of the Greeks; and a similar modification, in rarer examples, might be cited in regard to a considerable number of purely Egyptian deities who happen to be mentioned in Greek documents.

5. The decay of the Greek element.—The attempt of the earlier Ptolemies to plant a new State-religion in Egypt, like their attempt to Hellenize the country, was doomed to failure; the imported elements in the gods and in the human population were alike absorbed and disappeared. By the 3rd cent. A.D. the descendants of the Greek colonists, except perhaps in *Alexandria*, had become practically indistinguishable from the mass of the natives of Egyptian race, and in the same way the old Egyptian deities had reasserted their position, and had obliterated the Greek equivalents who formerly shared their worship.

(1) The clearest illustration of the recrudescence of native religious ideas may be found in the case of *Osiris*. He should, under the Ptolemaic system, have been entirely supplanted by *Sarapis*. But, as has already been seen, at *Abydos*, *Osiris* held his ground, at any rate amongst the Egyptian-speaking part of the population, and apparently his worship was so far recognized that *Strabo* records him as the god of *Abydos*:¹⁵ his name appears in demotic inscriptions as the equivalent of that of *Sarapis* in Greek;¹⁶ occasionally even Greek inscriptions of homage on the temple-walls are addressed to him instead of to *Sarapis*.¹⁷ There are other indications that he was sometimes treated by the Greeks as distinct from *Sarapis*; thus a Ptolemaic

¹ Bee-figures do occur in buildings of this period, but they are architectural rather than religious in their purpose; e.g. at *Tentyra* (Milne, *Hist. of Egypt*, v. 132, fig. 89).

² e.g. *Berlin Mus. Cat.* nos. 4577, 9433, 11006, 11630, 12444.

³ *Amm. Marcell.* xix. 12. 3. ⁴ *PSBA* x. [1887-88] 379 ff.

⁵ *J. E. Quibell, Excavations at Saqqara, 1905-06*, Cairo, 1907, p. 12. ⁶ *P. Lond.* 121. 222, 122. 64.

⁷ *P. Tebt.* 204. 5, 295. 6, 298. 7, 302. 3.

⁸ *Alt. Mitt.* xix. [1894] 212; *BCH* xviii. [1894] 147.

⁹ *P. Tebt.* 83; *Strabo*, xvii. l. 83. ¹⁰ *P. Petr.* ii. 2.

¹¹ *P. Lond.* 345. 4. ¹² *P. Tebt.* 114. 10, 16.

¹³ *P. Tebt.* 88. 6, 106. 41, 109. 21.

¹ *Griech. Urk. Berl.* 1, 149, etc.

² *GGN*, 1892, p. 532; *Hermathena*, xxi. [1895] 162.

³ *Milne, Hist. of Egypt*, v. 185. ⁴ *ZÄ* xxxi. [1893] 23.

⁵ *Griech. Urk. Berl.* 229, 230, 296; *P. Lond.* 353. 8.

⁶ *P. Tebt.* 60. 10, 63. 18, 84. 92, 98. 28.

⁷ *P. Tebt.* 115. 10, 24. ⁸ *P. Fay.* 18. 3, 137. 1.

⁹ *Ann. Serv. Ant.* x. [1910] 155; *Griech. Urk. Berl.* 1023. 5.

¹⁰ *EEFM*, 'Fayum Towns,' p. 32; *Griech. Urk. Berl.* 707. 2.

¹¹ *P. Tebt.* 63. 25, 84. 73, 93. 30. ¹² *P. Tebt.* 33. 13.

¹³ *Griech. Urk. Berl.* 471. 6; *P. Tebt.* 87. 108.

¹⁴ *Ann. Serv. Ant.* x. [1910] 162. ¹⁵ *Strabo*, xvii. l. 44.

¹⁶ See p. 377^a, notes 7 and 8, for references.

¹⁷ *PSBA* x. [1887-88] 352.

altar is dedicated to Osiris with Sarapis, Isis, and Anubis;¹ at Oxyrhynchus in Roman times there was an Osireion as well as a Sarapeion, and a priestly college served Thooris, Isis, Sarapis, and Osiris with other gods;² and a late Ptolemaic inscription from Theadelphia in the Fayum shows that an Osireion existed there also.³ About the end of the 1st cent. A. D., however, Osiris appears to be recovering the honours taken from him by Sarapis; for instance, the old Egyptian formula of entreaty to Osiris to give water to the dead, which had been preserved in demotic texts, begins to occur in a Greek version also, without any translation of Osiris into Sarapis;⁴ and in the magical papyri of the next two or three centuries Osiris is a leading actor,⁵ while Sarapis is scarcely mentioned.

(2) A similar revival can be traced in the cases of *Anubis* and *Horus* as against their Alexandrian equivalents Hermanubis and Harpokrates; and *Isis* had never been thoroughly Hellenized. In all three instances it is the Egyptian deity who recurs in the magical texts and remains a god of power long after the general acceptance of Christianity in the country: Isis and Horus are mentioned side by side with Jewish archangels and Jesus Christ.⁶

The importance of this apparent revival of old Egyptian ideas in the Roman period may perhaps be somewhat exaggerated at present by the comparative paucity of records concerning the worship of the lower classes of the Egyptian population after the Greek conquest. There is a fair amount of documentary evidence as to the State religion and the gods who were preferred by the upper and middle classes. But there must always have been a large substratum of *fellahtin* who did not speak Greek or write in any form, amongst whom the old traditional beliefs, as well as the old language, persisted. Demotic texts are few in number and usually unimportant in content, as compared with those in Greek, during the Ptolemaic and Roman periods; but they testify to a survival of the Egyptian tongue with sufficient vigour to enable it to recover its position not only as a national but as an official language when the external sanction of Greek was withdrawn. Similarly, there must have been a steady adherence to the old forms of worship among the peasantry, which is not recorded on monuments, but which caught the attention of Roman writers, and which the early Fathers of the Christian Church had to combat; for instance, the attacks of Clement point to a prevalence of animal-worship which would never be suspected from any Greek inscriptions; and it was this persistent belief which reappeared in the Egyptian magic of modern times.

Summary.—The official Græco-Egyptian worship was based on the Alexandrian triad of Sarapis, Isis, and Harpokrates. Only in the first of these three deities was the non-Egyptian element of material importance, and all derived the greater part of their local acceptance by inheritance from the native religion. The Greek inhabitants of the country frequently offered homage in the Egyptian shrines, addressing the god by a Greek name chosen on a superficial system of equation; or, if the particular deity could not readily be identified with a Greek equivalent, they were ready to adopt the Egyptian name. Meanwhile the native peasantry adhered to their old gods, and their faith gradually purged the worship of the country of the Hellenic elements which had been introduced, and made it in the days of its decline once more distinctively Egyptian.

¹ RA, 1887, p. 214.

² P. Oxy. 241. 10, 13.

³ *Éléo*, xii. [1912] 374.

⁴ e.g. *Alexandria Mus. Cat.*, 'Inscr. gr. e rom.', nos. 332, 341.

⁵ e.g. P. Lond. 121, *passim*.

⁶ ZN xxxii. [1894] 47 ff.

No attempt has been made, in the present article, to trace the development of the worship of Egyptian gods outside Egypt. The reason for this is that the cults of Isis, Osiris, Sarapis, and Anubis, when transplanted to Greece or Italy, ceased to be Egyptian. The account of the festival at Corinth given by Apuleius contains hardly anything that would be recognizable as Egyptian, apart from mere names.

Incidentally, however, it may be noted as significant that at Rome, and in the West generally, Osiris rather than Sarapis was the usual object of worship with Isis. In the Greek parts of Asia, and to a certain extent in European Greece, Sarapis had been introduced under Ptolemaic influence; but, when the Romans had reached the stage of borrowing Oriental gods, Osiris was coming to the fore again.

LITERATURE.—An excellent summary account of Egyptian religion in the Græco-Roman period is given in A. Erman, *Handbook of Egyptian Religion*, tr. A. S. Griffith, London, 1907. The fullest treatment of existing materials in regard to organization of worship is in W. Otto, *Priester und Tempel im hellenistischen Ägypten*, Leipzig, 1906-08; J. Kaerst, *Geschichte des hellenistischen Zeitalters*, Leipzig, 1901, has a very good review of the philosophical atmosphere in which the cult of Sarapis developed, in bk. v. ch. 5; see especially pp. 265-280.

For the worship of Egyptian gods outside Egypt, see G. Lafaye, *Hist. du culte des divinités d'Alexandrie hors de l'Égypte*, Paris, 1884, and A. Rusch, *de Serapide et Iside in Græcia cultis*, Berlin, 1906; also W. Drexler in *Nun. Ztschr.* xxi. [1889] 1-234, on 'Isis and Sarapis in Asia Minor,' and the catalogue of localities of Isis-worship abroad, in Roscher, s.v. 'Isis.' The chapter on Egypt in F. Cumont, *The Oriental Religions in Roman Paganism*, Eng. tr., Chicago, 1911, pp. 73-102, gives a valuable account of the influence of Egyptian beliefs at Rome.

J. G. MILNE.

GRAIAI.—The Graiai (Γραῖαι, 'old ones'), or Phorkides, first appear in Hesiod (*Theog.* 270-273) as daughters of the sea-deities Phorkys and Keto, and sisters of the three Gorgons. They are beautiful (unless in line 270 καλλιπάρῃος should be read, referring to their mother only), and well-dressed, one being εὔπεπλος and the other κροκόπεπλος. They are also white-haired from birth (ἐκ γενετῆς πολιάς; but lines 271-2 are commonly obelized by modern editors. It is, however, unlikely that this phrase is spurious; and it is simpler to consider the two lines genuine, removing all difficulty by reading θύγατρας for Γραῖαι in line 270). Two sisters only are named by Hesiod—Pephredo (v.l. Pempfredo or Tephredo or, in other writers, Memphredo or Pephrido or Pephrodo) and Enuo; but it is probable that a third name—Deino or Dino—should be substituted for the word εὔπεπλον in line 273. In the following passage, lines 274-286, Hesiod names the Gorgons, and gives very briefly the elements of the Perseus and Medusa legend; but he does not represent them as hideous (see art. GORGON). In Æschylus (*Prom. Vinc.* 793-797) both sets of sisters have become monsters (τέρατα), living in the Gorgonian plains of Kisthene, which was in the far West, or possibly in the far East.¹ His Phorkides are three aged maidens (θηναῖαι κόραι), swan-shaped (κυκνόμορφοι), with one eye and one tooth in common, never shone upon by sun or moon. To this must be added a statement in the lost *Phorkides* of the same dramatist, recorded by the pseudo-Eratosthenes (*Catasterismi*, 22) and the poet Hyginus (*Astr.* ii. 12), that they were προφύλακες of the Gorgons; the same play also alluded to a cave (Æsch., ed. Sidgwick, frag. 261 f.). Æschylus's epithet κυκνόμορφοι seems inconsistent with his μονόδοκτες; and it is suggested that the resemblance to swans should be taken as partial or vague rather than exact, or that some lost word, such as κυκνόφορκοι (swan-white), should be substituted; the paronomasia would be quite in Æschylus's manner. In Æschylus the Gorgons too have become τέρατα, not only winged, but δρακοντόμαλλοι and βροτοστυγεῖς; and the sight of them is fatal to life.

After this, though the Gorgons are frequently mentioned, their sisters disappear from extant Greek literature till the time of the mythologists. Apollodorus (ii. 4. 2), after Pherecydes, makes them in some way guardians of the Gorgons; Perseus

¹ A scholiast in the Cod. Med. of Æschylus says vaguely: τῶν Διβύνης ἢ Διθουσίας.

snatches away the common eye and tooth while these are being passed round, and then restores them in exchange for instructions how to find the Nymphs, from whom he wishes to obtain the magic cap, shoes, and sword. Palæphatus (*de Incred.* 32) makes the Graiai reveal to Perseus the way to the Gorgons. Hyginus represents Perseus as already possessed of the cap and shoes; he takes the eye and the tooth while the holders are passing them on to relieve guard, and throws them into the Tritonian lake. There are unimportant variations of detail in writers such as Tzetzes, Ovid, Nonnus, etc. (see the references in Roscher).

The Graiai very seldom figure in art. Miss Harrison describes (*Proleg. to Gr. Rel.*, Cambridge, 1903, pp. 194-96) and figures (fig. 35) a cover of a *pyxis* in the Central Museum at Athens, on which they are represented with dolphins, accompanied by Phorkys, Poseidon, Hermes, and Perseus (who is waiting to snatch the eye from two of them while the third holds the tooth); they appear to be young and lovely. Miss Harrison says this is the only known representation in vase-painting. A. Rapp (Roscher, i. 1737 f.) is disinclined to accept Panofka's interpretation of an incised stone and an amphora (the latter in the British Museum) as representing 'Perseus and Graia'; but he attaches more importance to an Etruscan mirror as described in the sale catalogue of the Castellani Collection at Rome in 1884.

From the above facts it is clear that the *mythos* of the Graiai was conflated and possibly contaminated at a very early period; it probably varied to some extent with the attempts at interpretation. The details, therefore, may not admit of any single or consistent explanation. Their parentage, complexion, swan-shape or colour, and association with dolphins connect them with the sea; sea-gods are also credited with mysterious knowledge of secrets, and are frequently of venerable appearance. The Gorgons also have marine affinities, and in modern Greek folk-lore have become mermaids (see J. C. Lawson, *Modern Greek Folklore and Ancient Greek Religion*, Cambridge, 1910, p. 186). Hermann (*Opusc.* ii. [1827] 179) goes so far as to make the Graiai of Hesiod tide-goddesses, translating their names as 'Auferona' and 'Inferona,' apparently from *φέρειν* and *εν*. Similarly, ancient etymologists derived *Φορκύς* from *φορεῖν*; or *Περφιδώ* may be from *φρίσσω*, and *Ἐννώ* from *ἐναθώ* (of sound). Their whiteness is easily connected with sea-foam.

Swans, however, also symbolize clouds; and the epithets of Hesiod suggest that the Graiai may represent the bright clouds of fine weather and especially the sunset (*κροκόπεπλος*), while their sisters the Gorgons personify the dark clouds of storm and rain. This view was advocated by Roscher, and is apparently supported by Rapp, who sees in the transferable eye and tooth of the Graiai, and still more in the baleful glance of the Gorgons, the flash of the lightning and its apparent passage from cloud to cloud. The Gorgons also seem to be credited with a single eye, possessed in common, by a scholiast on *Æsch. Prom. Vinc.* 793. Mannhardt (*Germ. Mythen*, Berlin, 1858, p. 217, *ZE*, 1875) interprets the eye as the ray of sunlight; while Tylor (*Prim. Cult.*, 1903, i. 352) thinks that the Gorgons, one mortal and two immortal, may stand for the present, past, and future, their eye being the sun itself. With these theories we may also class the suggested derivations of their names from the roots of *πέμφιξ* and *πομφός* and *εν-θω*. The *v.l.* *τεφρηδῶ* would mean 'the ashen-coloured,' and might apply either to waves or to clouds. So might the third name *Δυνώ*, if from *δύνη*, but it is more probably *Δεινώ* from *δεινός*.

The suggestions that the Graiai and Gorgons are volcanoes or gorillas seem fantastic, since it is now

generally held that the hideous head or mask of the latter—the *Γοργωνεῖον* or *Γοργεῖη κεφαλή* of Hom. *Od.* xi. 633—is not an original feature of them at all, but an *ἀποτρόπαιον* of Oriental, and probably Hittite, origin, introduced into Greece about the end of the 8th cent., and perpetuated in many various types. This conflation would not be difficult to account for if the Gorgons were originally storm-cloud goddesses capable of malignant glances of lightning; but it may well be due, in the first place, to some etymological confusion between names of similar sound. On these lines the latest mythologists, such as Miss Harrison (*op. cit.*), regard the Graiai and Gorgons as originally triads of sea- or cloud-goddesses and as by-forms of each other, perhaps distinguished as causing good or bad weather. The eye and tooth symbolize their potency, which can be transmitted from one quarter to another; it is a similar conception to the common one of the 'external soul.' At an early period, probably long before *Æschylus*, the Gorgons acquired alien characteristics, and their duplicates, the Graiai, were then worked into the Perseus legend in various ways. But some points in *Æschylus's* description would still remain obscure, such as the swan-shape and the avoidance of light by residence in a hole or cave; and these may be inventions of his own to make them monsters (*τετραπέθεσθαι*).

LITERATURE.—The article by A. Rapp in Roscher's *Lexikon*, i. 1729-1738, is full of references to obscure German dissertations on the Phorkides and Gorgons, but does not contain the latest views. G. Glotz (in Daremberg-Saglio, ii. 2) is more concise, but he explains the point about the *Γοργωνεῖον*. Among older books, the most important are G. F. Schömann, *de Phorcyns ejusque familia*, Leipzig, 1863, and W. H. Roscher, *Gorgonen und Verwandtes*, do. 1879. See also art. GORGONS above, and in other dictionaries; and E. S. Hartland, *Legend of Perseus*, London, 1896, *passim*.

H. E. D. BLAKISTON.

GRAIL, THE HOLY.—I. Term and idea.—The most familiar use of the word 'Grail,' though probably not the most ancient or accurate, applies it to the cup used by our Lord at the Last Supper. There is more literary support for a different interpretation—the vessel in which Joseph of Arimathea collected the blood from the wound-prints of Jesus; this vessel is sometimes, though not always, identified with a chalice or dish used at the Supper. Sometimes, again, the Grail seems to be a platter; or a reliquary to contain the Host; or a stone, as in Wolfram; or a 'rich Grail,' undefined, but apparently a food-producing talisman. Derivations of the word vary as much as definitions of its meaning. The best authenticated traces it to the Latin *crater* (cup), through the forms *cratalis* and *gradalis*. A derivation suggested by the Grail romancers themselves (*e.g.* Robert de Borron) is the root *gré*—the vessel being named from the pleasure it gives to those who behold it; cf. the much quoted sentence from Helinandus (Migne, *PL* ccxii. 815):

'Gradalis autem sive Gradale Gallice dicitur scutella lata, et aliquantulum profunda, in qua pretiosae dapes cum suo jure divitibus solent apponi gradatim . . . et dicitur vulgari nomine Graalz, quia grata et acceptabilis est.'

Paulin Paris (*Les Romans de la table ronde*, Paris, 1868, i. 102) quotes an eighth-century story, which, if its authenticity could be established, would give a new derivation and definition together—of a *Liber Gradalis*, the adjective being akin to the Gradual of the Roman Church. The whole subject, alike in its ultimate origins and in its inner significance, like the Grail itself in Tennyson's poem, is 'all covered over with a luminous cloud,' and there is room for much variety of theory and interpretation. The Grail itself in its elusiveness and changefulness baffles the writer's quest to-day, as it baffled the knight's quest long ago; it flashes across his vision and is gone before he has time to question it; and he who sets forth to write of it

finds more to describe in the quest than in the goal.

2. **Literary development.**—In the space of fifty years (roughly between 1170 and 1220) the great body of Grail romance apparently came into existence. But it was not until 1861 that complete texts began to appear, most of them merely 13th or 14th cent. transcripts of the 12th cent. MSS. These MSS are found in France, Germany, and Great Britain; and early printed forms are preserved also in Spain, Portugal, and Holland. The MSS are very confused as well as scattered—some fragmentary, and some suggesting interpolations by later hands. Parts of the story connected in one MS are found elsewhere separated and conjoined with other parts, so that the task of research has been one of very great difficulty. The Germans F. Zarncke (in H. Paul and W. Braune's *Beitr. zur Gesch. der deutschen Spr. und Lit.* iii. [Halle, 1876] 304 ff.) and A. Birch-Hirschfeld (*Die Sage vom Gral*, Leipzig, 1877) made praiseworthy attempts to introduce some chronological order into the chaos; and, while other scholars have not been able entirely to agree with Birch-Hirschfeld's analysis, it still supplies a basis for tabulation which is helpful. It must always, however, be remembered that the discovery of some hitherto concealed MS or some biographical fact might throw a flood of light on the whole subject, and re-arrange the knowledge now possessed by investigators. Meantime a very wide margin must be allowed in such dates as may be conjectured from internal evidence of the MSS. Much controversy still circles round the names of Chrétien de Troyes and Robert de Borron. Of the dated work, Chrétien's is the oldest of all, and by most scholars he was regarded as the undisputed head of the cycle. Birch-Hirschfeld, however, gave that place most emphatically to Robert de Borron, and of later years Miss Weston also has been inclined to take the same position. The decision is largely dependent on whether we may regard the *Prose Perceval* as representing de Borron's work, and thus much earlier than scholars have hitherto placed it. (For Nutt's division into 'Early History' and 'Quest' versions, and for the connexion with the Arthurian cycle as a whole, see art. ARTHUR in vol. ii. p. 6^b.)

It is to be noted that the Celtic *Peredur* and the English *Syr Percyvella* do not deal with the Grail as such. But they cannot be omitted in an account of the Romance literature, because of their value in the matter of tracing origins.

FRENCH:—1. *Le Conte del Graal* of Chrétien de Troyes (1180–90): poem printed for the first time by Potvin from the Mons MS, and contained (along with 'the Elucidation,' Gautier, Manessier, and Gerbert) in vols. ii.–vi. of *Perceval le Gallois, ou le Conte del Graal*, Mons, 1866–71. Copies of this work are so rare as to render it practically inaccessible.

2. Gautier de Douzens (or Wauchier de Denain, as he is called by Miss Weston, following M. Meyer) continues Chrétien's poem (1196–1216). A different version and interpolation given in another MS is referred to occasionally as *pseudo-Gautier*.
3. *Le petit St. Graal* of Robert de Borron (1180–99): (a) the unique fragmentary MS, a poem of about 3514 lines dealing with *Joseph of Arimathea*, and the remaining fragment with *Merlin*; (b) prose versions of the above: several MSS, of which the chief are the Cangé MS (1250); the Huth MS (c. 1280); and the famous Didot MS which includes as well the *Prose Perceval* (see below). The whole is accessible in an appendix to vol. i. of Furnivall's *Seynt Graal, or Sank Ryal*, London, 1861–63.
4. *Queste del Saint Graal*: prose; authorship unknown; the ascription in the MS to Map considered very dubious (1190, probably after Gautier); accessible in the form of Malory's *Le Morte d'Arthur*.
5. *Grand Saint Graal* (the fullest 'Early History'): prose; authorship unknown (c. 1200); accessible in Hucher's *Le Saint-Graal, ou le Joseph d'Arimathe*, Le Mans, 1875–78, or in Furnivall's *Seynt Graal, or Sank Ryal*.
6. Manessier continues Chrétien's poem, adding 45,579 verses after Gautier, and so finishing *Le Conte* (1214–20).

7. Gerbert de Montreuil interpolates 15,000 verses chiefly between Gautier and Manessier (1220–25). Both 6 and 7 are printed as above in Potvin's *Le Conte del Graal*.

8. *Perlesvaus* or *Perceval le Gallois*: prose; author unknown (c. 1225); first printed by Potvin in vol. i. of *Le Conte del Graal* (see above); now accessible in the form of *The High History of the Holy Graal*, tr. by Sebastian Evans, London, 1898.

9. The *Prose Perceval* (1230–50?; see above), found in the Didot MS (1301), also in a Modena MS which Miss Weston thinks both an earlier and better text; accessible in Hucher's *Le Saint-Graal, ou le Joseph d'Arimathe*. Miss Weston also gives a comparison of the D and M MSS in her *Legend of Sir Perceval*, vol. ii., London, 1909.

CELTIC:—1. *Mabinogi of Peredur, Son of Errawc*: prose; probably a re-translation back from French into Welsh of an old Welsh story. It is found in the *Red Book of Hergest*, MS of end of 14th cent., also in MSS of 13th cent.; accessible in *The Mabinogion*, tr. by Lady Guest, London, 1838–49; also selection ed. by A. Nutt, do. 1910.

2. *Y Seint Graal*: selections from Hengwrt MS (15th cent.); a Welsh 'Quest' Story (with Eng. tr. by Robert Williams, London, 1876) slightly differing from other forms, consisting in its first part of a version corresponding to Parts xiii.–xvii. of Malory's *Morte d'Arthur*, and in its second part of a version of the *Perlesvaus*.

ENGLISH:—The metrical Romance of *Syr Percyvella* or *Sir Perceval of Galles* from the Thornton MS (c. 1440) in the Library of Lincoln Cathedral; accessible in the *Thornton Romances* (1884, ed. Halliwell).

GERMAN:—1. *Parzival*, by Wolfram von Eschenbach: a metrical romance (c. 1210); accessible in Eng. tr. *Parzival: a Knightly Epic*, by Jessie L. Weston, 2 vols., London, 1894.

2. *Diu Crône*, by Heinrich von dem Türlin, who lived in the first half of the 13th cent.; accessible in vol. xxvii. of *Bibliothek des litterar. Vereins*, ed. G. H. F. Scholl, Stuttgart, 1852.

3. *Der jüngere Titurel*, by Albrecht von Scharffenberg (1270), written late for purposes of the study of the Grail, but interesting as a compilation and completion of fragments left by Wolfram and some unknown author; accessible as *Der jüngere Titurel*, ed. K. A. Hahn, Quedlinburg and Leipzig, 1842.

The three great names in connexion with this literature are those of Chrétien de Troyes, Robert de Borron, and Wolfram von Eschenbach. Chrétien was the poet of the court. His story is told with a charm of style and a sense of chivalry which give it a very high place in mediæval literature. But he does not explain the Grail, nor does he give any suggestion of realizing its deeper meaning. Whether this was merely the art of the skilful romancer, who intended to explain and deepen his theme, we have no means of knowing. His death broke the poem off abruptly, to be finished by those who may or may not have grasped his ideas. Robert de Borron was a much less skilled and polished workman. But there was a completeness about his work—especially if we may claim the *Perceval* as part of his idea—which puzzled scholars. He evidently had a definite and comprehensive plan. He viewed the Grail as a Christian symbol, and made his story carry out that conception. To him, for this reason, some have ascribed the fusion of the Grail story with the Saga. But the exact point of contact with the Arthurian cycle is very difficult to fix (see art. ARTHUR). To Wolfram v. Eschenbach it was left to give the legend its most spiritualized form. 'Wolfram,' says A. Nutt (*Studies on the Legend of the Holy Grail*, London, 1888, p. 257), 'makes his hero win salvation by steadfast faith.' The Grail is here certainly not the Cup of the Last Supper. But the field of Grail attainment is the field of Christian endeavour, and its banner is charity, the charity which for Wolfram changed the unmeaning question, 'What does it (the Grail) serve?' into 'What aileth thee?'

3. **Subject-matter.**—It is quite evident that hundreds of stories were floating about, and that the Romance writers could pick and choose according to individual temperament and desire. To this is probably due the welding of entirely different stories. These stories were, however, based on myths of the world's early days, and were, therefore, near enough akin to be constantly suggesting each other, while differing enough in detail to

make a strange confusion when brought together. Thus we get a loosely-connected mass of incident and at least three heroes—Perceval, Gawain, and Galahad. We may set Galahad on one side as quite probably a late invention. He appears in the *Queste* and *Grand St. Graal*. To this fact is perhaps due the theory that he was invented by Walter Map—possibly as a tribute to the son of Henry II.; more likely in order to detach the story from its early somewhat pagan associations and make the claim of the Church to the story more plausible because of the saintliness of the knight. Gawain and Perceval are both early heroes. In the *Conte* of Chrétien, Gawain is an understudy to Perceval. But close investigation has led Miss Weston to the conclusion that these are the heroes of two different stories which have fused, and that Gawain is the earlier of the two. It is worthy of note how much closer the connexion between Gawain and the rest of the poem is in Wolfram than in Chrétien de Troyes. Persistent features—in addition, of course, to the Grail itself and the question 'Cui on servit?' associated with it—are: (a) *The Vengeance Quest*: the hero sets out with the desire to avenge the fate of his father or uncle—a quite human and, therefore, primitive note. (b) *The Unspelling Quest*: the hero visits a bespelled castle, where he finds either simply supernatural beings such as the maidens or those—neither gods nor men—who linger under a spell from which only a mortal who has attained a certain heroic level can release them. The hero, therefore, must know or do certain things. If he fails, the castle vanishes or he leaves it unnoticed and unhelped. This is obviously a contribution from the childhood of the world, when mortals were half-aware of supernatural powers, with whom magic alone enabled them to deal. (c) *The Great Fool Tale*: this is a primitive story found among all peoples. It takes various forms, but, apart from incidental details, it is generally the story of a youth (son of a god or hero) who in consequence of certain events grows up away from the world and in ignorance of its ways; he returns to that world and, in spite of his want of knowledge, finds his way back to the hero-band to which his father belonged; and, in time, proves himself to be the greatest of them all. The appropriation of this well-known folk-tale for either simple or complex forms of the story is easy to understand, whether the writer had in mind a merely charming romance or one laden with inner meaning. And so this is either the Perceval of Chrétien's courtly poem or the Parzival of Wolfram's spiritual allegory. (d) *The Fisher-king*: the wounded king of the Grail castle is found fishing while he waits for his deliverer. Apart from the Grail itself, and the 'question,' this has been probably the most perplexing feature of the cycle. Attempts have been made to account for the king's occupation in various ways; but all are acknowledged to be not entirely satisfactory. There is, for instance, a possible link with the fish as the Christian symbol, the fish itself appearing in the 'Early History' as that which, caught and laid on the Table, divided the pure from the impure among those who were fed by the Grail. There is also the Salmon of Wisdom of Irish folklore. And, most remote of all, there is even the Babylonian story of Adapa, the wise one and fisher (cf. W. Staerk, *Über den Ursprung der Grallegende*, Tübingen and Leipzig, 1903, p. 55). (e) *The Lance, the Sword, and the Dish*: of these the lance is supposed to be the weapon which pierced the side of Christ, and ranks next to the Grail in importance. The sword is sometimes the weapon of the Vengeance Quest, but elsewhere it is sacred. The meaning of the dish is very uncertain. Indeed, there is some

reason for suspecting that the romancers had taken over the sword and the dish with little conception as to what they were or might signify.

4. Sources.—As has been indicated, there is no primary form of the literature now known to be extant; and there has been much speculation as to sources and originals. It may be taken as fairly certain that the *Evangelium Nicodemi* or *Gesta Pilati* (A.D. 425) is an early source of the Joseph of Arimathæa stories. Surmises based on internal evidence suggest among sources that have disappeared: (a) a possible lost Latin original from which Chrétien, Gautier, and Robert de Borron may have drawn, and which Walter Map (to whom the MSS ascribe the *Queste*) may have compiled; this, it is even thought, might have been the *Book of Philip of Flanders*, which is spoken of in the Prologue to Chrétien; (b) a lost poem by Kyot or Guiot, to whom Wolfram, scorning Chrétien's version, ascribes his version of the story (the rare North French poem, the *Saone de Nausay*, has been used in evidence of the existence of some such poet); (c) a lost Brutus: Robert de Borron in his *Merlin* refers to an 'estoire de Bretagne que on appelle Brutus, que Messire Martin de Rocester translata.' As has been shown above, all these problematic sources would again be dependent for their ultimate origin on a mass of traditional tales preserved and passed on by the bards of the time, of whom Master Blihis or Bleheris, referred to in 'the Elucidation,' may possibly have been one. The contact between East and West, and the especially close touch between England and France, in the century from which these stories come, makes the field of investigation a very far-reaching one and the search for origins extremely perplexing.

(1) *Celtic theory*.—In 1838 the publication of Lady Guest's *The Mabinogion; from the Llyfr Coch of Hergest and other ancient Welsh MSS* called attention to the marked similarity of incident between the three Welsh tales (*The Lady of the Fountain*, *Geraint the Son of Erbin*, *Peredur the Son of Evrawc*) and three Romances of the French trouvère Chrétien de Troyes (*Yvain, le chevalier au Lion*, *Erec*, and *Le Conte del Graal*). The bearing of this similarity on research into the history of the Grail story was at once seen by scholars, who divided themselves into partisans of either (a) the Insular or (b) the Continental school; the one holding that the Welsh tales were the earlier, and the other that the birth-place of the tales was not Wales but Armorica, whence they reached Chrétien de Troyes. Among the leading exponents of the Insular school were Gaston Paris and A. Nutt; and of the Continental school, Foerster and Golther. In the main, the Insular Celtic theory has prevailed. The essence of that theory is that the stories—a *proto-Mabinogion*—passed from the Welsh story-tellers to France through the medium of the Breton *lais*, and were seized upon and given literary form by Chrétien de Troyes. Some of the stories, retranslated, returned to Wales, and these we have in the *Mabinogion*. A. Nutt, in his *Studies on the Legend of the Holy Grail* (London, 1888), has given many instances of what he regards as conclusive proofs that the *Mabinogion* were very near to the myth roots in their primitive simplicity, and that many of the most curious incidents in the French cycle have affinities so close with Celtic folklore that they cannot be overlooked.

(2) *Oriental theory*.—The names of Gaster and Wesseloisky are associated with the hypothesis that the sources of the story are to be found in the East. By them it is connected with the famous Alexander-romance literature and other Eastern myths. There are, of course, characteristics which lend themselves to this theory. Rich Eastern colouring appears in most of the stories; there is

also an Oriental conversion legend; and Wolfram's *Parzival* has many features of this kind, including the introduction of Prester John and the Knights Templar. Most scholars, however, have rejected the theory on the ground that the mere existence of kindred myths proves little. The Crusades, too, with their continual movement between East and West, while explaining many Eastern features, make it impossible to base any origin-theory simply on Oriental colouring. W. Staerk, in his treatise (cited above), p. 44 ff., deals with the connexion between the sacramental cup and the wonder-dispensing vessel, and points out, with many interesting examples, the place of Babylonian myth in shaping 'the ground-tone in that Gnostic-Oriental circle of ideas out of which Judaism and Christianity equally have drawn deeply' (p. 47).

(3) *Nature-cult theory*.—One special ingredient among those suggesting an Eastern origin is very clearly marked—an apparent affinity with elements in the cult of Adonis or some similar Nature-cult. This becomes more important when one notices that this resemblance is plainest in forms of the story adjudged by criticism on other grounds to be the oldest. There is the persistent feature of the wasted land, partly or wholly restored to fertility, especially in combination with the wounded king restored to health: there is an obvious suggestion of 'Tammuz yearly wounded,' and of observances of Nature's annual decay and resurrection, which were not only wide-spread but, on the whole, travelled westwards. The parallel becomes still more suggestive when one notes the prominence of weeping in the Grail legends—sometimes a weeping maiden or maidens, sometimes the weeping of all in the Grail castle: in the *Peredur* there is the weeping and lamenting even without the Grail itself.¹ These affinities were first noticed by Simrock and Martin, but have been more completely worked out by Miss Weston in an article on 'The Grail and the Rites of Adonis' (*FL* xviii., Sept. 1907), and in her second vol. on *The Legend of Sir Perceval*.

(4) *Initiation theory*.—Blended with these elements there are others which suggest affinities with religious mysteries and initiation ceremonies. There is almost always in the Grail story a question to be asked by the hero; he fails to ask it, and draws upon himself the curses of the people of the wasted land; or he asks it partially, and the blight is but partially lifted; by and by he comes again to the Grail castle, and asks it fully and successfully. The same mystery-note is suggested by the 'secret words' which in some of the later forms of the story are confided to the successful Grail-winner; and by 'the changes of the Grail,' beheld by king Arthur, 'in five several manners that none ought to tell, for the secret things of the sacrament ought none to tell openly but he to whom God hath given it' (*High History*, ii. 112). The theory has been suggested that here we have the remnants of an initiation legend—the failure to ask the question representing an *initiation manquée*. The theory is difficult to prove: vagueness and mystery are of the essence of the incident; but it is difficult to account otherwise for the fact that the question-element is so central and so persistent.

5. *Christianization*.—The Christian element in the Grail stories now remains to be considered. This includes the whole 'Early History' material—the story of Joseph of Arimathea and his descendants and their connexion with the Grail, also the conversion of Britain through Joseph's kinsman Brons or his son Josephes. It also includes the Christianized details, which vary in quantity in different forms of the story. Sometimes this

¹ Cf. *Ezk* 8¹⁴; J. G. Frazer, *Adonis, Attis, Osiris*², London, 1907, p. 62., *The Dying God*, 1911, p. 263 ff.

element is very scanty: in the *Diu Cróns* it is practically absent; in the Thornton *Syr Percyvelle* there is nothing except that the Knight goes at last to the Holy Land. Sometimes, again, the documents abound in Christian symbolism or allusion: even in the *Mabinogion*, one comes across nuns, paternosters, baptism, Good Friday; in the *Perlesvaus* there is a strong tincture of asceticism; in Wolfram, though the Grail itself takes its least ecclesiastical form, there is the dove, the Host, and the order of virgin knights, and the Grail vision is denied to a heathen. It may now be taken as an accepted result of scholarship that these Christian elements represent transformations or fusions comparatively late in the history of the Grail idea, and do not give an indication of its ultimate origin, which is much more likely to be found among the elements alluded to in the preceding paragraphs. It is conceivable that a talisman in the form of a vessel or otherwise,¹ and already revered on other grounds, might be changed into the Chalice of the Last Supper by contact with Christian influence, just as the shrines of certain pagan goddesses were absorbed into the cult of the Virgin. But it is inconceivable that the process should work the other way—that a vessel hallowed by immemorial Christian tradition could degenerate into a mere food-producing talisman; it is unthinkable that the Holy Chalice and the lance of Longinus should be turned to the uses of a mere vengeance-quest, as would be the case on the hypothesis of a purely Christian origin for the Grail idea.

The problem remains of the time and place at which the Christian influences definitely touched the non-Christian traditions and accomplished the great fusion. Something of this must have been due to the *Gospel of Nicodemus* (see above; also *HDB* iii. 544 ff.), which had been known in the West for some hundreds of years. Much was also due to the Crusades; in Miss Weston's words (*Legend of Sir Perceval*, ii. 267),

'all eyes were turned to Jerusalem; and the effort to wrest the Holy Places, the site of the Death and Burial of the Redeemer, from the hands of the infidel captured the imagination of all Christendom. Relics of the Passion, fragments of the Cross, the Nails, the Crown of Thorns, were making their way in a continuous procession to Europe; the Holy Lance had been discovered at Antioch; numerous places boasted the possession of the Holy Blood.'

It was very natural that a story of a lance and cup should take on a new colouring from the things which were moving Christendom, and that a hero whose primal quest had been for vengeance on an enemy or for the removal of an evil spell should have his goal transfigured, without always losing all trace of its former character. One of the spots where the Joseph-legend was first localized, and where the 'sang real' was believed to be preserved, was Fécamp.² It is possible and probable that this was one of the most definite points of contact between the Christian and non-Christian traditions. But if that was so, a re-colouring of the whole matter in the interests of Glastonbury must have taken place when the Christianized story crossed the Channel and touched again the borders of the Wales from which, before its baptism, it had emerged. The reign of Henry II. (1154–89) coincides with three noteworthy things: the climax of the 'sang real' interest at Fécamp; the attempt to utilize the Arthurian tradition in the conciliation of wild Wales; and the ecclesiastical assertion of Britain against Rome, resisted by Thomas à Becket. There was thus a strong inducement to Christianize the cup of Celtic legend and to glorify Glastonbury as the home of the sacred Chalice;

¹ The much discussed stone in Wolfram may have been a vessel cut from stone. The *sauro catino* at Genoa was said to have been cut from an emerald.

² In 1171 the relic was discovered in a pillar, and exhibited above the High Altar of the Abbey. See Le Roux de Lincey, *Essai sur l'abbaye de Fécamp*, Rouen, 1840, p. 79 ff.

and the ambitions and necessities of Henry II. may have helped to give the legend its final form and home. It was a convenient thing that the sanctity of Glastonbury should rival that of any Continental shrine, and that the antiquity of its traditions should be widely known and revered.

The Grail legends, however thoroughly Christianized, always retained a flavour of heterodoxy; they never fully or universally received the sanction of the Church. This has been accounted for in different ways—by the fact that they involved too high a claim for the British Church; or because they were so largely coloured by the adventures, and, therefore, by the reputation, of the Knights Templar; or because they embodied elements derived from pagan faith and worship. Whatever ecclesiastical suspicion may have gathered round the theme was possibly intensified by the controversy regarding the denial of the cup to the laity. The deprivation caused wide-spread resentment, and the Grail may have taken to itself fresh glory as the symbol of an unsatisfied desire. Sebastian Evans' ingenious reading of one form of the story—in which he interprets the Fisher-king as the Pope, Perceval as Dominic, Galahad as Francis, the wasted land as Britain under the interdict, etc.—is, if unconvincing as an interpretation, at least a proof of the ease with which the story can be made to fit a theory. In early days it may have been equally easy to use it to convey an impression, if not definitely to advocate an opinion.

6. **Significance and symbolism.**—Is there any hypothesis which would unify these different ideas, and which, actually and historically, even if semi-unconsciously, might have served for a basis of fusion? The likeliest of those that have been suggested is the idea of the quest for the secret of life: it is sufficiently ancient, persistent, and close to the abiding instincts of men. The Adonis rites were concerned with the death and the quickening of the natural world. Some of the ancient mysteries were the expression of the human hunger for the supreme secret, and a promise of its satisfaction. May not some forms of this quest, and some dreams of its goal, have hidden themselves among the Celtic races, to emerge again in tales about the quests of heroes, the deliverance of a blighted land, or the achievements of a cauldron of plenty? Meantime there had come down another line of development the story of another Cup, hallowed by its connexion with the most sacred Name, exalted by the sacramental principle now accepted throughout Christendom, revered as the means whereby souls questing for life found life indeed. *Visio Dei vita hominis*; and God and life were together in the cup of sacrifice. So the two life-quests met, being aided in their fusion at once by certain convenient resemblances of external form, by historical causes alluded to above, and not least by underlying unity of essential idea. Through this fusion there was fashioned one of the richest influences which have ever inspired music, poetry, and art; and an abiding symbol for the moral and spiritual idealism of pilgrim humanity. Seen from different stand-points, the Grail became the emblem of moral purity, or of triumphant faith, or of soldierly heroism, or of gracious charity; the radiance of it became the radiance of that ultimate perfection which allures those who struggle and rewards those who attain. It is noteworthy that Robert de Borron, before the tradition had time to be deeply ecclesiasticized, and Richard Wagner, who had no special ecclesiastical interest to serve, should alike be able to see the spiritual significance of the Grail idea. While the symbol has still a special meaning for

'Godly hearts that, grails of gold,
Still the blood of faith do hold,'

it also expresses in the most comprehensive way, by virtue of its ancient origins and devious wanderings, the purest desire and best attainment of the human spirit.

LITERATURE.—In addition to the books and articles mentioned above in text and notes, see Lit. appended to art. ARTHUR, ARTHURIAN CYCLE. Of those mentioned there, the most useful in the present connexion are those of Birch-Hirschfeld, A. Nutt, and Jessie L. Weston. E. Wechsler (*Die Sage v. heil. Graal*, Halle, 1898) gives a very complete bibliography. See also J. L. Weston's second vol. of *Sir Perceval Studies*, London, 1909; A. Nutt's smaller book (popular, but sufficient), *The Legends of the Holy Grail*, do. 1902; Sebastian Evans, *In Quest of the Holy Grail*, do. 1898; A. E. Waite, *The Hidden Church of the Holy Grail*, do. 1909; Paul Hagen, *Der Gral*, Strassburg, 1900; cf. also an art. by A. Nutt, in *FLR* iv. (1881), on the connexion between the Grail stories and J. G. von Hahn's 'Aryan Expulsion-and-Return-Formula.' Among modern poetical expressions of the Grail idea, the most striking, next to Tennyson's, is that of R. S. Hawker, *The Quest of the Sangraal* (an unfinished fragment, Exeter, 1884; reprinted in *Poetical Works*, London, 1899). A fine practical and homiletical treatment is given by J. H. Skrine, in *Sermons to Pastors and Masters*, London, 1910, p. 211 ff.

J. M. E. ROSS and MARGARET ROSS.

GRANTH (Skr. *granth(a)* 'book,' 'treatise,' 'code,' or 'section' [Platts, *Hindustani Dictionary*, London, n.d., s.v.]).—The term *granth* is applied generally to any book, especially to a religious book. In the Sikh religion the Granth denotes the general body of the Sikh scriptures, which comprise two main parts: (1) the *Ādi* (or 'original') Granth, which was compiled by Guru Arjun, the fifth Sikh *guru*, from the writings of Bābā Nānak, the founder of Sikhism, and many other religious reformers; and (2) the *Dasam Pādshāhī dā Granth* (abbreviated to *Dasam Granth*), or 'Granth of the tenth Pādshāh,' viz. Guru Govind Singh, the tenth and last *guru* of the Sikhs. All Sikhs accept the authority of (1); but that of (2) is confined to the extremist sections of the Sikh community. From Granth is derived *granthī*, 'an expounder of the Sikh scriptures,' 'a reader or custodian of the Granth' (see Ernst Trumpp, *The Ādi Granth or Holy Scriptures of the Sikhs*, London, 1877; and Max Arthur Macauliffe, *The Sikh Religion: its Gurus, Sacred Writings, and Authors*, 6 vols., Oxford, 1909).

The *Ādi Granth* in its present form was compiled by Guru Arjun (1581–1606), but after his time some of Teg Bahādur's verses were added to it, with a single distich of Guru Govind Singh. The compilation included not only the extant writings of the earlier *gurus*,¹ but also those of many *bhagats*, or devotees, such as Rāmānanda and his disciples, Dhanni the Jatt, Pipā, Ravidāsa, Kabir, and Sainu, as well as Shaikh Farid, the Muslim *ṣūfī*, and Nāmadeva. Those of the last-named are of special linguistic interest, as he is considered the first Marāthī writer. Further, Guru Arjun appears to have added a number of panegyrics composed for the occasion by various *bhatts* (*bhatts*, or professional bards), but these are of little interest.² The Granth itself comprises a *Japji*, or introduction, by Nānak himself, the *So-daru*, or extracts from the *Rāg Āsā* and *Rāg Gūjari*, which are used as an even-song by the Sikhs,³ the *So-purkhu*, or further extracts from the *Rāg Āsā*, by Guru Rām Dās, and the *Sō-hilā*, or extracts from the *Rāgs Gauri, Āsā*, and *Dhanāsari*,⁴ which

¹ Bābā Nānak, Angad, Amar Dās, and Rām Dās, predecessors of Arjun.

² Macauliffe describes these as panegyrics of bards who attended on the *gurus* or admired their characters.

³ The *So-dar* or *So-daru* is classed by Macauliffe as one of the *Rahīds*, a collection of the hymns recited at sunset by the Sikhs. The hymns in this collection were composed by the Gurus Nānak, Amar Dās, Rām Dās, and Arjun, in the two modes stated.

⁴ To these Macauliffe (l. 259) adds *Rāg Gauri Purbi*. The *So-hilā* derives its name from *sovan wela*, 'the time for sleep,' and consists of hymns by Gurus Nānak, Rām Dās, and Arjun, in the modes stated.

are used as a prayer before retiring to rest. The morning service of the Sikhs consists in the recitation of the *Jappī*, followed by the *Āsā kī Wār*, which was composed almost entirely by Guru Nānak, though it includes some stanzas by Guru Angad. *Wār* meant originally a dirge for the brave slain in battle, but the term came to mean any song of praise. *Wārs* were composed in stanzas called *pauris*, 'ladders,' which were chanted by professional minstrels. The Granth of Guru Govind Singh contains his *Jappī*, the *Akal Ustat* (or praise of the creator), the *Vachitar Natak* (or Wonderful Drama), in which the Guru gives an account of his parentage, his Divine mission, and the battles in which he had been engaged. His militant character is illustrated by the inclusion of three abridged translations of the *Devi Mahātmya*, an episode in the *Markandeya Purān*, in praise of Durgā, the goddess of war. Then follow the *Gyān Parbodh* (or awakening of knowledge); accounts of 24 incarnations of the Deity, selected because of their warlike character; the *Hazāre de shabd* (quatrains in praise of God and in reprobation of idolatry and hypocrisy); the *Shāstar Nām Māla* (a list of weapons used in the Guru's time, with special reference to the Creator's attributes); the *Tria Charitar* (or tales illustrating the qualities and deceit of women); the *Zafarnāma* (an epistle of the Guru to Aurangzib); and several metrical tales in Persian. According to Trumpp, the body of the Granth comprises 30 original *Rāgs*, including those from which extracts are inserted in the foregoing parts, and a 31st *Rāg*, called the *Jai-jāvanti*, which was composed by Teg Bahādur. Among these *Rāgs*, or modes, are distributed the verses of the various *gurus*, and to each *Rāg* sayings of one or more *bhagats* are appended, but without any system or order. The first four *Rāgs* are the most important. Macauliffe's account agrees in essentials. He describes the hymns of the *gurus* and saints as arranged according to the 31 *Rāgs* in which they were composed, and adds (vol. i. p. li) :

'The first nine Gurus adopted the name Nanak as their *nom de plume*,¹ and their compositions are distinguished by Mahallas or *quartiers*. The Granth Sahib is likened to a city, and the hymns of each Guru to a ward or division of it. Thus the compositions of Guru Nanak are styled Mahalla one, that is, the first ward; the compositions of Guru Angad the second ward, and so on. After the hymns of the Gurus are found the hymns of the *Bhagats* under their several musical measures.'

But, despite its varied origins, the Granth is to the Sikhs the embodiment of their *gurus*.

The Granth is concluded with a *Bhog*, which comprises a number of *Shloks*, and minor pieces by various *gurus* and *bhagats*. Owing to the diversity of its origins, the book is not written in any one language, but in various vernaculars of modern India. Thus Nāmadeva wrote in an old form of Marāthī; and the Brāhman Trilochan closely resembled him in style. Jaideo used a curious mixture of Sanskrit and the modern vernacular, while Rāmānanda's idiom is the old Hindī, differing little, if at all, from that of Kabir and his co-disciples. It is curious that, though Nānak and his successors were all natives of the Panjāb, they used an idiom closely resembling the Hindī, doubtless in imitation of Kabir and the other *bhagats*, to whom they owed so much as religious teachers. The result is that parts of the Granth, e.g. that of Govind Singh, which is in pure Hindī, are unintelligible to the modern Sikhs.

The metres of the Granth, which is wholly in verse, are either old Prākṛit metres or of a later type, the verses being measured by quantity only and always rhyming.

¹ The ten *gurus* are regarded by the Sikhs as only one person, the light of the first Guru's soul having been transmitted to each of his successors in turn. Cf. with this the Shi'a teaching of the devolution of the *nūr*, or light, of the Prophet upon his descendants.

LITERATURE.—Trumpp's tr., as cited in the art., though it deserves much of Macauliffe's criticism for its obscurity, is prefaced by a valuable introduction. His notes on the Lexicography of the Granth are in the Royal Library at Munich. He published a useful booklet on *Die Religion der Sikhs*, Leipzig, 1881. Macauliffe's work is valuable as reproducing the view of the *gyānis*, or traditional interpreters, of the Granth, but it lacks an *apparatus criticus*.

H. A. ROSE.

GRATIÆ.—See CHARITES.

GRATITUDE.—There are many human emotions that can be understood only if taken directly in connexion with the social nature of man. They presuppose the fact that men dwell together in communities—have common interests, share common experiences, run common risks, and find unity to be power. To this class belong the tender emotions—those that are excited by concern or regard of one person for another, and that are essentially of a cementing and beneficent kind. Supreme among these is love, which carries along with it parental, filial, and similar affections—love of kinsfolk, love of country, and the like; next are friendship and the allied feelings of esteem and admiration; then come the benevolent affections or affections of good-will, including sympathy, compassion, pity, and so forth; and last of all may be instanced gratitude, which has distinct relations to all the others just enumerated.

1. Nature and origin.—Gratitude has been defined as 'that delightful emotion of love to him who has conferred a kindness on us, the very feeling of which is itself no small part of the benefit conferred' (Thomas Brown, *op. cit. infra*, lxiii). The definition, though correct so far as it goes, is not adequate; it does not reach the real centre of the conception. We wish to know what is the nature of the emotion, whence it originates, and how it manifests itself.

(1) First, then, we observe that what arouses the emotion is not the magnitude of the benefit conferred (although this may react upon it), but the display of friendliness, affection, and good feeling on the part of the benefactor—such manifestation of good-will and kindly consideration for the recipient as cannot be claimed or exacted. There is no claim, properly speaking, in true gratitude: giver and receiver both gain, but neither claims. Hence, gratitude is not, as the cynic has so frequently represented it to be, mere 'bread and butter' affection; nor is it the prudential 'regard for favours to come.' These are purely selfish considerations, marks of an unworthy calculating egotism, which debase the emotion and transform it into what is mean and ignoble. Gratitude is an unselfish joyous response to kindness—a response that is immediate and spontaneous; the ultimate meaning of which is that human nature is so constituted that affection and unity between persons is the foundation of it, ill-will and enmity (all indications to the contrary notwithstanding) being abnormal and depraved. Hence the biting force and odious character of ingratitude. 'Blow, blow, thou winter wind, thou art not so unkind as man's ingratitude' (*As You Like It*, II. vii. 174 ff.). Now, why? Not simply because the ungrateful man does not fully value one's gift (that would be a small matter), but also because he throws back one's good-will with coldness and thereby cuts one off from a place in his affections: in him, as Kant puts it, 'the duties of philanthropy are inverted, and the want of love is transmuted to a title to hate those by whom he has been first beloved' (*Metaphysic of Ethics*, tr. J. W. Semple, Edinburgh, 1836, p. 306).

The nature of gratitude is not obscurely indicated in the fact that 'grace' and 'gratitude' are at root one and the same term, and represent the

reverse and the obverse side of the same fact—more clearly expressed, perhaps, in Greek, where the one word *χάρις* is expressive of both. The Greek term shows that the emotion is essentially a social one, and works in the atmosphere of unity and love, and is, therefore, a species of 'brotherly affection.'

(2) On all hands it is allowed that gratitude is a joyful and pleasant emotion, though there may be in it an element of pain—more especially when it begets solicitude for the object of it. But, though this is granted, the source of the joy is matter of dispute. It has sometimes been maintained that gratitude arises either from our appreciation of the value of the benefit received, or from recognition of the fact that the benefactor has sacrificed something for our sake. This needs examination. There is no doubt that the value of the gift frequently comes in to augment the joy which we experience, especially when the benefit takes the form of freeing us from pain or from an embarrassing situation. It is equally indisputable that a well-balanced nature esteems sacrifices that are made on its behalf. But, although these facts may be necessary to the full explanation of the intensity of the joy that some cases of gratitude exhibit, they do not account for the essence of the emotion itself. For example, a pecuniary gift that brings a man domestic comfort, where penury and pinching held sway before, necessarily affords pleasure; but he will not be grateful for it unless, with greater or less consciousness, he realizes that it was the embodiment of benevolence, and that, in bestowing it, the giver was also bestowing himself. Relief from pain or suffering necessarily exhilarates and satisfies us; but the exhilaration and satisfaction become gratitude only when our heart goes forth to the person who has conferred the boon, and we desire his welfare. Moreover, one is frequently grateful, and that in a very marked degree, for benefits that cost the giver little, or that are in themselves of a trifling nature. Why in that case we are gratefully affected is because we recognize that the heart of the giver is embedded in his gift. Still further, a benefit is a source of gratitude to a man only so long as he believes that the person who confers it means his good. Let us suspect that he has a sinister object in view in helping us, and immediately our gratitude is turned into indignation and resentment: he has not been giving himself to us in his gift, but has been using us as a tool, a means to an end, thereby making us his slaves and his inferiors.

(3) From all this it will be at once apparent that, in gratitude, there is an element of *admiration*—admiration, by the recipient, of his benefactor as a man who finds it in his heart to bestow what cannot legally be claimed of him, and who is moved by non-selfish or altruistic regard. Generosity and disinterestedness are by their very nature impressive, and admiration is conditioned by mutual respect.

(4) From this it will be apparent, also, that gratitude is near neighbour to sympathy: it is not sympathy, but it involves it. Unless the recipient could place himself in imagination in the position of the giver and realize his kindly feeling and good intention towards him, gratitude could not arise; nor could the benevolence that actuates the giver have birth, did he not, in like manner, take home to himself the situation and the responding goodwill and tender affection of the recipient. What sympathy does is *to enable us to realize*; whereas gratitude is *the result* of the realization.

2. Feeling or sense of inferiority.—It has often been a question keenly debated, whether gratitude does not place the grateful person in a position of inferiority hurtful to his self-respect, and, conse-

quently, whether it should not be looked upon as a cringing and undesirable emotion. At any rate, in old Greek days, it was very much regarded in this light; and one of the characteristics of 'the high-minded man' (*μεγαλόψυχος*) of Aristotle is that, if he has to receive a favour, he hastens to pay it back with a greater, so as to escape from the disagreeable feeling of indebtedness.

'It is his nature,' so we read (*Eth. Nic. iv. 3, 24f.*), 'to confer benefits, but he is ashamed to receive them; for the former is the part of a superior, the latter of an inferior. And, when he has received a benefit, he is apt to confer a greater in return; for thus his creditor will become his debtor, and be in the position of a recipient of his favour. It is thought, moreover, that such men remember those on whom they have conferred favours better than those from whom they have received them; for the recipient of a benefit is inferior to the benefactor, but such a man wishes to be in the position of a superior. So he likes to be reminded of the one, but dislikes to be reminded of the other.'

In like manner, Cicero, in the Latin world, discourses rather coldly on the topic of benefits—when they should be received, and how and in what manner they should be conferred. As might be expected, he views the matter from a shrewd, practical, common-sense standpoint, and indulges in sage counsel of the prudential stamp, delivered from the moralist's platform, without much feeling and with little sympathetic interest (see *de Officiis*, i. 14-17). And even Seneca, in his *de Beneficiis*, does not get rid of this feeling of inferiority in the recipient—subtle, stimulating, and suggestive though his treatise be.

Now, that 'giver' and 'receiver' indicate two different relationships cannot be denied; and the situation is a delicate one as between recipient and bestower; it may, further, be allowed that 'it is more blessed to give than to receive.' But, when the gift takes the form of a token of goodwill, in which, therefore, the giver imparts himself, and when the responding gratitude in the recipient is the offer of his self in exchange (which even sincere 'thanks' always implies), there is no galling inferiority involved—certainly not such as would infringe on one's self-respect—but an exchange of love, generous and free, in so far as each self is given and each is accepted or received. Surely, if it is not derogatory to our dignity to learn of a person wiser or better than ourselves, it is not derogatory to our dignity to receive a benefit from one who is friendly to us and who has both the power and the will to confer it. As finite beings, we are naturally limited in our ability to supply our own needs; and, as members of the human race, we are bound to each other in mutual obligation from our birth to our death, nobody being excepted. Thus, favours conferred, where *all* need help, impose no derogatory inferiority on any. On the other hand, if the gift bestowed were accepted simply because of its extrinsic value—simply because, for example, it is a certain desirable sum of money—then disparaging inferiority would, indeed, be implied in gratitude (we have demeaned ourselves); but, inasmuch as the real origin of gratitude is to be found, not there, but in the gift of the giver's own self, it is altogether different. Hence, paying back the benefit or favour at the very earliest moment, so as to rid oneself of a distasteful obligation, becomes an irrelevant consideration here, and the thought of it vitiates, if it does not actually destroy, the noble emotion. The idea of paying back, so far as it really enters into the situation, is simply readiness on the part of the person benefited to befriend the benefactor, should necessity arise and the ability be present—the response, then, of love to love. It is the characteristic of gratitude that it links the recipient to his benefactor in the bonds of love, and the goodwill in the case is mutual. If the recipient believed that the

gift was not a true expression of the giver's self, or if it was bestowed grudgingly or ungraciously, then, while he might accept it (stern necessity being laid upon him), he certainly could not feel himself bound to the giver in true gratitude: heart has not gone forth to greet heart—the commercial idea has intervened to spoil the tender emotion. It is then that the recipient longs to pay back the gift at the earliest moment—to free himself of a galling burden: he has never had the gift as more than a loan; and the longer he keeps it, the more, he feels, are the interest and debt accumulating.

The process in gratitude might be expressed in physiological language, after the analogy of reflex action. In order to a reflex action, three things are necessary—a central nervous cell (O); an ingoing impulse from a sense surface (A), along a sensory or afferent nerve, liberating energy at the centre; an outgoing current (E), consequent on the discharge of energy, along an efferent or motor nerve, to a motor end organ, resulting in movement. Precisely so, with a certain difference, is it in the case of gratitude. If the conscious recipient be regarded as the nerve centre (O), then the inflowing current from the benefactor (A) creates an immediate response, which, however (and here is the distinctive difference), in the first instance, traverses the path of the ingoing current in the reverse order, back to the benefactor (A), and then, secondarily, manifests itself in active outflow (E)—in readiness to serve.

3. Religious and theistic bearings.—(1) The true nature of gratitude is strikingly exemplified in the realm of religion. In Scripture, God's 'grace' (*χάρις*) is represented as poured down on men—it comes as expressive of the Father's love, unsolicited and unmerited; it is the Father's affection taking outward beneficent form in relation to His earthly sons. The result is that, immediately on recognition of this, man's 'gratitude' (*χάρις* also) springs up towards God—it is the cheerful and spontaneous response to the request, 'My son, give me thine heart': in other words, love has begotten love, and a willing dedication of the creature to the Creator is the consequence—'The law was given by Moses; grace and truth came by Jesus Christ' (Jn 1⁷). Here, in especial, the joy of gratitude is associated with awe, as all deep joy is.

(2) Again, the place of gratitude among the emotions is a very important one, and its worth for human life and in the interests of religion is inestimable. It is but a phase of the solidarity of the race, on the one hand—'none of us liveth to himself, and no man dieth to himself' (Ro 14⁷); and, on the other hand, it is the basis of man's true relationship to God and to Jesus Christ. In the Christian religion, it means not only the welling up of affection towards the Heavenly Father and the Divine Redeemer, but also the dedication of the believer to the service of the Divine: as the writer of the Epistle to the Hebrews puts it, 'Wherefore, receiving a kingdom which cannot be shaken, let us have gratitude (*εχωμεν χάρις*; EV 'grace,' RVm 'thankfulness'), whereby we may offer service well-pleasing to God with reverence and awe' (12²⁸). This service of the Divine is the equivalent in religion of the good-will and readiness to benefit a benefactor in the sphere of the human.

(3) Hence, lastly, gratitude has a distinct religious value in relation to theism and theistic argument. When the evidence or testimony to God's existence, in Natural Theology, is laid (as it so frequently is) in human nature, one part of that evidence is placed in the emotions (the other sources being the intellect and the conscience), and, of the emotions, gratitude is not the least impressive for the purpose. Indeed, man's 'feeling of dependence' has often been represented (as by Schleiermacher) as the supreme source of theistic belief. And, certainly, feeling of dependence has to do with it, whether in an eminent degree or not.

Yet, feeling of dependence is only the other side of gratitude—the Creator giving Himself freely to the creature, and the creature responding to the significance of this by dedicating himself unreservedly to the Creator. Love craves for love, and rests in it when found.

LITERATURE.—Aristotle, *Nic. Eth.* iv.; Cicero, *de Officiis*, l.; Seneca, *de Beneficiis*; Spinoza, *Ethica*, iii. and iv.; F. Hutcheson, *Inquiry concerning the Original of our Ideas of Virtue or Moral Good*, London, 1725 (esp. §§ ii. and v.); Adam Smith, *The Theory of Moral Sentiments*, ed. London, 1861, pt. ii. § 1; Kant, *Metaphysic of Ethics*, Semple's tr., p. 300 (ed. Edinburgh, 1836); Thomas Brown, *Lectures on the Philosophy of the Human Mind*, Edinburgh, 1820, lxiii.; A. Bain, *The Emotions and the Will*, London, 1898, pp. 144-146; J. Martineau, *Types of Ethical Theory*, Oxford, 1885, ii. 229; H. Sidgwick, *Methods of Ethics*, London, 1890; W. L. Davidson, *Theism as grounded in Human Nature*, do. 1893, Lect. vii.; C. Mercler, *The Nervous System and the Mind*, do. 1888, p. 318; A. F. Shand, in Stout's *The Groundwork of Psychology*, London and New York, 1903, pp. 206-220; W. MacDougall, *Introd. to Social Psychology*, London, 1908, p. 182.

WILLIAM L. DAVIDSON.

GREAT MOTHER.—See MOTHER OF THE GODS.

GREAT SYNAGOGUE.—See JUDAISM.

GREAT VEHICLE.—See MAHĀYĀNA.

GREECE, GREEK RELIGION.

[L. R. FARNELL.]

The foundation of a serious and scientific study of Greek religion, as distinct from the mere mythology of Hellas, may almost be said to have been an achievement of the last generation of scholars. And at last the Hellenic spirit, so creative and imperial in the domains of literature, art, and science, can be recognized as manifesting itself not unworthily in the sphere of religion.

The history of Greek religion means, partly, the account and the interpretation of the various rites, cults, and cult-ideas of the various Greek families, tribes, and communities; partly, the statement of the religious temperament both of the masses and of the individuals who emerged from among them and of whom some record has been preserved. Now, as the Greek world in the long period of its independence was never organized as a single State, the attempt to give a summary and general account of its religion is confronted with the perplexity arising from the often incalculable diversity of religious forms and ideas in the different centres of its social life, which was in the highest degree centrifugal. Nevertheless, as will be shown, we find in the midst of manifold local variation a certain uniformity of religious psychology, making for uniformity of practice, which enables us to deliver certain general pronouncements about the whole.

ANCIENT SOURCES.—I. Literary.—Our real knowledge of any ancient religion depends obviously on the copiousness and variety of our records. And it is likely to be more luminous if the society in question expressed its religious life not only in surviving literature, but also in surviving art. Of both these kinds the student of Greek religion has an unusually rich material.

For, in spite of its secular freedom, which is its salient achievement, Greek literature in its highest and most popular forms, as well as in its narrower and more special, is deeply infused or preoccupied with religion and religious myth. In fact, it reflects the vivifying penetration of religion into all parts of Greek activity and mental life. This is obviously true of the Epic period, which produced the two types of the chivalrous and the theologic Epic, and which has left us most valuable material

for the religious history of the 10th and 9th centuries B.C. in the Homeric poems, and of the 8th and 7th centuries in the poems of Hesiod and in the 'Homeric' hymns; it is none the less true of the great Lyric movement which followed upon that, when the greatest poets devoted themselves to the composition of songs for festal-religious occasions or of hymns for the service of temple or altar. Besides these, whose great names and fragments of whose great works survive, there was another less distinguished group of special 'hieratic' poets, who composed hymns for the service of certain mystery-cults, and whose compositions were preserved as liturgical documents by the priestly families that administered them. The sententious ethical-political poetry of the 6th cent.—the elegiacs of Theognis and Solon—is instinct with religious emotion and reflexion. And the greatest product of the poetic genius of Hellas—the tragic drama—is of a religious character in respect both of its origin and much of its subject-matter. Finally, the later learned poetry of the Ptolemaic period—the *Cassandra* of Lykophron, the hymns and other works of Callimachus, the Epic poem of Apollonius Rhodius—is full of antiquarian religious lore. At the same time, our knowledge is much indebted to the great prose-writers of Greece, the philosophers, historians, and orators: among the philosophers, especially to Plato, who more copiously than any of the others reveals to us, however much he idealizes, the religious psychology and cult-phenomena of his period; among the historians, especially to Herodotus, who is the intellectual ancestor of the modern anthropologist and student of comparative religion, and whose presentation of the facts of history is coloured with religious conviction. The works of the Attic orators are of special value for our purpose, first because the classical orator was more apt than the modern to dilate on religious themes and appeal to religious sentiments, as religion was far more closely interfused with political and social life; secondly, because we are more sure of the orator than we can be of the poetic or philosophic writer that his words are attuned to the average pitch of popular belief and sentiment.

It is true then that all the great fields of Greek literature make their several contributions to the material of our subject. And besides the works of the great masters, the student has to reckon with the secondary and parasitic work of the later scholiasts, compilers, and commentators, which is even more replete with the special information upon which the history of Greek religion can be built. The study of it is, in fact, almost coextensive with the study of Greek literature.

But amidst this profusion of material we must specially mark the works of those ancients who wrote direct treatises on the various religious phenomena—on the gods, the cult-practices, the theologic and mythologic systems of the Hellenic societies. The earliest of such works that have come down to us are the poems of Hesiod and the Hesiodic School—the *Works and Days* and the *Theogony*—while of parts of the 'Homeric' hymns the special theme is the attributes and functions of the various divinities. But it was not till the period of scientific activity after Aristotle that definite treatises in prose on different departments of the national religion began to be rife. A chapter on sacrifice by Theophrastos is mainly preserved for us by Porphyry. The writers of 'Atthides,' or Attic history and antiquities, who belonged mainly to the 3rd cent., were special workers in this field; Philochoros, the chief of them, wrote 'on Festivals,' 'on Sacred Days,' 'on Divination,' 'on the Attic Mysteries'; Istros, the slave and friend of Callimachus, on the 'Manifestations of

Apollo' and on 'the Cretan sacrifices'; while the *Ἐτηρητικόν* of Kleidemos was, if we may judge from the fragments that remain, occupied with the problems of religion and mythology. Outside this circle we hear of other contributions to the history of Greek religion, such as the treatises of Herakleides, probably the pupil of Aristotle, usually called 'Pontikos,' on 'the Foundations of Temples' and 'on Oracles'; and a work by an unknown Sokratos of Kos on the important subject of 'Invocation-titles of the gods.' Lastly may be mentioned here a treatise of Apollodoros, *περὶ θεῶν*, which, if he is to be identified with the author of the *Bibliotheca*, was probably a learned account of the popular religion rather than a metaphysical inquiry.

Of nearly all this scientific post-Aristotelian literature only isolated fragments survive in quotations by later writers, lexicographers, and scholiasts, who were, no doubt, more deeply indebted to it than they always acknowledged; but it is some compensation for our loss that the work last mentioned, the *Bibliotheca* of Apollodoros, has been preserved—a rich storehouse of myth and folklore with some infusion of actual cult-record. Among the later writers our subject is indebted to the geographer Strabo for many incidental observations of local cults and ritual, still more to the philosophic moralist and *littérateur*, Plutarch, a man of earnest religious interest and some power of original thought, who knew the religion of his country at first hand and at a time when it was yet alive, and who devoted to it much attention and some literary industry; hence we must rank high among our ancient authorities his *Quæstiones Græcæ* and his treatises 'on the Pythian Oracle' and 'on the Cessation of Oracles.' Again, much desultory but varied information is afforded by the compilers Athenæus (in his *Deipnosophistai*) and Stobæus (in his *Florilegium*). But of higher value than all these, or, in fact, than any work that has been bequeathed to us from antiquity, is the *Descriptio Græciæ* by Pausanias, composed about A.D. 180; for he travelled somewhat as a modern anthropologist, relying partly on earlier literature, yet using his own eyes and ears and his own notes. His ruling passion was the study of the folk-religion and the religious monuments; so that it is due mainly to him that we know something of the village-religion of Hellas as distinct from that of the great cities, and can frame working theories of the evolution, through immemorial ages, of various growths of the polytheism.

The lexicographers Harpokration, Hesychios, and Suidas contribute facts of value, especially in their citation of cult-appellatives, which, owing to the magic value of the special name or title whereby the deity was invoked, throw a revealing light on the significance and power of many a worship, and help to frame our conception of the complex character of many a divinity. Again, the various collections of *scholia* on the classical texts are a rich quarry for our reconstruction of the fabric of Hellenic religion. Of chief value among these are the scholia on Homer, Pindar, Æschylus, Euripides, Aristophanes, and Theocritus, while Servius' Commentary on Virgil tells us even more about Greek cult and mythology than about Roman; and high in this class of our authorities we must rank a work of late Byzantine learning, the commentary of Tzetzes on Lykophron's poem *Cassandra*, for his scholia are charged with remote antiquarian lore derived from good sources.

Finally, we gather much of our knowledge from the controversial treatises of the early Christian Fathers, written with propagandist zeal in the heat of their struggle against paganism. They reveal to us much of the religion that they strove

to overthrow by the exposure of its viciousness and its absurdities. But their statements must be used with cautious criticism. Their knowledge was by no means always at first hand, unless—which we rarely know to have been the case—they were, like Clement of Alexandria, converted pagans who had been bred up in the Græco-Roman polytheism. Their statements, for instance, about the Greek mysteries are often vague and unconvincing, while in their desire to include them all in one general condemnation they confuse Anatolian rites with Eleusinian. And they are pardonably blind to the often beautiful ritual, the nobler ideas, and the higher moral elements in the older Mediterranean religions. Nevertheless, if we make due allowance for prejudice and exaggeration, works such as the *Protrepica* of Clement, the treatise of Arnobius *adversus Gentes*, of Firmicus Maternus *de Errore Profanarum Gentium*, Eusebius' *Præparatio Evangelica*, Augustine's *de Civitate Dei*, Athenagoras' *Legatio*, must be ranked among the primary sources of our history.

A special but very important chapter in the later history of Greek religion is the account of the growth and diffusion of the religious brotherhoods, especially the Orphic Dionysiac societies. For these we have something of direct liturgical evidence in the collection of Orphic hymns, mainly the products of the later theosophic period, but throwing light on the theology and ritual of these sects. But our knowledge of this mystic religion which was engrafted upon Hellenism has been in recent times enriched by the priceless discovery of an ancient poetical Orphic liturgy engraved upon gold-leaf found in tombs of Crete and South Italy, and probably a product of the 5th cent. B.C.

2. Monumental.—The above is a sketch of our more important literary sources. The knowledge to be derived from them would on the whole and in many important details remain vague and uncertain, were it not supplemented and secured by the evidence coming from another source which we may term monumental or at most semi-literary—the evidence from inscriptions. These have been accumulated in vast profusion during the last thirty years; and have been and are still being reduced to order for our special purpose. The public inscriptions, being dry State documents, do not reveal to us the heart of any mystery or the religious soul of the people, but rather the State organization and the exact minutiae of ritual and sacrifice from which we can sometimes reconstruct an image of the inward religious thought. And many a local cult of value for our total impression that was unrecorded by any writer is revealed to us by these monuments. But the needs and aspirations of the private man are better attested by the private inscriptions attached to *ex voto* dedications or commemorating Divine benefits received.

Yet, amidst all this wealth of evidence, there seems one thing lacking. Of actual temple-liturgies, of formal prayers proffered round the altars, of the hymns chanted in the public service, of all that might constitute a text of Greek church-service, there is comparatively little preserved. One or two hymns, and a few fragments of the religious lyric of the 7th cent.—to which we may now add the important recent find of the pæans of Pindar; a strophe of an ancient hymn to Dionysos, sung by the Elean women; a 4th cent. pæan to Dionysos, composed for the Delphic service; the newly discovered hymn of the Kouretes in Crete; a few formulæ of prayers quoted or paraphrased by later writers—all this appears meagre material when we compare it with the profusion of documents of the public and private religion that are streaming in from Babylon.

But, in respect of another source of the history

of religion, namely, the monuments of art, our Greek material is unique. For the greatest art of Hellas was mainly religious, the greatest artists working for the religious service of the State. And the surviving works of sculpture, painting, and glyptic, wrought for either public or private purposes, present us often not only with facts of religion and ritual unrecorded in literature, but also with an impression, hard to gain otherwise, of the religious consciousness of the people, and serve also as witnesses to the strength of the religious feeling. Therefore the study of Greek religion is concerned as much with the art and archæology as with the literature.

A summary sketch of so manifold a theme as that with which this article deals will be of more value if it can present the facts in some kind of chronologic sequence. We may conveniently distinguish four periods: (1) the pre-historic, falling mainly in the second millennium B.C., and closing with the epoch marked by the Homeric poems; (2) the period extending from 900 to 500 B.C., beginning with the colonial expansion of Hellas, and ending before the Persian invasion; (3) the period from 500 to 338 B.C., including the greatest century of Greek history, and closing with the battle of Chæronea and the establishment of Macedonian supremacy; (4) the Hellenistic and Græco-Roman period. The chronologic statement is embarrassed by the absence of any record of date for the institution and diffusion of most of the cults, and for the growth of certain religious ideas; nor can we safely date a religious fact by the date of the author who first mentions it: a detail of ritual, a myth, a religious concept attested only by Pausanias or a late scholiast may descend from an age far anterior to the Homeric. And our earliest inscriptions do not as yet reach back to a period earlier than the beginning of the 7th century.

I. THE PRE-HISTORIC PERIOD.—For determining our view of Greek religion in the second millennium B.C., when Hellenism was in the making, the poems of Homer and Hesiod are of priceless value, if they are used with cautious and trained criticism. We depend greatly also on the general inductions of comparative religion and anthropology, which may sometimes guide us rightly in this matter, especially if the anthropological comparison is drawn from the more or less adjacent communities rather than from the Antipodes. We depend also on the evidence of the monuments of the Minoan-Mycenæan religion, revealing glimpses of the practices and faith of a people of high culture, whom no one would dare now to call, at least in the earlier stage of their life, Hellenic, but from whom the earliest Hellenes doubtless adopted much into their own religion.

1. Sketch of Homeric religion.—The poems of Homer present us with an advanced polytheism, a system in which the divinities are already correlated in some sort of hierarchy, and organized as a divine family under a supreme god. These divine beings are not mere *daimones* or *numina*, such as were in the main the old deities of Rome, vague and dimly-outlined forces, animate yet scarcely personal; but rather concrete and individual *theoi* of robust and sharply-defined personality, not spirits but immortal beings of superhuman substance and soul, conceived in the glorified image of man. The anthropomorphic bias is dominant in the poems, plastically shaping the figures of all the divinities, except occasionally some of the lower grade, such as the river-god Skamandros. Even the vague group of nymphs, female *daimones* of the rill and the mountain, while lacking individual characterization, bear the anthropomorphic name, 'Brides' or 'Young Women,' which is the root-meaning of *Νύμφαι*. Though the gods and goddesses

are shape-shifters, and may manifest or disguise themselves in the form of any animal,—birds by choice,—yet their abiding type is human; nor has Homer any clear remembrance of a 'cow-faced' Hera, still less of an 'owl-faced' Athene, since for him at least Hera βοῶπις was Hera 'of the large ox-eyes,' and Athene γλαυκῶπις the goddess 'of the flashing eyes.' And his divinities are moralized beings with human passions, and ethical as well as artistic emotions. The highest among them are not imagined as Nature-powers, bound up with or immanent in the forces and departments of the natural world, for such a description applies only to his wind-gods, and nymphs and gods of river and sea; also, though more loosely, to his Helios, the god of the sun; to beings, in fact, that count little in his religious world. It scarcely applies to Poseidon, though his province is the sea; it does not describe at all his mode of imagining and presenting Apollo, Hera, Athene, Hermes, and others. There is no hint that these divinities were conceived by him as Nature-powers, or as evolved from any part of the natural world. The high god Zeus, though specially responsible for the atmospheric and celestial phenomena, is not identified with the thunder or even with the sky, though a few phrases may reveal the influence of an earlier animistic conception of the divine Sky. His religious world, in short, is morphologically neither a system of polydaimonism nor one of pantheism in which a divine force is regarded as universally immanent in the world of things, but is constructed on the lines of personal theism.

Again, in spite of one or two frivolous and licentious passages, the religious tone is serious, and in many important respects accords with an advanced morality. The deity, though jealous and revengeful of wrongs or slights to himself, is, on the whole, on the side of righteousness and mercy; his displeasure is aroused by those who spurn the voice of prayer, who injure the suppliant, the guest, or even the beggar; and besides Zeus and the other 'Olympians,' who are general guardians of the right, there loom the dark powers of the lower world, who are specially concerned with the sanctity of the oath. Much also of the religious reflexion in the poems strikes us as mature and advanced: notably that passage at the beginning of the *Odyssey* where Zeus declares that it is not the gods who bring evil to men, but that it is the wickedness of their own hearts that is the cause of all their evils.

Finally, the Homeric ritual appears as on the higher level of theism. We can detect in it no trace of savagery, and but little contamination of religion with magic. The sacrifice is more than a mere bribe; it is a friendly communion with the divinity; and the service is solemn and beautiful with hymn and dance. The cult is furnished with altar and occasionally with temple and priesthood, but not yet, as a rule, with the idol, though this is beginning to appear.

This slight sketch of the Homeric theology is presented here in the belief that the Homeric poems enable us to catch some glimmer of the religion of the centuries preceding the first millennium. This belief is based on the conviction that the poems represent a Greek society existing near the date 1000 B.C. It is, of course, opposed to the view still maintained by some scholars that they are—in their finished form—a product of a much later period, and that the religion which they enshrine may be such as was in vogue in Attica about the epoch of Peisistratos. But the evidence of Homeric ethnology and sociology is fatal to this theory, and still more so are the arguments that may be drawn from the history of Greek religion; for, at the period of Peisistratos, certain religious forces

were rife, and certain religious phenomena prominent, about which Homer is entirely silent.

Still less reasonable is it to imagine that Homer constructs a religious world out of his own brain. We must suppose that he reflects something real and contemporary. Only we must guard ourselves against the serious error of supposing that he reflects the whole. Much is, doubtless, missing in his account, which we may be able to supply from Hesiod and other sources by means of reasonable hypotheses.

The assumption is, then, that the Homeric poems present us with a partial picture of the religion that prevailed among some of the leading Greek communities before the Dorian invasion of the Peloponnese and the Ionic colonization of Asia Minor.

2. Pre-Homeric period of religion.—Now, when we consider how slow of growth and enduring are the forms and the moral and metaphysical concepts of religion, we have the right to believe that part of what Homer records on these matters is the inherited tradition of an age some centuries earlier than his own. It is probable that those earliest Aryan immigrants from the north—Achæans, Dryopes, Minyans, and others—who, by mingling with peoples of aboriginal Mediterranean stock and of the Minoan-Mycenæan culture, constituted the happy blend that we call the Hellenic race, had already arrived at the stage of personal theism, and that Hellenic religion proper does not start with a 'godless period,'¹ when the unseen powers were only dimly outlined in the vaguer and more fleeting characters of what is called 'Animism.' We now know, from the valuable discovery of a cuneiform inscription, that the Iranian people had evolved such personal deities as Mithra and Varuna before 1400 B.C.² And we have the right to suppose that their Western kinsfolk, who were forcing their way through the Balkans, perhaps only a century earlier, were at least at the same level of religious imagination. We can best understand the picture of the religious world of Homer, and also the later cult-records, if we believe that the kindred tribes coming from the north brought in certain personal deities, some of whom were common to more than one stock, and one at least may have been common to them all. This would best explain the supremacy of Zeus, the Sky-god, and the diffusion of his name Olympios, derived from the mountain that dominates the northern frontier, near to which the peoples that were to lead the history of Greece had at one time temporary settlements, and which they regarded as the throne of their high god. The wide geographical area of his cult cannot be naturally explained on the assumption that at any period in Hellenic history he had been merely the special deity of one particular tribe. And, as regards two other high gods at least, Apollo and Poseidon, we may be reasonably sure that, already in the pre-Homeric period, certain tribes other than the Achæans had these cult-figures; in the Hyperborean ritual, which reflects at points the earliest days of Hellenism, we can follow the track of Apollo's invasion from the north; and the evidence is fairly clear that Poseidon was equally a northern immigrant, being the special tribal deity of the Minyai.

We must not then apply to the pre-Homeric period of Greek religion the formula 'one tribe, one god,' but must imagine that religion had already surmounted in some degree the tribal barriers; for, though the spirit of tribal exclusiveness was strong throughout the earlier periods of

¹ As Karsten assumes in his *Outlines of Greek Religion*, p. 6.

² See E. Meyer, 'Das erste Auftreten der Arier in der Geschichte,' in *Sitzungsab. d. konig. preuss. Akad. Wissensch.*, Berlin, 1908, p. 14.

this polytheism, certain families and certain tribes having the special prerogative of certain *λεπά* and jealously excluding strangers, yet the fact of the common possession of certain worships by various tribes contained the germ of religious expansiveness. Moreover, at some age indefinitely earlier than the Homeric, the conception of the high god had expanded both cosmically and ethically. Zeus had become more than a 'departmental god': the deity of the sky was also in the first period—so far as we can reconstruct it—Zeus Chthonios, the Lord of the life of earth and of the world under the earth, and it is likely that Hades was only an emanation from him. We may also regard the Homeric appellation of Zeus, *πατήρ ἀνδρῶν τε θεῶν*, as a conventional and crystallized phrase descending from an older poetic tradition, and we are justified in interpreting it as a phrase belonging to the higher plane of theism.¹

We must also suppose that the anthropomorphic view of the personal deity, of which Homer is so attractive a spokesman, had asserted itself in the period before his. Unlike the early Roman, the early Hellenic divinities could be regarded as married, and ideas derived from the life of the family could be applied to them, although we can often discern that many of the myths concerning divine relationships—the sisterhood of Artemis to Apollo, for instance—do not belong to the earliest Hellenic epoch.

3. Minoan-Mycenæan religion.—But any account of the Hellenic polytheism of the second millennium demands a critical study of the Minoan-Mycenæan religion as well, and, before we can decide what part of the Homeric and later systems belongs to the aboriginal Aryan-Hellenic tradition, we must know what the northerners found indigenous in the lands that they conquered or occupied. We know now that they found in many centres a culture superior to their own and a religion of an advanced theistic type with elaborate, though mainly aniconic, ritual, devoted pre-eminently to a great goddess, by whose side a god was only the subordinate partner. It has then been pointed out that, where we find in historic Greece the goddess-cult predominant² and especially the prevalence of a virgin-goddess, we should recognize the Minoan-Mycenæan tradition in antagonism to the Aryan, the latter invariably maintaining the predominance of the god. We may, therefore, believe the cults of Artemis in Arcadia and Attica, of Athene in Attica, of Hera in Argos³ and Samos, to have been inherited from the former rather than to have been brought in by the latter. And sometimes linguistic science will be able to assign the different personalities of the polytheism to its different ethnic strains by determining the group of languages to which the divine name in question belongs. That philology has not yet brought us nearer to the solution of these problems is due to the lacunæ in our knowledge of the pre-Hellenic Mediterranean languages, and especially to our ignorance of the Minoan script, for which we have masses of material but as yet no interpreter. Finally, the evidence of the early geographical area of a certain cult may sometimes be decisive in itself: this is the case in regard to the cults of the 'Mother of the gods' and of Aphrodite, who are aboriginally connected with Crete and Cyprus respectively, i.e. with the centres of the Minoan culture.

But the ethnic decision is at present impossible on a vast number of details in this composite polytheism, in respect both of ritual and of the

¹ See Farnell, *The Higher Aspects of Greek Religion* (Hib. Lect.), London, 1912, p. 93.

² See Farnell, *Greece and Babylon*, Edinburgh, 1911, pp. 95-98.

³ The name Hera is probably Aryan-Hellenic, but applied in Argolis to the pre-Hellenic goddess.

divine personalities; and the student of Hellenic religion must often abandon temporarily the quest of origins in his investigation of the composite whole.

4. Proto-Hellenic period.—The very high development of this Mediterranean civilization from which Hellenism drew so much of its own life is in itself sufficient reason for the belief that the advanced picture that Homer presents of his contemporary polytheism affords us a true estimate of the progress that had been achieved in the centuries before him. And this is corroborated by a careful analysis of the later cult-records.

(1) *Family religion*.—Society in the latter half of the second millennium had already reached the higher agricultural stage and had evolved the monogamic family. Demeter—whose Aryan descent is proved by her name—was generally recognized by the various Hellenic tribes as the Earth-goddess of corn, and the festival of the *Thesmophoria* was commonly associated with her. Certain forms of the religion of the family, which was the life-source of much of the private ethics of later Greece, can be traced back to the earliest period—the worship, for instance, of Zeus 'Ερκεῖος, 'the god of the garth,' around whose altar in the courtyard of the old Aryan house the kinsmen gathered for worship. Another sacred centre of the family life in the pre-Homeric society was doubtless the hearth and the hearthstone in the middle of the hall; there are allusions to its sanctity in the Homeric poems, and the cult-records attest the great antiquity of this religious fact; although the development of the personal goddess Hestia is a later phenomenon (cf. HEARTH [Greek]). The curious Attic rite of the *Amphidromia*, wherein the kinsmen of the new-born child ran with it round the hearth, thereby consecrating it to its holy power, may have descended from a very ancient tradition.¹

Again, the wider kinship-groups of the *φρατρίαι* and *γένη* are obviously pre-Homeric, and doubtless these had been consecrated by aboriginal religion, though we cannot date precisely the emergence of such cult-forms as Zeus Φάτριος and Athene Φατρία.

(2) *Political religion*.—Further, it is fairly clear that already in this first stage the religion had become closely interfused with the higher political and social life. Although the greater part of the population lived still under the tribal system in scattered villages—*κωμηδόν*—yet the *πόλις* had already arisen; and in certain cases we may surmise for it a religious origin, where its name—such as *Ἀθήναι*, *Πορνίαι*, *Ἀλαλκομεναι*, perhaps *Μέγαρα*—is derived from the personal name or the shrine of some divinity. In these cases the temple must have been the nucleus around which grew up the secular habitations; and the deity of the temple would become supreme in the political religion. Athene had won this position at Athens and probably elsewhere in the immemorial pre-Homeric past; and this explains her character in the Homeric poems as the divinity who more than all others inspires political wisdom and counsel. Various indications point, in fact, to the belief that the earliest development of the city-life was closely bound up with the cults of Zeus and Athene; for no other divinity was ever styled *Polieus* or *Polias* by any Greek State; and this agrees mainly with the presentation of them in the Homeric poems. The unanimity of the tradition points back to the second millennium as the period when this political characterization of the two deities was determined. And this view is strikingly confirmed by the records concerning the ritual and the establishment of the cult of Zeus Polieus on the Athenian Akropolis, an institution attributed to Kekrops

¹ See CGS v. 356.

and marking probably the Hellenization of Attica. The singular features of the ritual and the association, preserved in its legend, of Attica with Crete indicate a high antiquity, when agriculture was the economic basis of the political as well as the religious life.

We may believe that other cults besides the two just mentioned played their part in the political growth of the pre-Homeric world. The marketplace, the cradle of political oratory, had become sacred ground, as Homer himself attests; and this consecration was probably marked by the presence of some *ἀγαλμα*, a sacred stone of Hermes, for instance. Apollo, also, had early divested himself of the aboriginal character of the god of the wood and of the homeless migratory host, had become a builder of cities, and had established himself in the city's street with a change in the meaning of his title *Ἄγχιεύς*, once an appellation of the Way-god who guided the host through the wild, now of the deity who guarded the ways of the city; and already, before Homer, his shrine at Pytho was beginning to acquire wealth and political importance as an oracular centre of consultation.

5. Earliest ethical religion.—The theistic system had been turned to good account in other directions than the political, before it appeared on the canvas of Homer. The whole morality of early social life had been nurtured and protected by it; for we may maintain that the ethical religious spirit of Homer—unless we regard him as a man or as a group of men to whom a special revelation had been made—must reflect in some degree a tradition that had grown up in the centuries before him. We see then that current conceptions about the gods had ceased to be inspired merely by fear; a milder sentiment had come to infuse religious thought; the deity was regarded not only as a righteous god of vengeance, but as loving mercy and compassion, and a protector of the weak and destitute. The cult of Zeus *Ζεῦσιος*, the guardian of the stranger and the wanderer, had already arisen; and the sanctity of the oath taken in the name of the deities of the upper and the lower world was the basis of much private and communal morality.

6. Art an aspect of religion.—Other parts of the higher activity of man had been consecrated by the polytheism of which Homer inherits and develops the tradition. The earliest imagination of the Hellenes appears to have perceived a daimonic potency—a *numen*, as we may say—in the arts of song and music, and this had sometimes crystallized into the personal forms of divinities, into such interesting embodiments as the Muses or the Charites, who must have belonged to the pre-Homeric popular theism. The latter group had grown up at the Bœotian Orchomenos, an old centre of the Mycenaean culture. It may be that at one time they had no other than the purely physical significance of vegetation-powers; but we understand their value for Homer only if we suppose that before his time they had come to be associated with the arts and the delight of human life. We discern also that the higher deities, Apollo and Athene, though by no means merely 'functional' or 'departmental' powers, had acquired the special patronage of song and art.

7. Proto-Hellenic ritual.—It seems, then, that even in the earliest period the polytheism was no longer on the most primitive plane; and we gather the same impression from what is revealed to us of the earliest forms of Greek ritual. The Homeric and Hesiodic poems are full of information concerning the liturgy or cult-service with which the poets were familiar; what they tell us then avails for the period of the 11th to the 8th century. But ritual takes long to develop, and, once fixed, is the most abiding element in religion. It is not too

bold then to take the Homeric account as vouching for a tradition that goes back at least to the later centuries of the second millennium. The sacred place of worship might be a natural cave, or a *τέμενος*, a fenced clearing in a grove containing as the *ἀγαλμα* of the deity a tree-trunk or holy pillar or heap of stones, whence gradually an artificial altar might be evolved. The latter had become, some time before Homer, the usual receptacle of sacrifice, and was a prominent feature in the Minoan-Mycenaean religion, which usually associated it with a sacred tree or pillar, the token of the deity's presence or a magnet for attracting it, but not with any iconic statue or idol. Theistic religion could content itself with such equipment, but, if the anthropomorphic instinct is strong in it, it prompts the construction of the temple or the house of God. And temples must have been found in the land in the pre-Homeric period; the few that have as yet been revealed in the area of Minoan-Mycenaean culture were built, with one exception,¹ within the royal palaces, and must be regarded as domestic chapels of the king, marking his sacred character as head of the religion of the State, the character with which the legends invest king Minos and king Aiakos. The earliest that have been excavated on free sites are the temples of Hera at Argos and Olympia, and these are now dated not earlier than the 9th cent. B.C. But the traditions of the earliest temple at Delphi and of that of Athene on the Athenian Akropolis suggest a greater antiquity than this.

With the multiplication of temples special priest-hoods must also have multiplied. But the professional priest had already arisen in pre-Homeric times: Homer knows of the brotherhood called the *Σελλοί*,² who tended the oracular oak of Zeus at Dodona, 'who slept on the ground and never washed their feet'; and he mentions others who were attached to special deities, and two of these at least administered cults without a temple, the priest of Zeus of Mount Ida³ and the priest of the river Skamandros,⁴ of each of whom he says: 'he was honoured like a god among the people.' These words suggest a high and sacrosanct position. Yet these two priests are also warriors fighting in the ranks, which is the mark of a secular priesthood; and there is no legend or any hint of evidence suggesting that a professional priesthood enjoyed a political and social power in the pre-historic, that we know was never achieved by them in the historic, period of Greece. For the evolution of many of the earliest Hellenic institutions evidence is almost wholly lacking. But on general comparative grounds we can surmise that the religious character of the monarchy was most prominent in the earliest times; and that, as its secular power and functions developed, the priest-expert was attached to the *βασιλεύς* to assist in the national cults, over which he retained a general supervision. We have scarcely a hint, either in the earlier or in the later days of Greece, of any conflict between Church and State; we know that at least historic Greece escaped sacerdotalism; and its earliest societies, whatever their danger or their struggles may have been, had escaped it by the days of Homer.⁵ Bearing on this point is the other negative fact that for this earliest age we have little or no evidence of the prevalence of what is called 'shamanism,' divine seizures, ecstatic outbursts of wild prophesying, by which a society can be terrified and captured. The professional *μάντις*, the prophet or soothsayer, existed as distinct from the priest; but his methods generally—so far as

¹ At Gournia (see Hawes, *Crete the Forerunner of Greece*, London, 1909, p. 101 f.).

² *Il.* xvi. 234.

³ *Il.* xvi. 605.

⁴ *Il.* v. 77.

⁵ He is aware, however, that a *θεοῦ δμφή*, an oracular mandate, might be delivered against the royal house (*Od.* iii. 215).

our earliest witness informs us—were cool and quasi-scientific.¹

The ritual at the altar in the early period, with which we are at present dealing, consisted of an oblation to the deity of an animal victim or an offering of fruits and cereals; the sacrifice might be accompanied with wine or might be wineless—a 'sober' sacrifice which was called *νηφάλια*, the latter being perhaps the more ancient tradition. We may interpret the earliest form of Hellenic animal-sacrifice as in some sense a simple tribal or family communion-meal with the deity, whereby the sense of comradeship and clan-feeling between man and god was strengthened and nourished. This is the view that Homer has inherited, and it endures throughout the later history of the ritual; it expresses the general genial temper of Hellenic religion—a trait which Robertson Smith marked as characteristic of other religions of the same social type.² Similarly, the description given us by Theophrastos and Pausanias of the ancient ritual of Zeus Polieus on the Athenian Akropolis reveals to us a typical example of the civic communion feast.³ Such a sacrifice is merely a transference into the divine circle of the practice of the common feast of the tribesmen. But we can also discern a mystic element in the Homeric ritual text, which is evidently based on a tradition indefinitely older than the poems: the sacrificers are specially said 'to taste the entrails' invariably before the real sacred meal begins; as the entrails are the inner seat of the life which has been consecrated by the hallowing contact of the altar, we are justified in supposing that the object of this solemn act was to establish the real and corporeal communion of the worshipper with the divinity.⁴

Chthonian worship.—The important distinction which is well attested of the later ages between the 'chthonian' and the 'Olympian' ritual—to use these two conventional terms for convenience—may already have been in vogue in the earliest period of the polytheism. In the first type of sacrifice, where the offering was made to the nether divinities, the victim's head was held down above a hole in the ground—a *βόθρος*—and the blood from the severed throat was shed into it. In the second, where the upper powers, whose region was the air or the sky, were the recipients, the victim was held up erect off the ground, his face lifted towards the sky, and in this attitude his throat was cut. Homer shows himself aware of this form of sacrifice; and that the other, the chthonian, was also in vogue in his time is to be inferred from his account of the ritual performed by Odysseus in honour of the shades, where he mentions the *βόθρος*, the sacrifice of black sheep, and the triple libation of honey, wine, and water.⁵ For the ritual of the dead in the Greek religious tradition was closely modelled on the service of the nether divinities. The triple libation is known to have been part of Minoan-Cretan cult, as the altar table found in the cave of Mount Dikte attests.⁶ And a shrine with a *βόθρος* in the middle of the cella has been found at Prinia in Crete, consecrated to a chthonian goddess, the foundation of which is ascribed to the 9th century.⁷

From these indications and from the great prevalence attested by later records of chthonian cults in which we can discern features of great antiquity, we can gather that the earliest period of Greek religion was not wholly characterized by

¹ Cf. CGS iv. 190.

² *Rel. Sem.* 2, London, 1894, pp. 236-243.

³ See CGS i. 88-92.

⁴ Cf. Farnell, *Greece and Babylon*, p. 236; also article on 'Sacrificial Communion in Greek Religion,' in *HJ* ii. [1904] 306.

⁵ *Od.* x. 517-520.

⁶ See A. J. Evans, 'Mycenaean Tree and Pillar Cult,' *JHS* xxi. [1901] 191.

⁷ *Arch. Anzeig.*, Berlin, 1909, p. 98.

the brightness of ritual and geniality of religious feeling that appear on the surface of Homeric poetry. Homer himself was aware of the dark world of powers who avenged the broken oath and punished sinners even after death. Long before his time, we may suppose, gloomy worship, such as that of the *θεοὶ Μειλιχιοὶ* described by Pausanias¹ at Myonia in Lokris, of which the rites were performed by night, was in vogue in parts of Greece. Mother Earth, prophesying through phantom-dreams, had held rule at Delphi before Apollo came, and that was long before Homer's work began.²

There are strong reasons also for believing that the cult of hero-ancestors was already a part of the pre-Homeric religion, as it was a prominent part of the post-Homeric. The elaborate tendance of the dead attested of the Mycenaean period by the graves discovered at Tiryns and Mycenae might easily develop into actual worship, when it was maintained through many generations, as it was at Menidi in Attica. Doubtless, the common and promiscuous worship of the dead was a morbid development of the later polytheism. But Homer, who is generally silent about such cults, and, in a well-known passage about the Twin-Brethren,³ seems to ignore deliberately their divine or semi-divine character, almost reveals his knowledge of the worship of Herakles,⁴ and certainly was aware of the Attic cult of Erechtheus, unless the passage that refers to it is the work of an interpolator.⁵

It is a difficult question how we are to estimate and how far we can trust the Homeric evidence on this important point of religion. Even if we trust it so far as to say that the Achæans at least practised no real worship of the dead, it yet remains probable that they found it existing here and there in the lands in which they settled (see HEROES AND HERO-GODS [Gr. and Rom.]).

It is important to emphasize this gloomier side of Greek religion; but it is detrimental to exaggerate it, as has been the tendency of some modern writers in a pardonable revolt against the old shallow theories of orthodox criticism. We have reason to suppose that at no period of his history was the ordinary Hellene ghost-ridden, worried and dismayed by demoniac terrors, or by morbid anxiety about the other world or his destiny after death; at least he will not appear so, when we compare his religious and mythologic records with those of Babylon, Egypt, and Christendom.⁶ Nor dare we affirm that the pre-historic Hellene was weaker-minded and more timorous in such matters than the later. He may even have been stronger-minded, and at least as willing to eat a sacramental meal in company with the *θεοὶ Μειλιχιοὶ* or with the nether-Zeus or the nether-Earth-Mother and with his departed family-spirits as were his descendants at Lokris, Mykonos, and many other places.⁷ The earliest myths have little of the goblin-element. Homer, indeed, himself was cognizant of such forms of terror as a black *κῆρ*—Penelope likens Antinoos to one;⁸ the ancient folklore of Argolis was aware of a bad spirit, called a *Ποιμή*, that once ravaged its homes.⁹ The early popular imagination was sure to have inherited or to have evolved such creations of fear; and a black earth-goddess with a horse's head and snake-locks who lived in a dark cave at Phigaleia, almost certainly in the pre-Homeric period, was a sufficiently terrifying personality.¹⁰

¹ x. 38. 4.

² CGS iv. 180, 193.

³ *Il.* iii. 243; but the poet of the *Nekyia* is well aware of the heroic or divine honours paid them (*Od.* xi. 300-304).

⁴ *Od.* xi. 602.

⁵ *Il.* ii. 546.

⁶ See Farnell, *Gr. and Bab.* p. 206 f.

⁷ See v. Protz, *Leges Græcorum sacræ*, n. 4; cf. *A. J. W.* 1909, pp. 467, 482-485.

⁸ *Od.* xvii. 600.

⁹ Paus. i. 43. 7.

¹⁰ CGS iii. 50-62.

But, happily for the Greek imagination, the divinities of the world of death, abiding below the earth, tended to take on the benign functions of the powers of vegetation. The god of the lower world is scarcely called by the ill-omened name of Hades in cult, but Plouton or Trophonios or Zeus Chthonios—names implying beneficence; for the Homeric and Hesiodic world Demeter is a goddess of blessing, not of terror. And, although in the earliest period certain demoniac personages such as Medusa—identical in form and perhaps in character with the snake-headed, horse-headed Demeter—may have loomed large and terrible in popular cult, afterwards fading wholly from actual worship or surviving in the lower strata of ineffectual folklore, yet the more civilizing imagination had also been operative in the religion of the second millennium. The monuments of the Minoan-Mycenæan religion reveal scarcely an element of terror. And at some period before Homer the kindly deity, Hermes, has assumed the function of the leader of souls. As regards the eschatological views of the pre-historic Greek, we can say little, unless we believe that Homer was his spokesman; and such belief would be very hazardous. The earliest communities may have had no special hopes concerning the departed soul; we have no reason for thinking that the Mysteries which later offered some promise of happiness in the world to come had as yet proclaimed such a doctrine; the earliest form of the Eleusinia may have been that of a secret society organized for agrarian purposes. At any rate, there is no proof that the primitive mind of the Hellene brooded much on the problem of death, or was at all possessed with morbid feeling about it; and in pre-Homeric times he must have been freer from care in this matter than he was in the later centuries, if we accept the view of certain scholars that the elaborate ritual of *κάθαρσις*, or purification, which was mainly dependent on the idea of the impurity of death, ghosts, and bloodshed, was wholly the creation of post-Homeric days.

8. Earliest ritual of purification.—It has even been said that the very idea of the need of purification on special occasions was unknown to Homer. This is demonstrably false. It is enough to mention one passage alone: at the close of the first Book of the *Iliad*, the Achæans, at Agamemnon's bidding, purify themselves from the plague, and throw the infected media of purification into the sea; this is a religious lustration. And, when Hesiod mentions the rule that a man returning from an 'ill-omened' funeral could not without peril attempt to beget a child on that day,¹ he happens to be the first literary witness to the Greek tabu of death; but we may be sure that he is giving us a tradition of indefinite age, and that 'Achæan' society, of which Homer is supposed to be the spokesman, had some of the cathartic rules and superstitions that are found broadcast in later Greece. It may not have elaborated or laid marked stress on them; it may have had no strong sense of the impurity of homicide, nor devised any special code for its expiation. But, if it was entirely without any instinctive feeling for the impurity of birth and death, and for the danger of the *μιασμα* arising from certain acts and states, it was almost unique among the races of man. Only, a progressive people does not overstrain such feelings.

9. Cruder religious conceptions in the earliest period.—So far, the religious phenomena discoverable with some certainty or some probability in the earliest period of Greek history indicate a theistic system of a somewhat advanced type. But doubtless we must reckon with the presence

of much else that was cruder and more savage. When we find in the later records ample evidence of the lower products of the religious imagination—the products of 'animism,' 'fetishism,' theriomorphism, or polydaimonism; more inarticulate and uncouth embodiments of the concept of divinity; or darker and more cruel ritual than that which Homer describes, such as human sacrifice, the driving out of the scapegoat, blood-magic for controlling winds or finding water—no reasonable critic will call all these things post-Homeric because they may not be mentioned in Homer, or suppose that the pure-minded Hellenes were seduced into borrowing them from the Orientals, or that they were spontaneous products of a later degenerate age. The view taken of them by those who have in recent times applied comparative anthropology to the study of Hellenism is the only one that is possible on the whole: these things are a surviving tradition of a mode of religious thought and feeling proper to the aboriginal ancestors of the Hellenic race, or immemorial indigenous products of the soil upon which that race grew up. There is no cataclysm in the religious history of Greece, no violent breach with its past, no destruction of primitive forms at the advent of a higher enlightenment; no fanatic prophet arose, and the protests of philosophy were comparatively gentle and ineffectual. Only a few religious forms of an undeveloped society that might shock a more civilized conscience were gradually abandoned; most of them were tolerated, some in a moribund condition, under a more advanced religion, with which they might be seen to clash if any one cared to reason about them. Therefore a chapter or a statement in Pausanias may really be a record of the pre-Homeric age; and in this way we can supplement the partial picture that has been given above.

10. Animal-gods and animal-worship.—The anthropomorphic principle, which is not necessarily the highest upon which a personal theism could be constructed, is the main force of the higher life of Hellenic polytheism. We may believe that it had begun to work before Homer, but not predominantly or with sufficient effect to produce a stable anthropomorphism in religion. Some worship of animals, which is called 'theriolatry,' some beliefs in the animal-incarnations of the divinity, were certainly in vogue. A few of the more ancient cult-titles would be sufficient evidence, apart from the later records. One of the most significant and oldest is *Λύκειος*, an epithet of Apollo marking his association with wolves. We find also that in many legends, and even occasionally in ritual, the wolf appears as his sacred animal. These facts point back to a period when Apollo was still the hunter-god of the wild wood, and was regarded as occasionally incarnate in the beast of the wild. We have also a few indications of direct reverence being paid to the wolf, apart from its connexion with any god.¹ Another salient example either of theriolatry or of theriomorphic god-cult is snake-worship, proved to have existed in the earliest epoch of the Delphic religion, and in vogue, according to later records, in Epirus and Macedonia. The snake may have been revered in its own right, or as the incarnation of some personal divinity or hero, as we find it later attached to the chthonian deities, to the Earth-Mother, Zeus *Κτήσιος* and *Μεταλχιος*,² Asklepios, and to the buried hero or heroine, such as Erechtheus, Kychreus. We have also reasons for assuming a very early cult of a bear-Artemis in Attica³ and Arcadia; and many other examples of similar phenomena will be found

¹ CGS iv. 112-116.

² See Nilsson, in *Athen. Mitth.*, 1908, p. 279.

³ CGS ii. 434-449.

in a treatise on the subject by De Visser.¹ Later Arcadia was full of the products and of the tradition of this early mode of religious imagination; besides the horse-headed Demeter at Phigaleia, we hear of the worship at the same place of a goddess called Eurynome, represented as half-woman, half-fish; and bronze figures belonging to the Roman period have been found at Lykosoura in Arcadia, apparently representations of divinities partly theriomorphic.²

The first anthropologists who dealt with the primitive forms of Hellenic religion interpreted this special set of phenomena in the light of totemism; but progressive students have now abandoned the totemistic hypothesis on the ground that there is little or no trace of totemism in any Greek or any Aryan society, and that theriolatry, or the direct worship of animals, needs no such explanation. Also, as recently pointed out elsewhere,³ the theriomorphic concept of divinity can, and frequently does, coexist at certain periods and in certain peoples with the anthropomorphic; nor can we say with assurance that in the mental history of our race the former is prior to the latter, or that generally the anthropomorphic was evolved from the animal-god.

II. Functional deities: polydaimonism.—In attempting to penetrate the pre-Homeric past, we have to reckon with another phenomenon, which, though revealed in later records only, has certainly a primitive character, and has been regarded as belonging to an age when the concept of definite complex personalities such as *theoi* had not yet arisen. It was Usener⁴ who first called attention to a large number of local cults of personages unknown to myth or general literature, and designated, not by what are called proper names, such as Hermes, Apollo, Zeus, but by transparent adjectival names, expressing a particular quality or function or activity, to which the essence of the divine power in each case was limited; such, for instance, are *Ἐχετλος*, *Ἐχετλαῖος ἦρως*, *Κναμίτης*, *Εὐροστος*, being nothing more than 'the hero of the ploughshare' at Marathon, the 'hero who makes the beans grow' on the sacred way to Eleusis, 'the hero who gives the good return of corn' at Tanagra; for these he invented the term *Sondergötter*, meaning deities of a single function only; and to those of them to whom only a momentary function, and therefore only a momentary existence, seemed to appertain, he applied the term *Augenblicksgötter*, 'momentary gods'; an example of this type might be *Μυλαγρος*, 'fly-chaser,' in Arcadia and Elis, who at the sacrifice to Athene or Zeus was called upon to chase away the flies that would worry the sacrificers, and who existed only for the purpose and at the time of that call. We may compare also for vagueness and inchoateness of personality certain aggregates of deities having no definite single existence, but grouped by some adjectival functional name, such as *θεοὶ Ἀποτροπῆται*, 'the deities that avert evil,' at Sikyon;⁵ *θεαὶ Γενετυλλίδες*, the goddesses of birth in Attica;⁶ the *θεαὶ Πραξιδικαί*, the goddesses of just requital, at Halimartos.⁷ Such forms seem to hover on the confines of 'polydaimonism,' and to be the products of an embryonic perception of divinity, cruder and dimmer than the robust and bright creations of the Hellenic polytheism, to which so rich a mythology and so manifold a personality attached. Another fact seems to fall into line with these: in some cult-centres the deity, though personally and

anthropomorphically conceived, might only be designated by some vague descriptive title like *ὁ θεός* and *ἡ θεά*, as occasionally at Eleusis; or *Δέσποινα*, 'the Mistress,' the goddess of Arcadia; or *Παρθένος*, 'the Virgin,' on the coast of Caria and in the Chersonese: even as late as the time of Pausanias the men of Boulis in Phokis never called their highest god by any other name than *ὁ Μέγιστος*, 'the Greatest.'¹ And it has been thought that the well-known statement of Herodotus, that the Pelasgians had no names for their divinities, was based on some such facts as these.

The importance of these phenomena would be all the greater if Usener's theory were true, that they represent the crude material out of which much of Greek polytheism has grown.² But in any case they claim mention here, because they are the products of a mental operation or instinct that must have been active in the earliest period of Hellenic religion.

12. Animism or Animatism.—In another set of facts, also attested by later records, we may discern the surviving tradition of an animistic period. A large part of the Hellenic as of other religions reflects man's relation and feeling towards the world of Nature, his dependence on the fruits of the earth, the winds, the waters, and the phenomena of the sky. The trend of the higher polytheism in the Hellenic mind was to set the personal divinity above and outside these things, which he or she directs as an intellectual will-power. But we have sufficient evidence of another point of view, which is that of more primitive religion, from which the deity is imagined as essentially immanent in the thing, not as a distinct personality emerging from it. The Arcadians who worshipped Zeus *Κεραυνός*,³ or 'Zeus Thunder,' at Mantinea, or the people at Gythion in Laconia who called a sacred meteoric stone Zeus *Κακτώρας*,⁴ 'the fallen Zeus,' or the Athenians who worshipped Demeter *Χλόη*, 'Demeter Green Verdure,'⁵ reveal in these strange titles an attitude of mind that is midway between 'Animatism,' that religious perception of each striking thing or phenomenon in Nature as in itself mysteriously alive and divine, and 'Theism,' which imagines it controlled by a personal deity. At the stage when Demeter could be named and perceived as *Χλόη*, 'Verdure,' the anthropomorphic conception of divinity, though certainly existing, was not yet stable.

But there are other cult-facts reported to us of a still cruder type that seem to reveal Animatism pure and simple and the infancy of the Hellenic mind. The Arcadians, always the most conservative and backward among the Hellenes, in their colony of Trapezus 'offered sacrifice to the lightning and thunder and storms';⁶ it seems that for them these things were animate and divine directly, just as the Air—*Bedu*—was for the Macedonians. Again, through all the periods of Hellenic religion, the worship of rivers and springs only at certain points approached the borders of Theism; sometimes offerings were flung directly into the water, and prayer might be made 'into the water'—we must not say 'to the river-god,' but to the divine water.⁷

¹ Paus. x. 37. 3.

² The present writer has criticized this theory of evolution in *Anthropological Essays presented to E. B. Tylor*, Oxford, 1907, 'The Place of the "Sonder-Götter" in Greek Polytheism,' where he has taken the view that some of them are products of the same religious instinct that produces theism or polytheism, and that some appear to be late offshoots of the polytheistic system.

³ BCH, 1878, p. 515.

⁴ Paus. iii. 22. 1.

⁵ *Ib.* i. 22. 3; for other references, see CGS iii. 312, ref. 9.

⁶ Paus. viii. 29. 2.

⁷ *Ib.* 38. 3; *ὁ ἱερεὺς τοῦ Ἀνκαίου Διὸς προσευξάμενος ἐς τὸ ὕδωρ*; cf. Hesiod, *Op.* 737; for the general facts, see CGS v. 420-424. Cf. art. RIVERS AND RIVER-GODS.

¹ *De Graecorum deis non referentibus speciem humanam*, Leyden, 1900.

² BCH, 1899, p. 635.

³ Farnell, *Gr. and Bab.*, pp. 66-80; cf. art. ARYAN RELIGION, vol. ii. p. 38.

⁴ *Götternamen*, Bonn, 1896.

⁵ Paus. ii. 11. 2.

⁶ *Ib.* i. 1. 4.

⁷ *Ib.* ix. 33. 2.

We discern these two different ways of imagining divinity in the worship and ideas attaching to Ἥλιος, 'Sun,' and Ἑστία, 'Hearth.' As regards the former, we have reason to surmise that his religious prestige was higher in the pre-Homeric than in the later age, and that the exalted position as a great political and cultured god which he enjoyed in the later history of Rhodes was a heritage from the Minoan religious tradition.¹ In Homer's poems we find him personal and anthropomorphized; but we may well doubt if he was so for the average Greek, who merely kissed his hand to him every morning, or bowed to him on coming forth from his house, and who, regarding him mainly as animate or 'Living Sun,' found it difficult to develop him into a free and complex individual person.

As regards Hestia the facts are still clearer.² In her worship, which belonged to the aboriginal period of Greek religion, she was at first, and in the main continued to be, nothing more than 'Holy Hearth,' the Hearth felt as animate; nor was the attempt to anthropomorphize her into a free personal goddess ever wholly successful, for reasons that will be considered later (p. 404^a).

13. Magic.—Now, that which is here called 'animatism' is a religious feeling which may inspire real worship, but is more liable than pure theism to be associated with magic; and it is reasonable to believe that magic was in vogue in pre-historic Hellas, not necessarily in antagonism to religion, but practised for purposes of the community as well as for private ends. It is true that the records which tell us about these things are all of a period much later than Homer's, and that he is almost silent about such matters.³ But we know now how to appreciate Homer's silences; and general anthropology compels us to believe that some of those records reveal facts of immemorial antiquity in Greece. The *Thesmophoria*, one of the most ancient of the Hellenic services, was partly magical; that is, it included rites that had a direct efficacy, apart from the appeal to any divinity—such as the strewing of the fields with the decaying remains of the pigs that had been consecrated to the earth-goddesses and thrown down into their vault.⁴ So also in the *Thargelia* of Attica and other Greek communities, the ceremonies connected with the scapegoat and the ritualistic whipping and transference of sin belong to the domain of magic rather than to religion.⁵

We have also direct evidence of a magical dealing with the elements in the titles of officials at Athens called the *Εὐδάεμοι*,⁶ and of those at Corinth called *Ἀνεμοκοῖται*,⁷ both words denoting 'wind-lullers,' 'those who charmed the winds to sleep'; and again in the description of the rite performed by the magicians at Kleonai, who, according to Clement,⁸ 'averted the sky's wrath by incantations and sacrifices'; or in Pausanias' account of the operations of the priest of the winds at Titane in Sikyon,⁹ who endeavoured to assuage their fierceness by 'singing over them the spells that Medea used.' Doubtless these officials were only maintaining the practices of an indefinitely remote past, such as are also reflected in legend of the ancient Salmeus, of Thessalian and possibly Minyan origin, who drove about in a chariot imitating thunder and, while merely practising a well-known type of weather-magic,

¹ See CGS v. 417-420; cf. also art. SUN AND SUN-GODS.

² See CGS v. 345-365; and cf. art. HEARTH (Greek).

³ Agamemnon of Ephyra seems to have practised harmless magic (*Il.* xi. 740); and the poet may have regarded the Elean Ephyra as the special home of magic (see *Od.* ii. 328).

⁴ CGS iii. 85-93; J. E. Harrison, *Prolegomena*, Cambridge, 1903, pp. 120-131.

⁵ CGS iv. 268 ff.

⁶ Hesych. s. v.

⁷ *Il.* 12. 1.

⁸ Arrian, *Anab.* iii. 16. 8.

⁹ *Strom.* p. 755.

was misunderstood by the higher powers and later moralists.

The few records that may avail for an opinion concerning the early period with which we are at present concerned entirely fail to suggest any such prevalence of magic as might obstruct intellectual progress or the growth of a higher religion. They reveal generally a type that is harmless, or even philanthropic.¹ Doubtless some black magic existed in the earliest as in the later Hellas, directed against the life or the property of individuals, and worked by evil means; the more ancient literature is entirely silent about this; but a late record of Pausanias testifies to a barbarous magic practised at Haliartos to discover a water-supply;² a son of one of the chief men was stabbed by his own father; and, as he ran bleeding about the land, springs of water were found where his blood dripped. But at no time, we may judge, was the religion or the intellect of Greece so clouded with magic as was the case elsewhere in the ancient civilizations, notably in Egypt and Mesopotamia.

14. Human sacrifices.—This attempted presentation of the first era of Greek religion must raise the question as to the practice within it of the ritual of human sacrifice. For we are apt to associate this with a primitive society and with a crude or savage religion. But this association is not borne out by the religious history of mankind. The practice has been found in societies highly developed both in morality and in civilization; and the *a priori* argument is dangerous, whether we apply it in one way or the other.

It has been said that the Homeric poems show no consciousness of the existence of the cruel rite in the Greek world of the period; and it has been argued on this ground that the Achæan society of which they are the voice was innocent of it.

A doubt may arise concerning the slaughter of the Trojan captives at the pyre of Patroklos,³ an act of ferocity for which Homer outspokenly blames Achilles. The passage certainly suggests that the poet was aware that such things were occasionally done at contemporary funerals. In Mycænæan tombs at Argos and Mycænæ human remains have been found before the entrance-door, that point to an offering of slaves or captives.⁴ But this need not have been an act of worship or strictly of religion. The dead might be imagined as needing slaves; and to kill slaves to accompany the departed, just as to kill horses over the pyre, may only imply 'tendance,' and no worship of the spirit. But Homer's silence concerning human sacrifice as a rite of religion is of no value as evidence for our present question, as has been argued elsewhere.⁵ How are we to account for the fairly numerous records of actual human sacrifice or of the semblance or reminiscence of it in later Greek worship—records that are found sporadically among most of the leading Greek stocks? The old shift of attributing to Oriental influences everything in Hellenic religion that clashed with our ideal of Hellenism was naively unscientific. That the practice should have sprung up spontaneously and suddenly in the later society, when civic life and morality were advancing, is hard to believe. It is more natural to suppose that it was an immemorial and enduring tradition of the race, which was only with difficulty abolished, and which lingered here and there till the end of paganism. It has been found among many other Aryan races, and it was specially in vogue among the Thracophrygian stock of near kin to the Hellenic. These

¹ In the earliest versions of her legend, the magic of Medea is not black, but benevolent.

² *ix.* 83. 3.

³ *Il.* xxiii. 174.

⁴ See Tsountas, in *Ephem. Archæol.*, 1888, p. 1201.; and Vollgraf, in *BCH.*, 1904, p. 370.

⁵ See Farnell, *Higher Aspects of Gr. Rel.* p. 19 f.

general grounds for believing that it was a feature of the earliest Greek religion are confirmed by some special evidence derivable from the legends and cult-records. It is generally impossible to date the birth of legends; but some can be discerned to belong to an earlier stratum than others: such are the legends concerning the human sacrifice to Zeus Λύκαιος on Mt. Lykaion in Arcadia, to which is attached the story of King Lykaon and the banquet he offers to Zeus on the flesh of his own son;¹ the Achæan or Minyan story of the sacrifice to Zeus Λαφύστιος, 'Zeus the Ravening,' of the king's son of the house of Athamas;² Kyknos' sacrifice of pilgrims and the dedication of their skulls to Apollo on the Hyperborean pilgrims' way at the Achæan Pagasai;³ the sacrifice of a boy and a maiden to Artemis Τρικλαρία by the Ionians on the southern shore of the gulf of Corinth.⁴ A careful study of the legends of these various rites will convince one that they belong to the earliest period of Greek religion. The last example is specially illuminating; the human sacrifice is here practised by the Ionians in their ancient settlements in the land afterwards called Achaia; and its cessation is connected with the arrival of the cult of Dionysos and the return of the heroes from Troy.

The purpose and significance of the rite differed probably in the different cult-centres. In most cases we may interpret it as piacular, the dedication to an offended deity of a valued life, the life of a king's son or daughter, as a substitute for the life of the people, such vicarious sacrifice being a common human institution; in a few cases we may discern an agricultural motive, the blood being shed as a magic charm to secure fertility;⁵ finally, in the ritual of Zeus Lykaios we may detect a cannibal-sacrament, in which the holy flesh of the victim, whose life was mystically one with the god's and the people's, was sacramentally devoured. This ghastly practice is only doubtfully disclosed by legends and by interpretation of later records; a faint reminiscence of it may also have survived in the Argive story of Harpalyke and Klymenos.⁶ But a close parallel to it will be noted in the Thracian Dionysiac ritual.

Summary account of the first period.—A detailed account of the pre-Homeric religious age must at many points remain doubtful and hypothetical; but certain definite and important facts may be established. Anthropomorphism, in a degree not found in the earliest Roman religion, was already prevalent, even dominant, and nearly all the leading personal divinities of the later polytheism had already emerged; only Dionysos had not yet crossed the border from Thrace; Asklepios, dimly known to Homer, was merely the local deity of a small Thessalian community, Pan merely the *daimon* of flocks in remote Arcadia. Cretan religion, also personal in its imagination and mainly anthropomorphic, had left its deep imprint on the mainland; and its divine personalities, such as Rhea, the mother of the gods, and Aphrodite, were soon adopted by the northern immigrants, but not at first into high positions.⁷ The deity was generally imagined, not as a spirit or a vague cosmic force, but as glorified man, and therefore the religion became adaptable to human progress in arts, civilization, and morality. But much in the animal world still appeared sacred and weird; and the deity might be at times incarnate in animal form. At the same time the religious imagination was

¹ See CGS I. 40-42.

² *Ib.* iv. 272; schol. *Pind. Ol.* x. 19.

³ *Paus.* vii. 19. 1-9.

⁴ *e.g.* CGS iii. 93.

⁵ *Ib.* 42.

⁶ *Ib.* 22.

⁷ Homer's prejudice against Artemis and Aphrodite may reflect the feelings of the northerners towards those Mediterranean deities whose cult they had not yet wholly absorbed.

still partly free from the bias of personal theism, and produced vaguer divine forms, of some force and power, but belonging rather to 'animatism' or polydaimonism than to polytheism.

Finally, a study of all the facts and probabilities may convince a careful student that the origin of Greek polytheism as a whole from simpler forms cannot be found in this earliest period. In the second millennium, which is the starting-point for Hellenic history proper, we cannot discern the 'making of a god' (unless we mean the building-up of his more complex character), nor do we start with a godless period. We may well believe that in the history of mankind theism was evolved from animism or polydaimonism; we may believe the much more doubtful theory that anthropomorphism arose from a previous theriomorphism; and there may still be some who are convinced that theriomorphism implies a totemistic society. But, at any rate, these evolutions had already happened indefinitely before the two strains, the Northern and the Mediterranean, had blended into the Hellenic race. The higher and the lower, the more complex and the simpler, forms of religious imagination operate together throughout Hellenic history; and the higher, though dominant, never wholly absorbs the lower, both being an intellectual tradition of an indefinite past. Much work on the origins of Greek religion has been wasted because its chronology is anachronistic; and the attempt to unlock many of its mysteries by the key of totemism has been abandoned by those who recognize that many of the views concerning this social phenomenon and its religious importance, prevalent in a former generation, were erroneous.

We can now pursue the inquiry nearer the border-line of the historic period, as it is conventionally termed.

Introduction of worship of Dionysos.—As early as the 10th cent. B.C., and probably earlier, a new religion with a new and imposing divinity was intruding itself into the Hellenic lands from Thrace and Macedonia.¹ Dionysos and the Thracian ritual-legend of Lykourgos are known to Homer; but the poems suggest that he was not yet definitely received into the Hellenic pantheon. Yet there are reasons for believing that Bœotia had received the alien worship in the 'Minyan' epoch, before the incoming of the 'Boiotoi'; and Attica before the Ionic emigration; while in the Peloponnese the Argive legend associates the advent of the god with the names of Perseus and the Proetid dynasty. In spite of local opposition and its natural antagonism to the nascent spirit of Hellenism, which was now tending to express itself in certain definite and orderly forms of mood, thought, and feeling, the new religion won its way victoriously, taking Thebes for its Hellenic metropolis, and some time afterwards securing its position at Delphi, where the priesthood and the Apolline oracle became its eager champions. It was distinguished from the traditional Hellenic in regard to its idea of divine personality, its ritual, and its psychic influence, that is to say, the mood that is evoked in the votary. In the first place, the figure of Dionysos belonged indeed to personal theism, certainly in Hellenic cult and probably in the Thracian; but he was less sharply defined as a concrete individual than was, for instance, Apollo or Athene; he was vaguer in outline, a changeful power conceived more in accordance with daimonistic, later with pantheistic, thought, incarnate in many animal-shapes, and operative in the life-processes of the vegetative world; and an atmosphere of Nature-magic accompanied him.

¹ See CGS v. 86-118; cf. generally chs. iv. and v.

The central motives of this oldest form of ritual were the birth and death of the god—a conception pregnant of ideas that were to develop in the religious future, but alien to the ordinary Hellenic theology, though probably not unfamiliar to the earlier Cretan-Mycenaean creed. But the death of this god was partly a fact of ritual; he was torn to pieces by his mad worshippers and devoured sacramentally, for the bull or the goat or the boy that they rent and devoured was supposed to be his temporary incarnation, so that by this savage, and at times cannibalistic, communion they were filled with his blood and his spirit, and acquired miraculous powers. By such an act, and—we may suppose—by the occasional use of intoxicants and other nervous stimulants, the psychic condition that this worship evoked was frenzy and ecstasy, which might show itself in a wild outburst of mental and physical force, and which wrought up the enthusiastic feeling of self-abandonment, whereby the worshipper escaped the limits of his own nature and achieved a temporary sense of identity with the god, which might avail him even after death. This privilege of ecstasy might be used for the practical purposes of vegetation-magic, yet was desired and proclaimed for its own sake as a more intense mood of life. This religion preached no morality, and could ill adapt itself to civic life; its ideal was supernormal psychic energy. The process whereby it was half-captured and half-tamed by the young Hellenic spirit forms one of the most interesting chapters in Hellenism.

II. *SECOND PERIOD: 900-500 B.C.*—It is convenient for the purposes of religious study to mark off the period between the 9th cent. and the 6th as the second period of Greek religion, in which we can observe the working of new forces and the development of older germs into new life. By the beginning of this period the fusion of the Northerners and the Mediterranean population was mainly complete, and the Hellenic spirit had acquired its definite instincts and bias. The 9th and 8th centuries witnessed the diffusion of epic literature, the rise of lyric poetry, the emergence of the *εἰκῶν*, or idol, in religious art, and, generally, the development of cities and civic life; and it is essential to estimate the religious influence of these forces.

I. *Influence of epic and lyric poetry.*—That the contribution of Homeric and of the later Hesiodic literature to the shaping and fixing of Hellenic religion was most fruitful and effective cannot be doubted. Only, we must not accept the exaggerating view of Herodotus¹ that these two poets were really the founders of the anthropomorphic religion, creating the orthodox Hellenic theogony, and determining the names and functions and shapes of the special divinities. By such a statement some scholars have been misled into regarding the Homeric poems as a kind of Greek Bible, which in respect of religious matters it might be heresy to disbelieve. We know that local temple-legend and local folklore could always maintain their independence of Homeric or Hesiodic authority, in respect of the titles of the gods, their relationships, and genealogies: Artemis was not everywhere reputed to have the same parentage or Zeus the same spouse. The early epic poets gathered many of the *ἱεραὶ λόγῳ* of shrines, but there was much that they did not gather, and which survived. There was a noticeable particularism in Greek theology, and no orthodoxy and no heterodoxy in the sense that it was moral to believe or immoral to disbelieve any sacred book.

The chief religious achievement of Homer and his fellows was to intensify the anthropomorphic trend in Greek religion, to sharpen and indi-

vidualize the concepts of divinity, and to diffuse throughout the Hellenic world a certain uniformity of religious imagination. To their work partly, as well as to the higher synthetic power of the Greek mind, we may ascribe the fact that, in spite of local varieties of myth and cult-titles, in spite of the various elements that the divine personality may have absorbed from earlier cult-figures and cult-forms in the various cult-centres, the sense of the individual unity of person was not lost so long as the same name was in vogue; hence Apollo Lykeios of Argos could not be a different person from the Apollo Patroös of Athens, nor could hostility arise between them. That is to say, the higher religious literature imprinted a certain precision and definiteness upon the personal names of the leading divinities and endowed them with a certain essential connotation; for example, the dogma of the virginity of Athene and Artemis, always presented in the highest poetry, prevailed so far as to suppress the maternal character that may have attached to them in the pre-historic period, and of which we can still discern a glimmering in certain local cults.² To this task of shaping the divine characters the rising lyric poetry, which was growing up with the decay of the Epic, and which, in obedience to the Hellenic passion for disciplined form, was developing fixed types of song and music appropriate to special festivals and worships, must have contributed much. The 'spondaic' metre was adapted to the invocation or hymn sung at the libation—the *σπονδή*—to Zeus; and the solemn gravity of the spondaic fragment attributed to Terpander fittingly expresses the majesty of the high god, 'the primal cause of all things, the Leader of the world.'³ The pæan and the *nomos* became instinct with the Apolline, the *dithyrambos* with the Dionysiac spirit.⁴ The earlier Greek lyric was, in fact, mainly religious, being composed for public or private occasions of worship; its vogue was therefore wide, and in some communities, as in Arcadia, the singing of these compositions formed part of the national training of the young.⁴

2. *Idolatry.*—Another phenomenon of importance at the beginning of this second period is the rise of idolatry, the prevalence of the use of the *εἰκῶν* in actual worship in place of the older aniconic *ἄγαλμα*, which had sufficed for the Minoan and the Homeric world as a token of the divine presence or as a magnet attracting it to the worshipper. This important change in the object of cult may have been beginning in the 10th cent., for we have one indication of it in the Homeric poems, and recently on one of a series of vases of the early geometric style found in a grave of the post-Minoan period near Knossos, the figures of an armed god and goddess are depicted on low bases, evidently idols, and perhaps the earliest of any Hellenic divinity.⁵ Henceforth, although the old fetish-object, the aniconic *agalma*, lingered long in certain shrines and holy places, the impulse towards idolatry became imperious and almost universal, exercising a mighty influence on the religious sentiment of the Hellenes both before and after the triumph of Christianity. The worship before the idol intensified the already powerful anthropomorphic instinct of the polytheism, and was at once a source of strength and a cause of narrowness. It brought to the people a strong conviction of the real presence of the concrete individual divinity; as it gave its mandate to the greatest art of the world, it evolved the ideal of divinity as the ideal of humanity, expressible in

¹ See *CGS* ii. 442-449.

² Bergk, *Poetae Lyrici Graeci*, Leipzig, 1843, vol. iii. fr. 1.

³ Philochoros, frag. 21; Müller, *FGH* i. 387.

⁴ Athenæus, p. 626 B.

⁵ See *Arch. Anzeig.*, 1908, p. 122.

forms of beauty, strength, and majesty. On the other hand, it was a force working against the development of a more mystic, more immaterial religion, or of a consciousness of godhead as an all-pervading spirit, such as might arise out of the vaguer religious perception of those half-personal *daimones* or *numina*, which never wholly faded from the popular creed.

3. Progress of anthropomorphism.—It is interesting to mark within this second period the various effects of the now regnant anthropomorphism. Those functional *daimones* tend to leave the amorphous twilight of religious perception, in which the Roman *indigitamenta* remained, and to be attracted into the stronger life of personal theism. *Κουροτρόφος*, once perhaps only a vague functional power that nurtured children, becomes identified with Artemis or Gē; *Χλόη*, 'Divine Verdure,' when the cult was introduced from the Marathonian Tetrapolis to the Akropolis of Athens—if this, indeed, is a true account of its career—could maintain herself only as *Δημήτηρ Χλόη*. Again, the name *Ἡρως* comes to be applied to even the most shadowy of these functional powers, to *Μυλαγρος*, 'the Fly-chaser,' the most limited and momentary of them all; to *Εὐροστος*, the *daimon* of good harvest, about whom a very human tale is told; and to call them *Ἡρως* implies that they were imagined as semi-divine men who once lived on the earth. Even the most immaterial forces, some of those which mark mental phases or social conditions, such as *Ἔρως*, Love, *Φιλία*, Friendship, *Εἰρήνη*, Peace, became often for the religious imagination personal individuals with human relationships;¹ thus *Εἰρήνη* emerges almost as a real goddess with the traits of Demeter, *Φιλία* on a relief in the Jacobsen collection is individualized as the mother of Zeus Philios, in defiance of the traditional theogony.² Others such as *Αἰδώς*, 'Reverence' or 'Compassion,' remained in the border-land between animating forces and personal deities.

But we observe in many cases that the name itself was an obstacle to the emergence of a convincingly personal god or goddess; and, where this is the case, the personality never could play a leading part in the advanced religion. Thus *Ἑστία* bore a name that denoted nothing more than 'the Hearth,' considered as animate and holy; Greek anthropomorphism did its utmost for her, but never or rarely succeeded in establishing her as a fully formed personal goddess. The same phenomenon is observable in regard to Gē, Helios, and Selene; it was easy to regard them as animate powers, and as such to worship them; such worship they received throughout all periods of Greek religion, but they exercised no direction of the moral, social, and spiritual progress of the race; for their names so obviously connoted substances unlike and alien to man that they could not with conviction be imagined as glorified men or women.³ It was otherwise with such names as Apollo, Hera, Athene, which could become as real and individual as Miltiades or Themistocles; and it is these humanized personalities that alone dominate the higher religion of Greece. The spiritual career of Demeter began only when men forgot the original meaning of her name and half forgot that she was only Mother Earth. The *Ἄνεμοι*, being mere 'Winds,' were scarcely fitted for civic life; but Boreas, having a personal name, could become a citizen and was actually worshipped as *Πολίτης*, 'the Citizen,' at Thourioi.⁴ A curious and unscientific distinction that Aristophanes makes

¹ CGS v. 443-447.

² See Furtwängler, in *SMA*, 1897, l. 401; Nilsson, in *Athen. Mittheil.*, 1908, p. 234.

³ The striking exception to this rule is the great cult of Helios at Rhodes (see above, p. 401a).

⁴ *Æl. Var. Hist.* xii. 61.

between the religions of the Hellenes and the Barbarians¹ has its justification from this point of view.

4. Influence of the 'Polis' on religion.—The spirit of the *Polis*, the dominant influence in Greek religion throughout this second period, worked in the same direction as the anthropomorphic instinct, giving complexity, varied individuality, and an ever-growing social value to the idea of godhead. The deities of the wild enter the ring-wall of the city, and shed much of their wild character. Apollo Lykeios, the wolf-god, enters Argos and becomes the political leader of the State, in whose temple a perpetual fire was maintained, symbol of the perpetual life of the community.² And the advanced civic imagination tended to transform the primitive theriolatry or theriomorphic ideas that still survived. Proofs of direct animal-worship in the later period are very rare and generally doubtful; for the ancient writers employ the term 'worship' carelessly, applying it to any trivial act of reverential treatment.³ In the few cases where we can still discern the animal receiving cult, we find the anomaly explained away by some association established between the animal and the anthropomorphic deity or hero. Thus the wolf became no longer sacred in its own right—if, indeed, it ever was—but might be revered here and there as the occasional incarnation of Apollo, or as his guide or companion. The primitive population of the Troad may once have 'worshipped' the field-mouse, though the authority that attests it is a late and doubtful one. And when Apollo becomes in this region the civic guardian of the Æolians and the protector of their crops, he takes a title from the mouse [*Σμυθεός* from *σμυθος*], and the mouse is carved at the side of the anthropomorphic image as a propitiatory hint to the rest of the species not to injure the corn, or as a hint to the god that mice needed regulating.⁴ The serpent worshipped in the cavern, or in some hole or corner of the house—vaguely, in 'Aryan' times as the Earth-*daimon* or House-genius⁵—became interpreted as the embodiment of the ancestor Erechtheus of Athens, or Kychreus of Salamis, or Zeus *Κτήσιος*, the guardian of the household possessions, or Zeus *Μειλιχίος*, the nether god. When the very human Asklepios came to Athens towards the end of the 5th cent., he brought with him certain dogs who were ministers of healing; and the Athenians offered sacrificial cakes both to the god and to his dogs, which partook of his sanctity.⁶ This may appear a strange imbecility; but at all events we discern in these facts the prevalent anthropomorphism dominating and transforming what it could not abolish of the old theriolatry; just as we see the coin-artist of Phigaleia transforming the uncouth type of the horse-headed Demeter into a beautiful human form of a goddess wearing a necklace with a horse-hoof as its pendant. The sacred animal never wholly died out of Hellas; but it could maintain its worship only by entering the service of the human gods.

The expansion of the civic system in this second period, due to extended colonization and commerce, induced a development of law and an expansion of moral and religious ideas. One of the most vital results of the institution of the *Polis* was the widening of the idea of kinship. For in theory the city was a congregation of kinsmen, a combination of tribes, phratries, and families,

¹ 'They worship Sun and Moon, we worship real Gods such as Apollo and Hermes' (*Paz*, 410).

² Schol. Soph. *Elec.* 6.

³ See Farnell, *Gr. and Bab.* pp. 77-80.

⁴ See CGS iv. 163-166.

⁵ See SERPENTS AND SERPENT-WORSHIP.

⁶ Protz-Ziehen, *Leg. Sacr.* n. 18.

wider or narrower associations, framed on a kin-basis; and it gradually evolved the belief, pregnant of legal and moral developments, that every citizen was of kin to every other.

In consonance with the conception of the State as an extended family, we find certain ancient family-cults taken over by the religion of the *Polis*. As the private family was knit together by the worship of the hearth in the hall and of Zeus 'Ερκεῖος, 'the god of the garth,' in the courtyard of the house, so the city had its common Hestia, or Holy Hearth, upon which often a perpetual fire was maintained in its *prytaneum*, or common hall; and the cult of Zeus 'Ερκεῖος was established in ancient days on the Akropolis of Athens. The great divinities of the State, Zeus, Hera, Aphrodite, and—perhaps later—Demeter, consecrate and regulate the monogamic rite of marriage, in which the *Polis* was directly interested. The organization of the 'phratries' was also consecrated to the high deities, Zeus, Athene, and, among some Ionic communities, Aphrodite; and the decisions of the *φράτρες*, or 'brothers,' on questions of adoption and legitimacy of citizens were delivered from the altar of Zeus *Φράτριος*; while the union of the local districts, or 'demes,' was sanctified by the cult of Zeus or Aphrodite *Πάνδημος*, the god or goddess of 'all the demes.' The *Polis* also organized and maintained the kindred festivals of commemoration proper to the family, or gens, or phratría—the All-Souls celebration of the dead which was held at the end of the *Ἀνθεστήρια*; the *γενέσια*, the funeral feasts of the *γένη*; the *Ἀπατούρια*, the joint festival of the phratries; while the great achievement of the consolidation of the scattered groups into the single city was celebrated at Athens by the festival of the *Συνοικέσια*, the 'union of all the houses,' and the *Παναθήναια*, the all-Attic feast of Athene.

The picture that these facts present of a State-religion based on the idea of the family and of kinship is mainly drawn from Athens, of which the religious record is always the richest; but it reflects undoubtedly the system of the other Hellenic States as well. Many of their records attest the belief that some one of the high divinities was the ancestor or ancestress of the whole people, and this ancestry was generally understood in the physical and literal sense. Thus Apollo *Πατρῶος* was the divine ancestor, being the father of Ion, of the Ionic population of Attica; and even the non-Ionic stock desired for political purposes to affiliate themselves to this god.¹ In the same sense he was called *Γενέτωρ*, 'the Father,' in Delos.² Zeus was the father of Arkas, the eponymous hero of the Arcadians, and was worshipped as *Πατρῶος* at Tegea;³ Hermes also was ancestral god of part of the Arcadian land, and identified with the ancestor *Αἰπυτός*.⁴ These religious fictions came to exert an important influence on morality, and also to develop a certain spiritual significance, which will be considered later.

5. Hero-cult.—This aspect of the public religion is further emphasized by the prevailing custom, which appears to have gathered strength in this second period, of worshipping the hero or the mortal ancestor of the State, or the tribe, or the clan. The first clear evidence of this in literature is in the poem of Arktinos of Miletos called the *Aithiopsis*, which may belong to the end of the 8th cent. B.C., and in which the apotheosis of Achilles is described. But there is, as has been said, strong reason for believing that the practice of 'heroizing' the dead descended from the pre-Homeric age.

¹ Plat. *Euthyd.* 302 C; Demosth. xviii. 141, lvii. 54, 67; Arist. *Ath. Polit.* 55.

² Diog. Laert. viii. 1. 13; Macrob. iii. 6. 2.

³ *BCH*, 1893, p. 24.

⁴ Paus. viii. 47. 4.

Nevertheless, of the multitude of hero- and ancestor-cults recorded in ancient Hellas, the greater number are probably post-Homeric. We find the Delphic oracle giving vigorous encouragement to the institution of them, and in the 6th cent. B.C. cities begin to negotiate and dispute about the possession of the relics of heroes. Some of these in the older cults may have been actual living men dimly remembered; some were fictitious ancestors, like Arkas and Lakedaimon; some may have been faded deities, such as were Eubouleus at Eleusis and Trophonios at Lebadeia. But all were imagined by the worshipper to have been once men or women living upon the earth. This, then, becomes a fact of importance for the religious thought of the world, for it engenders, or at least encourages, the belief that human beings might through exceptional merit be exalted after death to a condition of blessed immortality, not as mere spirits, but as beings with glorified body and soul. Furthermore, certain ancient heroes, long endeared to the people as the primeval parent or the war-leader of their forefathers, become raised to the position of the high god and merged in his being; Erechtheus shares the altar and even the title of Poseidon and Zeus; Aipytos of Arcadia becomes Hermes; Agamemnon in Laconia at last is fused with Zeus.¹

Nor in this second period were such heroic honours reserved for the remote ancestor or the great king or warrior of old, but were sometimes paid to the recently dead, to the men who had served the State well by arms or by counsel. On the assumption that Lykourgos of Sparta was a real man—and any other theory of him is less natural—his case is the earliest recorded instance of the heroizing of a historical personage. A great stimulus about this time was given to this practice by the expansion of Greek colonization, the greatest world-event of the period, which reacted in many ways on religion. As the new colonists could not take with them the tomb or the bones of the aboriginal hero of their stock, they must institute a new hero-cult, so as to bind the new citizens together by the tie of heroic kinship. The most natural person to select for this high honour was the founder or leader of the colony, the *κτίστης* or *ἀρχηγέτης* as he was called, and we may regard it as the usual rule that, when he died, he would be buried within the city, and his tomb would become a *ἥρωον*, and would be visited yearly with annual offerings.

That the ordinary head of the private household in this period received posthumous honours amounting to actual worship cannot be definitely proved. The tendance of the dead had become, indeed, a matter of religion, and at Athens was attached to the ritual of the State by the commemorative feast of All Souls, the *Χύρποι*, or 'Feast of Pots,' the last day of the *Antheateria*. But nothing that is recorded of this ghost-ceremony convicts it of actual worship; the ghosts are invited to spend the day with the household that holds them in affection, they are offered pots of porridge, and then at sunset are requested to depart. Prayers are proffered in their behalf to the powers of death, but not directly to the ghosts themselves; no cult is offered them as to superior beings endowed with supernatural power over the lives of individuals and States.² Nevertheless, the passionate service of lamentation and the extravagant dedication of gifts which marked the funeral ceremonies of the 8th and 7th centuries, and which certain early legislation was framed to check, reveal a feeling about the dead

¹ The other view, still held by some, that Zeus-Agamemnon is the earlier fact and Agamemnon the hero the later, does not bear criticism.

² See CGS v. 219-221; J. E. Harrison, *Prolegomena*, ch. II.

bordering on veneration, and such as might inspire actual worship.

We may safely assume that the growing interest of the States in hero-cult intensified the family aspect of the State-religion; the hero as the glorious kinsman is invited to the sacrifices of the higher deities, and to the *θεοξένια* in which the god himself is the host.

It is important for the student of religion to mark the consequences of this close association of the civic religion with the idea of kinship that held together the family and tribe. These have been estimated more at length elsewhere;¹ and only a few general observations are possible here. Where a family-bond exists between the deity and the city, the spirit of genial fellowship is likely to prevail in the ritual and religious emotions, and the family meal might become the type of the public sacrificial meal with the god. Such a religion is adverse to proselytism; for, as it is the sacred prerogative of certain kindred stocks, its principle means the exclusion of the stranger. Its religious and moral feeling is naturally clannish; the whole group must share in the moral guilt of the individual, and the sins of the fathers will be visited on the children. It affords a keen stimulus to local patriotism, and quickens an ardent life within the wall of the city; it has at the same time the natural defects of narrowness of view. Yet, in the course of religious evolution, we must regard the old Hellenic conception of the god, the Father of the tribe or the city, as pregnant of the larger idea of God the Father of mankind—an idea which had already dawned upon Homer at a time when the tribal spirit of religion was still at its height.

A further result of such a system is that the State-divinities become also the patrons and guardians of the family morality, Zeus and Hera, for instance, being the supervisors of human marriage and of the duties of married life; and copious records present the High God as the protector of the father's right, of the tie that binds together the brethren, the sisters, the kinsmen. While such a religion was a living force, it was not likely that the family could assert itself as against the State; to marry healthfully and early, to beget vigorous children as defenders of the State and the family graves, to cherish and honour one's parents, to protect the orphan—these were patriotic religious duties inspired by the developed State-religion, and strenuously preached by the best ethical teachers of Greece. The State being the family writ large, private and public morality could not clash. The brutal action of Kreon in the *Antigone* is equally an attack on the religion of the State and on that of the family; and it was not till the 5th cent. that the question could be asked whether the good man was really the same as the good citizen.

6. Influence of advanced religion on law.—Of still greater interest is an important advance in criminal law, discernible as early as the 8th cent., which may be traced partly to the growth of the city, with its extended idea of kinship, partly to the growing intensity of the belief in the power and significance of the spirits of the dead.

In the most primitive period of Hellas, the shedding of a kinsman's blood was already a heinous sin; but the slaying of one outside the kindred circle was ordinarily neither a sin against God nor a social crime. But, as the public mind of Greece became penetrated with the feeling that all the citizens of the *Polis* were in some sense akin, the slaying of a citizen became a criminal act of which the State, and no longer merely the clan of the slain man, would take cognizance. This expanded concept of law is reflected in the expansion of an

¹ See Farnell, *Higher Aspects of Gr. Rel.*, pp. 73-91.

ancient and most significant cult, the cult of Zeus Meilichios.¹ This was the underworld god, who was angered and must be appeased when kindred blood was shed; as the idea of kinship was enlarged, any civic massacre might arouse his wrath, and rites of atonement might be offered to him. This keener sensitiveness concerning the sanctity of human life was accompanied by a feeling that bloodshed might imprint a stain on the slayer that rendered him ritualistically unclean, that is, temporarily unfit to approach the gods or men; it was also fortified by the growing fear of the ghost-world, which seems to have lain more heavily on the post-Homeric society than on Homer's men. It is hard to give the dates for this section of the mental history of Hellas. The first record of the thought, which is nowhere explicit in Homer, that homicide in certain circumstances demands purification, is derived from the *Aithiopsis* of Arktinos, the epic poet of Miletos in the 8th century.² Achilles, having slain the worthless Thersites, must retire from the army for a while to be purified in Lesbos by Apollo and Artemis. We mark here that the slain man was no kinsman of the slayer in any true sense of the word, but was a member of the same Achæan community, and therefore his slaying brought a religious impurity upon the hero; and we may believe that the narrative reveals the early religious law of Miletos. But, in passing, we must recognize the possibility that these apparently new manifestations may be only a revival of immemorial thought and feeling, common in the older non-Hellenic societies, and only for a time suspended.³

7. Influence of Delphi and Crete.—In this post-Homeric development of a system of purification from bloodshed, the legends suggest that Crete and Delphi played a momentous part. In the great island, the cradle of European culture, the cult of Zeus had early attached to itself certain cathartic ideas, probably of Dionysiac origin. And probably in the pre-Homeric period the influence of Crete had reached Delphi; while the legend of the migration of Apollo Delphinios from Crete to Delphi, and the story that the god himself must go to this island to be purified from the blood of Python, belong to the second period with which we are dealing.

We have reason to believe that the Delphic god—through the agency of his politic priesthood—was asserting his claim in the 8th and 7th centuries B.C. to be the dictator in the matter of purification from homicide, and thus to satisfy the cravings of an awakening conscience. This claim may have been suggested partly by the fear of competition with the spreading Dionysiac religion, which also brought with it a 'cathartic' message, and with which the Delphic priesthood were wise enough to agree quickly; partly also by the aboriginal nature of Apollo who was immemorially *Φοῖβος*, or 'pure.' Though the claim was not universally admitted and the Apolline jurisdiction could not obliterate the function of other divinities in this matter, yet it was powerful and effective of much that was vital both to law and to religion. Of the early procedure at Delphi we know nothing. If the god exercised discretion in his grant of purification, if he refused, for instance, to purify the deliberate and cold-blooded murderer, here was the opportunity for the emergence of a civilized law of homicide. It may not have been till the 7th cent. that any Hellenic State could express in a legal establishment its consciousness of the difference between the act of murder and the act of justifiable

¹ See CGS I. 64-69; for the religious evolution of the Greek laws concerning homicide, see Farnell, *Evolution of Religion*, pp. 139-152, CGS IV. 295-306.

² *Epic. Græc. Frag.*, ed. Kinkel, Leipzig, 1877, p. 22.

³ CGS IV. 299.

or accidental homicide. The earliest that we know of was the law-court *ἐπι Δελφῶν* established at Athens under the patronage of the Cretan-Delphic god to try cases where homicide was admitted and justification was pleaded. In this as in other Attic courts that dealt with the same offence, rites of purification were often an essential adjunct of the ceremony. The typical legend that enshrines the early ideas of *κάθαρσις* and turns on the question of justifiable homicide is the story of Orestes, which had spread around the Peloponnese and penetrated Attica as early as the 8th cent. B.C., and later became Pan-Hellenic. Apollo as a divine agent appears in it first, as far as we have any literary record, in the lyric of Stesichoros, and at some indeterminate date in this period undertook the purification of the matricide.

These cathartic functions and the general demand for their exercise must have greatly enhanced the influence of Delphi in the earlier part of the post-Homeric period. It was doubtless strengthened even more by the great secular movement of Greek colonization. With wise foresight the god had undertaken the guidance and encouragement of this already in the earliest days when the Hellenes were pushing across the sea; for it seems as if the first Greek settlements on the Asia Minor coast, the Lycian and the Æolic, were due to his leadership, if not to his inspiration. The legends that associate him with the Dorian migration into the Peloponnese are too powerful to be rejected. And after this event, when light begins to shine on Greek history, and the Hellenic race was rapidly establishing that chain of colonies across and around the Mediterranean which were to diffuse Greek culture through the world, the power of Delphi and the Delphic oracle reached its zenith. For it is clear that it was the prevailing fashion to consult the Pythian Apollo as to the choice of a site. Hence it came about that in so many Greek cities Apollo was worshipped as *Ἀρχηγέτης*, that is, as the divine founder, and that the flourishing communities of the West sent tithe-offerings to his shrine.¹ Was it by some accident or by something essential in his early cult and character that the god was able to play this momentous political part, such as no other deity has ever played in the secular history of his people? The cause may lie far back in the dim antiquity of the Apolline cult, when he was specially *Ἄγυιεύς*, a god 'of the road,' the leader of the migratory host. And in pre-Homeric times, if not aboriginally, he was already an oracular god; nor was any occasion so urgent for a consultation of the local oracle as when the people were setting forth on their perilous path to find a new home.²

The Delphic oracle.—The spiritual history of the Hellenic race in the early historic period, when we mark a growing consciousness of nationality and of kinship in the various stocks, is very much a record of the career and activity of the Delphic oracle; and this is too complex and lengthy a theme to be more than adumbrated here.³ Due partly to the local position and the immemorial sanctity of the oracle, partly to the devotion and the grateful remembrance of the powerful Dorian States in the Peloponnese, the Pythian worship came to overshadow the Delian, and provided the chief religious centre and the strongest bond of spiritual unity in the Hellenic world. For political unity it could do little, owing to the centrifugal bias of Greek politics; yet the Delphic Amphiktyony, the most powerful of those religious confederations that are recorded here and there in the early history of Greece, contained within it the germs of intertribal morality and concord. Its

members were not indeed pledged to perpetual amity, but at least to a certain mutual forbearance even in their warlike dealings with one another. But the chief regulative functions of the oracle were concerned with questions of the institution and administration of cults, with the domains of legislation, colonization, public and even private morality and conduct. In the sphere of religion, it doubtless emphasized the necessity of purification from bloodshed; otherwise it had no high religious message to deliver; but it was enthusiastic for the propagation of the cult of Dionysos, and it authorized and sometimes encouraged the growing tendency towards the posthumous worship of distinguished men. In the sphere of morality its standard was generally high and its influence beneficent, especially—if we can trust the record—in the later period when it played the part of a State-Confessional and in its utterances reflected generally the progress of Greek ethics and the spirit of an enlightened humanitarianism. But its chief religious achievements were to bring some principle of unity and authority into the complex and shifting aggregate of Greek polytheism and to deepen the impression on the Hellenic mind of the divine ordering of the world; and the fruits of this teaching we gather in the works of Attic tragedy and in the history of Herodotus.

In view of the history of other temple-institutions of like power among other peoples—the Mesopotamian, for instance—we may be surprised that the Delphic priesthood made no attempt to impose Apollo as the supreme god upon the Hellenic States. The author of the Homeric hymn, composed partly under Delphic influences, exalts Apollo as high as he dares; but neither in this nor in any Delphic utterance is Apollo presented as more than the minister of Zeus, the mouthpiece of the supreme Father-god, the tradition of whose supremacy among the Aryan Hellenes had been fixed fast by Homer and the Homeridae.

Nor did the Delphic Apollo succeed in achieving a monopoly of divination; for the spirit of local independence was opposed to any divine monopoly in any department of life. And other oracles, such as some of those on the Asia Minor shore, acquired considerable prestige, especially in the later period when the influence of Delphi had declined. But from the 8th till the beginning of the 5th cent., the Pythian is the only one of the many mantic institutions that is to be regarded as a vital force of Pan-Hellenism.

8. The games of Greece.—As another important phenomenon belonging to the earlier part of this second period we note the emergence and development of the great Hellenic games, which were always associated with the worship of deities or heroes. These also must be reckoned as among the strongest Pan-Hellenic influences, evoking and strengthening the consciousness of nationality. For in the 8th cent. B.C. the whole of Hellas, eastern and western, was represented at Olympia, Pytho, the Isthmus, and Nemea; here was maintained the 'truce of God' between the jealous or hostile communities; and at Olympia once in every four years the Pan-Hellenes offered a common homage to their aboriginal Father-god.

We must, then, regard the great games and the Pythian establishment as momentous factors in the religious national life, as tending to evolve a religion of a broader compass than those of the narrow tribal type of the remote past. And they concern the higher mental history of the race because most of them, and notably the Pythian, included competitions in art and literature; and thus they assisted in establishing the specially Hellenic theory of the divine significance of the artistic and intellectual life.

¹ See CGS iv. 200-202.

² *Ib.* iv. 161 f., 200-202.

³ Fuller account in CGS iv. 179-218, and art. ORACLES (Gr.).

There were other featal and public meetings of a more exclusively religious purpose, such as the great Pan-Ionic feast of the Delian Apollo, that also served to deepen in the various States the consciousness of spiritual unity, and often, where the great lyric poets composed hymns for the occasion, to exalt and illuminate the ideal conception of the divinity: the Delian festival, for instance, of which the splendour developed in the early post-Homeric age and with the growing prosperity of the new Ionic colonies, must have contributed much to the building up of the peculiarly Hellenic ideal of Apollo; and the Homeric hymn, inspired by this occasion, is the earliest record of the national consciousness of the Ionic race.

9. Diffusion of Dionysos-worship. — Another religious phenomenon, pregnant of consequences for the spiritual history of Hellenism, is the diffusion of the worship of Dionysos. Faint though indubitable traces of this can be discerned in the pre-historic period, but it begins to be palpable and important only in the early historic. Its significance has already been indicated in general outlines (see above, p. 402^b). Having entered Attica from Bœotia and been adopted into the Attic State-religion some time before the Ionic migration to the Asia Minor coast, in the 8th and 7th centuries it gradually captured most of the States of the Peloponnese and of the islands, and the more distant colonies.

The Hellenic culture of Dionysos forms one of the most interesting chapters in the spiritual career of Hellenism; the taming of the wild Thracian god, the transformation of him into a civic deity, the disciplining and the adaptation of the *Maenad-thiasoi* to the uses of an orderly State-religion, were not the least among the achievements of the Hellenic genius. And as the State-religion of those centuries had no eschatologic theory, so it seems to have discarded everywhere whatever eschatologic promise the Dionysiac religion proclaimed on its entrance into Greece. Yet, in spite of the chastening influence of the civic spirit, the worship preserved much of its distinctive tone and religious power, evoking a special mood unknown in the other cults, while even the savage form of sacrament, in which the god was devoured in his human or animal incarnation, survived with some modifications in Tenedos and Chios down to a late period. The history, then, of the Dionysiac religion concerns the account of the development of the sacramental idea in the Mediterranean. It concerns also the history of Hellenic culture; for one of its modes of expression was a peculiar type of emotional music, accompanying the Dionysiac hymn known as the dithyramb, which is usually regarded as the parent of Attic tragedy. Its main contribution to the polytheism of Greece was its stimulation of a warmer and stronger religious faith; and its special later service to popular religious theory was the refining and brightening of men's thoughts and sentiments concerning the life after death and the powers of the lower world, with whom the mild and genial god was generally identified or associated.

10. Orphic 'thiasoi.' — But the highest importance of Dionysos is found rather in the esoteric than in the external or popular domain of Hellenic religion. For, perhaps as early as the 7th cent., the cult of Dionysos was raised to a higher power by the rise and diffusion of the Orphic brotherhoods, or *thiasoi*, who worshipped this deity under various mystic names. The study of Orphism is of the greatest interest and complexity; and here it is possible to indicate only its general features and significance.¹ The preachers of the Orphic doctrines are the first propagandists or mission-

¹ See THRACE.

aries that we can discern in the pre-Christian Mediterranean world. For they had a definite message, and, ignoring the gentile and civic barriers of the old political religion, they preached it, if not to all mankind, at least to all the Hellenes. It was a message fraught with some new and momentous ideas, whose real import we have been able to gather in part from the now famous gold-tablets found in the graves of Crete and South Italy, and containing parts of a metric Orphic liturgy and creed that is a product at latest of the 5th, if not of the 6th century B.C. Combining this evidence with some passages in Pindar's *Odes* and Plato's *Dialogues*, we can recover in outline the doctrine of early Orphism. It proclaimed a theory, unfamiliar to native Greek mythology and religion, that the soul of man is divine and of divine origin; that the body is its impure prison-house, where it is in danger of contracting stain; that by elaborate purifications and abstinences the soul might retain its purity, and by sacramental and magic methods the pure soul might enjoy in this life and in the next full communion with God. Preoccupied with the problem of the life after death, the Orphic mystics evolved the concept of purgatory, a mode of posthumous punishment temporary and purificatory; also, if we can trust certain indications in Pindar and Plato, the dogma of reincarnation or more specially of a triple cycle of lives both in this world and in the next. Students of religious philosophy have noted here the striking resemblance to Buddhistic thought; and have considered whether Indian speculation could have cast its influence so far westward at so early a time.

It is of more immediate importance for the religious history of the Greek people to determine — if we can — the measure of success that these missions achieved, how far they succeeded in capturing the masses or the élite of the people. They certainly did not succeed in penetrating the inner circle of the Eleusinian mysteries: there is no evidence that they even tried, though it is likely that they did; but we may surmise that their influence was at one time strong at Athens, as Aristophanes proclaims as a generally accepted tradition that Orpheus was the apostolic founder of all mysteries.¹ They were evidently powerful in Crete; but the chief arena of their activity and the chief scene of their secular and political influence was Western Hellas or Magna Græcia, where Pythagoras was their greatest convert, and the Pythagorean clubs their militant orders. The career of these forms a page of general Greek history. Their downfall relieved Hellas from the danger of the establishment of Orphism as a secular power, which threatened the Hellenic spirit with a bondage to sacerdotalism and to the pharisaic formalism of the purist. Henceforth the Orphic religion was a private influence only, and we have no evidence to determine precisely how great it was at any particular epoch. Pindar was deeply touched by it; Æschylus and Sophocles, so far as we can see, remained unmoved, while Euripides may have been at times attracted and at times repelled, but was in no sense its champion. Plato in a well-known passage² protests strongly against the Orphic mystery-mongers as spiritual quacks destitute of any real morality, who dealt in magic and traded in promises and threats concerning the other world. Whether this moral estimate of Orphism was just or not, there is no doubt that Plato's theory of the soul as expressed in the *Phædrus* was indebted to the Orphic metaphysic. And the part played by these preachers

¹ *Frogs*, 1032. The mystic formula used in the Attic marriage-service, 'I have fled from evil, I have found a better thing,' may have been derived from Orphic sources (see Farnell, *Higher Aspects of Gr. Rel.* p. 321.).

² *Rep.* p. 364 f.

of purity and salvation in the later spiritual history of Greece was certainly of high importance. They mark the beginning of a new era of individualism in religion; for their concern was with the personal soul and its destiny.

11. Eleusinian mysteries.—The *Eleusinia*, or Mysteries of Eleusis, were a more national and Pan-Hellenic institution than the Orphica, but of somewhat similar influence and purpose (see art. MYSTERIES). Originally they may have been merely the tribal mysteries of an agrarian society to which only the adult members of the Eleusinian community were admitted. But, when our earliest record reveals them, namely, the Homeric hymn to Demeter, which cannot be later than the close of the 7th cent., they have already enlarged their borders and their scope. For they appear there as appealing to the whole Hellenic world, and their special promise to the initiated is the happiness of the soul after death. Having once transcended the tribal limits, they seem to have imposed no conditions on the aspirants for admission except the possession of Hellenic speech and purity from actual stain; the initiation was open to women and occasionally to slaves. Nor does their influence and the power of their appeal appear to have waned until the introduction of Christianity. Many scholars have laboured to solve the problems concerning their ritual, their doctrine, and their inner significance. It has been thought that their chief attractiveness may have lain in their preservation of a higher sacramental conception of the sacrifice that had died out in the ordinary public ritual; that the initiate drank of a sacred cup in which were mystically infused the very life and substance of the kindly Earth-Mother with whom their own being was thus transcendently united. But more careful criticism shows that, though a simple form of sacrament was part of the preliminary service, the real pivot of the mystery was not this but a solemn pageant, in which certain sacred things fraught with mystic power were shown to the eyes of the catechumens, who also were allowed to witness mimetic performances showing the action and passion of a divine drama, the abduction of the daughter, the sorrow and long search of the mother, the holy marriage of reconciliation, and possibly the birth of a holy infant. To imagine the thrill and the force of these rites, one must imagine a mediæval Passion-play performed with surpassing stateliness and solemnity. Those who saw these things in the Hall of the Mysteries at Eleusis may have carried away with them an abiding sense of a closer communion with the benign powers of the nether world and a resulting hope of a happier posthumous lot. We must regard them as the highest and most spiritual product of the pure Hellenic religion, investing it with an atmosphere of mystery and awe that was generally lacking in the public cult, and which was unperturbed at Eleusis by any violence of morbid ecstasy such as marked the Phrygian and some of the Orphic rites. We may believe that they exercised a healthful influence on the moral and spiritual temperament of the Hellene; but it is not clear that they definitely proclaimed any higher moral theory, nor do they appear, like the *Orphica*, to have preached any dogma of metaphysics or theology. But, like the *Orphica*, they tended to widen the horizon of the religious spirit; for they appealed to a far larger public than the ordinary cults of the city; and, while Pan-Hellenic in this sense, they belong to the domain of personal religion; for they satisfied the personal craving of the individual for closer fellowship with the deity, and soothed the troublous apprehensions that were growing up in this second period concerning the individual destiny of the soul. Yet, as regards

Attica and Athens at least, and probably as regards Hellas, they are not to be ranked, as the *Orphica* may be, among the disruptive forces of individualistic religion undermining the social fabric of public worship. For the Athenian State administered them by the help of Eleusinian officials in its corporate capacity; and one of the catechumens—the *παῖς ἀφ' ἑορτίας*—was initiated, according to the most probable view, on behalf of the whole youth of the city.

In the Great Mysteries the agrarian significance, though discoverable and associated with simple agrarian magic, was overshadowed by higher and more spiritual religion. And elsewhere in the State-festivals we note the same phenomenon of progress in the second period. Old-world utilitarian rites of agriculture and fertility were often taken over by the expanding *Polis* and received an artistic elaboration that disguised their original significance for the primitive peasant and raised them to a higher plane of social religion. This interesting process can be best studied in following the detailed records of the Laconian *Karneia* and *Hyakinthia*, the Delphic *Pythia*, the Attic *Panathenaia*; we can feelingly appreciate in these the potent influence of the lyric poetry, the music, and the art of early Greece, shaping and elevating men's imagination of divinity.

By the close of this second period—500 B.C.—the Hellenic national consciousness has realized itself in respect of intellectual culture, ethics, and religion. Zeus Hellanios, the tribal god, is becoming Panhellenios. The age of the tyrants contributed much to the growth of Pan-Hellenism; Peisistratos probably something to the idea of a national religion, in that he seems to have worked zealously for the organization and expansion of the Eleusinian mysteries. The cult of Dionysos has penetrated the leading communities and most of the by-ways of Greece; and nearly everywhere he has been partially tamed, and the Mænads have been either suppressed or disciplined to the more sober purposes of civic worship. But the two most striking phenomena in the spiritual history of the 6th cent. were, first, the rise and expansion of Ionic philosophy and physical speculation; and, secondly, the development of a new form of literature that came to be known as the Attic Drama. Both of these must be reckoned with among the forces affecting the life of the popular religion.

12. 6th century philosophy.—The relation of Greek philosophy to Greek religion is a great and complex subject, the theme of many modern treatises; and in this slight sketch of the whole history of the polytheism there is no room for more than a few very general observations. So far as the new speculation, which gave birth to the free secular science of Europe, was preoccupied with questions of the physical origins of things and with elemental theories of cosmogony, it would not necessarily clash with any orthodox prejudice of the average Hellene. For he had no sacred books which dictated to him any views concerning the origin of the world or the constitution of Nature, and which he would have considered it immoral to disbelieve. In fact, when Herakleitos boldly declared that 'neither God nor man made the kosmos,' there was no authoritative Greek myth or theologic dogma to gainsay him. But the great philosophers of the 6th cent.—Pythagoras, Empedokles, Xenophanes, and Herakleitos—were also directly concerned with the philosophy of religion, with speculations on the nature and the true definition of godhead; and some of the surviving fragments of their works express ideas and sentiments in sharp antagonism to the concepts and ritual of the contemporary polytheism. The main trend of their speculations ran counter

to the anthropomorphic theory of divinity; and they tend to define God not as a person, but rather as the highest spiritual, or metaphysical, or even physical power or function of the universe; and there is a common tendency in this 6th cent. thought away from the theistic to the pantheistic view. Pythagoras is said to have explained the conception of God in terms of mathematics, and to have been willing to accept the personages of the popular polytheism on condition of finding their true mathematical equation.¹ But this philosopher stands apart from the other leaders of this first period of Hellenic free thought. The mathematical mind is often a prey to mysticism. And Pythagoras was the most powerful champion and apostle of Orphism, the founder of those secret societies which threatened the secular and the intellectual freedom of Hellas. Equally on its mystic and on its rationalistic side the Pythagorean teaching was in tendency inimical to the public religion of Greece, though the members of this sect appear always to have compromised with it. But it is in the fragments of Xenophanes that we find the most severe protests against the current religious conceptions of Hellas: his verses quoted by Clement² polemicize strongly against the folly of anthropomorphism, which is the master-passion of Greek polytheism; and, if one or two of his quoted utterances seem to proclaim monotheism, it is clear that for his higher thought godhead was not a person but a cosmic principle or a noetic idea. On the whole, the same account may be given of the religious theory of Herakleitos so far as this is revealed at all in the fragments. It has, indeed, been recently maintained that he tolerated and found a place in his system for the contemporary polytheism;³ but it is probably a truer view that he regarded it with half-disguised contempt and used its terms and figures only on occasion as literary expressions; while three of his fragments are scornful exclamations against the excesses of the Bacchic ritual, the methods of purification from blood, and the folly of idolatry.⁴

In this early speculation of the 6th cent., however, the parting of the ways has not yet been reached for physical science and religion; the cosmic theory is expressed in spiritual and animistic rather than in materialistic terms: for Empedokles, Love and Strife are creative principles; in the view of Thales the magnet has a soul, and all things are full of divine potencies. The great movement of Ionic thought was indeed adaptable to a high pantheistic or animistic creed, but not to the personal polytheism of the Hellenes, though most of the philosophers do not appear to have been vehement protestants. And at first their protests could have influenced only the minds of a few; nor before the 5th cent. was the popular State-religion obliged to take notice of it.

13. Rise of Tragedy.—The other phenomenon referred to above as marking the close of this period was the rise of Tragedy. The question of its influence on the whole popular religion belongs to the history of the 5th century. What concerns us chiefly at this point is its close association with Dionysos-cult. The traditional view, that it actually originated in some mimetic form of Bacchic ritual, is in the opinion of the present writer still the most reasonable, although this is now denied by some scholars.⁵ But, even if its connexion with Dionysos-worship is a secondary or accidental fact,

¹ *Plut. Mor.* 881 E; *Porphyr. Vit. Pyth.* 19, 20.

² *Strom.* v. p. 714.

³ See Gilbert, 'Speculation und Volksglaube in der ionischen Philosophie,' in *AW*, 1910, p. 306.

⁴ *Frag.* cxxvii., cxxvi., cxxx. (*Bywater*).

⁵ See Ridgeway's *Origin of Tragedy*, Cambridge, 1910; and the present writer's criticism of his theory in *Hermathena*, 1912

it is still a fact of importance for the history of Greek polytheism. The records concerning Theopis of the Attic village Ikaria, a place dominated by ancient Dionysiac legend; the statement of Herodotus concerning Kleisthenes, the tyrant of Sikyon, who gave to Dionysos the tragic choruses that hitherto had been devoted to the hero-cult of Adrastus¹—are sufficient proofs that this greatest of all the literary achievements of post-Homeric Hellas was dedicated to the god already in the 6th cent.; and throughout the glorious career of the Attic stage Dionysos remained its patron-god. His worship, then, must have received a strong stimulus from this new form of literature, which rapidly achieved popularity, and appealed directly to a larger public than any other. His character thus undergoes a singular transformation: the wild god of barbaric origin comes to take rank by the side of Apollo and the Graces as a divinity of culture and education, the inspirer of one of the greatest of Hellenic arts. Here, again, as in the cults of Apollo, Athene, and the Muses, we mark the characteristically Hellenic fusion of art and religion; and the history of the dithyramb, the Dionysiac hymn, which may have been the parent of the drama, and which was wedded to a peculiar mode of music and rhythm, is an important chapter in the history of European music.

III. THIRD PERIOD: 500–338 B.C.—The third period of Greek religion may conveniently include the 5th cent. and that part of the 4th which ends with the downfall of the system of civic autonomy at the battle of Chæronea. For the history of Greek religion, as of Greek culture, it is of the highest interest, being the richest in respect of religious monuments and literature, and the most forceful and momentous in regard to the influences at work. In the sphere of external history, it witnessed such world-crises as the struggle of Hellenism against barbarism, the rise and fall of the Imperial city-State, and the emergence of Macedon as a world-power; in the sphere of culture, it witnessed the culmination of the greatest plastic art of the world, the bloom and maturity of the Attic drama and Pindar's lyric, the diffusion of education and the spirit of inquiry through the activity of the Sophists, and the higher development of philosophy and science. To show how the religious practice and theory of the higher and lower members of Hellenic society were affected by the great events and achievements of this greatest period of human history is a necessary, but a difficult, task.

I. 5th century religion contrasted with the Homeric.—If we take Athens as the typical religious community of the 5th cent., and compare the structure and forms of her State-polytheism with that of the old Homeric world, we find the personalities of the pre-historic pantheon still worshipped and cherished; no cult of that epic world had as yet fallen into desuetude; nor had the most civilized city of Hellas discarded the immortal rites of the simple peasant religion, the worship of rivers and streams, and some of the most naive practices of Animism. And it is clear that this conservatism was no hieratic convention, but a living faith, expressing a religious intuition of the people, who were as yet untouched by the cooling influences of science and philosophic scepticism. In fact, for the greater part of the 5th cent. the life of the polytheism was probably stronger than it had ever been in the past. It was strengthened by the admission of a few new figures and by the development of some of the old.²

¹ v. 67.

² Pan came in from Arcadia at the beginning of this century (see *CGS* v. 481). Asklepios with his circle from Epidaurus at the close

It is rather in respect of its spirit, tone, and outlook that the religion of the 5th cent. presents some striking contrasts to the Homeric. Its anthropomorphism is even more pronounced, thanks to its great art-power; but it reveals a deeper conviction concerning the part played by moral agencies and powers in the affairs of men. The writings of Herodotus expound a religious view of history, of which only faint indications were found in the earlier epic literature. The historian of the 5th cent. regards the momentous contest of Greece with Persia as a conflict of moral forces, the issue being worked out by unseen powers such as Nemesis, Violence, and Justice, with Zeus as the righteous Judge; and, in weaving into his narrative the stories of Aiakid heroes and the Eleusinian deities speeding to the help of the Hellenes at Salamis, he doubtless represents the faith of the average Greek. A similar view was also impressed on the religious imagination of the people by oracular utterances, such as that which was imputed to the prophet Bakis—*δία Δίκη σβέσσει κραιπέρον Κόρον, Ἰβριος υἱόν*¹—and is expressed pictorially on the famous vase at Naples representing Hellas and Asia pleading their cause before the High God with Ἀπάτη, 'Deceit,' as a tempting demon standing by Asia.² In this scene we trace also the influence of the famous tragedy of Æschylus, the *Persæ*, which in more than one passage of deep religious conviction pronounces moral judgment on the great event.³ The same view is expressed and the same tone heard in the striking poem of Pindar's eighth Pythian ode, where he exults over the triumph of 'Hesychia,' the armed Peace of Hellas, who has cast Insolence into the sea, even as Zeus quelled the monster Typhoeus.

2. Pan-Hellenism.—The Hellenic confederate effort against Persia was the nearest approach ever made by the Hellenic race to Pan-Hellenic action; and in a striking chapter of Herodotus, eulogizing the loyalty of the Athenians to the cause of Greece, emphasis is laid on the name of Zeus Hellenios.⁴ This is the highest political title of the High God; and its history is interesting. Originally the narrow tribal name of the god of the Hellenes, a small Thessalian group under the leadership of the Aiakidai, it was transported to Aigina by a migration of the same tribe, whose ancestor Aiakos was the high priest of Zeus Hellenios; already in the 6th cent., when the denotation of Hellas was enlarged, the title may have taken on a wider meaning. But it was the danger of the Persian wars and the part played in them—we may believe—by the men and the old heroes of Aigina that brought the cult into prominence, investing the cult-name with a wider significance and a more potent appeal. Here, then, was Hellenic religion giving voice to an ideal that might be realized by the poet, the artist, and the thinker, but never by any statesman or State.

Another cult belonging to the same range as this was that of Zeus Eleutherios, the god of Hellenic freedom. 'Having driven out the Persian, they raised an altar to Zeus the god of the free, a fair monument of freedom for Hellas.'⁵ These lines of Simonides commemorate the dedication of the Greeks after the victory at Plataea, when they had purified the land and its shrine from the polluting presence of the barbarian by means of sacred fire brought from Delphi. The significance of this has been pointed out elsewhere by the present writer;⁶ the fight for liberty was prompted by more than a mere secular passion, by an idea inherent in the

civic religion. The title Ἐλευθέριος is known before the Persian wars only in the Zeus-worship of Laconia; henceforth it was widely diffused, commemorating not only the deliverance of Greece from the barbarian, but, in Sicily for instance, emancipation from the domestic tyrant.

In contrast with the deterioration of the old Roman religion caused by the Hannibalic wars, the successful struggle of Greece against barbarism in the East and the West undoubtedly quickened for a time the fervour and devotion inspired by the national cults. The sufferings of Hellas were easily repaired; the gods in whom they had trusted had not failed them, and much of the spoils won from the barbarian was gratefully dedicated to the embellishment of the shrines. The vacillating and time-serving policy of Delphi at the hour of the greatest peril was condoned or unnoted by the victors, and Apollo received an ample share of the fruits of victory. The champions of Hellenism in the West, Gelo and Hiero, commemorated their victories over the Carthaginian and Etruscan powers at Himera and Kyme by thank-offerings sent to Apollo at Delphi and Zeus at Olympia. The bronze helmet found at Olympia and now in the British Museum, inscribed with the simple dedication, 'Hieron the son of Deinomenes and the Syracusans send Tuscan spoils to Zeus from Kyme,' is an epoch-marking monument of Pan-Hellenic history and religion. The gratitude of Hellas was paid in the first instance to the high god Zeus: to him was consecrated the 'feast of freedom' at Plataea, which was still commemorated with pathetic fervour even in the last days of Hellenic decay;¹ to him, under the national title of Olympios, was dedicated the mighty temple at Akragas from the spoils won by Gelo at Himera. But the outflow of national thankfulness was directed to other divinities as well—notably and naturally to the war-goddess of the Athenians; and the spoils of Persia at Athens and Plataea were partly devoted to the erection of two striking statues of Athene. Nor were the lesser powers of the elements forgotten—the winds that assisted the Greek fleet at Artemision and the nymphs of the soil on which the battle of Plataea was fought; the grateful Athenians instituted a cult of Boreas, their kinsman, in their restored city, and assisted in the worship of the Nymphs at Kithairon.

The Arcadian goatherd-god, the rustic Pan, was admitted into Athens shortly before the battle of Marathon, and the story to which the Athenians gave currency of the help he rendered them at the great battle contributed something, no doubt, to the subsequent diffusion of his cult. A further religious consequence of these great events was the stimulus given to hero-worship; Gelo, the victor at Himera, and some of the Hellenes who fell at Thermopylae, Marathon, and Plataea, received heroic honours. This 'heroizing' of the recently defunct had its moral value as a strong stimulus to patriotism, when they had died in the service of their country; and, though it was degraded in the 5th cent. to the exaltation of the useless athlete, yet it must be reckoned among the life-forces of later polytheism and as a momentous factor of higher religious history.

Finally, we may with probability ascribe to the triumph of Hellas and to the expanding glory and greatness of Athens a marked increase in the Hellenic popularity of the Eleusinian mysteries. For this the Athenians might thank Herodotus, and his thrilling narrative of the vision of a heavenly host seen moving from Eleusis towards Salamis for the salvation of Hellas; they might also thank their own far-sighted policy of encouraging the whole Hellenic world to take part in the worship

¹ Herod. viii. 77.

² H. Heydemann, *Die Vasensammlungen des Museo Nazionale zu Neapel*, Berlin, 1872, no. 3253.

³ See specially lines 805-808, 822-824.

⁴ ix. 7.

⁵ *Higher Aspects*, 83 L.

⁶ Bergk, frag. 140.

¹ Plut. *Vit. Arist.* 20; Paus. ix. 2. 5.

at Eleusis, aspiring thus to make the Hall of the Mysteries, a recent architectural work of the Periclean administration, the centre of a Pan-Hellenic faith.¹ And their attempt in great measure succeeded.

3. Influence of religious art.—The study of the polytheism of this century is essentially also a study of the great religious art which culminated under Pheidias, but which continued forceful and prolific till the age of Alexander. The general effect of the iconic art upon Greek religion has been briefly indicated above; and long before this century the religious bias of the race was committed to idolatry;² the people craved an image that they could love and cherish, though here and there they might retain the uncouth fetish, the block of wood or rudely-hewn stone, because of the immemorial magic which it had acquired through ages of shy, half-savage veneration. The achievement of Pheidias and his contemporaries was only the culmination of a process of ideal anthropomorphism that began with Homer and was helped forward by the lyric poetry and music of the post-Homeric age, and by the art of the 6th century. Strictly estimated and studied in all its fullness, in the marvellous products of vase-painting, glyptic, and sculpture which even the shattered fabric of antiquity presents to us, the art of the 5th and early 4th centuries must be called the most perfect religious art of the world. A more spiritual or more mystic religion could not have produced or could not have borne with such an art. But it was the best and most satisfying expression of the best that the religious spirit of Hellenism admitted; for this polytheism had been built up by the teachers of the people—poets and artists obeying the race-instinct—not on vague conceptions of infinite godhead ineffable for art and inexpressible in clear speech, but on vivid perceptions of concrete divine personages, distinct in form, attributes, and character, robust and very real. The Greek artist, with his miraculous cunning of hand, could deal with these types as he could not have dealt with 'the Word' or with 'the Buddha.' Nor was he merely the exponent of the highest popular imagination, but, unconsciously perhaps and in obedience to a true art-tradition, at times a reformer and in any case a creator. For us his works have this value among others that, even more than the poetic literature, they reveal to us how the people at their best imagined their deities. But they also helped the people to imagine them better and more nobly. Perhaps the earliest art of Hellas that takes rank among the works of high religious inspiration is seen in the Attic vase-paintings produced near to 500 B.C. that portray the *thiasos* of Dionysos. The strong spirit of that religion which lifted the votary above the conventional, moral, human life, the wild joy of self-abandonment, the ecstasy of communion with God—all are here more startlingly expressed than even in the lyrics of the *Bacchæ* of Euripides or in the single perfect Bacchic ode of Sophocles' *Antigone*. It was not till the time of Skopas in the 4th cent. that Greek sculpture could so deal with this orgiastic theme. The glyptic work of the 5th cent. dealing with divine forms is mainly tranquil, majestic, ethical, intellectual; the physical perfection of the divinities sculptured on the Parthenon impresses us not so much with the sense of physical beauty and strength as with the sense of a higher and nobler vital power, so instinct is the beauty with that quality which the Greeks called *σεμνότης*—a quality partly ethical, partly spiritual, but palpable in material forms which hint at a tranquil reserve of strength. The expressive power of such an art can show benignity and mildness

¹ See CGS iii. 156 f.

² See above, p. 403.

of mood without sentimentality, beauty without voluptuousness, intellectual thought without morbidity, majesty without self-display.

The gentle and tranquillizing spirit of the Eleusinian mysteries speaks in the famous Eleusinian relief showing the Mother and the Maid giving his mission to Triptolemos. The Pheidian Athene Parthenos was a more deeply conceived ideal than the Athene of the poets, for it showed her as the Madonna of the Athenian people, with a softer touch of maternal gentleness in the face. The Zeus Olympios of Pheidias transcended the portrait of the High God as given by Homer or even by Æschylus; for the chryselephantine statue impressed the later Greeks as the ideal of the benign and friendly deity, the divine patron of a Hellas united and at peace with itself—an image that appeared 'to add something to the traditional religion,'¹ embodying, as Dio Chrysostom says, a conception of the god so convincing and complete that, 'having once seen it, one could not imagine him otherwise.'² Nor had any of the poets presented Hera in forms so winning and gracious as those in which the best art of this age embodied her, as the Argive goddess 'of good works,' 'in whose face and person brightness appeared by the side of majesty.'³ The poetic presentation of Apollo is blurred and incomplete compared with such plastic types as the Apollo of the Parthenon frieze and the Pheidian statue in the Museo delle Terme. The older poetic ideal of Aphrodite was shallow and trite compared with the Aphrodite of the Pheidian type, such as we see presented by the Laborde head in the Louvre; here is something of the majesty of the great cosmic goddess imagined by Æschylus in his *Danaides*, but combined with an emotion of human love in the countenance, and a winning appeal that the verses of the great poet do not clearly convey. And we may surmise that the *Οὐρανία* Aphrodite of Pheidias had some influence on the theory of Plato and his distinction between the heavenly and the sensual love. The full imagination of the personality of Kore would combine the radiance and the grace of the young cornfield with the awe and mystery of the lower world: the former is masterfully presented by a coin of Lampsakos, which shows her rising from among the cornstalks with uplifted, yearning face;⁴ and the unknown artist of the great Syracusan medallion struck towards the close of the 5th cent. combines this aspect of her, in a type of surpassing loveliness, with a touch of melancholy that hints at the character of the goddess of Death.⁵

And yet this triumphant anthropomorphic art must have failed, and, judged by the fragments that survive, did fail, when it tried to reveal in clear outline and full light the half-shrouded forms of the nether world, the chthonian goddesses and the Eumenides whose nature appealed to the sense of religious awe, to what the Greeks called *τὸ φρικώδες*, and did not brook to be wholly revealed. We may doubt, therefore, if even the Holy Ones, the Semnai, of Kalamis and Skopas were types so expressive of the real moral-religious imagination which fashioned these figures of cult as were certain awe-struck verses of Sophocles in the *Œdipus Coloneus*. Nevertheless, this ideal Greek art, by expressing in palpable forms of benign beauty the half-palpable personages of the lower world, did one service to religion and the religious imagination: it banished the uncouth and the terrible, and helped to purge and tranquillize the Greek mind by investing the chthonian powers with benevolence and grace. We discern here the influence of the Bacchic and

¹ Quintil. *Inst. Orat.* xii. 10. 9.

² *Or.* 53, p. 401.

³ See CGS i. 231.

⁴ *Ib.* iii. coin pl. no. 2; Gardner's *Types of Greek Coins*, Cambridge, 1883, pl. 10, 25.

⁵ See CGS iii. 271 f., coin pl. no. 12.

Demeter mysteries working upon the artist, and through the artist upon the popular faith. That the average Greek of the classic period was saved from the vampire terrors that J. C. Lawson has discovered in Modern Greece¹ was due equally to the religion and to the art that he saw around him.

Apart from this special fact, a phenomenon so momentous in the spiritual world as the flowering of this religious art in the 5th cent. claims prominent notice even in the slightest sketch of the whole history of Greek religion; for it must have worked an effect, which no student of insight would be tempted to belittle, upon the religious mood and thought of the people. Greek records sufficiently attest its religious working; even the alien Roman, Æmilius Paulus, when he approached the Pheidian masterpiece of Zeus Olympios, felt the thrill of the 'real presence.'² When Aristophanes fervently calls on Athene as 'the Maiden who holdeth our city in her hand and alone hath visible power and might, and is called the Warder of the Gate,'³ he is thinking of the bronze statue carved by Pheidias and set to guard the entrance to the Akropolis.

It is impossible, then, that this beautiful idolatry, against which the philosophers might occasionally protest,⁴ could have weakened the popular faith in the native deities. Introduced suddenly into Rome, it helped to destroy the old Roman animistic religion. But the religious instinct and history of Greece were wholly different from those of Rome. Greek polytheism would probably have perished or been absorbed by alien systems of cult far sooner than it was, if Greek art had not fortified and ennobled it, rooting it deeply in the æsthetic-religious emotions and perceptions of the people.

4. Influence of literature: Pindar, Æschylus, Sophocles.—More familiar, and apparently more answerable, is the question concerning the influence of the poetic masterpieces of this period, the works of Pindar and the Attic drama, on the general history of Greek religion. The subject is obviously too complex for the scope of this article, and has been handled by many scholars in large treatises. There is room here only for the most general statement of facts, tendencies, and effects. As exponents of the highest contemporary religious thought, the names of Pindar, Æschylus, Sophocles, and Euripides are those of prime authority. It is easy and interesting to collect religious citations from their works, and to compare these one with another, and with the current polytheism. It is far more difficult to decide, generally and in regard to any special point, how far any one of them could have influenced or modified the popular religion. Nor are all these four on the same footing in respect of opportunity. For Pindar writes for dynasts and aristocrats, and, being a hireling, might be thought fettered in the free expression of his sentiments; and in any case his public was more limited than that which the three dramatists addressed. Their message, therefore, was likely to reach further and to penetrate the Greek mind more deeply than anything that Pindar had to say; and that this was actually the case can be proved. Nevertheless, Pindar must be reckoned with as an original thinker who spoke words of power; in spite of his profession, his mind remained imperial and free; and in his attitude to the public religion he is to be grouped with Æschylus and Sophocles; and all three stand together and apart from Euripides. All three show the virility, the mental tranquillity combined with imagination and audacity,

¹ *Modern Greek Folklore and Ancient Greek Religion*, Cambridge, 1910.

² Livy, xlv. 28.

³ *Thesmoph.* 1136 ff.

⁴ Xenophanes' protest in the 6th cent. is the most noticeable (*Clem. Strom.* v. pp. 714, 715 P); the Stoic theory of Zeno condemned the erection of temples as well as idols (*ib.* p. 691 P).

that marked the typical character of the greatest age of Hellas. And all three genially and without querulous protest, though with some freedom of criticism, accept the existing religious order, desiring to ennoble it, not to destroy it. Pindar himself was the establisher of certain new cults, and the first great literary preacher in Greece of Orphic eschatology, and, we may say, the first great poet in Europe who raised the theme of Paradise to the level of the highest poetry. Such a marvel of song on the mysteries of life and death as the second Olympian ode was a new voice in Hellas; how far it echoed, and with what influence on the faith of the people, is impossible to measure with accuracy. For the progress of this new eschatology, which is a weighty subject for the history of later Hellenism, we have some important negative evidence in the fact that neither Æschylus nor Sophocles shows any knowledge of Orphism or interest in it, or any pre-occupying concern with the state of the soul after death; nor in their occasional utterances concerning posthumous judgment do they go beyond the popular traditional view; though the thoughtful refinement of Sophocles suggested to him that there might be forgiveness of sins and reconciliation after death.¹ Nor do we find anywhere in the works of the two dramatists any hint of that pregnant Orphic doctrine to which Pindar gives voice, that humanity is of Divine origin—*ἐν δὲ δῶρ' ἐν θεῶν γένος*,—a doctrine which passed into the higher thought of later Greece.

Leaving aside this special question, we find a certain general resemblance in the religious view of these earlier poets of the 5th century. All three preach the supremacy of Zeus, his omnipotence and perfect justice, while Sophocles lays stress on his mercy. The effect of this poetic message was probably great, and certainly timely; for the growing power and frequency of hero-cult, which Pindar himself and the dramatists indirectly encouraged, was a danger to the higher religion; and the backward and less cultured Hellenes were doubtless liable to the propensity of the savage mind to prefer the worship of the local *daimon* to that of the high god. Against such degeneracy the works of the greatest 5th cent. poets, like the masterpiece of the greatest 5th cent. sculptor, served at least as an enduring protest in Hellas. It would be of interest to consider how far the sculptor, in regard to the general conception of his mighty theme and in the choice of mythic bywork whereby he made it articulate, drew certain suggestions from the poetry of Æschylus.

These poets also deal with the question of Fate and Destiny. The personal *Moira* was an old, though insignificant, figure of the popular religion and mythology; Homer is aware of her and has to reckon with her. She might become more formidable under the philosophic conception of *τὸ ἐμπαμπέρον*, which appeared in the philosophy of Herakleitos; and we know that later philosophy and cultivated thought were much perplexed over the problem of the reconciliation of Fate with the idea of a free divine Providence. These poets, taking their cue from Homer, 'follow a short cut,' interpreting *Moirai* as the voice or agent or 'emanation of the power' of Zeus.² The pupil of Pheidias, Theokosmos of Megara, was working out the same idea when he carved the Fates with the Hours as subordinate adjuncts to the great form of Zeus.³

¹ *Antig.* 521.

² The *Prometheus Vinculus* of Æschylus expresses indeed a view of Zeus that conflicts with the higher religious thought of the poet. But Æschylus has here taken up a crude story that he cannot wholly moralize. On the other hand, his handling of the idea of the curse in the house of Pelops is not worked out on the lines of mechanical fatalism. Cf., further, art. FATE (Greek and Roman).

³ *Paus.* I. 40. 4.

We may say, then, that both the poetry and the art of this period worked for the deliverance of the polytheism from the burden of fatalism, which tends to lower the value of all theistic religion.

Again, each of these poets, while accepting and in certain points purifying the traditional polytheism, was capable of religious thought that worked on other lines than anthropomorphism. The high god Zeus is generally for them a definite personal Being; but once at least Æschylus transcends this apprehension of him, and defines Zeus pantheistically as a supreme, cosmic force; a fragment of his *Heliades* speaks of him thus: 'Zeus is air, earth, heaven; Zeus is the whole of things, and whatsoever is higher still than these.' Moreover, the other divine forces that shape our lives are presented by him and his fellow-poets not always as *theoi* but as moral powers that are only half-personal, not as concrete individual deities but as emanations of these. We may call them 'personifications of moral ideas,' and some are no more than what this phrase implies, such as those, for instance, with which Euripides capriciously plays. But some may rather be described as the soul-powers of the High God, like in some ways to the Persian *Fravashi*; such are Pindar's *Σώτριάς Διὸς Ζεῦτος Θεῖος*,¹ the *Δίκη* of Æschylus, 'Justice the maiden daughter of God,'² who 'shines in the poor man's smoke-dimmed cabin,'³ and, in the verse of Sophocles,⁴ Mercy who 'shares the throne of God to deal with all the deeds of men.' While Pindar's genius inclines to the brighter of these emanations, Æschylus broods rather over the gloomy forces of the shadowy world, which he might at times be constrained to present in palpable concrete form for stage purposes, and yet his own deeper thought could grasp as half-outlined spiritual powers, not the less real because impalpable. The ordinary Hellene in his religious perceptions laid too much stress on personal individuality, as if this were the only criterion of ideal reality: from his point of view, if Eros was to be a real force of the spiritual world, then Eros must be imagined as a beautiful youth. But Kypris or Aphrodite in a striking Sophoclean fragment is no longer presented as a personal goddess but as a diffused pantheistic force.⁵ And the Attic drama may have enlarged the mental outlook of the succeeding generations in this matter; for the author of the speech against Aristogeiton in the 4th cent. must have been sure that his audience would understand him when he said: 'All mankind have altars dedicated to Justice, Law-abidingness, Pity, the fairest and holiest (being those) in the very soul and the nature of each individual.'⁶ This is just how Euripides might speak.

The great 5th cent. poets were all moralists, each in his own way. The history of Greek ethics concerns us only at the several points where it touches religion; and to this history, both generally and on its religious side, the works of Pindar and the three dramatists make important contributions. Of special interest is their attitude to Greek mythology, which, in spite of its general brightness and beauty, seriously needed in parts the puritanical reformer, if it was to be harmonized with the higher religious thought. But none of these poets, not even the grave Æschylus, was willing to undertake such a rôle. Pindar of all the three comes nearest to preaching, for his *metier* allowed him more personal freedom of comment. We find him anticipating Plato in his protests against some grotesque and repulsive stories such as the cannibalism of the gods in the myth of

Pelops, or blasphemous stories such as the theomachies and the combats of heroes against divinities: 'Let all war and strife stand far apart from the immortals'¹ is a good sententious maxim for the expurgation of Greek mythology and for the enrichment of Greek ethico-religious thought. But neither Pindar nor the two older dramatists protest against the more licentious myths, and they accept at need various legends about the amours of the gods. In fact, the axiom that sexual purity was an essential attribute of all divinity was not yet accepted by the higher thought of Greece.

Pindar's freedom and sense of irresponsibility in regard to myths has a certain value, in that it shows that the futilities and improprieties of mythology—the 'unhappy stories of bards'—were not necessarily a burden on the stronger religious minds of Hellas, and that they could be gently excised from the polytheism without endangering the popular worship and faith, which in the main were independent of them.

As for the two dramatists, Pindar's contemporaries, mythology was their public business; and they accepted it genially because they were not in the first place moral teachers but dramatists; it did not, therefore, occur to them to protest or violently to reform. But they might select, discard, and re-shape; they could take the great legends of the past—legends of Thebes, the story of the Niobids, of Prometheus, the death of Ajax—all of them irreconcilable in parts with higher morality and religion, and invest them with as much morality as the tradition admitted. This they did with force and subtlety. And generally the moral spirit and imagination of Æschylus and Sophocles must be counted among the spiritual facts of this period with which the history of Greek ethics and religion must deal. Doubtless the older and robuster poet was the stronger moral and religious force: his protests against the superstitious doctrine of Nemesis, his profound utterances concerning moral responsibility and the moral continuity that links our lives and actions, his discovery that suffering brings wisdom—these are landmarks in the ethical story of Greece; while with Sophocles the conviction is no less deep of the eternity and divinity of the moral law. They were the last spokesmen of a civic-imperial system with a civic religion and morality that had not yet passed its zenith. Cf., further, artt. ÆSCHYLUS, SOPHOCLES.

5. Euripides.—The part played by Euripides in this spiritual history of Hellas was wholly different. Younger contemporary of Sophocles as he was, he seems to belong to a different age. In his work and thought is reflected far more vividly than in the older poets of the same century the new mental life which was fostered by the philosophers and the sophists. The influence of the physical speculations of the 6th cent. and of those of Demokritos and Anaxagoras of the 5th, which at some points advanced further in materialism, had had time to penetrate the more gifted minds and to compel the public to a certain attention. The paid 'sophist,' the pioneer of modern education and the first champion of the critical spirit, was travelling around. And after 470 B.C. the imperial greatness of Athens had begun to attract the greatest teachers and thinkers of the age. It was of great moment for Euripides that such men as Anaxagoras and Protagoras were active in Athens for many years, and that he had enjoyed familiar intercourse with them, as he also enjoyed with Socrates. It is clear that the poet imbibed deeply their teaching and their spirit; he was also learned in Orphism, antiquarianism, and remote folklore. Being by nature a great poet, he had also something of the weak-

¹ *Ol.* viii. 28.

² *Agam.* 776.

³ 678. *Dind.*

⁴ *Sept. c. Theb.* 662.

⁵ *Ed. Col.* 1268.

⁶ § 35.

¹ *Ol.* ix. 60.

ness of the 'polymath' or the 'intellectual'; he had not the steadiness of brain or strong conviction enough to evolve a systematic philosophy or clear religious faith; his was, in fact, the stimulating, eager, critical spirit, not the constructive. His mental sympathies and interests shift and range from pole to pole. He is a secularist in his view of a physical universe, and he foreshadows a secular treatment of ethics based on ideas of *φύσις* and heredity—though a chorus of his maidens may praise chastity as 'the fairest gift of the gods.' It was, therefore, possible, though most unjust, that Aristophanes should call him an atheist. On the other hand, he is capable of profound religious sentiment and exalted religious utterance, and strikes out flashes of light that might kindle and illuminate a higher religion. Therefore it was possible for Clement of Alexandria to find in some of his words a foreshadowing of Christ.¹ He remains for us an enigma, and probably no final judgment will ever be pronounced upon him, in which we shall all agree. But the student of Greek religion must confront these two questions about him: (a) What was his real sentiment concerning the popular religion? (b) What were his contributions to religious thought, and what was likely to be his influence on the religious temperament of his audience and readers? To make up one's mind on these questions demands a long and critical study, also a tactful sense of the distinction between Euripides the playwright and Euripides the thinker. It is the confusion of this distinction that leads, for instance, to the strangely erroneous views held concerning the religious significance of his *Bacchæ*. A sympathetic reading of many of the plays must convey the impression that certain cult-figures and legends of the polytheism filled the poet with scorn and loathing; and at times he seems to compose as if he had a personal hatred of Apollo and Aphrodite in particular, for instance in the *Ion* and *Hippolytus*. When he can interpret Aphrodite as a cosmic force, he can dilate on this as beautifully and ardently as Lucretius; if he could have believed that Apollo was merely the sun, as he tells us 'the wise' were well aware, he might have forgiven him. But it is the real personal Aphrodite of Homer and Helen, the personal Apollo, the father of Ion, the seducer of Kreusa but the beloved ancestor of the Athenians, that rankle in his mind. When he handles the story of the madness of Herakles and brings Madness on the stage, he uses her first as his mouthpiece to convey to the Athenians what he thought of Hera;² just as he puts into the mouth of Amphitryon his own mordant criticism of the action of Zeus.³ Yet with other parts of the polytheism he seems at times in the most glowing sympathy: in the *Hippolytus*, for instance, where he expresses for the first time in literature the religious rapture of purity; in the *Bacchæ*, where he discovers the necessary phrase for the expression of the Bacchic communion, for the ecstasy of the Mænad revel on the mountain, in verses that tingle with the nature-magic that was at the root of this wild cult. Yet no one should be deceived into thinking that he is preaching the cause of Dionysiac worship; for the *Bacchæ* closes with that depressing anticlimax, where Dionysos plays the sorriest part, and Euripides' own sour dislike of the personal traditional god gives an unpleasant flavour to the last scene. It is this bitterness of protestantism and criticism in this poet that strikes a new note in Greece; and Euripides may be regarded as the first in European history to be possessed with the theologic temper. It cannot be said that he preached a new religion: he was no votary even of Orphism; for, though, as the *Bacchæ* and the fragment of his *Cretans*

¹ Strom. p. 688. ² Herc. Fur. ll. 847-858. ³ Ib. 339-347.

attest, he felt something of its spell, he was not of that cast of mind which could be deceived by its pharisaic ritual and laws of diet, and he certainly cherished no mystic belief concerning the life after death. Nor can he be truly described as a zealous reformer of the people's faith and practice: for the reformer must have some belief in that which he wishes to reform, and that Euripides firmly believed in any part of the polytheism is hard to maintain; his final attitude is generally a doubt. Nevertheless, his protests might have been of value to the more cultured citizen who still clung to his civic worship. They are directed mainly and most forcibly against the stories of divine vindictiveness and divine licentiousness. He is evidently touched with the new idea that vengeance is alien to the perfect nature of God; this was still more insistently proclaimed by the Pythagoreans, by Plato, and later philosophers.¹ On the second count his protest is suggested by the notion that was dawning in him that purity in every sense was essential to the divine nature; he is then the herald in literature of a thought which Orphism may have prompted, and which was to play a leading part in later religion and religious speculation, but which was unfamiliar to his contemporaries either in Hellas or anywhere in the Mediterranean except in Israel. His leading principle of criticism in all these matters is expressed in the *Iphigenia in Tauris*, namely, that the evil in religious practice and legend arises from men imputing their own evil nature to God.² We owe much to the man who first uttered this warning against a debasing anthropomorphism.

The immoral elements in Greek mythology, which have been constantly reprobated by ancient and modern writers, have often blinded them to the fact that Greek religion in its forms of worship and sacred formulæ was mainly pure and refined. The stories about the gods, often of the type natural to savage folklore, did not constitute ancient religion; and they were the less able to choke the growth of a higher ethical-religious spirit in that they were not enshrined in sacred books that could speak with authority to the people. Yet we have not infrequent proofs in Greek literature, notably in Plato's *Euthyphron*, that they might exercise at times an immoral influence on men's conduct. Meantime the educational movement in the 6th and 5th centuries had awakened men's minds to the importance of the moral question in literature. And the protests of Euripides are developed by Plato in his scheme of education in the *Republic*; and the same moral point of view prompts him to his puritanical legislation against poets. Such moral movements in the polytheistic societies of Greece are interesting to mark, though their effect is often difficult to estimate. The new puritanical spirit had probably a wholesome influence on the more cultured minds; it had little influence on the mass of the people, nor does the later poetry of the Hellenistic period show much trace of it.

As regards the actual forms of Greek ritual and worship, Euripides has nothing revolutionary to say. He appears to have a strong dislike for prophets, and in this he was in some accord with Æschylus, Sophocles, and the Athenian people. He shows great distrust for Delphi; and its influence was doubtless impaired at Athens during the Peloponnesian war. He protests against human sacrifice, as a barbaric and non-Hellenic institution;³ and on one occasion the speaker argues that the gods need nothing from mortals at all:⁴ the thought was suggested merely by dramatic exigencies; and Euripides nowhere attempts a crusade

¹ See Farnell, *Higher Aspects*, p. 114.

² l. 391.

³ *Iph. Taur.* 391.

⁴ Clem. Strom. p. 691 P.

against the value of sacrifice in general. He has only one important thing to say about it, namely, that the small sacrifice of the pious often outweighs the hecatomb.¹ This thought implies a more spiritual view of the divine nature, and is not infrequently expressed in the later literature; according to Theophrastos and Theopompos, this higher view of sacrifice was even encouraged by the Delphic oracle.²

There is much, indeed, in the sententious poetry of Euripides that might have elevated and cleared the religious thoughts of his age; but it is doubtful if his ultimate conception of godhead, as it tends towards pantheism, could have been reconciled with the anthropomorphic polytheism of the people, or if those most conversant with his tone and inspired by his spirit could have remained long in sympathy with orthodoxy. And there is an instinct in Euripides which enhances his value for the modern man, but which in the long run was to be subversive of the old civic religion, namely, the humanitarian or cosmopolitan instinct—that which allowed him to sympathize with Trojans, women, children, and slaves, which inspired him with the beautiful thought that 'the whole earth is the good man's fatherland,'³ which prompted him to despise the life of civic duty and activity, and to recommend, as Aristotle does, the secluded and contemplative life. The further development of this cosmopolitan spirit and its effect on the old civic religion will be noted below.

It has been necessary to dwell so long on Euripides, not only for the reasons mentioned above, but also because, owing to the vogue that he won in his lifetime and that was greatly to increase after his death, he more than any other of the great men of letters must be regarded as the popularizer of the new enlightenment. Cf., further, art. EURIPIDES.

6. Influence of the new enlightenment on the popular religion.—Whether Euripides individually exercised any immediate religious influence upon the popular mind, either for good or for harm, is not easy to decide with precision; for there were other exponents than he of the same freer and more advanced thought which began to express itself early in the 6th century. As a result, we are able to discern the religious view of human life and conduct becoming what we should term more spiritual, more inward. The moral judgment begins to look to the soul or the inner principle; the doctrine begins to be proclaimed that God as a spiritual power can read the heart of man, and judges him by that; that sin lies not in the external act alone; that external ritualistic purity is of less avail than purity of soul. Such thoughts as these, which could serve as the foundation-stones of a new religion, and which helped to shape the later religious history of Europe, were mainly a heritage from the speculation of the 6th cent., and were in the air of the 5th. We cannot think that they were confined to the philosophic circles until Euripides gave them publicity; for the notable oracle quoted and commented on by Herodotus had proclaimed to the people the novel view that a sinful purpose was the same in the sight of God as a sinful act;⁴ Epicharmos had preached the higher ideal of purity: 'If thou art pure in mind, thou art pure in thy whole body.'⁵ It was perhaps in the latter part of the 5th cent. that some rhetorician of the school of Gorgias interpolated the proem of Hesiod's *Works and Days*, which reveals an exalted view of the High God.⁶

¹ See Stobæus, *Flor.*, vol. iv. (Meineke) p. 264.

² See CGS iv. 210.

³ Stobæus, *Flor.*, vol. ii. (Meineke) p. 71.

⁴ vi. 88.

⁵ Clem. Alex. *Strom.* p. 844.

⁶ See Ziegler, in *ARW*, 1911, pp. 393-405; its authenticity is well defended by P. Mazon, 'Hésiode, la Composition des "Travaux et des Jours,"' in *Revue des Etudes anciennes*, xiv. (1912).

We may believe, then, that this higher religious ethic had a certain elevating influence on the popular imagination. The question of immediate interest is whether we can trace any effects of this in actual worship. Did the new enlightenment, for instance, lead to the abolition or reform of cruel or impure forms of ritual?

7. Human sacrifice.—This question involves the consideration of the practice of human sacrifice, which had certainly been prevalent in pre-historic and early historic Greece, as in other Mediterranean communities. We have evidence that in the 5th and 4th centuries the practice was of rare occurrence in the Greek societies, and was repugnant to the religious morality of all but the most backward.¹ The Platonic dialogue of the *Minos* contrasts the Greeks with the barbarians in this matter, yet implies that the Arcadians in the cult of Zeus Lykaïos and the men of Halos in that of Zeus Laphystios² continued the cruel offerings which disgraced their Hellenism. Euripides attests that the human sacrifice once customary in the rites of Artemis near Brauron had been, before his day, transformed to a mere fiction.³ The Locrian sacrifice of the maidens to appease the wrath of Athene Ilias fell into desuetude in the 4th cent. B.C.,⁴ and at some time earlier than this the Athenians must have ceased to immolate the *φάρμακοι* in their *Thargelia*.⁵ The Rhodians eased their consciences, and at the same time maintained their immemorial rite, by choosing as a human victim to Kronos⁶ a malefactor who had been condemned to death. According to Porphyry, the practice survived here and there under the Roman Empire until the time of Hadrian.⁷

But the better sentiment of Greece had probably begun to work as early as the time of Homer;⁸ for certain legends concerning the abolition of this ritual and the substitution of the animal for the human life point back to the pre-historic period; and the merciful reform in the ritual was ascribed to the High God himself in a Laconian legend which closely resembles the story of the sacrifice of Isaac.⁹ The humanitarian spirit, then, had asserted itself before the 6th cent.; but doubtless the higher teaching and thinking of this and the succeeding age quickened its influence.

8. Phallic ritual.—As regards that element in Greek ritual which by modern taste is pronounced impure, there is little trace of any attempt at reform in any period of the polytheism. The element was indeed but slight. The forms of worship were, on the whole, decorous, often stately and beautiful; ancient legend reveals the anxious care of the early Hellenes to preserve their temples from any sexual defilement; where a *λεπὸς γάμος*, or 'holy marriage,' was enacted in any of the shrines, there is no need to suspect any licentiousness.¹⁰ No such feature is discernible in the Eleusinian or other Hellenic mysteries, although the Christian Fathers are eager in their insinuations. The Hellenic cults of the Oriental Aphrodite were generally innocent¹¹ of that ritual of temple-prostitution which was found in certain Anatolian cults, and which scandalized the Greek as much as the Christian writers; the few impure titles attaching

¹ The feeling about the sacrifice of Iphigeneia manifested in the *Agamemnon* of Æschylus and the story about the Bœotian generals, and the sacrifice of a maiden before the battle of Leuktra (Plutarch, *Vit. Pelop.* 21 f.), are sufficient proof; cf. Eur. *Iph. Taur.* 391.

² Cf. Herod. vii. 197, who shows that the human sacrifice was rare and conditional.

³ *Iph. Taur.* 1458.

⁴ Schol. Tzetz. *Lykophr.* 1141; see CGS i. 383.

⁵ See CGS iv. 276-27.

⁶ Porphyry, *de Abst.* ii. 54.

⁷ *Ib.* ii. 58.

⁸ See above, p. 401b.

⁹ Plut. *Parallela*, 35; see CGS i. 95.

¹⁰ Farnell, *Gr. and Bab.* p. 267.

¹¹ The exceptions are the cults of Aphrodite at Corinth and among the Lokri Epizephyrii; see CGS ii. 635 f.

to this goddess may well have arisen in the later period of the decadent polytheism.¹ In the early ages, it is clear, the wholesome and temperate influence of the Hellenic spirit had worked upon the forms of the polytheism. Nevertheless, in the ritual of a few divinities—Demeter, Hermes, Dionysos, and even Artemis herself²—sexual emblems were occasionally in vogue, and dances of a more or less licentious character are mentioned, though these are very rare; while in the Thesmophoria and other services of Demeter, what was called *αἰσχρολογία*, indecent and scurrilous badinage, was indulged in by the women among themselves, or more rarely with the men also. We note that such ritual is practically confined to vegetation-cults, and in some it is merely vegetation-magic, hardly attaching to the divinity, or affecting his or her moral aspect. The phallic emblem and the procession called the *φαλλαγῶγία* or *φαλλοφορία* were specially associated with Dionysos and Hermes; and Plutarch, a man of more than average culture and refinement, and strikingly susceptible to the spiritual influences of the more mystic religions, describes it as a harmless adjunct of the ancestral and cheerful Dionysiac ritual of the Bœotian peasant.³ Now, it is worth noting that against this element in Greek ritual there is scarcely a word of protest in all the ethical and philosophic literature of Greece. The exception is only a fragmentary utterance of Herakleitos, in which he rails against the phallic procession of Dionysos; but the exact sense of his words is not quite clear.⁴ The higher moral thought of Greece on this matter is probably more nearly represented in the utterance of Aristotle in the *Politics*,⁵ where he lays down austere rules for the training of the young:

'No impure emblem or painting or any representation of impropriety is to be allowed by the archons, except in the cults of those divinities to whom the law attaches the ritual of scurrility (*τρωθασμός*); in their case the law allows those of more advanced age to perform the divine service in behalf of themselves, their children, and their wives.'

Even in the last three centuries before Christ, when greater stress was continually being laid upon purity in cult, no protest is heard against these old-world forms, which have maintained themselves in many parts of Europe down to the present day, in spite of the denunciations of Christianity. The seeming paradox is explained when we reflect that the idea of purity changes its content in the different generations; and, secondly, that the Hellenic, like all the other Mediterranean religions except the Hebraic, regarded the physical procreative power as belonging to the divine character and as part of his cosmic creative force; therefore an emblem that was secularly impure might be made holy by cult and consecration.

9. **Survival of other primitive ritual.**—There is much besides in old Greek ritual that appears to us harmless, but uncouth and irrational; strange and naive things were done that primitive ideas of magic and animism inspired; and one may be surprised to find that the higher culture of the 5th and succeeding centuries is not known to have suppressed a single one of these. Still in the time of Theophrastos, and indefinitely later, the Athenians were capable of the quaint old-world ritual of the *Bouphonia*, that strange medley of ritual, magic, and dramatic make-believe:⁶ in the time of Demosthenes⁷ they were capable of bringing up to judgment in the law-courts an axe or any other inanimate thing that had caused the death of a man or of the sacred ox, and solemnly condemning it to be thrown into the sea. The driving out of

sin or famine, incarnate in a human being, was a ceremony in vogue at Massilia,¹ and probably also at Athens long after the beginning of our era. Nor did the higher anthropomorphism, powerful as its working was, entirely obliterate the worship or half-worship of animals in the later centuries.² Even Zeus might still be conceived by the men of the 4th cent. as occasionally incarnate in the snake; we have noticed above a ritual law regulating the cult of Asklepios at Athens, composed shortly after 400 B.C., in which a sacrifice was ordered to certain sacred dogs; the pious votary would comply, however the act might awaken the laughter of a comic poet. Herakleitos protested against the absurdity of praying to idols; but no voice of the new enlightenment is heard against these far more irrational and backward ceremonies. The average public thought of the 5th cent. did not repudiate the use of magic; in fact, it is not till this century that its efficacy is known to have been recognized by legislation.³ And Plato, speaking about it in his *Laws*,⁴ a work of his declining years and intellect, is not sure whether he believes or disbelieves in its power. There is nothing more conservative than ritual; and Greece produced no ardent Protestant reformer. Therefore the average educated Athenian even of the 4th cent. would doubtless agree with the orator Lysias that 'it is prudent to maintain the same sacrifices as had been ordained by our ancestors who made our city great, if for no other reason than for the sake of the city's luck.'⁵

10. **Strength of the traditional religion in the 5th century.**—The question naturally occurs—Were the mass of the citizens touched at all in their inward theory of things by the spirit of modernism which breathed from Ionia and inspired the sophists? The culture which was the stock-in-trade of the latter was offered only to those who could pay; and upon these the poorer Athenian looked askance. He heard of it at first with a dislike that might become dangerous. Fanaticism, as we are familiar with it in the pages of European and some Semitic history, was happily alien to the Greek temperament. But the banishment of Anaxagoras and Protagoras and the execution of Socrates, by the city that was to become the school-mistress of Greece, might seem to savour somewhat of this temper of mind. These acts were not inspired solely by religious feelings; but they are clear proofs that the polytheism was by no means moribund and could be dangerous in its own defence. Nothing is more erroneous than the view, sometimes expressed, that the popular devotion to the old religion was abating and its divine personalities and forms were losing life and value towards the close of the 5th century. In their dark days the Athenians remained truer to their old faith than did Rome in her time of terror. We do not find Athens turning desperately for aid to alien Oriental cults. We hear, indeed, of the beginnings of Adonis-cult in the latter part of the Peloponnesian war—the first ripple of a wave of Orientalism that was to surge westward later. But this feminine excess was unauthorized, and Aristophanes hates it and mocks at it. The shallow view mentioned above would be sufficiently refuted by his comedy of the *Clouds*, in which he, the greatest genius of his time, poses as the champion of the reaction against modernism. It is refuted also by other incidents in Athenian history that fall within the last decades of this century; the rage of the people at the mutilation of the Hermai,

¹ Serv. ad Verg. *Æn.* iii. 57.

² See Farnell, *Gr. and Bab.* pp. 76-80.

³ See 5th cent. inscription of Teos containing a law threatening with penalties those who used magic against the State or against individuals (Roehl, *Imag. Inscr. Græc. Antiq.*, Berlin, 1894, p. 50, no. 497).

⁴ 932 E-933 E.

⁵ *Or.* 30, § 18.

¹ CGS ii. 667.

² e.g. in the cult of *Ἀρτεμις Κορδάκα* in Elis, said to be of Lydian origin (CGS ii. 445).

³ P. 627 D.

⁴ Bywater, frag. cxxvii.

⁵ vii. 17, p. 1336b.

⁶ CGS i. 56, 88-92; art. ANIMALS, vol. i. p. 506.

⁷ xxiii. § 76.

at the supposed insult to the Eleusinian Mysteries, at the neglect of the dead after the battle of Arginousai, may be evidence of morbid religiosity, and is surely inconsistent with a general prevalence of scepticism; in these episodes the whole people reveal a passionate attachment to their holy mysteries, to their quaint phallic Hermes-images on which the luck and the life of the State depended, to the duties of the loving tendance of the dead. Even their animistic beliefs concerning the common phenomena of the physical world had not yet been extirpated or purged by the physical philosophy of Ionia; for, according to Plato, it was still a dangerous paradox, which his Socrates disclaims before the jury, to maintain with Anaxagoras that the sun and the moon are merely material bodies and not in themselves divine. Intellectually, Nikias appears inferior to Homer's Hektor. It was Athens that produced in the 4th cent. 'the superstitious man' of Theophrastos; but it is right to bear in mind that she also produced the man who could so genially and tolerantly expose that character.

11. Influence of comedy.—Those who believe that the faith in the polytheism was falling into rapid decay by 400 B.C. sometimes quote by way of evidence the astonishing licence of Attic comedy in dealing with the divine personalities; the notorious example is the ludicrous figure and part of Dionysos in the *Frogs* of Aristophanes. Yet the people who enjoyed the humour of the play were more devoted to Dionysos than to most of the other persons of their pantheon. If the 'excellent fooling' of Aristophanes is a proof of popular unbelief, what shall we say of that Attic terra-cotta of the 6th cent. which represents the god half-asleep and half-drunk on the back of a mule and supported by an anxious Silenos? The present writer has suggested that 'this is some peasant's dedication, who feared his god little but loved him much, and treated him *en bon camarade*.'¹ Epicharmos in Sicily had been beforehand with Aristophanes in venturing on burlesque of divine actions, Hephaistos and Herakles specially lending themselves to ridiculous situations. Even in the Epic period the same gay irreverence had occasionally appeared, as in the Homeric hymn to Hermes. These things do not necessarily arise from an anti-religious spirit, but they may be taken as indications of a certain vein in the Hellenic character, a lightheartedness and a reckless freedom in dealing on certain occasions with things divine that is markedly in contrast to the Oriental spirit. Nevertheless, it is not improbable that comedy at Athens and elsewhere did gradually exercise a weakening or a debasing influence on the popular faith. For the other poets of Attic comedy took greater liberties than even Aristophanes: Kratinos, Telekleides, and Plato of the 5th cent., Amphis of the 4th, did not shrink from introducing the High God himself on the stage in ridiculous and licentious situations. There probably was some reserve and no gross indecency in the presentation of these plots. And much is conceded to the spirit of the Carnival, especially when a certain *αλοχολογία* was sanctified by custom and ritual. Nevertheless, the more earnest-minded of the Athenians may have agreed with Plato's condemnation of such a handling of divine personages;² and, though the popular faith may have been robust enough to endure such shocks, one cannot but suspect that the people's religious imagination suffered a debasement in moral tone. A few south-Italian vases of the 4th cent., on which are scenes that appear to have been inspired by such comedies, are the worst examples of Hellenic vulgarity.

¹ CGS v. 264.

² *Rep.* 378 C, where he seems to glance at Epicharmos.

The history of Greek religion, then, must reckon with Attic and other Greek comedy as among the possible causes of religious corruption and decay; but at the worst this is only one side of the picture, for the fragments of the comedies of Menander contain many a striking expression of the higher religious spirit and advanced ethical sentiment (see below, p. 421).

12. Waning of the political value of Delphi.—There are certain external events in the history of Greek religion towards the close of the 5th cent. that must be noted in a general sketch of its career. One is the waning of the political influence of the Delphic oracle: its secular mission appeared to have been accomplished when the era of Greek colonial expansion had closed; at the first terror of the Persian invasion, the great States anxiously resorted to Delphi for guidance, but the priesthood failed to rise to the Pan-Hellenic occasion and played a double game. During the Peloponnesian war it was obvious that they were 'Laconizing'; nor were they ever given again an opportunity of leading *la haute politique* of Hellas; and in the middle of the 4th cent. Demosthenes could speak contemptuously of 'the shadow at Delphi,' although the Amphiktyonic League, as the only federal council of Hellas, still retained a nominal value sufficient to induce Philip to scheme for admission. Generally, in the 4th, 3rd, and 2nd centuries the oracle retained influence only in the spheres of religion and morality. It came to serve the purposes of a private confessional, giving advice on questions of conscience; its counsel was generally sane and often enlightened, and shows the priests as possessed with the progressive spirit of Greek ethical philosophy.¹

13. Spread of Asklepios-worship.—Another event of importance is the diffusion of the cult of Asklepios and the growing influence on the Hellenic mind of this once obscure hero or earth-daimon of the Thessalian Triikka. It was thence that, some time probably in the 6th cent., he had migrated to Epidaurus, where his power expanded through his union with Apollo. His cult-settlement in Kos was a branch of the Epidaurian; and already in the 5th cent. the Asklepieion of this favoured island had reared the great Hippokrates, and was thus the cradle of the later medical science of Europe. Towards the close of this century, Asklepios and his daughters came over from Epidaurus to Athens, and, according to a well-founded tradition, the poet Sophocles was his first apostle: in the next generation we find the Athenian State regulating his worship, which was soon to conquer the whole Hellenic world. In the survey of the Hellenistic age this must be reckoned with as one of the main religious forces of later Hellenism. We may note in passing a striking divergence between the European spirit of Hellenic religion and the Oriental spirit of Mesopotamia; the Babylonian god practises magic, the Hellenic Asklepios practises and fosters science; and his cures at Epidaurus were not merely of the Lourdes type, but show the beginnings of sane therapeutic.

14. Growth of the 'thiasoi'.—Another interesting phenomenon that begins to arrest our attention in the latter part of the 5th cent. is the growth of private *thiasoi*, or voluntary religious associations independent of the public religion and devoted to a special divinity who might be an alien. The most interesting testimony is the title of a comedy by Eupolis called the *Baptai*, which we may interpret as 'the Baptizers,' satirizing a society devoted to the Thracian goddess Kotytto, whose initiation rites must have included a ceremony of baptism, of which this is the earliest example within the Hellenic area. It will be more convenient to esti-

¹ See CGS iv. 211-214.

mate the importance and religious significance of these *thiasoi* in the survey of the next period of our history. Meanwhile it is well to mark certain evidence that the most powerful and appealing of these, the Orphic mystery, having failed in the 6th cent. to capture the States of Magna Græcia, was increasing its private influence in Eastern Greece in the century before the rise of Alexander. Plato's attack is itself a witness to this. And, when Aristophanes¹ and an Attic orator contemporary with Demosthenes² openly acknowledge Orpheus as the apostle to the Hellenes of 'the most holy mysteries' and the teacher of a higher way of life, we must conclude that the spirit of the Orphic brotherhoods had touched the imagination of the general public outside the circle of the initiated.

15. Religion in first half of 4th century B.C.—Yet it is hazardous and probably false to say that the public religion of Greece was decaying visibly throughout the first half of the 4th century. Athens is, as usual, our chief witness. The restored democracy was all the more strenuous in matters of religion as scepticism was considered a mark of the new culture of the oligarchically-minded. The trial of Socrates is an indication of this temper. We have also evidence from this period of the occasional severity of the Athenian people against those who tried to introduce unauthorized and un-Hellenic cults. The Hellenic tradition is still strong against the contagion of the orgiastic spirit of the Anatolian religion, and it was with difficulty that the Athenian public could tolerate the wild ritual of Sabazios and the Phrygian Mother, nor even in the time of Demosthenes were the participants in it secure from danger. The early 4th cent. art still exhales the religious spirit and serious ethos of the Pheidias school; it created the type, and almost succeeded in establishing the cult, of the new goddess of Peace, Eirene, for whose presence among them the wearied Athenians might well yearn; it also perfected the ideal of Demeter, the Madre Dolorosa of Greek myth, whose Eleusinian rites with their benign promise of salvation added power and significance to the later polytheism. The literature of this period still attests the enduring vitality of the popular religion. The Attic oratory of the 4th cent. was more religious in its appeal than any modern has been, as might be expected of a time when there was yet no divorce conceivable between Church and State. It is not a question of the religious faith of the individual orator, but of the religious temper of the audience, which is attested by many striking passages in the speeches. According to Antiphon, the punishment of sinners and the avenging of the wronged are specially the concern of the deities of the nether world;³ Andokides avers that foul misconduct is a more heinous sin in a man who has been in the service of the Mother and the Maid of Eleusis;⁴ the speech against Aristogeiton is almost as much a religious as a juridical utterance. Demosthenes may have been a sceptic at heart, believing in chance—as he once says—as the governing force of our life; but otherwise he is glowingly orthodox in respect of Attic religion and mythology, and the greatest of his speeches closes with a fervent and pious prayer.⁵ Again, it is well to remind ourselves that the political or forensic orator is a truer witness to the average popular belief than the poet or the philosopher.

16. Plato's attitude towards the popular religion.—A consecutive history of Greek religious thought as embodied in the surviving writings

or records of the philosophic schools of Hellas is far too large a subject even to be adumbrated here; and a general survey of the religion can only notice shortly the leading thinkers whose works there is reason to suppose had popular vogue and lasting influence upon the religious world. Among these the primacy belongs to Plato; and the full account of Greek religion, both in the period that precedes the downfall of Greek independence and in the periods that follow, must include a critical estimate of his religious speculation. This is no place for an elaborate consideration of the metaphysic of his ideal theory, or the relation of his ideas to a theistic system; only the most general observations may be allowed for the purpose of this sketch. To understand his main attitude towards the popular cults, and his influence upon the later educated world of Greece, we must recognize at once that, idealist and reformer as he was, he was no revolutionary or iconoclast in matters of religion: he would reform Greek mythology, purging it of stories of divine conflicts, divine vengeance, divine amours; and, as these fortunately were enshrined in no sacred books, he feels that this might be done gently and easily without disturbance to the established forms of worship. He does not desire to abolish sacrifices or idolatry, but he inculcates simplicity in the offerings.¹ In one passage he even maintains that the legislator will not change a single detail of the ritual, if only for the reason that he does not know anything of the inner truth that may lie behind such outward forms.² Even in his most advanced physical and metaphysical speculations, he finds a place for the popular pantheon:³ in the hierarchic scale of things the Olympians are ranged somewhere below the supreme transcendental God of the Universe. The *Timæus* dialogue presents some interesting theologic dogma; here,⁴ in the scale of divine creation, the Olympian pantheon, which seems to be accepted rather for the sake of ancient tradition, is given the third place, after the planets and the sun, which are the second works of the supreme Creator, the first being the cosmic Heaven. These deities of the polytheism, then, are not immortal in their own nature, but are held together for all eternity by the will of the Highest God. And it was to them that He committed the formation of man, and lent for this purpose a portion of His own immortality; the mortality of man is thus accounted for, which would have been inexplicable had man sprung directly from the immortal Supreme Being. It is interesting for our present purpose to note that this esoteric and transcendental system, devised by the great master and parent of Greek theosophy, would leave the established religion more or less unimpaired; it even accepts its data at certain points, namely, the nativity of its gods, and draws the logical conclusion that gods who were born could not be by essence immortal; therefore Zeus could not be accepted as the Absolute and Supreme Being of the Cosmos. It also proclaims the idea of an immortal element in man, which, again, is in accord with the contemporary popular faith in the survival of some part of our being after death.

But the work which reflects most vividly the popular religion and betrays the strongest sympathy with it is the *Laws*, a work of Plato's old age, in which the conservative spirit of the religious reformer is no less striking than the intellectual decay of the philosopher. He accepts the greater part of the civic political religion, merely purifying the mythology and some of the ideas concerning divinity; and it is striking how easily he finds in it materials ready to his hand on which he can

¹ *Frogs*, 1032.

² *Or.* i. § 31.

³ *de Cor.* § 324.

⁴ κατ' Ἀριστοφάνη, *A.* § 11.

⁵ *de Myster.* § 125; cf. § 31.

¹ *Laws*, 956 A-B.

² e.g. *ib.* 984 D.

³ *Epinomis*, 985 D.

⁴ pp. 34-41.

build an exalted ethical religious system of rights and duties, especially those which concern the life of the family and the groups of kinship.¹ In fact, the background of the thought in this lengthy treatise is almost always the Greek *Polis*, though glimpses may here and there break through of a wider vista. Plato expresses a prejudice against all forms of private and orgiastic cult, which were dangerously enticing to women;² any doubtful question that might arise concerning rite or cult he would leave to the decision of the oracles of Delphi or Dodona or Zeus Ammon.

We feel generally that Plato did not consciously assume the part of an apostle of a new order of religion, but that both in his philosophy and in his religious theory he found a sufficient *point d'appui* in the old, of which he tried to strengthen the moral potentialities. The later sects which attached themselves to his name or to his school were deeply interested in religious speculation, which degenerates at last into the mystic superstition of Neo-Platonism. Therefore, as the work of Aristotle belongs to the history of European science, so the philosophy of Plato concerns the later history both of pre-Christian and of Christian religious thought. To estimate exactly how his influence worked on the better popular mind in the centuries before Christ is impossible. But we may naturally and with probability surmise that he contributed much to the diffusion of the belief in the spiritual nature and perfection of God, to the extirpation of the crude notions of divine vindictiveness and jealousy, to the interpretation of the external world in terms of mind and spirit as against any materialistic expression, to the acceptance of the belief in the divinity of the human soul, and its affinity with God, and in the importance of its posthumous life, which was partly conditioned by the attainment of purity. The latter ideas constitute the faith of the Orphic sects, from whom Plato may have silently borrowed them. But, whether through Plato or through the *thiasoi*, many of them come to appeal strongly to the popular mind of later Hellas.

17. Religious art in the 4th century.—Our general survey is now approaching that period of world-change brought about by the rise of Macedon. But, before leaving the scene of the free city-State, we should remember to estimate the religious work done by the great 4th cent. masters of sculpture before the power of Alexander reached its zenith. The fiery imagination of Skopas found plastic types for the forms of Dionysos and his *thiasos*, and his work rivalled at least, if it did not surpass, in inspiration of tumultuous life the masterpieces of the older Attic vase-painters noticed above. Praxiteles, the master of the gentler moods of the soul, in the religious sphere consummated the types of Aphrodite and Demeter; the almost perfect embodiment of the latter goddess, the Cnidian Demeter of the British Museum, has affinity with the spirit, if not with the formal style, of his school, and combines something of the tearful expression of the Madre Dolorosa with the blitheness of the corn-goddess. We are conscious, indeed, of a change in the representation of divinity. The works of this later generation have lost the majesty and awe, the *σεμνότης*, as the Greeks called it, of the 5th cent. art; nor can the Greek States command any longer the creation of the chryselephantine colossal statues of temple-worship. In these later types, though still divine, there is more infusion of human passion, the personal experience, the struggles and yearning of the individual soul. Anthropomorphism is pur-

suing its path; and, though still fertile in works of high spiritual value, may come to weary and weaken the religious sense.

IV. *FOURTH PERIOD.*—The establishment of the Macedonian Empire wrought momentous changes in the civic-political religion of Hellas; and some of these were in the direction of loss and decay, while others worked for the possibility of new religious life. The political significance of Apollo of Delphi, of Zeus and Athene, the divine leaders of the *Polis* in its counsels and ambitions, was doomed to pass away. Athene as the warder and counsellor was of less avail for Athens than were the Samothracian sea-deities for the victorious Demetrios. Certainly in the first centuries of the Hellenistic age there were few external signs of decay; we do not yet hear of ruined shrines or the decline of great festivals such as the *Delia*; Athene, though no longer the goddess of a civic Empire, was still and for ages remained for the Athenian the benign Madonna to whose care the boy-athlete and the marriageable girl were dedicated; we have record from the island of Tenos¹ of the abiding hold that even such a deity as Poseidon still exercised on the affections of his people as late as the 2nd and 1st centuries B.C.; the later personal names, as some of the earlier, attest the affectionate faith that linked the family and the individual with the national deity, for the child is often named as if it were the gift of Apollo, Athene, Hermes, or the river-god; and, if we had continuous chronicles of each cult-centre, we should probably find similar evidence showing that the dominant figures of the old polytheism were still able to fulfil in some degree the religious wants of the individual worshipper. And scholars who have been tempted to antedate the decay of Hellenic polytheism have ignored, among other evidence, this important historic fact that in the 4th cent. it was still vital enough to make foreign conquests, to penetrate and take possession of Carthage, for instance, and that in the 3rd cent. it began to secure for itself a new lease of life within the city and the growing Empire of Rome; in fact, the last chapter of Greek religion falls within the Roman Imperial period.

1. Growing force of personal religion.—Yet the Hellene in the 4th cent. B.C. and in the early days of Macedonian ascendancy began to crave other outlets for his religious emotion than the traditional cults of his phratry or tribe or city. Personal religion was beginning to be a more powerful impulse and to stimulate a craving in the individual for a more intimate union with the divinity, such, for instance, as was offered freely by the Great Mysteries of Eleusis. We have fairly sufficient evidence that the 4th cent. witnessed a great extension of their influence.² The Mysteries of Megalopolis were instituted, and those of Andania were re-organized, by their aid; and Ptolemy I. is said to have invited the aid of an apostle from Eleusis to assist in some religious institutions of his new city of Alexandria.³

2. The religious brotherhoods.—The same craving was also satisfied by the private *θιασοί*, the guilds of brethren devoted to the special cult of one divinity. These unions belong to the type of the secret religious society which is found in all parts of the world at varying levels of culture (see art. GILDS). In Greece we have evidence of them as early as the time of Solon; it was probably not till the 5th cent. that any of them were instituted for the service of foreign divinities; we hear then of the *thiasos* of the Thracian goddess; and, in the earlier half of the 4th cent., of the orgiastic fraternity devoted to Sabazios, with which Æschines

¹ For particulars, see Farnell, *Higher Aspects*, pp. 37, 46-48 103, 117.

² p. 209 E.

¹ BCH xxvi. 309-439.

² Ib. 199.

³ See CGS iii. 199-202.

in his youth was associated. But it is not till the Macedonian period that the epigraphic record of these guilds begins; henceforth the inscriptions are numerous and enlightening concerning their organization and their wide prevalence throughout the Hellenic world.¹ Their importance for the history of religion is great on various grounds.

They show the development of the idea of a humanitarian religion in that they transcend in most cases the limits of the old tribal and civic religion and invite the stranger; so that the members, both men and women, associate voluntarily, no longer on the ground of birth or status, but drawn together by their personal devotion to a particular deity, to whom they stand in a far more intimate and individual relation than the ordinary citizen could stand to the divinities of his tribe and city. This sense of divine fellowship might sometimes have been enhanced by a sacrament which the members partook of together; we know that this was the bond of fellowship in the Samothracian mysteries, which were beginning to appeal widely to the early Hellenistic world. A common meal at least, a love-feast or 'Agape,' formed the chief bond of the *thiasotai*, and this was sometimes a funeral-feast commemorative of the departed brother or sister. There was nothing to prevent the *thiasos* choosing as its patron-deity some one of the leading divinities of traditional polytheism, to which they must not be supposed, as Foucart supposed them, to stand in any natural antagonism; for instance, there were local reasons why Greek merchants whose central meeting-point was Rhodes should form *thiasoi* under the protection and in the name of Zeus Xenios, the god who protects the stranger, or of Athene Lindia, the ancient and powerful divinity of Lindos, or of Helios, the pre-historic sun-god whose personality pervaded the whole island. So far, then, the religious importance of these societies consists in their quickening influence on personal religion, in the gratification that they afforded to the individual craving for personal union with the god-head, also in their organization which aroused a keener sense of religious fellowship between the members, and which later served as a model to the nascent Christian community.

But in the history of Hellenic religion their significance is even greater on another ground, namely, that they bear a most striking testimony to that fusion of East and West which it was the object of Alexander and the mission of his successors to effect; for many of these religious brotherhoods, whose members and organization were Hellenic, were consecrated to foreign deities—Sabazios, Adonis, Xousares, and the Syrian goddess—so that they played undesignedly the part of missionaries in the momentous movement sometimes called the *theokrasia*, the blending of Eastern and Western religious and divine personalities, of which the significance will be considered below.

3. Menander.—The student who is tracing the course of the religious life and experience of Hellas through the Hellenistic period should endeavour to gather beforehand a vivid impression of the spirit of the Menandrian comedy. For Menander, the friend of Epicurus and the devoted admirer of Euripides, was the favoured heir of the humanitarian spirit that had gleamed fitfully even in the Homeric period and had gathered strength and articulate expression in the century before Alexander opened the gates of the East. Patronized and courted by Demetrios Phalerens and Ptolemy, admired by the scholars and reading public of Alexandria and the Hellenistic world even more than he had been by his own contemporaries, Menander was eminently in a position to give a

¹ See Foucart, *Associations religieuses chez les Grecs*.

tone to the religious sentiment of this period; and the Anthologies of his works prove that he was actually revered as an ethical-religious teacher.¹ Therefore, for the general exoteric history of Greek religion he counts for more than any of the philosophers, for he addressed a far larger public. Yet the message that he has to deliver has come to him from the philosophers and from the inspiration of the humanized Attic spirit, of which he appears the most delicate and final expression. While writing and thinking pre-eminently as the cultured Athenian of the close of the 4th cent., he is the mouthpiece of cosmopolitanism in ethics and religion—'No good man is alien to me; the nature of all is one and the same' (*οὐδείς ἐστὶ μοι ἀλλότριος ἀνὴρ ἢ χρηστός· ἡ φύσις μία πάντων*);² the Terentian formula, 'homo sum, humani nil a me alienum puto,' is only an extension of this, losing something of its ethical colouring. Many of the fragments, showing striking approximations to New Testament teaching, are of vital importance for the history of Greek ethics. As regards religion, they may contain protests against superstition, and the extravagance of sacrifice proffered as a bribe;³ but they exhibit no real or veiled attack on the popular polytheism as a whole. On the other hand, they have preserved many memorable reflexions that bear witness to the development of a religion more personal, more inward and spiritual, than had hitherto been current, save perhaps in Platonic circles. God is presented as a spirit and as spiritually discerned by the mind of man; and a high ideal of Platonic speculation is delivered to the public in the beautiful line, *φῶς ἐστὶ τῷ νῶ πρὸς θεὸν βλέπει δει*, 'the light of the mind is to gaze ever upon God.'⁴ The sense of close and mystic communion between man and the omnipresent divine spirit is strikingly attested in the passage of one of his unknown comedies:

'a guardian spirit (*δαίμων*) stands by every man, straightway from his birth, to guide him into the mysteries of life, a good spirit, for one must not imagine that there is an evil spirit injuring good life, but that God is utterly good.'⁵

In attempting to estimate what is most elusive—the inner religious sentiment of any period—it is important to remember that the author of such expression was dear to at least the cultivated public of the Hellenistic age.

4. The 'theokrasia.'—The tolerant humanitarianism of Menander, of which we catch the echo in certain formulæ inscribed on the Delphic and other temples, is reflected in that which is perhaps the most striking religious phenomenon of this period, namely, the *theokrasia*, the fusion of divinities of East and West. As regards religious theory, this is not to be regarded as a new departure. Herodotus shows how natural it was to the Hellenic mind to interpret the deities of foreign nations in terms of its native pantheon: and it was easy for Euripides to commend Kybele as Demeter.⁶ But it was by no means easy, in fact it was exceedingly dangerous, before the time of Alexander to introduce any unauthorized foreign cult into the city-State. We hear vaguely of the death-sentence inflicted or threatened on those who did so. Nevertheless, as we have seen, such foreigners as Sabazios and Attis were intruding themselves into Athens at the time

¹ See a recent paper by Pierre Waltz in *REG*, 1911, 'Sur les Sentences de Ménandre'; the writer aims at discovering or imagining the dramatic setting of each fragment, and at disproving the view that Menander was posing as an original ethical teacher. Accepting his theory, we can still assign high value to the 'Sentences' for the purpose of Greek ethical history, whether we regard them as original and earnest utterances of Menander or as commonplaces which he uses lightly for dramatic purposes; for, if the latter view of them is the more correct, they show at least what was in the air.

² Kock, *Com. Att. Frag.*, Leipzig, 1880-88, no. 602.

³ e.g. quotation by Clemens, *Strom.* p. 720 P: cf. fragment of the *Ἰέρεια*, Kock, 245.

⁴ *Γνώμαι μονόστιχ.* 589, Meineke, iv. 356.

⁵ *Fab. Incert.*, Kock, no. 550.

⁶ *Helene*, 1300-1305.

of the Peloponnesian war, trailing with them the orgiastic atmosphere of Phrygia; and at some indefinite time before this the impure ritual of certain Oriental goddess-cults had invaded the Corinthian worship of Aphrodite. But after the establishment of the kingdoms of the Diadochi, the gentile barrier in religion gradually loses its force and significance. It was, in fact, a far-sighted measure of policy on the part of some of the kings to establish some common cult that might win the devotion of the Hellenic and Oriental peoples alike. Such was the intention of Ptolemy when he founded at Alexandria the cult of the Babylonian god Sarapis, whom the Egyptians were able, owing to a similarity of name, to identify with their Osiris-Apis, and the Hellenes with their Plouton, owing to the accidental fact that an image of this underworld-god happened to be consecrated to the cult at its first institution. Similarly, when the Syrian city of Bambyke was re-settled as Hierapolis by Seleukos Nikator, the personality of the great goddess Atargatis (*q.v.*) was mingled with that of Artemis, Hera, Aphrodite, and other Hellenic goddesses; and the treatise of Lucian, *de Dea Syria*, gives us the most interesting picture presented by antiquity of the working of the *theokrasia* in the domain of religion and religious art.

The spirit of syncretism grows stronger and more pervading through the later Greek and Græco-Roman periods, and dominates the later Orphic and Gnostic thought; and the inscriptions, usually the best record of the popular religious practice, attest its wide diffusion. We find the deities of diverse lands—Egypt, Syria, and Greece—linked together in the same formula of thanksgiving, and the same offering dedicated to them all. And the name Zeus is applied to so many gods of the East that in the cult-formulæ it seems often to have lost all its personal and concrete value and acquired the vaguer meaning of 'God.' The Jewish Jahweh Himself—under the name 'Iâw—was occasionally identified with him, and at times, it seems, even with Dionysos.

The importance of this movement for religious thought was of the highest. Varro's view recorded by Augustine,¹ that the name of the deity made no difference, so long as 'the same thing is understood,' and that therefore the God of the Jews was the same as Jupiter, is a great idea bequeathed to the world by Greek tolerance and Greek sanity. Only a nation could attain to this freedom of religious imagination that was not held captive by the magic spell of names² which made it so difficult for the Jew to shake off the tribal spirit of the religious blood-feud. This Hellenic expression of religious enlightenment prepared the way for monotheism, and thus indirectly for Christianity; it also could induce the pantheistic idea of a diffused omnipresent spirit of divinity such as is expressed in the lines of Aratos, the scientific poet of the 3rd cent. B.C.: 'All the ways are full of (the spirit of) God, and all the gathering-places of men, the sea and harbours, and at every turn we are all in need of God, for we are of kin to him.'³

5. Stoicism, Epicureanism, Cynicism. — This pantheistic speculation inspires some of the dogmas of Stoicism; and for most of the Stoic writers and thinkers the concept of divinity was less that of a personal concrete Being than of a spiritual force or soul-power immanent in things; therefore, while some of them tried to find a place in their metaphysical system for the creations of the polytheism and even a justification for augury and divination, the impression left on our minds by the fragments that have come down to us of the religious specula-

tion of the Stoa is that of a system alien and antipathetic to the popular theistic point of view, and especially to the social religion of kin-group and city; Zeno the founder is said to have protested against shrines and idols.¹ His protest was in vain; nor is there any clear indication that Stoicism had any influence on the religious thought and practice of the average man of the people; unless, indeed, the emergence of the cult of 'Aperth, Virtue, in the 2nd cent. B.C. at Pergamon and Smyrna was suggested by the strong theologic colouring that the Stoic gave to morality.²

As for Epicureanism, it cannot be regarded normally as a religious force; if it touched the popular mind at all, its influence must have been generally in the direction of atheism or indifferentism; the only signs that it did are occasional grave-inscriptions which breathe the Epicurean spirit of unperturbed quiescence in regard to the posthumous fate of the soul.

The philosophic school that was most aggressively protestant against the popular creeds and cults appears to have been the Cynic, mordant and outspoken criticism being characteristic of this sect. We have record of Diogenes' contempt for the Eleusinian mysteries, of Antisthenes' disdain for the great Mother of Phrygia and her mendicant priests; and the fragments in a newly discovered papyrus of a treatise by Kerkidas,² the Cynic philosopher and statesman of Megalopolis in the 3rd cent. B.C., contain a theory which reduces personal deities to impotent instruments of Fate, and would substitute for Zeus and his colleagues certain divinized abstractions such as *Némeosis* and *Merádōs*; the latter term, if the reading is sound, seems to denote the spirit of unselfishness or sacrifice—an interesting and potentially valuable idea but at this time still-born.

6. Asklepios-cult and later mysteries.—These sectarians of this later age do not appear to have made a serious attempt to capture the mind of the public; and the popular religious movements for the most part ignored them and their teaching. The Hellenistic religions are as convincingly theistic and idolatrous as the older were. The chief change lay in this, that a man now might to some extent choose his own divinity or—what was even of more import—be chosen by him or her; he was no longer limited to the cults into which he was born. This freedom had already for some time been offered by the *thiasoi*; and now in the Hellenistic world, especially by the powerful and wide influence of the cult of Asklepios, the idea was developed of a deity who as Healer and Saviour called all mankind to himself; and it was this significant cult-phenomenon that induced Kerkidas in the above-mentioned passage to include *Παίδν*, 'the Healer,' among the true divinities whose worship ought to supplant that of the older gods. In the treatise called *Asklepios* of the pseudo-Apuleius a long address and prayer to this deity are preserved, of which the tone is strikingly Christian.⁴

7. Non-Hellenic mysteries.—The phenomenon here indicated attests again the stronger vitality at this period of personal or individual, as distinct from tribal or political, religion; and this was quickened also by the growth of certain non-Hellenic mysteries in the Mediterranean area in the later centuries of paganism, notably by the Samothracian, those of Attis and the Great Mother, the Egyptian Isis, and, finally, in the last period of all, of Mithra. In most of these the records allow us to discover many interesting ideas that reappear in Catholic Christianity, such, for instance,

¹ Clem. Strom. p. 601.

² See *CGS* v. 446, 475, ref. 221.

³ *Oxyrhynch. Papyri*, viii. 81.

⁴ See *JRW*, 1904, p. 395; Farnell, *Evolution of Religion*, p. 207.

¹ *de Consensu Evangelistarum*, l. 80 (xxii.); cf. *de Civ. Dei*, iv. 9.

² See Farnell, *Higher Aspects*, pp. 104-106.

³ *Phainomena*, lines 2-5.

as communion with the divinity through sacrament, the mystic death and rebirth of the catechumen, the saving efficacy of baptism and purification. These rites could satisfy the craving of the mortal to attain to the conviction of immortality and to the ecstatic consciousness of complete or temporary self-absorption in God. But in the mysteries of Sabazios and Cybele, and possibly in others, this sense of divinity was conveyed to the *mystes* by the simulation of a holy marriage or sex-communion with the god or goddess; and for this reason the pagan mysteries were generally attacked by the Christian Fathers as obscene; the charge was unjust on the whole, though the psychic effect of the special act of ritual just alluded to was probably detrimental to the moral imagination.

8. Hermetic literature.—The strangest and most interesting reflexion that the ancient records have preserved for us of this fusion of Hellenic culture and Oriental religious sentiment is presented by the Hermetic literature. The origins of this most fantastic product of the human mind are traced by Flinders Petrie¹ back to the 6th or 5th cent. B.C. But though much of it is pre-Christian, its philosophic diction proves that it cannot be earlier than 300 B.C., and the bulk of it is probably much later. A frequent Hermetic formula addressed to the Deity—*ἐγώ εἰμι σὺ καὶ σὺ ἐγώ*, 'I am Thou and Thou art I'—may be taken as the master-word of these hieratic writings.² The unnatural alliance between Greek philosophy and the Oriental mystic theosophy that these writings reveal is a momentous phenomenon of later paganism; and the study of the origins of Christian metaphysic is much concerned with it. Such theosophy had a natural affinity with magic; and magic, always a power in an age of intellectual decay, begins to be most powerful in this latest age of Hellenism. It is a just reproach that Augustine brings against Porphyry, the most notable of the Neo-Platonists, that he 'wavered between philosophy and a sacrilegious curiosity,' that is, a vicious interest in the black art.³

In these strange forms of faith and speculation the clearness and sanity of the pure Hellenic intellect appear clouded and troubled, the lineaments of the old types of the Hellenic thought and imagination almost effaced. And the learning and science of the Hellenistic age stood mainly aloof from the religious forces that moved the masses of the people.

9. Daimonism.—The mystic and theosophic literature of the Hellenistic and Græco-Roman period was markedly 'daimonistic,' being infected with the polydaimonism of the East and positing the existence of good and evil *daimones* as a metaphysical dogma. We can trace a corresponding change in the popular Hellenic imagination. In the earlier period, as has been shown, the native Hellene was, as compared with other races, fairly strong-minded in respect of the terrors of the demon-world; but the later people of the Greek area were certainly tainted in some degree with this unfortunate superstition of the East, and various forms of exorcism, conjuration, and evocation became more prevalent. The modern Greek temperament appears to be possessed with this disease;⁴ and we may suppose that the germs have been inherited and developed from this last period of the old civilization.

10. Eschatology.—But another feature that we mark in this mystic religion and these mystic societies of the Hellenistic world indicates a higher aspect of religion, and suggests possibilities of

¹ *Personal Religion in Egypt*, London, 1909, p. 40.

² See Reitzenstein, *Poimandres*, Leipzig, 1904.

³ *de Civ. Dei*, x. 9.

⁴ See J. O. Lawson, *Modern Greek Folklore and Ancient Greek Religion*.

momentous development; most of them, if not all, proclaimed the immortality of the soul, a happy resurrection, a divine life after death. The Hellene who had been initiated into the Osirian faith hoped to attain immortal happiness in and through Osiris, availing himself of Egyptian ideas and Egyptian spell-formulæ. The priest of the mysteries of Attis comforts the congregation of the faithful, sorrowing over the death of their god, with words that aver the certainty of his resurrection and by implication the hope of their own:

Ἐσπεύετε μύσται τοῦ θεοῦ σεσωσμένον
ἔσται γὰρ ἡμῖν ἐκ πόνων σωτηρία.¹

The mysteries of Mithra embodied much the same eschatologic ideas and hopes; but these came to the Græco-Roman world only in the latest period before the establishment of Christianity, and had little hold on Hellenic society proper. Doubtless the most attractive mystery for the Hellenes was the Orphic; we have many proofs of its activity and life in the two centuries before and after the beginning of our era; and we can well understand the causes of its popularity. Its deity had become Hellenized long ago; the Orphic formulæ are free from barbarous jargon, and admit the familiar divine names; the insistence on purification was congenial to many Hellenic temperaments; there was probably nothing surviving in the ritual that was objectionable to the cultivated Hellene; and, finally, its picture of Paradise seems to have accorded with the trend of the Hellenic imagination. The numerous grave-inscriptions of those centuries rarely express any definite Orphic sentiment or allude to any specially mystic faith; but we have the evidence of Plutarch attesting the prevalence of the Orphic societies and their power of appeal: when he is consoling his wife for the death of their child, he reminds her of the promises of future happiness held out by the Dionysiac mysteries, into which they have both been initiated.²

11. Hero-worship and apotheosis.—The idea that was common to many of these mystic brotherhoods, that the mortal might achieve divinity, is illustrated by another religious phenomenon which stands out in this latest period, namely, the worship of individual men and women either in their lifetime or immediately after death (see artt. DEIFICATION, HEROES [Greek and Roman]). To appreciate the full significance of this, one must be familiar with the usages of the earlier Hellenes as also of the Oriental peoples who became subjects of the Diadochi. We have observed that the Greek of the 6th and 5th centuries was willing to concede heroic honours to certain distinguished individuals after death; in this there was nothing inconsistent with the principles of higher polytheism; and in the earlier cases the grounds of canonization were usually good and reasonable. It becomes a more serious question about the religious and moral character of a people when divine worship is proffered to a living person. Of this the first example is the cult of Lysander as a god, which, as Plutarch seems to imply, arose even in his lifetime.³ The same writer records the story of the apotheosis offered by the people of Thasos to Agesilaos, and his sarcastic refusal.⁴ The same kind of adulation was lavished by the degenerate Athenians on Alexander and Demetrios Poliorketes. The most salient examples are derived from the records of the Seleukidai and the Ptolemies, the kings of these dynasties usually

¹ Firm. Mat. *de Err.* 22; cf. Dieterich, *Eine Mithrasliturgie*, p. 174.

² *Consol. ad uzor.* 10, p. 611 D.

³ *Vit. Lysandr.* 18; cf. Athenag. p. 61 (Leclair).

⁴ P. 210 D, *Apoth. Lacon.*; he advised them to begin with making themselves gods if they felt equal to making him one.

enjoying divine honours after death, and sometimes bearing divine titles such as *Σωτήρ*, 'Saviour,' *Θεός*, 'God,' in their lifetime. Is this merely the gross servility of a decadent age that had lost all real sense of religion? This is no doubt the true account of it in some degree: Dio Chrysostom exclaims against the quackery and vanity of it;¹ and the sharp-witted Athenians and the educated Greeks generally would be under no illusion when they prostrated themselves before these human gods. It is natural to suppose that the effect upon the life of the old religion was corrosive, when a queen or a courtesan could be publicly recognized as Aphrodite, and that the general belief in Apollo and Dionysos would tend to collapse when the one was identified with the Seleukidai, the other with Attalos. Yet the faith in Dionysos at least was able to survive the strain. And what looks to us mere hypocrisy and blasphemy would appear to many of the Hellenistic communities in another light. It seems that the uncultured Greek in the time of Herodotus was capable of believing in all seriousness that Xerxes might be a real incarnation of Zeus upon earth;² and such an idea would be familiar, as an old tradition in the popular estimate of kingship, to the natives of Syria, and still more to the Egyptians. When the Rosetta Stone proclaims the Ptolemy as 'the living image of God,' the average Greek might smile in secret, but the native Egyptian would instinctively assent to this assumption of divinity by the heir of the ancient Pharaohs.

This deification of the mortal, so rife in this later period, may be regarded as a moral and religious evil. Yet it must not be taken too hastily as a proof of the unreality of the prevailing polytheism. And, for better or worse, it was a momentous fact belonging to the higher history of European religion; for it familiarized the Græco-Roman world with the idea of the incarnation of the Man-God.

12. Signs of decay and of new life in later paganism.—The Hellenistic period cannot be severed by any sharp dividing line from the Græco-Roman; but it belongs rather to the student of Roman religion and the Roman Empire to pursue the history of Hellenic polytheism through the first centuries of our era down to the establishment of Christianity.

The religious phenomena of the period that has just been sketched present, on the one hand, the signs of decay,—the decay of the old civic and political religion which fostered the growth of the Greek *Polis*,—and, on the other hand, the working of new religious forces which prepare the way for Christianity. The cults of Apollo, Zeus, and Athene were among the first to wither; yet a living and personal religious sense was in all probability more diffused through the Greek world under the Epigoni and the Roman Empire than it had been in the earlier centuries. Contact with the Oriental spirit brought to many a stronger intensity of religious life; religion is no longer preoccupied with the physical and political world; its horizon lies beyond the grave, and its force is 'other-worldliness.' Men flock to the mysteries seeking communion with the divinity by sacrament, and sustaining their faith by mystic dogmas. The religious virtue most emphasized is purity, of which the influence is often anti-social; this was no longer always understood in a pharisaic sense, but its spiritual significance was proclaimed to the people and penetrated the sphere of temple-ritual. An inscription from a temple in Rhodes of the time of Hadrian contains a list of rules 'concerning righteous entrance into the shrine'; 'the first and greatest rule is to be pure and unblemished in hand

¹ *Or.* 64 R. 338 (Dind. ii. 213).

² Herod. vii. 56.

and heart and to be free from an evil conscience.'¹ Something similar was inscribed on the temple of Asklepios at Epidauros.² The *objectif* of the earlier Hellenic polytheism was the city, the tribe, the family: that of the later was the individual soul. The earlier religious morality looked rather to works and practice, the later rather to purity and faith. The gradual divorce of religion from the political life was a loss which was not repaired for many centuries; but it was compensated by the rise of a humanitarian spirit, which was to be infused into a new cosmopolitan religion.³

The above is only a panoramic sketch, indicating the various elements of a singularly manifold religious system. It has been impossible to touch on all the special points of interest, such as divination and the minutiae of ritual and of the festivals; for these the student must consult special articles and treatises. The object of this article has been to present the main essential features in a chronological survey, and to assign to each its significance and relative importance. The history has been adumbrated of a religion that maintained itself for at least two thousand years on the higher plane of polytheism; a religion which, while lacking the sublimity and moral fervour of some of the Oriental creeds, made certain unique contributions to the evolution of society and the higher intellectual life of man. By the side of the higher growths many of the products of lower and savage culture were maintained which were mainly obliterated by Christianity. It is necessary to note and appreciate these lower facts; but there is a risk of overestimating their importance and vitality. Many of them are found in all higher religions, usually in a moribund state. It is its higher achievement that makes any particular religion of importance in the history of civilization; and we are now aware that Greek religion can claim this importance. Nor can the lower elements as a whole be shown to have generated the higher within the Hellenic period proper. We cannot show the evolution of the personal anthropomorphic deities of Greece from magic ritual or totemism or theriomorphism, without transcending the chronologic limits of the period within which it is allowable to speak of a Hellenic people at all. Some modern anthropology applied to classic life is seriously anachronistic. The emergence of personal gods, from whatever region or by whatever influence they emerged, is an event of very primitive history. At least we know that of the two populations whose blending made Hellenism—the indigenous Mediterranean and the Northern or Central-European invader—the former possessed a personal theism of dateless antiquity; while all the evidence points to the conviction that the Aryan tribes entered Greece with certain personal deities already evolved or acquired. We find that anthropomorphism was the strongest bias of the Hellene's religious imagination; and with this we associate his passion for idolatry and hero-worship. It is interesting for the student of Hellenic Christianity to note the influence of these tendencies on the later history of the Greek Church; and generally it has been the result of much modern research to expose the truth that the indebtedness of Christian dogma and ritual to the later Hellenic paganism was far greater than used to be supposed.

LITERATURE.—Older works such as F. Welcker's *Gr. Götterlehre*, 3 vols., Leipzig, 1857-63, and L. Preller's *Gr. Mythol.*, 2 vols., ed. C. Robert, Berlin, 1887-94, are mainly useful now for their collection of facts.

Recent literature: O. Gruppe, *Gr. Culte und Mythen in ihren Beziehungen zu den orient. Religionen*, Leipzig, 1887, *Gr. Mythol. und Religionsgesch.*, vol. i., Munich, 1906; L. R. Farnell, *Cults of the Greek States*, 5 vols., Oxford, 1896-1910; P. D.

¹ *CIG (Ins. Mar. Aeg.)* i. 780.

² See Farnell, *Evolution of Religion*, p. 138.

³ See Farnell, *Higher Aspects*, Lect. vi. 'Personal Religion in Greece.'

Chantepie de la Saussaye, *Lehrb. der Religionsgesch.*³, Tübingen, 1906, Greek section; J. E. Harrison, *Proleg. to the Study of Greek Religion*, Cambridge, 1903, *Themis, a Study of the social Origins of Greek Religion*, do. 1912 (both works dealing with special questions and the more primitive aspects of the religion).

Treatises on special cults and special questions; separate artt. in Roscher, *Ausführliches Lexikon der griechischen und römischen Mythologie*, Leipzig, 1884-1911; Pauly-Wissowa, *Realencyclopädie der classischen Altertumswissenschaft*, Stuttgart, 1894 ff., and Daremberg-Saglio, *Dict. des antiquités grecques et romaines*, Paris, 1873-1911; G. Showerman, *The Great Mother of the Gods*, Madison, Wis. 1901; J. G. Frazer, *Atthis, Adonis, Osiris*², London, 1907; A. Dieterich, *Mutter Erde*, Leipzig, 1905; S. Eitrem, *Hermes und die Toten*, Christiania, 1909; W. Immerwahr, *Die Kulte und Mythen Arkadiens*, Leipzig, 1891; S. Wide, *Lakonische Kulte*, do. 1893; H. Usener, *Götternamen*, Bonn, 1896; cf. paper on his theory in *Anthropological Essays presented to E. B. Tylor*, Oxford, 1907, 'The Place of the "Sonder-Götter" in Greek Polytheism,' by L. R. Farnell; M. W. de Visser, *De Græcorum Diis non referentibus speciem humanam*, Leyden, 1900; E. Fehrle, *Die kulturelle Keuschheit im Alterthum*, Giessen, 1910 (cf. L. R. Farnell, *Evolution of Religion*, London, 1905, Lect. iii. 'The Ritual of Purification'); Th. Wächter, *Reinheitsvorschriften im gr. Kult*, Giessen, 1910; C. Ausfeld, 'De Græcorum precatationibus quæstiones,' in Fleckeisen's *Jahrbuch*, Supplement, Leipzig, 1903 (cf. L. R. Farnell, *op. cit.*, Lect. iv. 'The Evolution of Prayer'); S. Reinach, various artt. on Greek cults and myths, in *Cultes, Mythes, et Religions*², 3 vols., Paris, 1904-08.

For Eschatology, Mysteries, Thiasoi, Hero-worship: C. A. Lobeck, *Aglaophamus*, 2 vols., Königsberg, 1829; E. Rohde, *Psyche*², Freiburg and Tübingen, 1898; A. Dieterich, *Nekyia*, Leipzig, 1893, also *Eine Mithrasliturgie*, do. 1903; K. H. E. de Jong, *Das antike Mysterienwesen*, Leyden, 1909; Goblet d'Alviella, *Eleusinia*, Paris, 1903; P. Foucart, *Les grands Mystères d'Eleusis*, Paris, 1901 (in *MAIBL* xxxvii.); H. G. Pringsheim, *Archäol. Beiträge zur Gesch. des eleus. Kults*, Munich, 1905; P. Foucart, *Des Associations religieuses chez les Grecs*, Paris, 1873; L. Weniger, *Ueber das Collegium der Thyiaden*, Eisenach, 1876; F. Deneken, art. 'Heros,' in Roscher; E. F. Pfister, *Der Reliquienkult im Alterthum*, Giessen, 1910.

For Greek ritual and festivals: A. Mommsen, *Feste der Stadt Athen im Alterthum*, Leipzig, 1898; P. Stengel, *Die gr. Kultusaltertümer*², in Iwan von Müller's *Handbuch*, vol. v., Munich, 1898, also *Opferbräuche der Griechen*, Leipzig, 1910; H. v. Fritze, *Die Rauchopfer bei den Griechen*, Berlin, 1894; L. R. Farnell, 'Sacrificial Communion in Greek Religion,' *HJ* ii. (1904) 306 ff.; M. P. Nilsson, *Gr. Feste*, Leipzig, 1900, *Studia de Dionysia Attica*, Lund, 1900; P. Foucart, *Le Culte de Dionysos en Attique*, Paris, 1904; A. Thomsen, 'Der Trug des Prometheus,' *ARW*, 1909; W. H. D. Rouse, *Gr. Votive Offerings*, Cambridge, 1902; A. Bouché-Leclercq, *Hist. de la divination*, 4 vols., Paris, 1879-81; W. R. Halliday, *Greek Divination*, London, 1912; L. Deubner, *De Incubatione*, Leipzig, 1900; E. Samter, *Geburt, Hochzeit, und Tod*, do. 1911.

For Greek religious thought and speculation: L. Campbell, *Religion in Gr. Literature*, London, 1898; E. Caird, *Evolution of Theol. in the Gr. Philosophers*, 2 vols., Glasgow, 1904; J. Adam, *The Religious Teachers of Greece*, Edinburgh, 1908; P. Decharme, *La Critique des traditions religieuses chez les Grecs, des origines au temps de Plutarque*, Paris, 1904.

Epigraphic material: *CIG* (passim); special collections of inscriptions bearing on Greek religion: W. Dittenberger, *Sylloge*², Leipzig, 1901, vol. ii. 'Res Sacrae'; I. von Prött and L. Ziehen, *Leges Græcorum sacræ e titulis collectæ*, do. 1896 ff.

Religious monuments: J. Overbeck, *Gr. Kunstmythologie*, Leipzig, 1871-87 (unfinished); L. R. Farnell, *CGS*; J. E. Harrison, *opp. cit.*; A. Baumeister, *Denkmäler des klassischen Alterthums*, Munich, 1885-88; Roscher; Daremberg-Saglio; C. Bötticher, *Über den Baumkultus der Hellenen und Römer*, Berlin, 1856.

L. R. FARNELL.

GREEK ORTHODOX CHURCH.—I. The name.—The term 'orthodoxy' (ὀρθοδοξία) is used to indicate the immutable conservation of the true Christian doctrine, as taught by Christ and the Apostles, and set forth in Holy Scripture and Holy Tradition, as against the divergence therefrom of heretics, which is heterodoxy (ἑτεροδοξία). In this sense the word is used as early as the 2nd cent. (e.g. in Clement of Alexandria). The appellation 'Orthodox' was applied in ancient times to the whole Church; but after the Western Church separated from the Eastern, it was appropriated by the latter, inasmuch as it was in the name of this faithfulness that it broke off the connexion with the Western Church, which has appropriated to itself the name 'Catholic.' Since the chief part in the Eastern Church was long taken by the Greek nation, very often, even in official documents, especially in the West, the name 'Greek Church' was used as a synonym for 'Orthodox Church'; but at the present time, when out of the 16 Ortho-

dox Churches only 5 are Greek, and out of the 106 million Orthodox people the Greeks number less than 8 millions, the appellation has become an anachronism. A more convenient appellation is 'Eastern Church,' so far as it denotes her geographical position, and brings out the idea that the 'Orthodox' Church does not make up the whole Christian Church; but even this without the addition of 'Orthodox' is inexact, as the term 'Eastern' may as justly be applied to the Nestorian, Monophysite, and other Churches.

2. History.—The history of the Orthodox Church falls into four periods, each division being marked by an event which defined its character for the whole period, viz. in the first three centuries the initial development; in the 4th cent. the recognition of Christianity as the State religion (A. D. 313); in the 9th cent. the completion of the Orthodox system of dogma (843), together with the beginning of the separation of the Western from the Orthodox Church, and the adhesion of the Slavic peoples to the latter; in the 15th cent. the subjugation of the Græco-Slavic world by the Turks, completed by the capture of Constantinople in 1453.

(1) *The early period.*—The very first days of Christianity were marked by the invitation to the Hellenes to accept it, and the Christian Church of the first two centuries was a Church of the Greeks. Even in Rome the Christian community was Greek, both in composition and in language. The missionary activity of the Church was wider and more successful in the regions in which the influence of Hellenism had spread. The Books of the NT, as well as the first productions of Christian theology, were written in the Greek language. It was the Greek Churches that developed the idea of the Logos, the doctrine of the Person of Christ, of the Holy Trinity, and the like; it was they that introduced order into the life of the Church, and created a Christian terminology which was accepted everywhere; it was they that gave birth to Christian Apologetics. Church discipline in this period was regulated partly by local councils, partly by collections of rules of private origin (*Didascalía*). The external history of the period is characterized by the hostile attitude of the pagan State towards the Church, which found expression in the persecutions. The tendencies of the Roman Church are in this period very slightly noticeable, so that the history of Orthodoxy almost coincides with that of Christianity.

(2) *From A. D. 313 to 843.*—After Christianity had been recognized as the State religion, the Greek Church elaborated the normal relations between Church and State, being guided by the principle of *symphonia* and an adaptation of the Church organization to that of the State, according to which the diocesan bishops were subordinated to the bishops of the chief towns, or *metropoleis*, i.e. to the Metropolitans, and these in their turn to the bishops of the capitals of the 'dioceses' established by Diocletian, these bishops receiving the titles of Archbishops, Exarchs, and Patriarchs. Such at first were the bishops of Antioch, Cæsarea in Cappadocia, Ephesus, Heraclea (capital of the Thracian 'diocese'), and Alexandria; in the last case the bishops were all directly under the Patriarch, without the intervention of Metropolitans. Finally, the Patriarchate of Constantinople took a special place among them, the city having become the permanent residence of the Emperor from the time of Theodosius I. Constantinople had originally been subordinate to the Metropolitan of Heraclea, the capital of the 'diocese,' but the second Ecumenical Council (canon 3), at Constantinople in 381, gave the bishop of the latter precedence (προσβεία τῆς τιμῆς) next after the bishop of Rome, as being bishop of 'New Rome'; and in

A. D. 451 he had put under him, by the 28th canon of the Council of Chalcedon, the 'dioceses' (provinces) of Heraclea, Ephesus, and Cæsarea, and gained a position second to Rome, but superior to Alexandria, Antioch, and Jerusalem. He had authority over all Asia Minor, and in Europe over Thrace, from the beginning, and later, in A. D. 730, after long controversy with Rome, over Illyricum Orientale, i. e. the countries south of the Danube, together with Dalmatia, Epirus, Greece, and Crete. To him also were assigned, by the 28th canon of the Council of Chalcedon, 'all other tribes' as well (*ἄλλοφύλοι*); and this became a matter of great importance from the time of the conversion of the Slavs to Christianity, when by 'other tribes' they began to mean peoples living outside the limits of the Empire. About A. D. 500 the Patriarch of Constantinople received the title of 'Ecumenical' (*ὁ οἰκουμενικός*), i. e. the Patriarch standing at the head of the whole (Eastern) Empire.

With the elaboration of Church organization, Church life reached a very high development. The lively intercourse between the Churches allowed the seven Ecumenical Councils to settle definitions of a dogmatic and canonical character in the name of the Universal (Ecumenical) Church; Theology in its various branches—Dogmatics, Church History, Exegesis, Apologetics, polemics, sermons, etc.—supplies admirable examples. There arose the heresies of the Arians, Macedonians, Monophysites, Monothelites, with their ramifications, and then that of the Iconoclasts, which gave rise to debates in which part was taken by the people, by monks, and by the civil power; but the Councils made clear and settled the doctrine of the Church, and excommunicated those who did not receive it. This resulted in the formation of the Eastern non-Orthodox Churches—Nestorian, Monophysite (Coptic, Jacobite, and others), and Monothelite (Maronite). The completion of this dogmatic work of the Councils was reached by the Council which met in Constantinople on 11th March 843, confirmed the definitions of the seven Ecumenical Councils, and secured the triumph of Orthodoxy with the excommunication of the heretics. See COUNCILS AND SYNODS (Chr.).

The Councils also settled the rules of Church discipline; but side by side with these rules there now appeared a new source of ecclesiastical law in the decisions concerning the Church emanating from the civil power as collected at the end of the *Codex Theodosianus* (A. D. 438), and at the beginning of Justinian's Code (A. D. 534), and supplemented by numerous Imperial novels.

There appeared also collections of regulations made by the Councils, and afterwards of civil regulations made by the secular power concerning the Church, and, finally, collections uniting both elements. Of the latter, the greatest importance attached to the *Nomocanon*, in 50 and 14 Titles (best ed. by J. B. Pitra, *Juris eccles. Græcorum historia et monumenta*, Rome, 1868, ii. 433 ff.). The theory of the *symphonia* between Church and State was given a very wide extension, which showed itself, on the one hand, in interference by the Emperor in Church affairs, in particular as concerning its property, in the election of bishops, in the summoning of Councils, and even in the publication of statements concerning the formulæ of the Creeds; and, on the other hand, in the action of the Church upon the civil laws and administration. Bishops had the right of supervision even over the civil administration of their cities, the right to sit in judgment, and to give protection to the poor (*personæ miserabiles*); and sometimes they are found as rulers of the people (*δήμαρχοι*), and even received royal honours.

Church property increased, and Christian phil-

anthropy, under the protection of the State, assumed great importance. Monasticism, which had already made its appearance at the end of the first period, spread widely in Egypt, Palestine, Syria, Armenia, and Asia Minor. At first each monastery was managed under its own rules; but later in the Church of Constantinople the rule of St. Basil the Great, and in that of Jerusalem the rule of St. Sabbas the Consecrated, became dominant. Church Services also became more complicated. There came into use bells, incense, and candles; there appeared splendid examples of Church poetry; festivals and fasts were established; ecclesiastical art elaborated forms of its own (the Byzantine style), including a surpassing technique (mosaic), the examples of which, e. g., St. Sophia at Constantinople, remain unapproachable to this day. Orthodoxy spread beyond the limits of the Empire to Ethiopia, Iberia (Georgia), Persia, Armenia, among the Goths, Abasgi, Alans, Lazi, and other Caucasus tribes; and in India, China, and Arabia among the Saracens. Only in the second half of the period does the region over which it dominated begin to be narrowed by the spread of the Monophysites and the conquests of the Arab Musalmāns.

Within the Empire the battle with the remains of paganism went on, special zeal being shown by Theodosius I., Theodosius II., and Justinian.

(3) *From 843 to 1453.*—The reasons for the separation of the Western Church are very numerous and very complicated. Already in the 3rd cent. the Roman Church had become latinized, and was acquiring a special character on account of its position in the centre of the whole State and the influence exercised upon its theology by Roman juristic thought. The division of the Empire into two parts, Eastern and Western, prepared the way for the differentiation of their Churches. The weakness of the Western Empire, its fall, the great migrations, and the flood of barbarous peoples gave cause enough for the relation of Church and State in the West to assume a different form, and for the Popes to take upon themselves the part of representatives and defenders of the Roman ideals in civilization and politics. This is the basis of the misunderstandings which began to arise with the Eastern Church, especially with that of Constantinople, and these passed into disputes which finally ended in complete disruption. Rome rejected the 28th canon of the Council of Chalcedon, which conferred upon the Patriarch of Constantinople powers equal to the Pope's. From A. D. 484 to 519 relations between Rome and Constantinople were broken off because of the Monophysite dispute. Under Pope Gregory the Great a dispute about the title 'Ecumenical' began. Certain canons (nos. 1, 2, 3, 6, 12, 13, 36, 55, 67, 82 of the 'Quinisext' Council in *Trullo*) which condemned Western practice were not received in the West. In the Frankish Empire there arose the question of the *Filioque*, and the decisions of the 7th Ecumenical Council as to the honouring of icons were rejected. The question of the Papal territory which began in A. D. 787 was ended in A. D. 800 by the coronation of Charles the Great. Out of the 530 years of the second Period (A. D. 313–843) relations between Rome and Constantinople were interrupted during a total of 228 years. The affair of Photius and Ignatius, in which Pope Nicholas I. interfered (861), ended in the heads of the two Churches reciprocally excommunicating each other. In consequence of the insertion of the *Filioque* into the Creed and the exacerbated personal relations, the Roman peculiarities in ritual—fasting on Saturday, celibacy of the clergy, and the like—are in Photius' Epistle (A. D. 866) quoted as evidences of Rome's defection from Orthodoxy, the only defender of which was now to be found in the

Eastern Church. After the second deposition of Photius in 886, the name of the Pope was again inserted into the Diptych of the Eastern Church. At the beginning of the 10th cent. relations once more became strained over the question of the fourth marriage of the Emperor Leo the Philosopher, which after his death was condemned at the Council of A.D. 920.

In 1017 the *Filioque* was officially recognized at Rome, and in 1053 the Patriarch Michael Cerularius, dissatisfied with a plan of political alliance with the Pope, dispatched, in conjunction with the Bulgarian Archbishop Leo of Ochrida, an epistle to Bishop John of Trani, in which new accusations (unleavened bread) were added to those brought against the Pope by Photius, and the dispute which arose ended on 16th July 1054 in the excommunication of the Patriarch by the Papal Legate and the final erasure of the Pope's name from the Diptychs. Attempts at reunion of the Churches went on until the end of the period: in 1099, at the Council of Bari under Alexis I. Comnenus and Pope Paschal II. (1099-1118), under John Comnenus (1118-43), under Manuel Comnenus (1143-80), in 1232, 1250, 1274 at Lyons, in 1339 at Avignon, in 1369 at Rome, in 1439 at Florence. These were not successful, inasmuch as they were undertaken from motives not directly concerned with reunion—on the part of the Popes for the sake of increasing the area subject to their power, on the part of the Orthodox to obtain the political support of the West.

For the Musalmān conquest of the Patriarchates of Antioch, Alexandria, and Jerusalem in the 6th and 7th centuries, and the defection of the Western Church in the 9th-11th centuries, the Orthodox Church found compensation in the conversion to Orthodoxy of the populous Slavic nations in the 9th and 10th centuries. These nations formed national Churches, at first remaining dependent upon the Church of Constantinople, but afterwards forming temporarily or permanently independent (autocephalous) Orthodox Churches.

So in A.D. 864-65 the Bulgarians and the Serbs at almost the same time submitted to baptism, and in A.D. 988 the Russians. This addition, however, while increasing the number of the members of the Orthodox Church, did not stimulate any great improvement of her internal condition, partly because among the newly converted nationalities education was in a rudimentary condition, but principally because of the pressure of Mongolian nationalities from Asia. The Russian Church from A.D. 1224 to 1480 was under the yoke of the Tatars. The Church of Constantinople from the 11th cent. onwards suffered first from the Seljuk Turks, and at the same time from the Crusaders; in the 13th cent. (A.D. 1204-61) from the Crusaders who had gained possession of Constantinople; and from the 14th cent. from the Ottoman Turks. In 1361 the latter conquered Serbia, in 1393 Bulgaria, in 1453 Constantinople, in 1571 Greece, and finally in 1669 Crete, so that only one Orthodox Church was left in liberty—that of Russia.

The internal life of the Orthodox Church during this period is characterized by the decay of theological thought and of Church education. The questions in dispute were more matters of detail. The Church was chiefly disturbed by the struggle of the partisans of 'accommodation' (*οικονομία*), i.e. the permissibility, for the sake of higher ends, of making certain relaxations or exceptions from the ecclesiastical laws against the partisans of *acribia* (*ἀκριβεία*), i.e. the exact observance of the same. These disturbances arose under Patriarch Tarasius (A.D. 787-806), and continued, with interruptions, until the 13th century. On the side of *acribia* stood the monks, the defenders of the Church's independence, while 'accommodation' was de-

fended by the civil power and the secular clergy. The defenders of the former bore at various times the names of Ignatians, Nicolaites, Zealots, and Arsenians; the defenders of the latter were called Photians, Euthymians, and Politici. The struggle ended in the triumph of the former. The heresies of the period either exhibit a mystic character (Paulicians, Euchites, or Enthusiasts), or appear to be the result of Parsi influence (the *Arevurdik'*, or 'sons of the sun,' in Armenia) and Judaism (*Athingani* in Phrygia). Later on, under Alexis Comnenus in the 11th cent. we have the heretical teaching of John Italus as to the manner of the union of the two natures in Christ; at the Councils of A.D. 1156-58 at Constantinople the question discussed concerned the signification of the sacrifice of the Cross; at the Council of A.D. 1166 that of the meaning of Jn 14²⁸; and in the middle of the 14th cent. the more serious controversies of the Barlaamites and Palamites or Hesychasts (1320-51) on the relation of the energy of the Deity to His essence, and on the light of Tabor. The organization of the Church suffered hardly any changes during this period. The canons established at the Councils were concerned only with particular questions. Certain new Collections of Ecclesiastical laws appeared, but the chief importance attached to the *Nomocanon* in 14 Titles as revised about A.D. 883 by the Patriarch Photius. In the 11th-12th centuries were written the commentaries on the canons by Zonaras, Aristenus, and Balsamon; and in the 14th cent. a guide to ecclesiastical law in the *Hexabiblos* of Constantine Armenopoulos, and the alphabetic *Syntagma* of Matthæus Blastares. Among the Slavs there appeared their own Collection of Canons adapted from the Greek—the *Kormchaia Kniga* ('The Steersman's Book'), in its four redactions, Bulgarian (9th cent.), Slavo-Russian (10th cent.), Servian, and Sophian (13th cent.).

Canonically the ecclesiastical organization remained unchanged, but *de facto* the Emperors interfered more often in Church affairs, and appropriated the title of 'Holy,' and the right of deciding questions of dogma; and, on the other hand, the Constantinopolitan Patriarch's primacy of honour passed (in fact, not in theory) into primacy of power.

But the attempt to supply a dogmatic foundation for the extension of the Emperor's power in the Church and the power of one Patriarch over the others did not obtain recognition in the Church. The Patriarch had now about him a new organization, the permanent Synod (*σύνδος ἐνδημοῦσα*), consisting of bishops and patriarchal officials, and having the authority of a final, highest administrative, and judicial court. About the Patriarch there was formed a whole staff of officials ('the nine pentads'). Enormous influence on the life of the ecclesiastical community was exercised by the monasteries, especially those on Mt. Athos, the Stadium at Constantinople, the *Μέγα Σπήλαιον* in the Peloponnese, the Meteora in Thessaly, etc. They stood up for the exact observance of dogmas and canons and for ecclesiastical independence, supported the science of theology, spread education abroad, and sent out missionaries. The education of the clergy, which had declined at the end of the preceding period, in the middle of the 9th cent. recovered and attained a higher level under the Comneni in the 12th century. In the 13th cent., at the time of the Latin domination, Byzantine learning again declined; but in the 14th cent., under the Palæologi, it once more revived, though during the whole third period (as against the second period) it suffered from a want of originality. This movement, moreover, was not disregarded by the newly converted Slavic nationalities.

(4) *From 1453 to the present day.*—After the taking of Constantinople (29th May 1453) the Orthodox Church within the boundaries of Turkey retained its internal organizations without any substantial change, but the Patriarch of Constantinople, in his capacity of 'head of a nation' (*Millet-bashi*), received also civil authority over all Orthodox people. By this increase of authority, however, neither the Patriarch himself nor his flock was in the very least guaranteed against the violence of the conquerors, who regarded the *raya* as without rights and a mere source of income. The Patriarchs were forced to pay taxes beyond their resources, both at their election (*pishkesh*) and year by year (*kharādzh*). Vacancies occurred extremely often, and few Patriarchs ended their days on the throne (30 out of 103). Many were elected several times. Still worse was the position of the rest of the clergy and of the lay people, who suffered from the fanaticism of the Turks, and contributed no small number of martyrs for the faith canonized by the Church. There were martyrs also among the Patriarchs. The internal life of the Church was uneasy too by reason of the struggles of candidates for the Patriarchate and the interference with ecclesiastical affairs of the Phanariots, or rich and distinguished laymen living in Phanar (a quarter of Constantinople), who, on account of their knowledge, enjoyed influence with the Government. Some trouble resulted from the institution under Patriarch Samuel (1764–80) of the *gerusia*, an ecclesiastical oligarchy consisting of the six senior bishops and four lay Phanariots, which was abolished in 1858. It was not until the 19th cent. that the position of the Orthodox Church was improved (Khatt-i-sharif, 2nd [14th] Nov. 1839, and Khatt-i-humāyūn, 18th Feb. [1st March] 1856). The Turkish Constitution (14th [27th] April 1909) did not bring the anticipated advantage to the Church, and an attempt was even made to deprive the Patriarchate of its ecclesiastical privileges.

Taking advantage of the sad position of the Orthodox Church, the Popes tried to subject it to their power, and with that intent dispatched several epistles and sent a whole army of missionaries to the East. Success crowned these attempts in one region only, S.W. Russia, thanks to political circumstances. There the Jesuits succeeded in establishing the Union of Brest in 1596. The Patriarch Gregory VI. refused to accept an invitation to the Vatican Council. To Leo XIII.'s Bull on the Reunion of the Churches (20th June 1894, *Præclara gratulationis*) the Ecumenical Patriarch Anthimus VII. answered on 29th Sept. by an epistle enumerating the errors of the Roman Church. Negotiations as to union with Protestants were also unsuccessful: in 1559 between Melancthon and the Patriarch Joasaph II., in 1576–81 between the Lutherans of Tübingen and Patriarch Jeremias II., and in 1731 the attempt of Zinzendorf. Great trouble was caused by the attempt made by Cyril Lucar, who was Patriarch seven times (1612–38), to approximate Orthodoxy and Calvinism. More success has attended the attempts which are still going on to make a *rapprochement* with the Anglican Church. They were begun in 1716–25 by the party of the Non-jurors, and renewed in 1862 by the adherents of the Oxford movement. So far they have led only to the establishment in 1899 of *ἐπικοινωνία* between the Constantinopolitan and the Anglican Churches, that is, to permission given to laymen of one Church in special cases of extreme necessity to have recourse to the clergy of the other, and to an end being put to proselytizing. Negotiations, likewise still in progress, for reunion with the Old Catholic Church, which were begun soon after the establishment of the latter (Conference of Bonn, A.D. 1874), have led to no results.

The weakening of Turkey during the 19th cent. led to the process, still at work, by which the Orthodox nationalities are being freed from her yoke, and they have formed the independent States of Montenegro, Greece, Servia, Rumania, and Bulgaria.

With the diminution of Turkish territory has proceeded the diminution of the territory subject to the Patriarchs of Constantinople, as it appeared unsuitable that the new States should continue in ecclesiastical dependence upon a Patriarch who was a Turkish subject. Autocephalous Churches have also been formed by the Orthodox nationalities of Austria-Hungary. Side by side with this the importance of the Greek nationality is lessening. At the end of the 18th cent. in all Orthodox Churches except the Russian and the Montenegrin the hierarchy was Greek. At the present time the Churches remaining Greek are the Constantinopolitan, Alexandrian, Hellenic, Cyprian, and Sinaitic. In the Church of Jerusalem the struggle of the Arabic population against the power of the Greek Brotherhood of the Holy Sepulchre has already been crowned with decided success. The unwillingness of the Greeks to give up their ecclesiastical privileges, which raised them above the other nationalities, gave rise to the schisms of Antioch and Jerusalem, now satisfactorily settled, and to the more serious Bulgarian schism.

In the Greek Church a new Collection of Canons has appeared, viz. the *Πηδάλιον*, compiled in 1793 by the Athos monks Nicodemus and Agapius, and in the Rumanian Church the Collection *Indreptarea Legii*. Both are modifications of the Slavic *Kormchaia*. In the Russian Church the *Kormchaia* ceased to be the source of law still in force, and was superseded in the 19th cent. by the *Book of Canons*, in which a place is given only to the minimum of canonical rules accepted by the whole Orthodox Church: the 85 Apostolic Canons, the Canons of the Seven Ecumenical and eleven Local Councils, and extracts from the canonical works of the thirteen Holy Fathers. There have also been published editions of canonical documents, among which special importance attaches to the so-called Athenian Syntagma (G. A. Rhalles and M. Potles, *Σύνταγμα τῶν θείων καὶ ἱερῶν κανόνων*, Athens, 1852–59; M. I. Gedeon, *Κανονικαὶ Διατάξεις . . . πατριαρχῶν Κωνσταντινουπόλεως*, Constantinople, 1888–89).

3. *Present condition and geographical distribution.*—At the present time the Orthodox Church consists of 16 Orthodox Churches of which 5 are Greek: those of Constantinople, Hellas, Cyprus, Alexandria, and Sinai (in all 7,200,000 souls); 7 Slavic, viz. those of Russia (116 millions in 1911), Bulgaria, Servia, Carlowitz, Bosnia-Herzegovina, Bukovina with Dalmatia, and Montenegro (9,920,000); 2 Rumanian, that of the Kingdom of Rumania and that of Hermannstadt in Austria (about 6 millions); and 2 Arabic, Antioch and Jerusalem (some 380,000). The ancient Church of Georgia (1,300,000 souls) now officially forms part of the Russian Church (*q.v.*).

Accordingly, the number of all the Orthodox Churches together amounts to 134 millions. All these Churches are autocephalous, *i.e.* independent of each other as regards internal administration, but make up one Orthodox Church, as they have one Head in Christ, and possess one doctrine and communion in sacraments and services. The communion between them also finds expression in Councils, the decisions of which are obligatory for the Churches that take part in them, or in the interchange of epistles. Both the Councils and the exchange of epistles take place rather seldom, and not regularly, mainly owing to political circumstances

(a) **GREEK CHURCHES.**—(1) *The Constantinopolitan Patriarchate* is bounded by the frontiers of Turkey, but even within these limits the Orthodox Bulgarians are subject to the authority of the Bulgarian Exarchate. Exact statistics do not exist, but the most likely number for the Orthodox of the Patriarchate is 2½ millions in Europe, and 2 millions in Asia Minor and the Islands. At the head of the Patriarchate stands the Patriarch (since 28th Jan. [10th Feb.] 1913, Germanus V.) with the title of 'His All-holiness (Παναγιώτης), the Archbishop of Constantinople the New Rome, the Ecumenical Patriarch.' He has precedence over all Orthodox hierarchs throughout the world. The Patriarchs in the Turkish Dominions communicate with the Government through him. He has two governing bodies—the Synod and the Mixed Council. According to the Constitution of A.D. 1862, the Holy Synod (Ἱερά Σύνοδος) consists of 12 Metropolitans, half of whom retire in rotation every year. The Permanent National Mixed Council (Διαρκές Ἐθνικὸν Μικτὸν Συμβούλιον) consists of 12 members, 4 Metropolitans, and 8 laymen who retire at the same periods as the members of the Synod. The sphere of the Synod's activity is of a spiritual character; that of the Council relates to affairs of a civil and economic character—schools, hospitals, almshouses, looking after the Church finances, questions of legitimizing children, of testamentary dispositions, contracts, etc. Besides the Synod and the Council, the Patriarch has a large number of secondary organs of administration: the central ecclesiastical Epitropia, the pædagogic Epitropia, the Epitropia of episcopal property, the financial Epitropia, the Ecclesiastical Court of Justice, the Notary's office, the Ottoman Chancery, and a whole series of officials both spiritual (for example, the Chief πρωτοσύγκελλος, the Chief Archdeacon, and such like) and secular (as the Chief Logothete, etc.). In the Patriarchate there are numbered 78 Metropolitan sees, of which 4 are in the semi-independent Bosnia and Herzegovina. The dioceses (ἐπαρχίαι) are ruled by Metropolitans. Some Metropolitans have bishops subordinate to them, e.g. the Metropolitan of Crete has 7 suffragans, the Metropolitan of Ephesus 6, the Metropolitan of Thessalonica 5, and so on. The dependence of certain Metropolitan sees in Bosnia and Herzegovina and of the Metropolitan of Crete is purely nominal. The organ of the Patriarchate is the journal Ἐκκλησιαστικὴ Ἀλήθεια. The higher clergy receive their education in a school on the island of Chalki, in the Sea of Marmora not far from the Bosphorus (since 1844), the inferior clergy in the Seminaries at Cæsarea in Cappadocia, on the Isle of Patmos (since 1713), and on Mt. Athos (since 1899). The authority of the Patriarchate also extends to secular schools.

(2) *The Church of Hellas* was proclaimed independent of that of Constantinople at a Council of 36 bishops at Nauplia, 15th [29th] June 1833, but in Constantinople it was recognized as autocephalous only in a decision of the Synod on 11th [23rd] July 1850. Now the Church of Hellas is governed by a Synod modelled on the Russian Synod, and consisting of the President, the Metropolitans of Athens, and 4 diocesan bishops, who change every year. In purely spiritual matters the Synod is independent; in affairs of a mixed character it has to obtain the approval of the civil power. Its decisions gain the force of law on being signed by the king's Commissioner. There are 32 dioceses in all, including 4025 parishes and 1,922,000 souls. Together with the Greeks of the Diaspora, who have since 1908 been reckoned as under the authority of the Athenian Synod, they amount to 2,400,000. In 1908 there were in Greece one Metropolitan (at present Theoclitus), 6 arch-

bishops, 25 bishops, 167 men's monasteries with 1743 monks, and 10 convents with 225 nuns. The yearly income of the monasteries amounted to 2 million drachmæ, the value of their property to 60 million drachmæ. Higher theological training is received by the clergy in the theological faculty of the University of Athens, secondary instruction in seminaries—the Rhizarion at Athens, one at Arta, and one at Tripolis. The chief clerical journal is the Ἱερός Σύνδεσμος, published by the league of that name. On 15th [28th] Jan. 1910 a 'law' was published with regard to Parish Churches and their property, the qualifications of parish priests and their stipends, and on 1st [14th] Feb. 1911 a supplementary 'law' as to a central Church treasury and the administration of the monasteries.

(3) *The Cyprian Church* was recognized as autocephalous as early as the Council of Ephesus in A.D. 431. In recent times it has occasionally been subject to the influence of other Patriarchates, but formerly its autocephaly had always been recognized. At its head stands the Archbishop (at present Cyril), who bears the title of 'the Most Blessed the Archbishop of Justiniana Nova and of all Cyprus,' and lives at Nicosia. His suffragans are the bishops (Metropolitans) of Paphos, Citium, and Cyrenia. The Archbishop and the Bishops make up the Synod which administers the Church of Cyprus. In the election of the Archbishop the lower clergy and the people have their part. In April 1911 the Orthodox in the island amounted to 182,737; and there were 607 churches and 79 monasteries. At Larnaca there has been a seminary since 1910, and a journal is published, Ἐκκλησιαστικὸς Κήρυξ.

(4) *The Patriarchate of Alexandria*, founded, according to tradition, by St. Luke, included in the 4th cent. Egypt, the Thebaid, Libya, and the Pentapolis, and had more than 100 dioceses. In the 5th cent. Monophysitism spread in this region. In A.D. 638 it fell under the power of the Arabs. In the 18th cent. the patriarchs lived in Constantinople. Now it has an extremely small population. The Greeks put the number at 150,000, but, as a matter of fact, it does not reach 100,000. It is governed by the Patriarch (at present Photius), who bears the title of 'the Most Blessed Patriarch of Alexandria and all the land of Egypt, of the Pentapolis and Pelusium, of Libya and Ethiopia,' and lives in Cairo. In the Patriarchate there are (1st Jan. 1913) 7 dioceses, 5 monasteries, 31 parishes, and 55 churches. The Bishops with the Patriarch form the Synod. In Alexandria two clerical journals are published, the weekly Πάνταϊος and the monthly Ἐκκλησιαστικὸς Φάρος. In 1908 a diocese was founded in Abyssinia (Χαρτούμ).

(5) *The Church of Sinai* consists of no more than the monastery on Mt. Sinai, built in A.D. 527 by Justinian. The monastery received autocephaly by a decision of the Council of Constantinople in 1575, which ended a controversy between Alexandria and Jerusalem as to which had authority over the monastery, by declaring it independent. The monastery is governed by the Hegumenos Archbishop, who bears the title of 'Archbishop of Mount Sinai and Raitha' (a village on the Red Sea) and 'all honourable,' and is consecrated by the Patriarch of Jerusalem (at present Porphyrius II.). The number of brothers is not more than a few dozen (now 50). At Cairo the monastery possesses a branch establishment (*metochia*) in which the Archbishop mostly resides; in his absence the monastery is governed by the 'Dikaïos.' The monastery is famous for its library, in which among other things was found the renowned 'Codex Sinaiticus.'

(b) *SLAVIC CHURCHES.*—(6) *Russian Church.*— See separate article.

(7) *The Bulgarian Church*, originated under King Boris in A.D. 865, was at first subject to the Patriarch of Constantinople, but very soon pretensions to authority over it were made by Rome. Under Czar Simeon it became independent and the Archbishop was raised to be a Patriarch, and this was recognized even by Constantinople in A.D. 945 under Czar Peter. Under Pope John (A.D. 1197-1207) a union with Rome was agreed upon, but it came to an end in 1232. The throne of the Patriarchs was successively at Dorostolum (Silistria), Sardica (Sophia), Vodena, Moglena, Prespa, and finally at Ochrida. In 1234 a second Patriarchate was founded at Tirnova. In the 14th cent. Bulgaria was conquered by the Turks, and soon after the Patriarchy of Tirnova was subordinated to Constantinople and ranked as a Metropolitan see. But the Archbishopric of Ochrida preserved its independence until 16th [27th] January 1767, when it also was united to the Patriarchate of Constantinople. When there was an awakening of the national self-consciousness of the Bulgars in the first half of the 19th cent., there began a struggle to be ecclesiastically independent of the Greeks, and this found its consummation in the declaration of March 10th [22nd] 1870, that the Bulgarian Church was autocephalous. This was recognized by the Sultan, but not by the Patriarch. In September 1872 a Council was held in Constantinople which pronounced the Bulgarians schismatics because they had based their scheme of ecclesiastical organization upon the principle of nationality (ethnophiletism). But the decisions of this Council were not recognized by the Slavic Churches, and therefore to this day the position of the Bulgarian Church remains undefined. It consists of two parts, of which one is in Bulgaria, vassal till 1908 and now independent; the other is in Turkey. Both parts are under the Exarch (at present Joseph), who resides in Constantinople and has a deputy in Bulgaria. At Sophia there is a Synod and since 1910 there has been one at Constantinople, each consisting of 4 Metropolitans. At Constantinople there is also (since 1910) a Mixed Council, consisting of the 4 Metropolitans together with 6 laymen. In Bulgaria there are 11 bishoprics (with 3,334,790 souls), in Turkey 9 with bishops. In 1909 there were in Bulgaria 214 town churches, 2056 village churches, 75 men's and 16 women's monasteries, 9 metropolitans, one bishop, 8 archimandrites, 22 œconomi, 1917 priests, 11 deacons, 5 archidiaconi, 49 hegumeni, 13 hegumenissæ, 52 hieromonachi, 68 monks, and 247 nuns. At Sophia there is a Clerical Seminary (about 150 students), and at Bachkou a school for priests. At Sophia is published the journal *Sovétnik* ('Counsellor'). The Turkish part of the Exarchate consists of 22 sees, but there are bishops only in half of them, the rest being governed merely by Diocesan Councils, consisting of 4 clerics and 5-7 laymen. In all the population amounts to 1,057,052 souls (1906). There are 1232 churches, and 51 monasteries. At Shishli near Constantinople there is a Clerical Seminary and at Usküb (Skoplje), a Priests' School. The authority of the Exarchate extends to the secular Bulgarian schools in Turkey. The organ of the Synod of Sophia is the journal *Tserkovny Vestnik* ('Ecclesiastical Messenger'), of the Exarchate, *Vésti* ('News'). The Bulgarian Church is governed according to the 'Regulation of the Exarchate' elaborated in 1883 and adapted to the kingdom in 1895. By the law of 1908 the clergy in Bulgaria receive their stipends from the State.

(8) *The Servian Church*, founded as far back as A.D. 867, gained its independence of the Patriarch

of Constantinople A.D. 1219, and under King Stephen Dushan (1331-55), a Patriarch was appointed with his throne at Ipek. The Patriarchate of Ipek extended over a wide area, and included Montenegro, Dalmatia, Bosnia, and Herzegovina. In 1375 its autonomy was recognized by Constantinople, but between 1386 and 1459 the whole Patriarchate fell under the Turkish yoke and was united to the Bulgarian Patriarchate of Ochrida. The Patriarchate of Ipek was re-established in 1557. In 1690, under the leadership of the Patriarch Arsenius, some 200,000 souls migrated to Hungary where they formed the Church of Karlowitz. On Sept. 11th [22nd] 1766 the Patriarchate of Ipek was once more abolished and its dioceses were until 1830 ruled by Greeks, bishops nominated from Constantinople. In 1832 the Servian Church, or rather a part of it, gained some independence, and in October 1879 full autocephaly. By the *Tómos synodikós* of 1879 the Church of the kingdom of Servia is governed by a Metropolitan (at present Demetrius) and 4 bishops in the towns of Zič, Timok, Niš, and Šabac, who form the Council of Bishops. At present the organization of the Church is regulated by the law of 27th April [7th May] 1890. In 1905 the Church of Servia numbered 2,735,147 souls, 5 dioceses, 651 churches, 71 chapels, 54 monasteries (men's), 887 parishes, and 1142 clergy. The clergy are educated in the Seminary of St. Sabbas at Belgrade. Several religious journals are published at Belgrade—*Glasnik Pravoslavne Crkvi* ('The Herald of the Orthodox Church'), the organ of the College of Bishops; *Vétnik Srpske Crkve* ('The Messenger of the Servian Church'), and *Pastyrska Reč* ('Pastoral Speech'), the organ of the secular clergy. In accordance with the law of 31st Dec. 1882 [12th Jan. 1883], the clergy are supported by payments made according to a tariff for services rendered.

(9) *The Karlowitz Servian Church* was formed of the 200,000 Serbs who in 1690 migrated from the Patriarchate of Ipek under the leadership of the Patriarch Arsenius III. Crnajević, in the time of the Austrian Emperor Leopold I. The immigrants were granted rights of ecclesiastical and civil autonomy, confirmed in 1791 by the Reichstag. Their dependence upon the Patriarchate of Ipek came to an end with the abolition of the latter in 1766. In 1848 the Metropolitan of the Karlowitz Church received the title of Patriarch from Francis Joseph. In 1864 the Church of Hermannstadt was cut off from it, and in 1873 the Bukovino-Dalmatian Church. Now the Karlowitz archbishopric contains over a million members, 7 dioceses, and about 800 parishes. At the head of the archbishopric stands the Metropolitan-Patriarch with the title of 'Holiness' (at present Lucian Bogdanovich), and at the head of the bishops of the 6 sees: Karlstadt, Pakrácz, Buda, Temesvár, Versecz, and Bács. Questions of dogma are decided by a Synod consisting of all the diocesans under the presidency of the Patriarch. The Patriarch is elected by a congress of Church and people held every three years, and exercising the right to decide all matters concerning the Church's autonomy. By the Regulation of Synod, 27th July 1911, and an edict of Francis Joseph published in June 1912, the rights of the congress have been restricted, while the power of the Hierarchy has been increased. The clergy are educated in the seminary at Karlowitz, established as long ago as 1792. The Archbishopric publishes a monthly journal, *Bogoslovski Glasnik* ('The Herald of Theology'). By the Law of 1869 the clergy were assigned a stipend, glebe, and a tariff of fees for occasional offices.

(10) *The Church of Bosnia and Herzegovina* has been *de facto* autocephalous since 28th March 1880, when an agreement was made between Austria and

the Patriarchate of Constantinople, though nominally it is dependent on the Patriarchate. Down to A.D. 1766 it was under the Patriarch of Ipek, and since then under that of Constantinople. It is divided into four dioceses (Sarajevo, Mostar, Dolnja-Tuzla, Banjaluka), governed by Metropolitan. In 1910 it numbered 825,418 members. At Reliev there is a Theological College at which candidates for the priesthood are educated. Since the beginning of 1912 there has been published at Sarajevo an organ of a league of secular clergy, the *Srpski Sveštenik* ('Servian Priest'); formerly the Archbishopric published *Istochnik* ('The Source'). The ecclesiastical organization is regulated according to a Code for Churches and Schools, published on 1st Sept. 1905 by the Austrian Government, according to which a stipend is assigned to the clergy.

(11) *The Bukovina-Dalmatian Church* consists of two parts, Zara and Bocca di Cattaro, the link between which is almost nominal—the Metropolitan see of the Bukovina and 2 dioceses in Dalmatia. The Metropolitan see is governed by the Archbishop of Czernowitz, who is Metropolitan of Bukovina and Dalmatia (at present Vladimir Repta), with his throne at the town of Czernowitz; and the dioceses of Dalmatia and Bocca di Cattaro are controlled by the bishops.

Founded in A.D. 1402, the diocese of Bukovina was at first part of the Moldavian Archbishopric; from 1768 to 1783 it was independent; from 1783 to 1873 it was part of the Archbishopric of Karlowitz, and in 1873 it became autocephalous; and at the same time the sees of Dalmatia and Bocca di Cattaro were subordinated to it. The former was founded by Napoleon I. in 1808, the second in 1873. In the Archbishopric of Bukovina there are 535,042 members (1906) and about 330 priests; in the diocese of Dalmatia (in 1910), 89,951 members, 77 priests, 54 parishes, and 3 monasteries; and in that of Bocca di Cattaro, 31,275 souls, 64 priests, 44 parishes, and 8 monasteries. Besides these there are in Lower Austria 6859, in Bohemia and Moravia 7311, in Trieste and Styria 2949 members—altogether an Orthodox diaspora of 17,119. In the Archbishopric of Bukovina the clergy are educated at the Theological faculty of the University of Czernowitz; in Dalmatia, in the Theological College at Zara. At Czernowitz a Rumano-Russian *Candela* is published. At Zara, down to 1912, there was published the *Glasnik Pravoslavne Dalmatinske Crkve* ('The Herald of the Orthodox Dalmatian Church'). In Bukovina the clergy receive their stipend from the 'Fund for the Religious,' founded in 1782; in Dalmatia, from the treasury, according to the law of 4th Feb. 1907.

(12) *The Montenegrin (Crna Gora) Church* became autocephalous in 1766, when the Patriarchate of Ipek, of which it had been a part, was abolished. Down to 1862 it was governed by Metropolitans who were at the same time the Princes of Montenegro. But in 1862 this theocracy came to an end, and Prince Danilo kept for himself the civil power only, and handed over the spiritual to a separate Metropolitan. At the present time the Montenegrin Church numbers some 220,000 members, and consists of two dioceses—Cetinje, governed by the Metropolitans (at present Metrophanes), and Zachlumje-Raša (since 1909), governed by a bishop (at present Cyril). The bishops are usually consecrated in Russia. In 1909 a law was passed defining the stipend which the parochial clergy are to receive from the State. On 30th Dec. 1903 [12th Jan. 1904] there came into force a 'Constitution for the Holy Synod,' consisting of the Metropolitans, the Bishop, 2 Archimandrites, 3 Proto-presbyters, and a Secretary. On 1st [14th]

Jan. 1904 was promulgated a 'Constitution for Spiritual Consistories.'

(c) *RUMANIAN CHURCHES.*—(13) *The Rumanian Church* has enjoyed *de facto* independence since 1864, but this was recognized by the Patriarch of Constantinople only in 1885. In 1899 it numbered 5,451,787 members, 3666 parishes with 8000 clergy, and 41 monasteries. It includes 8 dioceses, 2 Metropolitan sees, viz. the Wallachian (Bucharest) and the Moldavo-Suzavan (Jassy), and 6 bishoprics, viz. Arjish, Buzeo, Lower Danube (Galatz) Romanatz, Rimnik-Vălcii, and Hush. Each of the Metropolitans and the bishops with sees has a suffragan bishop. The Church is governed by a Synod consisting of the bishops and a Highest Church Council (since 1909), in which secular clergy and laymen take part. The election of a Metropolitan and certain ecclesiastical affairs are in the competence of Parliament, but in these proceedings only Orthodox members take part. The country clergy are educated in (secondary) Seminaries with an eight year course, the town clergy at the Theological faculty of the University of Bucharest. At Bucharest is published a religious paper, the *Biserica* (i.e. *Basilica* = 'Church') *Orthodoxa Romana*. By the Law of 21st Jan. 1902 the clergy receive their stipends from the Church fund (*cassa bisericii*).

(14) *The Hermannstadt (Szeben) Rumanian Church in Hungary* was severed from the Archbishopric of Karlowitz in 1864 to satisfy the nationalist tendencies of the Rumanians. The Organic Statute as to its government was confirmed by the Austrian Emperor in 1889. It numbers some 1,075,000 members, and consists of 3 dioceses—the Archbishopric of Transylvania and the bishoprics of Arad and Kazan-Sebes. At the head of the Province is 'the Archbishop of Transylvania, Metropolitan of all Rumanians to be found in Hungary' (at present Joseph Metsian). As in the Archbishopric of Karlowitz, there is a Congress of the Church and people, consisting of 30 clerics and 60 laymen.

(d) *ARABIC CHURCHES.*—(15) *The Church of Antioch* numbered in the 4th cent. as many as 220 sees. In 431, Cyprus was separated from it, and in 481 the Church of Jerusalem. In 638 it fell under the power of the Arabs; in 732 it was taken back again by the Greeks, in 1098 by the Franks, and in 1268 by the Turks. It now numbers some 316,000 members, mostly Arabic-speaking, living in Syria, Cilicia, Mesopotamia, Isauria, and other provinces of Asia Minor. It is governed by a Patriarch (at present Gregory IV.), who bears the title 'Most Blessed Patriarch of the Great City of God, Antioch, and of all the East,' and resides (since 1269) in Damascus. The Patriarchate is divided into 14 sees, governed by Metropolitans. A great and beneficent work connected with it is carried on by the Russian Imperial Palestine Society, which establishes schools for the Arabs. The Patriarchate publishes in Arabic a journal called *Grace*. There is a seminary at Belesmehent. The Hierarchy was for a long time Greek, but the last two Patriarchs (1899) have been chosen from among the Arabs, for which reason the other Patriarchs refused for some time to recognize them.

(16) *The Church of Jerusalem* was originally a bishopric subject to the Metropolitan of Cæsarea Philippi. The Council of Chalcedon made it a fifth Patriarchate, subordinating to it all the bishops of Palestine to the number of 50. From the 4th to the 6th cent. monasticism was very general in this region. In A.D. 614 it was wasted by the Persians, in 628 recovered by the Greeks, in 636 conquered by the Arabs, in 1076 by the Seljuk Turks, in 1098 by the Crusaders, in 1187 by the

Muhammadans, and finally, in 1517, by the Ottoman Turks. It now numbers no more than some 30,000 members, mostly Arabic-speaking, but is governed by Greek monks, about 80 in number, who have since 1687 formed the 'Brotherhood of the Holy Sepulchre' (Ἀγιοταφίτικη Ἀδελφότης). The Patriarch and all the higher clergy are elected exclusively from the members of the brotherhood. The former bears the title, 'Most Blessed Patriarch of Jerusalem and all Palestine.' To the Patriarch are subject 4 Metropolitans and 11 Archbishops, of whom only a few live in their sees, the majority residing in Jerusalem. The Patriarchate is governed by a Synod, presided over by the Patriarch; the members (16) are certain members of the Brotherhood. On 20th Dec. 1910 [2nd Jan. 1911], besides the Synod, there was established, on the demand of the Arabs, a Mixed Council (Μικτὸν Σωματεῖον) of 6 clergy (members of the Brotherhood) and 6 laymen (Arabs), and this slightly restricts the power of the Brotherhood in matters of marriage, Church property, and schools. In the Patriarchate a journal is published called *Νέα Σιών*. In the Monastery of the Cross is a seminary, temporarily closed. Relations with the Patriarchate of Alexandria have been broken off in consequence of personal questions between the Patriarchs.

4. The dogmatic system of Orthodoxy.—The fundamental distinction between the dogmatic teaching of the Orthodox Church and that of other confessions consists in the particular view it takes of dogma. Orthodoxy does not allow of the possibility of dogmatic development. The complete fullness of dogmatic doctrine was once for all taught by Christ and the Apostles, and is an object of faith. Modification and development can affect only the formularization of the dogmas. Such formularization is the more authoritative according as it expresses better the faith of the whole Church at all times, *i.e.* according as it answers to the formula of Vincent of Lerins: *quod semper, quod ubique, quod ab omnibus*. For this reason the highest authority in the Orthodox Church is the Seven Ecumenical Councils, because they had representatives of the Church from all parts (*ubique*), and because they did not establish any new dogmas, but only formularized that which always (*semper*) had been confessed by the Church ('following after the Divine Fathers'). Guided by this principle, the Orthodox Church regards as inventions of men's minds the doctrine of the Roman Catholic Church as to the perpetual procession of the Holy Ghost from the Son as well (*Filioque*) (instead of the momentary sending of the Holy Ghost by the Son), the Immaculate Conception of the Theotokos, the Infallibility of the Pope and his power over the whole Church, and the doctrine of purgatory. The Orthodox Church is distinguished from Protestantism by its recognition of Holy Tradition as a source of teaching as to faith; by its doctrine of Seven Sacraments, not as signs of grace, but as being the grace itself; and in particular by its doctrine of the Transubstantiation of the bread and wine in the Sacrament of the Eucharist into the very body and very blood of Christ; and by its doctrine of salvation not by faith alone, but also by good works. It also rejects the Reformers' doctrine of the working of salvation by grace alone, and of unconditional predestination, and it teaches that grace works together with man's freedom (*synergismos*), and that predestination has its foundation in the Divine foreknowledge. While admitting the common priesthood of believers, the Orthodox Church admits at the same time a special priesthood in a hierarchy of three orders (Bishop, Priest, and Deacon), and that this receives its full powers not from other members of the Church, but from her

founder Himself, and hands it on in succession by episcopal laying on of hands. Reckoning the Church on earth as only a part of the whole Church, Orthodoxy teaches the indispensability of lively communion between the Church on earth and the other part of the Church—the Church in heaven. This is expressed in prayer to the saints. Finally, Orthodoxy teaches of reverence (*προσκύνησις*) paid to relics and icons; but this reverence is, by the decision of the 7th Ecumenical Council, 'not to the wood and the paints, but to the persons represented in them.' In its moral teaching, Orthodoxy, in contradistinction to Protestantism, considers asceticism to be indispensable, not as an independent end in itself, but as a means for fallen man to reach moral perfection.

Both Holy Scripture and Holy Tradition are admitted as sources of doctrine as to faith. Any question of the comparative authority of one or the other source is impossible in Orthodoxy, inasmuch as each is merely a different mode of expressing one and the same doctrine of the Church. All its fullness is already included in Holy Scripture, and finds its foundation therein. Holy Scripture includes both canonical and uncanonical Books. Among the dogmatic documents of Holy Tradition, the highest authority attaches to the so-called *Niceno-Constantinopolitan Creed* ('Symbol of Faith'). Its significance is not in the least undermined by attempts to show that it is of other origin, as, in any case, at the Council of Chalcedon (A.D. 451) it was recognized as being the expression of the faith of the whole Church.

A fuller statement of Orthodox teaching is given in the so-called *Symbolic books*. This expression has been borrowed from the Protestants; but, strictly speaking, *Symbolic books* do not exist in the Orthodox Church, as no single one of them has been approved by the highest ecclesiastical authority—an Ecumenical Council—and the name merely attaches to certain more or less authoritative statements of faith, the number of which cannot be exactly defined.¹ Generally the term is applied to the following statements of faith:

(1) *Pravoslávnoe Ispovédanie* ('The Orthodox Confession') of the Metropolitan of Kiev, Peter Mogilas, composed in 1638, and approved by all the Patriarchs and by the Russian Holy Synod.

(2) *The Confession of Dositheus*, Patriarch of Jerusalem, approved in 1672 by the Council of Jerusalem. It is also known by the title of *The Epistle of the Patriarchs of the Eastern Catholic Church touching the Orthodox Faith*, as it was sent in 1723 to Russia and Great Britain.

(3) *Prostránnij Pravoslávnyj Catechismus* ('A Longer Orthodox Catechism') of the Orthodox Catholic Eastern Church, by the Metropolitan of Moscow, Philaret; approved in 1839 by the Russian Synod and afterwards also by the Patriarchs.

Among works on Dogma, the best known in the Russian Church are the *Dogmatic Theologies* of the Metropolitan Macarius, Archbishop Philaret, Bishop Sylvester, and the Protohierens Malinovsky; in the Greek Church, *Ἱερά Κατήχησις, Σύναγμα Δογματικῆς τῆς ὀρθοδόξου καθολικῆς ἐκκλησίας* of Z. Rhoses, Athens, 1903, and the work of Androuzoz, do. 1907.

Editions (fairly well known) of the Confessions of Mogilas and Dositheus in Gr. and Lat. are: E. J. Kimmel, *Monumenta Fidei Ecclesiae Orientalis*, Jena, 1850, and earlier; I. E. Mesoloras, *Συμβολικὴ τῆς ὀρθοδόξου ἀνατολικῆς ἐκκλησίας*, Athens, i. 1893, ii. i. 1901, ii. ii. 1904; in Greek, J. Michalcescu, *Θησαυρὸς τῆς ὀρθοδοξίας*, Leipzig, 1904. There is a German translation of the first in Hofmann, *Historia Catechismi Russorum*, Ratislav, 1751; of the second, in *Revue Internationale de Théologie*, i. [1893] 210-238; an English tr. of the Catechism of Philaret in

¹ Sometimes the title of a 'Symbolic book' is applied to the *Answers of Jeremias II., Patriarch of Constantinople* (to the Theologians of Tübingen), and the *Confession of Metrophanes Critopoulos*, afterwards Patriarch of Alexandria.

P. Schaff, *The Creeds of Christendom*, ii. (New York, 1877) 445 ff. For the newest literature, see Paul Ponomarev, 'Symbolic Books in the Russian Church,' in the *Theological Encyclopædia* [Russ.], xii., St. Petersburg, 1911.

As a basis for a summary of the dogmatic teaching of Orthodoxy we must inevitably take the *Nicæno-Constantinopolitan Creed* (Symbol) as it is set forth in the above-mentioned authoritative statement of the faith of the Orthodox Church. The first Article of the Creed speaks of the Creation of all things visible and invisible by God the Father. In connexion with this the Orthodox Theologians develop the doctrine of the Holy Trinity, traces of which they find in the OT, the doctrine of angels and their seven orders, of the guardian angel, of demons, of the double bodily and spiritual composition of man's nature as a microcosm, and of Providence, under which predestination (*προορισμός*) is explained as foreknowledge (*πρόγνωσις*), through which the freedom and the fall of man become intelligible. In opposition to the Pelagians it is recognized that in Adam there sinned also all his descendants, and they are therefore liable to the same punishments, but possess a special potentiality for good as having preserved the *εἰκὼν θεοῦ* though having lost his *ὁμολοίαις*.

The second Article speaks of the Person of Jesus Christ. In developing this and the eighth article on the Holy Ghost there is given a detailed refutation of the innovation of the *Filioque*, by which is introduced teaching irreconcilable with Holy Scripture, the immutability of the Creed is violated, and a doctrine of two *ἀρχαί* in the Deity formulated. The teaching of the Creed as to the Godhead and manhood in Jesus Christ is supplemented by the definitions of the 3rd to the 6th Councils as to the unconfounded, immutable, inseparable, indivisible union in Him of two natures in one Person. *πρόσωπον* is by some (e.g. V. V. Bolotov) understood as the unity of self-consciousness but not of consciousness, but the majority leave this question on one side. In connexion with the teaching as to the Incarnation the doctrine of the Perpetual Virginity of the Theotokos before, at the time of, and after the birth of Christ is set forth.

The salvation of mankind through the Incarnation, Passion, Death, Resurrection, and Ascension of Christ (Articles 3-6) is understood as a deliverance from sin, the curse, and death. This salvation is completed by Christ's threefold service as King, High Priest, and Prophet. The Descent into Hell was the manifestation of Christ's kingly power, and its purpose was to liberate those who under the Old Dispensation believed in His coming. The 9th and 10th Articles speak of the Prophetic and High Priestly service of Christ. His Prophetic service consisted in His giving the doctrine of *ζωὴ αἰώνιος* and the means for its attainment. This doctrine, passing from the Apostles to the Bishops, is preserved by means of oral and written *παράδοσις* in the Church. The Church is called 'Apostolic' because she is faithful to this Apostolic tradition; she is called 'One' because she has one Head, Christ, and in her works one Holy Ghost; she is 'Holy' because her members are made holy by true doctrine, and by the Sacraments; she is 'Catholic' because she ought to embrace the whole world. An attempt to give a more exact definition of the Church as 'the Body of Christ' has not been successful. In opposition to the Protestants it is explained that the Church is at one and the same time both visible on earth (or militant) and invisible in heaven (or triumphant). The existence of several autocephalous Churches does not contradict the unity of the Church, inasmuch as they are united by unity of confession of faith and communion in prayers and Sacraments. Her task, the salvation of souls, is exercised by the Church and those that

bear office in her, through preaching the doctrine of Christ and the Apostles, and celebrating the Sacraments established by Christ for the sanctification of men.

The 10th Article of the Creed mentions only one Sacrament—Baptism; but all statements of faith enumerate seven—*βάπτισμα, χρίσμα, εὐχαριστία, μετάνοια, ιερωσύνη, γάμος, εὐχέλαιον*. The doctrine of the seven Sacraments was not established till the 13th cent., apparently under Western influence (Council of Lyons, A.D. 1274). St. John Damascene mentions only the first three Sacraments, Dionysius the Areopagite six, and among them the taking of monastic vows and *τὰ ἐπὶ τοῖς κεκοιμημένοις τελούμενα*. The taking of monastic vows is also reckoned a Sacrament by the monk Job in A.D. 1270, and by some modern Russian theologians (Leontiev—as a form of penance; Archbishop Antonius of Volhynia).

The Sacraments are looked upon as spiritual means by which, under visible signs, there is granted an invisible grace of God, i.e. a saving force of God. The Roman Catholic doctrine of their acting *ex opere operato* is rejected. The unworthiness of the celebrant does not interfere with their efficacy; but on the side of the recipient, faith and preparation, in accordance with the ordinances of the Church, are indispensable. Baptism begins with the rite of the renunciation of Satan and his expulsion (*ἐξορκισμός*), and is administered by threefold immersion; only in the case of the sick (*τῶν κλιτικῶν*) is baptism by affusion (*ἐπιχύσις*) allowable. Baptism is a new birth which annihilates original sin and all sins previously committed, and makes the baptized a member of the Church; but the consequences of sin remain in a tendency to sin and disease. At Baptism there must be sponsors. The ordinary practice is the baptism of infants as soon as possible. Re-baptism is not allowed, if only because of the words of the Creed 'one Baptism.' Baptism by heretics is recognized if it has been administered in the name of the Holy Trinity and in accordance with Christ's command. If the Greek Church in contradistinction to the Slavic Churches refuses to recognize the Baptism of the Western confessions administered by affusion, this is a modern practice and is also subject to exceptions. The ministrant of Baptism ought to be a presbyter (or bishop), but in extreme cases it may be a deacon or a layman without even excluding women, but upon return to health the rite is completed by a presbyter.

Unction is considered a substitute for the laying on of hands in Apostolic times (Ac 8¹⁷). It is generally administered immediately after baptism and by the same person, i.e. the presbyter or bishop, but not by a deacon or layman. It is called the *σφραγὶς δωρεὰς Πνεύματος* (2 Co 1²¹), and is repeated in the case of the reconciliation of apostates. The anointing of kings at their coronation is considered a form of unction. The consecration of chrism, which was formerly performed by every bishop, is now performed only by the very highest Hierarchs and only in certain churches; the others obtain it from them. For instance, the Church of Constantinople supplies those of Greece, Servia, Alexandria, etc.; the Russian Church those of Bulgaria, Montenegro, and Antioch.

Holy Communion is administered to all baptized persons, infants not excepted. It is called the holiest of all the Sacraments, since in Baptism we have communion with Christ on the side of His power (*κατὰ δύναμιν*), but in the Eucharist with Him in His very essence (*κατ' οὐσίαν*). Under the form of bread (leavened) we are offered the very Body of Christ, and under the form of wine the very Blood of Christ, to the worthy unto remission of sins and unto eternal life, but to the unworthy

unto condemnation. The term 'transubstantiation' (*μετουσίωσις*) is borrowed from the West, but in the Orthodox Church it does not imply the raising into a dogma of Aristotle's teaching of substance and accidents, but implies only that the bread and wine upon consecration are transmuted (*μεταβάλλονται*) into the Body and Blood, not *τυπικῶς* or *εἰκονικῶς*, but *ἀληθῶς καὶ πραγματικῶς*, i.e. into the very Body and very Blood of Christ. In contradistinction to the Roman Church, Communion is administered in both kinds and with leavened bread. The consecration of the Holy Gifts takes place not by the repetition of the words of Christ, 'Take, eat . . .,' but by the invocation of the Holy Ghost (*ἐπικλήσις*, *ἐπιφοίτησις*). The Eucharist is not only a sacrifice of praise and thanksgiving, but also an atonement (*ἱλαστική*) on behalf of living and dead, identical in essence with the sacrifice of Golgotha. In contradistinction to the Roman Church, the participation of the faithful in the Eucharist is regarded as indispensable, and 'private masses' are not permitted at a celebration of the Eucharist. At any rate, those engaged in the service must communicate, and non-communicants receive particles of the *προσφορά* ('oblation') from which were taken pieces for the Sacrament (*ἀντίδωρα*). The Eucharist can be celebrated at the same altar only once in the day, and the celebrant can celebrate only once in the day. The consecrated elements receive the same worship (*λατρεία*) that is due to the Lord Himself. Once consecrated, the elements remain so for ever; they are kept in pyxes and *ciboria*, and are used for the celebration of the Liturgy of the Pre-Sanctified and the communion of the sick. The Liturgy (i.e. the Eucharist) can be celebrated only by a priest or a bishop, and only upon an *ἀντιμύησιον*.

Penitence (*μετάνοια*) is usually taught from the age of seven years, and precedes communion. In penitence there are distinguished the moments of contrition (*συντριβή*), confession (*ἐξομολόγησις*), and remission of sins (*λύσις*). But the Roman doctrine of satisfaction for sins on the part of the repentant is definitely rejected. Sometimes a penance (*ἐπιτίμιον*) is laid upon the repentant; this is meant as a spiritual exercise or self-denial necessary for a victory over evil habits, e.g. fasting on other than the appointed days. It is recommended that confession be made to one 'spiritual Father,' who acts not as a judge, as in the Roman Church, but as a spiritual physician. Denial is given to the doctrine that for sin we must suffer not only eternal but also temporary punishment, from which doctrine proceeded the theory of the *thesaurus meritorum* and the practice of indulgences.

Besides the Sacrament of Confession there is the so-called 'confession to elders,' i.e. to elders among the monks (laymen) famous for pious living.

The Sacrament of Ordination is administered by the laying on of hands (*χειροτονία*) by a bishop. Ordination with the three degrees—bishop, presbyter, deacon—was instituted not by the Church but by her Founder, Christ. A second conferment of ordination to the same degree is not allowed even in the case of converts, as long as the orders of the non-Orthodox Church are recognized as valid. Accordingly, Roman Catholic clerics receive the rank that belongs to them. The practice in regard to Anglicans has not been settled, and the ordination in America of the unfrocked Anglican priest Irvine, on 5th Nov. 1905, by the Russian Bishop Tychon, has no decisive bearing upon the point. Ordination is allowed only in the case of the unmarried or the once married. Marriage after ordination is not allowed. Since the Council in *Trullo* (A.D. 692), bishops have been exclusively chosen from among the unmarried, and mostly from those who have taken monastic vows. The rite of admission (*χειροθεσία* or

σφραγίς) to the minor orders or offices of the Church is not considered a Sacrament. Only two lower orders now exist, the Reader (or Singer) and the Subdeacon. Formerly there were others also—exorcist, doorkeeper, and women servants of the Church, widows, and deaconesses. Bishops, according to the sees they hold, or their distinctions in the service of the Church, bear the titles of Patriarchs, Exarchs, Metropolitans, Archbishops; presbyters of archpresbyters, protopresbyters, protohieries; deacons of archidiaconi and protodiaconi. These are not different orders, but honorary titles. Monks are said to belong to the clergy only when they have received ordination, in which case they bear the title of *hieromonachi* (presbyters) and *hierodiaconi*. Those who have embraced the monastic life are divided into novices (*ραιοφόροι*) who have not yet taken vows, monks of the lesser *schema* (*μικροσχημοί*, *σταυροφόροι*) who have taken vows and received the tonsure, and monks of the great *schema* (*μεγαλοσχημοί*) who have taken specially strict vows. Monasteries are not classed in orders, but all follow the rule of St. Basil the Great, somewhat modified in modern times. Their general vows are those of chastity, obedience, and poverty. The last is variously interpreted: in some monasteries with common life (*κοινόβια*) monks may not possess any individual property, in others where life is not in common (*ιδιόβρυθμα*) they may. The heads of monasteries bear the title of *hegumeni*, those of convents *hegumenissæ*. The larger men's monasteries are ruled by Archimandrites.

Marriage is declared to be a Sacrament on the authority of Eph 5³². It is preceded by betrothal (*μνηστεια*, *ἀρραβών*), formerly entered into long before marriage (even up to 10 years), but now usually, both in the Greek and in the Russian Church, celebrated just before the Sacrament. The chief moment of the Sacrament is held to be the crowning. In contradistinction to the Roman Church, in which the parties themselves are considered to be the celebrants of the Sacrament, and its essence is held to be either the *consensus* or the *copula*, the Orthodox Church considers the cleric to be the celebrant of the Sacrament, and its essence the conferring of a grace. Wedlock is allowed only between Christians, and at least one party must be Orthodox. Marriage between blood relations is forbidden to the seventh degree inclusive, both in the direct and in the collateral line. In the case of relations by marriage, wedlock is not allowed in the first four degrees. In particular, a man is not permitted to marry his brother's wife's or sister's husband's sister. An impediment is also found in spiritual relationship, i.e. relationship arising through standing sponsor at baptism. The Russian Church nowadays forbids marriage only between a godfather and the mother of his godchild, but at one time this impediment extended to the seventh degree (e.g. in the Patriarch Nicholas III. Grammaticus [1092-1107]). From this general norm there are variations both towards condescension and towards greater strictness. A second marriage is allowed, but, if both sides have been married before, it is celebrated with less pomp; a third marriage is allowed only by condescension (*συγκατάβασις*); a fourth is absolutely forbidden, though sometimes and in some Churches exceptions have been allowed (as nowadays in Bulgaria and Bosnia). Divorce on the authority of Mt 5³² is allowed in case of adultery, with a right to the innocent party to re-marry. In the Russian Church in recent times divorce has been allowed on other grounds, and second marriage is allowed even to the guilty party after the expiration of a period of penance.

The use of holy oil (chrism) is mentioned in Mk

16th Ja 5th; it is a Sacrament in which the body of a sick man is anointed with oil with an invocation of the grace of God which heals the diseases of the body and the weaknesses of the soul. It is usually performed by a council (Russian *sobor*) of 7 priests; hence in the Russian Church it is called 'Soborovanie.' In contradistinction to the Roman Church, which teaches regarding anointing with oil that it is the last anointing of a dying man (*extrema unctio exeuntium*), the Orthodox Church teaches that it ought to be performed only upon the sick for their recovery and not for the dying, though the Western practice is fairly widespread. Sometimes anointing with oil is performed upon the healthy, e.g. at the Trinity Laura of St. Sergius on Maundy Thursday.

The 7th, 11th, and 12th Artt. set forth eschatology. The Orthodox Church recognizes a double judgment, one particular and not final on the soul of each human being at his death, the other general and final—the last judgment (the dreadful judgment) which will follow after the universal resurrection of the dead with their bodies, and will also be for those then living. Until the last Judgment those who have been condemned at the particular judgment may receive pardon through the prayers of the Church. The existence of Purgatory as a place midway between heaven and hell is not recognized.

See also CHURCH, vol. iii. p. 622, and CONFESIONS, vol. iii. p. 837.

LITERATURE.—I. GENERAL.—J. M. Heineccius, *Abbildung der alten und neuen griech. Kirche*, Leipzig, 1711; M. Le Quien, *Oriens Christianus*, Paris, 1740; J. M. Neale, *Hist. of the Holy Eastern Church*, London, 1850-78; A. D. Kyriakos, 'Εκκλησιαστικὴ ἱστορία ἀπὸ τῆς ιδρύσεως τῆς ἐκκλησίας μέχρι τῶν καθ' ἡμᾶς χρόνων', Athens, 1881-98 (Germ. tr. of vol. iii. by E. Rausch, 'Gesch. der orient. Kirchen von 1453-1898', Leipzig, 1902); Ph. Bapheides, 'Εκκλησιαστικὴ ἱστορία ἀπὸ Ἰησοῦ Χριστοῦ μέχρι τῶν καθ' ἡμᾶς χρόνων', Constantinople, 1884-86 (extends only to 1453); H. F. Tozer, *The Church and the East. Empire*, London, 1888; A. d'Avril, *Les Eglises autonomes et autocephales*, Paris, 1895; J. B. Röhm, *L'Eglise orthodoxe gréco-russe*, Brussels, 1897; R. B. C. Sheridan, *The Greek Catholic Church*, Oxford, 1901; A. H. Hore, *Eighteen Centuries of the Orthodox Greek Church*, London, 1899, and *Student's History of the Greek Church*, do. 1902; Bishop Arsenius, *Chronicle of Eccles. Events* [Russ.], St. Petersburg, 1900; K. Beth, *Die orient. Christenheit der Mittelmeerländer*, Berlin, 1902; A. P. Lebedev, *Collection of Works on Church Hist.* [Russ.], St. Petersburg, 1903-04; I. Silbernagl, *Verfassung und gegenwärtiger Bestand sämtlicher Kirchen des Orients*², Regensburg, 1904; J. Pargoire, *L'Eglise byzant., de 627 à 847*, Paris, 1905; A. Fortescue, *The Orthodox Eastern Church*, London, 1907; W. F. Adeney, *Greek and Eastern Churches*, Edinburgh, 1908; J. Kulakovskii, *Istoria Vizantii*, Kiev, 1910 ff.; M. G. Dampier, *Organisation of the Orthodox Eastern Churches*, London, 1910; K. Lübeck, *Die christl. Kirchen des Orients*, Munich, 1911; A. P. Lopukhin, *Hist. of the Christian Church in the 19th Cent.* [Russ.], vol. ii. ('The Orthodox East'), St. Petersburg, 1901; P. Uspensky, *Book of my Life* [Russ.], do. 1894-1904; V. V. Bolotov, *Lectures on Ancient Church Hist.* [Russ.], do. 1907 ff.; Placide de Meester, *Études sur la théologie orthodoxe*, Paris, 1911. For the Orthodox Church in the United States, see *Special Reports of the Bureau of the Census* (1906), 'Religious Bodies,' ii. 258-267, Washington, 1910.

ii. RELATIONS TO THE WESTERN CHURCH.—C. Will, *Acta et scripta quæ de controversiis ecclesiarum Græcæ et Latinæ sæculo xi. composita extant*, Marburg, 1861; A. Pichler, *Gesch. der kirchl. Trennung zwischen dem Orient und Occident von den ersten Anfängen bis zur jüngsten Gegenwart*, Munich, 1864-65; A. Demetrakopoulos, 'Ἱστορία τοῦ σχίσματος τῆς λατινικῆς ἐκκλησίας ἀπὸ τῆς ὀρθοδόξου ἐλληνικῆς', Athens, 1867; G. B. Howard, *The Schism between the Oriental and Western Churches*, London, 1892; L. Duchesne, *Eglises séparées*, Paris, 1896; L. Bréhier, *Le Schisme oriental du xi. siècle*, do. 1899; W. Norden, *Das Papsttum und Byzanz*, Berlin, 1903; Max Herzog zu Sachsen, *Vorlesungen über die orient. Kirchenfrage*, Freiburg, 1907 (Gr. tr. 1909); Fr. Tournèbize, *L'Eglise grecque-orthodoxe et l'union*, Paris, 1907.

iii. INDIVIDUAL CHURCHES.—Th. A. Kurganov, *The Organization of Government in the Church of the Kingdom of Greece* [Russ.], Kazan, 1871; E. E. Golubinsky, *A short Sketch of the Hist. of the Orthodox Churches of Bulgaria, Servia, and Rumania* [Russ.], Moscow, 1871; A. Papadopoulos-Kerameus, 'Ἀνάλεκτα ἱεροσολυμιτικῆς σταχυολογίας, i.-iv.', St. Petersburg, 1891-97; M. G. Dampier, *Hist. of the Orthodox Church in Austria-Hungary*, London, 1905; V. Kolokoltsev, *The Organization of the Government of the Rumanian Orthodox Church since it became Autocephalous* [Russ.], Kazan, 1897; I. P. Cheltsev, *The Church of the Kingdom of Servia*

[Russ.], St. Petersburg, 1899; A. Chrysostomos Papadopoulos, 'Ἡ ἐκκλησία Ἱεροσολυμῶν', Athens, 1900; J. Hackett, *Hist. of the Orthodox Church of Cyprus*, London, 1901; M. Semenov, *Collection of Church Constitutions of the Constantinople Patriarchate* [Russ.], Kazan, 1902; I. I. Sokolov, *The Church of Constantinople in the 19th Cent.* [Russ.], St. Petersburg, 1904; G. Troubetzkoi, *La Politique russe en Orient, le schisme bulgare*, Paris, 1907; D. I. Yakshich (Jakšić), *Episodes in the Hist. of Orthodox Serbs at the End of the 17th Cent.* [Russ.], Prague, 1912; also artt. in the *Pravoslavnaia bogoslavskaiia entsiclopedia* ('Orthod. Theol. Encycl.'), s.vv. 'Vizantia,' 'Bosnia,' 'Bolgaria,' 'Gretsia,' 'Alexandrine,' 'Jerusalem Churches,' 'Constantinopol,' etc., and the reviews of Church life abroad in the periodicals, *Tserkovnaya vedomosti* ('Church News'), *Tserkovny vestnik* ('Church Messenger'), *Soobsheniia imp. pravoslavnago palestinskago obshchestva* ('Report of the Imp. Orthod. Palestine Soc.'), 1905 ff., *Vizantiysky vremennik* ('Byz. Chronicle'), etc.

iv. CANON LAW.—G. A. Rhalles and M. Potles, *Σύνταγμα τῶν θείων καὶ ἱερῶν κανόνων*, Athens, 1852-59; J. B. Pitra, *Iuris ecclesiastici Græcorum historia et monumenta*, Rome, 1864-68; J. Zhisshman, *Die Synoden und die Episkopalämter in der morgenl. Kirche*, Vienna, 1867; M. Sakellaropoulos, 'Εκκλησιαστικὸν δίκαιον τῆς ἀνατολικῆς ἐκκλησίας', Athens, 1898; N. Milaš, *Das Kirchenrecht der morgenl. Kirche* (Germ. tr. by A. von Pessic, Zara, 1897); Michael Theotoka, *Νομολογία τοῦ οἰκουμηνικοῦ πατριαρχείου*, Constantinople, 1907; S. V. Troitsky, *The Sustentation of Foreign Clergy and of Orthodox Clergy Abroad* [Russ.], St. Petersburg, 1910.

v. SYMBOLICS AND DOGMATICS.—E. J. Kimmel, *Monumenta fidei ecclesiarum orientalis*, Jena, 1848-50; W. Gass, *Symbolik der griech. Kirche*, Berlin, 1872; I. E. Mesoloras, *Συμβολικὴ τῆς ὀρθοδόξου ἀνατολικῆς ἐκκλησίας*, Athens, 1883-1901 (incomplete); P. Schaff, *Creeds of Christendom*⁵, New York, 1887; F. Kattenbusch, *Lehrbuch der vergleichenden Confessionskunde*, i., Freiburg, 1892; J. Michalcescu, *Die Bekenntnisse und die wichtigsten Glaubenszeugnisse der griech.-orient. Kirche*, Leipzig, 1904; A. Palmieri, *Theol. dogmat. orthodox. eccles. græco-russicæ ad lumen catholicæ doctrinæ examinata et discussa*, Florence, 1911; Z. Rhoses, *Σύνταγμα δογματικῆς τῆς ὀρθοδόξου καθολικῆς ἐκκλησίας*, Athens, 1903 (incomplete).

vi. LITURGICALS AND HYMNOLOGY.—Leo Allatius, *de Libris ecclesiasticis Græcorum*, Paris, 1645 (reprinted by J. Fabricius, *Bibl. græca*, v., Hamburg, 1712); J. Goar, *Euchologion, sive rituale Græcorum*², Paris, 1730; E. Renaudot, *Liturgiarum orient. collectio*³, Frankfurt, 1847; H. A. Daniel, *Codex liturgicus ecclesiarum universarum*, Leipzig, 1847-53; H. Denzinger, *Ritus orientalis . . . in administrandis sacramentis*, Würzburg, 1868; N. Nilles, *Kalendarium manuale utriusque ecclesiarum orient. et occident.*, Innsbruck, 1879-85; C. A. Swainson, *The Greek Liturgies*, Cambridge, 1884; A. von Maltzew, *Die göttlichen Liturgien . . . Johannes Chrysostomos, Basilios des Grossen, und Gregorios Dialogos*, Berlin, 1890, *Die Nacht- wache oder Abend- und Morgengottesdienst der orthodox-kathol. Kirche des Morgenlandes*, do. 1892, *Die Liturgie der orthodox-kathol. Kirche des Morgenlandes*, do. 1894, *Der grosse Busskanon des hl. Andreas von Kreta*, do. 1894, *Andachtsbuch der orthodox-kathol. Kirche des Morgenlandes*, do. 1895, *Fasten- und Blumentriodion*, do. 1899, *Oktochos oder Parakletike*, do. 1903 (incomplete), *Menologion*, do. 1900-01; F. E. Brightman, *Liturgies, Eastern and Western*, i., Oxford, 1896; J. Archatzikaki, *Étude sur les principales fêtes chrétiennes dans l'ancienne église d'orient*, Geneva, 1904; I. Haggood (tr.), *Service Books of the Greco-Russian Church*, New York, 1906; Nikodemos Haglorites, 'Εξομολογητάριον¹⁰', Venice, 1893; J. M. Neale, *Hymns of the Eastern Church*, London, 1868; J. B. Pitra, *Hymnographie de l'église grecque*, Rome, 1867; G. I. Papadopoulos, *Συμβολαὶ εἰς τὴν ἱστορίαν τῆς παρ' ἡμῶν ἐκκλησ. μουσικῆς*, Athens, 1890; J. Brownlie, *Hymns of the Holy Eastern Church*, Paisley, 1902.

Abundant material is also to be found in the periodicals *Il Bessarione*, Rome, 1897 ff.; *Oriens Christianus*, do. 1901 ff.; *Revue de l'orient chrétien*, Paris, 1896 ff.; *Echos d'orient*, do. 1897 ff.; *Revue internationale de théologie*, Bern, 1893 ff.; *Écclésiastique*, do. 1893 ff.; *Badia di Grotta Ferrata*, 1910 ff.; *Acta Academ. Velegradiensis*, Prague, 1911 ff.; *Byzant. Zeitschrift*, Leipzig, 1892-1910, etc. For the writings, etc., of the earlier theologians, see especially K. Krumbacher, *Gesch. der byzant. Lit.*², Munich, 1897, particularly the section 'Theologie,' by A. Ehrhard (pp. 37-216), the sections on 'Kirchenrecht' (pp. 607-612) and 'Kirchenpoesie' (pp. 653-706), and the bibliography given on pp. 1087-1096; cf. also the artt. 'Orient. Kirche,' by F. Kattenbusch in *PRE*³ xiv. [1904] 436-467, and 'Greek Church,' by S. Vailhé in *Cath. Encyc.* vi. [1909] 752-772, and the literature there given.

S. V. TROITSKY.

GREEN, THOMAS HILL.—i. Life.—An adequate account of T. H. Green's life is given in the memoir prefixed to the *Works* (see Lit. below), from which the following details are selected (cf. also *DNB*, s.v.).

Green was born 7th April 1836. His father, Valentine Green, was rector of Birkin in the West Riding of Yorkshire. His relatives on both sides were clerical—a fact of some interest in estimating the influence which formed his earliest environment. His family was distantly connected with Cromwell—a circumstance which also seems to have affected Green's thought by attracting his mind to the political theories of Cromwell's time. At the age of fourteen (1850), Green went to Rugby; in 1855 he

entered Balliol College, and in 1859 gave the first proof of his ability by obtaining first-class honours in the school of *Literæ Humaniores*. He appears to have developed slowly; he was more inclined to meditation than to accumulation of facts, and therefore never exhibited the qualities of the prize-winning schoolboy. The trend of his thought is well indicated by his interest in Carlyle, Wordsworth, Kingsley, F. D. Maurice, and Fichte. From 1860 to 1863 he lectured in Oxford, at first on History and afterwards on Philosophy, slowly making up his mind to adopt teaching as a profession. The influence of Jowett was the one dominant factor of this period. During 1864-66, Green was engaged in the work of a Royal Commission on Education, and his reports did much to further the development of education for children of the middle classes; his interest in this type of secondary education was a phase of his democratic tendency, and lasted through life.

In 1867 he finally settled to the work of College Tutor, showing capacity for the detail of his post beyond expectation. He seems to have been eminently practical when circumstances compelled him to undertake such duties. This feature of his character became more marked later. In 1871 he married Charlotte Symonds, daughter of Dr. Symonds of Olifton, and sister of John Addington Symonds. In 1872 he began a temperance campaign, engaged in social work, opened a coffee-tavern in Oxford (1875), and was a member of the Town Council in 1876. In these activities he showed the qualities of a reformer, and might have advanced to a wider sphere of activity as member of Parliament if his health had allowed him to stand the strain. From 1881 he was actively interested in the discussions over reform of the Church in England. As early as 1867, Green was writing, largely as a way of forcing himself to work systematically. He wrote articles for the *North British Review* at that time. In 1874-75 his views were formulated in his Introductions to Hume's *Treatise of Human Nature*. This was his main work until 1878, when, having been elected Whyte's Professor of Moral Philosophy, he gave the lectures which form the *Prolegomena to Ethics*. This work never reached its final form. In 1882 he was finding new interest in Lotze as one who stood between Kant and Hegel, but the work of translating Lotze was only in its beginning when after a short illness Green died on 26th March 1882.

2. Philosophical views.—(a) *General position.*—

In the history of English speculative thought Green deservedly holds a high position. He forms one part of a well-defined antithesis, in reference to which both his ideals and his achievements must be estimated. The close of the 18th cent. was a period of transition for British philosophy. On the one hand, there remained the method and principles which sprang from Descartes and were established, for Englishmen, by Locke. These had been developed, after Locke, by Berkeley and Hume, and may be called, for convenience, 'Associationism' or 'English Empiricism.' After Hume there was further progress of a somewhat desultory kind, leading to a revival of the spirit of Empiricism in James Mill, John Stuart Mill, and others. In Utilitarianism as begun by Hume, defended by James Mill, and most brilliantly expounded by J. S. Mill, there is a continuation of empirical thought, with increased emphasis on ethical and political doctrines. In the work of Bentham, speculative questions were relegated to the background. Similarly, in the case of James Mill and J. S. Mill, the real importance of their thought is to be looked for in practical as opposed to speculative questions. This must be emphasized, because Green approaches the work of Hume and Mill from this side, and is most concerned with the ethical implications of Empiricism. The roots of Green's own position are to be found in Kant, so that, in J. S. Mill and Green, British and German lines of development came into direct conflict. The position was further complicated by a new development on the British side. While Kant's successors rapidly moved away from his basis, and Hegel finally emerged as the outcome of a revolutionary development, the empirical position was further re-inforced by the work of Herbert Spencer, which ultimately incorporated Darwinism in its expansion of Empiricism. Green, therefore, found himself face to face with a growing opposition, and was compelled to attack at once Mill, G. H. Lewes, and Spencer. This whole movement is conveniently covered by the term 'Naturalism,' and it will now be clear that Green challenges in Naturalism a long line of thought which was by

no means a stagnant perpetuation of doctrine, but a living and aggressive development. In order to understand Green, it is necessary to grasp the character of this Naturalism. J. S. Mill accurately describes the nature of the first reaction against the 18th century. Speaking of the 'German-Coleridgean doctrine' he says:

'It is ontological, because that was experimental: conservative, because that was innovative: religious, because so much of that was infidel: concrete and historical, because that was matter-of-fact and prosaic' (*Dissertations*, 1859-75, i. 403).

This description of the first reaction applies to the later period also. Coleridge began the movement with a sentimental opposition to Locke's school; J. F. Ferrier (Professor of Moral Philosophy at St. Andrews, 1845-64) was vaguely Hegelian; J. H. Stirling began in 1865 to translate and expound the systems of Kant and Hegel; after him William Wallace at Oxford, and Edward Caird at Glasgow (1866-93) and Oxford, continued the work of expounding German philosophy in Britain. Thus before and during Green's time there was an established line of idealism with which he could associate himself in his opposition to Naturalism, and in all this movement there is clear evidence of the original antithesis of temper. Green's general position may be described as spiritualistic, religious, or idealistic in comparison with the Naturalism, Agnosticism, or Utilitarianism of the opposing theories. As stated above, Green associated himself with the idealistic movement. The vagueness of that expression is justified by the facts; for Green took Kant as his basis, but developed his own doctrine cautiously, and expressed considerable doubt as to the value of Hegel's position (*Works*, iii. 143). Consequently it is inaccurate to call Green Hegelian without further qualification; while the influence of Hegel is very patent, there is much in Green which should be regarded as directly developed out of earlier theories. It is partly on this account that the antagonism between J. S. Mill and Green appears now to have been often exaggerated: for Mill included under Utilitarianism a strong element of Kantian morality, and Green tended to limit himself to a combination of Platonism and Kantian rationalism. In both cases the influence of earlier British writers (*e.g.* Butler, Price) is a factor which tends to diminish the difference in their conclusions. When Utilitarianism took still another form at the hands of Henry Sidgwick, the controversy turned on points that were only of academic interest; for in Sidgwick, Utilitarianism made room for immediate moral judgments as originally found in Butler, thus admitting a rationalistic theory of conscience; while in Green the idea of absolute ends or absolute values, when closely inspected, becomes a formal concept of the end with no material content except just what Utilitarianism was, by then, prepared to supply.

The first consideration has been given to the ethical part of Green's work because that is the focus of his interests; and in dealing with that aspect it has become clear that Green was an opponent of Naturalism and of Utilitarianism in all the various forms which each assumed. The deepest ethical problems for a follower of Kant are naturally those of God, freedom, and immortality; Green is true to the Kantian standpoint in seeking a metaphysical basis for his ethical doctrine. To achieve this it was necessary to go back to the point from which Kant had started, namely Hume. The Introductions to Hume's *Treatise of Human Nature* (*Works*, i. 1-371) constitute a complete statement of Green's objections to English Empiricism. As these are at the same time aspects of his positive teaching, they may be summarily stated here.

(i.) Locke's theory of knowledge is declared to be grounded in a false conception of consciousness: the 'idea' is described by Locke as something given to, rather than produced by, the mind: hence the latter is said to be passive and to receive 'impressions.' The result of this false start was seen in Hume, whose work exhibited relentlessly the outcome of these premisses. To put the matter briefly, the initial error was the assertion of ideas as objects of the mind when it thinks; this Green takes to be a false analysis of experience, involving the absurd conclusion that an experience may be experience of an idea as of something given to the mind from without. On such a basis it is obvious that the self must be ultimately a complex aggregate of ideas, a product of experiences often repeated and (by association) knit together, a precipitate of time rather than a living reality. It must be admitted that Green's elaborate criticism is not always fair or relevant: there is much wearisome disputation about terminology where Locke was clearly making no effort to use technical terms; there is frequent distortion of the significance of passages due to concentration on detail in place of breadth of treatment; there is a striking lack of appreciation for the work which Locke actually achieved and for the historical background of the famous *Essay*. On the other hand, Green has a cause to plead, and his main points are strong. The real objection to Locke lay in the fact that his principles, consistently followed, led or might lead to that view of man which makes him a thinking machine, a merely animal organism, a creature without personality. The origin of these false views was to be found, Green thought, in the associationism of Locke and his followers. In denouncing this, Green was eminently in the right; his persistent challenge to Empiricism to show how a series of sensations could know itself as a series produced no answer: the doctrine, like its original supporters, was dead. With this point gained, the whole position is reversed: as the series does not sum itself, there must be a permanent self which does sum the series; this self must be active, not passive, and therefore the sensations, feelings, desires must all be phases of its activity rather than data which it receives more or less passively. Again, if we look to the objective system, we find there not only things in the cruder empirical sense of substances, but also relations; relations cannot be antecedents of the act of thinking, because they are not things that make 'impressions'; they are essentially the 'work of the mind.' Locke (from Green's point of view) was wrong in attaching so little importance to the work of the mind, for it now becomes obvious that not only relations but all that Locke would have called 'objects' are 'work of the mind'; they are not things, hopelessly external to our neuro-cerebral organism, but complexes of relations, nuclei in a network of experience. Thus, through a criticism of Empiricism, Green expounds a form of critical idealism based on Kant.

(ii.) The complement of this speculative theory is the practical theory: after treating the 'understanding,' it is necessary to discuss the principles of morals. The connexion is obvious: if the analysis of the understanding leaves us with no 'self' capable of originating action, there can be no responsibility and no morality. Green was aware that Hume could not be answered by a dogmatic reassertion of Intuitionism. Hume's position was extremely subtle: if his doctrine involved denial of the self, it none the less provided a working substitute in that product of habit and association which the average man might be satisfied to call his 'self'; if his position seemed to cut man off from all communication with God and

deny all affinity between human nature and the Divine nature, it yet left the average layman a sphere of aspirations and scope for social labours. There could be no doubt that, if the only escape from Hume was by retrogression to Cudworth, the case was hopeless. Was it necessary to escape at all? The answer to that seemed to be written in the history of Deism, in growing infidelity, in the fact that the average man is never content to think of himself as a creature of circumstances (cf. *Works*, iii., xxii.), but either rises above that estimate of himself or sinks below it to moral degradation. Green saw that morality belongs only to persons as self-determining agents; his task was to prove the possibility of morality by removing the objections to the view that men are self-determining agents; and he achieved this in an argument that deserves more attention than it has received. The point is in strict conformity with the previous demonstration that an idea cannot come from without into the mind, but must be itself a product of the mind, an expression of mental or spiritual activity. From this it follows that we must revise the use of such terms as 'pleasant,' 'tempting,' and the like. These can no longer be taken to indicate permanent qualities of objects independent of the mind. An object is 'pleasant' only when a person regards it in that way; an opportunity is 'tempting' only when a self-determining agent pronounces it such (*Prolegomena*, 98). Through thinking of pleasures and pains as things that act on the self, men had come to regard themselves as victims of circumstances or propensities. Hume finally declared reason to be the slave of the passions; no other conclusion was possible while reason and the passions were external one to another; Green's answer is based on his proof that reason is the root of the passions. The new position had far-reaching consequences: if pleasures and pains can in this way be taken up into the life of the self, if the environment is no longer a sum of irresistible attractions and repulsions, Green can triumphantly vindicate the moral life as a life of self-determination and self-realization.

These two phases of the opposition to Hume so far exhibit Green's main position that it is unnecessary to examine with the same care his attacks on G. H. Lewes and Herbert Spencer. Between Green and those writers who laid emphasis on the physical substratum of the mind, the natural history of morals, and the continuity of animal and human natures, there was hardly sufficient sympathy to make the antagonism interesting. With J. S. Mill and Sidgwick the case is different. Green naturally found in Mill's system the most significant exposition of Hedonism. J. S. Mill appeared to him simply as the heir of those doctrines which Bentham originated and James Mill advanced; the allowances which should be made on account of Mill's own condemnation of Benthamism are made by Green in word only; there is no real surrender of the belief that Utilitarianism is wrong, and that Mill's doctrine is the old Utilitarianism in new armour. In this Green was decidedly at fault; if he had ever realized the extent to which Mill was under the influence of Butler and Kant, he would not have been the precursor of a whole generation of shortsighted attacks on Mill. As will be shown later, Green's central position is religious; and on questions of religion Mill and Green were antagonistic by birth, breeding, and nature. Green divided with Mill the allegiance of the public, largely because of the natural affinity between Green's point of view and that of the advanced thinker in religious matters. Mill, on the other hand, appealed more directly to those who set social progress before the philosophy of

religion, including also those who were so far secular as to be anti-clerical, and so far opposed to orthodox beliefs as to welcome the 'irreligion of the future.' Here, again, the exaggeration of differences was unfortunate: Mill's views on religion were not directed against such refined theology as that of Green, and Green on questions of social progress was fervent enough to satisfy any utilitarian. But of all philosophers since Socrates it has been true that by their followers ye shall know them. Green and Mill were not really in the same plane. Mill belonged to the world of affairs, and his ethical writings are the theoretical background of social and political propaganda. Green is primarily academic; his atmosphere is the rarefied air of dialectics, smokeless if not cloudless. It is only necessary to read Green's criticism of Mill's *Logic* (ii. 195) to realize the difference: in the analysis of thought-processes, Green may win an easy victory; but the investigator in the laboratory or the field, handling 'things,' finds in Mill the more instructive guide; and, even where modern scientific method rejects Mill, it does not reject him in order to accept Green. As compared with Mill, Sidgwick was more akin to Green in his academic mode of thought; he could and did meet Green on his own ground; he attacked his metaphysics, criticized his demonstration of freedom, freely and mercilessly analyzed those vague phrases in which Green expressed his aspirations and too often obscured his meaning. But this, again, was not of ultimate significance; the only really valuable criticism made by Sidgwick on Green was the publication of his own version of Utilitarianism.

(b) *Speculative groundwork.*—In the exposition of his thoughts, Green was hampered by his familiarity with German modes of expression. In place of the lucid English of Hume, Green employs a technical language which baffles the untrained reader. His phrases undoubtedly reflect at times a want of clearness in the thoughts; but, as this is not the place to discuss details, an attempt will be made to state his principal ideas in ordinary terms; and those ideas were, we believe, for Green clear and distinct. It must be granted that some ideas are more easily expressed than others; also, the expression of convictions which are akin to religious experiences is notoriously difficult, easily ridiculed, and hardly ever intelligible to those who have no memory of similar experiences. Green's whole philosophy is the outcome of a profound conviction of the deep significance of personality. He saw in contemporary English philosophy an implicit reduction of personality to illusion, an analysis which ultimately explains it away. In Kant he saw the basis of a different philosophy, which could be employed to refute English Empiricism and open the way for a different expression of moral values. Having shown that Locke and his followers were at fault in their psychological method and their idea of the objective world, Green proceeds to argue that experience properly treated (*i.e.* in Kant's way) proves that there is a 'spiritual principle' in Nature. The world is for common sense a collection of objects in space. On the Kantian basis, space is a form of perception, and 'objects' are discriminated experiences, having differences which reflect the ultimate differences of 'things,' *i.e.* of those stimuli to which we refer our distinct experiences. The word 'Nature' is thus interpreted to mean a complex of experiences which indicate a ground of experience beyond themselves and constitute a system. This system is objectively real, because it is real for all rational beings, but not objective in the sense of being set over against the thinker as alien to thought. Thus, the old distinction of subjective and objec-

tive, opposed as inner and outer, is removed; the thinker and that which is thought are not divided from one another; they are not divisions of the universe, but distinctions arising out of experience, in which they have first been given as a unity. Since 'Nature' in this sense is always continuous (not an aggregate of empirical 'things'), distinctions are made by thought, and similarly laws of Nature are made by thought. But, as these laws are not arbitrary dictates so much as the revelation of rationality in the universe, it is argued that experience, thus analyzed, leads to the conclusion that there is a spiritual principle in all things—in the thinker as his capacity of thinking, and in the objective reality as its capacity of being thought. From this can be deduced (1) the ultimate unity of subject and object as collateral manifestations of one principle (which is called the higher unity, as taking precedence over the unification of separate experiences in one personality); and (2) the freedom of the individual conscious activity, because that 'Nature' which in Empiricism tends to be presented as controlling conscious activity is now shown to be one of its manifestations. This position bristles with difficulties, but its main point is not without justification. Empiricism certainly inclined to the belief that man is a material organism, that thought is a function of the nerves, and that circumstances control action. Against this Green would assert that the nature of man is spiritual, that the physical body is not the cause of thought but its instrument, and that circumstances are no more than occasions for the exercise of freedom in choice. The metaphysical discussions thus prepare the way for the ethical doctrine.

(c) *Ethical and religious views.*—Green's proof of freedom, the basis of his ethical work, amounts to a demonstration that the physical aspect of man cannot be cited as the true cause of his actions. To make morality possible it is not necessary to prove liberty in the sense of unmotivated choice. That phase of the dispute between advocates of necessity and defenders of freedom was past before Green wrote; both parties had already admitted that choice is determined by motives; they were both, therefore, determinist, but divided upon the question of the factors which determine choice. Those who favoured materialism declared that the factors which determine choice are external to the self, parts of that outer world called the not-self. On their side could be quoted the part which physiological changes play in producing psychological states, hereditary dispositions, and the like. Green, on the other side, maintained that what was external (if anything) cannot affect choice, from the very fact that it is external. To affect choice the so-called external influence must become part of experience; it must, therefore, be a phase of conscious life. In part this means no more than that desire, wish, will, and reason are all aspects of experience, and not to be treated as capable of antagonism. If in popular language we may say that our reason is overcome by desire, the philosopher has to recognize that this is inaccurate: reason and desire, if so related as to be distinguished, must, for that very reason, be also contained in a 'higher unity' which is their real identity. Thus the first phase of Green's ethical doctrine is the demonstration of the unity of the self. The second point dealt with is the continuity of the self in time. Though the self is one, it is not therefore static; it develops in and through a time-process. But moral development is not of the same kind as physical growth; it is not a mere accretion of parts. On the contrary, moral development is possible only for a being that sets before itself the idea of a condition which is not yet realized, and which,

when realized, is not other than a condition or state of itself. The moral development of a rational being is, therefore, to be regarded as the continuous realization of the capacities of the self, a ceaseless recognition of incompleteness accompanying the striving after greater completeness.

The central point of the theory is in harmony with the general position sketched above; evolution is not a sequence of disconnected states resulting from changes in the environment, but an evolution of spirit dependent throughout on the activity of a self-determining agent. The third point is the most difficult. Green essays to prove that this doctrine of spiritual evolution or personal self-realization necessarily implies a similar universal evolution. Taking history as a whole, he describes the development of the moral ideal as a process in which not men as individuals but humanity as a whole continuously realizes its 'self.' This involves at once the notorious difficulty of explaining the nature of such a universal 'self.' Green never succeeded in bridging the gulf between these two concepts of 'self.' In dealing with the individual he gave an interpretation of the idea of 'self-preservation' (the key-word of Hobbes and Spinoza alike) which successfully rebutted the arguments of the anti-rationalists; he converted the physical self-preservation into spiritual self-realization. It was possible to go further, and, under the lead of Plato and Hegel, insist on the spiritual view of society, thus making the co-operation of individuals in society something more than a mere compromise to attain material comfort. But beyond the individual and the aggregate of individuals in society, there is in Green the idea of a totality, a universe of rational beings which also becomes one in a higher unity. The opponents of Green's view were never satisfied that this was not Mysticism. The language of the *Prolegomena* particularly gave offence on this account. It did not seem possible to accept Green's terminology without developing pantheism from his position. If the personal realization of ends is to be regarded as also the realization of ends that are super-personal, is it not only too true that man is the vehicle of a Divine consciousness? Will it not then be true that self-realization is not, in fact, properly personal at all? If, on the other hand, emphasis is laid on personality, what becomes of the will to be evil, which must be a contradiction of Divine will, a refusal to be the vehicle of Divine consciousness?

These difficulties must be faced in judging Green's position, and in estimating the nature of his influence; but it would be an error to magnify their importance. The spiritual view of man and of society upheld by Green is one phase of a great tradition; in supporting it he was in the main striving to give a re-interpretation of Platonic and Hegelian views. The ethical doctrine runs up into religious beliefs which do not admit of the same treatment. Through the ambiguities of Green's language we see the essential meaning: man is never an isolated individual cut off from the rest of the universe; he is always in relation to the world about him. Life is a name for the complex activities in which personalities are like nuclei in the network of relations; take from a being all its relations, and it becomes abstract, not (as the empiricists implied) a concrete self-subsistent individual. Thus the whole comes before the parts in the case of man and of society; the reality in which man finds his own realization is always above and beyond him no less than in him; we build better than we know. From such a position it is at least consistent to declare that the will of God is above all and yet finds its realization only through individual wills; to feel also that the

essence of religion is the experience of co-operation with God, and that, mystery though it be, yet in Him we live and move and have our being.

Green, though never opposed to orthodox Christianity, was often unable to accept the ordinary formulæ of ecclesiastical religion. The task of addressing his pupils on the day before the Sunday on which Communion was administered was one of the occasions on which he felt most acutely that his mode of thought was not that of the man who is religious without being philosophical. The truth was that Green desired to get away from outward forms and phrases and concentrate on spiritual significance. His faith was deep but not conventional, and required for its understanding a sympathy not often accorded by the average church-goer or even the average clergyman. In St. Paul's writings, Green found a meeting-point for the Christian tradition and his own idealism. The deepest life of man is the inner self-consciousness; the life of thought is a perpetual revelation of the self which indicates infinite possibilities; man has, therefore, in himself a witness to God, for God is thinkable only as the realization of all that man has in him to become. As God is thus, objectively, the sum of perfection, so in man religion is faith in that perfection. Faith is not a belief in facts resting on historical evidence; it is rather the immediate consciousness of 'potential unity with God,' an experience rather than an acceptance of proofs. The position is stated in essence in the *Prolegomena* (§ 187):

'He is a Being in whom we exist, with whom we are in principle one: with whom the human spirit is identical, in the sense that He is all which the human spirit is capable of becoming.'

At a period when religious men were inclined to rise up in arms against all re-interpretation of dogma, whether due to philosophy or to science, Green's views were of a kind not to be rashly disseminated. This he knew; but he was not in any sense troubled by doubts; he rested securely in the personal conviction of truth, and feared not for religion, but for those who by narrowness of interpretation were imperilling the adequacy of religion for life.

(d) *Political philosophy.*—It is possible to write on Logic, Ethics, or Metaphysics without being truly philosophic, but it is not possible to be truly philosophic without coming to terms with the daily life of common people. The moral philosopher is most severely tested at the point where the individual and the common good come into consideration, for he has then to choose the way in which he will formulate their relation and maintain their agreement or their incompatibility. This fact was realized by Green. He saw the significance of political philosophy for his own outlook, and at the same time he had a natural tendency towards an active participation in schemes which might be thought wholly uncongenial to an academic tutor. In Green's political philosophy can be found the most concrete expression of his thought. His academic work in teaching Aristotle stimulated his appreciation of civic life and ideals; his religious emotions, always mildly anti-clerical, found an outlet in the theoretical and practical fostering of common life; his Anglo-German idealism was a further incentive to study the life of societies, these being so clearly capable of interpretation as the realization of identity in difference, unity in plurality. Looked at from this angle, society or the life of communities appears as that higher universal with which the individual has most immediate contact. Whether the individual recognizes it or not, every act has significance for the whole community; the life of the individual is nothing apart from the community; and, conversely, the

community progresses in and through the life of individuals. Here again there is room for mysticism; but the sphere is not so abstruse or remote as that of religion; it is possible to demonstrate in some degree that history supports this point of view. Green united modern and ancient politics in proof of his position. Among the Greeks the civic spirit was for him the spiritual element in the history of the City-States. In the democratic movement of his own day he saw a wider manifestation of the same spirit. He regarded the political history of the West as the record of a continual expansion of the common good, checked by private greed and dishonesty, yet never wholly prevented from growing wider and deeper. His sympathy with the work of Bright and Cobden was that of a fervid partisan for those who practised what he preached. The result was a complex attitude highly characteristic of Green. He has been rightly described as a political idealist, a philosophical radical, and a religious radical. The apparent contradictions are easily explained. In his political theory Green kept hold of the idea of personality more successfully than in his metaphysics. This led consistently enough to the demand that all persons should (in Kant's language) be treated as persons; the State has for its primary object the removal of all obstructions to free personal development. In this recognition of liberty, equality, and freedom, Green did not accept the extreme views latent in Rousseau's doctrine; he inclined more towards Burke's view, because the latter had more adequately recognized the universal essence, the relations embodied in habitudes and institutions which make man what he is (iii. 117). Thus Green's radicalism, rooted in his valuation of personality, was tempered by reverence for institutions which represent the consciousness of society, and have therefore something of universal significance. Lastly, there was the ever-present conception of a spiritual principle as an abiding factor in all the changes of political development. This element—partly metaphysical, partly religious—welds together for Green all the divisions of life into a unitary manifestation of the permanent Divine agency at work in the historical evolution of society. The firm belief that nothing is wholly bad moderated Green's radicalism; the equally firm belief in progress prevented him from acquiescing in established conditions. In his own political activities, whether in questions of educational reform or of social legislation, he found his theory adequate; it was a reason for extending knowledge among all classes, as it was a reason for supporting the abolition of slavery even at the cost of war. In brief, his own genius converted his idealism into the working faith of a social reformer; in practice he was heart and soul with the progressive tactics of the utilitarians, and in this part of his life's work nothing separated him from the better class of utilitarians except the significant assertion in which he persisted, that the ultimate end of society is not comfort but character.

LITERATURE.—The works of T. H. Green are published in three volumes with a memoir by R. L. Nettleship, London, 1885-88. This edition contains all the important writings except the *Prolegomena to Ethics*, which is published separately (ed. A. C. Bradley, 3rd ed., Oxford, 1890). An exposition of Green's thought is given by W. H. Fairbrother, *The Philosophy of Thomas Hill Green*, London, 1896. But the most instructive views of Green are to be found in more general works of which two deserve special mention: Henry Sidgwick, *Lectures on the Ethics of T. H. Green*, Mr. Herbert Spencer, and J. Martineau, London, 1902 (a keen criticism); and the essay on 'Green,' in John McCunn, *Six Radical Thinkers*, London, 1907 (a sound appreciation of Green's spirit and aims). Mention should also be made of A. W. Benn's *The History of English Rationalism in the Nineteenth Century*, London, 1906, which deals with English Hegelianism and its relation to the philosophy of religion.

G. S. BRETT.

GREGORIAN ARMENIAN CHURCH.—See ARMENIA (Christian).

GRIFFIN.—See SYMBOLS.

GROTIUS.—In this article attention will be directed mainly to the contributions made by Grotius to the development of religious and ethical thought. It will be unnecessary, therefore, to do more than indicate in outline the chief events of his life.

1. **Life.**—Hugo Grotius was born on 10th April 1583, and was from early years brought under the influence of those more liberal ideas in theology of which afterwards he himself became a powerful champion. His tutor was Uytenbogaert, subsequently a friend of Arminius and a leader of the party of the Remonstrants. At the University of Leyden, to which he went at the age of twelve, he attended the lectures of Scaliger, and very soon exhibited an extraordinary proficiency in scholarship. So much attention did his precocious talents attract that, when no more than twenty years of age, he was commissioned to write the history of the national struggle against Spain. His work as historiographer, viz. *Annales et Historiae de Rebus Belgicis*, was, however, not published during his lifetime. It was edited by his sons and issued in 1657. His professional advancement was rapid. He was appointed to the office of Advocate General of the Fisc of the Provinces of Holland and Zealand, and in 1613 became Pensionary of Rotterdam, thus acquiring a seat in the States of Holland. In the same year he proceeded on a mission to England, connected with a Fisheries' dispute. Here he came into touch with Overall, with Andrewes, and, in particular, with Casaubon, who was most favourably impressed with his appearance and intelligence (Casaubon, *Epp.* 881). Between the two men there was a kinship of spirit and a community of aim bringing them together in spite of the disparity of their ages. Both were true Christian scholars, earnestly desirous of seeing the differences of Christendom composed, and hopeful of the results which would follow from an unbiased and well-informed appeal to antiquity.

Grotius on his return to Holland found the flood of religious rancour in full stream. The controversy about Predestination and other points of Calvinistic doctrine, which had begun between the two university professors, Gomarus and Arminius, had so widened its scope as to become a pressing national danger. Although the protagonist, Arminius, had died in 1609, his followers continued to defend the positions which he had maintained, and in 1610 drew up the famous *Remonstrantie*, from which the party derived their name of 'Remonstrants.' The Gomarists replied with the *Contra-Remonstrantie*. Politics mingled with religion. On the side of the Remonstrants was Oldenbarneveldt. Their opponents could reckon on the support and sympathy of Prince Maurice. In 1614 the States of Holland passed an ordinance forbidding the preachers to deal from the pulpit with the points in dispute, the resolution to this effect having been moved by Grotius. This attempt to suppress religious controversy by means of the action of the secular power proved a disastrous failure. However well intentioned, it only aggravated the evil which it was intended to alleviate. The strife continually increased in bitterness, until in 1618 a definite crisis was reached, and the States General ordered the arrest of Oldenbarneveldt and of Grotius. After a trial, which was little better than a travesty of justice, the former was condemned to death and executed as a traitor, the latter consigned to perpetual imprisonment. At the same time the Synod of Dort assembled, and repudiated in unqualified terms the theology of the Remonstrants.

Some two years later Grotius, with the help of his wife, escaped from the castle of Loevestein, where he was incarcerated, and took refuge in France. There he composed, and in 1624 published, his most famous treatise, the *de Jure Belli et Pacis*. The book obtained prompt and wide recognition, immensely increasing the already high reputation of its author. Grotius, however, in spite of the fact that a pension had been granted him, found it no easy matter to maintain himself and his family. After some fruitless efforts to gain permission to return to Holland he accepted, in 1634, the office of Swedish ambassador to the Court of France. The duties of this office he discharged faithfully, but without conspicuous success, for ten years. Finally, determining to retire from the post, he went to Stockholm in order to place his resignation in the hands of the Queen of Sweden. It was on his return thence that he was overtaken by a sudden illness and died at Rostock (1645).

Even this brief record is sufficient to show that Grotius' life was not spent in learned leisure. From early manhood he was a busy professional man, engaged in multifarious duties. It is a matter of astonishment that, in spite of all distractions, he should have achieved so large a literary output of permanent value. So versatile was his genius that, in order to obtain some definite conception of the character of his work, it will be well to comment on his productions, under several headings.

2. **As Christian apologist.**—Of all the writings of Grotius, probably the most widely read has been the unpretentious little book entitled *de Veritate Religionis Christianae*. A special interest attaches to its origin. The germ of the book was composed

in vernacular verse, in order that it might be committed to memory by Dutch sailors and traders, and by them be employed, as occasion served, for the propagation of the faith. Subsequently he expanded this material into a short Latin treatise in six books (1627). In the first book he lays down the fundamental principles of natural religion—the being and attributes of God, and the immortality of the soul; the second is devoted to an examination of the claims of Jesus Christ to be the teacher of the true religion; the third deals with the authority of the Bible; the remaining three books are concerned with destructive criticism of Paganism, Judaism, and Muhammadanism.

It may fairly be said that this small volume initiated a new kind of Christian Apology. Not that it introduced any new arguments. The author explicitly professes to base his work on that of earlier Apologists, among whom he names, in particular, Raymond of Sabunde, Luis Vives, and Philip de Mornay. In fact, the principles which underlie Grotius' treatment of his subject do not differ essentially from those of the classical scholastic Apology, the *Summa contra Gentiles* of Thomas Aquinas. There is the same confident appeal to the natural reason and natural conscience of man, the same unshaken assurance of the impossibility of any radical opposition between reason and faith. But the difference in the method of presentment is obvious. Theology has issued from the study and come down into the market-place. Hence both loss and gain. There is loss in the consequent surrender of completeness of treatment, and in the avoidance of difficult but accurate technicalities. On the other hand, there is a noteworthy gain in compression, in simplicity, and in directness of statement. The arguments put forward are such as make their appeal to the mind of the plain man without expert knowledge. Moral considerations are placed in the forefront; much is made of the obvious superiority of Christian ethics. In fact, the proof of the truth of the Christian religion is made to rest on three supports—the height of the ideal which it sets before men for attainment, the excellence of its rules of duty towards God and man, the pre-eminence of its Founder as testified by the miracles which He was enabled to work.

In writing of the Bible, Grotius naturally defends positions from which modern criticism would dissent; but it is interesting to notice how soberly he insists on the natural value of the testimony of Biblical authors, their opportunities for accurate observation, and their unmistakable good faith. At the time he was criticized for omitting to mention such fundamental doctrines of Christianity as the Trinity and the Atonement. But the criticism is beside the point. It was not his purpose to write a treatise, however elementary, on Christian Doctrine. Rather he set himself the practical task of proving to inquirers the reasonableness of submission to the teaching of Jesus Christ. What that teaching actually was they might learn from recognized sources, especially from Holy Scripture. Thus we have in the *de Veritate* an excellent example of the Christian Apology written by a layman for the use of the laity. It is brief, pointed, practical, effective. That it answered its purpose may be inferred from the number of editions that were called for, and from the fact that it was promptly translated into several European languages.

3. As dogmatic theologian.—During the lifetime of Grotius, Holland was a hotbed of theological controversy. In these discussions he took a share, influenced not by any partisan spirit, but by the desire to make a good use of his wide and intimate acquaintance with Christian writers

of all ages, and to furnish such a statement of the truth as might help to reconcile discordant opinions. His methods may best be illustrated by his treatment of the two burning questions—the theory of the Atonement and that of Predestination.

(a) Grotius' views on the Atonement are to be found in the *Defensio Fidei Catholice de Satisfactione Christi*, a treatise directed against the opinions of Socinus. He declares himself entirely dissatisfied with the explanation given by Socinus of the connexion between Christ's death and our forgiveness. It is not enough to say that Christ preached forgiveness and gave His life to be a pledge of the truth of His preaching; that by His death He gained the right to distribute pardon; that He gave us a supreme example of patience; and that by the Cross He instils into us that faith which is the necessary condition of forgiveness. Above and beyond this, Christ's sufferings must be recognized as vicarious punishment, notwithstanding His innocence. For Grotius boldly maintains it to be not of the essence of punishment that it should fall upon the shoulders of the guilty party: 'Affirmo non esse simpliciter iniquum aut contra naturam poenae ut quis puniatur ob peccata aliena.' It cannot, therefore, be said *a priori* that Christ's punishment on our behalf involved an injustice. The view that sin can be regarded as merely constituting a debt, and its punishment remitted without other consideration than the willingness of the creditor to forgo payment, is severely criticized. In opposition to this 'debit and credit' conception of the relation between sin and its punishment, he views the matter as a kind of legal transaction, God filling the rôle of Rector or Governor, and man that of culprit. The Governor's function is explained to be the administration of laws, which have been devised for, and are enforced in the interest of, the common good of the governed. Yet this enforcement is not a matter of mechanical rigidity. Room is left for the exercise of discretion, and the law which requires the due punishment of the offender is subject to dispensation. Having made these preliminary explanations, Grotius proceeds to state his theory of the Divine forgiveness in terms of the law-court. A *solutio* involves the removal of an obligation. In some cases the *solutio* immediately cancels the obligation, as when a debt is fully paid or a penalty fully borne. Let it be remembered that the person who provides the *solutio* need not necessarily be the debtor or criminal, but may be some one else acting in his name. In these cases there is no remission because no part of the debt has been left unpaid, no part of the penalty omitted. But in other cases, where the settlement is not thus complete, there can be no discharge of obligation unless the governor officially intervenes and decides that some offered compensation shall be accounted sufficient for the purpose. In relation to the law, this act of the Governor is dispensation; in relation to the offender, remission. The compensation is, properly speaking, a *satisfactio*, not amounting to a *solutio* strictly so called. Thus Grotius dissents from Anselm's theory of the Atonement, according to which the price paid by Christ was the equivalent of the debt due from man, the infinite value of the death corresponding to the infinite amount of sin. Grotius holds that Christ, by submitting Himself to suffering and death, offered a true *satisfactio*, which, by the act of God as Governor, was accepted as a sufficient reason for granting to guilty man a remission from the obligation to pay the penalty for his sins. When a debt is remitted without any *solutio*, the transaction is called *acceptilatio*. If the discharge follows upon the substitution of some new obligation in place of the old, the term used is *novatio*. With the help of these

technical terms Grotius condenses his theory into the following sentence :

'Non est acceptilatio; non est solutio rei ipsius debitae; non est novatio; sed est remissio antecedente satisfactione.' 'There is no unconditional absolution; there is no payment of the exact debt; there is no substitution of a new obligation; but there is a remission in consequence of a precedent satisfaction.'

Two further points remain for consideration. Why did the Almighty adopt this method of requiring satisfaction before forgiveness; and why was Christ the person to provide it? To the first question Grotius replies that there was, indeed, no absolute necessity for the choice of this particular mode of Atonement, but that God selected it in order that He might thereby manifest at the same time the greatest number of His attributes, viz. His clemency, His severity or hatred of sin, and His concern for upholding the law. To the second question he answers that Christ was pre-eminently suited to provide the requisite satisfaction, because of His incomparable dignity, and because of His close connexion with ourselves as head of the body of which we are the members. His death ensured our forgiveness, while at the same time it was a conspicuous demonstration of the Divine justice.

This theory of the Atonement has not escaped severe criticism. H. N. Oxenham writes of it as follows :

'Of all the strange notions that at various times have darkened the revelation of Calvary it would be hard perhaps to find any more strange than this, which eliminates from the greatest fact of history all real significance, while it dares to interpose between man and God the fiction of misdirected vengeance' (*Catholic Doctrine of the Atonement*³, London, 1881, p. 263).

But in passing judgment upon Grotius it would be unfair to forget that his theory was framed to meet a particular difficulty. Socinus had forcibly urged the incompatibility of free forgiveness with the demand for satisfaction. Let men choose, he had said in effect, between the view that God is ready to forgive sins freely and the view that He requires the satisfaction of the Atonement. Grotius set himself to show that the supposed contradiction does not exist, and that it is possible to combine belief in the freedom of Divine forgiveness with belief in the necessity of the Atonement. To this particular end his argument was well adapted. It disposed once for all of the unsound dilemma which Socinus had set up. At the same time it is impossible to close one's eyes to the very serious defects of this so-called 'Governmental Theory' of the Atonement. The attempt to express the sacred and tender relation between God and the erring soul in terms of human law could not be otherwise than unsuccessful. That the analogy between sin and crime enabled Grotius to bring out some points clearly is true. He showed convincingly the weakness of the conception of sin as mere debt. But the hard and rigid ideas of sovereignty and administration are wholly inadequate for the purpose which they are made to serve. The royalty of God is allowed to obscure His fatherhood. Moreover, the theory of Anselm, with all its shortcomings, had at least suggested a reason why the sufferer should be God Incarnate, viz. in order that there might be an equivalence between injury and compensation. This reason disappears from Grotius' statement of the case, and there is nothing to put in its stead. Grotius throughout appears strangely unconscious that he is speaking of a mysterious truth in merely analogical terms, and that the spiritual fact could at best be roughly indicated by what is, after all, no more than a complicated and highly elaborated metaphor.

(b) With regard to Predestination, Grotius' desire to discover a *via media* between extreme opinions is even more clearly exhibited. The *Conciliatio Dissidentium de Re Predestinaria et Gratia Opinionum* is exactly what it purports to

be—an attempt so to state the problem as to lessen the bitterness of controversy. Its mediating tendency becomes specially apparent if its statements be contrasted with the outspoken declarations of the Five Articles of the *Remonstrantie*. In a certain sense the Arminians held the tenet of Predestination; but it was a predestination to eternal life, conditional upon the Divine foreknowledge of the faith of the individual. Grotius, avoiding this pronounced Arminian tenet, allows a kind of predestination to be antecedent to the foreknowledge of faith. Such an opinion, he says, if rightly explained, need not diverge from the truth of the Scriptures, Catholic tradition, and right reason. But why God should call some in such a way that He foreknows they will follow His voice, and others in such a way that He foreknows they will not follow, is a mystery belonging to the inscrutable judgments of God, who, indeed, loves all men, but loves some more than others. To the question whether grace is irresistible, Grotius likewise gives a hesitating answer. Of grace there are two modes—illumination and regeneration. The one concerns the mind, the other the will. Both considered in themselves are irresistible, and man in relation to them is entirely passive. But to these Divine operations certain human acts are subordinated, such as attention and the use of the regenerate will in faith and penitence. In no case must it be supposed that the will of man is physically determined: 'Libere credit homo, sed libertate non nata sed data.' In certain cases, Grotius is ready to recognize the possibility of an absolute decree, ensuring the means which shall inevitably produce faith and consequently salvation. The faith of the elect will not fail finally and totally, though they may for a time fall away from the justifying grace of God.

From this review it may be inferred that the opinions of Grotius on the subject of Predestination were not so dominated by any single and consistent principle as to issue in an orderly and logical system. Himself drawn this way and that by opposing considerations, he endeavoured to patch together a compromise which should secure the assent, if not the approval, of hostile factions. But, when party passions run high, balanced statements, however carefully constructed, are apt to be cavalierly treated. At any rate this was the fate of Grotius' well-meant efforts. He did not succeed in composing the quarrel between Remonstrants and Counter-Remonstrants. Nor did his work in this direction contain elements destined to live. Whereas his theory of the Atonement undoubtedly influenced the subsequent current of theological thought on that subject, no similar effect appears to have been produced by his attempt to analyze the meaning of Predestination.

4. As Biblical commentator.—Grotius was a voluminous commentator. Of the four folio volumes in which his collected theological works were published in 1679, no fewer than three are filled with his annotations of the OT and NT. From Bossuet—a most hostile witness—we get unimpeachable evidence of the authority acquired by his exegetical writings during the latter half of the 17th cent. (*Œuvres*, ii. 58). It was a success well deserved. Grotius' system of interpretation was based upon sound principles. Rejecting the rigid theory of verbal inspiration which had practically rendered impossible any rational treatment of the Sacred Text, he recognized and allowed for the presence of the human element in the work of the Canonical authors. In an age when it required some courage to make the avowal, he declared himself unable to hold that all the books contained in the Hebrew Canon had been dic-

tated by the Holy Ghost. What need was there that the Histories should have been so produced? It was enough that the writer's memory should be strengthened and his accuracy in consulting authorities ensured (*Vot. Pro Pace; de Canon. Scrip.*). The words of Scripture were to be interpreted according to the recognized rules of grammar and philology, on lines independent of dogmatic considerations. It is clear that Grotius had laid to heart the lessons which he had learned from Scaliger. In applying his principles he displayed a rare soundness of judgment which particularly attracted the admiration of that pioneer of Biblical criticism, Richard Simon. Fully accepting the reality of prediction in Jewish prophecy, he held that the passages in question generally referred to the fortunes of the Jewish people, and only in a secondary and allegorical sense found fulfilment in Jesus Christ. With regard to the use in the NT of quotations from the prophets, he maintained that for the most part they were introduced for the purpose of enforcing a faith already existing, and that, in controversy with the Jews, the Apostles had preferred to base the proof of their Master's Messianic dignity on His miracles and His resurrection (cf. note to Mt 12⁹).

In the 17th cent. textual criticism was still only feeling its way forward without fixed principles to guide it. In this department of study, as in so many others, Grotius showed to advantage in comparison with his contemporaries. A collection of his suggestions with regard to various readings is printed as one of the Appendixes attached to Walton's *London Polyglot* (vol. vi. App. xv.). The higher criticism was even further removed from the horizon of that age. Yet it is interesting to notice how Grotius had come to the conclusion that Ecclesiastes is a pseudonymous and post-exilic work, and how he attempted to detect Christian interpolations in Sirach and the Book of Wisdom. Examples of his independence in matters of exegesis, and of his freedom from the shackles of mere tradition, will be found in his comments on the following passages: Gn 1²⁶ 3¹⁵, Pss 2. 16, Is 7¹⁴ 9⁶ 11¹ (cf. F. W. Farrar, *Hist. of Interpretation*, London, 1886, p. 383 n.).

5. As moralist.—In referring to the events of Grotius' life, we have already noticed the favour with which the *de Jure Belli et Pacis* was received. From the point of view of the jurist, the publication of this book may be said to mark the initiation of the new science of International Law. For, although Francis à Victoria, Balthazar Ayala, and Albericus Gentilis had already written on the subject, no previous work had commanded any large measure of assent. A general agreement as to first principles was still lacking. The treatise of Grotius provided what was wanted. Within thirty or forty years of its publication it was generally accepted as authoritative by the professors of Continental Universities. The students of ethics, however, will take more interest in the moral principles upon which Grotius builds up his structure of jurisprudence. Writing at a time when no such thing as a concert of Europe was imagined, he was precluded by the nature of his subject from appealing to any positive enactments. He was, therefore, compelled to find a sanction for his proposed rules of war in that which is antecedent to all institutions. With a fine confidence he made his appeal to Nature, teaching that the source of rights is to be found not in any bare calculation of expediency, but in the moral constitution of man. Moreover, it is of the essence of his system to consider man not in isolation but as a member of a community. Human nature, even apart from any specific want, constrains men to form a society which, in order to satisfy their instinct, must be peaceably and ration-

ally constituted. Utility, indeed, affords the occasion for the introduction of civil law, but is not its source (Art. 16). Grotius complains that previous writers had mingled together in confusion law natural and Divine, the law of nations, and the law of particular States. In making his appeal to the law of Nature, he maintains its validity even upon the impossible supposition that there is no God, or that He takes no account of human affairs (Art. 11). He holds that its pronouncements can be deduced from notions that are self-evident and impossible of denial except by those who do violence to their own reason (Art. 39). Thus, although Grotius was not specifically concerned with questions of right and wrong in relation to the conscience of the individual, he clearly insists on the possibility of moral sanctions independent of religion and revelation. In so doing he prepared the way for the modern development of ethics as a separate science.

6. General estimate of Grotius' character and influence.—Grotius possessed untiring industry, a highly trained and penetrating intellect, and a vast erudition, together with absolute sincerity of purpose and unquestionable honesty. These qualities attracted, as they most thoroughly deserved, the profound respect and admiration of his contemporaries. But he was never a great leader. Some elements of force were lacking. In religion he was earnest, thoughtful, and devout. But he hardly gives us the impression of being irresistibly compelled to deliver his testimony by the indwelling power of conviction. His was not the mystic's direct and overwhelming vision of Truth. His faith had its roots in his conscience and his reason, and in a well-considered deference to authority. Though he wrote much on disputed religious topics, it was not his natural bent. In answer to a letter from de Thou strongly dissuading him from taking any part in theological controversy, he replied that he found himself obliged to do so by his love of country, his wish to serve his Church, and the request of those to whom he owed obedience (*Ep.* 58). It is an accurate statement of the considerations by which, against his inclination, he was impelled into controversy. He was emphatically a lover of peace. Above all things he desired to promote the cause of Christian reunion. In pursuit of this great end he was willing to concede much to Roman Catholicism; and, when writing on this subject, he so expressed himself as to lead many to suppose that he would eventually join that communion. That he came to view with increasing disfavour and apprehension the dogmatic instability and fissiparous tendencies of Protestantism is undoubtedly true; but no direct evidence is forthcoming to show that he ever intended to make his submission to Rome. It is, therefore, idle to speculate on what he might have done, had his days been prolonged. When it came, his death was the close of a conscientious and laborious life, the fruits of which have not ceased to be of service to succeeding generations.

LITERATURE.—H. Grotius, *Opera Omnia theologica*, 4 vols. fol., Amsterdam, 1679, also *Epistolae quotquot reperiri poterunt*, fol., do. 1687; J. L. de Burigny, *Vie de Grotius*, Paris, 1752; C. Butler, *Life of Hugo Grotius*, London, 1828; H. C. Rogge, *H. Grotii operum descriptio bibliographica*, Hague, 1883; J. B. Bossuet, 'Dissertation sur Grotius,' *Œuvres*, Paris, 1836, II. 76 ff.; H. Hallam, *Introd. to the Literature of Europe*, London, 1837-39, III. 57-67, 384-450; A. D. White, *Seven Great Statesmen in the Warfare of Humanity with Unreason*, do. 1910, pp. 55-110; C. Roy, *Hugo Grotius considéré comme apologiste*, Colmar, 1855; D. P. de Bruyn, *Opinions of Grotius*, London, 1894 (a legal treatise). G. C. JOYCE.

GROVE.—See TREES AND PLANTS.

GROWTH (Biological).—A distinctively vital process, characteristic of all living creatures. It is closely associated with development (*q.v.*) and with

reproduction, which is often a more or less discontinuous growth. For practical purposes it is usually enough to say that growth is increase in the size or volume of an organism, and usually implies increase in mass or weight. But this definition is too wide, since there is plainly considerable difference between an increase of size due to a subcutaneous deposit of fat and the slow, continuous growth of a lean fish like a haddock; or between an enlargement due to the accumulation of watery fluid and the fine growth of an embryo's brain. When a dried turnip is surrounded with water, or when a frog leaving its winter-quarters in the mud passes into the pond, we see increase in size, but no one would call this growth. The fact is that more than one word is required to cover the phenomena which may be in a general way referred to as growth. Organic growth is essentially a regulated increase in the amount of the protoplasm and intimately associated substances. It is much more than accretion, it is an active process of self-increase. Unlike a crystal's growth, it comes about at the expense of materials different from the growing substance—often very different, as in the case of plants which feed on air, water, and salts. Unlike mere expansion, it is regulated in relation to the organism, or organ, or cell that is growing.

Conditions of growth.—(a) *Nutrition.*—It is a fundamental condition of growth that income should be greater than expenditure. Growth primarily depends on the assimilation of food—on there being a surplus in the continual process of self-renewal. It is not inconsistent with this to say that an organism may grow larger for a time without taking in any food, for what happens in such a case is a change of condensed stored substances into more dilute and bulkier form. The shoots of a potato sprouting in a dark cellar show true growth, though the organism as a whole is actually losing water in transpiration, and, as its respiration shows, breaking down carbon-compounds. Nor is it inconsistent with our previous statement to recognize the fact that, during the period of most rapid growth in tadpoles, the imbibition of water is more important than the assimilation. But during this period the weight of dry substance in the tadpole does not increase at all.

(b) *External agencies.*—Growth, like development, has its optimum environment, but this differs greatly for different kinds of organisms, and it is difficult to make general statements in regard to the agencies that favour or hinder growing. As light is essential for the assimilatory process (photo-synthesis) of ordinary green plants, we may say that light is a condition of their growth; but as a matter of fact light is directly retardative. The strongly refractive, so-called chemical rays, which have little or no effect on assimilation, have an inhibiting effect on growth. Other things being equal, plants grow more rapidly during the night than during the day. The growth of plants is also dependent on humidity, the amount of oxygen, electrical conditions, temperature, etc. The optimum temperature usually lies between 22° and 37° C., and there is a complete cessation of growth in plants at a temperature less than 0° or higher than 40°–50° C. For animals the general statement may be made that lowering the temperature slows growth; it does so in part by retarding the process of cell-division, and this, in part, by retarding the formation of nuclein compounds in the cells. For a developing chick the temperature above which death occurs is 43° C., the minimum at which growth stops is about 28°, the normal limits are between 35° and 39° C.

(c) *Internal stimuli.*—Growth is a regulated

phenomenon, occurring in a certain sequence and within certain limits. The regulation has reference to the specific constitution of the organism (its structural organization on the one hand, its characteristic metabolism on the other), and that means that it has reference to the past history or evolution of the organism. This regulatedness is one of the criteria of organic growth; it differentiates it from the mere multiplication of chemical substances, or from the continued action of a ferment. But it should be remembered that in the growth of crystals there is also some degree of regulation in relation to the already existing architecture.

One of the ways in which the regulation of growth is brought about within the organism is by means of internal secretions or 'hormones.' The internal secretions of the thyroid gland and the pituitary body have a specific regulatory effect on the growth of the brain, the subcutaneous tissue, and the bones. The internal secretions of the reproductive organs have a definite effect on the growth of parts of the body, both of important organs like mammary glands and of trivial decorative structures, like some of the secondary sexual characters. In the galls formed by plants, say in response to the stimulus of the salivary secretion of the larval gall-insect, we have very striking examples of specific secretions inducing specific kinds of growth. It is said that, in the growth of the roots of some plants, specific chemical substances are formed which inhibit further growth. In short, facts are accumulating which show that particular parts of an organism have their growth regulated by specific internal secretions. It has been proved that some, if not all, human giants are the result of exaggerated pituitary stimulus, and it is possible that some kinds of dwarfs are due to a deficiency of this stimulus.

The correlation of the growth of different parts of the body must be recognized as a fact even though there is no available physiological interpretation, *e.g.* in terms of the formation of specific secretions. There is great inequality in the rate of growth of different parts. In cases of under-feeding there is great diversity in the way in which the growth of different parts is affected. More familiar and perhaps simpler are cases where an organ, such as the heart, responds by increased growth to increased demands upon it.

In his elaborate discussion of growth, Herbert Spencer sought to show that it varies (other things equal)—(1) directly as nutrition, (2) directly as the surplus of nutrition over expenditure, (3) directly as the rate at which this surplus increases or decreases, (4) directly (in organisms of large expenditure) as the initial bulk, and (5) directly as the degree of organization. This kind of analysis is valuable, but what is most needed at present is an extensive series of measurements of growth under diverse conditions.

Periods and rates of growth.—In a segmenting ovum we see development but no growth. Soon, however, development and growth proceed hand in hand, both very rapidly. Later on, when development is proceeding slowly—all the chief steps having been taken—growth may go on very vigorously. Thus in the pre-natal life of man great strides in development are taken in the first three months, along with very rapid growth. Thereafter, when the developmental steps are less striking, the growth is for a time very rapid. From the third to the fourth month the increase in growth is 600 per cent. After this it drops quickly and is barely 25 per cent. in the last month of pregnancy. In some organisms the growing period is very sharply punctuated; thus in insects with complete metamorphosis all the growing is done in

the larval period. In other cases growth may go on as long as the organism lives and feeds. Thus we may distinguish the definite or determinate growth of birds and mammals from the indefinite or indeterminate growth of reptiles and fishes. In other words, some organisms have a definite limit of growth—the physiological optimum—while others have not.

It is partly, no doubt, because of dependence on nutrition and on external agencies that growth is so often 'punctuated,' in some detail, rather than continuous. Every one is familiar with the rings of growth seen in the cross-section of a tree and with the lines of growth on the outside of shells. Similarly the coming and going of the seasons is for many fishes accurately registered by the concentric zones of growth seen on the scales and even in some of the bones. But besides the periodicities of growth which can be reasonably correlated with external periodicities, such as those of the seasons, there are others of a more recondite nature, such as the phases of quick growth and slow growth that alternate in the development of some animals, as Fischel has shown, for instance, in the embryo of the duck.

Active growth in multicellular organisms implies the growth of the individual cells and ensuing cell-division. The cells may grow by taking in water, and by accumulating products of metabolism, but essentially by having a surplus in the renewal of the living matter. Spencer, Leuckart, and Alexander James have thrown light on the limit of growth in cells and the division which usually occurs when that limit is reached. When a spherical cell has quadrupled its original volume, it has by no means quadrupled its surface, the one increasing as the cube, the other as the square, of the radius. But, as it is through its surface that the cell is fed, aerated, and purified, functional difficulties set in when the growth of surface begins to lag behind the growth of the cell-substance. The maximum safe size is the limit of growth, and it is then that the cell so often divides, halving its volume and gaining new surface. As a general rationale, applicable *mutatis mutandis* to organs and organisms as well as to cells, the suggestion thus briefly outlined is very helpful. Boveri and Richard Hertwig have also pointed out that the limit of growth in cells is in part determined by the ratio of the amount of nuclear material in the cell to the amount of cytoplasmic material.

The rate of growth has been studied carefully in a few cases—*e.g.* in guinea-pigs by Minot—and the facts are striking. In guinea-pigs there is in both sexes a decline in the growth-rate almost from the moment of birth. The rate falls rapidly between about the 5th day and the 50th, from the 50th day onwards more slowly, until growth stops. Moreover, this post-natal decline in the growth-rate has been shown to be a continuation of an ante-natal decline. As Jenkinson puts it, 'The younger the animal, the faster it grows; the more developed it is, the more slowly it grows. The rate of growth, in fact, varies inversely with the degree of differentiation' (*Experimental Embryology*, p. 62).

In man, according to Robertson's researches, there are three maxima of rate of growth. The first is before birth, but its precise occurrence is uncertain. As we have mentioned, the increment from the 3rd to the 4th month is 600 per cent. It then falls with great rapidity between the 4th and 6th months, and thereafter more slowly till birth. The second maximum is in early infancy or childhood. Minot puts it in the first year, when the increase of weight is about 200 per cent. Robertson puts it in the fifth year. The third maximum is near the time of puberty—about the age of 13 for girls, of 16 for

boys. It has been suggested by Robertson that the first period is predominantly characterized by the synthesis of nuclear compounds, that the third is one of cytoplasmic increase, while the second is intermediate and represents a contemporaneous occurrence of both synthetic processes. It is important to notice that the growth of women is very different from that of men. It is not only 7 per cent less, but it is on a different scheme, with the parts in different proportions.

The law that the rate of growth varies inversely with the degree of differentiation has been verified in a few cases in regard to individual parts. 'Thus human stature exhibits the same loss of growth-power as is shown by the weight of the whole body, with this difference, however, that the rate is not so high in early stages, the descent in later stages less abrupt' (Jenkinson, *op. cit.* p. 68).

When we say that growth is a *regulated* increase in the amount of living matter, we refer to such facts as its periodicity, its varied rate in different species, and its general correlation. Kellicott has emphasized the same idea by calling attention to the diversity in the rate of growth of different parts of the body. In the smooth dogfish (*Mustelus canis*) the organs, or perhaps tissues, seem to grow as more or less separate units. 'Each organ grows in its own characteristic way—each has an individual form of growth curve' (Kellicott, *op. cit. infra*, p. 598). The rates of growth of the brain, the heart, the pancreas, the spleen, and so on, are different from the rate of increase in total weight. In animals of indeterminate growth, like fishes, the brain, heart, digestive glands, and fins do not keep pace with the general increase of trunk musculature and connective tissue; and a loss of physiological equilibrium results. The determinate and more perfectly regulated growth of birds and mammals, for instance, is an obvious improvement on the more primitive unlimited growth.

When we consider growth in its entirety as a regulated self-increase of the whole organism and of its parts, we see how far it lies beyond the present limits of physico-chemical interpretation. The analogous phenomena of chemical polymerization and of the increase of crystals in a solution are interesting, but they do not at present bring us nearer understanding organic growth.

LITERATURE.—C. B. Davenport, *Experimental Morphology*, New York, 1899; J. W. Jenkinson, *Experimental Embryology*, Oxford, 1909; W. E. Kellicott, 'A Contribution to the Theory of Growth,' *Verh. VII. Internat. Zool. Kongress Graz*, 1910, Jena, 1912; F. H. A. Marshall, *The Physiology of Reproduction*, London, 1910, ch. xvi.; C. S. Minot, *The Problem of Age, Growth, and Death*, London, 1908; T. H. Morgan, *Experimental Zoology*, New York, 1907; Robertson, 'On the Normal Rate of Growth,' *Arch. Entwicklungsmechanik*, xxv. xxvi., Leipzig, 1908; H. Spencer, *Principles of Biology*, vol. 1., revised ed., London, 1898; S. Weissenberg, *Das Wachstum des Menschen nach Alter, Geschlecht, und Rasse*, Stuttgart, 1911.

J. ARTHUR THOMSON.

GROWTH (Moral and Religious).—I. DEFINITION AND SCOPE.—This article has for its scope the sum-total of the moral and religious changes through which a child passes in the attainment of moral and religious maturity, these changes being considered as natural processes.¹ Two distinctions are to be made at the outset. (1) 'Growth' as here used is a more specific term than 'increase.' In addition to the effects of mere increase in knowledge and power, we have to consider changes in children's interests, points of view, and feeling-attitudes. (2) There are two factors in the changes from moral infancy to moral maturity—the congenital or constitutional factor, and the individual's own experience. The former may be illustrated by the mental phenomena of puberty. Here a

¹ The artt. *ADOLESCENCE* and *CHILDHOOD* contain data and analyses that are presupposed in the present discussion.

change occurs that does not depend for its general character upon the individual's experience. On the other hand, many features of the individual's moral progress are after-effects of his previous experiences. Stout and others propose that the term 'development' should be used for congenitally determined changes, and 'growth' for the others.¹ The present article will adopt this nomenclature.

Development and growth do not, however, denote two independent series, but one series of changes each of which has the two discriminable factors. Thus, a hungry baby is bound to make some kind of demonstration, but what kind depends upon the experiences that have previously been associated with feeding. Just so, the ripening sexual instinct is bound to manifest itself morally, but the conduct of each pubescent boy or girl depends partly upon habits of thought, speech, and conduct already acquired. Development is the manifestation of instincts and impulses, of which the food-instinct and the sex-instinct are in a peculiar sense basal, but which include many other unlearned tendencies, such as curiosity, play, mere gregariousness, emulation, and sympathy.² Such tendencies are always one co-efficient in character, but of themselves they do not define one's moral attainments.

'Man's original equipment dates far back and adapts him, directly, only for such a life as might be led by a family group of wild men among brute forces of land, water, storm and sun, fruit and berries, animals and other family groups of wild men. But man has created a new world, in which his original nature is often at a loss, and against which it often rebels' (Thorndike, 91 f.).

Each item that is ascribed to development (as distinguished from growth) is a generic tendency rather than a specific attainment. What is specific is the particular direction given to the tendency by the individual's own experience in a particular environment, and this is what we mean by growth. While the general direction of both racial and individual progress is in some sense pre-determined by original nature, the character of each individual depends also upon accumulation of the effects of particular reactions to particular stimuli.

Because this cumulative process is itself spontaneous and constitutional, we are justified in calling growth a natural process. Further, we are justified in designating as natural any common method whereby the species as a whole, or a race of men, expresses a fundamental tendency of human nature. Thus, the monogamous family is a natural, though not the exclusive, instrument of the reproductive instinct. In a parallel way, society at large is natural; and, consequently, the cumulative influences of society upon the individual are natural also. An unnatural reaction is one that either defeats an instinct or fundamental tendency, or (though it satisfies an individual) is incapable of social approval and adoption.

II. *CHARACTERISTICS OF THE DIFFERENT STAGES OF GROWTH.*—Efforts have been made in recent years to construct out of congenital factors alone a picture of the normal progress of the child's personality. The suggestion of such a possibility appears to have come from the fact that the human embryo assumes successively certain forms that correspond in part to an ascending series of embryonic forms of inferior species. Here, to some extent, the individual body recapitulates the physical evolution of the species. May not the mental life of the immature individual similarly recapitulate the mental history of the race? This hypothesis was adopted in such a rigorous fashion as to give an impression that the one great essential for the maturing of character is that a child should run through a series of congenitally fixed periods in each of which

¹ See Baldwin, *DPhP*, art. 'Growth (Mental).'

² The most thoroughgoing analysis of these unlearned tendencies is that of E. L. Thorndike, *Education*, New York, 1912, ch. v.

one's social attitudes are pre-determined (see Literature at end of art. ADOLESCENCE). This notion lent support to the culture-epoch theory of education, according to which a child can best assimilate our present culture by first assimilating the products of earlier cultures in the order of their origin.¹ The recapitulationists went for a time to remarkable extremes, e.g. accounting for our fondness for water by reference to the aquatic life of our remote ancestors, and for the attractiveness of trees by reference to our arboreal forbears. But not only has evidence for recapitulation in any such extreme sense not been forthcoming; the challenge that it has offered to the educational world has been answered by fundamental dissent from the educational doctrines of both the older culture-epoch theory and the later recapitulation theory. It is not denied that in such respects as simplicity or complexity of organization, immediateness or remoteness of interest, and the growth of inhibitions, there is a certain kind of recapitulation or parallelism. Nor is it denied that the adaptation of the literature of the world to child interests shows a partial parallel. But the notion that the moral interests and attitudes of children are congenitally restricted to what was most prominent in earlier cultures is rejected. A child is interested first of all in what is immediately about him. The social environment to which he has to adjust himself is not a primitive one. It sets its problems upon its own plane, and the child mind goes at them directly, not merely through the intermediation of culture upon some other level. Indeed, a child cannot live through a genuinely savage period without having a savage social environment. The cultural progress of a child, then, is not merely a development, it is also a growth, in which motives and moral attitudes (as well as applications of motives) are largely determined by present social experience.

What, then, are the natural periods or stages of change from the moral and religious condition of an infant to moral and religious maturity? It will conduce to simplicity if 'religious' be here understood as synonymous with 'Christian,' and the Christian religion be assumed to include morality (the second Great Commandment). Re-statement can easily be made by the reader for any other religious or ethical position. It is now clear that to define these periods of growth we shall need to combine three points of view: (1) phenomena consequent upon mere increase of knowledge or of power, physical or mental; (2) the relative prominence of different instincts or unlearned tendencies at different ages; (3) the changing contacts of the child with the present social order.

Comparatively little attention has been given to the growth of the moral personality in its unity and in relation to its moral environment. Periods of the physical life have been extensively studied, and isolated phases of the mental and moral life have been subjected to analysis, but what we now require is to see the individual child in his integrity as a person reacting to the ordinary environment and growing thereby. The chief essay thus far made in this field is E. A. Kirkpatrick's *The Individual in the Making*. His division and general description of the pre-adolescent years is the basis for the analysis of these years that now follows. But various modifications of his terminology and description have been made, considerable discussion of the method of religious growth has been added, and an independent analysis of the adolescent years is offered.

I. *First Year.*—*The pre-individual stage.*—The infant reacts to things and to persons in much the

¹ For a brief statement, with bibliography, see art. 'Culture-Epoch Theory,' by John Dewey, in P. Monroe's *Cyclopedia of Education*, vol. i. (1911).

same way. There is little realization either of one's individual selfhood or of other persons as objects that have thoughts and feelings. Nevertheless, a basis for genuinely social habits can be laid now by associating pleasure with the infant's experience of persons. Such association with persons is the surest quickener of intelligence, and the surest beginning of a spiritual and moral interpretation of one's world.

2. Ages 1 and 2.—*The period of preliminary socialization by imitation.*—Even yet the child does not steadily distinguish himself from others. But his ability to walk and to talk, and his increasing control of hands and arms, make possible greatly increased interaction with other persons, and increased participation in the common consciousness of the family.

'He acquires many antipathies and likings that he feels, but cannot explain, in later life. . . . If the persons around him show fear of worms, insects, snakes, darkness, lightning, etc., he shares their feelings, and may in later life be unable to overcome his timidity and repugnance, although he knows that there is absolutely no basis in reason or fact for such feelings' (Kirkpatrick, 87).

In the same way attitudes towards persons, and even towards one's own pleasures and pains, can be educed and formed into habits even at this early age.

3. Ages 3, 4, and 5.—*The period of preliminary individualization.*—The child now discovers himself as an individual, and he experiments with his own selfhood as contrasted with both things and other persons. A boy in his fourth year requested of his mother something that was entirely beyond her power. When she attempted to explain, he cried out, 'You can, too! You're a bad mamma! I haven't any mamma any more!' Here is no longer the complete absorption in woe that is characteristic of the preceding years, but a self-conscious woe and an effort to find one's place among persons. Towards the end of this period there is likely to appear sheer contrariness, or apparently unmotivated refusal to conform to social expectation. But such refusal is often, no doubt, a genuine experiment which brings the pleasure of self-active exploration in new fields. This individualization offers new opportunities for moral and religious growth. Individualization is a necessary foundation of character. Therefore the process should be encouraged, not hindered. This preliminary self-assertion expresses no moral fault, and it should not be treated as a violation of a moral standard already understood and assimilated. On the other hand, conformity without experimentation should not be prized. This implies that the best moral results are to be expected where a child finds out for himself that certain kinds of conduct bring mutual pleasure, and other kinds mutual pain. That is, his experimentation, while free, should be within a social group, so that success shall mean a shared pleasure, and his earliest self-consciousness be a social self-consciousness. If, now, the family be a religious one, with habitual outward expression of its faith in speech, in family devotions, in church attendance, in religiously motivated conduct, the child, even at this age, can begin the conscious assimilation of religion. Christian family life is naturally and normally the introduction of the child to the duties and privileges of the family of God (see CHILDHOOD, § 4).

4. Ages 6 to 11 inclusive.—*A period of socialization by means of regulation and competition.*—(1) The child now begins school life, with its new social environment. The rules or ways of securing social co-operation in the school play a large rôle in the child's experience. (2) In the home also rules are now imposed with increased assumption of the child's responsibility to obey. (3) Association with other children in games and plays extends

greatly, and the necessity of playing according to rules increases throughout the six years. This necessity is due partly to the possession of growing strength, initiative, resourcefulness, which would be destructive if organization did not increase. It is due also to the increasing remoteness of the ends sought. Finally, it is a consequence, in part, of the development of instinctive tendencies which Thorndike calls 'mastery and submission,' 'approving and scornful behaviour,' and 'emulation or rivalry.' Games during these years work out these tendencies on a larger and larger scale. But another factor also enters. Competition changes its character as the years go by. At first each individual plays for his own advantage or honour, as in the game of 'tag.' Then come games in which each child plays on a 'side.' But still the individual seeks individual success, with little or no 'team work,' as in the game called 'pull away.' But towards the end of the period there is an approximation to true team games, that is, games in which functions are specialized and the player seeks the success of the team rather than personal glory. But the approximation is ordinarily only a distant one. Individualistic and social impulses still struggle against each other in a most interesting manner, as can be seen in the efforts of boys of twelve to play football. Clearly we are witnessing the approach of the bloom-time of one of the socializing instincts.

(4) Towards the end of this period there is another manifestation of the same thing in the combination of leadership and chumming. Girls form 'sets' and boys form 'gangs,' with a spontaneity and impulsiveness that point towards an instinctive origin (see CHILDHOOD, § 3). (5) In this period children usually experience important contacts with society in a larger sense, as in the Church, in social customs, in the ordinances of a city, or the laws of the State. The grown-up world is likely to appear to children in their impetuosity as chiefly a hindrance to freedom, as negative regulation. Probably this cannot be altogether prevented. Yet it is important that children should discover that the regulations of society are not arbitrary, and that freedom comes through obedience to the conditions of socialized existence. Here the family organization is likely to be the determining factor. Arbitrariness, or what seems like it, on the part of parents may easily intensify the already strong tendencies to individualistic self-assertion on the part of children; and this experience, if it is cumulative through the whole period, may permanently stunt the personality on its social side. In the family, and in the Church, the child should be conscious not so much of regulation as of fellowship. In this way he will have a means of interpreting the values of his own little competitive organizations, and he will have reinforcement for the developing social instinct. (6) Yet the special mark of this period cannot be any profound socialization of motives. The progress of character takes the form, rather, of a heightened sense of laws, of rights, of penalties, of the necessity of co-operation, and of the force of social opinion. That is, the will is being socialized chiefly on the plane of 'the law' as distinguished from 'grace.'

(7) But it is a mischievous exaggeration to say, as is often done, that this period is naturally one of unrelieved egoism. The narrow range of experience, the lack of foresight, the seeking of proximate rather than remote ends, the impulsiveness—these do, indeed, render impossible the broad sociality that adults demand of themselves. But against all this we must set not only the fact that children spontaneously, apart from all instruction, organize themselves socially, but also these two capital evidences: *First*, children very early show

traces of the parental instinct. This should not be confused with the sexual instinct, which ripens later. The parental instinct is manifested towards babies and smaller children, domestic pets, dolls, toys, and parents. Girls display it in certain directions more than boys, but it is actively present in both; and it should be developed as a softening and socializing force. *Second*, children respond to parental affection with real devotion. Admiration amounting in many cases to worship, family loyalty, and pride, a genuine glow of affection—these are the rewards which parents may reap who really share their life with their children.

(8) The religious significance of this period can easily be gathered from what has already been said. If the social environment of a child is a religious one, he naturally conforms to it under the same conditions that favour conformity in other respects. The fundamental condition is that he should realize himself as a part of an actual religious fellowship, as his father's family, a Sunday-school class, or the Church. Religion will then be to him an extension, through imagination, of social experience on the level of his present life. Laws of conduct, with the consequences of right and wrong acts; admiration and condemnation; the inclusion of God in one's family life, and loyalty to Jesus as one's leader—these will sufficiently indicate the nature of the religious experience at this age. Neither intellectual nor moral depth is to be looked for as yet.

5. Ages 12 to 14 inclusive.—*Early adolescence.*—No single phrase can adequately characterize the method of socialization that now sets in. For, on the one hand, there appears a tendency to take a self-assertive or at least independent attitude towards social authority (as in the family), and, on the other hand, to deepen one's social attachments ('gangs' and 'sets,' personal friendships, loyalty to 'teams,' partisanship). The whole expresses the approach of puberty, or the attainment of it. Here the basal fact is the ripening of an instinct. For the sake of simplicity, the age characteristics of boys are taken as our starting-point. Beginning with this period, deduction should be made, therefore, for the earlier development of girls; and the deduction should increase as the years go on—from about one year at the beginning of adolescence to about three or four years at its close. Both the apparently contradictory marks of the period above named have a positive moral significance. The new attitude towards social authority is not a mere revolt, as the complementary fact of the deepening of social attachments shows. Rather, the profounder socialization that is being prepared for—requiring, as it will, the steady devotion of personal conviction and seasoned loyalty—presupposes the detachment of the individual consciousness from chance groupings and from control by mere rules passively submitted to. Thus, increasing individualization and increasing socialization are merely complementary phases of a single process. Rather, they may be; but the possibility also arrives for a deeper selfishness than any that childhood knows. Self-assertion often becomes revolt, open or clandestine, against the social order. There is a sudden accession of juvenile crime at precisely these years. Yet even in his crimes the youth commonly reveals the socializing process that is going on, in the fact that his criminal acts are usually done in 'gangs,' or at least prompted and supported by gang enterprises and sentiment. The moral opportunity of parents and teachers is clearly indicated. It is to release the youth progressively from childhood's restraints, and to promote his free devotion to worthy socially-organized activities. There is now a rather general recognition that the youth's

interest in heroic men and women furnishes an important clue to some of the best material for moral impressions, and that his *penchant* for organization can be morally utilized by promoting clubs for outdoor sports and other appropriate activities. These things are now widely utilized also in religious instruction and training. The Young Men's Christian Associations in particular have seized upon the organizing impulse, and used it effectively. There is now a large literature of religious and moral work with boys, and most of it makes some sort of boys' organization a central consideration. Further, on the part of Sunday schools, along with a growing use of hero studies, there is wide experimentation in methods of social-religious group life. Confirmation or Church membership now makes a vital appeal to the grouping impulse in many youths.

6. Ages 15 to 17 inclusive.—*Middle adolescence.*—For the general moral significance of the attainment of reproductive capacity, see ADOLESCENCE. The main differences between this period and the one just described are fittingly indexed by the fact that, whereas in early adolescence the sexes have a sort of repulsion for each other, in middle adolescence sex attraction becomes clear and conscious. Here, again, we find a period of moral growth fundamentally determined by instinctive development. The moral possibilities and the moral dangers radiate from the same centre. The misuse of sexual power is unquestionably the chief moral failing of humanity. But around the largely instinctive preparations for family life gather some of the greatest moral forces. If we put together the two facts of increased capacity for sentiment, and the necessity of reckoning oneself henceforth a man or a woman, not a child, we shall see that we are now near the climax of the moral growth of self-conscious individuality. Middle adolescence is more difficult of treatment than the earlier periods, however, for the reason that the conditions become so much more diverse. For example, we must now deal with the moral growth of persons the large majority of whom are engaged in industries, either within or without the home. Some of the effects of shop and factory labour upon adolescents we can already discern. From the monotony and fatigue of their daily work, for instance, they react towards flashy, exciting, and often perilous pleasures.¹ On the other hand, religious conversion occurs more frequently during these years than at any other period of life. Indeed, the ages of sixteen and seventeen mark the climax in the age curve for conversions in so many different and widely scattered groups that we cannot doubt that we are dealing here with a natural law. But misunderstanding of the significance of such facts is easy. What is proved is that, in populations subjected to certain emotional incitements, the largest response comes from young persons of sixteen and seventeen. This by no means proves that capacity for religion suddenly awakes at this age. It proves only that responsiveness to certain kinds of appeal is at a maximum. A complementary indication of a natural law may be seen in the fact that religious Confirmation almost the world over has tended to seek its centre of gravity in point of age in the earlier period, not far from the age of fourteen. At fourteen the religious response is social in quality, but not chiefly emotional. What we must recognize as the peculiarly important fact about middle adolescence is that the new capacity for sentiment carries with it a certain plasticity that is of exceeding importance for education. This plasticity does not exist before; and, once gone, it is likely never to return. As has been indicated, it carries within itself certain con-

¹ See Jane Addams, *The Spirit of Youth in our City Streets*, New York, 1909.

structive tendencies. The moral interests of the race, therefore, demand that these years should be devoted to education—possibly in connexion with industries, but certainly with opportunity for freedom, play, idealization, experiment.

7. *Ages 18 to 24 inclusive.—Later adolescence.*—This deserves to be counted as a period, not because of any new developmental factor, but because of the changing social relationships and functions of the young. The youth is now fully his own master, the maiden (in her different way) her own mistress, and upon each now comes the full authority and responsibility of a citizen. Marriage is to be contracted; an occupation is to be entered upon; legal majority with all its responsibilities is attained; at last one is a full member of society and of the State. The general effect is to check the emotional ferment of the preceding period, and to give greater place to rational reflexion and deliberate decisions. Bearing in mind that mental and moral growth is checked for multitudes at various stages, especially of adolescence, and that many youths squander their powers by frivolous living, we may say that the normal line of moral and religious growth at this period has as its main characteristics independent reflexion and the solidifying of the will by the bearing of responsibilities. A frequent result of the deepening realization of responsibility for one's own thinking is doubt concerning commonly accepted views, whether in religion or in politics. Indeed, dissent from the socially accepted is a frequent phenomenon of adolescence at all its stages. But the quality of the dissent is likely to change from arbitrary impulse at the beginning to emotional unrest (as doubt of one's status before God), and, finally, to the steadier questioning of a mind that is interested primarily in seeing clearly for itself the foundations of things. During later adolescence the mental and moral life commonly takes a set (as conservative or radical), and fixes upon interests (intellectual, social, moral, recreational) that exercise a fundamental control over one's maturity. One's acquisitions go on increasing, and subdivision and differentiation occur within one's thinking and one's purposes, but the fundamental motivation of the whole is generally determined before the end of adolescence.

III. *GENERAL PRINCIPLES.*—It remains now to indicate certain general principles that apply to this whole series of growth periods.

1. A general description of vital processes as complex as those with which we are here dealing has inevitable limitations. Growth periods and transitions have, for instance, no such sharpness as any numerical division must have. Such divisions, too, can indicate only a central tendency from which there is much variation. Further, the qualitative description can never adequately represent the temperamental and other variant shades that a given mental tendency may take. Nevertheless, the fact that, to use common parlance, 'no two children are alike' is misused and becomes misleading whenever it seems to justify the abandonment of definite methods and expectations.

2. A single central principle of moral and religious growth can be discerned throughout these periods, namely, the reciprocal individuation and socialization of consciousness by participation in the social order. Intercourse with persons is the primary condition of the attainment of reflective self-consciousness. The individual's acquisition of language is, for example, a crucial point for his whole growth. Further, the social inhibitions and the social pleasures to which the individual is gradually introduced both awaken and socialize self-consciousness. Hence the incomparable importance of group life for the child at every period—

VOL. VI.—29

the family group, the play group, the school group, the 'set' or 'gang,' the civic group, the national group, the Church group, world society, the Kingdom of God. The degree and the form of one's participation in these groups depend partly upon the ripening of instincts, partly upon increase in knowledge and in power; but none of the periods of growth is strictly either pre-moral or pre-religious. The social principle, which has its culminating definition in the notion of an ideal society or family inclusive of God and men, applies throughout. The religious family includes the Heavenly Father in the domestic consciousness to which the youngest children adjust themselves; and thus it may go through their enlarging experience, the social consciousness being in varying ways religious at all stages of life. Indeed, nothing short of religious hope, faith, and loyalty gives uncompromising and unhampered expression to the social principle of moral growth. In religion we find at once the broadest and the deepest sense of social connectedness, and the profoundest realization of personal freedom. That is, religion is the supreme principle of both individualization and socialization and of their unity.

3. This principle gives us likewise a clue to arrests and perversions in moral and religious growth. An arrest consists in the persistence of any individual-social consciousness and mode of functioning beyond the chronological period to which it naturally belongs. A perversion consists in the disproportionate growth of any natural factor in any period. Now and then congenital conditions or unfavourable physical environment give a certain instinct undue prominence, and upon this basis a monstrous moral growth supervenes. But in other cases some unfortunate social emphasis or social neglect turns the forces of growth into side channels. The permanently selfish person is generally one whose natural and even useful egoistic impulses have been socially over-indulged in early life until a habit has been fixed. Thus it is, too, that society itself produces not only such relatively mild perversions as egoistical self-consciousness on the one hand, and social callousness on the other, but also much of the criminality and the vice that afflict us. Undoubtedly degeneracy of certain stocks is at the root of much crime and vice; there is often relative incapacity for response in one direction, and disproportionate strength of impulse in another. It would unquestionably contribute enormously to the moral health of society if these stocks should cease to breed. But it remains true, on the one hand, that the outcome of growth, even for one with unfortunate heredity, depends in great measure upon the social pains and pleasures that he meets during his plastic years; and, on the other hand, that a great proportion of vice and crime is simply perverted growth on the part of fairly well endowed individuals. Such perverted growth must be charged to the inadequate provisions that society has made for a normal moral life on the part of the young. Sexual vice, for example, though it is the utterance of an instinct, is enormously promoted by the refusal of adult society to face the facts of sex, and to incorporate into our dealings with the young a socially constructive sex-consciousness.¹ Most of the entrenched wrongs of society, in fact, thrive by virtue of specific social experiences of the young. The natural correlate of our analysis of growth and its laws, therefore, would be a proposal that society should regulate all its intercourse with the young on the principles of education.

LITERATURE.—From the very extensive literature of child-study and of moral and religious education, the following list selects a few recent studies of the order and processes of moral

¹ See the *8th Year-Book of the National Society for the Scientific Study of Education*, Chicago, 1909.

and religious growth, together with a few studies of practical methods for promoting such growth. The reader should consider the literature appended to art. CHILDHOOD as a part of the present list.

I. GENERAL WORKS ON THE GROWTH OF MORAL CHARACTER: E. A. Kirkpatrick, *The Individual in the Making*, Boston, 1911; E. O. Sisson, *The Essentials of Character*, New York, 1910; J. M. Tyler, *Growth and Education*, Boston, 1907; E. R. Mumford, *The Dawn of Character*, London, 1911; J. MacCunn, *The Making of Character*, New York, 1900.

II. WORKS CONCERNED ESPECIALLY WITH RELIGIOUS GROWTH: E. D. Starbuck, *Psychology of Religion*, London, 1899; E. S. Ames, *Psychol. of Rel. Experience*, Boston, 1910, pt. III.; G. A. Coe, *The Spiritual Life*, New York, 1900; R. M. Jones, *A Boy's Religion from Memory*, Philadelphia, 1900.

III. GENERAL WORKS ON METHODS FOR PROMOTING MORAL AND RELIGIOUS GROWTH: G. A. Coe, *Education in Rel. and Morals*, New York, 1904; W. B. Forbush, *The Coming Generation*, do. 1912; E. H. Griggs, *Moral Education*, do. 1906; E. Richmond, *The Mind of a Child*, London, 1901; E. P. St. John, *Child Nature and Child Nurture*, Boston, 1911; P. du Bois, *The Culture of Justice*, New York, 1907.

IV. WORKS THAT DEAL PARTICULARLY WITH METHODS WITH ADOLESCENTS: W. B. Forbush, *The Boy Problem*, Boston, 1907, also *Church Work with Boys*, do. 1910; E. C. Foster, *The Boy and the Church*, Philadelphia, 1909; M. Slattery, *The Girl in her Teens*, do. 1910; J. W. Jenks, *Life Questions of High School Boys*, New York, 1908; E. Richmond, *Boyhood*, London, 1908; *Poems of Action*, A Collection of Verse for Youth, chosen and edited by D. R. Porter, New York, 1911; Fr. W. Foerster, *Jugendlehre*, Berlin, 1904.

V. PERIODICALS AND BIBLIOGRAPHIES: *Work with Boys*, published by the Federated Boys' Clubs, Norwood, Mass.; *American Youth*, published by the Internat. Committee of Y.M.C.A., New York; *Selected Books for Boys*, Y.M.C.A. Press, do. 1907; *Classified Bibliography of Boy Life and Organized Work with Boys*, published by the Internat. Committee of the Y.M.C.A., do.

GEORGE A. COE.

GUARANI.—See BRAZIL.

GUARDIAN ANGELS.—See TUTELARY GODS.

GUEST, GUEST-RIGHT.—See HOSPITALITY.

GUIANA.—I. Name, geography, and physical characteristics.—The origin and history of the place-name 'Guiana' or 'Guyana' are obscure, despite the very full and pregnant note by G. E. Church prefixed to the article under this name in *EBr*¹¹, vol. xii. p. 674. The name is almost certainly compounded of the two local Red men's root-words *wai* or *guai* and *ana*, which respectively indicate 'water' (or rather 'river'), and 'the place of.' There seems little doubt that the name Guiana was unintentionally coined by some of the earlier explorers of the 'Wild Coast' of the north-east of the southern continent of America. In sailing past the long series of river mouths and deltas which occupy the coast between the Amazon and the Orinoco, they very probably inquired of the few natives of the locality with whom they came into contact as to the name of the new land, and, being answered that it was 'a place of many rivers,' misunderstood this to mean that *Guiana* or something that sounded like it was the proper and accepted name of the country which they saw from their ships.

Naturally enough, the extent of this imaginary land of Guiana was undefined in the minds of these earlier explorers. Probably it was to them at first merely an alternative for what they had before spoken of as the 'Wild Coast.' Then it was thought of as extending quite indefinitely back from the coast, even perhaps as far as the then almost unknown ocean which, it was assumed, lay far away to the westward. Next, as a little information was gleaned from the few bold traders who penetrated into the interior, as also from the Red men who came down to the coast from homes somewhere about the heads of the rivers, it was vaguely gathered that the main sources of the many rivers which reached the coast must lie close together, also that behind these sources there was some sort of water communication between the two great

rivers Orinoco and Amazon, and that the whole of the land watered by the rivers of Guiana was thus a great island, the so-called 'Island of Guiana,' a huge delta-island, as it were, of the single great river-system which the Amazon and the Orinoco were then supposed to form.

About the mouths of the rivers of the Guiana coast representatives of various European nations—Dutch, English, and French—at an early period established a few widely scattered settlements, and thus acquired some sort of claim to possession. Meanwhile other European nations—the Portuguese as regards the whole of the southern part of the continent and the Spaniards as to the northern part—professed to have acquired between them, by gift from the Pope, exclusive rights over the whole continent, including that country of Guiana which even then was more or less in *de facto* possession of the Dutch and others. For several centuries Dutch, English, and French struggled, each against the others, for possession of Guiana, and were—often much to their indignation—regarded and dealt with as interlopers by the Spaniards and Portuguese. Only within quite recent years has the last of the Guiana boundary disputes between Dutch, English, and French and the Brazilians and Venezuelans—the two last-named respectively representing the old Portuguese and Spanish claims—been settled.

Nowadays Guiana—the old island area of Guiana between the Orinoco and the Amazon—is divided, from north to south, into Venezuelan Guiana (*i.e.* that part of Venezuela which lies south of the Orinoco), British, Dutch, and French Guiana, and Brazilian Guiana (*i.e.* that part of Brazil which lies north of the Amazon).

'The island' of Guiana, of course, never existed, in the strict geographical sense of the term; but, as it has proved, the term did cover something real, in that it applied to an area distinct in physical features, and, perhaps consequently, in the kind and condition of the natives who occupied the land before White men first entered in, and who still linger there. Towards the back of the so-called 'island' there is a group of mountains, mostly flat-topped and hardly anywhere exceeding 8000 ft. in height, from which originate all the main rivers of Guiana, some of these flowing towards the west to join the upper waters of the Orinoco and the Amazon, while others—the longer and more important ones—run eastward into the sea on the Guiana coast. Except for the mountain watershed, to which reference has just been made, and a few minor and isolated elevations, the whole of Guiana is comparatively low and of recent origin; indeed, a very large proportion of it consists of actually recent alluvial deposit from the many rivers. The long slope from the coast to the main watershed is for the most part densely covered with trees; and the slope from the watershed down towards the main affluents of the Orinoco and the Amazon is chiefly open country, locally called *savannah*, with few trees except in the gullies.

2. Ethnography.—At the time when Europeans first entered and penetrated the region in question, it was inhabited by red-skinned natives obviously belonging to a considerable number of tribes, more or less distinct from and hostile to each other, and all at a very primitive stage of (American) culture, though some—and those the more dominant tribes—were further advanced than others. As it happened that the chief and most enduring European influence brought to bear on the Red men of Guiana was that of the Dutch—the English, though a long way behind, perhaps coming second in this respect—and as the Dutch, from motives of policy, sought to make allies rather than subjects of the Red men, there seems to have been comparatively

little change in the condition of the so-called 'Red Indians,' from the first entry of Europeans till comparatively recent times. It is true that the early European settlers introduced into Guiana large numbers of African negroes for manual work on the tropical plantations; and that, though these plantations were very seldom far from the coast, the negro slaves—especially, from the nature of the case, the more brutalized of them—did from time to time, and often in large numbers, escape into the forests of the interior and make their homes not far from those of the Red men. But, as it was also part of the established Dutch policy to use their red-skinned allies against the escaped black slaves, there was hardly any intermingling between these American and African coloured folk; and it was only much later—quite recently, indeed, when the gold which had long been sought there had at last been discovered, and the White colonists themselves had thereby been attracted in large numbers into the interior—that any very considerable change occurred in the habits and condition of the Guiana Red men. What the latter were up to a very few years ago they almost certainly were when the Dutch established their first colony, in 1621, on the Essequibo River.

From time to time many different names have been more or less vaguely applied to the various groups, or so-called tribes, of Guiana Red men; and it is even now difficult to classify them in any definite and scientific way. But in the main they belong to four not very widely separated branches of the American race. In the swampy forests nearest to the sea are the *Warraus*, the least advanced of all the local tribes, and probably representing the earliest of the known inhabitants of the country. In the forest, a little way inland from the Warrau country, were, and still are, the *Arawaks*, who must have come into Guiana, from the north, at a later date than the Warraus, but sufficiently long before the arrival of White men to have established themselves firmly and almost as aborigines. Inland from the Arawak country the greater part of Guiana is, and has been throughout historic times, occupied by several branches of the great *Carib* stock, all the members of which may conveniently be distinguished as 'true Caribs.' Still further from the sea, i.e. entirely in the *savannahs* lying beyond the main watershed, are, or were, the so-called *Wapianas*, who may or may not have been originally of Carib stock. The true Caribs and the *Wapianas* almost certainly reached Guiana after the Arawaks, and not very long before the discovery of the country by White men. Indeed, some of these true Carib tribes entered Guiana from the south, by the waterways connecting the Amazon with the Guiana river-system, at periods long subsequent to the settlement of the Dutch on the coast.

3. Stage of culture.—All these Red men were in a very primitive stage of that culture which was developed—sometimes, as in Mexico, to a very high degree—in America. And though, as might be expected from their history as briefly indicated above, the Warraus are at a somewhat lower stage than the other Red men of Guiana, the difference is not very considerable.

The Red men of Guiana, so far as their habits have not been altered by European influences, are in the stage at which they live by hunting and fishing and, in most cases, by cultivation of a kind almost too simple to merit the name of agriculture. Four-footed game and birds are plentiful everywhere. Fish are extraordinarily abundant in the rivers, large and small, as also in the sea. Fresh-water turtles are so numerous in the rivers that their flesh and eggs provide the Red man with a considerable addition to his animal food; and near

the sea, crabs and shell-fish are at least equally plentiful. Nor is there any lack of wild fruits and other vegetable food. As to cultivation, the cassava plant is the chief object; and the roots of this made into 'bread'—much of which is further manufactured into the slightly fermented and highly nutritive drink called *paiuari*—supply a very large part of the food of all the tribes except perhaps the Warraus, who, having their homes in swamps where cultivation is difficult if not impossible, use the fruit and pith and sap of a palm (*Mauritia flexuosa* [Linn.]) growing wild round their homes in place of cassava.

None of these Red men had occasion—and, in proportion as they are out of contact with Europeans, still have little occasion—for much in the way of clothing. A small apron is quite sufficient except at festivities or in courting; and on such occasions a greater or less amount of ornamental clothing is easily added by working up the feathers, seeds, shells, and barks which Nature has abundantly provided.

As for shelter, on the open *savannah*, where the wind is often cold, fairly large and substantial houses, with thickly thatched roofs and thick mud walls, are built; throughout the greater part of the forest region much less substantial houses of leaves and posts suffice; and in their low-lying, palm-tangled swamps the Warraus construct for themselves yet simpler shelters of leaves and sticks; but, owing to the nature of the ground, they have to place these houses on somewhat substantial platforms of felled palm-trunks. In none of these cases is the house in any way much elaborated; nor is much labour involved in getting the material together.

Fire was always easily made by rubbing two sticks together, in a simple and easily learned way (cf. art. FIRE), and fuel lies everywhere around. Most of the tribes are good potters, after a simple fashion. Bows and arrows, blowpipes—the latter used only on the *savannah*—and fishing-gear they are singularly expert at constructing. The only other prime necessity of their simple and easy lives is the hammock, or hanging bed, the invention of which is the one great triumph of ingenuity which they have achieved. The material of which the hammock is made is either the cotton which grows almost wild about their houses or the strong string-like fibre which they know how to extract from palms and similar plants.

In short, these Red men, when first discovered by Europeans, had attained to nothing more than that stage of culture in which each individual, or at any rate each family group, knows how, from the material ready to hand, to supply easily all the immediate needs of life, but is unable, owing to ignorance of the necessary arts, to produce treasure of wealth for the use and enjoyment of succeeding generations.

4. Mental attitude: quasi-religious conceptions.—It is more difficult to describe what would appear to be the mental attitude of this people, at this stage of culture, towards their fellows and towards the world in general. The individual Red man of Guiana knows only himself, and knows neither of any beginning nor of any end to that self. He sees children born into the world, and—if and when he thinks on that subject—he probably assumes that he himself was once 'born,' but not that he then came into existence as an individual; rather he assumes that at the crisis of birth he—i.e. the 'being' whom he recognizes in himself—merely passed into a new body. Similarly, when he sleeps, he dreams perhaps that he is a jaguar or a tree or some other man or thing than himself; and when he is awake, if he remembers his dream at all, he assumes that he (his being) was really at the

moment that jaguar, tree, or man, and that he has now passed back into the body which he happened to be occupying at the moment when he went to sleep. Once more, he sees men die, and probably assumes that he himself will one day die; but he does not for a moment suppose that this will be the end of him, but rather that it will be merely the passing of himself into another body—much as during his dreams he has already been in other bodies.

Another thing which it is necessary to understand is that a typical Guiana Red man is—and, so far as he retains the innate habit of thought of his race, could not but be—the purest of egoists. He knows himself, and instinctively claims for himself certain rights, for instance the right to get for himself all that he is strong and clever enough to get. At the same time he can hardly fail to recognize the existence of innumerable other beings, which are more or less 'good' or 'bad' to him, but are all more or less elusive as to bodily form. These beings with which he comes in contact may be in what we should call human bodies, which may be those of Red men of tribes other than his own, or, again, not of his own family or not of his own household; they may be in bodies which we should call those of brute beasts; or they may be embodied in trees, or stones, or any other outward shape. Moreover, all these beings may be, as the Red man thinks, sometimes in one kind of body and sometimes in another. His feelings towards this innumerable host of beings outside himself are not what we should describe as those of affection or hatred, but rather those either of appreciation of something useful to himself, or of depreciation of something possibly more or less harmful, or at least useless, to himself. He dreads, or at least suspects, every strange man and strange object; and the degree of his liking even of the beings which are not strange to him is in proportion to the degree in which he is familiar with them, or rather to the degree in which, from experience or otherwise, he judges that these outside beings are or may be useful to him. Even the members of his own family are not loved, but are more or less valued, in proportion as they are, or may be, more or less good, *i.e.* useful, to him.

Another aspect of this primitive philosophy is that, as every 'being,' however much and however often it may change its form, is without beginning and without end, hence it follows that no one of these 'beings' ever dies (as we should say), but remains actually present in the world, whether in visible form or not. To the Red man every being that ever existed still exists; and every being that at any time did anything, good or bad, to make itself remembered, even though it has long left the body in which it did that deed, is not only actually present, but is as capable as ever it was of doing the kind of thing that it used to do. If the deeds of the 'dead man' were good (subjectively, to our supposed red-skinned philosopher), the dead man is (to him) a still existing hero, and he thinks it well to cultivate his favour, or at least to guard against his disfavour. If, on the other hand, the 'dead man' did things which were bad, he still remains present as a being to be dreaded. It is apparently in some such way as this that the Red man regards the world of beings that are to him what, for want of better words, we should speak of as, on the one hand, 'heroes,' or even gods, and, on the other hand, evil spirits, or even devils.

The old controversy between anthropologists as to whether any particular group of primitive folk did or did not recognize the existence of a supreme god (see GOD [Primitive and Savage])—the Great Spirit, All-Father, and the Creator—as a being of entirely different origin and order from their own,

has been raised as regards the Guiana Red men. The present writer, after long and intimate intercourse with the latter, came to the conclusion, to which he still adheres, that they have never of themselves recognized such a superior being, and that, if they speak, as they have certainly sometimes spoken, of a very powerful being which, for instance, made men or made the world, or submerged an existing world under the waters of a great flood, they are then referring, on the strength of tradition, to a more or less exceptionally powerful being belonging to their own order.

Holding the ideas above described, the Guiana Red man instinctively feels that of all the quite indefinite number of beings—in all sorts of forms—of which he becomes aware during the course of his life, the most important to him are those which are, or may be, actively hostile to him, all of which he calls *kenaima*; and those which may help him to ward off the effects of the *kenaima's* hostility—these he calls *peai*. Absolutely all evil that happens to him is done by the being which, whether at the moment of action it happens to be in the form of man or beast, or stock or stone, or in any other conceivable form, is *kenaima*; and the Red man's one obligation other than that of getting together the necessities of life is to guard himself against the attacks of the *kenaima*. Against the open attack of the *kenaima* he can to a certain extent guard himself; but against the insidious attacks which the *kenaima* is able to make—in virtue of that being's unlimited power of changing its form—the Red man naturally feels himself insufficiently equipped; and he therefore applies for help against the *kenaima* to the professional wise man of his tribe, the *peai*, or medicine-man.

It may at first sight appear that this conception of the relations of good and evil is not very different from that which among more civilized folk takes the form of a great contest between good and evil, between God and the devil. There is this difference, however, that to the Red man there does not appear to be any God to fight for him; it is a question of fighting only for his own welfare, with the help, at most, of beings of his own kind, though perhaps somewhat more clever.

A question may be asked as to what is the nature of the material with which the *kenaima*, when he does not use an arrow or other material weapon, works harm, and, again, as to the material with which the *peai* counteracts this evil. In both cases the 'medicine,' *i.e.* the poison or the antidote, is called by the Red man *beena*; it is thought of as an essence extracted from some substance, and it may be used, now by the *kenaima* and now by the *peai*, much as, under the conditions of Western culture, poison might be administered by an enemy, or medicine by a doctor.

The *kenaima* and the *peai* are both more clever, *i.e.* more artful, than their patient, and both possess one faculty which is of great importance to them; they know how to extract the real being of the red-skinned patient from the body in which it happens to be enveloped. For instance, the *kenaima*, if he gets possession even of a fragment of the body of the patient on whom he intends to inflict ill—say even a few hairs or a nail-cutting—may be able to get possession of the whole being which was within the body from which the fragment was cut; or, again, the *peai*, by certain processes of what we should be inclined to call incantation, can, for convenience of treatment, draw out the spirit (the real being) of his patient, just as one of our own medical men might on occasion have the body of his patient stripped of its ordinary clothes.

5. *Morals.*—The innate ideas of the Guiana Red man most nearly approaching to what, if he had ever for himself attained to any higher stage of

culture, would have been his religion have been briefly indicated above, and it now remains to note what, under the restraints of this very primitive philosophy of his, is his line of conduct towards all outside himself. As a matter of fact, his morality, like his religion, is purely egoistic. Whatever he does he does for himself. His 'wives'—he is naturally a polygamist—are no part of himself; and, so far as he takes trouble for them (and he habitually does much in this way), it is because they are good—i.e. useful—to him. On the other hand, his children—one of the chief uses of his wives is to bear children to him—are (the boys at least) part of himself, and are cherished accordingly. This difference in his personal relation towards his wives and his children is clearly indicated in his practice of the remarkable custom of *couvade*, in accordance with which, as soon as the child is born, the mother, as a matter of course, at once resumes her ordinary daily tasks; but the father not only refrains from hunting and all similar hard tasks, but lies in his hammock, and is even nursed. The explanation of this strange custom seems to be that a part of the father's being is supposed to have been separated from him and embodied in the child. It is the recently separated father and child who require nursing—much as, in the process of plant propagation by cuttings, the first necessity is to provide for the healing of the wounds on stock and on offset.

Moreover, it is the egoism of the Red man which regulates the more or less kindly bearing—in proportion as the co-operation of these is useful—towards his relations other than his descendants, and towards Red men of groups other than that to which he belongs. Again, it is his egoism, carried to a more or less extreme form, which regulates his greater or less hostility towards strangers—whatever the colour of their skin—so long as he suspects them of possible evil intention towards himself.

Finally, the present writer is anxious to make it quite plain that, in attributing to the Guiana Red men an extreme form of egoism as the leading motive of life, he has no intention of disparaging them. It is only that the Guiana Indian is a survivor from a very primitive stage in the development of mankind, from a stage before the first glimmering perception of the habit of altruism had given the impetus which really started a portion of the human race along the road which, after many centuries, led so-called civilized folk to a point whence they see the universe in a light so different from that in which the Guiana Red men—and a good many other equally primitive folk—see it.

The most practical lesson to be derived from all this seems to be that the difficulty of suddenly imposing our very much and differently elaborated system of thought, religion, and morality, on such folk as the Red men of Guiana is enormous, that the task should not be undertaken except after as full an understanding as possible of the conditions, and that it can be accomplished only, if at all, by civilized teachers who have agreed among themselves as to what exactly to teach.

LITERATURE.—Sir Walter Raleigh's *Discovery of Guiana*, ed. Robert Schomburgk (Hakluyt Society), London, 1848; J. J. Hartsinck, *Beschryving van Guiana*, Amsterdam, 1770; J. G. Stedman, *Surinam . . . on the Wild Coast of Guiana*, London, 1796; L. S. van's Gravesande, *The Rise of British Guiana* (Hakluyt Society), London, 1911; G. Pinckard, *Notes on the West Indies*, do. 1808; R. Schomburgk, *Reisen in Brit. Guiana*, Leipzig, 1840-44; W. H. Brett, *Indian Tribes of Guiana*, London, 1868; W. G. Palgrave, *Dutch Guiana*, do. 1876; E. Im Thurn, *Among the Indians of Guiana*, do. 1883; J. Rodway, *Guiana, British, French, and Dutch*, do. 1919; H. Ternaux-Compans, *Notice historique de la Guyane française*, Paris, 1843; T. Waltz, *Anthropol. der Naturvölker*, ii., Leipzig, 1870.

E. IM THURN.

GUILD.—See GILD.

GUILT.—See SIN.

GUINEA (Africa).—See NEGROES AND WEST AFRICA.

GŪJAR (Skr. *Gurjara*, the country now known as N. Gūjarāt and Rājputāna which took its title from a tribe of the same name entering India in the train of the Huns [V. A. Smith, *JRAS*, Jan.-Apr. 1909; D. R. Bhandarkar, *JASB*, 1909, p. 167 ff.]).—A tribe of cultivators, herdsmen, and cattle thieves, which at the census of 1901 numbered 2,103,023, found in the largest numbers in the Panjāb, Rājputāna, United Provinces, and Kashmir. The theory of Cunningham (*Archæological Reports*, ii. 64), that they are connected with the Yueh-chi tribe of Central Asia, afterwards known as the Tokhari, is rejected by Risley (*ICR*, 1901, i. 513 f.) on the ground that the latter are almost certainly of the brachycephalic type, while the Gūjar is dolichocephalic. He therefore includes them in what he calls the 'Indo-Aryan branch.' It is, however, certain that during the first five centuries A.D. hosts of the Scythian and Hun invaders of N. India became absorbed in the indigenous population, and were adopted into Hinduism (Smith, *Early Hist. of India*², 1908, p. 375 ff.). In their purest form at present they seem to be found in Kashmir, where Drew (*Jummoo and Kashmir Territories*, 1875, p. 199 f.), though he does not regard them as 'high Aryan,' found some with eyes lighter in colour than are common among other tribes of the country. There is much in the physique and customs of the Gūjars which renders it probable that they are connected with Central Asian tribes.

In religion, the Gūjars of the Panjāb have been largely converted to Islām, and not far from half their total number now follow that faith. In the United Provinces and Rājputāna they are still largely Hindu. In the W. districts of the United Provinces they are usually worshippers of Śiva and of the Śakti, or Mother-goddesses, and in particular of Sitalā Bhavānī, who controls small-pox. They also worship the local village-gods, such as Chāmar, and two tribal deities, Pyāreji and Bābā Sabhā Rām. The latter are deified heroes of the tribe. Pyāreji, whose shrine is in the Sahāranpur District, flourished early in the 17th cent. A.D. He was one of the marvellous children of the folk-tales, and, when he grew up, the tribe was severely afflicted by the ghosts of certain Brāhmins whom they had slain by treachery. Pyāreji, who had by that time acquired saintly powers, exorcized the evil spirits, and the reputation which he thus acquired earned for him Divine honours. The management of his shrine still remains in the hands of his descendants, who have now joined the Vaiṣṇavite sect. Bābā Sabhā Rām was another worthy of the same class, who is worshipped at a shrine on the banks of the Jumnā in the Ambāla District. The Panjāb Gūjars are specially devoted to the cult of the saint Sarwar, whose shrine is at Sakhi Sarwar (q.v.) (Maclagan, *Panjāb Census Report*, 1891, i. 136).

The Musalmān branch of the tribe, in spite of their conversion, continue to follow many of the animistic practices of their Hindu forefathers, such as the ceremony of waving lights over a bride to scare evil spirits. They consult Brāhman astrologers to fix lucky times for domestic rites; and they worship not so much Allāh as a host of deified heroes and saints, such as Ghāzī Miyān, the saint of Bahrāich in Oudh, Madār Ṣāhib, and other martyrs of the faith. In some parts of the Panjāb, members of the tribe claim the hereditary power of wonder-working and curing disease. The head of one sept in the Jhīlam District pretends to cure

a skin disease which causes baldness, by pulling out a single hair from the head of the patient. He practises only on one Sunday in the month, and must accept no fee, because that condition was imposed by the *faqir* who conferred the power upon his ancestor many generations ago (Rose, i. 162). A branch of the tribe in the Hazāra District shows that its conversion to Islām is recent and incomplete, by the retention of Hindu rules of eating, keeping strictly for personal use the vessels employed in cooking, practising purification before prayer, and praying with the hands downwards instead of upwards, as is the usual custom with Muhammadans (PNQ ii. 45). The Gūjars in the Bharatpur State of Rājputāna have a curious custom of making a cow of cow-dung, covering it with cotton, and then going through a rite of symbolical slaughter of the image. This seems to imply some form of totemistic communion, or a commutation of the actual killing of the sacred animal. The latter explanation is accepted by the neighbouring tribes, who consider that the Gūjars are degraded by the rite (Rājputāna Gazetteer, i. [1879] 162). In W. India many of the tribe have joined the Jain community, while others follow the Vaiṣṇava Vallabhāchārya sect.

LITERATURE.—D. C. J. Ibbetson, *Punjab Ethnography*, Calcutta, 1883, p. 262f.; H. A. Rose, *Census Report Panjāb*, 1901, i. 324; F. Drew, *The Jummoo and Kashmir Territories*, London, 1876, p. 109ff.; W. Crooke, *TC*, Calcutta, 1896, ii. 439ff.; *BG* i. pt. i. 21, v. 67, x. 120, xii. 67; J. Kennedy, 'The Child Krishna, Christianity, and the Gujars,' in *JRAS*, Oct. 1907.

W. CROOKE.

GUNA.—This is one of the most characteristic technical terms of the Sāṅkhya (*q.v.*) philosophy. This system explains the evolution of primitive matter (*prakṛti* or *pradhāna*) and the infinite variety of the universe by the hypothesis that primitive matter, in spite of its unity and indivisibility, is composed of three different substances, termed *guṇas*. Since the Sanskrit word *guṇa* signifies 'quality' in addition to its earlier meaning 'constituent,' the later signification was formerly adopted for the technical Sāṅkhya term, and primitive matter was said to be composed of the 'three qualities.' This rendering, however, is incorrect. The three *guṇas* in the Sāṅkhya philosophy are nothing but the constituents of primitive matter (or of the material universe, developed from primitive matter), as is proved by the express declarations of the Sāṅkhya texts and by the connexion of the doctrines. The view maintained by H. Jacobi does not practically differ from this, when he contends (*GGA*, 1895, p. 203f.) that, although the three *guṇas* are regarded by the extant Sāṅkhya authorities as constituents of primitive matter, the term originally denoted 'quality,' since the Sāṅkhya system, as he maintains, goes back to a period at which to the Indian consciousness the categories of quality and substance were not clearly distinguished.

The three *guṇas* bear the names of *sattva*, *rajas*, and *tamas*. To assign to these, however, their etymological meanings of 'goodness,' 'passion,' and 'darkness' would be misleading; and, indeed, the terms do not admit of exact translation. The founder of the Sāṅkhya philosophy regarded as most important for men those qualities in objects which excite either pleasure or pain or indifference (apathy, insensibility). Pleasure was associated with the ideas of brightness and lightness, pain with those of incitation and movement (activity), apathy with those of heaviness and restraint. The conclusion was then drawn that all matter is composed of three elements, each of which is manifested especially in one of the three above-mentioned dispositions. The author of the Sāṅkhya system further explains the profusion of

material products and the variety of impressions by the unequal and varying combination of the three constituents, which everywhere contend with one another, and give more or less complete expression to their own essential nature, according to the measure of success attained by one or two, in suppressing both the others or the third at some particular place. If the several constituents are allowed to develop freely, *sattva* is manifested in the object as light and buoyancy, in the subject as virtue, benevolence, happiness, cheerfulness, etc.; *rajas* in the realm of objects as force and movement, in the subject as every kind of suffering, anxiety, passion, wickedness, etc., but also as ambition, effort, and activity; *tamas* in the realm of objects as heaviness, rigidity, and darkness, in the subject as cowardice, fear, stupidity, sloth, etc. According to this theory, *sattva* predominates in the world of the gods, *rajas* in that of men, *tamas* in that of animals, plants, and minerals.

The most remarkable feature of this whole theory is clearly that it traces the characteristics of men back to physical causes. The relation of the three *guṇas* to human belief and sentiment, modes of life and action, is described in the 17th and 18th chapters of the Bhagavad-Gītā.¹ It is a remarkable doctrine also that pleasure, pain, and apathy not only exist as subjective and individual experiences, but have their objectively real correlatives in the external world.

Every process in the material universe depends, according to the doctrine of the Sāṅkhya, upon the action of one or more of the *guṇas*. In spite of the infinite variety of the modifications to which they are subjected, every phenomenon, every development, and every change is explained by the qualities of these three elements. If, however, *sattva* and *rajas* and *tamas* have a place in all products, it is a necessary inference, from the principle that the product is simply the material cause in a definite stage of evolution, that they must have already existed in that first cause, *i.e.* in primitive matter. As *sattva*, *rajas*, and *tamas* in the form of the product (*kārya-rūpa*) fashion the universe as it exists, so in the form of the cause (*kāraṇa-rūpa*) they fashion the primitive matter before evolution begins. Is it possible, however, for the infinite indivisible primitive matter to be fashioned by three finite elements? Can it consist altogether of parts? The answer given to the second question is in the affirmative, just as a single river may consist of three tributary streams. And in reply to the first the explanation is offered that the three constituents are finite only in the sense that *sattva*, *rajas*, and *tamas* are not present in their entirety everywhere, but that, on the other hand, there is no point in the universe where at least a minimum of these three elements is not to be found. As long as primitive matter remains quiescent, the three *guṇas*, according to the doctrine of the Sāṅkhya, continue in a state of equilibrium. While this condition lasts, during which the constituents remain unrelated to one another, all the forces and qualities which display themselves in the developed universe are latent and inactive as germs in primitive matter. It must not, however, be inferred that during this period the three *guṇas* are completely at rest; that would be contrary to the nature of these elements, which are in a state of ceaseless change. It is rather that in primitive matter, before evolution begins, an isolated movement takes place within each separate *guṇa* in such a way that each of the *guṇas* is transformed into an equivalent to itself, *i.e.* *sattva* becomes only *sattva*, etc.

When the state of equilibrium of the three *guṇas*

¹ Translated into English by J. Davies, 3rd ed. 1894; K. T. Telang, *SBE* viii., 2nd ed. 1898; L. Barnett, London, 1905.

is disturbed, and they begin to contend with one another, the universe is evolved in the way described in the article SĀṆKHYA. This philosophy ascribes the breaking up of the stable equilibrium of the three *gunas*, i.e. the close of the inert and undeveloped state of primitive matter, to the mechanical influence exerted by the souls on the primitive matter which stands to them in a relation of perpetual dependence. Those actions of living beings which in the previous age of the universe have not yet received their recompense claim reward or punishment in a new age. Forthwith merit and demerit, which had slumbered during the period of the dissolution of the universe, awake to life, and proceed to call into existence a new creation. When the process of evolution of primitive matter has reached its conclusion, a period of stability follows, during which the creative force of Nature brings into being individuals and particular products. To this period of the world's existence the three *gunas* maintain everywhere throughout the universe an unceasing strife for the ascendancy. At the close of the period of stability, and therefore of an age of the universe, reabsorption commences, the products of the gross elements returning successively in reverse order into their material causes, until primitive matter is again found in the same condition as before evolution began, and the state of equilibrium of the three *gunas* is again established. This alternation of the rise and dissolution of the universe is repeated in a perpetual cycle without beginning or end.

It is obvious that this whole theory of the three *gunas* as taught by the Sāṅkhya is a pure hypothesis, which shares the fate of very many other hypotheses of philosophy, and cannot hold its ground from the modern scientific point of view. It is nevertheless an interesting essay in explanation, which to the Indian mind has appeared possessed of such convincing force that the idea has become absolutely the common property of all philosophical Sanskrit literature. Even at the present day the entire circle of philosophical conceptions in India is controlled by the theory of the three *gunas*.

LITERATURE.—R. Garbe, *Die Sāṅkhya-Philosophie*, Leipzig, 1894, p. 200 ff.; F. Max Müller, *Six Systems of Indian Philosophy*, London, 1899, pp. 146 f., 234 f., 343 ff.; *Sarva-darśana-saṅgraha*, tr. E. B. Cowell and A. E. Gough, 2nd ed., London, 1894, pp. 221-230.

R. GARBE.

GÜNTHERIANISM.—Güntherianism is the name given to a rather vaguely defined body of teaching, mainly philosophical in scope, but with important bearings upon certain theological dogmas, which originated in the writings of Anthon Günther (born 17th Nov. 1783 at Lindenau in Bohemia; died at Vienna, 24th Feb. 1863).

1. *Life of Günther.*—He was the son of devout Roman Catholic parents; but, giving himself in his youth to the study of Kant, Fichte, Schelling, etc., he seems for a while to have been seriously shaken in his religious convictions. When, however, in 1811 he moved to Vienna with the household of Prince Bretzenheim, in which he acted as tutor, he fell under the influence of Clement Mary Hofbauer, afterwards canonized, with the result that his faith in Christianity revived, and he set himself eventually to study for the priesthood. Two years after his ordination (1820) he entered the Jesuit novitiate, but found that he had no vocation, and then for the remainder of his days (1824-63) he settled down quietly at Vienna as *Privatgelehrter*, giving some part of his time to pastoral work, but occupied mainly with philosophical and theological speculations. For more than twenty years he acted as official censor to a Government which still subjected literature to theological revision. He refused tempting offers of a professorship at Munich, Bonn, Breslau, and Tübingen, probably in the hope of ultimately securing a similar distinction at Vienna itself; but, before the opportunity came, his writings, many of which were much controverted and discussed, had brought his orthodoxy under suspicion. Finally, in 1857, his books were placed on the Index at Rome, though due recognition was given to his personal integrity and good intentions. Günther submitted to the condemnation, but it filled his remaining years with bitterness.

2. *System.*—It was the purpose of Günther to build up a philosophical system in opposition to

the prevalent Hegelian pantheism, which he considered the philosophy of the schoolmen was inadequate to meet. Consequently we find in his writings a certain fundamental dualism (which attains its climax in the antithesis between God and the created universe) dominating all his speculations. Nor can the student of his works, casual and unsystematic though they be, resist the suspicion that the development of his ideas has been guided by an exaggerated desire to discover analogies and symmetrical features in every field of thought, and that the anticipation of being able to provide some sort of natural explanation of the great Christian dogmas of faith has moulded, consciously or unconsciously, the whole of his psychological theory. It was a conspicuous element, if not a fundamental principle, of Günther's teaching that there is no real distinction between the truths demonstrable by human reason and the mysteries of faith. The latter are not to be regarded as beyond the range of human intelligence unaided by revelation. On the contrary, he maintained that pure reason is capable of demonstrating the 'why,' though not the 'how,' of such revealed dogmas as the Trinity and the Incarnation. Revelation he held to be only hypothetically necessary; that is to say, in so far as man's intelligence had been clouded and impaired by original sin. From this position it resulted that reason is the supreme arbiter, and ought not to be regarded as the handmaid of faith—a view, as the Papal condemnation pointed out, which laid itself open to the objection that knowledge and faith are not distinct things, and, further, that the dogmas of faith may change as knowledge is perfected. These theological conceptions rested on a philosophical basis which seems to have been devised expressly to support them.

Like Descartes, Günther made psychological consciousness his starting-point. Man, he said, acquires the consciousness of himself, of his ego, not immediately, but by means of the faculties of the ego, its 'receptivity' and its 'spontaneity' (that is to say, the understanding and the will), the acts of which bring the spirit (*Geist*) face to face with the ego, which is the reason and foundation of both. Starting from the ego, Günther, by an inferential process again analogous to that of Descartes, sets out to demonstrate the existence of God, as well as of 'nature' and of 'spirit,' with their attributes and mutual relations, the whole system being pervaded by a sort of symbolical reflexion of the relations which he discovers between the Persons of the Trinity. In the Trinity he recognizes three egos, which he describes as thesis, antithesis, and synthesis; or, again, as absolute subject, absolute object, and absolute subject-object, trying in this way to give an account of the genetic nexus between Father, Son, and Holy Ghost. Corresponding to this, when God, not, properly speaking, free, but necessitated by the Divine essence, created the universe, a trinity of elements resulted, consisting of spirit (subject or thesis), nature (object or antithesis), and man (subject-object or synthesis). Apart from these three things there can be no universe. Their 'form' is one, but their essence is threefold, this being the very opposite of what we find in God, where there are three egos, three substances, and a single essence. From this point of view it may be said that creation is an inverted God (*verkehrter Gott*) or a 'contraposition' of God.

Similarly, in his psychological analysis of man's constitution and mental processes, Günther finds an aid to the comprehension of the mystery of the Incarnation. In man, he says, there are three elements—body, psychic principle (*Seele*), and spirit (*Geist*). The psychic principle is the product of

'nature,' and is not directly created by God. Nevertheless, it is the seat of imagination, memory, and an understanding which forms concepts (*Begriffe*), and which in so far may be said to 'think.' But the reflex processes by which we form ideas (*Ideen*), and by which we penetrate to the being of things as distinguished from their appearances, belong to the spirit. This spirit in every man is hypostatically united to the psychic principle, and from this results a certain 'communication of idioms' between the faculties belonging to the spirit (i.e. reason and will) and the imagination, memory, and understanding, which are the functions of the psychic principle. This teaching concerning the psychic principle, which runs expressly counter to the scholastic axiom that the soul (*anima rationalis*) is the true and immediate 'form' of the body, was also specially noticed in the Papal condemnation of 1857.

These illustrations may suffice to indicate the general trend of Günther's teaching. The more philosophical aspects of it have been re-constructed and systematized by his disciples, notably by Theodor Weber in his *Metaphysik* (2 vols., Gotha, 1888-91). Weber was an Old Catholic who acted as vicar-general to Bishop J. H. Reinkens of Bonn, himself also a Güntherian; and it may be said that, so far as Güntherianism has any followers at the present day, it is among the Old Catholic body that they are found. With the exception of J. E. Veith, most of the prominent disciples of Günther, like P. Knoodt, his biographer, joined the Old Catholic movement after the Vatican Council.

LITERATURE.—A full account of Günther's life and writings is given by P. Knoodt, *Anton Günther, eine Biographie*, 2 vols., Vienna, 1881. Günther's own works, apart from contributions to periodical literature, were the following: *Vorschule zur spek. Theologie*, 2 vols., Vienna, 1828-29 (2 1846-48); *Peregrins Gastmahl*, do. 1830; *Süd- u. Nordlichter am Horizonte spek. Theologie*, do. 1832; *Janusköpfe f. Philos. u. Theologie* (in conjunction with J. H. Papst), do. 1833; *Der letzte Symboliker*, do. 1834; *Thomas a Scrupulis*, do. 1835; *Die Juste-Milteus in der deutsch. Philos. gegenw. Zeit*, do. 1838; *Eurystheus u. Herakles*, do. 1843; *Lydia* (a philosophical annual, published in conjunction with J. E. Veith), do. 1849-54. His collected works were issued at Vienna in 1882 in 9 vols. Among the numerous critics of his system may be mentioned in particular: F. J. Clemens, who, in 1863, published at Cologne several pamphlets attacking Güntherianism from the orthodox Roman standpoint; and J. Kleutgen, who, in his *Theol. der Vorzeit*² (5 vols., Münster, 1867-74), has devoted much attention to Günther. More summary accounts may be found in Wetzer-Welte², Freiburg, 1888, v. 1324; in *PRE*³; in Ueberweg, *Gesch. der Philos.* iv.¹⁰ [Berlin, 1906] 189 ff.; and in *The Catholic Encyclopædia*, New York, 1910, vii. 85.

HERBERT THURSTON.

GURKHĀ, GORKHĀ.—The dominant tribe in Nepāl, which takes its name from the District of Gorkhā in the N.E. portion of the valley of the river Gandak, between the rivers Trisūlgāngā and Svetī Gandak, the chief town being Gorkhā, 56 miles W. of Kāthmāndū (*q.v.*), the present capital of the country. The name *Gorkhā* is popularly interpreted to mean 'cow-protector' (Skr. *gorakṣa*); by others it is connected with that of the national saint, Gorakhnāth (*q.v.*), a mysterious figure of whom the recorded history is little more than legend (Wright, *Hist. of Nepāl*, Camb. 1877, p. 140 ff.; H. H. Wilson, *Essays*, i. 213); but it is more probably a local name which has acquired its present form and interpretation under Brāhman influence. The present dynasty claims Rājput origin, tracing back its lineage to the son of Rājā Samarṣi of Chithor in Rājputāna in the 12th cent. A.D. But the recorded genealogies begin with Mahārājā Dravya Sāh (A.D. 1559, a date confirmed by the MSS collected by Bendall [Wright, p. 289; *JASB* lxxii. 17]). A member of this dynasty, Prthivi Nārāyan, in 1769 expelled the ruling house said to have been founded by Hari Simha Deva, Rājā of Mithila, or N. Bihār, in A.D. 1332.

1. The term Gorkhā, as usually employed, is vague. It is not limited to any particular class or

clan, but is applied to all those races whose ancestors occupied the country of Gorkhā, and subsequently, from this centre, extended their conquests far and wide over the E. and W. hills. In practice, among Europeans, it is applied to the classes from which the British Nepalese regiments are recruited, such as the tribes of Khas, Gurung, and Mangar (Vansittart, p. 213; Gait, *Census Report Bengal*, 1901, i. 452). The Khas certainly belong to the Mongoloid family; but from the 12th cent. downwards the tide of Muhammadan conquest and bigoted persecution spread over Hindustān, and numbers of Brāhmins and other high-caste Hindus took refuge in Nepāl. In order to secure the spread of Hinduism in their new home, they raised the earlier and more distinguished converts to the rank of the *kṣatriya*, or Hindu warrior, class. Moreover, they cohabited with women of the country, who insisted that their children also should be raised to a position of dignity.

'To this progeny also, then, the Brāhmins, in still greater defiance of their creed, communicated the rank of the second order of Hinduism; and from these two roots, mainly, sprung the now numerous, predominant, and extensively ramified, tribe of the *Khas*—originally the name of a small clan of creedless barbarians, now the proud title of the *Kshatriya* or military order of the Kingdom of Nepal' (Hodgson, *JASB*, 1833, p. 217; Gait, *op. cit.* i. 456).

2. The Khas, Gurung, and Mangar.—The Khas have, since the Brāhman immigration, received a considerable admixture of Aryan blood; they speak an Aryan language, have largely come under Hindu influence, and are now the predominant race of the country, claiming the right to wear the Brāhmanical thread, and supplying many officers to the national army. The Gurung, on the other hand, one of the best fighting tribes of the country, retain the comparatively pure Mongoloid type. In their own country they are generally Buddhists. But they

'still retain pronounced traces of the primitive animism which they professed before their conversion to Buddhism, and worship the mountains and rivers, offering flowers and grass to the former and food to the latter. This worship seems to be of a propitiatory kind, and is celebrated more particularly for recovery from illness or relief from domestic calamity. Brāhmins serve them as priests, but if no Brāhman is available, a member of the Guaburi *thar* (sept) may take his place and may perform the ceremonies of marriage and disposal of the dead and *nuarmi*, or purification after childbirth' (Risley, *TC*, Calcutta, 1891, i. 305).

Sometimes, when at home, they employ a *lāma*, or local Buddhist priest; but, when serving with British regiments in India, they resort to Brāhmins for all religious purposes. The beliefs of the Mangar are of the same kind; and 'may best be described as lax Hinduism tempered by survivals of an earlier animistic cult.' Brāhmins assist them in the worship of the orthodox Hindu gods; but the more primitive household deities are worshipped by the headman of the family without the assistance of any priest (*ib.* ii. 75).

In short, Hinduism is a more fashionable and respectable creed than the lax, degraded Buddhism which prevails in the cis-Himalayan region, and has absorbed the animistic beliefs which preceded both Hinduism and Buddhism. Hence all Gurkhās belonging to British regiments are practically Hindus; they are served in religious matters by Brāhman priests, and celebrate all the usual Hindu festivals. Among these the *Dasahrā*, 'the taker-away of ten sins,' the feast celebrated on the 10th of the light half of the month Jeth (May-June), at which the weapons of war are worshipped and animal-sacrifices are offered, is the most popular because it is congenial to the animistic beliefs which form the real basis of their religion. Though nominally Hindu, the bonds of caste sit lightly upon them. The food restrictions apply only to pulse and rice, which must be cooked by each man for himself, and with due regard to the laws of ceremonial purity. Anything else all Gurkhās

will eat in common; and the only prohibited meats are beef, the flesh of the *nilgāi*, or blue bull (*Boselaphus tragocamelus*), and that of female goats, which none save menials will touch. Game and fish are also allowed, and Gurung use buffalo meat in their own country—a practice which they deny when serving with their more Hinduized brethren (Vansittart, *loc. cit.*). This laxity of caste restrictions makes the Gurkhā specially valuable on field service, and tends towards greater comradeship between him and the British soldier, particularly in Highland regiments, than is possible in the case of Indian sepoy, who are more scrupulous in matters of food and drink.

3. The Gurkhā religion.—The religion of the Gurkhās is thus of a mixed character. The present ruling dynasty, like all new converts, follows the tenets of Hinduism with more anxious care than many of their co-religionists in the Indian plains. They have a great reverence for Brāhmins, and the slaughter of the sacred cow is rigorously prohibited. The result is a very decided observance of orthodox Hinduism. Thus, though at present in the Indian plains there is little actual worship of Indra, the Vedic god of the firmament, except in a vague way for the purpose of securing timely falls of rain, in Nepāl there is a regular feast in his honour, the *Indrajātra*. But it is significant that this is combined with a car-festival, the *Rathjātra*, in honour of Devī Kumārī, the maiden goddess—one of the many forms of her cultus which has probably been derived from the indigenous Animism. This local cult of Indra, however, may have been, in a great measure, derived from Buddhism, Indra or Sakra being a favourite object of worship among the later Buddhists (Oldfield, ii. 312 ff.; Wright, p. 38; Waddell, *Buddhism of Tibet*, Lond. 1895, p. 356). Śiva is worshipped under the forms of Sambhunātha, 'the Lord, giver of prosperity,' and Paśupatinātha, 'lord of cattle,' the latter cult probably absorbing some of the primitive theriolatry. The Sivarātri feast, 'the night of Śiva,' is very popular, the principal object of worship being the four-faced *linga* which stands in the temple of Mahādeva at Paśupati. To this prayers and offerings are made; fees are given to the presiding Brāhmins, who pour water on the *linga*, wash it, and cover it with flowers. When this rite is over, the officiating priest, after repeating sacred verses, reads out of the holy books the many names and epithets of Śiva, while the worshippers fling leaves of the Bel tree (*Aegle marmelos*) over the top of the *linga* (Oldfield, ii. 321). Equally popular is the worship of his consort in one or other of her many forms. The chronicler, writing of the king Sivadeva-varma of the ancient Sūryavarmāi dynasty, says that, recognizing that Bachlā Devī was the principal deity of Nepāl, he ordered that after the worship of Śiva as Paśupatinātha a cloth should be tied by one end to his temple and the other to the palace, the object being to bring him into mystic contact with the goddess (Wright, p. 128). In her form of Devī Bhairavī she is the guardian deity of a considerable district; and in another shape she is honoured at the *Durgā-pūjā* or *Dasahra* festival, with annual sacrifices. Here, however, as is the case in Bengal, a clay image of the goddess is not made; but on the first day of the festival the Brāhmins sow barley on the spot where they worship, and sprinkle it daily with sacred water. On the tenth day of the feast they pull it up and present small bunches of it to their followers, in return for presents which they receive from them—a case of the 'gardens of Adonis' of which Frazer has collected many instances (Wright, p. 39; Frazer, *Adonis, Attis, Osiris*, London, 1907, p. 194 ff.). The more savage and purely animistic conception under which the goddess is regarded is shown

by the proceedings of the Gurkhā Rājā, Ran Bahādur, in A.D. 1800. His Brāhman paramour, after recovery from an attack of smallpox, finding that she had lost her beauty, and with it her influence over her lover, committed suicide. Thereupon the Rājā vented his rage on the shrines of Devī, to whom he had in vain made supplications for the recovery of his mistress. Some smaller shrines, and the large temple of Devī, known as Talējū, near the palace at Kāthmāndū, were desecrated and defiled; filth was thrown on the images; worship was forbidden; and the *baidis*, or physicians, were executed (Oldfield, i. 285 f.; Wright, p. 262).

The mixture of creeds is shown by the temple dedications at the chief sacred cities. Śiva as Mahādeva and Sambhunātha has shrines at Kāthmāndū; Viṣṇu as Jagannāth and Nārāyaṇa has temples in the same city, that of the former having been erected by Mahārājā Jang Bahādur; Devī at Kāthmāndū and Lalita Patan; Bāgh Bhairon, or Śiva in his tiger form, one of the aboriginal deities, at Kirtipur; and Gaṇeśa at Kirtipur and Bhatgāmv. Finally, according to Oldfield (ii. 284 f.),

'there is so close a connection between Hinduism and Buddhism, and the one religion seems to pass into the other so insensibly, that it is difficult to draw the exact line of difference between them. Nothing is more common than to see shrines dedicated to Hindu deities (Viṣṇu, Gaṇeśa, and Garuḍa) or reliefs representing them, not only within the precincts of a Buddhist temple, but actually forming part of it.'

But this refers more to the popular than to the orthodox worship. Even under the mild and tolerant Newār sovereigns the strongest influence was exercised to induce the Buddhists to adopt the creed and customs of the Hindus who were then dominant in the country; and their successors, 'the bigoted Gorkhas, regarded the Buddhism which existed in their newly-acquired provinces as a creed which was, at the same time, too contemptible to be feared, and too heretical to be in any way encouraged. . . . It is now in the last stage of its existence; it is rapidly being supplanted by Hinduism; and before the lapse of another century the religion of Buddha, after enduring for upwards of two thousand years, will, in all probability, be as extinct in Nepāl as in the plains of Hindustān.'

LITERATURE.—The earliest and still the best authority on the religion of the Gurkhās is Brian H. Hodgson, the author of numerous papers on the subject, some of which have been collected in *Essays on the Languages, Literatures, and Religion of Nepal and Tibet*, London, 1874; see also W. Kirkpatrick, *Account of Nepal, in 1793*, do. 1811; T. Smith, *Five Years' Residence at Nepal*, do. 1852; Laurence Oliphant, *A Journey to Katmandu*, do. 1852; O. Cavenagh, *Rough Notes on Nepal*, do. 1851; and, in particular, F. Buchanan (formerly Hamilton), *An Account of the Kingdom of Nepal, and of the Territories annexed by the House of Gorkha*, do. 1819; H. A. Oldfield, *Sketches from Nipal, Historical and Descriptive, Essay on Nipalish Buddhism, etc.*, do. 1880; H. Vansittart, 'Tribes, Clans, and Castes of Nepal,' *JASB*, vol. lxiii. pt. i. p. 213 ff.

W. CROOKE.

GURU.—See BHAKTI-MĀRGA, vol. ii. p. 546.

GUSAIN.—See GOSAIN.

GWĀLIOR (Hindī *Gwālīār*, said by Cunningham to take its name from the shrine of the hermit Guālīpā, the cow-keeper saint).—The celebrated fortress, capital city of the Gwālīor State in Central India; lat. 26° 13' N., long. 78° 12' E. The religious buildings in the fort consist of two remarkable temples, and a series of caves or rock-cut sculptures. One of the temples is now known as *Sāsbahū*, which is interpreted to mean 'mother-in-law and daughter-in-law'; but the name is really derived from *Sahasra-bāhu*, 'the thousand-armed,' an epithet of Śiva. An inscription dated A.D. 1093 opens with an invocation to Padmanātha, who has been identified with Padmaprabha, the sixth Jain *tīrthānkara*, or hierarch. But there are numerous sculptures of Brahmā, Viṣṇu, and Śiva, that of Viṣṇu being the central figure over the main entrances of the portico and sacrarium; and Cunningham therefore concludes that the

building was originally dedicated to his worship, the name *Padmanātha* being not of Jain origin, but applied to Viṣṇu in the sense of 'lord of the lotus.' This temple is now in ruins, the cruciform porch alone remaining, though in a dilapidated condition. The second great temple is the loftiest building on the hill, and forms the most conspicuous object in the view from every side of the fortress. Its original name is now lost, and it is known as *Teli Mandir*, the 'oilman's temple,' from the person at whose expense it is said to have been built. The design of the temple resembles that of several of the S. Indian shrines. It seems to have been originally dedicated to Viṣṇu; but over a later doorway is a figure of Gaṇeśa, which shows that the followers of Śiva subsequently adapted it to their worship. They also introduced the *linga* and the image of the bull Nandi. The earliest inscriptions referring to the worship of Viṣṇu belong to the 9th and 10th centuries A.D.; and the temple seems to have been adapted to Saivite worship as early as the middle of the 15th century. There is also a true Jain temple, discovered by Cunningham, and one of the Mother-goddess, *Mātā Devī*, besides other less important shrines. The rock-sculptures are unique in N. India for their number as well as for their gigantic size. They fall into several groups. That known as *Urwāhī* contains twenty-two principal figures, all of which are entirely naked. Inscriptions fix their date at 1440-53, under the Tomara Rājās. One figure is that of *Ādinātha* or *Ṛṣabhadeva*, the first Jain pontiff. The largest figure, not only of this group, but of all the *Gwālior* rock-sculptures, is a standing colossus, 57 ft. in height, near which is seated a second colossus, 30 ft. in height, of *Neminātha*, the twenty-second Jain hierarch. In the S.W. group the most remarkable figure is that of a sleeping female, 8 ft. in length, lying on her side, with her head to the south and her face to the west. Both thighs are straight, but the left leg is bent backward beneath the right. Next this is a seated group of a male and female with a child, whom Cunningham identifies with *Siddhārtha* and his wife *Triśalā*, the reputed father and mother of *Vardhamāna* or *Mahāvira*, the last of the twenty-four Jain pontiffs (Bühler, *Indian Sect of the Jainas*, Eng. tr., Lond. 1903, p. 25). The remarkable fact about these sculptures is that they were executed during a single generation of 33 years (A.D. 1441-1474).

LITERATURE.—The antiquities of *Gwālior* are fully described by A. Cunningham, *Archæological Reports*, ii. 330 ff.; see also W. H. Sleeman, *Rambles and Recollections*, London, 1893, i. 317 ff.; J. Fergusson, *Hist. of Indian and Eastern Architecture*, do. 1899, pp. 244 ff., 452, 461 f.; Fergusson-Burgess, *Cave Temples*, do. 1880, p. 509 ff. Some of the temples and statues are illustrated in W. H. Workman, *Through Town and Jungle*, do. 1904, p. 176 ff.

W. CROOKE.

GWĀLIOR STATE.—See CENTRAL INDIA.

GYPSIES.—A race of people inhabiting various countries of Europe, but distinguished from the surrounding populations by their special language, customs, and physical characteristics.

1. Name.—The name 'Gypsy,' or 'Gipsy,' is used only by English-speaking people, and is a corruption of 'Egyptian,' by which name the race in question was known in mediæval Europe, owing to the belief that these so-called 'Egyptians' were natives of Egypt, or, rather, of a country called 'Little Egypt.' In England the abbreviation 'Gypson' appears in 1513-23, 'Gipcy' in 1526, and 'Gipcyan' in 1536. What seems to be the first Scottish instance of the abbreviated form occurs in 1598, when the Privy Council Records state that Hew Bellenden, younger of Pendreich, was 'accompaneid with certane gipseis and divers

utheris' at Lasswade, Midlothian. But the full name 'Egyptian' was concurrently used with its abbreviations throughout Great Britain until the present day. The name 'Egyptian' has also been applied to this race in most of the countries of Europe, occurring in France and Belgium as 'Gyptien,' in the Netherlands as 'Gyptenaer,' and in Spain as 'Gitano' (from 'Egiptiano'). It was used in a Latin form in Hungary in 1490, as may be seen from the will of a Hungarian noble, Ladislas Hermanfy, now preserved in the archives of Prince Battyáni. The passage deserves quotation. In allocating four of his 'smaller horses,' the testator directs as follows, the language employed being Latin:

'The third, which I bought from the Egyptians or Czingany (*ab Egyptis sive Czinganis*), I leave to my servant Istók. This horse is a grey one, and used to be a carriage horse.'¹

Here an alternative name, very wide-spread in Europe, is introduced. It takes the following shapes: *Cingani* or *Acingani* (Corfu), *Tchinghiané* (Turkey), *Jinganih* (Syria), *Czigani* (Hungary), *Zigani* (Russia), *Cygan* (Poland), *Ciganos* (Portugal), *Tsiganes* (France), *Zigeuner* (Germany), *Zingari* (Italy), and *Zincali* (Spain).² The etymology of this name has given rise to much discussion, but without definite result. Many other names, more local in character, have been given to the Gypsies. In Spain they have been known as 'Greeks,' as 'Bohemians,' as 'Germans,' as 'Flemings,' and as 'New Castilians.' In France they have been variously designated 'Bohemians,' 'Saracens,' 'Cascarrots,' and 'Biscayans.' In the Netherlands they were not only 'Gyptenaers,' but also 'Greeks' and 'Heidens' (i.e. Heathens). They have been frequently styled 'Tartars,' notably in Scandinavia, where they are also called 'Fante-folk.' There are English instances of 'Bohemian Tartar' and 'High-German' applied to people who were probably Gypsies; while Scotland has references to 'Gypsies or Saracens,' otherwise 'Moors or Saracens,' as present in that country in the 15th century. In Poland they have been called 'Szalassi' and 'Philistines,' as well as 'Cygani.' Early writers have variously designated them 'Nubians,' 'Ethiopians,' 'Assyrians,' 'Uxii,' and 'Cilices.' Many of these names seem to denote the name of the country or province whence the Gypsies had come, bestowed upon them by the people of the country in which they had arrived.

2. Physical characteristics, distribution, etc.—The physical characteristics of Gypsies of pure stock, or nearly so, are well marked. Their complexion is generally dark, ranging from olive to deep brown, or even black. A. Weisbach, who examined 52 Gypsy soldiers from a Hungarian regiment, found the colour of their skin to be as follows: brown, 18; inclined to brown, 20; light brown, 8; inclined to yellow, 6.³ That is to say, the great majority were brown-skinned men. The colour of their hair accorded with their complexion. Of the whole number 33 were black-haired, 16 had hair of a dark brown, and 3 were brown-haired. The hue of the eyes was in the following proportions: dark brown, 28; brown, 15; light brown, 5; greyish brown, 2; and grey, 2. It will be seen, therefore, that the prevailing colour of skin, hair, and eyes was dark. Eugène Pittard, of Geneva, records similar results from an examination of 1270 Gypsies, of whom 840 were men and 430 women; 94 per cent of the men, and 88 per cent of the women had black or brown hair.

'The proportion of black-haired men was very remarkable,' observes Pittard. 'In many cases the colour of their hair was

¹ *Ethnographia*, Budapest, vol. i. no. 3, March 1890, p. 164.

² The *Sigynna* described by Herodotus (v. 9) as inhabiting Hungary have also been identified with the *Cygan*.

³ 'Die Zigeuner,' *Mitth. d. anthrop. Ges. in Wien*, 1889.

so intensely black that, taken in the mass, it had a bluish gleam like the plumage of a raven or a magpie. The expression "raven-black" commonly given to their hair is perfectly accurate. Light hair is very rare among them.¹

In this group, Pittard found that 86.6 per cent of the men, and 87.9 per cent of the women had dark eyes, grey or blue eyes being very rare.¹

But, although the typical Gypsy is of swarthy complexion, black-haired, and dark-eyed, it must be noted that certain members of that caste have not all of these characteristics. For example, a group of Carinthian Gypsies is thus described by Pincherle :

'Strange to say, the women were all blondes, with the exception of one who had the real Indian features and physique. The men were tall and portly; and they too, instead of being olive-coloured, were of a deep-red complexion. But they had the regular Gypsy features: oval face, low brow, ivory teeth, and jet-black hair, which fell in curls at the temples.'²

These were Romani-speaking people, living the Gypsy life, but differing from what is regarded as the typical Gypsy in complexion, although not in other physical characteristics. This is not a singular case, as could be shown from other references, and the fact requires to be kept in view.

Weisbach sums up the result of his examination of the 52 Gypsy soldiers in the following terms :

'These Gypsies are of middling height, bulk, and weight. Their distinctly mesocephalic head is small, and moderately contracted towards its base. The short neck, of average thickness, is placed upon a short, tapering body. They have very short arms, with the upper part short and slender. Their legs are long, much longer than their arms.'

On the question of craniology, however, Pittard is not in agreement with Weisbach, for the former states that the race is markedly dolichocephalic, the series of 1270 Gypsies examined by him having yielded 71.19 per cent of dolichocephalic forms. Isidore Kopernicki, eminent as a craniologist and also a keen student of the Gypsies, made a special investigation of this subject in his monograph 'Ueber den Bau der Zigeunerschädel,' contributed to the *AA* in 1872.³ Pittard adds that the Gypsies of the Balkan Peninsula have straight noses, inclined to aquiline. With regard to the stature of the Gypsies examined by him, he places that of the men at about 1 m. 649 (say 5 ft. 5 in.), and of the women at 1 m. 532, or a little over 5 feet.

Less scientific, but very illuminating, is Hugh Miller's description⁴ of a band of Cromarty 'tinklers,' or semi-Gypsies.

'They were a savage party, with a good deal of the true gipsy blood in them, but not without mixture of a broken-down class of apparently British descent. . . . There were two things that used to strike me as peculiar among these gipsies—a Hindu type of head, small of size, but with a considerable fulness of forehead, especially along the medial line, in the region, as the phrenologist would perhaps say, of individuality and comparison; and a singular posture assumed by the elderly females of the tribe in squatting before their fires, in which the elbow rested on the knees brought close together, the chin on the palms, and the entire figure (somewhat resembling in attitude a Mexican mummy) assumed an outlandish appearance, that reminded me of some of the more grotesque sculptures of Egypt and Hindustan. The peculiar type of head was derived, I doubt not, from an ancestry originally different from that of the settled races of the country; nor is it impossible that the peculiar position—unlike any I have ever seen Scottish females assume—was also of foreign origin.' Describing a certain visit to the cave in which those people were living, he observes: 'On a couch of dried fern sat evidently the central figure of the group, a young, sparkling-eyed brunette, more than ordinarily marked by the Hindu peculiarities of head and feature, and attended by a savage-looking fellow of about

¹ For these data, and many more, see Pittard's art. 'L'Étude anthropologique des Tsiganes,' in *Journal of the Gypsy Lore Society* (New Series), July 1908, vol. ii. no. 1. (In subsequent references, that journal, which is printed by T. and A. Constable, Edinburgh, will be indicated by the letters *JGLS*, the new and old series being differentiated by 'N.S.' and 'O.S.')

² *JGLS* (O.S.), January 1889, vol. i. no. 3.

³ Other studies in Gypsy anthropology, by Glück, Hovelacque, von Steinberg, Blasio, Petersen, and von Luschan, are cited by Pittard in *JGLS* (N.S.), July 1908, vol. ii. no. 1, p. 38 f., where he also refers to his numerous papers relating to this subject.

⁴ *My Schools and Schoolmasters*, ch. xvii.

twenty, dark as a mulatto, and with a profusion of long, flexible hair, black as jet, hanging down to his eyes, and clustering about his cheeks and neck.'

The last reference recalls the *coiffure* of Transylvanian Gypsy men at the present day, or of those seen by Coryat at Nevers, France, in 1608, whom he describes as 'having exceeding long black hair curled.'¹

The similarity between the Hindu and the Gypsy types, pointed out by Hugh Miller, has been commented upon by many writers, before and after his time. Nor is this similarity confined to physical characteristics; for the language of the Gypsies, essentially the same in all countries, although presenting local variations, is more akin to Hindustani than to any other living form of speech.

The numerals show this affinity very clearly: 1. *yek*; 2. *dui*; 3. *trin*; 4. *shidr*; 5. *pantch*; 6. *shōv*; 7. *efta*; 8. *okhto*; 9. *enta*; 10. *desh*, etc. Many words are identical in Romani and Hindustani: e.g. *pāni* (water), *kalo* (black), *shuri* (knife), *rāni* (lady or queen), *nak* (nose), and *bal* (hair). Groome points out that the sentence 'Go, see who knocks at the door,' is in Romani, *Jā, dik kon chalavela o vuddr*, and in Hindustani, *Jā, dekh kon chaldya ddr ko*. The two languages present, of course, many points of difference, but their kinship is undoubted. When and in what locality they began to diverge from the parent stem is unknown. Groome estimates that there are about one hundred Greek words in Romani, and nearly as many Slavic words; while there are also a few words of Persian, Armenian, Rumanian, Magyar, and German origin. The existence of an Arabic element is disputed.

Although there is a common belief that Gypsies are homeless wanderers, they are for the most part a sedentary people, only occasionally showing nomadic tendencies. In the official 'Report on the Gypsy Problem,' drawn up by Arthur Thesleff in 1900, and published at Helsingfors in 1901, the following definite statements are made with regard to the Hungarian division of the race:

'The number of Gypsies in Hungary amounts to some 280,000, of whom about nine-tenths are settled, 7½ per cent. belong to the uncertain class who have sojourned for some considerable time in one place, and about 9000 are out-and-out wanderers. The densest Gypsy population is to be found in Transylvania; there are in the country at least 40,000 Gypsy children of the age for compulsory school-attendance who have not attended any school. Of the whole Gypsy population 61.74 per cent. dwell in houses, 33.33 per cent. in earth or straw huts, 3.25 per cent. in tents, and 1.68 per cent. in burrows, the dwelling-houses consisting of one or at the most two rooms, and being of a quite primitive nature. Those who are settled often live a more miserable life than those who wander, for the latter are, as a rule, better off. About 30 per cent. of the Gypsies consider Romani their mother-tongue. Of the total number, 92.39 per cent. can neither read nor write (the corresponding figure for the population is 46.89 per cent.). There are 0.80 per cent. who are independent farmers, 0.92 per cent. servants, and 0.46 per cent. day-labourers; there are 33,930 male and 16,576 female Gypsies carrying on trades, principally smiths and metal-workers (17,020 men), wood-workers (5553), and builders' work-people (16,395 men and women). The musicians, a considerable number, form in every sense the highest and most intelligent class.'²

Gypsies are more numerous in S.E. Europe than elsewhere, and they have existed in that region for an unknown period of time. They are specially congregated in the territories bordering upon the western shore of the Black Sea. According to one writer,³ there are 500,000 Gypsies in the district of the Lower Danube and the Balkan Peninsula, the Gypsy population of Macedonia being remarkable for its density. For particulars as to the Macedonian group, this writer refers us to Vasil Kunchev's *Makedonia*, a work written in Bulgarian (Sophia, 1900),

'which contains much information about the Gypsies there entirely new to literature. The population and names of all the many Gypsy villages are given, and there is a valuable account of their trades, characteristics, etc. The statistics have evidently been prepared carefully. . . . It is an authoritative work.'

¹ *Coryat's Crudities*, London, 1611; see London reprint of 1776, vol. i. p. 64, also ed. 1906, Glasgow.

² The above extract is from an Eng. tr. of the original Swedish, which was made for the *Gypsy Lore Society* by Harald Ehrenborg and another member of that Society, with subsequent revision by Arthur Thesleff. This tr. appears in the *JGLS* (N.S.) for 1911-12 (vol. v.).

³ A. T. Sinclair, *JGLS* (N.S.), vol. i., Jan. 1908, p. 126.

Owing to the fact that a certain proportion of the Gypsy population is migratory, and also because there are many people of mixed blood who may be regarded as Gypsies by one enumerator but not by another, it is impossible to obtain wholly accurate statistics in connexion with the race. Indeed, the figures vary to an astonishing degree. The official census taken in 1873 reported that the number of Gypsies in the countries belonging to the Crown of Hungary amounted to 214,714;¹ whereas the return of 1900, quoted above, raises the figure to 280,000. On the other hand, the *Almanach de Gotha* for 1888 states that there were only 79,393 Gypsies in Hungary on 31st Dec. 1880.² The same authority gives the following figures: Rumania, 200,000 Gypsies in 1876; Servia, '29,020 se servent de la langue bohémienne,' in 1884; Bulgaria, 37,600 in 1881; and Eastern Rumelia, 27,190 on 13th Jan. 1885. These statistics, notably in the case of Rumania, are remarkably at variance with those furnished by the Helsingfors report of 1900, wherein it is stated that the number of Gypsies in Rumania amounts to 'perhaps nearly 300,000,' while Servia possesses 46,212, and Bulgaria 52,132.³ It will be noticed that, excepting the *Almanach de Gotha* statement with regard to Hungary, the later figures show an increase which might be explained by the assumption that the race has been more prolific during the last generation, possibly owing to an improvement in its surroundings. There is, however, a sufficient discrepancy between the reports to warrant the conclusion that these statistics can be accepted only as approximate.

The Gypsy populations of several other European countries are thus allocated in the Helsingfors report of 1900: Russia, 50,000; Finland, 1551; Poland, 15,000; Lithuania, 10,000; Galicia, 16,000; Spain, 50,000; and the British Isles, 20,000. A 'Statistical Account of the Gypsies in the German Empire,' published by Rudolf von Sowa in 1888,⁴ shows that there were then 241 families, consisting of 1054 individuals, living permanently in Prussia. Although permanent residents, they were not sedentary all the year round, but moved about, attending the principal fairs in their occupation of horse-dealers, musicians, and puppet-show men. In most of the other German States there are no resident Gypsies, according to von Sowa, although Gypsies from other States or countries occasionally pass through. Württemberg, however, possessed about 100 resident Gypsies in 1888; while there were 53 in Alsace-Lorraine, 24 in Baden, and 17 in Brunswick. Von Sowa's statistics appear to minimize the number of Gypsies in Germany, if one may judge from his statement that 'as far as is known, there are no Gypsy colonies in Bavaria.' He adds that 'the police authorities have the strictest orders not to permit Gypsy bands to enter Bavaria, or, if found, to send them away.' This certainly does not accord with Richard Andree's report on 'Die Zigeuner in Bayern,'⁵ based upon the official *Zigeunerbuch*, Munich, 1905, wherein the number of Gypsies in Bavaria is estimated at 3350. It must, therefore, be assumed that von Sowa's figures, as regards the German Empire, cannot be relied upon.

'The Gypsy race is found in every country of Europe, all over Asiatic Turkey, Persia, Turkestan, Afghanistan, Beluchistan, Siberia, Egypt, the north coast of Africa, and in the Soudan. It is scattered throughout North and much of South America. Everywhere it is the same Gypsy race and the language is the same *Romani chib* [Gypsy tongue], in different stages of decay, and modified by various environments.'

The accuracy of these statements cannot be questioned, although the writer¹ omits India and Australasia from his list. It is scarcely necessary to explain that the Gypsies found in America and Australasia are not indigenous, and have merely gone there from the Old World in modern times. But the writer here quoted omits India deliberately. In view of the fact that the Gypsy language is closely akin to Hindustani, this is a remarkable omission. The writer's contention is, however, fully deserving of citation, although it is opposed to the ideas at present prevailing. He contends that the purest Gypsy is spoken in the Balkan Peninsula and the region of the Lower Danube.

'As we leave this district, in all directions their numbers rapidly diminish, and their language becomes corrupt. Eastwards, when we reach the territory adjacent to India and the Hindu Kush, their language has almost disappeared, and they are very few in number. There are no Indian Gypsies. . . . There is no need to go to India to seek the cradle of the Romani tongue.'

That there are no Indian Gypsies is too sweeping an assertion; nevertheless, it contains a good deal of truth. There are Gypsy-like castes in India, but these people would not find themselves at home among European Gypsies. Turkish and Welsh Gypsies could easily converse with each other, whereas neither could converse with the Gypsy-like castes of India, unless in a most fragmentary way, through the medium of Hindustani, a language common to the greater part of India. De Goeje of Leyden, who was an eminent Arabic scholar, has shown, however, that a great migration of Jāts or Lūris took place from India to Persia in the 5th cent. A.D., and again in 710 from the same district to the valley of the Tigris. Thereafter, in the 9th cent., they were brought into the Greek Empire by the Byzantines. De Goeje has a very strong case in favour of these people being Gypsies. An argument used against him is that the Jāts still remaining in India do not speak the Romani language; but language is not an infallible test of race. Another objection is that there are indications of a Gypsy population in Europe at an earlier date than the 9th century. De Goeje's theory is, none the less, of much importance.²

But the other view has much to say for itself. It is certainly a pregnant fact that Europe is, at the present day, the seat of the Gypsy race and language. It is possible to draw very opposite conclusions from this fact, but in any case it cannot be ignored. Francis Hinds Groome³ has quoted a striking passage, not previously noted by modern scholars, from the *Itineraria* (Cambridge, 1778, p. 57) of Symon Simeon, an Irish Minorite friar, who visited Egypt in 1322. There he saw many 'Danubian' captives, whom he describes in terms which suggest that they belonged to the same stock as the modern Gypsies of the Danube:

'Item sciendum est, quod in saepedictis civitatibus [Alexandria and Cairo] de omni secta alia ab illorum viri mulieres lactantes juvenes et cani pravae venditioni exponuntur ad instar bestiarum; et signantur indiani schismatici et danubiani, qui omnes utriusque sexus in colore cum corvis et carbonibus multum participant; quia hii cum arabis et danubianis semper guerram continuant, atque cum capiuntur redemptione vel venditione evadunt. . . . Praedicti autem Danubiani, quamvis ab Indianis non sunt figura et colore distincti, tamen ab eis distinguuntur per cicatrices longas quas habent in facie et cognoscuntur; comburunt enim sibi cum ferro ignito facies illas vilissimas terribiliter in longum, credentes se sic flamine [flammis] baptizari ut dicitur, et a peccatorum sordibus igne purgari. Qui postquam ad legem Machometi fuerunt conversi christianis deteriores sunt Saracenis, sicut et sunt Radiani renegati, et plures molestias inferunt. . . . Item sciendum, quod in praefatis civitatibus tanta est eorum multitudo, quod nequaquam numerari possunt.'

Groome's comment is as follows: 'There is much in this

¹ *JGLS* (O.S.), vol. ii., July 1890, p. 153.

² *Ib.*, vol. i., Oct. 1888, p. 120.

³ *Ib.* (N.S.), vol. v., 1911-12, p. 86 f.

⁴ *Ib.* (O.S.), vol. i. pp. 29-33 and 134 f.

⁵ Contributed to *Münch. anthrop. Gesellsch.*, 24 Nov. 1905.

¹ A. T. Sinclair, *JGLS* (N.S.), vol. i., Jan. 1908, p. 198.

² See the original art. in the Proceedings of the *Koninklijke Akademie van Wetenschappen* of Amsterdam, and Eng. tr. in MacRitchie's *Gypsies of India*, London, 1886; also de Goeje's supplementary art. in *JGLS* (O.S.), vol. ii. no. 3, July 1890.

³ *Gypsy Folk-Tales*, Introd. p. xix.

passage that remains obscure; but it seems clear from it that in 1322 there were in Egypt large numbers of captives, male and female, old and young, from the Danubian territories. They were black as crows and coal, and in complexion and features differed little from Indians, except that their faces bore long scars produced by burning (? a kind of tattooing, like that of the Gypsy women in 1427 at Paris). On conversion to Mohammedanism these Danubians were worse to the Christians than the Saracens. Were these Danubians, or some at least of them, Gypsies, prisoners of war, from the Danubian territories? and did some of them buy back their freedom and return to Europe? If so, perhaps one has here an explanation of the hitherto unexplained names "Egyptian," "Gypsy," "Gitano," etc., and of the story told by the western immigrants of 1417-34 of renegacy from the Christian faith.¹

The presumption that these Danubian captives were Gypsies is very reasonable. It has already been mentioned that modern Rumania possesses between 200,000 and 300,000 Gypsies, and that there is a large Gypsy population in the other Danubian territories. No one can point to a time when these regions were not inhabited by Gypsies, and there is therefore every probability that the captives of 1322 were members of that race. It ought to be added that Polydore Vergil, writing about 1499, asserts that the Gypsies were all tattooed—a practice which, in his opinion, gives them an Assyrian ancestry.¹

Gypsies speak of themselves as *Romi* or *Romané* (*Rom*, *Rúm*, or *Romano*, in the singular masculine), and sometimes as *Romané-tchavé* or *-tchéla*, and *-tchaia*, i.e. 'Romany lads and lasses.' Their language is known to them as *Romanes*, *Romani*, or *Romani-tchib* (*tchib*='tongue'). It has been more than once suggested that this name of *Rom*, or *Roum*, is derived from their long residence in the Byzantine Empire, formerly known as *Roum*.

3. Occupations.—At the present day, Gypsies follow various occupations, modified partly by the habits of the country in which they live. They have long been famous as musicians, and in S.E. Europe the hotels, restaurants, and other places of public resort are nightly visited by Gypsy bands. Everywhere their women are associated with the arts of divination, notably by means of palmistry. The men are equally celebrated as clever horse-dealers, and in Southern France and Northern Spain they are professional clippers or shearers of horses and dogs. Such names as *tinker*, *brazier*, *chaudronnier*, and *calderar* preserve the memory of a time when they were more generally than now famous as metal-workers. Indeed, the existing bronze-workers of Polish Galicia are all of Gypsy race.² The skill of Gypsies as craftsmen is further denoted by the Scottish name of *caird* (Gaelic *ceard*='artificer'); and by the Montenegrin *majstori* (cf. Germ. *Meister*), given to them because they are even yet the only artificers in Montenegro. Their occupations in Eastern Europe, as detailed by Emil Thewrewk de Ponor,³ are very varied. They are stated to be singers, dancers, tight-rope dancers, puppet-show men, mountebanks, clowns, tale-tellers, improvisatori (in Turkey and Moldavia), bear-leaders, monkey-leaders, smiths, farriers, metal-workers, gold-washers, fishermen, horse-dealers, pig-dealers, boot-makers, agriculturists, hangmen, knackers, fortune-tellers, sorcerers, quack-doctors, cheats, thieves, and beggars. The wives of the musicians are noted for their skill in making beautiful embroideries for Hungarian ladies of rank. Other Gypsies, in various countries, are workers in wood, manufacturing chairs, spoons, children's toys, and such-like articles. Those of Scotland were at one time famous as makers of horn spoons, whence their popular name of 'horners'; and in Scotland they are still known as 'muggers' on

¹ *JGLS* (N.S.), 1911-12, vol. v. no. 4, p. 317, quoting Polydore's *De inventoribus rerum*, vii. 7, ed. Basel, 1545, p. 470.

² See Paul Bataillard, *Les Zlotars, dits aussi Drvonkars, triganes fondeurs en bronze et en laiton*, Paris, 1878; also Groome, *Gypsy Folk-Tales*, xxv.-xxvi.

³ *JGLS* (O.S.), vol. ii. p. 149.

account of their trade in pottery. Many of the occupations already noted are associated with them in the Middle Ages, when they appear prominently as travelling actors, showmen, mountebanks, jongleurs, hypnotists, quacks, false coiners, pilferers, robbers, and mercenary soldiers. As itinerant actors and showmen they were apparently very numerous. P. Lacroix, in referring to such people in the 16th cent., observes:¹ 'Many of them were Bohemians or Zingari [i.e. Gypsies]. They travelled in companies, sometimes on foot, sometimes on horseback, and sometimes with some sort of a conveyance containing the accessories of their craft and a travelling theatre.' Richard Augustine Hay, a Scottish priest of the 16th cent., tells how a company of Gypsies used to be the guests of the Earl of Roslin every year, occupying two towers in Roslin Castle (Midlothian, Scotland) during May and June, when they acted several plays. As these towers became known as 'Robin Hood' and 'Little John,' it may be assumed that they were named after the most popular plays.²

Perhaps the most important of all the occupations professed or followed by mediæval Gypsies is that which has yet to be named. They figured conspicuously in the character and attire of religious pilgrims, and were everywhere accepted as such—a fact which will receive fuller consideration below.

The performance of histrionic dances, for which Gypsies were noted, can hardly be separated from their displays as actors. In the Accounts of the Lord High Treasurer of Scotland there is an entry of the year 1530, which shows that the sum of forty shillings was then paid 'to the Egyptians that danced before the King [James V.] in Holyrood house.' There is no indication as to the nature of the dance on that occasion. But from Spanish and Provençal sources we learn that, in the mediæval miracle-plays relating to the life of Christ, Gypsy dances are of frequent occurrence. For example, the last act of Lope de Vega's *Nacimiento de Christo* ends 'with the appearance of the Three Kings preceded by dances of Gypsies and Negroes, and with the worship and offerings brought by all to the new-born Saviour.'³ One of the carols sung by Spanish children on the Day of the Holy Kings (Epiphany or Twelfth Day) opens with the verse:

'The Gypsy women, who are always
The joy of the town-gate,
Seeing the Kings arrive,
Wish to give them a dance.
Get ready the castanets, Gypsies;
The Three Kings have come in at the gate,
To see the young boy;
Chas, chas, chas.'⁴

In a certain Provençal *noël* the Three Kings themselves are understood to be Gypsies, and they successively foretell the future of the infant Christ by the art of palmistry, in approved Gypsy fashion. They introduce themselves thus:

'We are three Bohemians
Who tell good fortune.
We are three Bohemians
Who rob wherever we may be;
Child, lovely and so sweet,
Place, place here, the cross,⁵
And each (of us) will tell thee
Everything that will happen to thee.
Begin, Janan, however,
Give him the hand to see.

¹ *Manners, Customs, and Dress in the Middle Ages*, London, 1876, p. 230.

² See R. A. Hay, *Genealogie of the Sainteclaires of Roslyn*, printed from the original MS, and edited by J. Maidment, Edinburgh, 1835 (see p. 136).

³ O. Ticknor, *Hist. of Spanish Literature*, London, 1849, vol. i. p. 25.

⁴ Intended to represent the snapping of the castanets.

⁵ Meaning one of the coins used in the Crusades, impressed with a cross. A subsequent reference to 'the white piece of money' implies that it was a silver coin. This is the origin of the demand of English and Scottish Gypsies to 'cross my hand' or 'cross my loof.'

Thou art, from what I see,
Equal to God.
And thou art his Son all wonderful:
Thou art, from what I see,
Equal to God.
Born for me in the nothingness:
Love has made thee a child
For all the human race;
A virgin is thy mother,
Thou art born without any father;
This I see in thy hand.
Love has made thee a child,' etc.

After completing their forecast of the Child's destiny, they proceed to examine the hands of the Virgin and Joseph, the latter of whom is thus addressed:

'And thou, good old man,
Who art at the corner of the manger,
And thou, good old man,
Wilt thou not that we see thy hand?
Say, thou fearest perhaps
That we should steal that ass
Which is tied up there?
We would rather steal the child:
Place (something) here upon, fair sir,
We have scarcely drunk (to-day).'

The Gypsy proclivities which emerge in this last stanza are still more unreservedly indicated in an Andalusian carol:

'In the gate of Bethlehem
The little Gypsies have entered,
And the new-born child
Have robbed of his swaddling clothes.
Rascally Gypsies,
Faces of olives,
They have not left the child
One little rag!'

'How the Blessed Virgin with her Child Jesus and Saint Joseph fled into Egypt, and how they found food and lodging,' is the title of an Italian tract of mediæval origin, wherein a Gypsy woman encounters the Holy Family during their flight, and offers them hospitality.

'I have here a little stable,
Good for the young she-ass;
I will now place therein straw and hay:
Behold a shelter for ye all!'

After bidding Saint Joseph to be seated, she goes on to foretell the future of the Virgin and Child,—'for we dear Gypsies can all divine the future.'

These references¹ are not the only ones which associate Gypsies with Jesus of Nazareth. One very persistent tradition is that the nails used at the Crucifixion were made by Gypsies, and that the race became accursed in consequence. On the other hand, the Gypsies of Alsace and Lithuania assert that this was not so, and that a woman of their people endeavoured to steal the nails from the Jews, in order to prevent the Crucifixion. She succeeded in stealing one, with the result that only three nails remained available, two of which were used for the hands, and the remaining nail was driven through the feet, which were crossed one above the other. Groome comments as follows upon this tradition:

'This Gypsy counter-legend offers a possible explanation of the hitherto unexplained transition from four nails to three in crucifixes during the twelfth and thirteenth centuries. Dr. R. Morris discusses the change in his Introduction to *Legends of the Holy Rood* (*Early Eng. Text Soc.*, 1871). There it appears that, while St. Gregory Nazianzen, Nonnus, and the author of the *Ancren Riwle* speak of three nails only, SS. Cyprian, Augustine, and Gregory of Tours, Pope Innocent III., Rufinus, Theodoret, and Ælfric speak of four; and that the earliest known crucifix with three nails only is a copper one, of probably Byzantine workmanship, dating from the end of the twelfth century. Now, if the Byzantine Gypsies possessed at that date a metallurgical monopoly, this crucifix must, of course, have been fashioned by Gypsy hands, when the three nails would be an easily intelligible protest against the calumny that those nails were forged by the founder of the Gypsy race.'²

4. History.—From these various references it will be seen that the Gypsy race has been interlinked, with what justice remains to be ascertained, with the earliest events of Christianity. Moreover, evidence is accumulating which tends to show that

¹ Extracted from the fuller accounts in *JGLS* (O.S.), vol. i. pp. 135-143, and vol. iii. pp. 45-47.

² *Gypsy Folk-Tales*, p. xxx.

they were obtaining the benefits accorded to Christian pilgrims as early as the 8th cent., and that they are referred to in this character by Charlemagne, in an edict of the year 789.¹ They undoubtedly appear as pilgrims at a much later period.

We know, for example, that in the year 1417 the noble Transylvanian family of Horvath presented forty sheep 'to the poor pilgrims out of Egypt, in order that they, returning to Jerusalem, may pray for the salvation of our souls'; that in 1418 the Saxon Count of Herrmannstadt, in Transylvania, granted 'to the people from the Holy Land food and fodder for their horses, worth eight denars'; that in the same year the municipality of Frankfort-on-the-Main gave bread and meat to 'the wandering people from Little Egypt'; and that in 1419, Andrew, a duke of Little Egypt, with a hundred and twenty followers, received money, wine, and bread from the town of Mâcon, in Burgundy. Further, a certain 'Lord Emaus from Egypt and his two hundred and twenty comrades' were voted a sum of money, corn, and poultry by the municipality of Kronstadt, Transylvania, in the year 1416. Then, again, in 1429, on St. Andrew's Eve, the town of Arnhem, in Guelderland, paid six guildens 'to the count of Little Egypt, with his company, to the honour of God'; and, at the same time, gave 'to the same count and to the Heathen women, to the honour of God, a half malder [a corn measure] of white bread, a barrel of beer, and a hundred herrings.'

In all these cases, which are only a few selected out of many of the same kind, it is manifest that the pilgrims who received these various gifts belonged to the caste known as 'Egyptians' or Gypsies. That Gypsies actually professed to be pilgrims is seen from the statement made by Peucer in his *Commentarius* (1572), wherein he asserts that they wore the pilgrim dress.² Aventinus, who wrote in the early part of the 16th cent., complained indignantly that their pilgrim character gave them a liberty possessed by no other class. 'Robbing and stealing are prohibited to others, under pain of hanging or beheading, but these people have licence for them.' Aventinus was not using the language of exaggeration, for robbery and theft were among the many characteristics of the mediæval Gypsies. Nevertheless, they sustained at the same time the rôle of genuine pilgrims; and as such they were supported by the citizens and country-folk among whom they travelled.

In order to understand the situation properly, it must be realized that the Gypsies enjoyed Papal protection. This is seen from a letter granted in 1496 by Charles, Count of Egmond, under his privy seal, to a certain 'Count Martin Gnougy, born of Little Egypt,' in which it is stated that the Pope, Alexander VI., had ordained Count Martin and his family and company 'to go on pilgrimage to Rome, to St. James of Galicia, Compostella, and to other holy places.' To enable this count of Little Egypt and his followers to fulfil the Papal injunctions, Count Charles of Egmond strictly commanded all his representatives throughout his principality to succour and protect the Gypsies. The Count of Egmond and all orthodox people were bound by their religion to obey the wishes of the Pope in this respect. Obedience, moreover, brought them a spiritual reward. The citizens of Amiens were granted Papal indulgences and pardons because they gave alms to an earl of Little Egypt and his company of about forty persons who visited their town in September 1427. The same kind of reward is indicated also in an ordinance of the magistrates of Tournai in Hainault, who appealed to the devout members of the community to give alms to 'the great Earl of Little Egypt or his people,' who were expected to sojourn for four or five days in Tournai in the last week of March 1429.

At this period, if not at earlier dates, the leaders of these Gypsy bands were men of noble birth, who received their appointments from the Crown, or other supreme power, in the various European countries. They have borne many designations—

¹ For an exhaustive and scholarly study of this question, see an art. by Leo Wiener, in *JGLS* (N.S.), vol. iii. no. 4, April 1910, pp. 253-276.

² The passage is quoted in *JGLS* (O.S.), vol. iii. p. 7.

king, regent, governor, master, judge, duke, earl, count, baron, and captain. It is to be noted that these rulers were not of Gypsy blood, but belonged to the nobility and gentry of the country in which their particular section of the race was settled. The evidence obtained from Poland and Lithuania is clear and distinct.

'From the sixteenth century till the close of the eighteenth the Chancellor Royal nominated a *Regent of the Gypsies* from among the Polish gentry. These regents were the supreme judges for the Gypsies of the district; they gave laws to the Gypsies; they had the right of punishing the Gypsies, and of levying taxes on them.'¹ 'With us,' says a Hungarian writer,² 'the Gypsy captaincy was vested in the nobility of Transylvania and Hungary. The captaincy of the Gypsies has long been with us an office of state, combined with which were *iura praerogativa fructus et emolumenta*, which the Crown bestowed on distinguished persons as a reward of merit, but not on Gypsies.'

In illustration of this statement are two commissions granted in 1557 by Queen Isabella of Hungary in favour of two of her courtiers, Lord Balatsi de Kiskend and Caspar Nagy, who were appointed *vayvodes*, or rulers, of the Cigáns of Transylvania.³ More than a century before this, in the year 1423, the Emperor Sigismund had issued a passport to 'our faithful Ladislaus,' *vayvode*, or baron, of the Cigáns, in which the Emperor commands all the Imperial officials to favour and protect the said Count Ladislaus and the Cigáns who are subject to him. 'And if any trouble or disturbance should arise among the Cigáns, then none of you whomsoever, but Count Ladislaus alone, shall have the power of judging and acquitting.'⁴ This, it will be seen, gives the Gypsy Count an authority second only to that of the Emperor himself. It would seem that this nobleman represented a family which had held the countship of the Cigáns for several generations. This appears from three documents of 1326, 1373, and 1377, the first of which relates to a Domenick Czigáni, there styled a nobleman or prince (*homo regius*). Those of 1373 and 1377 refer to 'the son of Domenick Czigáni' and to 'Ladislaus Czigáni,' presumably the same individual. The context renders it probable that these were ancestors of Count Ladislaus of 1423.⁵

Another Gypsy baron was Antonios Eparchos, who is described as a versatile genius, at once poet, Hellenist, and soldier, who corresponded with Melancthon. In 1540, after the great siege of Corfu, the fief of the Gypsies of Corfu was conferred upon Eparchos as compensation for his losses and as the reward of his talents. Marmora, whose *Historia di Corfù* was published in 1672, describes the Gypsy barony as 'an office of not a little gain and of very great honour.' The jurisdiction of the baron extended over the continental dependencies of Corfu, as well as over the Gypsies of the island. Under Venetian rule, the title appears to have been *Giudice e Capitano delli Acingani*, 'Judge and Captain of the Gypsies.' At the close of the 14th cent. the *feudum Acinganorum*, or Gypsy barony, was possessed by Gianuli de Abitabulo, from whose family it afterwards passed to the house of Goth.⁶

From these references it will be seen that the counts and earls 'of Little Egypt,' whose occasional visits to one part of Europe or another are chronicled in various archives, were not men of Gypsy blood. They were members of the upper classes of Europe, who were appointed by their respective governments to these Gypsy baronies,

¹ Zielinski, in *JGLS* (O.S.), vol. II. p. 239.

² Emil Thewrewk de Ponor, *ib.* pp. 148-160.

³ H. M. G. Grellmann, *Dissertation on the Gypsies*, Raper's Eng. tr., London, 1787, p. 197 f.

⁴ *ib.* p. 245. ⁵ *JGLS* (N.S.), vol. II. p. 274.

⁶ See Groome, *Gypsy Folk-Tales*, p. xix f.; Carl Hopf, *Die Einwanderung der Zigeuner in Europa*, Gotha, 1870, pp. 17-23; W. Müller, *The Latins in the Levant*, London, 1908, pp. 622, 639 f.

as a distinction and a reward. Their revenues were mainly derived from the authorized poll-tax that their subjects were bound to pay to them, although they had apparently other sources of profit. One thing clear is that, when they travelled from home, both the rulers and the ruled subsisted upon the gifts which they looked for—and not in vain—from the people among whom they sojourned. This was because they bore the character of pilgrims, to whom it was a pious duty to give alms.

The mediæval Gypsies constituted therefore a system, and not merely a race—an organization which had its ramifications all over Europe, and which held a position that all the secular and religious authorities recognized. To analyze the component parts of that organization, and to endeavour to solve the problem of its origin, is outside the scope of this article. A close investigation of the causes and effects of the Crusades (*q.v.*) forms the first step in such a study. No very great weight can be attached to the single assertion of a French Gypsy soldier in 1628, that his people came into France under the French kings at the time of the Crusades, notably under St. Louis (1252).¹ Indeed, that assertion conflicts with the belief already referred to, that Gypsies figured as Christian pilgrims as early as the reign of Charlemagne. But it is evident that the Gypsies of the 15th cent. availed themselves of the privileges of pilgrims and Crusaders, and particularly of those possessed by the Templars and Hospitallers. A concrete instance of this is seen in the case of 'Lord Emaus from Egypt and his two hundred and twenty comrades,' who were so hospitably received at Kronstadt, Transylvania, in 1416. Emaus, or Emmaus, is in Judæa, not in Egypt; and Emmaus was formerly a Commandery of the Hospitallers. The Lord Emmaus of the year 1186 was a certain Barthélemy, who, with his comrades, enjoyed precisely the same privileges as those accorded to the Lord Emmaus of 1416. That is to say, he and his company were entitled to travel about Europe, living on the countries through which they passed, all on the strength of their being pilgrims, or the defenders of pilgrims. As recently as 1528, the Grand Master appealed successfully to the Pope and the Emperor against the attempt made by the Duke of Savoy to exact money from the Grand Master and his company for their food and lodging when passing through Savoy. Thus, the position occupied by the people popularly called 'Egyptians' was identical with that of the Hospitallers. This identity can be seen in other respects, such as exemption from military duty to the country in which they lived, and freedom from its taxation. Perhaps the most notable link is the use of the sign of the Cross as a mark of union.²

Even if the Gypsies had been quiet and peaceable people, their assumed right to exact food and money from others would have rendered them a burden to the general population of Europe. But, as they travelled in large companies, their men being armed to the teeth, and as their demands were enforced by acts of violence, when necessary, the situation became increasingly intolerable to the middle and lower classes. Consequently, in all the countries of Europe, edicts were passed for the suppression or the expulsion of the 'Egyptians.' On the other hand, the leaders of those 'Egyptians' were men of noble birth, legally appointed by the State to their position of regent, baron, or count, and that position gave them a good income and many privileges. It was therefore to their advantage that the laws against 'Egyp-

¹ *JGLS* (N.S.), vol. III. no. 8, Jan. 1910, p. 238.

² Van Elven, *JGLS* (O.S.), vol. III., Jan. 1892, p. 127.

tians' should be nullified as far as possible. The result of these opposing interests was that, for several centuries, the European countries oscillated between the enactment of laws framed for the purpose of ending the Gypsy system, and the very perpetuation of that system by the continued filling-up of vacancies in the Gypsy baronies.

France furnishes an excellent illustration of this conflicting state of things. In 1539 an edict was issued in the king's name forbidding any Gypsies to enter the country, and ordering those then within it to leave without delay. Nevertheless, it appears that in 1545 there were no fewer than 4000 Gypsy men in France, all capable of bearing arms. Further, in 1606, and again in 1680, the Gypsies received notice to quit France—with two months' grace in the former instance and one month's in the latter. In spite of all this, it was found necessary in 1682 to issue a royal declaration 'Contre les Bohémiens, leurs femmes et enfans, et ceux qui leur donnent retraite.' This last clause refers to certain of the French nobility and lords-justiciary, who were accused of giving shelter to the Gypsies in their castles and mansions, in defiance of Acts of Parliament expressly forbidding them to do so. They are now ordered once more to desist, under pain of losing their fiefs and offices, with threats of severer punishment if they continue to disobey.¹

Eventually, but only after the lapse of centuries, the Gypsy system was completely suppressed. In the course of the struggle, thousands of Gypsies were executed, banished, or imprisoned; and their surviving representatives are, with few exceptions, inoffensive members of the community in which they live. The problem of the Gypsy system and the Gypsy race still awaits a completely satisfactory solution; but a careful study of the system cannot fail to throw light upon the origin of the race.

It may be added that the country known as 'Little Egypt' was probably the Holy Land, in the first instance, and, in later times, the territories retained by the Crusaders in Greece and the islands of the Levant.

5. Religion.—The question of the religion of the Gypsies is somewhat involved. Their over-lords during the Middle Ages were undoubtedly Christian. The Genoese family of the Abitabuli, their successors of the house of Goth, and, at a later date, Antonios Eparchos, the correspondent of Melanchthon, all of whom were in turn Barons of the Gypsies of Corfu, could not have been anything else than Christian. The same can be said of the noble Hungarian family represented in 1423 by Count Ladislaus, who then held the office of *vayvode*, or baron, of the Cigáns. Similar examples are Lord Balatsi de Kiskend and Caspar Nagy, who belonged to the court of Queen Isabella of Hungary, by whom they were created *vayvodes* of the Cigáns of Transylvania in 1557. All of these were non-Gypsies upon whom the office of *vayvode* was conferred. No room for doubt exists in the case of two Swabian nobles of the Gypsies who died in the 15th century. The monument of one of them was placed in a little monastery beside Schloss Fürstenu, a castle of the Counts of Erbach, in the Odenwald. The epitaph was to this effect: '1445 years after the birth of Christ our Saviour, on St. Sebastian's evening, died the high-born lord, Lord Panuel, duke in Little Egypt, and Lord of Hirschhorn in the same country.' Lord Panuel's arms were emblazoned on his tomb—a golden eagle crowned, with a stag-horn for crest, above a crowned helmet. The Swabian chronicle recounts further how, in the year 1498, at Pfortzen, 'there died the well-born Lord John, Free Count out of Little Egypt, to whose soul may God be gracious and merciful.' Both of these references² testify clearly to noble birth and Christian faith. The case of Count Martin Gnougy, 'born of Little Egypt,' who was commanded by Pope Alexander VI. to go on pilgrim-

¹ For these references, see *JGLS* (O.S.), vol. iii., 1891-92, p. 228, and *ib.* (N.S.), vol. v., 1911-12, pp. 313-316.

² For which see the *Annales Suevici* of M. Crusius, Frankfurt, 1596, ff. 384, 510.

age, about the year 1496, is perhaps not quite so definite. Nevertheless, it is inconceivable that a Pope would enjoin upon any but a Christian the duty of pilgrimage to various holy places in Europe. The religion of the Gypsy rulers, therefore, may be regarded as certainly Christian. That of the Gypsies themselves, in some instances, falls within the same category. Mention has been made of Symon Simeon, an Irish friar, who visited Candia in Crete in 1322, and who there saw 'a race outside the city, following the Greeks' rite,' whom he describes in terms that clearly indicate Gypsies. Consequently, it is evident that those Cretan Gypsies belonged to the Eastern or Greek Church. The same friar also refers to numerous Danubian captives in Alexandria and Cairo, apparently Gypsies, who had been converted to Muhammadanism by their captors. What was their previous religion? The Danube territories formed then a part of Christendom, and, if there is no evidence that those Danubian captives were previously Christians, there is, on the other hand, no evidence that they were not. The presumption is that they were Christians in name, if not in fact. The whole history of the Gypsies points to this conclusion. It was because they were accepted as Christian pilgrims that they received alms, to the honour of God, and free quarters in all the countries of Europe. They wore the pilgrim dress, and the cross was their chief symbol. When they had to retreat before superior numbers, they sought and obtained refuge in religious houses. No fewer than three hundred Gypsies found shelter in the Augustin Convent at Plainpalais, Geneva, in 1532, when they had to give way before the attacks of the populace and the town officials. Moreover, when twenty of their number were taken prisoner on that occasion, they were speedily pardoned and released, *propter Deum*. Martin del Rio tells of a similar incident in Spain, apparently in the town of Santiago, on Corpus Christi Day, 1584, when the Gypsies took refuge in 'the magnificent mansion and hospital of the knights of St. James, where the ministers of justice attempting to seize them were repulsed by force of arms; nevertheless, all of a sudden, and I know not how, everything was hushed up.' Neither the Augustin friars nor the Knights of St. James would have so championed the Gypsies had they been strange and unknown pagans. Nor would either of these fraternities have exerted themselves to protect a crowd of the ordinary citizens of Geneva or Santiago from the consequences of their turbulent behaviour towards the city officers.

There is no better testimony to the Christianity, nominal or real, of the Gypsies than that afforded at the Church of Les Saintes Maries de la Mer, in the Ile de la Camargue, Bouches-du-Rhône. In this church the festival of the Holy Marys is annually celebrated on 25th May. On that occasion, the crypt of the church is reserved exclusively for the Gypsies, because here is the shrine of Saint Sara of Egypt, whom they regard as their patron saint.

The Gypsies, to the number of several hundreds, begin to arrive as early as the 22nd of May, and throughout the night of 24th-25th May they keep watch over the shrine of Saint Sara. On the 25th they take their departure. This custom, which is in full force at the present day, has continued for at least four or five centuries; for M. Ribon, curé at Les Saintes Maries, states (1907) that the votive offerings of the Gypsies, still preserved in the crypt, date back to about the year 1450. Since that date, therefore, the Gypsies have worshipped in the crypt as Christians.

Many other statements might be adduced which show the Gypsies, past and present, in the light of orthodox Christians, punctilious in observing the rites and ceremonies associated with Christianity.

On the other hand, evidence of another kind is not difficult to obtain. The crypt of Les Saintes

Maries itself suggests an opposite view. It is stated that the shrine of Saint Sara rests upon an ancient altar dedicated to Mithra; that the Gypsies of that neighbourhood, who are known as 'Caragues,' are descended from the Iberians formerly inhabiting the Camargue; and that their cult is really the Mithraic worship of fire and water upon which the veneration of Saint Sara is superimposed.¹ Even this fact, however, if it be a fact, does not wholly differentiate them from the worshippers in the church above, because a critical analysis of modern Christian ritual, in some of its phases, at any rate, reveals affinity with, or derivation from, the ritual of earlier faiths. De l'Hoste Ranking points out² that what Wislocki describes as a Hungarian Gypsy ceremony 'is simply the ordinary ceremony of the Orthodox Greek Church.' This statement, however, leaves the origin of that ceremony still unsettled. The same writer mentions that Christmas, Easter, and Holy Week are high seasons among the Transylvanian Gypsies. This does not necessarily show that the Gypsies are Christians, for these had been sacred seasons long before the Christian era.

In his monograph on the 'Forms and Ceremonies' practised by Gypsies,³ E. O. Winstedt has brought together a mass of curious information on this subject. Here, again, there is the same difficulty of ascertaining what is and what is not a distinctively Gypsy custom. For example, 'The Gypsies of Roussillon hold a feast in honour of the dead on All Saints' eve; but the ceremony—burning tapers—seems to be borrowed from their Christian neighbours.'

With regard to a certain ceremony of the Hungarian Gypsies, Winstedt further observes:

'Exactly how much of this is purely Gypsy ritual, and how much is due to borrowings from the superstitions of the intermixture of Slav, Hungarian, Greek, Latin, Germanic, and Turkish races in that quarter of the world, it would be difficult to say.'

Even the practice of constituting marriage by the simple act of jumping over a broomstick, which appears to have been at one time a usage among Gypsies, is not solely an attribute of these people, for there are survivals of such a custom among the peasantry of Austria, Germany, and the Netherlands.⁴ Ranking indicates another parallel instance when he writes:

'The great festival among the Transylvanian Gypsies is St. George's Day, "Green George," as he is called. The chief figure of the feast is a lad who from head to foot is covered with green leaves, twigs, and flowers, and hence is called "Green George," obviously our "Jack in the Green."⁵

This is the spring festival observed among the Gypsies of Rumania, Servia, and Bulgaria, as described by Kopernicki.⁶ But the point is that, as Ranking justly remarks, it is also the same as the May Day festival observed, until quite recently, in England and Ireland, in which the leaf-clad 'Jack in the Green' is the principal figure.⁷ The Gypsies, therefore, have no special claim to this custom, which is or was common to the whole of Europe. It is the ancient celebration of the yearly re-birth of vegetation in spring-time, as observed in the Roman *Floralia* and the kindred rites of the Druids. The 'holly-boy' and 'ivy-girl,' which used to figure prominently in the Shrovetide festivities of English villagers, notably in Kent, represent similar ancient rites.⁸ Groome's statement,⁹ that 'there is, or was lately, actual idolatry

¹ For the above references to Les Saintes Maries, see *JGLS* (N.S.), vol. i. no. 1, July 1907, pp. 92-95, and vol. i. no. 4, April 1908, p. 391.

² *Gypsy and Folk-Lore Gazette*, vol. i. no. 2, London, 1912, p. 59.

³ *JGLS* (N.S.), vol. ii. no. 4, April 1909, pp. 338-366.

⁴ *Id.* vol. v. no. 8, 1911-12, p. 235 f.; E. Samter, *Geburt, Hochzeit, und Tod*, Leipzig and Berlin, 1911, p. 35.

⁵ *Gypsy and Folk-Lore Gazette*, vol. i. no. 2, p. 56.

⁶ *JGLS* (O.S.), October 1891.

⁷ Hone, *Every-Day Book*, London, 1838, vol. i. cols. 583-585, and vol. ii. col. 577.

⁸ *OED*, s.v. 'Holly.'

⁹ *Gypsy Folk-Tales*, p. lxxiii.

—tree-worship—among German Gypsies,' might be held to indicate an absolutely pagan cult. The fir, the birch, and the mulberry-tree are specified as the respective symbols of the Old Prussian, the New Prussian, and the Hanoverian Gypsies.¹ Once more, however, it has to be noted that tree-worship was formerly practised in all the countries of Europe, traces of it being still discernible among the peasantry down to our own times.² Indeed, not only among the peasantry and in past times; as witness the solemnity of decorating churches with holly and mistletoe in the Christmas season, which is the ancient Yule.

Considerations such as these seem almost to point to the conclusion that the chief difference in religious matters between ordinary Europeans and the Gypsies of Europe is that the latter have conserved in a greater measure than the former the pagan practices once common to all Europeans.

In a communication made to the *Orientalische Gesellschaft* (Berlin) in 1888, Solf represents the 19th cent. Gypsies of Germany as combining a religious code of their own with Christian profession and practice.

'A "captain" presides over each tribe. He is elected for seven years. His powers are both regal and sacerdotal. He marries, divorces, excommunicates, and reconciles those who have forfeited honours and privileges. Nearly all the marriages are celebrated on Whitsunday. Great care is taken at present to avoid marriages between the degrees prohibited by the German law, although they are otherwise allowable by Gypsy custom and tradition. Adultery is exceedingly rare, and is punished with severity. The children are baptized, and handsome presents are always expected from the god-parents. If a child is born while they are lodging near a village, they usually take him to the parish church for baptism. They wear no mourning at a death. Solf describes the Gypsy as "full of piety."³

The term *Heiden*, or 'Heathen,' so often applied to Gypsies in Western Europe during past centuries, would seem to denote that they were not regarded as Christians. When, in 1429, the town of Arnhem, in Guelderland, gave six guildens 'to the count of Little Egypt, with his company, to the honour of God,' and, on the same day, a quantity of food and drink 'to the same count and to the Heathen women, to the honour of God,' a difference in religion between the count and the Heathen women appears to be implied. Nevertheless, the name *Heiden*, or 'Heathen,' was used, on at least two occasions, as a racial or caste designation solely, when the people so designated were Christians by religion. One of these instances occurs in Justinger's *Berner Chronik*. Bataillard, who cites the passage,⁴ points out that Justinger was recorder of the town of Bern, and that his chronicle runs from 1411 to 1421. In 1419 he makes the following entry:

'Regarding the baptized Heathen. In this year there came to Basel, Zürich, Bern, and Solothurn more than two hundred baptized heathen [*Heiden*]; they were from Egypt, pitiful, black, miserable, with women and children; and they camped before the town [Bern] in the fields, until a prohibition was issued, because they had become intolerable to the inhabitants on account of their thefts, for they stole all they could. They had dukes and earls among them, who wore good silver belts [*silbrin Gürteln*], and who rode on horseback; the others were poor and wretched. They wandered from one country to another; and they had a safe-conduct from the King of the Romans.'

Here, it will be seen, the term 'Heathen' is applied to people who were admittedly Christian by religion. The other similar instance is that afforded by the *Staats-Archiv* of Basel, in which it is recorded that on 13th June 1423 a payment of one gulden was made 'to two heathens [*zwein heyden*] who had become Christians.' There is practically no doubt that in all these instances—at Bern in 1419, at Basel in 1423, and at Arnhem

¹ *JGLS* (O.S.), vol. i. p. 51, quoting Solf.

² See Frazer, *GB*, 1900, l. 106, 224, etc.; A. Lang, *Myth, Ritual, and Religion*, new ed., London, 1899, ii. 239, 254.

³ Quoted in *JGLS* (O.S.), vol. i. p. 51.

⁴ *JGLS* (O.S.), vol. i. p. 282.

in 1429—the people denominated 'heathen' were Gypsies. Those referred to in 1419 and 1423 are distinctly stated to have professed the Christian faith. Notwithstanding this, they continued to be styled 'Heathens,' as a racial name. It is extremely probable, therefore, that the term was so understood when used at Arnhem in 1429, and that those 'Heathen women' professed Christianity. Indeed, it is very unlikely that the magistrates of Arnhem would have bestowed substantial benefits upon avowed pagans.

There is obviously much room for speculation as to the religion of the rank and file among the 'Egyptians,' or 'Heathens.' If they were not actually members of the Christian Church, they, at any rate, passed themselves off as Christian pilgrims, sustaining that character not only by their dress, but also by their observance of Chris-

tian rites, as in the Church of Les Saintes Maries. To what extent they also followed heathen practices cannot be ascertained.

LITERATURE.—A *Gypsy Bibliography*, by George F. Black, issued by the Gypsy Lore Society in 1909 (new ed. 1914), mentions almost every work upon this subject published up to date. It is found in the leading libraries of Europe and America. Those to whom that work is not accessible may be referred, for historical information, to the following: H. M. G. Grellmann, *Die Zigeuner*, Dessau and Leipzig, 1783 [Raper's Eng. tr., *Dissertation on the Gypsies*, London, 1787]; C. Hopf, *Die Einwanderung der Zigeuner in Europa*, Gotha, 1870; P. Bataillard, *Sur les Origines des Bohémiens ou Tsiganes*, Paris, 1876. For ethnography, languages, and history, see A. F. Pott, *Die Zigeuner in Europa und Asien*, Halle, 1844-45; F. Miklosich, *Ueber die Mundarten und die Wanderungen der Zigeuner Europa's*, Vienna, 1872-80. F. H. Groome's Introd. to his *Gypsy Folk-Tales*, London, 1899, contains a comprehensive survey of the whole question. The *Journal of the Gypsy Lore Society* (New Series), issued at 21A Alfred Street, Liverpool, continues to furnish the most recent results obtained by modern scholars.

DAVID MACRITCHIE.

H

HABIT.—In its most general acceptation, habit denotes a persistent readiness in certain phenomena to recur, which has been acquired by repeated recurrence. Here readiness is to be understood as including not merely ease or facility, but also a tendency or impulse. Habitual readiness is thus distinguished, on the one hand, from a readiness that is transient; on the other hand, from a persistent readiness that is inborn. The former is merely the general tendency of all living things to act under any stimulus. The latter is what is known distinctively as *instinct* (*q.v.*). The distinction between habit and instinct, however, is no longer thought to be so absolute as was in former times generally supposed. Empiricism, indeed, has long endeavoured to break down the distinction. The older empiricists, of whom J. S. Mill may be taken as the last representative, generally held that most, if not all, instincts are habits formed by each individual, but at a period so early in life as to have left in memory no traces of their formation. But this older form of the empirical theory has completely given way before the ideas of evolutionism. At the present day, while many, if not all, instincts are in their ultimate analysis reduced to habits, they are still admitted to be inborn in the individual, and the process of their evolution is extended over an indefinite period in the life of preceding generations. Empiricism includes in its theory not only instinctive impulses to action, but also the insuperable necessities of thought. The necessity of thinking that $2+2=4$, or that two straight lines cannot enclose a space, is regarded merely as a habit which has become so firmly fixed that it can no longer be resisted. A much more questionable use of the term *habit* is one which extends it to facts in the inorganic world. For instance, W. James speaks of 'the habits of an elementary particle of matter,' and describes 'the laws of Nature as immutable habits which the different sorts of elementary matter follow' (*Principles of Psychology*, vol. i. p. 104; cf. Radestock's *Habit and its Importance in Education*, p. 32). These theories carry us into the general problems of philosophy, and it is the ethical significance of habit with which we have specially to do. For our purposes there is no gain, but rather a loss of scientific perspicuity, in extending the idea of habit as is done by the theories in question. For, even if the unalterable necessities of thought and the unalterable properties of matter can be with

any propriety described as habits, yet, in so far as they are unalterable within the range of all scientific experience, they lack the essential character of habits; they cannot even be identified with instincts, for these are by no means incapable of modification. The very essence of a habit is that it is an effect of alterations going on in living things; it is an aspect of organic growth. Consequently, as Aristotle pointed out long ago, habit cannot be engendered in inorganic things. 'For instance, the stone, which by nature moves downwards, cannot acquire the habit of moving upwards, not even if one tried to give it the habit by throwing it up ten thousand times; nor could fire form a habit of moving downwards; nor could anything else with a nature of one sort be made to take on another from habit' (*Eth. Nic.* ii. 1. 2). Analogies, indeed, are sometimes drawn from acquired facilities in the inorganic world. Folded paper returns readily to its folds. A lock or an engine works more easily after being used for a while. The fittest analogy of all is probably to be found in the improvement of a violin that has been played by a master. In all these cases the acquired facility is associated not with elementary particles, but with complex combinations of matter; the material of the violin is even an organic compound. But the analogy of such facilities with habit is superficial at the best. It has no connexion with any process of organic growth.

As an organic process, however, habit is found in the vegetable world. Thus the modifications which may be developed in a plant by artificial culture or by natural adaptation to a new environment are of the nature of a real habit. More nearly akin to the habits of human life are the numerous aptitudes which animals can be trained to form. In man also the most spiritual habits have their basis in his organic life. The nutrition of the organs called into play must be affected by the uniformity of their action during the formation of a habit. Layers of nutritive material will run into peculiar positions determined by the habitual movement of the organs they supply, and thus the growing organs will receive a peculiar structure, adapted to the actions repeatedly performed. The fact is that often after prolonged effort we continue to feel the beat of the blood in the arteries and the throb of nervous and muscular movement which the effort called forth, long after the effort itself has ceased. This effect is experienced not only in the sensations of active effort, but also in

the so-called passive sensations. A din thrills in the ears of many persons after a long railway journey, and after-images are a familiar phenomenon in vision. It thus appears that, though the elementary properties of inorganic, and perhaps also of organic, matter are unalterable, there is in organic beings a natural adaptability to the alterations of organic structure involved in the formation of a habit.

This is the physiological interpretation of the fact that habitual actions are done with a certain unconsciousness; that is to say, though we may remain conscious of the series of habitual actions as a whole, we fail to note consciously the separate actions in the series. When we begin to form a habit, the actions required are in general performed slowly, deliberately, and with an amount of effort that is often even painful. Gradually with repetition the slow and deliberate effort disappears, and the actions are performed with an easy rapidity that carries them beyond the ken of consciousness. For, to attain distinct consciousness, one mental activity must endure for a certain length of time before being supplanted by another. Consequently, if one activity is in experience uniformly followed by another, it comes after a while to suggest that other so instantaneously that it fails to be noticed in consciousness, and the activity suggested alone appears. This process can be traced all through intellectual life, and is specially familiar in the perception of the external world. The fact perceived is always suggested by some sensation, and in general so instantaneously that the sensation escapes attention, and the fact perceived appears like an object of immediate intuition. The same result is of great service in practical life also. For feelings that might, if indulged, obstruct or even paralyze active exertion may come to be habitually associated with some such exertion. They will then serve merely to suggest and stimulate the activity with which they have been habitually associated without obtruding themselves into consciousness at all, or at least in a manner to disturb or distract. Surgeons or nurses, who would be helpless if they indulged their natural sympathy at the sight of a painful wound, may train their sympathetic feelings to prompt at once the measures necessary for relief and cure. On the other hand, the indulgence of mere feeling, however amiable it may be, tends to create that habitual excess of sensibility which is commonly described as *sentimentality* or *sentimentalism*. This almost inevitably entails an enfeeblement of character; and therefore an important phase of moral training consists in checking the tendency to excessive indulgence of idle sentiment, and forcing the sentiment into habitual association with some form of practical effort (James, *Principles of Psychology*, vol. i. p. 125 f.).

Often the activities which come to be thus habitually associated form a long series; and, when by frequent repetition they succeed one another with great rapidity, they become no longer distinguishable, but are fused into an indiscriminating consciousness of them all taken together. Thus vibrations of the atmosphere, on reaching a certain velocity, are no longer heard distinctly, but form a single tone; and many striking optical effects are produced by the fusion of visual sensations rapidly succeeding one another. In the same way actions, originally done with conscious effort, may by habitual training cease to be individually distinguishable, leaving in consciousness merely a trace of their general effect. They then appear as if they were performed by the organs called into play without affecting the highest centres of conscious life.

An interesting illustration of this phenomenon is given by Max Müller in his *Autobiography* (p. 218 f.). The printer in

Oxford who set up the Rigveda in Sanskrit knew nothing even of the alphabet of that language. But, though it contains some 300 characters, he sometimes detected mistakes which Müller himself had overlooked. He explained this by saying that his arm soon formed certain habits of movement in accordance with the common combinations of letters, and felt something unusual in wrong combinations, just as it might feel the combination *hs* to be wrong in English.

Even the higher nerve-centres in the brain exhibit the same result at times. Complicated mental operations come to be so habitual that they too fall below the verge of consciousness. From the physiological point of view this sort of activity is described as *unconscious cerebration* (see Carpenter's *Mental Physiology*, ch. xiii.).

In its psychological as distinguished from its physiological aspect, habit is connected with the mental process of suggestion or association. A habit is an acquired readiness in the suggestion of phenomena that have been frequently associated. Now, among other facts connected with this process it is a familiar law that phenomena are more readily suggested in proportion to their original intensity and to the frequency with which they have been repeated. These two conditions of ready suggestibility are the influences mainly called into play in the formation of habits. Sometimes a new habit seems to spring into full development all at once, under the impulse of a peculiarly intense impression. A violent shock in conscious experience may suddenly produce such organic changes as in ordinary circumstances are the result of very gradual modifications. This effect may be met with in all spheres of mental life, but it is peculiarly striking in the great moral and religious change commonly known as *conversion*. It may be that, however sudden this change may appear at times, its suddenness is more apparent than real. Possibly it has been prepared by subconscious processes that have been going on for some time before and only burst suddenly over the threshold of consciousness (E. D. Starbuck, *The Psychology of Religion*, London, 1899, pp. 105-113; W. James, *Varieties of Religious Experience*, New York, 1902, p. 236 f.). In any case the fact that changes of similar violence are seen in other regions of mind shows that sudden conversions are not out of harmony with the laws of mental life (Starbuck, *op. cit.* ch. xi.). But, however valuable a sudden and violent shock may be as an initial impulse to the formation of a new habit, its value apart from this is apt to be dangerously overestimated. An intense excitement finds its worth mainly in the fact that its intensity makes it readily suggestible. It haunts us so that we cannot escape from it, and thus it determines the current of our life; that is to say, it gives life a new habit. But without this continued recurrence of an intense impression its original intensity would not prevent it from being gradually, in some cases even rapidly, effaced. It is a familiar rule, therefore, of all life that habitual attainments must be kept in continued practice, else they are apt to be supplanted by a return of the untrained awkwardness with which they began. Even instincts, as will presently appear, die away if they are not kept in life by practice; and any peculiar variety of plants tends to lose the distinctive habits developed by culture, and to revert to its wild type if it is left uncultivated. This fact bears with eminent significance on the training of the moral and religious life. The young convert in the glow of his fresh enthusiasm is apt to imagine that the habits of the new life are already acquired. He does not realize that he has only been *born* anew, and that there is a long process of growth before him still, ere he can reach the stature of spiritual manhood. It is not therefore surprising that statistics seem to point to a startling proportion of relapses after

spiritual changes produced by the violent excitements of revivalism, when compared with the proportion among cases where conversion has been due to the ordinary unexciting religious culture of home and church and Sunday school (Starbuck, *op. cit.* p. 170). For moral and religious habits must be trained by the same organic process by which all life is evolved; and it is an interesting fact that the Great Teacher draws His favourite parables and metaphors for illustrating the development of the kingdom of God from the processes of organic growth in Nature. It is the organized structure developed by a process of growth that distinguishes habitual goodness from a goodness that is due to any transitory impulse. 'One swallow does not make spring,' as Aristotle puts it in illustrating the necessity of trained habit to genuine virtue (*Eth. Nic.* i. 7. 15); and Hosea (6⁴) had long before denounced the futility of a goodness that is transient as a morning cloud or early dew. On the other side also of the moral life:

'The sin that practices burns into the blood,
And not the one dark hour which brings remorse,
Shall brand us after, of whose fold we be'

(Tennyson, *Merlin and Vivien*).

While habit is thus not to be confounded with any fleeting impulse, it is also, as we have seen, distinguished from those impulses that are inborn. But we have seen, further, that this distinction is not so sharp as was at one time supposed. Possibly instinct may itself be but a habit earlier formed, and thus embedded in the primitive structure of living things. But, whatever its origin, we now see that the processes which constitute life can, by a prolonged uniformity of action, produce a new organic structure giving a habitual readiness of the same kind as the instinctive. For this reason habit is commonly spoken of, in a phrase which has long been proverbial, as a second nature. It is, moreover, a familiar experience in common life, confirmed by scientific observation, that the second nature, thus created by a man's own habitual action, may overbear the instincts of his original nature. For instincts are by no means beyond reach of the changes going on in life. On the contrary, not only do they require the stimulus of a proper environment to be called into activity in the first instance, but, even if roused in this way, they may afterwards be completely supplanted by counteractive habits. Numerous illustrations of this will be found in Spalding's celebrated article on 'Instinct' in *Macmillan's Magazine* for February 1873, and in the chapters (xi. to xvi. inclusive) on 'Instinct' in G. J. Romanes' *Mental Evolution in Animals*, London, 1883; see also C. Lloyd Morgan's *Animal Life and Intelligence*, do. 1890-91, ch. xi. on 'Habit and Instinct.' It thus appears as if the value of an instinct, like that of any intense impression, were to be found in the original start which it gives to the process of forming a habit.

But, if the mere animal can thus modify its native instincts in adaptation to the changing exigencies of life, it would be preposterous to deny to man a similar adaptability. The truth is that man's superiority to the mere animal is to be found mainly in his superior adaptability. This is not indeed to be interpreted as meaning, what is too commonly assumed, that Nature guides the lower animals by the instincts with which she endows them, while she leaves man to the direction of his own intelligence. Both statements are wide of the truth. For, on the one hand, many of those modifications of instinct which have been referred to above are intelligent adaptations by an animal to a new situation. On the other hand, it is a mistake to suppose that man is distinguished from the lower animals by the comparative poverty of his instincts. So far from this being the case, his

superiority is to be found in a richer endowment of natural impulses (James, *Principles of Psychology*, vol. ii. pp. 303, 441) as well as in a power of more varied and more intelligent adaptability to unforeseen contingencies. But the instincts of man, like those of the lower animals, become persistent influences only by being kept in habitual practice. In fact, many of the instincts with which man is endowed are opposed to one another, and it is environment and training that determine which of the opposing instincts is to become the habitual influence (James, *op. cit.* vol. ii. p. 392). Science thus points to the conclusion which common observation had long ago reached, that every man is what he is more by trained faculty than by native endowment, that he is 'a creature of habit,' 'a slave of custom,' or, as Paley puts it in a phrase which has become almost proverbial, 'a bundle of habits' (*Moral and Political Philosophy*, bk. i. ch. vii.).

The development of habits may be said to be the aim of all education. The capacity for forming habits constitutes educability. This capacity, as we have seen, has two aspects. Physiologically it means the power of forming new organic structures; psychologically it is the power of associating activities so that they will readily suggest one another in the order in which they have been associated. Both these powers constitute a natural endowment in which men differ greatly from one another. Some men are of weak formative power, hardly able to fix new organic changes, to make new associations cohere by any amount of repetition. They remain characterless beings to the end. In every sphere of life they represent the feeble types. 'Mr. Pliable' never takes on any persistent habit. The original endowment of men, however, varies not only in its general nature, but also in its special directions. Each individual can usually form a certain kind of habit with ease, while he may be practically incapable of forming others. This gives to every one his peculiar bent, his *indoles*.

It thus appears that there is a limit to the plasticity of human nature, a limit to the changes that may be produced in a man's original nature by the second nature of habit. On the theory of evolution, indeed, this limit is not absolutely immovable; even the distinctive organic structure of new species has been evolved by a modifying process similar to that by which habits are formed, through a process so slow that it must have extended over incalculable æons of cosmic history. But there are two facts which must be recognized. On the one hand, all experimentation by man proves that there is a limit to the variations which he can produce in himself or in animal and vegetable organisms. On the other hand, however, instances of appalling moral degradation and instances of amazing moral triumph make us hesitate about any sweeping assertions against variability in the moral life. Here at least the ratio of the old and the new is no fixed quantity. Apparently it varies in different individuals, and probably in the same individual at different periods of growth. Consequently it is difficult to define the relative influence of inherited nature and acquired faculty in human life, and the attempt to define it leads to conflicting theories. Not only do scientific thinkers vary in their views on the subject at the present day, but the variation runs through the great historical controversies between Augustinianism and Pelagianism, Jansenism and Molinism, Calvinism and Arminianism.

But educability implies the power not only of forming, but also of reforming, habits. Often the most formidable task of the educator is, not to counteract the original tendencies of nature, but

rather to break off habits that have become inveterate. The second or habitual nature, as we have seen, sometimes overrides the primitive nature of men; and then it becomes for the educator a more intractable factor than congenital instinct. It seems at times to impose a limit on the plasticity of human nature as rigid as any that are fixed by original constitution. This is the ground of the familiar educational rule, to begin all training on a right method from the first, in order to avoid the formation of habits which must be unlearned before further progress can be made. The obstruction of old habits is also one of the causes which make the acquisition of new habits increasingly difficult with advancing years. For, as the years go on, every man is gradually forming an aggregate of habits which constitutes his distinctive character. That character becomes every day more intricately woven into the innermost tissue of physical and psychical life, and the drift of this process points to the conclusion that the character thus formed may become at last practically unalterable. Whether the moral doom of men does actually in the end become fixed immutably for evil as well as for good is a problem which would carry discussion beyond the limits of our theme. But in the phenomena of habit there is revealed a moral government of life, which is characterized by the most rigorous justice. The growth of habit furnishes an unfailing reward for every virtuous act, and brings to every vicious act an unfailing penalty. In a familiar but singularly appropriate figure, every act we perform is likened to seed sown in a fit soil, destined to produce a fruit of its own kind. Whatsoever, therefore, a man soweth, that precisely, but that certainly, shall he reap in the habits that he creates. Thus virtue is literally its own reward, vice its own punishment.

LITERATURE.—The best studies on habit are those in the great works on Psychology. Most of these treat the special kinds of habit separately, though the separate treatments can usually be found in an index. Fortunately, however, one of the greatest recent works on the science, W. James's *Principles of Psychology* (Lond. 1907), devotes a whole chapter (the fourth) to the general nature of Habit. The chapter on Habit (the eighth) in W. B. Carpenter's *Mental Physiology* (Lond. 1876) also deserves mention as being still of value. On the educational aspects of the subject there is a little monograph by Paul Radestock, *Die Gewöhnung und ihre Wichtigkeit für die Erziehung* (Eng. tr. *Habit and its Importance in Education*, Boston, 1889). For younger children and their teachers there is another monograph by Walter L. Sheldon, *Lessons in the Study of Habits* (Chicago, 1903). The historical development of the subject is admirably traced in the tenth chapter of *A History of the Problems of Philosophy*, by Paul Janet and Gabriel Séailles (Eng. tr., London, 1902).

J. CLARK MURRAY.

HADES.—See **ESCHATOLOGY, STATE OF THE DEAD.**

HADES, DESCENT TO.—See **DESCENT TO HADES.**

HAGGADA.—See **RABBINISM.**

HAGIOLOGY.—See **SAINTS.**

HAIDA.—1. Geographical and ethnological.—The *Haida*, or, as they term themselves, *Xáida* (i.e. 'people'), are an American Indian people whose territory includes the Queen Charlotte Islands and the southern end of Prince of Wales Island, Alaska. Between 150 and 200 years ago the so-called *Kaigani* left the N.W. end of the Queen Charlotte Islands, and, landing on Prince of Wales Island, drove out the Tlingit from the southern end, of which they took possession. The Haida are not now a numerous people; of the main body, according to Swanton, in 1907 there remained some 600, and of the Alaskan branch about 300, making less than 1000 in all. In 1836–41 their

numbers were estimated at more than 8000; and in 1888 at 2500, which must have been quite an exaggeration, in the light of the figures reported since then. Linguistically, the Haida form an independent family, termed, in Powell's classification (7 *RBEW* [1891], 118 f.), *Skittagetan*, from the town-name *Skidegate*, a corruption by the Whites of a name of a chief of the north shore, *Sqēdagits*. Authorities like Boas and Swanton, however, consider possible an ultimate relationship of Haida with Tlingit (phonetic and lexical coincidences, grammatical peculiarities), and more remotely with Athapascan; but this is still doubtful, although certain elements of social organization also point in the direction of closer affinity between Haida and Tlingit (Koluschan). Physically, the Haida belong to that group of Indians of the North Pacific Coast which includes also the Tlingit and the Tsimshian, as has been shown by the anthropometric researches of Boas and other investigators.

2. **Contact with Whites.**—Swanton considers it not impossible that the Queen Charlotte Islands may have been visited by Spaniards during the 17th cent. (*HAI* i. [1907] 521), but 'the first certain account of their discovery is that by Ensign Juan Perez, in the corvette *Santiago*, in 1774.' Bodega and Maurelle came the next year; in 1786, La Perouse, and, in 1787, Capt. Dixon, who 'spent more than a month around them, and the islands are named from his vessel, the *Queen Charlotte*.' From that time onwards, 'scores of vessels from England and New England resorted to the coast, principally to trade for furs, in which business the earlier voyagers reaped golden harvests.' The result of this intercourse is thus indicated by Swanton (p. 521):

'The advent of whites was, as usual, disastrous to the natives. They were soon stripped of their valuable furs, and, through smallpox and general immorality, they have been reduced in the last 60 years to one-tenth of their former strength. A station of the Hudson's Bay Company was long established at Masset, but is now no longer remunerative. At Skidegate there are works for the extraction of dog-fish oil, which furnish employment to the people during much of the year; but in summer all the Indians from this place and Masset go to the mainland to work in salmon canneries.' These canneries also furnish the *Kaigani* with work in summer.

Most of the Haida are Christians, at least nominally; mission-stations exist at Skidegate (Methodist), Masset (Anglican), and Howkan (Presbyterian). Of the general attitude of the Haida, Swanton says (*loc. cit.*):

'The Haida, Tlingit, and Tsimshian seem to show greater adaptability to civilization and to display less religious conservatism than many of the tribes farther south. They are generally regarded as superior to them by the white settlers, and they certainly showed themselves such in war and in the arts.'

In the 'Story of the shaman, Gándox's-father,' recorded by Swanton ('Haida Texts,' in *Bull.* 29 *BE*, 1905, pp. 311–315), some items of White influence are referred to, and it seems that the 'new religion' of Bini, the Carrier Indian (Athapascan), reached the Haida of Skedans.

3. **Tribal and social organization.**—The Haida belong to those American Indian peoples who had a set social system, with caste divisions. The whole Haida people, according to Swanton (*HAI* i. 522), 'is divided into two "sides" or clans—Raven (Hoya) and Eagle (Got)—each of which is subdivided and resubdivided into numerous smaller local groups.' Each clan is reputed to be 'descended from one woman.' Besides the principal and more important towns of the Haida, 'there was formerly an immense number of small towns hardly distinguishable from camps, places that had been occupied as towns at some former time, and mythic or semi-mythic towns' (*ib.* 523). Society consisted of chiefs and nobles, and common people and slaves; and the lines were strictly drawn between the various classes. The slaves (see below) per-

formed menial labour, and the difference between the common people and the nobility was accentuated in divers ways. For example, 'if people of low family passed close in front of chiefs' houses in their canoes, they might be injured or enslaved.' High-born children did not cry like those of slaves or of common people; chiefs' children sat high in their fathers' canoes; to lean backwards in sitting was an evidence of low caste, good form demanding that 'one must sit on the forward part of the seat in an alert attitude'; common people were often referred to as 'mosquitoes'—their bad words 'bit' the rich (Swanton, 'Haida Songs,' 12, 24, 25). There were many 'low-class' words, which the upper classes disdained to use. The use of labrets was a mark of high birth among the Haida. The people of the other clan took charge of a man's funeral; when an Eagle died, the Raven people attended to the ceremonies, and *vice versa*.

4. Slavery.—The Haida are among those tribes of the North Pacific Coast with whom the institution of slavery attained considerable proportions; here a slave-class existed, the members of which were either war-captives or individuals purchased or obtained in other ways as slaves from neighbouring tribes. The strong caste-system probably made it difficult for male slaves as a rule to rise to positions of importance, although Swanton states that the greatest Skidegate chief was a slave in his youth (cf. *Bull. 29 BE*, p. 306 f.). With female slaves the case was somewhat different, for these, 'especially if they were known to be of noble descent, sometimes married their captors and became free.' Swanton says further (*HAI* i. 205):

'Four prominent Haida clans and one clan among the Tsimshian are said to have originated from marriages of this kind, while another prominent Haida clan was called "the Slaves," though it is impossible to say whether they were descended from slaves or whether the term is applied ironically.

Slaves appear to have been often harshly used, and in the songs and myths there are many references to their low estate and menial duties. In a cradle song given by Swanton ('Haida Songs,' p. 11), it is stated of the child that he may not kill dog-salmon or halibut, or chop cedar-bark; for such things are the work of slaves. In another song a mother styles herself, in jest, the 'slave' of her child (p. 41), and in yet another (p. 16) a mother is represented as having to take care of the baby herself, because her family have no slaves. One slave was often set above all the rest. By the supernatural beings of Haida mythology, men and women were regarded as 'human slaves,' 'human servants,' etc. At death, the bodies of slaves were usually thrown into the sea. According to Swanton (*Bull. 29 BE*, p. 433), 'payment of *káda*, remuneration for having enslaved a person, was accompanied by dancing; payment of *wal*, remuneration for having killed or wounded a person, was not.' A special being, 'Supernatural-slave,' appeared to those about to be enslaved.

5. Secret societies.—According to Swanton, the Haida have had secret societies 'only during the last 100 or 150 years.' These are of the spirit-initiation type. 'The entire performance consisted in the supposed possession of the novice by some one of a number of spirits, who carried the youth away and made him act the way the spirit himself was supposed to act. Some of these ways of acting were introduced, while others were in accordance with native conceptions. They were largely the property of certain chiefs, who would allow only their own families to use them' (Swanton, *HAI* ii. 497).

6. Peace and war.—A considerable proportion of the Haida stories relate to war with their neighbours, the Tlingit, and others. Each war-party was accompanied by its own shaman. Tantalizing songs were sung in the language of the

people attacked. A figure for 'being killed in war' was 'being eaten by the Raven.' Those killed in battle were thought to go to the house of *Táxēt* in the sky. Battle-songs were sung by women in the absence of their husbands at war, and there were songs used by all families in making peace. It was believed that unfaithfulness on the part of a wife while her husband was away hunting or at war would cause him ill-luck or even death. This incident appears frequently in tales and legends. A supernatural being named *Tia* 'presided over slaughter, and made his presence known at a time when it was about to take place' (Swanton, *Bull. 29 BE*, p. 374). 'When peace was made, one man from each side was generally taken up and borne around upon the shoulders of his opponents. He was called the "deer"' (*ib.* p. 390).

7. Totemism and heraldry.—As noted above, the Haida people are divided into two clans, 'Raven' and 'Eagle,' of both of which there are many minor groups and subdivisions. Each clan has presumably a female progenitor (*Djiláqons*, the reputed ancestress of the Eagle clan, figures in a number of legends, and is connected with a famous scandal). Marriage between members of the same clan was forbidden. The fact that men and women are of different clans seems to have influenced the Haida idea of the next or spiritual world. Most of the supernatural beings, however, seem to be assigned to the Raven people. Children followed the mother, and were bound to her by closer ties than were husbands to wives. The Haida have been described briefly as having 'animal totemism,' with 'exogamic totem-groups' and a 'maternal organization.' The germ of what is known in Europe as heraldry may be said to have developed among the Haida. Mooney (*HAI* i. 544) says:

'Among the Haida and some other tribes of the N.W. coast, according to Swanton and other authorities, is found the germ of a similar system. Here, in many cases, the clan totem, or perhaps the personal manito of the individual, has evolved into a crest which persons of the highest rank, i.e. of greatest wealth, are privileged to figure by carving or painting upon their totem poles, houses, or other belongings, tattooing upon their bodies, or painting upon their bodies in the dance, on payment of a sufficient number of "potlatch" gifts, to secure recognition as chiefs or leading members of the tribe. The privilege is not hereditary, the successor of the owner, usually his sister's son, being obliged to make the same ceremonial payment to secure the continuance of the privilege.'

Swanton, in his article on 'Totem-poles' (*HAI* ii. [1910] 794 f.), states that,

'According to native Haida accounts, carved designs were originally made directly on the front slabs of the house, afterwards on a broad, thick plank, and finally on poles,' remarking, further, that 'this comparatively modern evolution is corroborated by the Tlingit, who have only the grave post, upon which they carve representations of stories as well as crests.'

The totem-poles of the Haida are chiefly of three kinds, 'outside and inside poles, and memorial columns.' Grave-posts consisted of carved posts with carved grave-box on top. The totem-posts were erected during potlatches.

'The carvings on grave posts and grave boxes were almost always crests owned by the family of the deceased, while those on house poles might be crests, or they might illustrate stories, and occasionally a figure of the house-owner himself was added, or the figure of some one whom he wished to ridicule.'

8. Games.—Among the plays and games of the Haida Indians, Swanton and Culin enumerate: archery, dice-games, the 'hand-game,' hoop and pole, jackstraws, quoits, ring and pin, shinny, stick games, tops, and some other miscellaneous games. The dice-game of *gutgi qaátagañ* 'was usually played at camp in the smoke-house, and the winner had the privilege of smearing the loser's face with soot' (Swanton, 'Ethnol. of Haida,' p. 59). The game appears to be played indiscriminately by men and women. In the 'hand-game,' G. A. Dorsey (Culin, 'Games,' in *24 RB&W*, p. 318) reports the use of a false bone

so constructed that it can be made to show up either white or black. Of the hoop and pole game, several varieties exist among the Haida. It is usually played with a disk or ring of hemlock twigs and a long stick. Under this head Culin also classifies the game of *gao skū dji*, or 'a woman's pubic bones,' described by Swanton ('Ethnol. of Haida,' p. 60) as follows:

'This was a boys' game. Late in the spring, when a tall, slim plant called *Lai*, the pith of which was eaten, was at its best, the boys would collect a great quantity of the stalks. Then two would each drive a couple of sticks into the ground about 5 yards apart. After that each would take about 20 sticks of the salmon-berry bush, and, using them as spears, alternately try to drive one of them between the adversary's posts, or stick it into the ground beyond, so that it would rest on their tops. Each boy would then bid a certain number of *Lai* stalks, and after they had used up all of their spears, he who scored the most hits won all that had been put up by his adversary. If he were one point ahead, he got nothing more; but if he were two points ahead, he won as much again; if he were three points ahead, twice as much, and so on.'

Concerning the game of *icitgadáldaña*, or 'knocking something over by shooting,' which was played by older people (sometimes a whole town turned out, and the resulting contests extended over a long period of time), Swanton informs us that, 'for some religious reason, they ceased playing with arrows as soon as winter began.' Of the 'stick-game,' Swanton, who describes it in some detail in his account of Haida games, says ('Ethnol. of Haida,' p. 58):

'The great gambling game of the Haida was the same as that used on neighbouring parts of the mainland. It was played with a set of cylindrical sticks, 4 or 5 inches long. The number of the sticks varied in the sets that I have seen, one having as many as 70. Some of the sets were made of bone, but the most of yew or some similar kind of wood. These were finely polished, and in many cases elaborately carved or painted, but usually were simply divided into sets of from two to four by various lines drawn around them in black and red. One of the sticks was left blank, or nearly so, and was called *dji*, bait. The *dji* was the piece hidden and guessed. The gambling-sticks had separate names, most of them bearing those of animals.' 'The more elaborate ones are ornamented with representations of the animal figures whose names they bear.' A set of 48 sticks, collected by O. F. Newcombe and now in the University of Pennsylvania Museum (Culin, *op. cit.* p. 259), consisted of the following: shadow, 8; red fish, 8; black bass, 8; mirror (of slate, wetted), 8; sea anemone, 8; dance head-dress, 8; puffin, 8; black bear, 8; devil fish, 8; guillemot, 8; large housefly, 8; halibut, 8; humpback salmon, 8; dog salmon, 8; centipede, 1; chiefs who kiss (*i. e.* rub noses), 1; supernatural beings of high rank (*dji*), 4.

A monotonous chanting accompanies the game, here as elsewhere. Of the ethics of gambling among the Haida, Swanton observes, 'it is not so true to say that cheating was fair in Haida gambling as to say that it was part of the game.'

In a 'ring and pin' game, described by Swanton ('Ethnol. of Haida,' p. 60), when the V-shaped piece fell to the ground instead of being caught on the stick, after being thrown into the air, 'the one who threw must yield to the next player; but, before doing so, he was at liberty to pull his opponent's hair violently or punch his knuckles as many times as he had made a catch.' Concerning the game of jackstraws, which, he thinks, 'would seem a natural and logical development from the game of stick-counting,' Culin (p. 729) says: 'The only intimations the writer has had of it in America are among the Eskimo and the Haida.'

9. Songs.—The Haida have many brief songs of various sorts, both in connexion with feasts and other public ceremonies and for other purposes. Magic songs and 'power songs,' used by shamans and others for the purposes of acquiring or increasing ability or influence, and incantations of divers kinds for luck in fishing or success in hunting, war, etc., are common. There are also war-songs, love-songs, songs for calming and for raising storms, 'dancing-hat' songs, satiric and taunting songs, songs belonging to the animals and other creatures in stories, house-songs, canoe-songs, songs of joy and mourning, women's songs, cradle-songs, and peace-songs. A large number of all

sorts are recorded in the various works of Swanton (in 'Haida Songs,' texts and translations of 88 cradle, 11 mourning, and 6 miscellaneous songs from the several Haida dialects are given). Totem-pole raising and 'potlatches' were accompanied by much dancing and singing. The joyful songs, called *Lên*, were commonly sung indoors. The *djiā' djiat qagan*, or 'women's songs,' were used 'when totem poles and house timbers were towed in during a potlatch' (*Bull. 29 BE*, p. 147).

10. Feasts and festivals.—Like other tribes of the North Pacific coast, the Haida had a number of important feasts and festivals, some of which were of foreign origin. The institution of the 'potlatch,' a great feast in which the giver disposed of large amounts of property (commonly blankets) in presents to all invited, being afterwards 'potlatched' in return, was so esteemed that in one of the cradle-songs, cited by Swanton ('Haida Songs,' p. 8), a child is told that he is a boy and not a girl, in order that he may give great potlatches—for that was he born. Swanton says (*HAI* ii. 293):

'During the festival in which the gifts were made, houses and carved poles were raised, chiefs' children were initiated into the secret societies, their ears, noses, and lips were pierced for ornaments, and sales of copper plates, which figured prominently in the social and economic life of the people of this region, took place. Among the Haida, children were then tattooed. All was accompanied with dancing, singing, and feasting.'

People save money for years in order to hold a great potlatch, and, distributing their wealth in this manner, become really 'rich' and attain high rank as chiefs, etc. It is said, as Swanton reports ('Haida Songs,' p. 21): 'Once when there was a great famine in Skidegate Inlet, the chief of Drum Town had enough property to hold a potlatch and save every one from starvation.' In a cradle-song the future potlatches of a child are likened to the deluge in the time of the Raven. In another, families are warned to be ready for invitations to the potlatch when the child is to be tattooed, etc. At potlatches and feasts the chiefs were placed 'in accordance with their wealth, the richer sitting nearer the inside house-pole, in the back part of the house.'

Among the peoples of the North Pacific Coast the salmon-ceremonials were of great importance.

11. Shamans, medicine-men, etc.—The shamans of the Haida deserve special mention from a religious point of view. According to Swanton (*HAI* ii. 522):

'Among the Haida and Tlingit, shamans performed practically all religious functions, including, as usual, that of physician, and occasionally a shaman united the civil with the religious power by being a town or house chief also.'

Shamans obtained their positions hereditarily, or by natural fitness. The former was more common, the shaman getting his position from his uncle, and 'inheriting his spiritual helpers, just as he might his material wealth.' He had a guardian spirit in either case, and 'the first intimation of his new power was given by the man falling senseless and remaining in that condition for a certain period.' This was the sign of the presence of a secret-society spirit or a guardian spirit.

12. Witchcraft.—Among the Haida, as with other peoples of the North Pacific Coast, belief in the power to influence or control the thought and actions of others by supernatural means, occult practices, and the like, prevailed. According to Swanton (*HAI* ii. 966):

'Among the Haida witchcraft was supposed to be due to mice which had got inside of a person's body, and if these could be expelled he might be restored to his right mind. There were said to be as many as ten of these mice sometimes, one of which (the last to leave) was a white one.' A means of detecting witchcraft employed by the Haida shamans was 'to repeat the names of all persons in the village in the presence of a live mouse, and determine the guilty party by watching its motions.'

One of the Haida families of the Eagle clan was called 'witch-people.'

13. Calendar.—Of the Haida month-names two refer to mammals, three to birds, two to fish, three to plants and fruits, and two to the weather. Swanton, in his account of the Haida calendar (*Amer. Anthropol.*, 1903), says that they formerly intercalated between the two portions into which they divided the year what they called a 'between moon,' which may sometimes have been omitted to correct the calendar. The two periods of the year, 'summer' (April–September) and 'winter' (October–March), consisted of six months each.

14. Art.—The art of the Haida is, in some respects, the most interesting and remarkable north of the region of Mexican and Central American influence. Indeed, as W. H. Holmes observes, 'The carvings of the Haida, Tlingit, Kwakiutl, and other tribes, in wood, bone, ivory, and slate are remarkable for their artistic qualities and perfection of execution, displaying more than a mere suggestion of the masterly qualities of the prehistoric work of the tribes of Mexico and Central America.' He says further: 'A carving in black slate by a member of the Haida tribe, representing the "bear mother," is not surpassed in spirit and expression by any known work north of Mexico. However, like the totem-pole models, masks, rattles, dishes, boxes, and tobacco pipes which excite our admiration, it was executed with steel tools and at a time when the influence of the art of the white man had no doubt come to be somewhat decidedly felt' (*HAI* ii. 491).

As materials whereupon to exercise their artistic sense the Haida had particularly the fine-grained black slate of the Queen Charlotte Islands, soft when first quarried, but growing harder with time, and taking a good polish; also the cedar-wood of this region, which enabled the tribes of the North Pacific Coast to attain a perfection not elsewhere reached among the aborigines north of Mexico. Haida carving and sculpture express themselves in special relations with religion, mythology, and history. Of wood-work we have the curiously carved and painted totem-poles (models of these for White consumption are now made in slate as well as in wood), and boxes for containing bones of the dead (grave-boxes), grave-posts, human figures and those of animals; the carved and painted house-fronts, posts, etc.; furniture (boxes and chests for storing household goods, property, etc.); implements, utensils, weapons, ceremonial objects (batons, etc.); masks, etc.

H. Balfour (*Man*, vii. [1907] 11.) describes a mask, carved from a solid block of wood some 40 years ago by a Haida Indian intended as a portrait of his wife, and said to be 'a good likeness.'

The Haida houses were substantially built of planks, and on the fronts were 'elaborately carved and painted symbolical figures,' while 'directly in front a totem pole is placed, and near by a memorial pole is erected.' Haida canoes are another example of the carver's art and that of the decorator. Of objects in slate the Haida made pipes, carvings of human beings, animals, and mythological figures. In horn, bone, and ivory, cups, ladles, spoons, and other utensils, implements, and ornaments were made, often in the form of or adorned with representations of human beings, animals, mythological beings, in whole or in part.

Of three Haida carved spoons described by Ridgeway (*Man*, vi. [1906] 145), one has the *motif* of a woman clasping a frog or a toad to her breast and kissing it; another a woman and a bear; a third a woman and a butterfly clasping each other. A fine old pipe has a woman and a raven in such a union.

The Haida were also skilful in metal work: copper was used for ornaments and utensils (knives, rattles, daggers, the 'coppers' used as symbols of wealth); of silver (introduced by the Whites) they made bracelets, etc., with symbolical figures engraved upon them. Other rather artistic developments appear in the chiefs' 'robes' of frayed bark, and in the ceremonial head-dresses. Noteworthy also is the Haida basketry hat. Rock-painting does not occur in the Haida country; according to

Newcombe, of two rock-carvings noted one is probably Tlingit.

15. Painting and tatuing.—Besides the use made of painting on masks, totem-poles, and other wooden objects and ornaments, house-fronts, canoes, etc., the Haida practised painting and tatuing of face and body. A. C. Fletcher says:

'Along the Pacific coast both men and women were tattooed on the face and body, a custom that recently reached its most ornate development among the Haida of Queen Charlotte Islands. The designs were of conventionalized "totemic" figures, and seem to have indicated personal or tribal distinction rather than any religious cult' (*HAI* ii. 700). Red and blue colours were employed.

16. Life and soul lore.—The souls of animals, according to the Haida, 'have the human form, and act very much as men do on earth.' According to Swanton (*Bull. 29 BE*, p. 189), 'every animal and every human being is supposed to be provided with a "thread of life"—an idea not found elsewhere in America, so far as I am aware.' The word applied to this 'thread of life' is *lis*—the term used also for thread made of mountain-sheep wool.

In one of the tales a woman lets out the 'thread of life' of her husband, who goes hunting, knowing by its action when he is coming back; in another tale a man is told to wear a new hat, when he leaves on a fishing expedition, and, when a storm occurs, 'she stretched her arm to the thread of life of him only who wore the new hat, and she saved him, because his wife left something for her.'

Restoration to life is a common thing in Haida tales, but Swanton (*Bull. 29 BE*, p. 349) met with but a single instance of restoration to youth, *i.e.* where Slaughter-lover 'spit medicine upon the old people they had killed, and they also became young.' Fire was the means of communication between this world and the world of spirits, the messenger being 'Old-woman-under-the-fire.' Water is also occasionally mentioned as serving for such purposes (*ib.* p. 14). Food for the slain in the land of souls was transmitted through fire. Concerning 'Woman-under-the-fire,' Swanton remarks (*ib.* p. 209):

'Woman-under-the-fire repeated to the supernatural beings everything that was said near it. But, if charcoal were instantly rubbed upon the lips of a person who had said anything they did not want the supernatural beings to hear, Woman-under-the-fire knew that it was not intended.'

The souls of those dying in battle or by violence went to Tāxēt's house in the sky. Concerning the souls of gamblers, we read in the tale of Sounding-gambling-sticks (*ib.* p. 57):

'He was also said to live in a place within sight of the Land of Souls, and, when a gambler died, he came over to gamble with him, staking dog salmon against souls. If he were successful, there would be many deaths; if the gambler won, there would be a great run of dog salmon.'

The re-incarnation of salmon in human beings (particularly twins) is a common belief among several peoples of the North Pacific coast, with whom the Salmon Festivals are of special significance.

17. Re-incarnation.—The belief in re-incarnation of the dead filled a very important rôle among the Haida, with whom the child was thought to be the returning father, mother, or other dead relative. The myths, legends, and songs treat often of this topic. In the cradle-songs the babies are reminded of what they used to do when formerly on earth; old tatu-marks and other evidences of their identity with those passed away are pointed out; their childish actions are rebuked as being unbecoming, since, *e.g.*, they are re-born chiefs, and 'too great to cry,' etc. In a cradle-song given by Swanton ('Haida Songs,' p. 5) a child is sung to as follows:

'You need not think that the smoke of your house in the middle of Skedans will be as great as when you were a woman [in your previous life upon earth].

You need not think that they will make such a continual noise of singing in Skedans Creek as they used to when you were a woman [in your previous existence].'

In another cradle-song we read (p. 38):

'Why does he cry as a noble cries (*i.e.* softly)?

Why does he move around as he sits?

He moves around and cries for grandfather's house.'

Many of the favourite stories of the Haida tell of the re-incarnation of the Raven or Shining-Heavens, their highest deity—particularly the myth 'How Shining-Heavens caused himself to be born.'

18. Influence of sea-environment on mythology and religion.—The influence of their island home and its sea-environment upon the mythological and religious ideas of the Haida has been very great, although not a few of the mythical figures, *motifs*, and incidents may have been borrowed rather recently from the Tsimshian, the Tlingit, and others. Water-monsters and supernatural beings of the sea of various sorts figure largely in folk-thought, myth, and legend. The most prominent group of those supernatural beings are the Killer-whales. The killer-whale (*Orca sp.*) appears in many stories of the type of 'The Man who married a Killer-whale Woman,' cited by Swanton (*Bull. 29 BE*, p. 286 f.). The killer-whale is prominent in Haida art, being often represented conventionally by his fin instead of by his whole body. In tales borrowed from Tsimshian and elsewhere, the rôle of the killer-whale is disproportionately emphasized, as, *e.g.*, in the story of Gunanasimgit (*ib.* 336-340).

19. Supernatural beings.—The Haida world teems with supernatural beings of land and sea, mountain and forest, river and lake, cliff and cave, air and sky. Communication between them and human beings is generally by way of fire, personified as 'Old-woman-under-the-fire' (see above), the messenger of the supernaturals. These supernatural beings 'are unable to bear the odour of urine, the blood of a menstruating woman, or anything associated with these' (*ib.* 148). They are believed to land their canoes bow first, and to do the opposite of the human in various other things. Supernatural beings 'hunt during the night, and get home before ravens begin calling; if they are detained in any way so that they hear the raven, they at once fall dead' (*ib.* 188). When a supernatural being was born, he grew up quickly, and soon cried for a bow, but would only be satisfied with one of copper. Supernatural beings made fire by rubbing hard white stones together. Those who have become animals can be recognized, when being skinned and cut open, by the ring of copper about their necks. Simply looking at them is said to be enough often to make supernatural beings laugh (*ib.* 268). Supernatural beings 'do not want anything dirty, like human beings, upon them.' Thus, a man often feels a reef shake under him for this cause (*ib.* 287).

Among the most noted supernatural beings, or figures with names of such, are the following: Killer-whale, Supernatural-woman-in-whom-is-thunder, the Wasgo, Cave-supernatural-being, Supernatural-fisherman (god of fishing), Master-Carpenter or Master-canoe-builder (a favourite deity of the canoe-building Haida), Mouse-woman, Supernatural-sparrow, Dagu-agana (being who tries the strength of heroes), Sacred-one-standing-and-moving, Supernatural-being-who-went-naked, The-one-in-the-sea (the greatest supernatural being in the ocean), Master-hopper (a one-legged supernatural being, or a being with one leg shorter than the other), Supernatural-being-at-whose-voice-the-ravens-sit-on-the-sea, Raven, Djiláqons, and Shining-Heavens.

The terms 'Master,' 'Greatest of,' 'Mother of,' 'Owner of' are often applied to supernatural or semi-supernatural creatures: *e.g.* 'Mother-of-halibut,' 'Greatest-of-gulls,' 'Owner-of-dog-salmon.' These supernatural beings seem often to have the power of assuming the form of a thing and yet to be distinct from it. Thus, *e.g.*, 'Cliff-woman,' or 'Reef-woman,' may be a cliff or a reef, and also live under it.

20. Deities, demi-gods, and heroes.—From the mass of characters in Haida mythology and folklore the following may be singled out as especially noteworthy: Shining-Heavens, Raven, Laguna, Djiláqons. Of these Laguna is a Tlingit spirit;

Djiláqons is the ancestress of the Eagle clan; the other two are the chief deities, or demi-gods, of the Haida. Sññ, or 'Shining-Heavens,' is 'the highest deity anciently recognized by them.' The myth of his incarnation, 'How Shining-Heavens caused himself to be born,' is one of the greatest of stories told by the Haida (Swanton, *Bull. 29 BE*, pp. 26-31).

One of the first incidents in this tale might be compared with the finding of Moses by the Egyptian princess: a Haida woman, digging on the beach, uncovers a cockle-shell, from which comes the cry of a baby. She looks into it and discovers a little child, which she takes home. The wonder-child soon grows up; it is Shining-Heavens, who shows his supernatural character in the approved way. In one myth the Raven finds a cockle-shell full of children thrown about by the waves. By some this birth in a cockle-shell is interpreted to mean birth from a cockle. The birth of the wonder-child, the re-incarnation of some famous personage, or the incarnation of some supernatural being, is the typical hero-story of the Haida.

Besides the tale of Shining-Heavens, we have the story of 'He-who-got-supernatural-power-from-his-little-finger,' 'He-who-was-born-from-his-mother's-side,' and others. Abandoned or put-away children often figure in hero-tale, such, *e.g.*, as 'The-one-abandoned-for-eating-the-flipper-of-a-hair-seal.' That the existence of a Raven clan among the Haida, Tlingit, and Tsimshian has had something to do with the importance of Raven stories in their mythology is pointed out by Swanton (*Bull. 29 BE*, p. 146, and 'Ethnol. of Haida,' p. 104), who gives (*Bull. 29 BE*, pp. 110-149) the tale of 'Raven Traveling,' which is sometimes spoken of as the 'creation legend of the Haida'; but, as Swanton remarks, it rather 'explains how things were altered from one state or condition into that in which we now find them' (p. 146). Raven, indeed, is transformer rather than creator, although he is represented as having originated not a few things, and is the principal figure at the 'creation,' for 'topographic features, natural phenomena, the tastes, passions, habits, and customs of animals and human beings are mainly explained by referring to something that Raven did in ancient times.' His story-name is Nañkñlslas, or 'He-whose-voice-is-obeyed.' He has a bullock-side, like some other American Indian gods and demi-gods, but some Haida also express the opinion that 'Nañkñlslas was a great chief who put on the skin of a raven [the usual magic device] only when he wanted to act like a bullock.' The travelling companion of Raven is Eagle or (among the Masset Haida) Butterfly. Other interesting deities are Taxët (whose name is confused with that of a small bluish salmon), to whose house in the sky go all murdered or killed in battle; and Tia, the Killer, 'the deity who presides over death by violence.' Tia, who is headless with blood streaming from his neck, is seen or is heard by those about to be killed (*ib.* 172). A curious feature of Haida mythology, as Swanton notes, is the fact that all the 'river-spirits' seem to be women, only a single instance to the contrary having been met with. Among these water-creatures, who appear frequently in the tales and legends, are the following: Creek-woman (in various localities); Supernatural-woman-who-plays-up-and-down-with-her-own-property (*i.e.* with the fish); Flood-tide-woman; and the Tidal-woman. One of the winds, North-east, was named after Fair-weather-woman, who figures in several stories. Other female characters in Haida mythology and folk-lore are: the Half-rock (stone from hips down) -woman, or Woman-rooted-to-the-ground; Old-woman-under-the-fire (messenger from men to the supernatural beings); Porpoise-woman; Ice-woman; Property-woman; Mouse-woman; Panther-woman (this character has a Tsimshian name); Woman-sitting-and-smelling. But the most famous female figure in Haida lore is Djiláqons. Djiláqons is the ancestress, or at least the special patroness, of all those of the Eagle clan; and she figures in a

scandal with Swimming-russet-backed-thrush, another supernatural being.

21. **Animals in legends.**—In the legends of the Haida a large proportion of the birds, beasts, and fishes of their environment figure more or less prominently: whale, porpoise, seal, sea-lion, salmon, cod, halibut, devil-fish, eulachon, sculpin, herring; gull, duck, water-fowl (scoter, grebe, etc.), eagle, raven, crow, cormorant, wood-pecker, owl, wren, hawk, puffin, loon, dipper (water-ousel), goose, robin, thrush, blue hawk, blue jay, snowbird, creeper, tanager, grouse, black-bird, sparrow; beaver, porcupine, marten (older brother of black bear), land-otter, dog, black bear, grizzly bear (a bugaboo for children), mouse, mink, heron, ground-hog, weasel, frog, etc. Some of the mainland animals, such as the wolf, also appear. The animals in the story have names different from their common everyday ones. Thus marten is commonly *Kux.u.*; but in stories he is called *Kux.ugfnágtts.* The Thunder-bird and the Sleep-bird are peculiar characters. Of the land-animals the land-otter has a rôle *sui generis*. According to Swanton ('Ethnol. of Haida,' p. 26 f., *Bull.* 29 BE, p. 225),

'A man who just saved himself from drowning was supposed to be deprived of his senses by land-otters and become transformed into a creature called *gáigiz.ú.* This being had land-otter fur all over its body, and upturned nose, and a face covered with fish spines. It travelled all over the Haida country with the utmost ease.'

If a land-otter looked at any one while drinking water, that person 'was seized with fits, soon died, and went to live among the Land-otter people' (*Bull.* 29 BE, p. 270). The idea that loss of the senses or craziness is caused by the land-otter is common to several of the Indian peoples of the North Pacific Coast. Concerning the land-otter we learn also (*ib.*) that 'if a land-otter forgot to take along the mat used to cover the knees of a canoe-man while paddling, he was sure to be killed by human beings.'

LITERATURE.—The most authoritative recent literature concerning the Haida consists of the various monographs of Swanton, the earlier Reports of Boas, etc. The following may be cited here: Franz Boas, 'Decorative Art of the Indians of the North Pacific Coast' (*Bull. Amer. Mus. Nat. Hist.*, N.Y., vol. ix. no. 10 [1897]), 'Facial Paintings of the Indians of Northern British Columbia' (*Mem. Amer. Mus. Nat. Hist.*, i. [1898] 1-24), 'Reports on N.W. Tribes of Canada' (*Rep. Brit. Assoc. Adv. Sci.*, 1889-1898), *Indian. Sagen von der nord-pazifischen Küste Amerikas*, Berlin, 1895; Stewart Culin, 'Games of the North American Indians,' in 24 *RBEW*, 1907; G. M. Dawson, 'Report on the Queen Charlotte Islands' (*Rep. Geol. Survey of Canada for 1878-1879*), Montreal, 1880; James Deans, 'Tales from the Totems of the Hidery' (*Arch. Intern. Folk-Lore Assoc.*, ii.), Chicago, 1889; C. F. Newcombe, 'The Haida Indians' (*Congr. Intern. des Amér.*, xviiième sess., Quebec, 1906 [1907] i. 135-149); J. G. Swan, 'The Haidah Indians of Queen Charlotte's Islands, British Columbia' (*Smithsonian Contrib. to Knowl.*, vol. xxi., Washington, 1874); John R. Swanton, 'Contributions to the Ethnology of the Haida' (*Mem. Amer. Mus. Nat. Hist.*, N.Y., Anthrop. v. [1905] 1-300), 'Haida Texts (Masset Dialect)' (*ib.* x. [1908] 271-812), 'Haida Texts and Myths (Skidegate Dialect)' (*Bull.* 29 BE [1905]), 'Haida Songs' (*Publ. Amer. Ethnol. Soc.* iii. [1912] 1-63), 'Haida' (*HAI* i. [1907] 520-523); on the language, see John R. Swanton, 'Haida' (*Handb. of Amer. Ind. Lang.* [*Bull.* 40 BE], i. [1911] 205-282), C. Harrison, *Haida Grammar*, ed. A. F. Chamberlain, Ottawa, 1895. Mention may also be made of *OT Stories in the Haida Lang.*, London, 1893, and of the partial tr. of the *Pr. Bk.* by J. H. Keen, do. 1899, and of the tr. of three *Gospels and of Acts*, by C. Harrison and J. H. Keen, 1891-97.

ALEXANDER F. CHAMBERLAIN.

HAIL.—See **PRODIGES AND PORTENTS.**

HAIR AND NAILS.—In custom, ritual, and superstition, the same ideas underlie the majority of beliefs and ceremonies relating to human hair and nails; and the whole class of observances may be conveniently treated in a single article. Sometimes, indeed, customs may be due to the close connexion of the hair with the head; and analogies in the case of the nails will naturally be wanting. For example, certain practices relating to the

hair of the head appear to have originated from the wide-spread belief that the head (*q.v.*) itself is particularly sacred (see Frazer, *GB*³, pt. ii. 'Taboo,' p. 252 f.). Some races think that a spirit lives in the head, and it is important not to disturb this spirit more than is necessary, or, as among the Greeks, the hair is itself regarded as the seat of life (Gruppe, *Gr. Myth. und Religionsgesch.*, Munich, 1906, pp. 187, 728)—a belief which is also found, in a modified form, among the Omaha (Fletcher and La Flesche, 27 *RBEW* [1911], p. 124). Hence the Burmese shrink from frequent washing of the head; and, when the hair of their kings was cut, the operation was attended with much solemnity. Possibly, therefore, some superstitions concerning hair-washing or hair-cutting arise from a special fear of offending or injuring the spirit of the head. Samson's strength was lost as soon as the hair of his head was cut off (Jg 16^{17a}). But, in the main, these superstitions are the outcome of a primitive belief which affects the nails as much as the hair. The savage thinks that any portion of his body, though severed, still retains some sort of connexion with himself. Thus, injury to the hair or nails is liable to cause danger to the person to whom the clippings belonged. The principle of 'sympathetic magic' is well-known in folklore; and, if a man can work magic on an enemy by obtaining a portion of his clothing, it is even more readily comprehensible that he can do mischief by means of a part of his enemy's actual body. The simplest precaution against this danger is obviously to avoid hair-cutting altogether. This course is sometimes taken to protect those whose lives are specially valuable, as in the case of the Frankish kings (*GB*³, pt. ii. p. 258), but more often the cutting of hair or nails is avoided only on certain occasions or at certain periods, when it would be more dangerous than usual. Young children are frequently thought to be peculiarly exposed to magic; hence we often find that neither nails nor hair may be cut in infancy or during the early years of childhood. This superstition is (or was till recently) common in England; *e.g.*, a baby's nails must not be cut until it is a year old, otherwise it will be 'light-fingered,' or ill-luck will result (see *County Folklore*, i. [1892] 12 [Suffolk], v. [1908] 230 [Lincolnshire], etc.). Usually the danger is avoided by biting the nails (one of the superstitions which indicate a fear of iron). This practice is widespread in Europe (see *Denham Tracts*, ii. [1895] 24; *County Folklore*, iv. [1904] 58; *Mélusine*, ii. 486, for examples from various parts). So, among the negroes of Jamaica, to cut the nails of infants with scissors will make them thieves (*FL* xvi. [1905] 68).

In the case of adults, the hair (or sometimes the nails) must not be cut during times of special danger. According to Diodorus (i. 18), Egyptian travellers did not cut their hair until the end of their journey. The inhabitants of Taïf in Arabia shaved their heads at the sanctuary of their town, on returning home. Robertson Smith, who quotes this example (*Rel. Sem.*² 331), suggests that the bond between the worshipper and his god has been loosened by absence during the journey, and the offering of hair has the effect of binding it again. This explanation is very possible in certain cases; but more probably the custom of leaving the hair uncut during a journey arises from the fear that a stranger may work magic by means of the locks. It is also possible that the idea of purification may underlie the practice: a traveller has been exposed to defilement or infection among strangers, and he removes the uncleanness by cutting his hair on returning home. Van Gennep (*Rites de passage*, p. 263) lays stress on the pilgrimage or journey as

intermediate between two stages (*séparation et agrégation*), each of which has its appropriate ritual.

In Greek myth, Achilles kept his hair uncut because his father Peleus had vowed it to the river Spercheius, if his son should come home from war in a foreign land (*Il.* xxiii. 144 ff.). This, however, does not prove that the early Greeks were among those who abstained from hair-cutting when on a dangerous expedition; Achilles had left home as a boy, and (as will be seen below) it was a practice for Greek youths to offer their hair to the local river on reaching manhood. But the passage is a good example of the common custom whereby the hair is left uncut during the period of a vow. A Nazirite was commanded to let his hair grow while under a vow; afterwards he shaved 'the head of his separation' at the door of the tabernacle, and burned the hair in the sacrificial fire (*Nu* 6st; see also *Ac* 18th 21st). Here, and in many other cases, the hair-cutting seems to be a means of purification for the person who, during the continuance of the vow, has been unclean.

Besides the period of a vow, there are other occasions on which the cutting of hair is avoided. According to a common English superstition,

'It was better you were never born
Than on the Sabbath pare hair or horn.'

(For European parallels, see *Mélusine*, ii. 487 f.) Here Christianity has no doubt adopted a pagan superstition, which is mentioned as early as Hesiod (*Works and Days*, 742 f.: *μηδ' ἀπὸ πεντόξοιο θεῶν ἐν δαίτῃ θαλερῇ | αἶον ἀπὸ χλωροῦ τάμνειν αἰθωνί σιδήρῳ*, i.e. nails must not be cut at a religious festival). The same warning is given in the *Symbols* of Pythagoras, where the prohibition extends to the hair also (*Iambl. Vit. Pyth.* 25, *Protrept.* 384). Plutarch (*de Is. et Osir.* 4) offers the explanation that nails are secretions (*περιττώματα*), and therefore impure. The remark is sensible enough; but we may perhaps look a little deeper for the origin of the tabu. We have seen reason to suppose that hair-cutting often marks the end of an unclean state, by carrying off the infection. But, within the range of savage thought, the same cause may produce results diametrically opposite; and, amongst some races, the danger of hair-cutting must be counteracted by various observances. The Maoris, in particular, were placed under many restrictions, and were debarred from all social intercourse for some days after the operation (*GB*³, pt. ii. p. 264). The ancestors of the Greeks and other Europeans may well have suffered similar restrictions; and the idea that the cutting of hair or nails prevented access to a festival would naturally pass into a belief that the festival would be defiled by such an act. Besides Sunday, Friday is commonly considered an unlucky day for hair or nails—e.g. in Somerset (*FL* v. [1894] 338), in the Hebrides (*ib.* x. [1899] 268), and elsewhere. Sometimes a distinction is made, as in Northumberland, where it is unlucky to cut hair on a Friday or pare nails on a Sunday (*Denham Tracts*, ii. 343). The prohibition, as far as regards Friday, seems to be influenced by Christianity; at least among the later Romans, Friday was lucky for the hair, as appears from a verse found in Ausonius (*Eclog.* 1: 'ungues Mercurio, barbam Iove, Cypride crines,' i.e. the nails should be cut on Wednesday, the beard on Thursday, the hair on Friday). Among the modern Jews in Jerusalem it is thought that nails should be cut early in the week, that they may not start growing on the Sabbath (*FL* xv. [1904] 187).

When it is necessary to cut hair or nails, there is a further difficulty in disposing of the clippings. For, as has been mentioned above, they may fall into the hands of an enemy who can work magic

upon them. In Europe this idea survives in the belief that a person will suffer from headache, if any of his hair is carried off by birds to build their nests. To avoid risk, the clippings are often burnt or buried. At Rome, the *flamen Dialis*, who was subject to many kinds of tabu, was obliged to bury the cuttings of his hair or nails under a fruit-tree (*Aul. Gell.* x. 15). A large number of parallel instances are collected in *Mélusine*, ii. 360 f.; *GB*³, pt. ii. p. 274; Hartland, *LP* ii. 132 ff. Harm may be done innocently as well as by malice; hence the warning, in a 'symbol' of Pythagoras, not to defile or stand upon the cuttings (*ἀπορυχίσματα καὶ κουραὶς μὴ ἐπουρεῖν μηδὲ ἐφύρασθαι* [*Diog. Laert.* viii., *Vit. Pyth.* § 17]). In another Pythagorean 'symbol' there is an injunction to spit on the cuttings (*Iambl. Protrept.* 21), obviously as a prophylactic (for this virtue of saliva, see Sittl, *Die Gebärden d. Griech. u. Röm.*, Leipzig, 1890, p. 117 f., and Hartland, ii. 258 f.). Brand (*Pop. Ant.*³, 1870, iii. 263) mentions a superstition that one should spit three times on hair which has been combed out, before throwing it away. In many cases, when the hair or nails are not burnt or buried, they are carefully preserved. Often the motive is a fear of magic; but occasionally the practice is due to a different cause. Those who believe in a resurrection of the body have a natural anxiety that no part of their person may be missing on the day of resurrection. In Leitrim, while some peasants burn their hair and nails for fear of the fairies, others keep their hair-cuttings, which may be required on the Day of Judgment to turn the scale against the weight of sins (*FL* vii. [1896] 182 f.). This explanation has probably superseded an original fear lest the body should be incomplete. Indeed, in Cavan this reason is avowed; it is unlucky to burn hair, which will be required on the Last Day in order that the body may appear as God created it (*FL* xix. [1908] 319). Such an idea is not confined to Christian races; Frazer (*GB*³, pt. ii. p. 279) quotes similar beliefs from the Incas of Peru, the Turks, and others.

In leech-craft, the use of hair and nails is widespread; only a few typical examples can here be given. Pliny (*HN* xxviii. 23) mentions, as a remedy for fever, that the Magi placed the parings from a patient's fingers and toes at the door of another man, before sunrise. Some of the Magi, more innocently (as Pliny adds), order the parings to be thrown on an ants' nest; the first insect that carries off the nails is to be caught and worn as an amulet. These prescriptions are generally explained, with Pliny himself, as cases of the 'transference of evil' to another person, animal, or place; and many cases of folk-medicine seem to be based on this principle. In the Hebrides, epilepsy is cured by burying a black cock with clippings of hair and nails from the patient. In Meath, a child may be cured of the same malady by burying some of his clothing with a lock of his hair. As the linen moulders, the child recovers (*FL* xix. 316). Here, and often, the object is to be rid of the disease by mere transplantation. But, as Hartland notes (ii. 144 f.), many of the cases generally explained by transference are different. In a common type of leech-craft, the hair or nails of a sick person are stuffed into the hole of a tree, or hung up in its branches. Here the object may often be to secure a healing union with a healthy tree; for in a similar rite, in which a sick child is passed through a tree, the good health or preservation of the tree is an important feature. It is quite possible, therefore, that the idea of a healing union is the motive of some other practices in which the parings are transferred to an animal or man; and Hartland thinks that the notion of mere transference has often obscured or supplanted an older

belief in the virtue of union with a healthy object, whether human being, animal, or plant.

Apart from cases of sickness, the hair is very commonly found as a medium of connexion or union. This idea is probably at the root of the well-known custom of dedicating a lock of hair to a god. At a later stage of thought, the hair is no doubt considered as a mere symbol; but in earlier times the worshipper, by offering a part of himself, is put in actual communion with his god. In Greece, as we have already seen in the case of Achilles, youths and maidens offered their hair to deities on reaching maturity. Frequently the deity was the life-giving river of the country; Orestes presents a lock 'for nurture' (*θρεπτήριον*) to the Inachus (*Æsch. Choeph.* 5). (For other examples, see Pausanias, i. 37. 3, viii. 20. 3, and 41. 3, with Frazer's note, giving parallels from other nations.) Both in Arabia and in Syria it seems to have been customary to sacrifice hair as an initiation into the state of adolescence (*Rel. Sem.*³ 327 f.; cf. Lucian, *de Dea Syr.* 55). The custom was regular at Rome, the hair being dedicated to some patron deity; e.g., Nero dedicated his first beard to Jupiter (see references in Mayor on Juvenal, iii. 186). Offerings of hair were also made on other occasions in Greece—as by girls before marriage (Herod. iv. 34; Paus. i. 43. 4). In these cases, the offering may have been 'propitiatory,' as it was made to virgin-deities, and seems designed to avert their wrath at the marriage of their worshippers. But the general idea is the same: the worshipper is put in communion with the deity. Pausanias (ii. 11. 6) mentions a statue of Hygieia, the goddess of health, which was almost hidden by women's hair and garments, no doubt dedicated before or after childbirth. Similarly, the cutting of hair is the means whereby the living are put in direct communion with the dead. Often the mourner's hair is placed on the tomb, or in the grave, or on the corpse itself. Here the desire to maintain connexion with the dead is, no doubt, the original motive, though frequently forgotten. The custom is classical: in *Æsch. (Choeph.)* 6, Orestes offers hair at the tomb of his father, as well as a lock to the river-god (see also Soph. *El.* 52, 449, *Aj.* 1174; Eur. *Tro.* 480; Lysias, *Epit.* 60; Bion, i. 81; for parallels from other peoples, see Hartland, *LP* ii. 220 ff.). In many instances the hair is not brought into close contact with the dead, and appears to be cut simply as a token of mourning (as in Homer, *Od.* iv. 198; Eur. *Alc.* 101, *Or.* 458; and often in other races). But here it is probable that the original purpose has been forgotten, and the cutting of hair has degenerated into a mere expression of grief. Hence the Persians cut not only their own hair, but also that of their horses, after the death of a famous general (Herod. ix. 24). By a natural extension, Death himself was said to cut off a lock from the head of a doomed person (Eur. *Alc.* 74 f.; Verg. *Æn.* iv. 698 f.). In many of these cases it has been thought that the offering of hair is a substitution for the whole person, who is thus spared the necessity of being actually sacrificed to the dead (see Tylor, *PC*³, 1891, ii. 401). According to a slightly different view, the hair is a pledge of the ultimate union of the mourner with the dead in the nether world. Both these explanations may hold in certain instances; but the general idea (as stated above) seems to be rather a wish to preserve connexion between the living and the dead (see *LP* ii. 325 f.).

The broad idea that union can be effected by means of the hair or nails may be illustrated by other practices. As is well known, savages lay great stress on the influence of diet, believing that to consume part of a man or animal will transmit

their distinctive qualities. Thus, in Japan, the character of another person was acquired by boiling his nails in water and drinking the decoction (*FL* xii. [1901] 71). In Jerusalem a Jewess will sometimes serve her hair or nail-parings in a pudding to her husband, in order that his love may be increased (*ib.* xv. 187). Instances might easily be multiplied. An equally primitive conception—that the processes of Nature can be controlled or influenced by human magic—can also be traced in various superstitions connected with the hair and nails. The Maoris believed that hair-cutting might cause a thunderstorm (*GB*³, pt. ii. p. 271); and, as Frazer adds, the same idea is probably the base of a Roman superstition that on shipboard the hair or nails should be cut only in a storm (Petron. 104). Petronius' own explanation is that the omen would be bad, as the sailors' most desperate vow was to offer their hair to the sea-god. Such vows, it is true, were common in classical times (see references in Mayor's note on Juv. xii. 82); but the origin of the maxim is, no doubt, the belief that, when the storm had arisen, the harm was already done. The use of hair as a rain-charm is clear from the examples collected in *GB*³, pt. i. 'Magic Art,' vol. i. p. 251 f.

LITERATURE.—For European and other folk-lore in this connexion, see *Mélysine*, ii. (Paris, 1884-85) 360, 481 f. (Gaidoz and Rolland), iii. [1885-86] 333. The general subject is treated by J. G. Frazer, *GB*³, pt. ii. 'Taboo,' London, 1911, p. 258 f., and by E. S. Hartland, *Legend of Perseus*, do. 1895, ii. 64 f., 132 f. See also W. Robertson Smith, *Rel. of Sem.*³, Edinb. 1894, pp. 325 f., 481 f.; G. A. Wilken, 'Über das Haaropfer und einige andere Trauergebräuche bei den Völkern Indonesiens,' in *Revue coloniale internat.* iii. [1886] 225 f., iv. [1887] 345 f.; F. B. Jevons, *Introd. to Hist. of Religion*, London, 1896, p. 193 f.; A. van Gennep, *Les Rites de passage*, Paris, 1909, p. 238 f.; J. Kirste, 'Indogerm. Gebräuche beim Haarschneiden,' *Analecta Græciensia*, Graz, 1893, pp. 53-59; W. Crooke, *PR* ii. 66 f., 277 f.; I. Benzinger, I. Broydè, and J. Jacobs, 'Hair,' in *JE* vi. [1904] 157-159; M. Seligsohn, 'Nail,' *ib.* ix. [1905] 149 f.; I. Benzinger, 'Haar,' in *PRE*³ vii. [1899] 276 f. (cf. R. Zehnpfund, *ib.* xx. [1908] 84, 88); A. C. Fletcher, 'Hair Dressing,' in *HAI* [*Bull.* 30 *BE*], i. [1907] 524-526; O. Schrader, art. 'Haartracht,' in *Reallex. der indogerm. Altertumskunde*, Strassburg, 1901, pp. 315-319.

E. E. SIKES.

[The cutting or tearing of the hair in mourning for the dead has been mentioned in *ERE* iv. 439 f. [primitive], 484^b [non-Aryan Indian], and abundant Hebrew and Jewish material is collected in *PRE*³ xx. [1908] 84, 88, and *JE* ix. [1905] 101 f. The same custom is also found on the American continent, as among the Shastan, Dakota, Crow (Yarrow, *Introd. to the Study of Mortuary Customs among the N. Amer. Ind.*, Washington, 1880, pp. 61, 71 f., 91), Iroquois, Virginians, Brazilians, Caribs (Lafitau, *Mœurs des sauvages amér.*, Paris, 1724, iv. 151 f.), Tlingit (Swanton, *26 RBEW* [1908], 429), and Pima (Russell, *ib.* 195). Among the Salish, according to Hill-Tout (cited by A. C. Fletcher, *HAI* i. 952), the conventional sign of mourning

'is the severing of the hair of the surviving relatives, who dispose of it in various ways according to the tribe—by burning it to prevent its falling into the hands of a sorcerer; by burying it where vegetation is dense, thus insuring long life and strength; by putting it away for final burial at their own death; by casting it into running water, and by fastening it to the branches on the eastern side of a red-fir tree.'

Occasionally hair is taken from the corpse instead of being cut off in its honour by the survivors. Thus, among the Iroquois a lock of hair from the corpse was given to the nearest relative of the deceased (Lafitau, iv. 122 f.). Among the Zuñi, locks are cut from the corpse and placed in a niche in the wall, the belief being

'that, if a person takes a bit of hair of a deceased friend, burns it, and inhales the smoke, he will have good health and not die, but go to sleep and thus pass on to Ko'thluwala'wa (the place of the dead)' (M. C. Stevenson, *23 RBEW* [1904], 309).

Among the Tlingit this usage is directly connected with the belief in re-incarnation. According to Swanton (*loc. cit.*),

'if a very dear relative had passed away, people often took the nail from the little finger of his right hand and a lock of hair from the right side of his head and put them into the belt of a young girl of his clan just reaching maturity. Afterwards she had to lead a very quiet life for eight months and fast for as many days, unless she were delicate, when half as many sufficed. . . . After her fast was over, and just before she ate, she prayed that the dead person would be born again from her, and also that she would marry well and live a good life.'

The formal cutting of the hair is sometimes a part of initiation rites. A conspicuous case is found in the Omaha consecration of a boy to Thunder, the symbol of the power controlling the life and death of the warrior (for a full description, see Fletcher and La Flesche, *27 RBEW* [1911], 122-128). Similarly, in India the hair of the child was ceremonially cut into the form appropriate to his family, and before such rites as the new and full moon ceremonies the ritual prescribed the clipping of hair and nails (see, for details, Oldenberg, *Religion des Veda*, Berlin, 1894, pp. 425-429). This reference to the peculiar form of family hair-dressing recalls the similar Omaha usage, where the child's hair is cut in a specific manner for each gens (see Fletcher and La Flesche, 42-46, 145 ff.), this being retained until the time of second dentition, when the hair is allowed to grow (*ib.* 128). As among the Omaha different gentes had their individual ways of cutting the child's hair, so different tribes were distinguished by divergent modes of wearing the hair. Thus the Pawnee

'cut the hair close to the head, except a ridge from the forehead to the crown, where the scalp-lock was parted off in a circle, stiffened with fat and paint, made to stand erect, and curved like a horn, hence the name *Pawnee*, derived from *pariki*, "horn." . . . The Dakota and other western tribes parted the hair in the middle from the forehead to the nape of the neck, the line, usually painted red, being broken by the circle that separated the scalp-lock, which was always finely plaited, the long hair on each side, braided and wrapped in strips of beaver or otter skin, hanging down in front over the chest. The Nez Percés of Idaho and neighbouring tribes formerly wore the hair long and unconfined, falling loosely over the back and shoulders. In the S.W. among most of the Pueblo men the hair was cut short across the forehead, like a "bang," and knotted behind' (Fletcher, *HAI* i. 524). For the usages among the Indo-Germanic peoples, see Schrader, *Reallex. der indogerm. Altertumskunde*, Strassburg, 1901, pp. 813-818; Hirt, *Indogermanen*, do. 1905-07, pp. 462 f., 723. Concerning the American scalp-lock, Miss Fletcher adds that 'this lock represents the life of the child, now placed wholly in the control of the mysterious and supernatural power that alone could will his death. The braided lock worn thereafter was a sign of this dedication and belief, and represented the man's life. On it he wore the ornaments that marked his achievements and honors, and for anyone to touch lightly this lock was regarded as a grave insult. As a war trophy the scalp-lock had a double meaning. It indicated the act of the supernatural power that had decreed the death of the man, and it served as tangible proof of the warrior's prowess in wresting it from the enemy.'

Marriage frequently involves a change in the mode of wearing the hair. Among the Hopi the unmarried girl wears her hair in a whorl over each ear, symbolizing the squash flower, but after marriage the hair is worn in two braids. Among the Indo-Germanic peoples the hair of the wife is parted and covered, whereas the unmarried wear it loose (cf. Haas, 'Heiratsgebräuche der alten Inder,' in *Ind. Stud.* v. [1861] 405 f.; Von Schröder, *Hochzeitsgebräuche der Esten*, Berlin, 1888, p. 144 ff.), just as the married Jewess covers her own hair with a wig. Again, difference of rank is marked by different modes of wearing the hair, shorn hair being characteristic of the slave, as contrasted with the long locks of the free man (Schrader, 318); among the Franks only the kings wore their hair long (Agathias, *Hist.* i. 3). Cutting off the hair is found, furthermore, as a punishment for adultery in India and among the ancient Teutons (*ERE* i. 129^a; Tacitus, *Germ.* xix.), for false accusation among the Assyro-Babylonians (*ERE* iv. 259), and for other offences (*ib.* 252^a).

The general principle that the hair, as being a part of the individual, gives him who has received or taken it from its original owner some power over and connexion with that owner finds illustra-

tion in folk-tales where one friend gives another some of his hair, which, on being burned, summons the primary possessor to the assistance of his friend (Steel and Temple, *Wide-Awake Stories*, Bombay, 1884, pp. 13 f., 32-34, 414; for further instances, see MacCulloch, *CF*, 211 f.; and for hair as a life-token, etc., *ib.* 126 f.). It is also to be noted that in folk-magic, particularly in love-charms, the use of pubic hair plays a part (Ploss-Bartels, *Das Weib*², Leipzig, 1908, i. 292).

Attention has already been called to the importance of the day on which the nails are pared. The order in which the nails of the individual fingers should be trimmed is also sometimes held to be of moment. Among the Parsis the order is 4, 2, 5, 1, 3 (Anquetil du Perron, *Zend-Avesta*, Paris, 1771, ii. 117); and this is adopted by Rabbinical authority for the left hand, though some maintain that for the right the order should be 2, 4, 1, 3, 5, the left hand being first manicured; others, however, hold that the right hand should be cared for first, and that the order should be 1, 3, 5, 2, 4 (Seligsohn, *JE* ix. 149). The impurity of the serpent which caused Adam's fall was under the nails (*ib.*); the Hindus also hold that the nails are dangerous, those of Europeans distilling deadly venom, so that they eat with knives and forks, instead of with their fingers (Crooke, *PR* ii. 9); and in portions of America the scratch of a negro's nails is said to cause blood-poisoning. The burning of hair and nails to drive away demons or to avert the evil eye is not based on the inherent properties of those substances, but is intended merely to create a stench, to which demons are notoriously sensitive (Thurston, *Omens and Superstitions of S. India*, London, 1912, pp. 53, 115). LOUIS H. GRAY.]

HAJJ.—See ARABS, PILGRIMAGES (Muslim).

HALAKHA.—See JUDAISM.

HALĒBĪD (Kanarese *halē-bīḍu*, 'old ruins').—A village in the Hassan District of Mysore; lat. 13° 13' N.; long. 76° E.; the site of the great ancient city Dorasamudra, Dvārasamudra, or Dvārāvātipura, the capital of the Hoysala Ballāla dynasty. It was founded in the early part of the 11th cent. A.D., and largely rebuilt by Rājā Vira Somēśvara in the 13th. He is said to have been attacked by leprosy, and was warned to erect temples in honour of Śiva as a means of curing his disease. This probably accounts for the splendid religious buildings which survive to the present day. The city was captured by the Muhammadan general Kāfūr, and plundered in 1310. Sixteen years later it was finally destroyed by another army of Musalmān invaders. One Śaiḡva temple is said by Fergusson to be dedicated to Śiva in his form Kaitābhēśvara (Kaitābha being the name of an Asura, and Kaitābhā a title of Durgā, the spouse of the god); but Rice shows that its proper name is Kedāreśvara, 'Lord of Kedār' (see KEDĀRNĀTH), and that it was erected by Vira Ballāla and his queen Abhinavā Ketalā Devī, about 1219. Of this temple Fergusson says:

'If it were possible to illustrate this little temple in anything like completeness, there is probably nothing in India which would convey a better idea of what its architects are capable of accomplishing. It is, however, surpassed in size and magnificence by its neighbour, the great temple at Hullabid [known as Hoysalēśvara, "Śiva, Lord of the Hoysala dynasty"], which, had it been completed, is one of the buildings on which the advocate of Hindu architecture would desire to take his stand' (*Ind. and East. Arch.*, ed. 1910, i. 442 f.).

This, the older of the two ornamental temples, was probably commenced by Vinayāditya (A.D. 1047-1100). It is unfinished; but whether this was always the case, or whether it was completed and afterwards lost its towers, is uncertain (Rice, *Mysore*², i. 514). Fergusson has given an elaborate

and enthusiastic description of this magnificent building. Rice, however, corrects his proposed restoration, assuming that the final ornament of the towers, resembling a lantern, was really a sacrificial vase (*kalasha*), bound round with a cloth knotted towards the four cardinal points, such as is filled with holy water and used at the consecration of a temple. Fergusson remarks:

'The mode in which the eastern face is broken up by the larger masses, so as to give height and play of light and shade, is a better way of accomplishing what the Gothic architects accomplished by their transepts and projections. This, however, is surpassed by the western front, where the variety of outline, and the arrangement and subordination of the various facets in which it is disposed, must be regarded as a masterpiece of design in its class.'

Rice (i. 515 ff.) gives a full account of this splendid temple.

LITERATURE.—B. L. Rice, *Mysore*², London, 1897, i. 514 ff.; M. Wilks, *Historical Sketches of the South of India*, ed. Madras, 1869, i. 7; F. Buchanan, *Journey through Mysore*, London, 1807, iii. 890 ff.

W. CROOKE.

HALEVI.—I. Life.—Jehudah ben Samuel Halevi (Arab. *Abū-l-Ḥasan Yahūdāh ibn Allavi*), Jewish philosopher and poet, was born in Toledo about 1085 (the year in which that city, the meeting-place of East and West, fell before Alphonso VI.), and died in Palestine about 1143.

Halevi was sent at an early age to the Rabbinical seminary of the famous Isaac Alfasi at Lucena. In addition to the usual subjects of Rabbinical study, he devoted himself to mathematics, the natural sciences, philosophy, and, since he was to be a physician, medicine. Arabic he learnt to write as skillfully as he did Hebrew. A born singer, he gave himself to poetry when he was quite a young man. On the completion of his medical studies he began to practise, first in his native city, and later at Cordova. But, though successful, he does not appear to have had much love for his vocation. His chief interest was literature, religious literature more especially; and, as he grew older, his sympathy with his oppressed people and his love for Palestine, the cradle of their lost greatness and the promised scene of their future glory, became his ruling passion. Meanwhile theological study, the instruction of young men in Rabbinics, and literary pursuits relieved the monotony and disappointments of his professional life. He wrote poems, both secular and religious, mainly in Hebrew, and his great philosophical work, *Kitāb al-Khazari*, usually known as the *Kuzari*, in Arabic. His religious poems have enriched the liturgy of the synagogue; his *Kuzari* is a classic. It was soon after the completion of the latter work—he was then about fifty-five—that he found opportunity for realizing the great dream of his life. To see Jerusalem with his own eyes, and to worship at her fallen shrines, was his chief desire.

'O, who will give me wings
That I may fly away,
And there, at rest from all my wanderings,
The ruins of my heart among thy ruins lay?'

Thus he apostrophizes Zion in one of his most fervid and popular elegies (since included in the liturgy for the Fast on the Ninth of Ab); and now that yearning was to be satisfied. Travelling through Spain, where his journey was a triumph—so enthusiastically was he hailed by his many admirers—he took ship for Egypt. He was an ailing man, and a tempestuous voyage caused him extreme discomfort; but it also fired his muse. The thought of the desired haven, and the utterances of that thought in verse, stilled for him the tumult of the waves:

'The sea rages, but my spirit is glad;
It draws nigh to the Temple of its God.'

The hospitality of his many friends kept him in Egypt longer than he wished; but at length he seems to have reached Palestine. He certainly got as far as Tyre and Damascus, and he may perhaps have seen Jerusalem, though only for a short time. It was at Damascus that he penned the elegy already cited. The closing passages of his life are unknown; but legend has filled up the gap. It is said that, while he was reciting his poem on Zion in the Holy City, an Arab horseman rode over him and trampled him to death.

2. Philosophy.—Halevi's great philosophic work is, as has been stated, the *Kuzari*. Written about 1140, it was rendered into Hebrew some thirty years afterwards by that famous translator, Judah ibn Tibbon. A little later (about 1200) a second Hebrew version was undertaken by Isaac Cardinal. Of this only the preface and a short fragment have been preserved. History tells of one Bulan, king of the Khazars, a tribe in the Crimea, who became a convert to Judaism in the 8th century. Halevi, who may have met some of the descendants of the Khazars at Toledo, utilized this incident to give point and vividness to his

book. His aim, as is indicated by its sub-title, 'The Book of Argument and Demonstration in aid of the Despised Faith,' was designed to vindicate Judaism against the assaults of its various detractors—the Karaites within the gates, and the Muslim and the Christian without. His disciples had asked him what shape such a vindication ought to take, and his great book was his reply. The story of Bulan provides the work with its starting-point and framework. The king, dissatisfied with paganism, invites a philosopher to expound his system. The God of philosophy, however, proves to be a distant Being, indifferent and inaccessible to men. The king turns, therefore, first to a Christian, and then to a Muhammadan, but with equally unsatisfactory results. The truth of the religion in each case is devoid of convincing historical guarantees. On the other hand, both have appealed to Judaism as the fount and the witness of their creed. The king accordingly sends for a Rabbi, and the rest of the work gives the imaginary conversation which ensues. The arguments of the Rabbi, which are, of course, those of the author, convince the king, who thereupon declares his adhesion to the Jewish faith.

In order to understand the genesis and significance of the *Kuzari* it is necessary to have a clear idea of the state of religious thought which prevailed among the Jews in Halevi's time. Coloured by Greek philosophy, by the teachings, more particularly, of Plato and Aristotle, Arabic theology in its turn influenced Jewish thinkers living under Muslim rule in Africa and Spain. That influence had a twofold result. It gave rise, on the one hand, to unorthodox views concerning the origin of the universe and the relation of God to the world, and it furnished, on the other hand, the impulse to a synthesis intended to reconcile Jewish theology with Greek speculation. Islām, forced to attempt a like reconciliation on its own behalf, had produced the order of philosophers known as the *mutakallimūn*, and these, in a measure, had their counterparts in certain Jewish thinkers headed by the famous Saadya (9th–10th cent.). Saadya's great work, *Emunoth Vedeoth* ('Creeds and Beliefs'), was designed to defeat the sceptic with his own weapons. A too material philosophy had been his undoing; a philosophy grounded on faith in the Unseen should be his salvation (see SEADIAH). To Saadya succeeded Bahya ben Joseph ibn Bakudah (11th cent.), who, in his *Hoboth Halebaboth* ('Duties of the Heart'), provided a philosophical antidote to the Aristotelian doctrine with which Ibn Sina (Avicenna) had familiarized his Muslim followers and their Jewish admirers. Theological turmoil in Islām was matched by a like ferment in Jewry. In the opinion of many among both communions, however, the attempt to reconcile religion with metaphysics was a failure. It fostered scepticism instead of curing it. Philosophy was the enemy, and war to the knife was the only means of averting its sinister effects. Thus orthodoxy asserted itself once more—in Islām in the person of al-Ghazālī (11th cent.; see ETHICS [Muslim]), in Jewry in the person of Halevi, whom al-Ghazālī influenced, and whose deep distrust of 'Greek wisdom,' 'whose blossom is beautiful, but bears no fruit,' tinctures even his poetry. Both writers aimed at displacing philosophy by unconditional belief, and the Jewish Rabbi was probably moved to write his *Kuzari* by the polemical works of the Muslim theologian. But, while a common purpose animated them, the Rabbi set himself the additional aim of defending his religion from Islām itself, with its attacks upon Jewish Biblical exegesis.

In spite of this, Halevi's repudiation of philosophy is far from thoroughgoing; it may even be

criticized as inconsistent. In regard to the fundamental principles of theology, such as the Divine Existence and the close relations of a personal God with the universe, he will have nothing to do with metaphysical speculation. The veracity of those principles is established for him by one kind of testimony, and one only—that furnished by the historic facts of the Bible. Holy Scripture is the impregnable rock upon which rests the truth of Judaism itself. But, when dealing with less vital matters—the genesis of the world, for example, the Divine attributes, human free will, and the like—he has no scruple in resorting to philosophy, and even to metaphysics. Nor can it be said that he succeeded in his main polemical purpose. If Saadya failed to discourage philosophical scepticism by encouraging philosophical belief, Halevi equally failed to discourage it by banning it altogether. The next great name after his in the chronology of Jewish thought is Maimonides (end of 12th cent.), with his *Morh Nebuhim* ('Guide of the Perplexed'), the most systematic attempt at interpreting Judaism in terms of the Aristotelian teaching which Jewry has produced. The fierce and protracted conflict of opinion to which that epoch-making treatise gave rise is a matter of history (see MAIMONIDES). The truth is that both the philosophical and the anti-philosophical positions are at once useful and dangerous. Theology has its psychic roots, and the evidences to which it makes its appeal necessarily vary with the individual. If the mystic finds his proofs of God in his own spiritual experience—'makes them,' as T. H. Green expresses it—the ordinary believer either looks to Nature and history for corroboration of his creed or declines to corroborate it at all. On the other hand, there are persons desirous of believing, but so constituted as to require conviction as a condition precedent to religious faith. If philosophy may unsettle and alienate the ordinary believer, it may satisfy and win the more exacting mind. Halevi practically recognized this truth when, though setting out with the avowed purpose of excluding rationalism from the sphere of his inquiry, he resorted to it in order to justify certain elements of his Judaism. Apart from its initial postulates, the *Kuzari* is throughout a reasoned and, therefore, a philosophical exposition of the Jewish religion. And it is as such an exposition that it retains its interest for us. It gives us a picture of the religion which appealed to the average Jew of the Middle Ages, of the religion, moreover, which still commands the allegiance of his successor to-day. That the book attained instant popularity, that it influenced so considerable a Jewish philosopher as ibn Daud, who wrote his *Emunah Ramah* in 1168, and that it has passed through a dozen editions, is not surprising. More remarkable is it that it should have been translated into many European languages, including English.

The following is a summary of the salient teachings of the work:

The aim of religion is the good life. Revealed religion is, therefore, superior to the natural religion of the philosopher which defines the good life in diverse ways. The belief in God, in His eternity, in His providential guidance of Israel's history, and in His revelation constitutes the essence of the Jewish creed. The truth of that creed is attested by historical facts, e.g. the Sinaitic revelation, which took place in the presence of a whole nation. Nothing in Scripture can ever be irreconcilable with reason. Thus the Biblical appellations of God, such as 'merciful,' 'jealous,' 'long-suffering,' and the like, do not imply any mutability of the Divine nature, but express the divergent points of view from which it is approached by the human mind. In like manner the Divine attributes merely correspond to the various relations of God to His creatures.

Like the dogma of the Divine existence, the idea of the election and mission of Israel rests upon an historical basis. The Bible tells of a succession of prophetic or spiritually-gifted natures, beginning with Adam, continued in the Patriarchs, and completed by the Israelitish people, who were chosen as

the depositaries of the Divine truth. That truth reached its full expression in the Bible, with its three great classes of precepts—ethico-social, ritual, and spiritual; and its communication to Israel elevated that people into a kingdom of priests, charged with the performance of the prophetic task. The adaptation of the Biblical precepts to the needs of successive ages is the characteristic function of the Talmud, which defines the boundaries of permitted and forbidden things in accordance with tradition. The theory of an Oral Law supplementing and elucidating the Written Law (Scripture) is essential to a due interpretation and fulfilment of the Biblical ordinances. Hence, unlike Karaite Judaism, which rejects tradition, Rabbinism gives satisfaction of spirit to its adherents by the assurance that, in obeying the laws of their religion, they are performing the clearly ascertained will of God.

Moreover, Judaism, the religion of joy, imposes limits on asceticism: 'Thy self-humiliation on a fast-day is not more acceptable to God than is thy devout rejoicing on a Festival.' The powers of soul and body are to be equally developed. The good man, as Judaism conceives of him, will not shun the world and its activities; nor will he long for death in order the more speedily to enter into eternal life. Man, moreover, is free (this in opposition to the Epicurean and fatalistic doctrine of Necessity). Nor does the idea of Divine providence conflict with this truth. God knows the consequences of human actions, but this is not equivalent to foreordaining them. Between the Divine foreknowledge and human action lie intermediate causes. The human will is one of them; it can direct the law of cause and effect as it desires. Nevertheless, the Divine omnipotence is not limited, inasmuch as these intermediate causes depend upon God, and are to be referred back to Him.

As to the prophetic gift, it is a direct emanation from the Godhead; it is the *summum bonum*. There is no prophecy outside the Holy Land (probably a polemical reference to Muhammadanism). The Prophet must be a man of exemplary life. In virtue of its obedience to the Law and of its ancestry, Israel has a special aptitude for prophecy, which it may foster in exile by obedience to the ceremonial precepts. That exile is no proof of its rejection by God. Israel is the martyr-people; it is 'the heart of the nations,' feeling every pain and disorder of the great body of mankind. But the dry bones will live. The Jew has been dispersed throughout the world in order to disseminate the Divine truth. Christianity and Islām are forerunners, preparing the way of the Messiah, whose sway will make them one.

3. Poetical works.—Halevi the poet is at least as great as Halevi the religious thinker. He has been called 'the most inspired writer of Hebrew after the Psalmists.' The allusion is to his poems, which, unlike his great prose work, were written mainly in the sacred language, but in the Arab style, with its fettering artifices and conventions. Though essentially a religious poet, Halevi, in common with his predecessors of the Judæo-Spanish school, did not disdain to sing of secular themes. Indeed, the new Hebrew poetry which that school created was secular before it was religious. Halevi—so facile is his gift—turns to poetry when others would use prose. If he has to write a letter or send a greeting to a friend or a great man—the ibn Ezras, Samuel Hannagid, Joseph ibn Migash, and many others—he sends it in verse. He invokes his muse on the smallest provocation. He has left epithalamia, elegies, satires, epigrams, riddles, and love-songs. He sings of youth and of old age, of feasting, and of the splendour of land, sky, and sea. He rallies a lad who has begun to grow a beard; he chronicles the discovery of his own first grey hair:

'I found my first white hair to-day,
And plucked it out, scarce knowing what I'd done.
"An easy task," it cried, "to vanquish one;
But how when all the host are grey?"'

With the title, 'To a Friend who finds my Poverty as grievous as I do,' he indites the following lines:

"I'm done with thee," exclaimed my friend,
The day my money fled.
"So wroth! Say, What's my sin?" I cried.
"Thy poverty," he said.'

But the didactic note prevails. He warns the worldling that mundane things, 'a protecting shadow' to-day, 'may be a snare to-morrow'; 'the eagle's pinion may wing the shaft that slays him.' He has some lines entitled 'The Counsel of the Sage,' which contain the following advice: 'Keep a joyous face for thy friend; be not always sad. Win the hearts of the learned, and capture the wisdom of the wise. So will thy desire be fulfilled, and thy weal multiply.' About to take

medicine, he writes some prayerful verses, in which he affirms his trust not in the potion, but in the healing power of God. Here is a characteristic stanza or two on 'Love to God':

'I haste unto the true life's fount,
Spurning the life that's vain and false,
My one desire to look upon my King;
No other being has my reverence.
Could I but see Him in a dream,
Then would I sleep for aye;
Could I but see His face within my heart
I'd never wish to look abroad.'

Another poem is entitled 'The Shame of the Jew is his Pride.' Its central thought is thus expressed: 'Men revile me—they know not that shame, borne for Thy sake, is truest glory.'

Halevi's chief strength, however, lay in his gift of hymn-writing. He is the poet of the Synagogue *par excellence*. No liturgical writer has found so wide acceptance among the Jews, or lifted their devotional poetry to so high a level. He has left hymns—some 300 in number—for the whole of the Jewish year, and the Synagogue has made abundant use of them. They are a common bond uniting the sects of Jewry—the Karaites among them—with their many differences of thought and ritual. Simple, as a rule, in ideas and expression, they tower above the effusions of the more ancient liturgical poet Kaliri, with his love for dark sayings and difficult phraseology. Halevi's religious poetry moves, moreover, on a far loftier plane. Its leading feature is a keen consciousness of God, the desire for communion with Him, an absolute trust in His rectitude. The joyousness issuing from this temper is modified, however, by the sad thought of Israel's low estate. The enmity of Edom and Ishmael (Christendom and Islām) is a constantly recurrent theme, as though the iron of persecution had entered into the writer's own soul. Occasionally he invokes the Divine judgment upon the oppressor. This sombre tone persists even in some of the poems written for Feast-days. But their final note is one of hope and faith. Purified by tribulation, Israel will be redeemed at last, and the old national life restored. Sometimes the poem is the voice of the soul of collective Israel, 'the King's son,' sometimes of the individual soul. Now the poet mourns his own sins, especially the sins of his youth; now he calls to youth to remember that life is fleeting, and that old age, with its disillusion and regrets, and the day of death, 'when there is neither love nor hate,' will come at last. 'Haste,' he exclaims, 'after thy King, with the souls that flow unto the goodness of the Lord.'

Apart, perhaps, from a quicker feeling for the beauty, as distinct from the solemnity, of the physical world, Halevi's poetry makes no appreciable addition to the content of Jewish thought. The Bible and the Rabbinical literature not only colour, but fashion, his theology and his outlook on life. His chief characteristics are intense spiritual feeling and lofty imagery. Traces of theosophy meet us here and there.

The angels are very real beings to the poet; they hold up the throne of God, but God upholds them. He is the Omnipresent, who fills, but transcends, Nature. 'Thou containest the universe; but the universe does not contain Thee.' But God is immanent as well as transcendent: 'He came down at Sinai, and He dwelt in the bush.' 'Is His throne, in very deed, among the Cherubim? Lo, the highest heavens contain Him not. He lives in men's hearts, even as He dwells among the angels. Yea, His assembled worshippers are very near to Him. Invisible to the eye of flesh, He is manifest to the soul.' His grace, too, is infinite; it triumphs over His strict justice, and ensures forgiveness for truly repentant sinners who 'essay to grasp His robe.' 'Their tears are as drink-offerings in His sight.' The one supreme joy is communion with God, His grace the one supreme boon. 'Away from Thee, my life is death; near to Thee, my death is life. . . . Let me seek Thy grace for awhile, and then let me die . . . for what else hath life in its gift? And if Thou art not my portion, what is my portion?'

In like manner, the poet cries in one of his finest passages:

'My heart is one with my Beloved; my soul lives again;
A poor prisoner, yet am I glorious.
My heart holds my Beloved; what need to seek Him, then,
Either in the heavens or in the deep?
My soul enthrones Him; why, then, brother or friend?
Or what can King or Prince do for me?'

Still more daring is his flight. Influenced by the Midrashic interpretation of Canticles, he thus apostrophizes God:

'Beloved, hast Thou forgotten how Thou didst lie between my breasts?
Why, then, hast Thou sold me into lasting slavery?
Once Thou hadst my love, and Thou gav'st Thy love to me;
How, then, couldst Thou give my honour to another?
Have I Redeemer but Thee? Or hast Thou a prisoner of hope but me?
Give me, I pray, Thy strength, for to Thee I give my love.'

He retains, too, some of the Talmudic superstitions. The note of the *shophar* (cornet), for example, on the New Year Festival will confound Satan, and give unimpeded play to the Divine mercy and men's contrition. His spirit chafes under his people's sufferings. Besides active persecution, they have to endure attempts to wean them from religion. 'They would turn me aside after false prophets'—so Israel is made to complain; 'they revile me when I seek to serve my God.' But 'Lo, Thy fame is in my ears; the Red Sea and Sinai witness to Thy greatness. How, then, shall I think of any god but Thee?' In these lines we may discern a poetic echo of the great thesis of the *Kuzari*—the testimony of history to the eternal truth of Judaism.

Halevi's eminence as a religious poet is attested by the frequency with which he has been translated. Heine, moreover, generally frugal in his praise, gives the ancient singer of his race unstinted homage: he is

'A very wondrous mighty
Fiery pillar of all song,
That preceded Israel's mournful
Caravan as it was marching
Through the desert of sad exile.

When this spirit was created
By its Maker self-contented,
He embraced the lovely spirit,
And that kiss's beauteous echo
Thrills through all the poet's numbers,
Which are hallowed by this grace.'

Of the many attempts to summarize Halevi's significance in the sphere of religious literature, Graetz's appreciation is perhaps the happiest: 'He was the transfigured image of self-conscious Israel seeking to express himself in thought and in Art.'

LITERATURE.—I. Abrahams, *Short History of Jewish Literature*, London, 1906; H. Brody, *Diwan des Abu-l-Hassan Jehuda ha-Levi*, Berlin, 1899-1911; D. Cassel, *Das Buch Kusari*, Leipzig, 1869; Nina Davis, *Songs of Exile*, London, 1900 and 1905; H. Edelman, *Ginze Oxford*, London, 1850; A. Geiger, *Diwan des Castiliens Abu' l-Hassan Juda ha-Levi*, Breslau, 1851, also *Nachgelassene Schriften*, do. 1876, iii.; J. Hamburger, art. 'Jehuda Halevi,' in his *Realencyclopädie des Judentums*, Leipzig, 1896; H. Hirschfeld, *Judah Hallevis Kitab Al Khazari*, London, 1905; J. Jacobs, *Jewish Ideals*, do. 1896; *J.E.*, art. 'Judah ha-Levi'; D. Kaufmann, *Gesch. der Attributenlehre*, Gotha, 1877, *Gesammelte Schriften*, ii., Frankfurt, 1910, and in *JQR* i. 441 ff.; *Kerem Hemed*, iv. [1839] 144, vii. [1843] 265 ff.; Alice Lucas, *The Jewish Year*, London, 1898; K. Magnus, *Jewish Portraits*, do. 1897; S. D. Luzzatto, *Betulat bat Jehudah*, Prague, 1840, *Diwan Jehuda Halevi*, Lyck, 1864; M. Sachs, *Relig. Poesie der Juden in Spanien*, Berlin, 1845; L. Zunz, *Ritus des synagog. Gottesdienstes*, do. 1859.

MORRIS JOSEPH.

HALLAJ.—In the history of Muhammadan pantheism there is no event more celebrated and remarkable in its consequences than the execution at Baghdād, on the 24th of Dhu 'l-Qa'da, A.H. 309 (26th March, A.D. 922), of Abu 'l-Mughith Husain ibn Mansūr al-Hallāj—often incorrectly called Mansūr Hallāj—on the charge of pretending to be an incarnation of the Deity. His claim was expressed in the most forcible and uncompromising terms that can be imagined: *Anā 'l-haqq*, 'I am the Real.' The significance of this formula will be explained after some account has been given of its author's life and character. Hitherto it has not

been possible even to sketch the outlines of his career with any certainty, but the researches of Louis Massignon, which will shortly be published (see below), have thrown fresh light on the subject.¹

1. Life.—Hallāj, whose grandfather is said to have been a Zoroastrian, was born c. A.D. 858 at Baidā, near Persepolis, in southern Persia, and passed his boyhood at Wāsīt, one of the chief cities of 'Irāq. At the age of sixteen he went to reside at Tustar (Shushtar) in Khūzistān, and entered upon the ascetic and mystical life as a pupil of the eminent Ṣūfī, Sahl ibn 'Abdallāh al-Tustarī; he then migrated to Baṣra, where he became a disciple of 'Amr ibn 'Uthmān al-Makkī, and married the daughter of another Ṣūfī, Abū Ya'qūb al-Aqṭa'. On leaving Baṣra, he proceeded (in 877) to Baghdād and completed his training in Ṣūfiism under Junayd, the greatest mystic of the time. Little is known concerning his movements and the events of his life during the next twenty years. About 895 he made the pilgrimage to Mecca, where he remained for a year in seclusion. The fact that soon afterwards his Ṣūfī teachers broke off relations with him was probably due to their dislike of the extreme pantheism to which he had by this time committed himself, although Hujwiri states (*Kashf al-Mahjūb*, 150) that they did not repudiate him because of any attack on religion and doctrine, but solely on account of a breach of discipline. After spending two years in retirement at Tustar, he travelled for a long while (c. 899-902) in Khurāsān and Fārs, preaching and composing his first works on mysticism; at this date he received the title of *Hallāj* ('wool-carder') by which he is generally known.² Having made the pilgrimage to Mecca a second time, he settled for a year at Baghdād, whence he travelled by sea to India and roamed to the farthest boundaries of Turkistān, preaching and writing as before. He then returned as a pilgrim to Mecca, where he stayed two years, and about 908 arrived at Baghdād, where he delivered a public discourse which raised an outcry against him and led to his being arrested; but he managed to escape from prison, and concealed himself at Sūs in Khūzistān (910). Three years later he was again arrested and brought to trial at Baghdād before 'Isā, vizier of the Khalīf Muqtadir. On this occasion he was charged with being a Carmatian (*q.v.*); and, although no evidence was found to justify the allegation, he was detained in custody at Baghdād. His captivity, which lasted for eight years, was not of a rigorous nature: he was moved from one prison to another, and was allowed to receive visitors and continue his preaching—a privilege which he used to such purpose that he gained many influential sympathizers.

Finally, in 922, a second trial took place. It was conducted by the viziers Ibn 'Isā and Hāmid, and dealt with three principal charges against Hallāj: (a) his secret correspondence with the Carmatians; (b) the extravagant notions of his disciples, who believed him to be Divine; (c) his own belief on the question of essential union with the Godhead ('*ain al-jam'*). Hāmid wished to confine the inquiry to these points, but the *qāḍīs* insisted on his adding a fourth, viz. the doctrine (which was, indeed, held by Hallāj) that the pilgrimage to Mecca is not one of those religious obligations that are absolutely binding, but belongs to the class that admits of abrogation. On this skilfully chosen combination of theological,

legal, and political grounds, the prisoner was condemned to death. During his execution, which was carried out in a barbarous manner, Hallāj displayed the utmost fortitude. His mutilated body was burned and the ashes thrown into the Tigris, while his head was sent to Khurāsān to be shown to his followers in that country. Many, however, both there and elsewhere, would not believe that he was dead, and continued to expect his return. They maintained, quoting the statement in the Qur'ān (iv. 156) concerning Christ, that Hallāj had been transported alive to heaven, and that the actual victim was one of his enemies whom God had changed into his likeness, or, according to other versions, a horse or a mule.

Similar legends are told of 'Alī (*al-Farq bain al-Firaq*, 223) and several Shi'ite heresiarchs. As Massignon has pointed out, they express the popular feeling that a God-man cannot possibly suffer the indignity of being murdered, crucified, or dismembered.

2. Teaching.—Although the later Muhammadan tradition attributes the condemnation of Hallāj to his outrageous impiety, it is certain that political motives played a large part in the affair. He is described, in the oldest historical books that mention him, as an agent attached to the Shi'ite or Carmatian propaganda,¹ a reckless and unprincipled agitator who dabbled in alchemy and magic, and imposed on the vulgar by performing miracles which were only the tricks of a clever conjuror. Now, there seems to be no evidence that Hallāj was a Carmatian, but it was easy to pretend that he was. The doctrine of incarnation (*ḥulūl*) was held in common by some heretical Ṣūfī sects and by various branches of the extreme Shi'ites, and Hallāj might plausibly be represented as a Carmatian, since he is said to have called himself 'the Radiant Light,' and to have been addressed by his disciples in terms like these: 'We bear witness that thou art He who puts on a different form in every age, and in the present age hath assumed the form of Ḥusain ibn Manṣūr; and we implore thy blessing and hope for thy mercy, O knower of secrets!' (*al-Farq bain al-Firaq*, 248, 12). Moreover, in the first quarter of the 10th cent. the Carmatians almost succeeded in establishing a reign of terror; and Massignon suggests, with reason, that Hāmid, who had incurred much odium by his measures for controlling the importation of corn, may have sought to regain popularity and credit by pretending that Hallāj was one of their most dangerous missionaries, and making it appear that his conviction was a political triumph. Otherwise, it is at least doubtful whether the audacious dialectic with which he pursued his theological speculations, or the pantheism which he openly professed, would have cost him his life. Islām has always been tolerant to the excesses of mystical enthusiasm, and the plea of ecstasy has seldom been urged in vain.

According to the theory of Ṣūfī philosophy, *al-ḥaqq*, 'the Real,' i.e. God regarded as pure being, is opposed to the phenomenal world, which exists only as a reflexion of pure being upon the darkness of matter or 'not-being.' Even the more orthodox mystics hold that union with God is attainable. They say that in 'passing away' (*fanā*) from his phenomenal self man necessarily becomes one with God, inasmuch as the Divine element in his nature is then free to rejoin its source. The theory, stated in this way, is not Hallājian, but Hallāj presents the same ideas in a symbolic form peculiar to himself.² While the Ṣūfīs are generally careful

¹ The present writer is indebted to M. Massignon for the greater part of the following biographical notice as well as for other important facts, and desires gratefully to acknowledge the courtesy with which they have been communicated.

² According to some authorities, the epithet refers to his power of reading men's secret thoughts, while others say that it was bestowed on him because he once carded a large quantity of cotton in a miraculously short time.

¹ The definite statement that he was one of the missionaries of 'Alī al-Riḍā, the eighth Imām of the Shi'a (Browne, *Literary History of Persia*, i. 429), seems not to be justified by the original text (*Fihrist*, 190, last line), which says that he carried on a propaganda in favour (*riḍā*) of the 'Alids.

² Apparently, however, Hallāj did not regard the deified man as being devoid of personality and indistinguishable from the

to disavow the heretical notion that the Divine substance or spirit can enter into man, this doctrine of human transubstantiation (*ḥulūl*) was nevertheless adopted by some of them; and, since it was taught by Fāris, one of the chief disciples of Ḥallāj, we may conclude that it is implied in the famous formula, *Anā 'l-ḥaqq*, 'I am the Real.'

Such, however, is not the opinion that prevailed among the mystic theologians who flourished in the 4th and 5th centuries of the Muhammadan era. The majority of these men saw in Ḥallāj a genuine theosophist, exalted by mystical rapture or intoxication to a point where he believed himself to be united with the Divine essence; and in their eyes he was not guilty of anything worse than a momentary indiscretion. Others hesitated to condemn him outright and took refuge in an attitude of neutrality. Ghazālī, who at first adopted this course, afterwards declared that *Anā 'l-ḥaqq* is an expression belonging to the highest stage of Unitarianism. Those who deemed Ḥallāj an infidel usually qualified their condemnation by saying that, although he had violated the religious law, he had not been false to the inner truth of Islām; his offence was that he divulged the mystery of the Godhead, and on this account he deserved to die.

Ḥallāj is the founder of Muhammadan pantheism in the same sense as Ash'arī (*q.v.*) is the founder of Muslim scholasticism. The pantheistic movement did not commence with him; it had long been gathering force below the surface, and his words only gave the signal for its explosion. They revealed, as in a flash, what many had more or less consciously thought but few had yet dared to speak. Here, at last, was the plain truth uttered so simply and tersely that no one could mistake or forget it, and its effect was intensified by the dramatic spectacle of torture and vengeance inflicted upon the man who had proclaimed himself to be God. The later Sūfī writers, especially the mystical poets of Persia, celebrate Ḥallāj in glowing language as a hero and martyr whose passion for the Real caused him to lay down his life in order that he might gain the perfect union that results from self-extinction.

Ḥallāj left behind him a sect designated by his name, who professed the doctrine of *ḥulūl* and are reckoned among the heretics of Sūfīism; and also a large number of mystical writings in prose and verse. The titles of forty-seven treatises by him are recorded in the *Fihrist* (p. 192), and this catalogue is not exhaustive. Only one of them has been preserved complete or nearly so—the *Kitāb al-Tawāsin*, which Massignon has recently discovered in an Arabic MS of the British Museum (Add. 9692), together with a Persian commentary by Rūzbihān Baqlī (A.D. 1209), extant in two Constantinople MSS. The forthcoming edition of these texts will furnish materials for a detailed account of the mystical theories developed by Ḥallāj, and will open the way to a better understanding of his character and his influence upon the subsequent history of pantheism in Islām. For example, it appears from a passage in the above-mentioned work that the Yezīdis—the so-called devil-worshippers—derived their peculiar veneration for Iblis from Ḥallāj and his school (Massignon, in *RHR*, June 1911). A considerable quantity of fragmentary compositions—sayings, letters, discourses, poems, etc.—some of which are undoubtedly authentic, have come down to us under his name. Two collections of poetry in Arabic and Persian are falsely attributed to him.

deity. The 'I' is not absorbed in, or confused with, 'the Real.' In this respect his doctrine is at variance with that of the Persian Sūfīs in general (see Massignon's introduction to the *Kitāb al-Tawāsin*, p. 20).

The latter, published at Bombay in 1887 and again in 1894, is a particularly gross forgery.

LITERATURE.—L. Massignon is preparing a special work, entitled *Bibliographie chronologique et critique d'al-Ḥallāj*. Only the most important notices in English and other European languages can be mentioned here: Ibn Khallikān, tr. de Slane, Paris, 1843-71, i. 423; Hujwiri, *Kashf al-Mahjūb*, tr. Nicholson, London, 1910, p. 150; F. A. G. Tholuck, *Blüthen-sammlung aus der morgenländ. Mystik*, Berlin, 1825, pp. 311-326 (the Life of Ḥallāj), tr. from 'Aṭṭār's *Tadhkirat al-Auliya'*; E. G. Browne, *A Literary History of Persia*, London, 1902-06, i. 428-437; A. von Kremer, *Gesch. der herrschenden Ideen des Islams*, Leipzig, 1868, pp. 70-78; R. P. A. Dozy, *Essai sur l'histoire de l'Islamisme*, tr. V. Chauvin, Leyden, 1879, pp. 324-335; L. Massignon, 'al-Ḥallāj,' in *RHR*, June 1911, also 'Anā 'l-Ḥaqq,' in *Der Islam*, 1912, pp. 248-257, *Kitāb al-Tawāsin* (in the press) and *La Passion d'al-Ḥallāj* (in preparation).

REYNOLD A. NICHOLSON.

HALLUCINATION.—I. Definition.—A hallucination is generally defined as a false perception. It is generically that; but it is not the only species of false perception, and a closer characterization is therefore necessary. Psychologists draw a distinction between states of consciousness in which there is contained or involved a reference to an object in the so-called external series here and now existent, and a state of consciousness which, though in content otherwise generally similar to the other, does not carry this objective reference. The first is termed a percept or a presentation; the second is termed an image or representation. These psychical experiences form two series known as the presentational and the representational series respectively. This nomenclature indicates the dominant characteristics of each type of experience, though, of course, there are representational elements in the percept, and representations are based on perceptual experiences. Normally there is no confusion between the two. A hallucination is said to occur when a member of the second series is ascribed to the first—i.e. when an image is taken by the conscious subject for a percept. The one, be it noted, is, *qua* psychical event, as real an experience as the other. The 'fallacy' lies in the function which the conscious state in this case is made to perform or in the significance which is attached to it. It is made to report falsely about external reality. In this it partakes of the character of illusion (*q.v.*), and yet it may be distinguished from that kind of experience. Whether the distinction is merely one of degree is a question on which there has been much debate among psychologists. Esquirol¹ gave currency to the following distinction. In hallucination an experience which is purely subjective, or, speaking in terms of cerebral activity, is centrally initiated, is judged to have an objective correlative or to be peripherally initiated, whereas in illusion the starting-point is found in presentation; there is peripheral initiation—it is not, strictly speaking, a 'fallacy of the senses'—but the presentational factors are wrongly apperceived or interpreted. Hallucination, in short, takes place when we perceive an object which by the accepted tests of external reality must be finally judged to be non-existent; illusion takes place when we perceive the *wrong* object. This may be taken as a working mode of differentiation, though further investigation has led to the conviction that the line of demarcation is not so bold and well-defined as it is thus made to appear. There are a number of borderland cases which present difficulty, and which are sometimes to be found in the literature of the subject under the head of 'hallucination,' and sometimes under the head of 'illusion.' It certainly seems well-established that in numerous (some would say in all) cases classed as hallucination there is a sensory or presentational factor. In these cases, however, the sense element is so vague and unspecific that it would not normally form the

¹ *Des Maladies mentales*.

basis of a percept; it is the occasion rather than the ground of the false perception.

2. Varieties.—It is said, not quite accurately, that we may have hallucination of more than one sense. What is meant is that the content of the hallucination may be of one or other or of several of the modes of consciousness normally regarded as modes of sensation. In this sense the statement is correct. Thus we may see before us the figure of an absent friend or acquaintance or some grotesque and monstrous figure; the visual factor is predominant here, and it may be said at this point that 'visual' hallucinations bulk most largely in the records of the subject, whether they relate to the experiences of persons in a normal or abnormal condition. But we may also find hallucinations in which the auditory (the subject hears voices or definite sounds), touch, temperature, olfactory, kinæsthetic, and other modes are respectively predominant. This is well marked in the experiences of persons in the hypnotic state. Tell such a person that he has taken snuff and he sneezes; tell him he is standing on ice and he feels cold at once; 'he trembles, his teeth chatter, he wraps himself in his coat.'¹ If one sense only is involved, the hallucination is said to be *simple*; if several are involved, the hallucination is said to be *complex*.

There is a well-known experience particularly marked in the case of the person in the hypnotic state, or under the influence of post-hypnotic suggestion, known as *negative* hallucination. This is the case where the subject fails to perceive an existent object. He may only fail to see a person in the room, or he may be totally unaware of his presence, according to the character and scope of the given suggestion. The epithet 'negative,' though applicable enough from the point of view of the observer or observers of the case, is misleading as applied to the hallucinatory state itself. The hallucination is as positive as any other. The whole objective situation is apprehended by the subject as other than it is; or, if we limit the reference to that part of space in which the unperceived object or person is at any moment, then that part of space is falsely perceived; the background is continuous; there is not a gap in it; e.g., the back of the chair on which is seated the person whose absence is suggested will be seen, although, of course, it is not really visible.

Dreams (q.v.) are generally regarded as the most familiar type of hallucinatory experience. We seem in dreams to be the spectators of external objects and of series of external events which are sometimes so vivid as to cause a distinct feeling of relief or disappointment when we wake and find that these events do not fit into the normal external series. So careful an observer as McDougall,² however, finds a marked distinction between the features of a dream experience and the features of a hallucinatory experience. This is a direct challenge to more careful introspection. The present writer's observations go to confirm the view that dreams are pure hallucinatory states. The chief distinction seems to be that in the dream state the hallucination is more complete than usual. The impressiveness of the object is as marked and the emotional co-efficient at least as intensive as in experiences which are unquestioningly recognized as hallucinations. It is to be remarked that among these are the hallucinations of the half-awake state or the transition state between sleeping and waking. The line between these hypnagogic hallucinations and dreams is extremely difficult to draw.

Instances of so-called normal hallucination are to be found in what are termed *waking hallucinations*.

¹ A. Moll, *Hypnotism*, Eng. tr., London, 1906, p. 108.

² 'Hallucination' in *EBR* xii. 859.

This form occurs in the experience of persons who may otherwise be regarded as in a normal waking state. There are many such cases reported by historians;¹ the anthropologist furnishes instances from his observations of primitive peoples;² current report furnishes a sufficiency of contemporary or comparatively recent cases. We are fortunate here, however, in not having to depend merely on such evidence. In 1889 the English Society for Psychical Research issued a questionnaire containing the following query: 'Have you ever, when believing yourself to be completely awake, had a vivid impression of seeing or being touched by a living being or inanimate object, or of hearing a voice; which impression, so far as you could discover, was not due to any external physical cause?' To this 17,000 replies were received, of which over 2000 stated that under the conditions indicated figures had been seen, or, less frequently, voices had been heard. Similar inquiries have been made in America by W. James, in France by L. Marillier, and in Germany by the Munich section of the *Gesellschaft für psychologische Forschung*, with a similar result. An attempt has been made by Parish, in an analysis of the evidence, to show that, while the subjects of these hallucinations no doubt believed, in all good faith, that they were fully awake at the time of the experience, they were really in the transition state between sleeping and waking. The evidence will not, however, bear this construction, though there are enough instances of a kind to make a *prima facie* case for it. The object of these inquiries has not been to establish the existence of waking hallucinations, but to obtain evidence on the vexed question of the possibility of directly intimating distant events by this means to a person who would have been unaware of these events through the ordinary and understood modes of communication. This is known as the question of *coincidental hallucinations*. The hypothesis has been advanced that there is a causal relation between such apparitions and the distant events to which they refer. The problem is one which lies beyond the scope of the present article. It is treated at length in *Phantasms of the Living* (E. Gurney, F. W. H. Myers, and F. Podmore, London, 1886). The available evidence shows a number of cases of coincidental hallucination markedly in excess of the number to be expected on the theory of probabilities; and this, so far, is favourable to the view that these occurrences are not merely fortuitous, but it is not sufficient in extent or quality to warrant a definite conclusion.

In addition to the above so-called 'waking hallucinations,' which are regarded as taking place when the subject is in his normal condition, there are hallucinations which occur either (a) in a state which at the time of the occurrence cannot be called normal, or (b) in a state which is permanently abnormal, as in the case of mental disease. As an instance of the first type may be mentioned the familiar hallucinatory experiences, already referred to, connected with those moments of our mental life when we are passing from the waking to the sleeping state, or from the sleeping to the waking state. At these moments there is a sudden irruption of an apparently irrelevant image or procession of images which have a vividness and impressiveness much superior to those of the image in the normal waking experience, and which are readily mistaken for percepts. Some of the experiences referred to as waking hallucinations, it will be found, really belong to this type. In extreme general fatigue or in fatigue of a particular sense organ, hallucinations readily occur. The exhausted traveller often passes into the hallucinatory state; prolonged

¹ Cf. Parish, *Hallucinations and Illusions*, p. 77 ff.

² Cf. Lang, *Making of Religion*, p. 113 ff.

fasting is a preparation for the state of hallucination. After protracted visual strain, 'visual' hallucinations often occur.

Intoxicants influence hallucination. The most familiar example is the hallucination accompanying alcoholic poisoning in the state known as *delirium tremens*. Intoxication by chloroform, nitrous oxide, hashish, opium, atropin, etc., are further instances. Hallucinations thus conditioned are mostly of an unpleasant and even terrifying character, though in certain cases, e.g. hashish intoxication, there is a pleasurable phase.

In other cases, conditions of a psychical character are predominant, as, e.g., in hypnotic trance and ecstasy. The results obtained by 'crystal-gazing' (*q.v.*) may also be included here. The general preliminary condition of these experiences is an intense concentration of the attention upon one point. Indeed, we may note the effect of concentration of attention upon hallucination before it reaches the stage indicated in any of the above-named experiences. A person eagerly listening for a knock or a footstep may have the hallucination of the sound he is awaiting. A 'ghost' may be seen by one who is aware he is in a haunted room, and who is consequently in a state of strained expectation. In the census of the Society for Psychological Research there are thirteen cases of hallucination which took the form of the appearance of a person whose arrival was looked for. *Collective* hallucinations, i.e. hallucinations of a particular kind experienced by more than one person at the same time and place, are, no doubt, explained by this factor. The hallucination first experienced by one member of the group may spread to the others by suggestion operating through the special direction and concentration of attention induced by the reported abnormal occurrence.

In *hypnosis* the process is carried further. The subject is in a highly suggestible state, and hallucination is easily produced either while he is actually in the hypnotic trance or subsequently, when the waking state supervenes, under the influence of suggestion made during the trance, i.e. of 'post-hypnotic' suggestion. The records of hypnotism (*q.v.*) teem with instances of both types.

In the extreme forms of *ecstasy* (*q.v.*) the distinction between the self and the not-self disappears, and with it the articulate content of the not-self, which on the psychical side is represented by percepts and images. There is one total, all-embracing, emotional state. There is, obviously, no room here for hallucination. But in the ecstatic experience, which may find its consummation in such a condition, there are moments in which hallucination, in the strict sense of the term, may be noted. The best-known cases of ecstasy are those of religious ecstasy, where the object of contemplation and desire is a religious one, though this state is not exclusively connected with objects of this type. Examples of hallucinatory religious ecstasy are to be found in the sacred books of many religions, in the records of lives of saints and mystics, and in the accounts of primitive peoples.

Gazing steadily at a shining surface—a metal mirror, oiled finger-nails, a blot of ink, a crystal—induces hallucination. The 'scryer,' or seer, perceives pictures of distant objects and events. This has been known to mankind in various parts of the world for many centuries. The antiquity of the practice as a method of divination is indicated by the fact that Æschylus attributes its discovery to Prometheus. Analogous to 'crystal vision' are the practices of inducing auditory hallucinations by holding a shell to the ear or by striking gently the rim of a bell. This is also used as a method of divination. The voices heard are oracular.

Hallucinations accompany *somatic disorder* or bodily disease. The delirium of fever is a familiar instance, and hallucination is associated with the state of collapse preceding death. The hallucinations accompanying acute alcoholic poisoning, already referred to, might also be brought into this category. An interesting type of this class is the 'visceral' hallucination noted by Head.¹ This observer states that patients suffering from visceral disease are liable to hallucinations of a peculiar kind, either visual, auditory, or olfactory. The visual hallucination, which is more characteristic, takes the form of a vague, shrouded, white, black, or grey human figure often incomplete. The auditory hallucinations are of sounds, such as tapping, scratching, and rumbling.

Coming between this type and the type connected with mental disease are the hallucinations of the *nervous diseases* such as hysteria (*q.v.*) and epilepsy. They are markedly present in the state known as 'the great hysteria,' at least in the third and fourth of the four phases indicated by Charcot.² In the aura preceding the epileptic attack and in the post-epileptic condition, hallucinations are frequent. They are very often of a distressing character.

In many forms of *mental disease* or insanity (*q.v.*), hallucination is a notable feature, more particularly in those cases where the mind falls into a state of mistiness or dreaminess; when there is a 'beclouding of the intellect.' Hallucination, according to Mendel,³ is often associated with amentia, but seldom with acute dementia. Paranoia, it is well known, is strongly hallucinatory. Persecuting and insulting voices and figures are seen by the victim of this painful malady. The hallucinations of insanity may be divided into those which are *sporadic* or *independent*, and those which are relatively *permanent*. The first, as the term indicates, are not in any known relation to the general morbid condition; the second are obviously related to, and are symptomatic of, this morbid state. Of the two the latter are regarded by psychiatrists as less serious, since they may be attacked through the disease, and may diminish or disappear with the amelioration of the general state of the patient.

3. Causes.—The central question for the theory of hallucination is this: What are the special subjective conditions under which a state of consciousness arises which bears the character of a sense-perception although the normal conditions are absent? The answers to this question take the shape of a general psycho-physiological formula. All such answers are conditioned by assumptions regarding the identity or non-identity of the ideational and sensory centres in the brain; and the theory of hallucination will not be in a wholly satisfactory state until the strife of hypotheses on this point is ended.

A prominent and obvious type of theory is that which is termed *centrifugal*. In the principal form of this view, which has been supported by Taine, Tamburini, Ferrier, Hoffmann, Griesinger, Krafft-Ebing, and many others, the hallucinatory state begins in the ideational centres. In an unusual state of excitability of an ideational centre the excitement overflows into a sensory centre. The excitement of the sensory centre is eccentrically projected, and a hallucination results. On this view the ideational and sensory centres are regarded as distinct and separate. Apart from this, which is called in question, there are various objections to the view as an explanatory hypothesis. It is pointed out that it overlooks the fact that an image,

¹ *Brain*, xxiv. (1901) 350 ff.

² *Le Progrès médical*, 1878, no. 3, p. 38.

³ Art. in *Berl. klin. Wochenschr.* xxvi. (1889) and xxvii. (1890).

no matter how intense, remains distinct in quality from the weakest sensation. Again, the relative infrequency of voluntary hallucinations would be difficult to account for on this hypothesis.

Against this we have the view that hallucination is a *phenomenon of dissociation*. This view, which assumes the identity of ideational and sensory centres, assigns the difference between ideation and sense-perception to a difference of degree of excitement of the same cells. A centre not excited by external stimulation may act as though it were, if it is brought otherwise to a high degree of excitement. Under certain conditions, such, *e.g.*, as fatigue, the action of a drug, or of disease, this may be brought about by the isolation or 'splitting off' of particular centres through the obstruction of the association paths between them and other centres. There is an inflow of energy but no outflow; there is, therefore, an accumulation in the centre which cannot in the normal way be drained off to other centres; a high state of tension is produced, and, finally, there is an explosion such as would be produced by a stimulation coming from the periphery. The chief authorities for this view—which, though not without its difficulties, is, on the whole, the best suggestion forthcoming—are W. James, Kandinsky, Parish, and Münsterberg.

4. Influence.—The influence of the hallucinatory experience upon the life and beliefs of man in the early forms of civilization is amply attested. The distinction on which the term 'hallucination' is based implies an articulated concept of reality which is beyond the reach of the savage. Lang¹ quotes evidence for the awareness among the Australian tribes of the distinction between kinds of this experience, namely between dreams and 'waking' hallucinations, but that is another matter. The world of the savage will, therefore, contain objects, the source often of fear, which would be judged by a person of a more developed type of mind to be 'unreal,' or at least not objects in the normal or accepted sense. Tylor and others, with some show of probability, assign to the experience in dreams and waking hallucinations the prevalent belief in the savage mind of the actuality of spirits. Their world is peopled by such objects, for which, from their standpoint, they have as good and as direct evidence as for the objects of sense. In the dream state it is assumed that the spectacle of strange or remote objects and events thus furnished can occur only through the detachment of the soul from the body; the soul thus separated and projected during sleep is the witness of these things. An Australian tribe mentioned by Howitt, quoted by Lang,² holds that it is injudicious to fall asleep while out hunting, since the *murup* [wraith] of the sleeping man may be detached by the magic of his enemies. Waking hallucinations will reinforce this belief, since in these instances the wraith of other persons whose bodies are at a distance will appear to the subject.

In those cases where there is the figure of an individual known to be dead or afterwards ascertained to have been dead at the time of the appearance, there will be ground for the belief in the continued existence of the spirit after death. This basal idea of the separability of the soul makes easy such conceptions as that of demoniacal possession. This state is brought to an end by the capture of the strayed soul and its return to its proper dwelling by the medicine-man.

The growth of a special class of medicine-men, wizards, or priests in savage communities is clearly connected with hallucinatory experiences. Among some tribes the individual who is known as the subject of what are now termed 'waking hallucinations' is set apart as a wizard. This separation

¹ *Op. cit.* p. 49.

² *Ib.* p. 118.

and distinction are, of course, further confirmed when the selected individual is able, as Stoll fully shows he is, by the influence of his status, his personality, and his ritual, to induce by suggestion hallucinations in other individuals, or groups of individuals, *i.e.* when they witness portents and strange events through his influence.

Myth or legend, again, is associated with hallucination. It is not possible to establish as a generalization the suggestion that these legends originate in hallucinations; the same legend is found among very diverse and widely scattered peoples. It is, however, a hypothesis which is worth consideration when dealing with the origin of legends. What is clear is that myth is supported and nourished by hallucination.

LITERATURE.—E. Parish, *Hallucinations and Illusions*, Eng. ed., London, 1897; W. James, *The Principles of Psychology*, do. 1907, ii. 114 ff.; F. W. H. Myers, *Human Personality*, do. 1903; H. Taine, *De l'Intelligence*³, Paris, 1879, i.; J. J. Hoppe, *Erklärung der Sinnestäuschungen bei Gesunden und bei Kranken*⁴, Würzburg, 1888; V. Kandinsky, *Krit. und klin. Betrachtungen im Gebiete der Sinnestäuschungen*, Berlin, 1885; J. E. D. Esquirol, *Des Maladies mentales*, Paris, 1838, Eng. tr., *Mental Pathology*, Philad. 1845; A. Brierre de Boismont, *Hallucinations*, Eng. tr., London, 1859. For the anthropological aspect, see A. Lang, *The Making of Religion*, do. 1898; O. Stoll, *Suggestion und Hypnotismus in der Völkerpsychologie*⁵, Leipzig, 1904; P. Beck, *Die Ekstase: ein Beitrag zur Psychologie und Völkerkunde*, Sachsa, 1906; E. B. Tylor, *Primitive Culture*, London, 1871 (⁴1903); A. Bastian, *Ueber psychische Beobachtungen bei Naturvölkern*, Leipzig, 1890; W. Wundt, *Völkerpsychologie*⁶, vol. iv. pt. i., do. 1910.

ALEXANDER MAIR.

HAMADRYADS (Teutonic).¹—The various stages of religious development among the Teutonic peoples are exhibited in their rites and myths connected with trees. The ancient belief in a power residing in trees—a power that might be transferred to other creatures and to the earth itself—may still be traced in a wide variety of popular customs. Thus, in early summer—on May-day or at Pentecost—the May-bough is carried from the forest to the village by the young people, in the hope that it will endow them with fresh vital energy; at the end of harvest, the harvest-tree is erected upon the last waggon-load of corn, in order that the spirit of vegetation may pass into next year's crop; in spring, cattle, fields, young girls, and newly-wedded couples—the latter also on their marriage-day—are stroked with fresh twigs of sprouting trees, or with bushes of the so-called 'rood of life.' From the belief in the power dwelling in trees sprang also the worship of the *irmensúl*—a huge tree-trunk standing erect under the open sky—among the Saxons (Mannhardt, *Baumkultus*, p. 303 ff.), the worship of the evergreen trees that stood before the temple of the gods in Old Upsala (Adam of Bremen, *Hist. eccl. Hammab.* iv. 26, schol. 134), the Norse myth of Yggdrasil, the world-ash, and the Eddic myth which tells that *Ask* and *Embla*, the ash and the ivy (*Voluspá*, 17-18), were the first men.

Then at an early period imagination proceeded to associate trees, and to people forests with demonic beings. These assume for the most part a female, but sometimes a male, form. Popular fancy ran riot among them, enwrapping them in myths of the most varied kinds, and even to-day they are met with in their primitive freshness among all the Teutonic peoples. In O.H.G. they appear as *skrato*, in A.S. as *vūdualf*, in M.H.G. as *holzmuoja*, *holzrāna*, or *waldminne*. In the popular belief of the present day they are known as wood- or moss-maidens, forest-nymphs, wild-folk, *Fanggen* (Tyrol), blessed maidens, *Norger* (Graubünden), *Ellepige*, *Skogsnuſva* (Dan. 'fairy-maidens,' 'wood-nymphs'), *Skogsrå*, *Skogsfru* (Swed. 'forest-woman'), and by many other names; when they assume a male form, they are known

¹ For the beliefs of other peoples on the same subject, see TREES AND PLANTS.

as 'wild men,' 'wood-mannikins,' or *Skogsmän* (Swed. 'forest-men'). They live in the woods—either underground or in trees, especially hollow ones—and are often encountered there by human beings. In outward appearance they usually resemble old women; their bodies are hairy, and covered with moss; they have, in common with field-spirits, the characteristic feature of long, pendulous breasts. Their faces are old and wrinkled; and sometimes their backs are concave, like the hollowed-out trunk of a tree. Here and there, however, and especially in the Tyrol, they are found as graceful figures with beautiful flowing hair. As males, their form approximates rather to that of the giants; they are abnormally large and strong; they have bristly hair, and are armed with tree-trunks. Occasionally they are endowed with the protean nature, and may avail themselves thereof to appear as animals.

Their attitude towards human beings is sometimes friendly, sometimes hostile. Their appearance presages a fruitful year. They put the hunter on the track of his quarry, and accordingly he seeks to win their favour. But they often fascinate the traveller with their trilling songs and their laughter, wiling him from the right way, and leading him astray. They occasionally unite in marriage with human beings, or engage to serve them, and in such cases bring good luck to the house so long as they stay in it. As denizens of the forest they possess a knowledge of medicinal plants, and make use of them to give health and strength to their favourites; thus, in the Balder saga, the food from which Balder drew his great strength was guarded by *virgines silvestres* (Saxo Gram. iii. 77). They make special appeal to human beings for succour when they are pursued by the Wild Hunter. At such times violent whirlwinds arise, shaking the trees and pressing the branches far down. If the hamadryad is not rescued, but falls into the hands of the Wild Hunter, he lays her crosswise upon his steed. If she is delivered from his power by a human being, she rewards the latter with foliage which turns to gold. Dwarf-myths have also been grafted upon the hamadryads. The latter, like the dwarfs, sometimes substitute their own offspring for human children.

It is very doubtful whether these tree- and forest-spirits were also objects of worship, *i.e.* whether the milk that was poured out, and the berries that were laid down, at the roots of trees were intended for them. It is much more likely that these gifts were offered to the souls of the departed, which were supposed to survive in trees. In point of fact, trees were regarded by all the Teutons as the abodes, not only of demonic spirits, but also of souls, and as such were treated with the utmost veneration—a practice constantly inveighed against in the penitential discourses and ordinances, as well as in the legal codes, of the early Christian period. We find it said in numerous legends that the souls of the departed pass into trees, or continue to live in the trees that grow upon graves. The extent to which a materialistic conception prevailed here is shown by the widely diffused belief that trees bleed when their bark is injured. Such ideas explain the severe penalties inflicted upon those who committed offences against trees. The act of peeling off the bark was specially forbidden, as the souls were supposed to dwell just beneath it. One found guilty of the offence, according to the *Weistümer* (*i.e.* abstracts of special usages forming precedents in ancient German law), had his body cut open, and his intestines wound about the tree in such a way as to cover the injured part (J. Grimm, *Deutsche Rechtsaltertümer*⁴, Leipzig, 1899, ii. 39). The spirits who lived under the bark could both impart disease and take it

away. Hence sick persons were drawn through a hollow trunk, or else the malady was driven into the tree—*i.e.*, a hole was made in the latter, and some of the invalid's hair or pieces of his clothing inserted into it, the cavity being then closed up again. Departed souls frequently take the form of a bird (owl, pigeon, owlet) sitting upon the tree within which they have their abode. It was also believed that the soul of the family-ancestor had passed into the tree growing in or before the homestead, and this tree accordingly became associated with the tutelary spirit of the family, *i.e.* the domestic spirit. According to Norwegian belief, the *fylgja* (on which see *ERE* iv. 633^a), the protective spirit of the individual, had its home in a tree. In Sweden, even at the present day, an elm or lime-tree growing in front of the homestead is often regarded as the *vårdträd* ('ward-tree'), the abode of the domestic spirit, and from this tree not a leaf must be plucked, or the smallest splinter cut. Pregnant women resorted to it, and hoped by embracing it to secure an easy delivery. As the dwelling-place of the guardian spirit it was known also as the *boträd* ('abode-tree'). Sacrifices and prayers were offered beside such trees with a view to propitiating the tutelary spirits, and warding off evil from man and beast.

The origin of the tutelary spirit—the fact that it was at first the soul of an ancestor—was gradually forgotten, and its place taken by another soul-like being, the guardian spirit of the house, the Norwegian *tomtegubbe* (cf. 'Robin Goodfellow'), the German *Hauskobold* (cf. 'brownie'), who lives either in the trunk of the tree or in the root beneath, and who guards the dwelling-house against injury by fire. If a tree which thus harbours a domestic spirit is hewn down, prosperity deserts the house, and the person who did the deed is taken ill. Some of the old tales represent the tutelary or domestic spirit as dying with the tree; according to others, it remains in the fallen trunk, comes into the house along with the latter, and continues to reside in the rafters made from it; and, if the required offerings (food and milk) are given to it, it continues to guard the house as before. To this class of tree-spirits—tutelary demons evolved from soul-like entities—belongs also the *Klabautermann* (see DEMONS AND SPIRITS [Teut.], vol. iv. p. 633 f.) of the Baltic and North Sea coasts. He is a tree-spirit who has been brought into the ship in the mast. Here he continues to reside, helping the sailors in their work, and protecting the vessel. But, should the ship be destined to go down, he deserts it. He, too, receives gifts of food and milk.

LITERATURE.—J. Grimm, *Deutsche Mythologie*⁴, Berlin, 1876, ii. 1 ff.; W. Mannhardt, *Der Baumkultus d. Germanen u. ihrer Nachbarstämme*, Berlin, 1875; J. G. Frazer, *GB*², London, 1900, i. 166 ff.; E. H. Meyer, *Mythologie d. Germanen*, Strassburg, 1903, p. 191 ff.; M. Höfler, *Wald- u. Baumkult*, new ed., Munich, 1894. E. MOGK.

HAMILTON.—See PHILOSOPHY (Scottish).

HAMITES AND EAST AFRICA.—The classification of the eastern Hamitic peoples is a matter of much controversy. There is a large body of tribes concerning whom, except on some trifling points, there is complete agreement between the various sciences and scientists; outside this sphere there is a want of harmony between anthropology and philology, and between the various philological schools. The common stock may be said to consist of two main groups: the Egyptian Bejas (although notable philologists incline to connect Egyptian rather with the Semitic languages), and the southern or Ethiopic group (Agaos, Sidama, Low Cushite [including Galla, Somali, and 'Afar-Saho]). With these anthropology connects other peoples or import-

ant groups of peoples, as the Nuba, the Funji, the Masai, and the Wahuma, of whom some at least speak languages undoubtedly non-Hamitic. One school of philology, of which the most illustrious representative is Reinisch, limits the true eastern Hamites to the peoples of the two great groups just named, but connects with them two other peoples dwelling between the one group and the other, viz. the Baria and the Kunama, who, although they do not speak a purely Hamitic tongue, employ languages—called by this school proto-Cushite—which seem to approach the Hamitic type, and represent, as it were, a link of connexion between the Hamitic and Nilotic tongues. Another school, of which the most recent and active champion is Meinhof, places the Baria and the Kunama among the peoples speaking the so-called Sudanese, and consequently non-Hamitic, languages; on the other hand, this school includes among the Hamites the Bari dwelling on the White Nile, and the Masai of British East Africa and of German East Africa. It is easy to understand why here, as elsewhere, even for historical reasons, anthropology and philology are not in agreement. Further, while we recognize the importance of the doubts raised concerning the character of the Kunama tongue and the importance of the analogies of the Masai language with the Hamitic tongues, this is not the place to discuss the differences between the philological schools. The following notes refer especially to those peoples whose Hamitic character is generally admitted, with brief references to the two proto-Cushite peoples.

1. The Bejas represent one of the greatest ethnical factors along the middle course of the Nile. According to some anthropologists, they were among the principal elements which went to form the ancient Egyptian people. Many of their tribes and parts of tribes are doubtless concealed under the unidentified names of the conquests of the Pharaohs to the south of Egypt. Their primitive seats appear to have been the desert regions of eastern Nubia. Towards the beginning of the common era they seem to have undergone a powerful movement of expansion or of migration, determined, it may be, by the influx of the Nuba and of other populations of the south-west into the regions of the kingdom of Meroë, of whose inhabitants they must have formed a conspicuous part. This movement drove towards the Egyptian frontier some fractions of tribes, such as the Blemmyes, who were the subjects of fantastic stories and of terror on account of their ferocious incursions; on the other hand, other tribes moved towards Abyssinia. The kings of Aksum were often occupied by the incursions of the Bejas or by expeditions against the Bejas, so much so that among their other titles they assumed that of 'kings of the Bejas.' In course of time the Bejas seem to have gained the upper hand, at least for a time, in the regions of northern Abyssinia. It is certain that among the peoples of the Abyssinian highlands we find some speaking the Tigrina tongue and observing the customs of the other Abyssinians, and who boast a Beja origin, as the Tedrer in Akkele-Guzay, and the Dekk Itäcs of Seraé. There was much rivalry between the Beja element and the Abyssinian stock in the valley of the Barka, in Eritrean Sahel, and on the mountains traversed by the river Anseba in the last part of its course; sometimes the one, sometimes the other, ethnic factor prevailed. Thus there were formed mixed populations, although fractions of races are to be met with who are purely Beja and speak a Beja dialect, as far as the foot of the mountains of Abyssinia proper, such as the ad-Sala dwelling near the outflow of the river

Barka from the mountains of Liban on the plain below.

Meanwhile in the northern regions the Arabs, who had succeeded the Byzantines in their rule over Egypt, must often have come into contact with the restless nomads of the south and their forays. Numerous military expeditions were the consequence, and also numerous treaties, the most ancient of which does not seem to have been very favourable to the Arabs, whose governor Ubaid Allāh ibn Hiyāb as-Salūli undertook to furnish the Bejas with three hundred young camels, provided they would respect the borders of Egypt and the lives and goods of the Musalmāns. As a matter of fact, it was possible to guarantee the safety of Egypt only when several Arab tribes went and established themselves in Nubia, thus paralyzing the warlike inclinations of the local elements, or when these tribes began to pass over to Islāmism. In the 8th and 9th centuries the Bejas formed a sort of independent principality, whose ruler, resident in al-Hajr in the southern part of their territory, acted in the name of all the tribes of his race dwelling between Egypt and Abyssinia. From Arab sources we learn the name of one of these, who already in the year 216 A.H. (A.D. 831) seems purely Islāmitic—Qanūn 'Abd al-'Aziz.

In the days of the historian 'Abd-Allāh ibn Aḥmad ben Sulaim al-Uswāni, who in the 10th cent. wrote a history of Nubia, this union of tribes had ceased, and the tribes had autonomous heads. Among these the ruler of the Balaw, whose seat was at Suakin, deserves mention. The Balaw principality lasted until the end of the 17th cent., when a family of Ja'aliyin, favoured by the Funji, seized the command of the country. Nevertheless the Balaw have continued to constitute a kind of aristocracy down to the present day.

A long time before the historian 'Abd-Allāh al-Uswāni, a great internal revolution had taken place among the Bejas. The place of the Sanafej tribe in the hegemony of the race had been taken by the Hedāreb tribe, to whom ancient Arab writers assign as their territory the Beja country from the Egyptian border as far as Alaky, Aidhab, and beyond. It is worthy of note that even to-day the Abyssinians call both the language and the tribe of the Bejas *Hedāreb*.

Even in ancient times the Bejas must have crossed the Nile, settling nuclei of populations on the left of the river. Among the most important of those derived from them are the Beni Kahil or Kawahla, who, however, in their various inter-crossings have ended by adopting the language and customs of the Sudanese Arabs, although they do not consider themselves to be Arabs. Their principal groups are on the Rahad and the Dinder, but some are also found on the Atbara, on the Blue Nile, and at el-Atshan on the White Nile. Important portions passed into Kordofan, where for a long time they remained mingled with the Kabābish. In fact, the Atawia sections of the Kabābish, the Waylia sections of the Hamar, and the Tuwaimāt sections of the Aulād Bika Jawāma'a still belong to them; a Kawahla colony has even settled at Werna in the mountains of southern Kordofan.

The principal divisions of the Bejas now are: (1) the Ababdeh, between the Nile and the Red Sea to the south of Wadi Hamamat up to the tropic; (2) the Bishāri, to the south of the last towards the territory of Suakin; (3) the Hadendāwa, between Suakin and Kassala; (4) the Halenga, in the territory of Kassala; (5) the Beni Amer, who consist of numbers of the Bejas mixed with others of Abyssinian origin, in the valley of the Barka.

The Bejas have a language of their own, which was formerly studied by Munzinger, and afterwards more perfectly by Alukvist and Reinisch.

The Bejas were always essentially nomads and a pastoral people. A few of them devoted themselves to agriculture; many were camel-drivers. They never had any high degree of civilization, although the *Kitāb al-Fihrist* ascribes a special alphabet to them—perhaps a confusion with that of the Ethiopians or of the distant Berbers. In regard to religion, according to Arab authors, paganism seems to have been dominant for a long time among the tribes furthest removed from Egypt. Mas'ūdi asserts that in his day they still venerated an idol. The tribes nearer to Egypt came under its religious influence. The Blemmyes, who had adopted the ancient Egyptian divinities, were among the most obstinate and latest supporters of them. Later, both from the north and from the kingdom of Aksum, Christianity found its way into their midst. Al-Hamadhānī reports the word employed by the Bejas, or at least by a part of them, to designate 'God,' and this appears to have been a corruption of the *egzi'abehēr* of the Abyssinian Christians. But, setting aside the Beja populations which are assimilated with the Abyssinians of the Eritrean highlands, Christianity has disappeared from among them. Islām, whether from the northern frontier of Egypt or from Aidhāb and Suakin, is now their only religion.

2. The Agaos, whom scientists call 'High Cushite' or simply 'Cushite,' represent the most ancient populations of Abyssinia in the narrowest meaning of the word. Originally they inhabited the highlands which to-day form Tigrē, Beghemder, Dembea, Gojam, Agaumededer, Damot, and Amhara. Later on they fell under the influence of the Semites, who came from southern Arabia; and this influence became stronger when the kings of Aksum were compelled to take action, no longer, as in the first centuries of the common era, to the north of the Abyssinian mountains, but in the wild countries to the south of their capital. The modern Abyssinian is the result of crossings between the Semites of southern Arabia and the local Hamitic peoples, among whom the Agaos had the chief place. In these inter-crossings the Semitic language at length prevailed, while from an ethical and anthropological point of view the Hamitic element obtained the victory. In short, there took place in Abyssinia something analogous to what happened in Egypt after the Musalmān conquest, where the Arabic language extinguished the Coptic, though the *fellah* of our days preserves the same type as the inhabitant of Egypt in the days of the Pharaohs.

The Agao race still remains more or less pure in various districts of Abyssinia. In those regions they have preserved the use of their own dialects, which they employ in familiar intercourse, while in conversing with strangers they use the dominant Semitic tongue of the country, viz. the Tigrē, or the Tigrīna, or the Amharic.

The Agao dialects or languages may be divided into four groups: (1) the central group, represented by the Khamir, spoken in Lasta (Socota, Uag, etc.), and the Khamta, spoken in some districts of southern Tigrē (Averghelle, Bora, Seloā); (2) the northern group, spoken by small tribes called Bogos or Bilin, who dwell in the territory of Keren, near the river Anseba (Eritrea); (3) the western group, represented by the Quara, which, spoken in the district of the same name to the west of Lake Tsana, was afterwards, owing to religious reasons, diffused throughout Dembea; by the Khamant, spoken by a special population scattered in the villages of the Chelga, of the Armatsoho, of the Janfaqara, of the Wagara, and of the Quolla Wagara, as far as Wehni and the north-west frontiers of Abyssinia proper; and, as it seems, by at least another dialect also, spoken in the Falasha villages of Dembea and Wagara; (4) the south-western group, constituted by the Awiya dialect, which is spoken in Agaumededer, and by the dialect of Damot, which exists in the province of the same name. From a more general point of view, the Agao languages can be divided into two great categories in regard to both grammar and vocabulary: to the first might be assigned the central, northern, and western groups; to the second there would only remain the south-western group. It is worthy of note that two special denomi-

nations of the Agaos seem to agree with this great division: those of the centre call themselves Kham (whence the adjectives *khamir* and *khamta*); and there are traces of this name among those of the north and west; those of the south-west call themselves Awā, Awāwā. The Agao languages are known principally through the publications of Reinisch and Conti Rossini.

The Agaos appear in written documents of the first centuries of the Christian era, whether under the name Agao or under that of Kham; some have even thought of connecting with them the *χαμαρά λῆξις*, which, according to Agatharchides, was spoken by the Troglodytes of Ethiopia. Thanks to the power of Aksum, they were able to extend their territory to the highlands of Eritrea. Cosmas Indicopleustes, in the 6th cent., speaks of a prince of the Agaos, who appears to have been a vassal of the king of Aksum, and who aided the caravans which went to the gold countries. In the 10th cent., Abyssinia was devastated by the invasion of a queen who came from the south. On that occasion many of the Agaos fled from the centre of Abyssinia and from southern Tigrē, in order to find a way of escape to the north of the river Mareb. The Bilin seem to have been the last representatives of this migration. In the 13th cent. the regal power passed to an Agao family called the Zaguē; this family was originally from the district of Beguenā (Lasta), and had its capital in Roha, whose famous monolithic churches are, as a matter of fact, ascribed by Abyssinian tradition to a king Zaguē. Several of these kings, as Lalibala and Na'akueto La'ab, figure among the saints of the Abyssinian Church. Towards the year 1268 the Zaguē dynasty was overthrown by another dynasty of 'semitized' origin, which had its capital in Amhara. This is the so-called Solomonide dynasty, because it claims as its founder Menilek, the son of the queen of Sheba and king Solomon; and the present kings of Abyssinia affirm that they too belong to this dynasty. This change of dynasty gave rise to a new movement of Agao peoples towards the north; the Adkemé Melgā of Seraé and the Zaguā of Liban are the chief representatives of this fresh migration, and in course of time they adopted the Tigrīna languages. The Solomonides extended their conquests over the Agaos of the west and south-west, who up till then had remained independent: at the beginning of the 14th cent. Damot was conquered; about a century after, Wagarā was firmly occupied; in the 16th cent. Dembea was definitely taken possession of; and in the 17th cent. Agaumededer was annexed. Semēn, a formidable mountain region, offered a fierce resistance; but the Agao element ended by being almost entirely destroyed.

Little is known of the ancient Agao religion. Their chief god was the sky (Deban or Jar). Under him were many genii—some malignant, like the *zar*, and some beneficent. The latter dwelt in springs, trees, and mountain-tops, and were there venerated. A special worship was rendered to certain genii of the springs, as, for instance, to that of the source of the Blue Nile. Homage was paid to certain animals, especially the serpent, from which omens were sought. For defence against evil spirits and to obtain the assistance of good spirits, the intervention was permitted of special individuals in whom were recognized exceptional faculties and powers. The priesthood was hereditary from father to son. Life continued after death, and food was offered to the dead.

To-day, Agao paganism is no longer professed, and the Agaos are either Christians, Jews, or Khamants. Of the Agao Christians it is not necessary to speak; but it seems certain that many usages of the Christians of Abyssinia, and even the style of their subterranean churches,

have been inherited from the ancient pre-Christian religion. The Jews of Abyssinia are *Agao* by race, and are called *Falashas*. Their origin is very uncertain. At first it was held that they were connected with colonies of Jews of southern Arabia, whom the kings of Aksum were supposed to have forcibly transported into Africa after the conquest of Yemen (6th cent. A.D.), and to have settled in exile on the mountains of Semēn. Now the hypothesis seems to be preferred that Judaism came into Abyssinia by land from Egypt. The *Falashas* do not know Hebrew, and they have not the Targum; they have adopted the Bible of the Christians of Ethiopia, and also their alphabet, their literary language, and almost all their books. But, although without originality, they have shown an indomitable attachment to their religion. Cf. *ABYSSINIA, AGAOS*.

3. The peoples conventionally called *Sidama* represent a great mixture of differing ethnic elements; and this explains the immense variety of classification met with among travellers, according to the prevalence of this or that physical characteristic. It may be, however, that a better knowledge of the anthropological elements and of the languages of these populations will bring about a modification of the classification which is at present accepted by scientists.

The territory of the so-called *Sidama* seems originally to have embraced the southern part of Abyssinia, properly so called (at least the western province of *Shoa*), and to have extended southwards to within a short distance of the great equatorial lakes; to the east it extended towards the *Webi*; on the west it occupied the high valleys of the rivers *Sobat* and *Didessa* and of the other affluents of the *White Nile*; to the north-west it crossed the *Blue Nile* (which separated it for a considerable part of its course from *Gojam* and *Damot*), and reached as far as the west of *Agau-meder*. The very position of this country shows that it must have been a battle-ground between the *Hamites* of the north and east and the *Sudanese* of the west—battles of which, for the most part, we know nothing. The *Abyssinians*—*Semites* or 'semitized'—early established themselves in the regions to the north, and absorbed the local tribes; the *Gurāguē*, who speak very corrupt *Semitic* dialects, seem to be descendants of a north *Abyssinian* military colony, which had been placed to guard the southern confines of the kingdom, and which in the course of centuries had become amalgamated with the peoples of the country. Thence the *Abyssinians* endeavoured to extend their territory still further south by conquests and raids; but the forming of *Sidama* States, whose chief sought a defence in *Islāmism*, kept them back, or at least hindered the populations of the valley of the river *Omo* from being absorbed. Towards the middle of the 16th cent. the *Galla* tribes, dwelling to the east of the so-called *Sidama*, began their migrations and invasions, which were, for Ethiopia, more violent, and had more lasting consequences, than the barbarian invasions of Europe. All the eastern part, all the north and north-west of the *Sidama* territory, became *Galla* territory; to the *Sidama* little more remained than the valley of the *Omo*.

To-day, as far as is known, the *Sidama* may be divided, philologically speaking, into four principal groups: (1) *Kaffa* and *Goaga*; (2) *Hadia* and *Tambaro*; (3) *Dawaro* and *Walamo* or *Walaita*; and (4) *Zenjero*, *Yangaro*, or *Yamma*. The *Kaffa* has been studied by *Reinisch* and, without any critical aim, by *Ohiarini* and *Bieber*; as regards the other idioms, we have only the imperfect, or not as yet scientifically examined, materials of *Beke*, *Chiarini*, *Cecchi*, *Borelli*, etc.

The *Abyssinian* conquests of the 16th cent. introduced Christianity among the *Kaffa*; and thence faith in the *Messiah* seems to have penetrated even

among the *Shūro*, negroid tribes to the south-west of the *Kaffa*. But the long isolation of those regions from Abyssinia caused great alteration in the adopted religion. Some results have been achieved by Catholic missions during the last fifty years. The recent *Abyssinian* conquest is destined to revive the condition of the *Coptic Church* there, unless *Islāmism* gains the upper hand. *Islāmism* had appeared among the *Sidama* of the *Hadia* in the 14th cent., but for centuries it made no progress; it has, however, been making rapid advance during the last fifty years. The old paganism is losing ground. Two types of paganism appear to be recognizable among the *Sidama*. It is not at present possible to say if the second represents a derivation from the first. The first type is met with among the *Kaffa* and the *Ometi* (*Conta*, *Cuisha*, *Kullu*, *Sale*, *Uba*, *Gofa*, *Mallo*). The supreme deity is *Hecco*, called also *Deoc* or *Deotshe*. *Hecco* is invisible, but is incarnate in his priests and in the king of the *Kaffa*; those who are incarnate in *Hecco* become *Hecco* themselves. Among the *Kaffa*, the priests belong to the aristocratic class of the *Gonga*, whence also is derived the royal family. There are twelve high priests among the *Kaffa*, and over all one high priest residing formerly in *Addio* near the village of *Gollo*, now in *Coba*. This high priest consecrates the newly elected king, and receives annual tribute also from the *Ometi*, or inhabitants of the valley of the *Omo*, who are not politically dependent on the *Kaffa*. Worship is paid in a temple in a wood. The priest, falling into a kind of trance, announces to the faithful the will of the god. The priest is naturally also the sorcerer who cures sicknesses, delivers from the effects of the evil eye, etc. Under *Hecco* there are tutelary genii of different places, who live in springs, rivers, cross-roads, and great trees. The priests may not eat the flesh of the ox. All, however, regard as prohibited, because unclean, the flesh of the horse, ass, mule, wild boar, hippopotamus, and monkey; men abstain from eating cabbages, and women from eating fowls. Their beliefs about the other world seem to have been largely influenced by Christianity; but at the same time it is still possible to discern in their various rites and ceremonies the remains of primitive beliefs—*e.g.* that death is succeeded by a life like the present. Thus, when a king died, his servants brought him his customary food every day for a year; it is also said (but this is not certain) that at the time of his burial a slave was killed, in order that he might continue to serve his sovereign. Among the *Zenjero*, religion had a specially ferocious and brutal character. The supreme god seems to be the sun; further, the *Zenjero* alone among all the peoples of Ethiopia have (or had) an idol of iron rudely formed, which, they say, fell from heaven. They venerate numerous genii in the mountains, rivers, and rocks. The king was supposed to be an incarnation of the supreme solar divinity, and was the chief of the priests and sorcerers of his realm. It was his duty to deal the first blow to the human victims who, at the beginning of ten out of the twelve months of the year, were immolated on the summit of *Mount Bor-Gudda*; these victims were chosen from twenty-two families of the country. Other human sacrifices were offered on other occasions. Out of every ten strangers who crossed the frontiers of the kingdom, one had to be sacrificed to the divinity. Naturally, the *Abyssinian* conquest, which took place in the year 1887, put an end to these practices.

According to *Borelli*, the chief divisions of the *Sidama*, based on their languages and on their political groupings before the *Abyssinian* conquest, are the following: (1) *Kaffa*; (2) the ancient kingdom of *Garo* on the south and east slopes of the mountains of *May-Gudo*; (3) *Zenjero*; (4) *Kullu*, *Dauro*, or

Dawaro between the river Omo and the Contab; (5) the kingdom of Contab between the river Gojeb, the Kullu, the Kaffa, and the river Omo; (6) the kingdom of Cosha between the Kaffa, the Contab, the river Omo and the Gola; (7) Gola between the Cosha, the plains of Yaya, and the Kaffa—to the east of the Omo; (8) Corbo near the Zenjero; (9) Conta between the Corbo and the stream Gamuna; (10) Maroko, a kind of 'enclave' in the Hadia; (11) Hadia, scattered between the Omo and the Amulla as far as the borders of the Galla Arussi; (12) Tambaro, bordering on the Walamo; (13) Walamo or Walalsa between the Tambaro, the stream Billaté, Lake Margherita, the Cusha, and the river Omo; (14) the kingdom of Cutsha to the south of the Walamo; (15) the kingdom of Gofa to the south of the Cutsha and the river Omo; (16) Malo between the Omo, the Gofa, the Doco, and the Arra; (17) Doco (negroid Sidama) between the Omo, the Dimé, the mountains of the Arra, and the Malo; (18) Dimé between the plains of Yaya and the Omo—outside the valley of the Omo; (19) the Cambatta to the west of the river Billaté and of the Arussi, between the Alaba, the Hadia, and the Walamo; (20) Arroro or Haruro, on an island of Lake Margherita; (21) the kingdom of Boroda, to the south-west of Lake Margherita; (22) Chochora in an 'enclave' of the Cutsha; (23) Gamo between the Arussi, the Cutsha, and the Zalla; (24) Zalla, to the west of the Gamo; (25) Uba, to the west of the Zalla; (26) Anica, to the south of the Uba; (27) Arra, to the west of the Uba.

4. The group which, from the nature of its situation, in contradistinction to the mountainous regions of the Agaos, is called Low Cushite, is composed of three great branches: Galla, Somali, and Afar-Saho. Their original seat seems to have been between the upper course of the Webi and the African coast of the gulf of Aden. Already in ancient times we find that the country between the strait of Bab el-Mandeb and Cape Hafun was inhabited by a people called Berbers, in whom we have no hesitation in recognizing the progenitors of the Somali people of to-day. How far they advanced into the interior is unknown; but it is very probable that from the most remote times the desert region, extending from the sea to the mountains of Abyssinia, belonged to tribes of this stock. In course of time, Low Cushite tribes spread not only towards the west, but also towards the north. These tribes, developing special characteristics, and vaguely recognizing a blood-relationship among themselves, gave place to the 'Afar or Dankali. 'Afar is a national name; Dankali is an Abyssinian name, whence comes the Arabic plural *Danākil*. It is noteworthy that the 'Afar are divided into 'Adoi Mara, 'white people,' and Asoi Mara, 'red people,' the latter forming a hegemony with the former; when and why this distinction arose is unknown.

(a) The 'Afar, establishing themselves in the oasis of Aussa, in the valleys descending from the Ifat and from the other eastern districts of the Shoa (if, indeed, they did not formerly occupy the eastern margin of the latter), must have formed the principal part of that kingdom of Adal which caused so much trouble to Christian Abyssinia in the 13th, 14th, 15th, and 16th centuries. Some portions of their tribes still call themselves Adiel. With these the Somali tribes of the north combined; but in the times of the *imām* Ahmad ibn Ibrahim, called the Ghazi (Gragh among the Abyssinians), who almost entirely destroyed Ethiopian Christianity, the invading Musalmān armies were still largely composed of the 'Afar. The 'Afar spread as far as the peninsula of Buri and the gulf of Adulis.

They are now divided into a number of small tribes, scattered over a very unfavourable territory, which consists principally of stony or sandy deserts, traversed by great lava streams. When the old Adal kingdom fell, and deep hatred grew up between the Dankali and the Somali, the chief 'Afar authority fell into the hands of the Sultan of the Aussa, who for some time had a certain measure of effective power, and till very recent times a considerable moral prestige among all the tribes of his race. Other sultanates, of only secondary rank, are those of the Biru, of Raheita, and of Tajura. The northern tribes, however, Dahimela, Belesua, etc., with chiefs of their own, came under the hegemony of the Abyssinian chiefs of Tigré or of the Musalmān chiefs who held Arkico and Massawa for Turkey. The 'Afar language is known through the studies of Reinisch and Colizza.

Ancient 'Afar tribes gradually spread further

northwards, where they gave rise to the Saho tribes.

It is possible to-day to recognize five Saho groups: (1) the Minifere, who dwell between Senafé and Arafali, and seem to be a cross between Saho people and the Abyssinian garrisons who had been placed to guard the country against Saho-Afar invasions; (2) the Haso, dwelling to the south of these last as far as the river Ragali or Endell and the torrent Laasi-ghedé, and their brethren, the Toroa, who wander with their flocks and herds in the valleys of the Hadda, the Alighedé, the Saaghedé, on the south-eastern declivities of the Hamasén, in Sanhar; (3) the Asaorta in the district between the maritime region of the Adulis (Zula) and the Abyssinian highlands, to the south of the Toroa, to the north of the Miniferi; (4) the Debrimela, two very small tribes dwelling in the region of Mount Debra to the east of the Senafé; and (5) the Irob, to the north-east of Agamé. But besides these tribes, who speak the Saho tongue, which is closely allied to the 'Afar language, the Saho gave rise to not a few other populations, who, mixing in course of time with local peoples of other races, adopted their customs and language entirely. The dominant class of the Mensa and Maria tribes, the former dwelling to the north of the river Laba and the latter on the lower course of the river Anseba, are of Saho origin, as also are the Egghelá of Tigré, the Soruxo of Agamé, the Temza of Seraé, several villages of Seraé, etc. It is also said that the Wojerát to the south-west of Tigré are of Saho origin, of the same stock as the Debrimela. The Saho language is known chiefly through the studies of Reinisch.

(b) The *Somali*, or their direct progenitors, as has been said, were in ancient times known as Berbera, Barbara (Berbers [*q.v.*]), and are so called by Arab geographers of the Middle Ages. The name *Sumālē* appears for the first time in documents of the beginning of the 15th century. The most ancient sources show the Somali maritime region as being defined to the west by the *Sinus Aualiticus* (Gulf of Tajura), and to the east by the mart of Tabe (*ras Binna*), commencing with Opone (Hafun), and the marts of the Azania and the Zenj of Arabic writers. But the Somali broke forth from these confines towards the south, crushing and absorbing the aboriginal populations of other races. This movement seems to have become more intense when the Somali passed over to Islāmism. It is said that towards the 14th cent. the Somali tribe Hawiya, called that of the Ajuran, succeeded in becoming masters of the territory between the lower courses of the Webi and the Juba; in that century the Arab geographer and traveller Ibn Baṭūta speaks of Mogadisho (Magdāshu) as a city in Somali territory which was founded by fugitives of the al-Harith tribe in the neighbourhood of Bahrein. To-day the Somali are one of the most widely diffused Hamitic peoples. Broadly speaking, the whole of the great triangle, Jibuti, Cape Guardafui, and the mouth of the Juba, may be considered as their country; but their ramifications seem to go even further towards the south-west.

According to Gabriel Ferrand, the principal Somali tribes are: (1) the Isa, between Jibuti, Khor Culangarit, and Ghildessa, with the ports of Jibuti and Zeila; (2) the Gadabursi, in a mountainous quadrilateral lying N.N.E.-S.S.W., traversed diagonally by the 41° long., and having its extreme angles at about 10° 40' lat. towards the N.W. and at 9° 30' towards the S.E.; (3) the Habr Awal to the east of the last, with the ports of Dungareita, Bulhar, Berbera, and Siyara; (4) the Habr Toljalé, between Adai Corda on the sea, Burao, the mountains Burdab, Muyo, and the mountains of the Gulai; (5) the Habr Gheraj (Gaa, Gaj) or Gaila, who together with the Habr Awal and the Habr Toljalé are also called Habr Magadlé; (6) the Warsangheli, between Gudneida on the sea, the mountains Gargar, the Tug Daror, and the port of Bender Ziyāde; (7) the Dulbohanta, to the south of the Warsangheli, to the east of the Habr Toljalé, to the north of the Ogaden, and to the west of the Mijurtin, with the high valley of the Wadi Nogal and with the village of Bobotle; (8) the Merraihan, an important sultanate which extends from Bender Ziyāde on the gulf of Aden to beyond Ras el-Khall on the Indian Ocean; (9) the Gherri, to the S.S.E. of Harar; (10) the Bartirri to the east of the latter; (11) the Barsub, towards the source of the river Fafan; (12) the Babilli, to the west of the Bartirri and the Barsub and the Galla frontier; (13) the Habescul, to the east of the Gherri and the Barsub; (14) the Mirawawál and the Mecabul in Ogaden; (15) the Hawiya, to the south of the Mijurtin, in all the zone towards the Indian Ocean, divided, like the former, into numerous tribes, among which may be named the Harti, the Abgal, the Bimal, the Shidle; and (16) the Rahanuin, who perhaps are not of Somali race, although they speak the Somali language, between the Webi Shebelli, the Ogaden, the Galla, the river Tana, and the mouth of the Juba. The Somali language has been the subject

of numerous publications. The most important are those of Reinisch; there may also be mentioned those of E. de Larajasse, Oyprien de Sampont, Schleicher, Jahn, etc.

(c) The Galla seem to have dwelt in ancient times to the S.E. of the river Webi. Unknown reasons caused their formidable invasions of the Sidama countries and of Abyssinia in the middle of the 16th century. They were at that time herdsmen; they were ignorant of the use of metals, so much so, that, according to tradition, they made use of the horns of cattle for swords; they did not possess the horse, although in the course of time they became the best horsemen of Ethiopia. Having scattered or subjugated all the Sidama people of the north-east and north, they succeeded in pushing themselves into the western districts, and even settled between the higher courses of the Baro and the Didessa. They also planted themselves in Abyssinia proper, not only in the southern districts of the Shoa, but also to the north of the river Jimma as far as Lake Hayk and the frontiers of the province of Angot. Enrolled as pretorian guards by the kings of Abyssinia, they founded military colonies here and there, of which that of Metsha in Gojam is important. Thanks to the beauty and fruitfulness of their women, in the 18th cent. they attained the highest political influence in the kingdom. One of their women practically governed the State towards the middle of that century, and sons of their women ascended the throne. To a less degree the Galla also spread towards the south; their extreme limits are met with at a distance of a few days' journey from Lake Rudolf, and the influence of their speech may be traced in the language of the Pokomo, south of the equator and to the north-west of Lamo. By reason of all these movements from place to place, and through the inevitable crossings with the populations already existing in the lands newly occupied, the Galla ethnical type was profoundly altered. While, on the one hand, some of their tribes do not differ in appearance from the true Abyssinians, others, on the contrary, have all, or almost all, the characteristics of negroid populations.

The changes in their social and family habits are equally profound. Thus, formerly they had no tribal heads, but nominated a kind of leader called *lubā*, who remained at his post seven years. Later on, wars and contact with peoples living under a monarchy brought about the development of the principle of monarchy, or at least placed that of a republic on more solid foundations. About the second half of the 18th and the beginning of the 19th cent. there grew up in the regions to the south-west of the Shoa (Ghera, Jimma, etc.) little Galla monarchies, having characteristics of their own.

The Galla call themselves by the national name *Ilmorma*, or 'sons of Orma,' whence the name Oromo or Oroma, under which they are also known. Their chief division is into Baraituma and Boran.

The most important Baraituma tribes are the Karayu, Wollo, Obo, Marawā, Warailū, Itu, Akatshu, and Warantisha; the most important of the Boran are the Metsha, Hocco, Obo, Gudru, Liban, Illu, Soddo, Galan, Tuloma, Sadatsha, Limmu, Lega, etc. From a geographical point of view we may mention the Boran, who occupy a vast extent of territory, the southern part of the Galla country, between the region of Lake Stephania and the river Juba; the Arussi to the north of the preceding between the Somali of Ogaden and the Sidama; the Ala to the south of Harar; the Itu, Itu-Chercher, Oborra, Metta, and Wara-Bellé, between the Shoa and the Harar; the Abitshu, the Gombitshu, and the Galan to the west of Ankober; the Metsha and the Metta to the west of Entoto; the Betsho, the Keku, the Illu, the Soddo along the upper course of the Hawash; the Nonno near the extreme northern curve of Ghibié, to the north of the Enarya; the Jilli between the Hawash and the Lake Zwai; the Limmu in the Enarya; the Jimma Abba Jifar to the south of the Limmu; the Ghera to the west of the last; the Motsha on the western slopes of the Ghesha mountains, the Ilu Nonno and the Guma between the high valleys of the Baro and the Didessa; the Jimma Hine, between the

Didessa and the Nonno; other Jimma peoples to the north of the Nonno; the Gudru near the extreme southern curve of the Blue Nile; the Wollo, in the heart of Abyssinia, between the river Jema and the upper course of the river Bashilo; the Yeju, near the Angot. The Galla tongue is known through the investigations of Praetorius and from the materials collected by Tutschek, Massaja, Cecchi, and others.

The Somali, the 'Afar, and the Saho have been converted to Islāmism, although not a few pagan practices corrupt the purity of their Musalmān faith. Part of the Galla have passed over to Christianity; but Islām is making rapid progress among them. Several tribes still remain pagan. Their supreme divinity is Wāq, who dwells in the sky above the clouds. Under him are good spirits (*ajāna*) and evil spirits (*jinni, sar*); the latter are 44 in number. The spirits possess some of the powers of the omnipotent, which they are credited with employing. A number of these genii have special names and functions; e.g., Atēte, a female spirit, presides over the multiplication of men and animals, and is in a certain sense the genius of fecundity. As a rule, the spirits are incorporeal, but at times they assume forms more or less strange; for example—at least among the Galla of Challa, Ghera, etc.—an evil spirit is believed in, having the body of a cock, with four horns on its head, and with a baleful look which causes the death in a few days of him who has been gazed upon. They have no idols. Every tribe, every family, every house, and every man has a tutelary genius. Genii dwell in rivers, great trees, ruins, and certain caverns, and are there venerated. Some species of serpents and of birds are likewise objects of veneration. The Galla do not practise human sacrifice. Divination by means of the peritoneum of immolated victims is very common—a usage which among Ethiopian populations seems to be of purely Galla origin. They have many superstitions, several of which are common to other Ethiopian peoples, as, for example, that of *buda*, a malignant man who transforms himself by night into a hyæna, exercises the power of the evil eye, etc. There are numerous classes of priests, diviners, and sorcerers. The Galla believe in life after death; but it is a vague belief, reflecting Christian and Musalmān ideas. Further, their religion, if it has succeeded in causing Shoa Christians to adopt its belief in its *qolo*, or house-protecting genii, has, on the other hand, largely accepted beliefs, rites, and beings who are objects of veneration in other religions. This it has done in regard to Islāmism and Christianity; from the latter it has even adopted some saints, the Virgin Mary, and a few churches—e.g. that of Zequalā. In the same way, it has taken from the Sidama religion the genius *datshe*, etc.

5. The Baria seem to be the last remains of a people at one time widely diffused but now on the road to extinction. If the hypotheses of the present writer are well founded, this people came from the highlands of Eritrea, and perhaps from the maritime region of the Red Sea, as far as the Nile over against Meroë. Their territory was more and more narrowed by the spread of other populations, as the Bejas, Nuba, etc. Reduced to a few thousands, they are to-day collected in the by no means hospitable region to the south-west of the Barka, which is traversed by the torrent Mogareb, dividing them into two groups. That to the west of the torrent is called Mogareb, that to the east Haghir. They, however, call themselves Neré. Their customs have a strongly democratic character. Their language, which has been studied by Reinisch, seems, even in its grammatical forms, to have undergone Semitic influence, while their vocabulary is still tolerably pure. Pagans, like the Kunama, until half a century ago, they are now all Musalmāns.

6. The Kunama appear to be the remains of a people variously named (Bazah, Hamej), which extended from the western outposts of the Eritrean highlands (Dembelâs) as far as the river Atbara at Metemma in the territory of Fazogl, almost as far as the Blue Nile. Other isolated portions of this people are found here and there. Somewhat recent events have brought about their almost entire destruction in the countries bordering upon Abyssinia; the more distant tribes are gradually undergoing change by contact with other peoples. Chiefly of Kunama origin are the Algheden, who speak the Tigré language, between the Baria and Kassala territories; and perhaps of the same origin are the Dabaina, a tribe in the Atbara territory which many assert to be Arabian. The Kunama are almost all collected in the middle valley of Gash and in part of the valley of Tak-kazé, which together form the south-west part of Eritrea. They are divided into many small tribes: Tica (Sogodas, Aneli, Ogonna, etc.), Tolé, Anagullú, Cullucú, Fodé, Bitama, Elit, Eimasa, Selest Logodat, Tawda, Goita, Alummu, Ghega, etc. They are at a very rudimentary stage of civilization, although they are tolerably perfect in agriculture. Their customs and laws are very democratic, and are based upon universal equality. They are, for the most part, ruled by the advice of the old men, and they hardly recognize any effective authority of chiefs. They have no idols. Their god is called Anna. Religious offices are handed down from father to son in certain families, as those of the Aula Manna, who have the duty of causing rain at suitable seasons; the Ula Manna, who keep the locusts at a distance from the Kunama country; and the Furda Manna, who indicate the time for beginning the ingathering of the grain, indiarubber, and honey. The first two offices carry with them the pain of death if the charms turn out ineffective. But the religious practices of the Kunama consist in manifestations of a gross superstition rather than in the worship of Anna. The Kunama language, which differs much from the Baria tongue, has been described by Reinisch.

LITERATURE.—Antoine T. d'Abbadie, artt. in *JA* vii. (Paris, 1839) 364-369, xi. (1840) 388-396, in *Actes de la soc. philol.*, Paris, 1872, in *Bull. soc. géog.*, 2nd ser., vol. xix.; Arnauld d'Abbadie, *Douze Ans dans la haute Éthiopie*, Paris, 1869; H. Almkvist, *Die Bischari-Sprache*, Upsala, 1881-85; C. T. Beke, in *Proc. of Philol. Soc.*, ii. (London, 1845) 89-107; Bieber, artt. in *Mitteil. des königl. geog. Gesellsch.*, Vienna, 1910, in *Rev. études ethnogr. et soc.*, Paris, 1909; J. Borelli, *Éthiopie mérid.*, do. 1890; J. Bruce, *Travels to discover the Source of the Nile*, Edinburgh, 1790; E. A. W. Budge, *The Egyptian Sudan*, London, 1907; A. Cecchi, *Da Zeila alle frontiere del Caffa*, Rome, 1885-87; E. Chantre, *Recherches anthropol. en Égypte*, Lyons, 1904; G. Colizza, *La lingua 'Afar*, Vienna, 1887; C. Conti Rossini, artt. in *Giorn. Soc. As. Ital.*, Florence, 1903, xvii. and xviii., in *Boll. Soc. Ital. di Esplor. geog. et commerc.*, Milan, 1903-04, in *Riv. di studi orient.*, Rome, iii. iv. vi., in *Rend. Reale Acc. dei Lincei*, 1912, *La Langue des Kemant*, Vienna, 1912, and *Schizzo etnico e storico delle popol. Eritree*, 'L'Eritrea Economica,' Novara, 1913; J. Duchesne-Fournet, *Mission en Éthiopie*, Paris, 1909; J. Faitlowitch, *Quer durch Abessinien*, Berlin, 1910; G. Ferrand, *Les Comalis*, Paris, 1903; A. E. W. Gleichen, *Handbook of the Sudan*, London, 1898; C. Guillain, *Documents sur l'histoire . . . de l'Afrique orientale*, Paris, 1856-57; J. Krall, *Beitr. zur Gesch. der Blemyer und Nubier*, Vienna, 1898; F. v. Luschan, *Anthropol., Ethnogr., und Urgesch.*, Hanover, 1905; H. A. MacMichael, *The Tribes of Northern and Central Kordofan*, Cambridge, 1912; G. Massaja, *Lectiones grammaticales . . . linguæ Amharicæ*, Paris, 1867; C. Meinhof, *Die Sprache der Hamiten*, Hamburg, 1912; F. Müller, *Grundriss der Sprachwissenschaft*, Vienna, 1877; W. Munzinger, *Ostafrikan. Studien*, Schaffhausen, 1864; P. Paulitschke, *Beitr. zur Ethnogr. und Anthropol. der Somdl, Galla, und Harart*, Leipzig, 1886, *Harar-Forschungsreise*, do. 1888, and *Ethnogr. Nordost Afrikas*, Berlin, 1896; F. Praetorius, *Zur Grammatik der Gallasprache*, Berlin, 1893; E. M. Quatremère, *Mém. géog. et hist. sur l'Égypte*, ii., Paris, 1811; L. Reinisch, *Die Barea-Sprache*, Vienna, 1874, *Die Sprache der Irob-Saho*, do. 1878, *Die Kunama Sprache*, do. 1881-89, *Die Chamire Sprache*, do. 1883-84, *Die Bilin-Sprache*, do. 1888-87, *Die Quarasprache*, do. 1885-87, *Die 'Afar-Sprache*, do. 1885-87, *Die Kafa-Sprache*, do. 1888, *Die Saho-Sprache*, do. 1889-90, *Die Bedaue-Sprache*, do. 1893-95, *Die Somali-Sprache*, do. 1900-03, *Das persönliche Fürwort und die Verbal-flexion in den chamito-semit. Sprachen*,

do. 1909, and *Die sprachl. Stellung des Nuba*, do. 1911; E. Revillout, *Mém. sur les Blemmyes*, Paris, 1874, and *Second Mém. sur les Blemmyes*, do. 1888; G. Révoil, *La Vallée du Darror*, do. 1882, and *Notes d'archéol. et d'ethnogr.*, do. 1884; G. Sapeto, *Viaggio e missione cattolica fra i Mensà, i Bogos, e gli Habab.*, Rome, 1867; A. W. Schleicher, *Die Somali-Sprache*, Berlin, 1892; G. Sergi, *Africa: antropol. della stirpe camitica*, Turin, 1897; S. Sergi, *Crania Habessinica*, Rome, 1912; H. A. Stern, *Wanderings among the Palashas*, London, 1862; C. L. Tutschek, *Dictionary and Grammar of the Galla Language*, Munich, 1844-45; D. Westermann, *Die Sudansprachen*, Hamburg, 1911; C. Wilson, in *JAI* xvii. (1887) 3.

C. CONTI ROSSINI.

HANBAL.—See IBN HANBAL.

HAND.—I. Introduction.—The hand, as that member of the body which is used more than any other for all actions, whether ordinary, magical, or religious, became naturally a symbol of power. The hand of a certain being means the power exerted by him. Thus, to take a few instances at random, in Semitic usage an attack by a ghost on a human being is called 'the hand of the ghost.'¹ In the Scottish Highlands, invocation of 'the hand of your father and grandfather' means invocation of their power.² In Biblical usage, and perhaps thence passing into general speech, 'the hand' is a common phrase for power, God's or man's (Ex 3²⁰); and it occurs in innumerable connexions. Similarly the phrase 'God's hand' in the Qur'an is taken to mean His power, though the Wahhâbis interpret it literally.³ In Christian art down to the 12th cent. a hand issuing from the clouds—frequently in the gesture of benediction, or with rays proceeding from it—is a symbol of God the Father.⁴ But already in ancient Egypt this symbolism is found as early as 1500 B.C., when the sun, the Divine symbol, is depicted with numerous rays, each terminating in an open hand.⁵ It is also found in the Rigveda. The god Savitar is said to extend 'his vast hand . . . and all here obey him'⁶ No doubt, in the primitive anthropomorphic thought of all ages, the 'hand of God' was regarded with literal significance. Thus the saying, 'the souls of the righteous are in the hand of God' (Wis 3¹), is represented symbolically, yet with clear anthropomorphic reference, as a large hand emerging from the clouds and holding a number of tiny human figures (souls), even in a late Greek fresco.

As a rule, the right hand is considered of more importance than the left, and it is usually mentioned before it in ceremonies affecting both hands, probably because it is used for many more purposes than the left, which is therefore more awkward. Hence many savages reserve the left hand strictly for the lower purposes of life.⁷ In South Africa a man must not touch his wife in bed with his right hand, else he will have no strength in war.⁸ Many Arabs will not allow the left hand to touch food, because it is used for unclean purposes, the right for all honourable purposes.⁹ In many magical rites there is a preference for the use of the right hand, because it is more powerful; but not infrequently the unlucky left hand is used, perhaps with a view to increasing the sinister force of the magical action.¹⁰ In religious actions the right hand is the more important. Thus the Egyptians anointed the statues of the gods with the little finger of the right hand, and it has been commonly used by most peoples in salutations, blessings, lay-

¹ R. C. Thompson, *Sem. Magic*, London, 1908, p. 35.

² J. G. Campbell, *Superstitions of the Highlands and Islands of Scotland*, Glasgow, 1900, p. 238.

³ Hughes, *DI*, p. 161.

⁴ A. N. Didron, *Christian Iconography*, Eng. tr., London, 1886, i. 201 ff.

⁵ J. G. Wilkinson, *Anc. Egyptians*, ed. London, 1878, iii. 52.

⁶ Rigveda, ii. 38.

⁷ H. H. Ellis, *Psychology of Sex*, Philadelphia, 1906, v. 48.

⁸ J. Macdonald, *JAI* xx. [1891] 140.

⁹ E. W. Lane, *Modern Egyptians*, London, 1846, i. 195, ii. 16.

¹⁰ Cf. J. Grimm, *Teut. Myth.*, tr. Stallybrass, London, 1882-88, pp. 693, 1197, and *passim*; Pliny, *HN* xxiv. 11 [Gauls].

ing on of hands, etc. (cf. Gn 48¹⁴).¹ In divination the Greeks regarded the right as the lucky hand, but the Romans mainly thought the left to be so. But with them the east was the favourable side, and, always facing south in taking omens, they had the east on the left hand.² They did, however, frequently regard left as unlucky, as is obvious from the secondary meanings of *sinister* and *dexter*.³ The preference for the right hand is perhaps connected with the apparent course of the sun from east to west, and the consequent idea that a sun-wise course, keeping the object always on the right hand, is of good omen and the opposite is evil.⁴

It still remains to be discovered why among all races, savage and civilized, the right hand is generally used. Left-handedness occurs sporadically (8.88% in the German army), and some people are ambidextrous. Some scripts run from right to left, or from each side alternately. There is no obvious physiological and psychological reason for the preference, and in fact most young children use the left hand until trained to use the right.⁵

Since the hand signifies power, gods and heroes are frequently represented with several arms. This is most common in Hindu mythology and religious art; it is also found among the ancient Slavs; and, though the Greeks were too artistic to make much use of what is a deformity, traces of it exist on Greek soil. A Lacedaemonian Apollo has four hands, Briareus had a hundred arms,⁶ Geryon six hands. Teutonic gods do not share this deformity, but it is often attributed to giants and heroes.⁷ The deformity of six fingers on each hand is probably also regarded as a symbol of strength (cf. 2 S 21²⁰). Conversely, some gods are one-handed—Tyr in Norse mythology, Nuada in Irish.⁸

The idea of the power of the hand is perhaps also shown in various myths of birth from the hand, etc. Persephone was called *Xειρογονία*, Prithu sprang from the hand of Veṅa, and from the arms of the primal man Puruṣa the Rājanya were formed.⁹ Human hands as well as feet and heads are stuck up in fields in Lhota Nāga, N.E. India, to ensure a good crop,¹⁰ and also in Luzon.¹¹ In the Lupercalia, women who wished to become fruitful received blows on the palms of their hands from the Luperci,¹² and in Quiché and Annamese myth or *Märchen* splitting into a woman's hand causes conception.¹³

In the speech of all lands, metaphors sometimes drawn from the gestures accompanying the actions thus described are in common use. 'Open-handedness' signifies generosity (cf. Dt 15¹¹); 'narrow-fistedness,' niggardliness; 'high-handedness' arbitrariness. 'To take one's life in one's hand' is suggested by the carrying of something precious through danger; it is of common occurrence in the Bible (Jg 12³, 1 S 19⁵, Job 13¹⁴; cf. Ps 119¹⁰⁹).

2. The sacredness of the hand in itself or for particular purposes is seen in various ways. The ancient Hindu sacred books point out that each part (*tīrtha*) of the hand is sacred; e.g., the root of the thumb is sacred to Brahmā, that of the little finger to Kṛṣṇa (or to Prajāpati), the tips of the fingers to the gods, and the part between the thumb and the index to the *Pitri*; and directions are given regarding the ritual sipping of water from the hand.¹⁴ In modern Hinduism the various parts of the hand are sacred to different forms of Viṣṇu, and in the *Kara-nyāsa* ceremony homage is offered to the thumbs, fingers, palms, and backs

¹ Praetorius, *de Pollice*, Leipzig, 1677.

² Cicero, *de Divin.* ii. 39 (82).

³ Cf. *ἀπαιρέσις* (possibly *ἀπαιρέσις* may be a kind of comparative of *ἀπαιρέσις*, 'the best'; and, if so, it is then used euphemistically for what is unlucky), *gauche*, *link*, with the secondary meaning of 'unlucky,' 'awkward,' 'clumsy'; righteousness is doing right, evil actions are sinister.

⁴ *Deiuit*, *pradakṣiṇa*, *dextratio*, *widdershins*, *cartursul*, *prasaṅga* (see CIRCUMAMBULATION; and, on the whole subject, O. Stoll, *Das Geschlechtsleben in der Völkerpsychologie*, Leipzig, 1908, p. 278; J. J. Bachofen, *Das Mutterrecht*, Stuttgart, 1861, *Versuch über die Gräbersymbolik der Alten*, Basel, 1859, s.v. 'Links'; Schrader, *Reallex.*, Strassburg, 1901, s.v. 'Rechts und links').

⁵ See artt. by von Bardeleben, in *L'Anthropologie*, Paris, 1911.

⁶ *Il.* i. 402. ⁷ Grimm, pp. 387, 1304.

⁸ See CELTS, vol. iii. p. 284, and explanation suggested there.

⁹ A. Kuhn, *Die Herabkunft des Feuers*, Berlin, 1859, p. 169; J. Muir, *Orig. Skr. Texts*, London, 1858-72, v. 368 ff. For hand and fingers as symbols of the fruitfulness of Nature, see Bachofen, *Versuch*, p. 173 ff.

¹⁰ *FL* xxi. [1910] 177.

¹¹ Frazer, *GB*², pt. v., London, 1912, i. 240 f.

¹² Ovid, *Fasti*, ii. 425 ff.

¹³ *Popol Vuh*, ed. B. de Bourbourg, Paris, 1861, p. 91 f.; A. Landes, *Contes et légendes annam.*, Saigon, 1886.

¹⁴ 'Inst. of Viṣṇu,' *SBE* vii. [1900] 198; 'Śatapatha Brāhmaṇa,' *SBE* xii. [1882] 865; 'Manu,' *SBE* xxv. [1886] 40 f. For other sacred divisions, see *SBE* xiv. [1882] 166, etc.

of hands. The parts of the body sacred to other gods are touched with the sacred fingers—an act gratifying to the deities.¹

The Teutons had similar ideas, for the space between the thumb and forefinger was called *Woodenspanne*, while the thumb was sacred.² The index finger was used by the Romans and other peoples as that by which the gods and people were saluted with a kiss or otherwise; hence, perhaps, it was called *salutaris digitus*.³ The touching of a fetish with the forefinger by a chief is found among some African tribes.⁴ Jews touch the *m'zūzāh* with the forefinger on entering the house or leaving it. In the ritual of the Church various rites are performed with the thumb—e.g. anointing and signing with the Cross in baptism. In later Jewish belief each of the fingers of God's right hand has a special function.⁵ For the universal use of the hand, especially the right hand, in ordeals of water or fire, see ORDEALS.

The custom of wearing jewels on the hand (e.g. in rings), though now mainly decorative, probably arose out of magical reasons. The jewels were amulets by which the hand would be protected. Occasionally, amulets are bound about the hand or wrist.⁶ For similar reasons, or in order to sanctify the hands of certain persons, they are sometimes anointed. This ceremony is found in early Gallican ordinals—bishops, priests, and sometimes deacons having their hands thus consecrated; and this is still continued in the Roman Catholic Church.⁷ Where tatuing is practised, the hands are sometimes tatued; and this, while it may have some other purpose now, doubtless was once regarded as a magical protective.

Tatuing the hands with special marks is practised by the Eskimos⁸ and by modern Egyptian women, both Muhammadan and Christian, the latter using the cross symbol.⁹ These marks often have a religious significance among the Arabs.¹⁰ This is an old Semitic custom—marking the name or sign of a god on the hand, either as a token of being his or as a protective (cf. Is 44⁵ 49¹⁶, Rev 13¹⁶ 20⁴; cf. also HZAB, § 7 f.). Among the Zuñis, part of the ceremony of initiation into the *Ko'tiki* consists in touching the hands with certain *sacra* and asperging them with flour.¹¹ The Ewe touch the hands five times with pieces of the first-fruits of the yams at the yam custom.¹²

It is perhaps this idea of the sacredness of the hand which has made kissing the hand of a person a token of respect, as, e.g., among the Arabs and other Orientals, Tongans, and in modern European custom.¹³ Kissing the hands of images of the gods was an act of worship, and kissing one's own hand to a person or to a divinity has doubtless the same signification of respect or worship (see § 6 (a), (b)).¹⁴

Hand-like marks on rocks, walls, etc., are often regarded as the impression of the hand of a giant, the devil, or some other mythical being. Thunderbolts are called *Teufelsfinger* in Germany; and many plants, because of the form of their leaves, flowers, roots, etc., are called 'God's hand,' 'Mary's hand,' 'devil's hand,' and the like.¹⁵

3. Laying on of hands.—As the hand is the principal organ of touch, contact with it is often regarded as an important means of transmitting the qualities or powers inherent in the person who

¹ Monier-Williams, *Brāhmanism and Hindūism*⁴, London, 1891, p. 405.

² Grimm, 160.

³ Suet. *Aug.* 80; Mart. i. 22; Praetorius, *de Pollice*, 147.

⁴ H. M. Stanley, *Through the Dark Continent*, London, 1878, i. 327.

⁵ *JE*, s.v. 'Hand.'

⁶ W. R. Smith², 453; Skeat-Blagden, *Pagan Races of the Malay Peninsula*, London, 1906, ii. 328; W. E. Marshall, *A Phrenologist amongst the Todas*, London, 1873, p. 49; R. C. Thompson, 165.

⁷ Duchesne, *Christian Worship*⁴, London, 1912, p. 370 ff.

⁸ F. Boas, *RBEW* [1888], p. 561.

⁹ Lane, i. 67, iii. 175. Dyeing the hands with henna is also practised (i. 63, 221, iii. 171).

¹⁰ W. M. Thomson, *The Land and the Book*, London, 1859, p. 66

¹¹ A. van Gennep, *Les Rites de passage*, Paris, 1909, p. 113.

¹² J. Spieth, *Die Ewe-Stämme*, Berlin, 1906, p. 304 f.

¹³ Lane, ii. 9; J. Malcolm, *Hist. of Persia*, London, 1815, p. W. Mariner, *Tonga*³, London, 1827, i. 227; cf. Sir 29⁵.

¹⁴ H. Spencer, *Ceremonial Institutions*, London, 1879, p. 122 f.

¹⁵ See Grimm, 179, 218, 241, 1014, 1022, 1029.

touches another, just as the mere lifting up of the hand over a person in blessing causes a *rapport*, even without actual contact. The well-known emotional or psychic states often produced by touch doubtless suggested the value of this more ritual use.

Conversely, it is through the hand that contact with sacred objects is often effected. The ancient Arabs on entering or leaving the house caressed the domestic god with the hand,¹ just as Jews touch the *m'azrah* with the finger. Similarly sacred stones, etc., were stroked with the hand, sometimes previously dipped in blood or oil (cf. the primitive meaning of 'anoint,' *נָסַח*, viz. 'to smear with the hand'). Suppliants touch or stroke the beard or garment of a superior, and at the procession of the *Mahmal* the crowd press forward to touch it with their hands.²

The hand is usually laid upon the head, because it is the noblest part of man, and because, as a possible spirit entry, power of a spiritual or magical kind would pass into it from the hand (see HEAD). Some examples from the lower culture may be given first. In Melanesia, where men are believed to possess more or less *mana*, one who possesses much of it will sometimes lay his hand on a boy's head to transmit some of it to him.³ In Samoa the priest laid his hand on and stroked the painful part of a patient's body, and recovery was supposed to follow.⁴ Touching for the cure of sickness is also used by the Dayaks.⁵ At the election of a king in Uganda the prince who is touched by the hand of the 'Keeper of the Princes' at once becomes king.⁶

Turning now to the higher races: among the Hindus, at the initiation of a Brāhman, his union with his teacher is identified with a marriage, and is symbolized by the teacher's hand being placed on the boy's shoulder.⁷ In Babylonia, healing or exorcizing was effected by laying the hand on the head of the sick man.⁸ In Egypt the blessing of the gods was supposed to be conveyed to a newly crowned king by their laying their hands on him, thus conferring the gift of a long life and a glorious reign. This is often depicted on the monuments.⁹ What was probably a usual practice in healing is also reflected in the myth of Isis, who laid her hands on a dead child and uttered spells, so that he lived.¹⁰ Teutonic legend and myth speak of the gods hallowing and blessing by laying on of hands.¹¹ Among the Arabs a holy person conveys a blessing by the touch of his hand, and healing certain sicknesses is also performed in the same way by the shaikh.¹² In Tibet the Grand Lama at the ceremony of reception imparts his powers to people of high rank by laying his hands on their heads; inferior laymen have a cloth interposed between his hand and their heads; the lower classes are touched by a tassel which he holds in his hand.¹³

Among the Hebrews the custom of laying on of hands had various purposes. In the case of the scapegoat the hands of the priest were laid on it in order to transfer to it the guilt of sin (Lv 16²¹). The same rite was used with other sacrificial victims, and here the intention probably was to identify the offerer with the victim by physical contact (Ex 29^{10, 19}, Lv 1⁴ 3² 4⁴ 8²², Nu 8¹²). A similar custom belonged to the Egyptians.¹⁴ The same idea of identifying is seen in the laying on of

¹ W. R. Smith², 461.

² *Ib.* 205; Lane, iii. 121; cf. Mk 5²⁷.

³ E. H. Codrington, *JAI* x. [1881] 303.

⁴ G. Turner, *Samoa*, London, 1884, p. 49.

⁵ H. Ling Roth, *The Natives of Sarawak*, London, 1896, i. 83.

⁶ J. F. Cunningham, *Uganda and its Peoples*, London, 1905, p. 224.

⁷ Van Gennep, 249.

⁸ R. C. Thompson, p. xxiv.

⁹ Wilkinson, iii. 363.

¹⁰ Frazer, *Adonis*, London, 1906, p. 213.

¹¹ Grimm, 1385.

¹² W. R. Smith², 205; R. C. Thompson, 18.

¹³ L. A. Waddell, *The Buddhism of Tibet*, London, 1895, p. 321 f.

¹⁴ Wilkinson, ii. 458.

the hands of the congregation upon the Levites (Nu 8¹⁰). It is also the act accompanying words of blessing (Gn 48¹⁴), and it is used to transmit an office or to ordain. Moses thus ordains Joshua and puts some of his honour upon him (Nu 27^{18, 20}), and he is full of the spirit of wisdom because of this rite (Dt 34⁹). This rite of ordination (*smikhah*) was also used at the appointment of members of the Sanhedrin, but was discontinued, perhaps because it had become a Christian usage.¹ Laying on of hands for the purpose of healing was probably also in use, as Mk 5²³ 7³² ('lay thy hands on her,' 'they beseech him to lay his hand upon him') and Ac 9¹⁷ (Ananias lays his hands on the blind Saul) suggest. The waving of the prophet's hands over the affected place was expected by Naaman (2 K 5¹¹). The practice was used by Christ (Mk 8²³, Lk 4⁴⁰) and the Apostles and others (Ac 9^{12, 17} 28⁸, cf. Mk 16¹⁸) in healing.

The expression 'fill their hand' in reference to consecration to the priesthood (Ex 28⁴¹) has received various interpretations, but it probably is metaphorical, signifying installation to office (cf. Jg 17⁵; and a similar Assyrian phrase, *katā mullā*, 'to fill the hand,' to install into office²).

Used by Christ in benediction (Mk 10¹⁶; cf. Lk 24⁵⁰ 'lifted up his hands, and blessed them'), the laying on of hands for purposes of blessing has always been continued in the Christian Church, though the hands are often merely uplifted, as in benediction of a number of persons (§ 6 (c)). But for two other important rites the laying on of hands is used—Confirmation and Ordination. In Ac 8^{14, 19}, after baptism and prayer for the reception of the Holy Spirit, the Apostles lay their hands upon the baptized, who then receive the Holy Ghost—a spiritual unction—and also speak with tongues and prophesy. This, the rite of Confirmation, is probably the 'laying on of hands' referred to in He 6². It became a necessary part of Christian initiation; but, being connected with anointing, its place tended to be taken by the latter in some Churches (on this see CONFIRMATION). In the Churches of the Anglican Communion the laying on of hands is retained, and there is no anointing. Here also, as in the Roman Catholic Church, the bishop administers Confirmation. In the Eastern Churches it is often delegated to a priest, the oil being consecrated by the bishop. In the early Roman baptismal ritual the exorcism which preceded the ceremony was accompanied by laying on of hands by the exorcist and then by the priest on successive days.³

The special grace (*χάρισμα*) in ordination was also conferred by laying on of hands (Ac 6⁶ [the seven deacons], 1 Ti 4¹⁴ [the *πρεσβύτεροι* assist], 2 Ti 1⁶). Similarly St. Paul and St. Barnabas are 'separated' to their office by laying on of hands (Ac 13³). This practice became, therefore, a necessary part of the rite in all branches of the Church. At the consecration of bishops, bishops alone may lay on their hands, who must be not fewer than three in number—a rule dating from at least the 4th cent.—save where the Pope consecrates, though consecration by one bishop has occasionally been allowed. At the ordination of priests, the bishop lays on his hands, with the priests present. According to the *Syr. Didasc.* iv., a priest lays on hands, but does not ordain (*χειροθετεί, οὐ χειροτονεῖ*). The bishop alone performs the rite of ordaining deacons. The imposition constitutes the matter of the sacrament of Ordination, but since the 9th cent. the Roman Church has added the *traditio instrumentorum*.⁴ Laying on of hands is also used in benedictions, visitation of the sick, absolution,

¹ Hamburger, s.v. 'Ordinirung.'

² Delitzsch, *Assyr. HWB*, p. 409.

³ Duchesne, 299 ff.

⁴ See Martène, *de Ant. Eccl. Ritibus*, Venice, 1783; Bingham, *Antiq. of the Christian Church*, London, 1840, s.v. 'Ordination.'

and, in earlier times and in the Eastern Church still, at the unction in baptism.

4. The hand in healing rites.—Some of the instances in the preceding section have shown that the touch or stroke of the hand is an important factor in the healing of disease. Laying on the hand, touching, stroking, rubbing, and massage are all used in savage and barbaric medicine (see DISEASE AND MEDICINE). The power of the hand is wide-spread in European folk-belief, but it is only certain persons who are thus gifted—*e.g.* a seventh son or the seventh son of a seventh son. But—doubtless as a result of the power ascribed to medicine-men and priests, or to chiefs and kings, who often had powerful magic—monarchs or petty sovereigns, even within recent times, have been thought to possess healing in the touch of their hand (see FAITH-HEALING, KING'S EVIL).

5. The hand in magic.—(a) The hand, as the chief member of the body used in magical rites, is of great importance. It is that with which powerful amulets or wonder-working objects are held. Thus a Bab. spell runs:

'The circle of Ea is in my hand,
The tamarisk, the powerful weapon of Anu,
In my hand I hold,
The date-spathe, mighty in decision,
In my hand I hold.'

By the touch of a sorcerer or witch, even by pointing the hand or finger, much harm can be done through contact real or imaginary, as, conversely, the touch or pointing of one who wishes well or who is lucky works good. 'After me may a lucky finger be pointed,' are words occurring in another Bab. spell.¹ Hence certain gestures of the hand or fingers are all-important in magic, whether for good or evil purposes, and perhaps this is reflected in the story of Moses' uplifted hands at the battle with Amalek (Ex 17¹¹). The wave or the lifting up of the magician's hand can effect wonders. The uttering of spells is accompanied by various twistings of the fingers.² Claspings the hands may retard or stop some action; unclasping them causes it to be resumed.³ Or, again, articles with which magical rites are performed or divination is exercised must be held only by certain fingers. But it is mainly as a protective against the evil eye that the hand (or certain gestures made by it) is all-important. Of these the most common is the *mano cornuta*, in which the index and little fingers are extended to imitate horns, the others being bent over and clasped by the thumb. The hand is usually pointed towards the person who is feared. This gesture is both ancient and wide-spread in its use. It is represented in early Christian art as a gesture of the hand symbolizing the Deity.⁴ This figure thus combines the power of the hand with the magical virtues attributed to horns (*q.v.*). The hand clenched, with the thumb pointing downwards between the first and second fingers, the *mano in fico*, is another common gesture against the evil eye, as also of contempt or insult. It is not improbably a phallic gesture, the phallus being a powerful amulet against the evil eye. (See EVIL EYE.)

(b) A hand, usually with fingers extended, is often found on houses, temples, and buildings of all kinds, especially on or above the door, to avert the evil eye or other witchcraft, or to prevent the entrance of malicious beings. It is painted, or the impression of a hand dipped in blood is made on the surface. The range of this custom is very wide; it is found in ancient Babylon, Phœnicia,

¹ R. O. Thompson, p. xxiii.

² *Id.* p. xxiv.

³ Waddell, 141; R. O. Thompson, p. xxvi; Monier-Williams, *Brahmanism and Hinduism*, 406.

⁴ Grimm, 1666.

⁵ F. T. Elworthy, *The Evil Eye*, London, 1895, p. 260 ff.; cf. p. 267, where a Hindu deity making the horned gesture is figured.

Carthage, Egypt, Japan, and India, and is practised in the East by Jews and Muslims, while it is also found in Italy (see DOOR, vol. iv. p. 850^a and *reff.* there).¹ The ancient Hebrews set up memorials apparently bearing the name 'hand' (1 S 15¹², Is 56³ RVm). Probably they bore the impress of a hand, as did Phœnician votive stelæ, dedicated to Taanith and Baal-Hammon, and the purpose of the hand may have been apotropaic. The hand also occurs on some article of dress. Thus it is figured on the robe of a Mandan chief,² and a red hand was also borne by dancers at the sacred dances among the Dakotas, Winnebagoes, etc.³

For the same reason hand-shaped amulets, representing a variety of gestures, or holding some other protective, or covered with symbols, are in wide use against the power of the evil eye. They were probably worn in pre-historic times, and they are known to have been used by the Phœnicians, Greeks, Etruscans, and Romans, and in ancient Crete, as they are now in India, Austria, Italy, Spain, Portugal, etc.⁴

(c) The hands of the dead have also great importance in magic. There was a well-known custom of cutting off the hands, or right hand, or fingers of slain enemies and bringing them home as witnesses of the numbers slain or as trophies.⁵ This was done by the Egyptians⁶, the Hebrews (2 S 4¹², 2 Mac 15³⁰), and the Teutons,⁷ and was extremely common among the American Indians.⁸ The right hands of living prisoners⁹ or their thumbs (Jg 1^{6c}) were also cut off, the object being to spoil their prowess for ever. In the case of maiming the dead there may have been a similar idea of maiming their ghosts, since, where mutilation is a punishment, it is sometimes dreaded for its effects in the Other-world. At the same time, as a result of the well-known belief that the part influences the whole, or that any part of the human body gives the possessor of it power over the spirit, the mutilation may also have served this purpose, as in the case of cutting off the head (see HEAD). This would account for the fact that the American Indians held a dance round the trophies, and it is suggested by the fact that the Khonds hung up hands of enemies on trees in the villages.¹⁰ But it is also seen more explicitly in the custom of wearing the hands or fingers as medicine among the American Indians.¹¹ The same practice might be used in the case of any dead person, especially a relative or friend, for some specific purpose, the power of the dead still acting through the relic. Thus in West Africa a common component of the fetish-bag is a human hand; or finger nails or clippings are carefully preserved in memory of dead relatives, and are thought to be very efficacious.¹² The preservation of fingers and nails as relics is found in New Caledonia and other parts of Melanesia.¹³ In Mexico a common amulet favoured by warriors was the middle finger of the left hand of a woman dying in child-birth. (Such women had the same

¹ *FL* vi. [1895] 174, xv. [1904] 189.

² G. Catlin, *N. Amer. Indians*, London, 1842, i. 146.

³ J. G. Müller, *Amer. Urreligion*, Basel, 1855, p. 43.

⁴ Elworthy, *passim*; *ARW* viii. [1905] 523; *FL* xvii. [1906] 458, xix. [1908] 215 ff., xxi. [1910] 7, 268; R. O. Thompson, p. lxii.

⁵ For the custom of the living cutting off a finger or hand in funerary rites, see AUSTERITIES, § 7 (2); and MUTILATION.

⁶ Wilkinson, i. 265.

⁷ Grimm, 240. ⁸ *NR* i. 380, 581.

⁹ M. W. Duncker, *Hist. of Antiquity*, Eng. tr., London, 1877-82, i. 174.

¹⁰ Macpherson, *Report upon the Khonds*, Calcutta, 1842, p. 57.

¹¹ J. G. Bourke, *9 RBEW* [1892], pp. 482, 486.

¹² M. H. Kingsley, *Travels in West Africa*, London, 1897, pp. 273 f., 444; R. H. Nassau, *Fetichism in W. Africa*, London, 1904, pp. 111, 159; H. Johnston, *George Grenfell*, London, 1906, ii. 655.

¹³ Turner, *Samoa*, pp. 239, 342; C. Seligmann, *Melanesians of Br. N. Guinea*, Cambridge, 1910, pp. 719, 725.

future abode as warriors.¹) The dead hand as a healing charm is also referred to by Pliny.²

Muhammadian women in Egypt wore the dried finger of a Jew or Christian as a cure for ague.³ In European folk-custom similar usages are found. In Italy three joints of the ring-finger of an assassin are reduced to powder, mixed with a liquid, and sprinkled on the road between a lover's house and his sweetheart's, in order to bring back her affections.⁴ In Ireland the hand of a dead man stolen from a churchyard gives the thief power to abstract butter from his neighbours as long as he keeps it in his house.⁵ The hand of an unbaptized infant disinterred in the name of the devil is also a powerful charm.⁶ The left hand of a dead man dipped in the milk-pail causes the production of very rich cream. Both in Ireland and in Cornwall there was a belief that the touch of a dead hand healed certain maladies.⁷ In Germany the possession of the hand or thumb of a thief was believed to give its owner great magic power. A hanged man's finger hung in the beer-cask caused the beer to sell fast.⁸ Witches were also commonly believed to make their magic salve or powder from the fingers of disinterred children.⁹ These modern survivals are probably based on the earlier animistic beliefs regarding the relics of the dead referred to above. An interesting aspect of them is found in the so-called 'Hand of Glory,' or *Diebskerze*. In the Middle Ages the dried finger or thumb of a newly-born child, anointed with grease and ignited, was believed to make a thief invisible, and to cause a profound sleep to fall upon all in the house which he entered. The mere laying of such a finger on a table caused them to continue in sleep while the thief went on with his nefarious work. In the 17th cent. thieves sometimes murdered pregnant women in order to obtain the unborn child's finger. The hand or finger of a dead unbaptized child had a like efficacy.¹⁰ A similar superstition regarding the use of the left hand and arm of a woman who had died in her first childbed obtained in Mexico.¹¹ The dried and pickled hand of a dead man, especially of a criminal, anointed with unguent and ignited, or a dead hand in which a candle made of human fat was placed, had similar magical powers; but, if any one remained awake in the house, the thumb could not be ignited.¹² On this superstition a number of folk-tales have been founded.¹³ It should be observed, however, that other objects have the same properties and are so used among other peoples.¹⁴

Where the dead are eaten for magical purposes, their hands are supposed to strengthen those of the eater (*Dayaks*¹⁵; *Australians*¹⁶); and in New Caledonia they were tit-bits reserved for the priests.¹⁷ Among the Mangeromas, an Amazon tribe, the palms of the hands are a special delicacy.¹⁸

(d) Magical omens are often drawn from the hands, especially from their itching. In the West Highlands, if the right hand itches, money will be re-

¹ *NR* iii. 364.

² *HN* xxviii. 4.

³ Lane, ii. 79.

⁴ *FL* viii. [1897] 4.

⁵ *FLR* v. [1882] 81.

⁶ J. F. S. Wilde, *Ancient Legends*, London, 1887, p. 82.

⁷ Wilde, 82; *FLJ* v. [1887] 204; G. L. Gomme, *Ethnol. in Folklore*, London, 1892, p. 114.

⁸ Grimm, 1138, 1337, 1824.

⁹ Brand, *Pop. Ant.*, London, 1870, iii. 10; Grimm, 1073.

¹⁰ A. Wuttke, *Der deutsche Volksaberglaube der Gegenwart*, Berlin, 1900, p. 134; Grimm, 1073, 1625.

¹¹ J. de Torquemada, *La Monarquía indiana*, Madrid, 1723, bk. xiv. ch. 227.

¹² F. Grose, *Provincial Glossary with a Coll. of Local Proverbs and Popular Superstitions*, London, 1811.

¹³ E. Cosquin, *Contes pop. de Lorraine*, Paris, n.d., i. 178 ff.; B. Thorpe, *Northern Mythology*, London, 1851-52, iii. 274; *FLR* iii. [1831] 297; cf. also Scott, *The Antiquary*, ch. 17; Southey, *Thalaba*, 27; R. H. Barham, *Ingoldsby Legends*, London, 1840-47, 'The Nurse's Story.'

¹⁴ See J. G. Frazer, *Kingship*, London, 1905, p. 67.

¹⁵ Ling Roth, ii. 221.

¹⁶ A. W. Howitt, *Nat. Tribes of S. E. Aust.*, London, 1904, p. 752.

¹⁷ Turner, *Samoa*, 344.

¹⁸ A. Lange, *In the Amazon Jungle*, New York, 1912, pp. 349, 359.

ceived; if the left, money will be given away. An itching right palm means blessing from a stranger, while an itching in the left hand signifies that one will receive a gift of money.¹ In Germany and Norway it was thought that, if the right hand itched, you would part with money; if the left, you would receive it.² In Cairo it is thought that, if the right hand itches, luck will follow; but, if the left hand, ill-luck.³ Similarly the negroes of Jamaica believe that, if the right hand itches, you will get money; if the left, you will spend it.⁴ Other omens may be illustrated by the following examples:

It is a Jewish belief that any one who, on the night of *Hoshana Rabbah*, in trying to read his fortune from his shadow, does not see his right hand, will lose a son during the year. If he does not see his left hand, he will lose a daughter; if his finger, a friend.⁵ In China, if a child has fat hands, it is a sign of future wealth.⁶ In Norway, if a flea jumps on the hand, the person will be sought by a good friend.⁷ Omens are also universally drawn from the appearance of various animals on the right hand or on the left—the former being usually lucky, the latter unlucky.⁸

(e) One form of 'skrying,' or crystal-gazing, is to gaze into ink poured into the open palm⁹ (see art. *CRYSTAL-GAZING*, in vol. iv. p. 352^b). The so-called science of cheiromancy or palmistry, the reading of the past or future from the lines of the hands, has always found many credulous believers both in ancient and in modern times.

6. Gestures.—(a) As a means of communication or of emphasizing speech, gestures of the hand as well as the use of fingers or hands in betokening numbers have been universally employed; but perhaps nowhere has 'sign language' been more cultivated than among the American Indian tribes. Cheiromancy was extensively used by both Greeks and Romans, and it is much practised in modern Italy.¹⁰ Many gestures, whether actually used or represented in art, are universally understood—hand or finger to mouth=silence; wringing the hands=grief; the clenched fist=anger; the hand to the cheek or leaning the face on the hand=sadness or grief.¹¹ Hence it is natural that, where speech is directed to magical or religious purposes, in spell or prayer, it is usually accompanied by gestures, some of which tend to become conventional. Pointing with the finger is often held to be of magical efficacy, the power streaming, as it were, from operator to victim. This gesture is found among savages, mediæval witches, and in later Tantrism.¹² Hence it is indecorous to point with the finger towards, e.g., the heavenly bodies or other worshipful objects, or at friends or superiors.¹³ Other magical uses of the hand have already been referred to.

(b) In prayer or adoration no gesture is more common than the lifting up of the hands, which are usually open. It is the gesture of appeal, a kind of acted prayer. In Tonga, people cut off a finger-joint to propitiate the gods, and, holding up their hands, confess that they have done wrong.¹⁴ The people of the Congo, in speaking to a superior, stretch out their hands towards him, the attitude being precisely that of prayer.¹⁵ This was also the usual attitude of prayer in Egypt, represented so often on the monuments, and referred to in a text which says: 'The hands of men and gods are lifted on high seeking for thee, even as those of a child [are stretched out] after his mother.' Osiris is also

¹ J. Napier, *Folklore or Superstitious Beliefs of the W. of Scotland*, Paisley, 1879, p. 137; *FL* xiii. [1902] 50.

² Grimm, 1117f.; F. Liebrecht, *Zur Volkskunde*, Heilbronn, 1879, p. 327.

³ *FL* xi. [1900] 381.

⁴ *Ib.* xv. [1904] 93.

⁵ J. Buxtorf, *Synag. Judaica*, Basel, 1603, p. 464.

⁶ *FLJ* v. 123.

⁷ Liebrecht, 329.

⁸ Pliny, *HN* xxx. 10; Grimm, 1128, 1132; Dio Cassius, lxi. 6.

⁹ Lane, ii. 91.

¹⁰ See G. Mallory, 1 *RBEW* [1881], p. 269; E. B. Tylor, *Early Hist. of Mankind*, London, 1870, p. 77 ff., *PC* i. 240 ff.; Jorio, *Mimica degli antichi*, Naples, 1837.

¹¹ Cf. Dante, *Purg.* viii. 107 f.

¹² Waddell, 337.

¹³ Codrington, *JAI* x. 301 f.; Liebrecht, 341; Grimm, 732 f.

¹⁴ A. E. Crawley, *Mystic Rose*, London, 1902, p. 227.

¹⁵ A. Bastian, *Afrikanische Reisen*, Bremen, 1859, p. 143.

referred to as 'god of the lifted hand.'¹ A similar attitude was used in Babylonia and Assyria, and one collection of prayers bears the name of 'Prayers for the lifting up of the hand.'² Both Greeks and Romans used this gesture in prayer (*submittere manus, manus ad caelum tollit*), the latter also first raising the hand to the mouth (kissing the hand) and making a complete turn to the right. The hands were turned down or touched or beat the earth in praying to gods of the under world.³ The most usual Hebrew attitude in prayer, repeatedly referred to in the OT, was that of lifting up or spreading forth the hands towards the holy place or towards heaven (e.g. Ps 28² 134², Is 1¹⁶, 1 K 8²²). This attitude also became usual among Christians from the earliest times—arms raised and hands extended (cf. 1 Ti 2⁸ 'lifting up holy hands'; 'stretch forth your hands to God'⁴). The arms were sometimes stretched in the form of a cross, to represent the Passion.⁵ Origen says that the lifting up of the hands symbolized the lifting up of the heart to God.⁶ The attitude is frequently represented in early Christian art (cf. the figures of the Oranti in the Catacombs).⁷ Holding out the hands horizontally is also a Buddhist attitude in prayer.⁸ Muhammadans, while using several positions and gestures of the hands in prayer, begin by raising the open hands on each side of the face, the tips of the thumbs touching the lobes of the ears; later gestures are to place the right or the left hand in front of the body, to hold the hands open before the body and to look at the palms, then to draw them over the face, and, at the conclusion of the prayer, to extend the hands in supplication.⁹

Many other gestures are used in prayer. In Mexico the worshipper stood touching the ground with the right hand, which was then carried to the mouth; in Peru he opened his hand and threw kisses to the sun.¹⁰ In Egypt the hand was sometimes put to the breast, or over the mouth, or both hands were brought to the level of the knees as the worshipper bowed.¹¹ Beating the breast was and is a sign of great contrition (Lk 18¹⁸ 23⁴⁸), and the OT also refers to bowing to the earth and placing the head between the knees (1 K 18⁴²). Kneeling and bowing with hands spread out on the ground or on the knees is also a Muhammadan gesture,¹² and the custom of folding the hands is common among Christians, and is also used as a devotional attitude among Buddhists.¹³

(c) In individual *benedictions* the gesture is that of the laying on of hands (Gn 48¹⁸, 14, Mt 19¹³), but in more general benedictions it is that of the raised and open hand or hands, as if to project the blessing forward upon the person or object blessed. Already in the OT this gesture is found (Lv 9²²), and we find our Lord raising His hands (Lk 24⁵⁰). The later Jewish method was to join the extended fore and middle fingers and the fourth and little fingers, the thumb remaining apart. The hands were then held up with tips of the thumbs and forefingers touching. The 'lattice' of Ca 2⁹ was interpreted of this position and division of the fingers.¹⁴

¹ Wilkinson, iii. 425; E. A. W. Budge, *Osiris and the Egypt. Resurrection*, London, 1911, ii. 45, 47.

² L. W. King, *Bab. Magic and Sorcery*, London, 1890, p. xli.; Perrot-Chapiez, iv. 542 f.

³ Macrobius, iii. 9, 12; Homer, *Iliad*, vii. 176 ff.; Pliny, *HN* xiv. 2; pseudo-Arist. *de Mundo*, vi. 276; *Esch. Prom.* 1006.

⁴ Clem. 1 *Ep. ad Cor.* cap. 2.

⁵ Tert. *Orat.* 14; Minuc. Felix, *Dial.* 90.

⁶ *On Prayer*; cf. the comment of Chrysostom on Ps 140.

⁷ H. Leclercq, *Manuel d'arch. chrét.*, Paris, 1907, I. 155; W. Lowrie, *Christian Art and Archaeology*, New York and London, 1901, p. 201 ff.

⁸ Waddell, 427.

⁹ Lane, i. 111 f., 121; Hughes, *DI*, p. 466.

¹⁰ Müller, 641, 884.

¹¹ Lane, i. 111.

¹² *Peñita Zuzarti* on Nu 6^{34c}.

¹³ Wilkinson, iii. 425.

¹⁴ Waddell, 427.

Both lifting and laying on of hands were and still are used in the Christian Church for individual and general benedictions, but in the latter the position of the fingers has been regarded as of some importance, and a symbolic interpretation has been given to it, while the blessing is always bestowed with the right hand. From comparatively early times in the Eastern Church the gesture has been that of the extended hand with the thumb joined or crossing the third finger, the other fingers open, or the second and fourth slightly bent. Among the mystic interpretations given, one is that the first and second fingers form the initial and final letters of *Ἰησοῦς*, and the thumb crossed on the third finger and the bent fourth finger form the initial and final letters of *Χριστός*.¹ The Western form of benediction is, for a deacon or a priest, the extended hand; for bishops, the thumb and first and second fingers raised, the others resting on the palm. This was at an earlier period the form used by priests also. The three upraised fingers signify the Trinity, the two closed fingers the two natures of Christ. These positions of the hand are met with in early Christian art, and occasionally others are depicted—thumb and first finger or first and second fingers or four fingers raised. The sign of the cross is made in all such benedictions. The Western gesture is the form taken by some pre-Christian amulets against the evil eye, and it is also one of commanding attention.² In Buddhism the hand upraised, open, with fingers pointing upwards, signifies blessing.³

The position of the fingers in signing oneself or any object with the sign of the cross is important and is mystically interpreted—five fingers outstretched signify the five wounds, three the Trinity, etc. At the Eucharist the cross is symbolized by the elevation of the celebrant's hands.⁴

(d) In *taking an oath* the position of the hand is of importance. It is placed upon some sacred object, the idea probably being that the power of the object will do harm to the person if he breaks the oath. This custom is found in Samoa (hand on sacred cup or stone),⁵ among the Hebrews (hand on generative organs, though here the oath partakes of a covenant [Gn 24², cf. 47²⁹]), among modern Jews (hand on roll of Torah or on page with the Decalogue), and among Muhammadans (hand on Qur'ān).⁶ Again, the hand is raised, as if calling the gods or God to witness the oath—a custom found among the Greeks,⁷ Teutons,⁸ Hebrews (Gn 14²², Dn 12⁷; cf. Rev 10⁵, 6; hence 'to lift the hand' signifies 'to take an oath' [Ex 6⁸, Ps 106²⁶, etc.]), modern Jews, and generally in Christian usage, as in judicial oath-taking in Scotland. Shaking hands is sometimes used to confirm an oath or covenant, or as witness of a pledge (cf. 2 K 10¹⁶, Ezk 17¹⁸, Pr 6¹). To avoid the necessity of keeping an oath and to escape the consequences, certain gestures of the left hand or of the oath-taking right hand are used in folk-custom.⁹

(e) The gestures or position of the hands in *representations of divinities* are often of importance, and reflect those already referred to. Or they hold various sacred objects, symbols, and the like. This is especially noticeable in early and later Christian representative or symbolic art, where our Lord or another Person of the Trinity holds His hand in the attitude and gesture of benediction. In Northern Buddhist art there are many recognized positions of the hands given to representations of Buddha and Buddhistic saints, each with its appropriate name, e.g. the 'meditative posture'—one hand resting on the other, palms upwards; the

¹ Didron, i. 407.

² Elworthy, 298; J. A. Martigny, *Dict. des ant. chrét.*, Paris 1865, p. 84.

³ Waddell, 337.

⁴ Turner, 19, 184.

⁵ *Fl.* xix. 254 f.

⁶ See *ARW* xii. [1909] 53 ff.

⁷ Cyprian, *de Cæna Domini*.

⁸ Lane, i. 156.

⁹ Grimm, 704, 1623.

'best perfection'—the index finger and thumb of each hand joined and held towards the breast; 'turning the wheel of the law'—the right index finger turning down the fingers of the left hand; that of the necromantic pointing finger, etc.¹

7. Hand-shaking.—This is a general mode of salutation even among such low savages as the Australians,² now more, now less, ceremonious,³ and an obvious expression of sympathy by means of contact. But it has also been a very common method of clinching a bargain, expressing a covenant,⁴ and the like, each of the two persons thus giving himself over into the possession of the other by contact, and so having a hold over him. This custom was prevalent among the Romans, Greeks, Hebrews, and most other peoples of antiquity, as it is with most modern races. The hand is struck into that of the other person, hence the phrase 'striking a bargain'; and in some popular usages, if this hand-shaking does not take place after a bargain, the bargain is null. The hand-shaking is even more effective when each spits into his hand before 'striking,' or when, as among the Iberians, Goths, and in the Highlands, the ball of the thumb is moistened and the parties press thumbs.⁵ Hence, also, clasping the hands is one of the most important parts of the ritual of marriage, not only among Christian races, as set forth in the Church rituals, but also among many savage and barbaric folk, and is already found in the Rigveda (x. 85. 36). The ceremony is at once a pledge and a symbol of the union which will later be consummated.⁶ In various religious or magical ceremonies, in which several persons are engaged, they sometimes join hands, probably by way of giving expression to the solidarity of the rite.⁷

8. Washing of hands.—(a) The obvious effect of water in removing dirt from the body, as well as the universal ideas regarding the sacredness of water or its being the seat of a spirit or divinity, suggested that other kinds of uncleanness—that of a tabu state, of guilt, and the like—might also be removed by washing. And, as the hands were the main parts of the body by which uncleanness through contact arose, or were a possible entry to the body for demons (as in the Hindu belief regarding *bhūts* ⁸), their ceremonial washing has everywhere had great importance. Indeed, with many peoples all washing of hands is more or less ceremonial.

Contact of the hands with any thing or person unclean or dangerous produces a tabu state, and no food must be touched with the hands while it lasts, because the uncleanness or contagion would pass over to the food, and so into the body. This is common in the lower culture, e.g. in Polynesia; and it is illustrated by a Yoruba story of a son who went to Hades to see his dead mother and would have touched her had she not forbidden him, saying that, if he did, the road to the upper world would be closed to him.⁹

Among the Greeks the danger of unwashed hands is illustrated by the story of Asterius, who, having approached the altar of Zeus with unclean hands, was struck dead; while no one could go beyond the *περὶ πύργου* until he had washed his hands.¹⁰ The Romans had a similar belief, and no one with hands stained with crime would touch sacred things. They must be washed first in a living stream.¹¹ The Jewish belief that to touch eye, nose, ear, etc.,

¹ Waddell, 336 f.; see also Grimm, 115 note.

² E. M. Curr, *Aust. Race*, London, 1886-87, i. 343.

³ See Lane, ii. 10. ⁴ Westermarck, *MI* ii. 623.

⁵ J. Aubrey, *Remaines*, ed. London, 1831, pp. 56, 129, 132; Napier, 100; B. Chambers, *Book of Days*, Edinburgh, 1863, i. 359; *FLR* iv. [1881] 103.

⁶ Crawley, *Mystic Rose*, 373, 381; Corso, 'Gli Sponsali popolari,' *Rev. des études ethnog. et sociol.*, 1908; Lane, i. 213; cf. *FL* i. [1890] 426, 456.

⁷ Cf. Frazer, *GB*³, pt. v. l. 96, 186. On this subject see Tylor, 'Salutations,' in *EBR*¹¹; Ling Roth, *JAI* xix. 166 ff.

⁸ Crooke, *PR*², London, 1896, i. 241 f.

⁹ A. B. Ellis, *Yoruba-Speaking Peoples*, London, 1894, p. 188 ff.

¹⁰ J. Potter, *Archæol. Græca*, Edinburgh, 1832, i. 262.

¹¹ Verg. *Æn.* ii. 717 ff.; cf. Ovid, *Fasti*, ii. 45.

with unwashed hands was highly dangerous (these being the openings by which a demon might enter) also illustrates this.

In Babylonia, washing the hands, besides the rest of the body in pure spring water is specially mentioned as a symbolic ceremony for ridding one of the power of evil spirits.¹

(b) Ceremonial washing of hands takes place before religious or magical acts. It is frequently used before *prayer*, and this is best illustrated from Muhammadan usage. The Muslim must wash his hands before prayer or before touching the Qur'ān: 'When ye prepare yourselves for prayer, wash your faces and hands up to the elbows' (v. 8, lvi. 78). This washing is done three times—first the right, then the left hand and arm. When washing the right hand, he says these words: 'O my God, on the day of judgment, place the book of my actions in my right hand, and examine my account with favour'; and, while washing the left: 'Place not at the resurrection the book of my actions in my left hand.'² The Jews are also careful to wash their hands before prayer, the custom being deduced by the Rabbis from various passages in the OT, where there is no direct reference to the custom. The Hindu usage at the *Brahmā-Yajña* service may be referred to, though here there is rather an offering of water to the *Pitris*, that they may be refreshed and their hands washed. Water is taken in the right hand and poured over the straightened fingers, and at a later stage it is offered so as to pour over the side of the palm between the root of the thumb and forefinger, the 'father's space' (*Pitritīrtha*), and again so as to pour over the opposite side of the palm.³

(c) Washing of the hands before *sacrifice* is also a very wide-spread practice. In Egypt the ritual washing of the priests before offering sacrifice included the whole body, though stress was laid upon the hands. Hence the name of the priests—*ūibū*, 'the washed,' or *ūibū totūi*, 'the clean of both hands.' In heaven the gods washed their hands in the laver before the door in heaven; and this act was performed on their images.⁴ Similar customs prevailed in Babylonia, where the *barū* must wash and be ritually pure before approaching the gods. Here also this was reflected back upon the gods, who, as well as worshippers, must cleanse their hands before taking part in the sacrificial banquet.⁵

In Greek and Roman sacrificial ritual the purity of the hands by washing in lustral water was insisted on, and a vase of water for this purpose stood at the entrance of the temples.⁶ Among the Hebrews the ritual law is quite explicit regarding the custom of washing hands before sacrificing (cf. Ex 30¹⁹ 40³¹). The ecclesiastical usage of ablution of hands in the Christian Church before or during the celebration of the Eucharist may also be referred to in this connexion. It is ordered in the early liturgies and has remained a constant custom since.⁷

(d) Before many rites of a *magical* kind the washing of hands is also customary. In Greece at the *ἀμφιδρόμια* the midwives had to wash their hands before running round the fire with the infant.⁸ Before touching seeds at planting, women of the Lower Congo region must wash their hands lest the crop be destroyed.⁹ Among the Romans, at the

¹ M. Jastrow, *Aspects of Rel. Belief and Practices in Bab. and Assy.*, New York, 1911, p. 306.

² Lane, i. 101; Hughes, *DI*, p. 3.

³ *SBE* xii. 365; Monier-Williams, 409, 415; see above, § 2.

⁴ G. Maspero, *The Dawn of Civilization*, Eng. tr., London, 1894, p. 123; G. Foucart, *Hist. des rel.*, Paris, 1912, p. 412; Budge, *Osiris and the Egyp. Resurrection*, ii. 5, 361; Herod. ii. 37.

⁵ Jastrow, 165; Maspero, 680. For the ritual washing of the hands of images, see Ball, *PSBA* xiv. 160 f.

⁶ Cf. *Il.* i. 449, vi. 263 ff., ix. 173 ff., xxiv. 300 ff.; Hesiod, *Works and Days*, 732.

⁷ Cf. Duchesne, 60, 175.

⁸ Potter, ii. 322.

⁹ J. H. Weeks, *FL* xx. [1909] 311.

Lemuria, the paterfamilias had to wash his hands thrice in spring water as part of the ritual against the ghosts.¹ Among the Assyrians and Babylonians unwashed hands in magic rites were unlucky.² In modern folk-custom the practice has survived.³ A curious custom is that of washing the hands in the water of a river before crossing a ford. This is found among various savage tribes, and is already referred to by Hesiod.⁴ It may be regarded as a species of inoculation against the dangers of the river or the spirits dwelling in it.

(e) Washing the hands is also a recognized method of *carrying away evil* of all kinds. Thus in Assyria a spell runs: 'May evil be carried off with the washings of his hands!'⁵ Among the Hebrews and modern Jews the same idea is also found, and the hands must be washed after all 'unclean' bodily functions or after touching any one who is unclean, or to remove the contagion of death or murder (see, e.g., Lv 15¹¹, Dt 21⁶).⁶ Washing has also the effect of averting misfortune.⁷

Not only impure but sacred objects, i.e. objects which must be approached carefully, cause uncleanness. Thus a Jewish belief is that the hands must be washed after touching the Scriptures—the sacredness or danger cleaving to the hands being thus removed.⁸ See art. BIBLES, vol. ii. p. 571^a.

(f) Washing the hands, or clean hands, thus became a *sign of innocence*, meaning that one had thus washed off all possibility of guilt; and the custom gave rise to the metaphor of 'clean hands' as signifying innocence (cf. Ps 18²⁰ 24⁴, Mt 27²⁴). In Cornwall, washing the hands was used as a token of innocence with regard to any crime.⁹ Cf. the common phrase used with regard to responsibility towards another person, 'I wash my hands of you'; or the metaphor about a person's hands not being clean, as meaning his dishonesty, etc.

A curious superstition in Scotland, England, and Ireland was that a child's right arm and hand should be kept unchristened, so that it might strike a more deadly blow; or unwashed immediately after birth, so that its luck might not be washed away.¹⁰

9. **Veiling the hands.**—Probably because of possible danger from unclean hands they are sometimes veiled in the performance of ritual or as a token of respect. During the Roman sacrifices to Fides in the Capitol the flamens' hands were wrapped, up to the fingers, in white.¹¹ A fillet was also worn on the right hand by the Eleusinian *mystæ*.¹² As a mark of respect, hands were veiled before a superior. Traces of this are found in early Christian art. St. Peter receives his mission, or the keys, with his hands covered with the skirt of his cloak; and martyrs hold their crowns of glory on veiled hands. In the Roman Catholic Church, when Cardinals approach the Pope to do homage or receive the hat, their hands are veiled with part of their cape.¹³ Among Muhammadans it is usual to cover the hands in presence of a person of higher rank or when making a visit.¹⁴

10. **Clapping the hands** is a method of calling a servant in the East.¹⁵ Hence it also passes into a method of inviting a god or a spirit.¹⁶ It is also a method of salutation, especially among African tribes, or of expressing joy; or it may be used as a rhythmic accompaniment of song or music.¹⁷

¹ Ovid, *Fasti*, v. 435.

² R. C. Thompson, 120, 129.

³ Cf. Frazer, *Adonis*, 139, 147.

⁴ *Works and Days*, 737 ff.; cf. W. R. Halliday, *FL* xxi. 159.

⁵ R. C. Thompson, p. lii.

⁶ Cf. Turner, *Samoa*, 145 (hands of priest bathed with hot water after touching the dead).

⁷ Petrarch, *Epist.* i. 4.

⁸ W. R. Smith², 426.

⁹ *FLJ* v. 98.

¹⁰ Gomme, *Ethnol. in Folklore*, 180; Henderson, 16; W. Gregor, *Folk-lore of the N.E. of Scotland*, London, 1881, p. 7.

¹¹ W. Warde Fowler, *Roman Fest.*, London, 1869, p. 237.

¹² Libanius, *Decl.* 19.

¹³ Martigny, 383.

¹⁴ Lane, i. 58, ii. 12.

¹⁵ India, Egypt, etc. (*FL* vi. [1896] 405; Lane, ii. 12).

¹⁶ Panjab (*FL* vi. 405); Kochs (E. T. Dalton, *Descr. Ethnol.*, Calcutta, 1872, p. 91); Manganja of L. Nyassa (Tylor, *PC* ii. 368 f.).

¹⁷ Spencer, 116, 120, 135; Lane, i. 230.

Grimm also mentions it as a powerful charm in enchantments,¹ while it is often used as a means of scaring off demons by noise,² as it was to frighten away serpents in the sacred cavern at the *Thesmophoria*.

LITERATURE.—There is no special work on the whole subject. See the works referred to throughout the article.

J. A. MACCULLOCH.

HANDICRAFT.—I. **Definition.**—The term 'handicraft' may be defined as the constructive adaptation by man to his needs of the material presented by the environment. It will thus include, on the one hand, the provision of implements, weapons, utensils, clothing, shelter, the preparation of food, and the like, but will exclude, on the other hand, activities such as those by which food and raw material are provided—gathering of fruits and roots, the processes of agriculture, hunting, fishing, etc.—as well as self-defence and war, and other activities in which, although manual dexterity and co-ordination of bodily powers are requisite, the result is either not material or, if it is, is not produced by a structural or formal modification. A simple adaptation, such as the use of stones as missiles by apes or by man, will not come within this definition, while it is doubtful whether the psychological processes which underlie the operation of nest-building, even in the higher apes, would justify the application of the term to this form of activity. The case of the orang which applied a piece of iron or other material as a lever and utilized strands of wire-netting, which it untwisted, as a saw to break out of captivity (*Times*, 4th Nov. 1912) may possibly be described as on the psychological threshold of handicraft.

2. **Implements of stone, bone, and shell.**—The earliest undoubted examples of the products of man's technical skill are the stone implements of the Pleistocene period. Whether the implements known as *coliths* are actual specimens of man's early attempts to produce a tool to meet his requirements or are the results of natural forces is immaterial. It may be assumed that the earliest process of manufacture consisted of a rough chipping to increase the utility of a stone naturally suited in form to some particular purpose.

Implements as simple in form and showing in themselves as little signs of human workmanship as *coliths* have been recorded among primitive races in modern times. The Seri Indians use stones which have undergone no process of preparation as hammers or as weapons in hand-to-hand fighting (W. J. McGee, 'The Seri Indians,' 17 *RBEW*, pt. i. [1898] p. 9 ff.), while the Andaman Islanders use whetstones, chips, and flakes which have been split by simple pressure after heating in the fire (E. H. Man, 'On the Aboriginal Inhabitants of the Andaman Islands,' *JAI* xii. [1883] 380).

The implements of the river-drift gravels of Europe belong to a stage when man had already acquired considerable technical skill, while a marked increase in dexterity is shown in the smaller but more carefully formed, as well as more highly specialized, implements of the cave-dwellers. The favourable conditions of archaeological study in France and the employment of a detailed method of analysis and classification have made it possible to follow closely, in a series of known relations in time, this advance in skill, as well as in the process of specialization. The civilization of the Stone Ages in Europe thus offers material of the greatest value in tracing the gradual development of man's technical ability.

The Palæolithic Age has been divided into three stages—Lower, Middle, and Upper. In these stages the Mesvinian, Strepyan, Chellean, and Acheulean implements, so called from characteristic sites in France, belong to the Lower Palæolithic; Mousterian implements to the Middle; and Aurignacian, Solutrian, and Magdalenian to the Upper. Each group is still further subdivided by

¹ P. 1026 and note 1.

² Crooke, *PR*² i. 168.

French archaeologists. Through all the stages, from the simple flake of the Mesvinian gravels to the highly elaborate examples of the flint worker's art in the leaf-shaped implements of Solutré, there is a steady progression in specialization and adaptation to a particular purpose. In the Strepian stage the forms include coarsely flaked scrapers, knives, and the *boucher*, a pointed implement which has been described as 'not unlike in size and form two hands opposed palm to palm.' This implement—a natural form, a nodule of flint which has been worked, but not essentially modified—is still more characteristic of the Chellean stage, which also includes scrapers and a dagger form. In these implements the flaking was apparently produced by oblique blows with a pebble. The Chellean industry is of world-wide distribution, occurring in the river-gravels of France, England, and Belgium, in Italy, Spain, and Portugal, and throughout Africa, Arabia, Palestine, in the valleys of the Tigris and Euphrates, in India, and in some parts of Canada and the United States. In the Acheulean stage—a direct development of the Chellean—the chipping of the flint becomes finer, and the implements, especially the *boucher*, show a better edge. In the Mousterian age there is an increase in the variety of implements employed, as well as a marked improvement in the methods of workmanship. The *boucher* disappears, but its place is taken by the Levallois flake, a large implement with a rounded point, dressed on one side and then struck from the nodule with a single blow. Side-scrapers, end-scrapers, notched scrapers, and awls are characteristic of this period, in which man began to make use of caves for dwelling-places. In the Aurignacian stage of the Upper Palæolithic period, the improvement in the working of flint continued. New types of implements were made, including curved pointed flakes with secondary chippings, carinated scrapers and gravers' tools to meet the requirements of artistic development, which now found expression in ivory and bone carvings and engravings. The distinguishing feature of implements of this period is the secondary flaking known as the Aurignacian retouch. At this time a new material was introduced; awls of bone and ivory, and other implements, such as spear-heads and rods of ivory, appear. The working of flint reached the highest stage of development in the Solutrian age. Primitive arrow-heads of the earliest phase were succeeded by the implements known as willow-leaf and laurel-leaf points—flat and very thin implements with remarkably delicate secondary flakings of great regularity, probably produced, not by blows as in the earlier types, but by pressure.

The Australian aborigines produced extremely delicately flaked spear-heads, latterly made of bottle glass, by means of pressure, the implement used being a gouge-shaped tool made of a bone from the hind leg of a sheep (H. Balfour, 'On the Method employed by the Natives of N.W. Australia in the Manufacture of Glass Spear-heads,' *Man*, iii. [1903] 65). The Fijians and the Eskimos also produced fine flaking by pressure with a bone. The Apaches, after breaking a boulder by means of a pebble set in a withy handle, wrought the implement into shape with a sperm-whale tooth; Torquemada describes the making of obsidian knives by pressure with wood, the flakes being split off a block held between the feet (see J. Evans, *Ancient Stone Implements of Great Britain*², p. 23).

The Magdalenian period witnesses a decline in skill in flint-working. The implements become less elaborate, and are often lacking in finish. This is due largely to the employment of bone and horn, which, being easier to work, allow greater diversity of form and consequently a wider application in use. The simple spear-point develops into the harpoon with one barb, and later with two or more; arrow-heads and spear-heads show great variety in basal form, to permit of different methods of attachment to the shaft. Spear-throwers of bone or ivory are used, as well as the

bâton de commandement, an implement conjectured, on Eskimo analogy, to be an arrow-straightener. Bone pins, needles, and bodkins found in large numbers suggest an increased elaboration in dress. The culture of this period is frequently compared with that of the Eskimos, especially in view of the use of bone implements by the latter for both hunting and domestic purposes.

In the Neolithic Age in Europe, the great variety in the forms of implements and the purposes for which they were employed bear witness to a profound change in the mode of life by which this period of human development is broadly distinguished from that which preceded it. Although the rude stone implements of the kitchen middens of Denmark and elsewhere argue a civilization and a technical skill certainly below that of the cave-dweller in the later Palæolithic period, a knowledge of agriculture, the domestication of animals, weaving, and the use of clay vessels, for which evidence appears at a comparatively early stage in Neolithic civilization, demonstrate that a rapid multiplication of human needs was accompanied by a parallel increase in effective means to satisfy them. The characteristic industry of the period—the making of implements and weapons of stone—in essentials remains unaltered; progress is marked mainly by a greater variety in form and by specialization. An important development in technique, however,—the process of grinding and polishing—permitted the use of stones other than flint and chert.

In the earlier stages of the Palæolithic period, it is not possible always to classify any given implement as a weapon or tool. The same uncertainty exists in the case of the neoliths. Some of the rough axe-like tools may be either unfinished weapons or implements possibly for agricultural purposes. Nor does the lack of finish argue an early origin. The mauls and hammer-stones which were used to shape the great blocks of stone at Stonehenge were of the roughest description, although this monument was erected at the beginning of the Bronze Age. Arrow-heads and spear-heads admit of no doubt as to their purpose. In the case of the former, the method of attachment can be followed, as it develops, from the form with a square butt, through the barbed form fitting into a notch, to the fully developed tang which was fastened to the shaft. The stone celt or axe, perhaps the most characteristic of all stone implements of the period, can also be followed through a sequence of forms, from the coarsely chipped and roughly shaped implement to the well-balanced weapon, carefully ground all over and brought to an edge, which exhibits the highest point of development in this branch of Neolithic technique.

The usual method of hafting the celt was not by fastening it to a handle with sennit sinew or other form of string, as is done by most modern primitive races among whom stone implements are, or recently have been, in use, but by fixing the celt in a transverse hole in the handle. The tendency to split the handle was ingeniously overcome by the peoples of the Swiss Lake Villages, who fitted into the handle a socket of horn which took the force of the blow. At a later stage, perforated axe-heads appear, into the hole of which the handle was fitted. In Great Britain this implement may be referred to the Bronze Age. The hole was bored by a cylindrical drill, or in some cases by a hollow tube, possibly of elder wood.

The greater skill in technique and the multiplication in form and uses of stone implements which took place in the Neolithic Age are only one phase of a general advance in culture. But in the case of these implements the limits of development were fixed by the nature of the material; and neither among modern primitive races nor in pre-historic times was the technique of the Scandinavian daggers or the translucent blades of the Egyptian knives surpassed.

The Australians, like many other primitive races, when first encountered by Europeans, were in the Stone Age. The uses to which they put their implements and weapons and the methods of manufacture they employed, serve to throw light on the general character of the culture of pre-historic Europe, as well as on special points where the purpose of a particular implement is not clearly deducible from its form and character.

One of their most useful implements, principally as a tool, rarely as a weapon, was the axe, which was the product of a long process of chipping with a lump of quartz and pecking with a rounded pebble, and then of grinding upon the nardoo mills, the stones used for grinding seeds. It was mounted in a twisted withy, either as an axe or as an adze, and fixed in position with porcupine-grass resin. As an axe it was used for notching trees for climbing, cutting open trees, catching the opossum or taking honey, taking off sheets of bark from trees, shaping wood for shields, and the like. As an adze it hollowed out wooden vessels. A knife set in a haft was used as a pick; fragments of stone set in a handle of gum made a saw; stone hammers were made of unflaked pebbles set in a handle; pounders were employed for breaking hard seeds; stone drills were sometimes, though rarely, employed; and all kinds of flakes were used as scrapers. The last-named implements were sometimes made of teeth, which also furnished knives and drills. The Australian native made a considerable use of shells. They were employed in cutting hair or bark, for making adzes, in cicatrization, in working the opossum skin, and as drills; a kind of spoke-shave of shell was used for slicing nuts or any other fruit which had to be cut thin. Shells were also used to make fish hooks.

Their implements of bone included awls made from the leg-bone of the kangaroo, a stiletto or needle used by the women to pierce skins or the edges of the bark which they sewed into canoes, and for piercing the septum of the nose for the reception of ornaments (N. W. Thomas, *Natives of Australia*, London, 1906, p. 48 ff.).

Adzes of both shell and stone were used in Melanesia, the area of distribution being well-defined in each case. Stone was used in the Solomon Islands (except Rennell and Bellona) and the New Hebrides. Shell was used by the Santa Cruz people, Torres Islanders, and Banks Islanders. For cutting threads, shaving, and fine carving, obsidian, chert, and shark's teeth were used (Codrington, *The Melanesians*, Oxford, 1891, p. 313 ff.).

3. Metal-working.—The introduction of a new material on the discovery of metals (probably in Asia Minor, or in Egypt, whence their use spread to the Mediterranean and the rest of Europe) was necessary to render possible further development in this department of human activities. It has been assumed that the use of metals was first discovered by the accidental inclusion of copper ore among the stones used to build up the primitive hearth. While this theory, on the ground of its strong probability, holds the field, it is generally conceded that, in localities where circumstances were favourable, the Bronze Age was preceded by a Chalcolithic Age in which native copper was employed very much in the same way as stone, and adapted to use by being hammered into the shape required. The Indians of Lake Superior, where native copper abounded, and possibly the early inhabitants of the Mediterranean area, passed through such a stage of development. That a Copper Age generally preceded the Bronze Age proper is a matter upon which it is more difficult to obtain conclusive evidence. Not only would copper implements be melted down for use in making bronze, but, in most regions where copper is found, it is not sufficiently pure to produce anything but a bronze without a special process. In Ireland, and again in the Mediterranean area, implements occur which are sufficiently pure to warrant their being called copper.

Apart from the link afforded by the Chalcolithic period where it occurs, the connexion between the civilization of the Neolithic and early Bronze Ages is sufficiently apparent in the form of the implements themselves, especially of the celt. The early metal celt, notwithstanding the greater refinement and economy made possible by the

qualities of the material, is practically identical in form with the stone celts. The development from the flat celt, based upon the stone form, can be followed in all its stages—through the flanged and stopped forms, in which the flanges were made to fit over the curved handle, to the socketed form into which the handle fitted, and to which it was fastened by a string passed through the ring of the celt. The same essential identity in form can be traced in knives, spear-heads, daggers, and other implements in which stone was superseded by bronze. By the end of the Bronze Age, the art of working metal had attained a comparatively high degree of excellence; gold and, more rarely, silver were employed for ornament, and the adaptability of bronze for purposes other than those of implements and weapons had been discovered. It is probable that iron was first worked in the region south-east of the Euxine. In Europe it was possibly in the first instance disseminated from the Balkan peninsula, as a costly, almost a precious, metal to be used sparingly, later as the staple material for a wide variety of articles. When its use became general, the art of metal-working in Europe, especially as shown in the bronze mirrors, articles and ornaments for personal use, horse trappings, etc., frequently enriched with beautiful combinations of coloured enamel, began to pass from the stage when it could be classed as a primitive industry and to take its place as an element in a higher plane of culture. In Africa the Iron Age probably began at a very early date, owing to the abundance of the raw material, but the metal is still produced among the natives by smelting in a primitive form of low blast furnace, such as must have been in use in pre-historic Europe, of which the product is practically a wrought iron. This primitive form of furnace, consisting of a shaft or trough of clay with holes for the introduction of the blast, is still found in India, Borneo, Japan, and, in Europe, in Catalonia and Finland.

Over the larger part of Africa the production of iron is of great importance. It is worked in the Upper Nile valley among the Nilotic tribes (the Ja-Luo being noted smiths), among the Bantu tribes of East Africa, and the negro tribes of West Africa, where the swords and knives, which show great diversity of form, are especially remarkable as examples of native workmanship. The Mashona and other Makalanga tribes have been noted from time immemorial as workers of iron; the Zulus, however, do not appear to have practised the art to any great degree. In the Shiré Highlands at one time every village had its smelting-house, and smiths who made axes, spears, needles, arrow-heads, bracelets, anklets, hoes, two-edged and one-edged knives, and the like (A. Werner, *Natives of British Central Africa*, London, 1906, p. 201 ff.).

Before leaving the subject of metallurgy, reference should be made to the famous bronze castings of Benin. Casts, though of an inferior quality, are still made in this district, the *cire perdue* process being employed. Wax is modelled on a clay core and covered with a clay mould; when the mould is hard, the wax is melted and drained through a hole, and molten metal poured in (H. Balfour, 'Modern Brass-casting in West Africa,' *JRAI* xl. [1910] 525-528). The Malays use this method in making hollow vessels of copper and white metal (W. Rosenhain, 'Notes on Malay Metal-work,' *JAI* xxxi. [1901] 165 f.).

4. Basketry.—Basketry and the making of pottery are, psychologically considered, the two most important arts in early primitive handicraft, as they both involve a distinct creative act, not merely an adaptation, as in the case of the early stages of making a stone implement. Basket-work, including in the term plait-work and matting, fulfils many functions in primitive culture; it furnishes, next to the skins of animals, one of the most primitive forms of clothing, as, for instance, the plaited mats worn in the Caroline Islands; it provides the sails of the Polynesian and Melanesian canoes; it is used to form a shelter against wind and rain, as in the interlaced boughs of the temporary hut of the Australian hunter, and the wattle and daub huts used in the lake-villages of Glastonbury, and it provides vessels for the collection, storage, and cooking of food, as well as mats,

cushions, and other furniture of the house. In Somaliland and Abyssinia, where the pottery is of poor quality, baskets are used as milk-vessels. Basket-work, whether as a receptacle or as a wrapping, was largely used for mortuary purposes by the Indians of N. America and the ancient Peruvians. Bodies wrapped in matting of alfalfa grass stems have been found in excavations in Nubia (D. E. Derry, 'The Red Coloration on Ancient Bones from Nubia,' *Rep. Brit. Assoc., Dundee*, London, 1912, p. 618). A simple variety of basket of the plaited type is that common in the Pacific, which consists simply of a palm-leaf split down the middle, the midrib being coiled round to make the rim. The pinnules are then plaited together to make the body of the basket. The inhabitants of the Swiss lake-dwellings in the Neolithic and Bronze Ages were expert in the making of baskets—checked, twined, and coiled. Specimens of coiled basketry have been found on the pre-historic site of el-Amrah, south of Abydos—so far the oldest to be discovered. Baskets of the same type are still found up the Nile.

In America basketry was of especial importance (cf. ART [American], vol. i. p. 827 f.).

While the vegetable kingdom supplied the Indians with the greater part of the material for making their baskets, they also drew upon the animal kingdom; sinew, skins of the smaller mammals, feathers, and split porcupine quills were employed. The texture of the basket-bottles and boiling-baskets, in which water was heated by throwing in hot stones, was almost sufficiently close in many instances to enable them to hold water, but gum or clay was used to give a waterproof lining. Among the Havasupai Indians of the Shoshonean stock baskets were rendered fireproof for cooking purposes by a lining of clay. One form of basket-work, made of narrow slats of wood, rods of hardwood, and twine, was used as armour on the Pacific coast of America, from the Tlingit coast as far south as the Hupa Indians of California. Captain Smith speaks of the Massawomekes of Chesapeake Bay as using similar armour. Wicker shields are used in many parts of Africa.

5. Pottery.—The art of the potter follows close upon that of the basket-maker in the development of culture. That precedence must be given to the latter in order of time, in most regions of the world, must be conceded from the fact that the earliest pottery forms follow closely those of basket-work, and in some regions the use of clay vessels for purposes of storing liquids or for cooking utensils would appear to have grown out of the devices employed for rendering basket-work more suitable for these purposes. A simple form of cooking-vessel in use among the Havasupai is a flat tray of basket-work, on which seeds, crickets, or pieces of meat were roasted by hot coals. The charring of the basket-work led to the employment of a clay lining. This was turned by the heat into a flat plate, which was, in its turn, used as a brazier. The origin of the parching pot of the Zuñis is indicated by the native name, which means a roasting tray of twigs. By the obvious process of raising the edges of the tray, whether of basket-work or clay, it becomes a bowl. It has been held that pottery generally was moulded in basketry in the eastern United States. It has also been suggested that the method of building up a pot by means of a clay coil is based upon the technique of coiled basket-work. It is possible, however, that in some cases the moulded forms of basket-work on early fragments of pottery both in America and elsewhere may be due to the use of this material to produce ornament by impression, or it may be derived in some cases from the common practice, which occurs, for instance, in the Andaman Islands, of covering the pottery with basket-work. The style of ornament of the pre-historic pottery of Europe, and especially the banded form, suggests a derivation from, or at least the strong influence of, a basket-work prototype, the appearance of regularity in the structure of which has been preserved by the con-

servative primitive mind by a corresponding regularity in ornament. Before the introduction of the potter's wheel, for which the earliest evidence has been found in de Morgan's excavations in Susa, and which appears in the Mediterranean in the Middle Minoan period of Crete, symmetry in form is usually obtained by moulding the pot on a base or in a shallow tray, which is frequently made of basket-work, as among the American Indians, in pre-dynastic Egypt, and in the Mediterranean in the Neolithic and early Bronze Ages. The Nicobarese women, who are noted for their skill in making pottery, employ a board on which is a ring of coco-nut leaves sewn together. In some cases the base of another pot was used, as in New Caledonia. In Papua, for the early stage of pot-manufacture, a gourd was used as a mould. The base was slowly turned as the pot was built up. The Kabyle woman uses her foot for this purpose, while squatting on the ground. The use of a slip in primitive pottery is not uncommon before the introduction of glazework. The Pueblos used a slip, usually white, made of carefully prepared clay, and it occurs in certain classes of pottery in the Mediterranean area. Ornament is usually effected by impression, for which the fingers, pieces of wood or basket-work, or stamps may be used, or by incision (the method commonly employed in the geometric designs of the European pottery of the late Neolithic and Bronze Ages in northern Europe and in the Mediterranean; where a slip is employed, the incision sometimes goes down to the fabric). Pigments may also be used. In Tunisia, in the hand-made fabrics the pigment is smeared on with the fingers. Most elaborate and artistic examples of painted ware are to be found in the Mediterranean Kamares pottery, while, in a more primitive type, the Pueblo painted pottery shows some highly effective designs, the ornament being derived and adapted from the motives of textile prototypes.

Pottery might be hardened simply by placing it in the sun to dry, but various methods of firing were more commonly employed. The Choctaw of the Mississippi in the middle of the 16th cent. are said to have fired their pots by simply placing them in the middle of a fire and covering them with charcoal. The defects of this method, which produced a discoloration of the pottery, were utilized in the South-Western States to produce a black ware, the embers being raked off and fresh fuel added to the fire. A method more nearly approaching the use of a primitive kiln is found in the Nicobars, where the pots are placed mouth down over ashes, firewood, coco-nut shells, etc., and firewood is piled against a wheel-like object which rests on the upturned pot. See, further, ART (American), vol. i. p. 828 f.

6. Weaving.—Weaving is technically closely allied to basketry, especially the woven variety, the essential operation in each case being the intertwining of two sets of strands of material. Weaving is, however, differentiated from its technical relative by the employment of machinery—the loom—and still further by the character of the product, which is essentially flat. The primitive loom consists of a cross-bar fixed on poles, which are usually, but not always, upright; or laid across convenient boughs of a tree. The warp, long strands of the material to be woven, is fixed upon the cross-bar, upon which the cloth is wound as the work progresses. The women of Bakah in Palestine use a loom of the rudest type, consisting merely of a stout stick at either end of the warp, which is stretched on the ground. The threads are passed through with the hand and pressed back with a wooden comb. The Ibans, who alone of the pagan tribes of Borneo attain any great

degree of proficiency in weaving, as the majority of those tribes use bark-cloth, employ a simple form of horizontal loom, on which the ends of the warp are fastened to a light cane. They are kept taut by a string which is fastened to the cane and passed round the body of the weaver as she sits on the ground (Hose-McDougall, *Pagan Tribes of Borneo*, London, 1912, i. 223). More usually the warp is kept in position by stone or clay weights.

The large number of stone weights and of spindle whorls found in Britain and other parts of Europe with remains of Neolithic or Bronze Age date shows the importance of the industry and the extent to which it was practised in pre-historic times. The place of the weights may be taken by a lower cross-beam. When this is used, the weaving usually proceeds from the bottom, and the cloth as it is made is rolled on the lower beam. The weft is passed between the threads of the warp by means of a shuttle. In a still more highly developed form of loom, a bar fastened below the upper cross-beam to the threads of the warp is used to raise or depress alternate threads, the shuttle being thrown or passed through the aperture thus made. A stick is used to push up the weft and secure the proper consistency of the fabric.

In the simple form of weaving, the weft is passed over and under the threads of the warp alternately, but variety in the pattern may be introduced by varying the number of threads over or under which the weft is passed. Further variation may be introduced by the use of different coloured threads. In the manufacture of the silk sarong at Sitiawan in Perak the pattern is produced by binding a number of threads, which are then dyed. After dyeing, the binding, which has preserved the original colour of the material, is removed (L. Wray, 'Notes on Dyeing and Weaving as practised at Sitiawan in Perak,' *JAI* xxxii. [1902] 153-156). The same method is followed by the Ibans in Borneo (Hose-McDougall, i. 221 f.).

Considerable skill in weaving was attained by the ancient tribes of both Mexico and Peru, while among the modern tribes of America, Pueblos and others, weaving formed one of the important industries (see ART [American], vol. i. p. 827).

The Navahos, who with the Apaches were an intrusion into the Pueblo country, apparently had not practised weaving before the conquest, and their earliest attempts at the industry are said to have been made with threads unravelled from Spanish cloth. No specialized form of spindle was used, the weft being fastened to any conveniently shaped piece of wood. The loom is not found in Polynesia or Melanesia except at Santa Cruz. A primitive form of loom was used by the Maoris to spin flax.

7. String, thread, etc.—Forms of thread were made from the fibres of the bark of such trees as the cotton-wood, the willow, the linden, and the cedar. Hemp was used in the United States and Canada, being treated by maceration to remove the rough fibres. Further south, in Central and South America, cotton was picked from the seed. Among other materials employed was the fur of animals, such as goats and rabbits; the latter was used with cotton in Mexico, where cotton was also used in conjunction with feathers. Maguey fibre was another material frequently employed.

Various devices were employed for the twisting process. A primitive method is to roll the material on the thigh with the flat of the hand. The Eskimos and the Zuñis employed two pieces of wood, bone, or ivory, one revolving on the other, the fibre being attached to the revolving part. Raw-hide rope and stout twine among the Eskimos are made with a fly-wheel arrangement. In Palestine at Bakah a primitive form of spinning is recorded, in which goat's hair was spun by fastening the strands to a stone which was turned until they were sufficiently twisted, when the yarn was wound on the stone and the process repeated. In Polynesia sennit was braided from coco-nut fibre. In the most primitive form of thread- or string-making the material was usually held in the left hand without a distaff, while the operator spun with the right hand; before the introduction of the spindle, the material was either twisted by hand, usually on the thigh, as in New Britain and Samoa, or with the assistance of the whorl. In

Australia hair twine was spun with a spindle, but vegetable twine was twisted on the thigh (Thomas, p. 56 f.). The use of the primitive spindle of the Navahos, without a hook at the top, has already been described (§ 6). There is considerable variation in the manner in which the distaff is used among primitive peoples. The Hopis twirl the distaff on the leg with the flat of the hand; the Peruvians and ancient Egyptians threw it in the air.

8. Cloth other than textile, and preparation of skins.—Weaving, owing to climatic and material conditions, was the method of cloth-making practised by the peoples from whose culture modern civilization has developed. There are, however, two other industries whereby man has provided himself with clothing, which in primitive culture are of almost equal importance. These are the preparation of bark-cloth and of skins.

The use of bark-cloth, which is obtained by beating out the bark of certain trees, for clothing is of wide distribution. It is found in Mexico, in Central America, in S. America as far as the tropic of Capricorn, throughout equatorial Africa, and throughout the Southern Seas, where, speaking generally, the loom is not in use. In the Australasian area it is stamped with patterns, while the Andean tribes decorate the costumes which they make from this cloth with shells, seeds, and feathers. The bark-cloth of Hawaii was extremely thin and delicate—an almost lace-like fabric. *Tapa*-cloth is manufactured by beating the bark on the smooth top of a hard log with a variety of hand clubs or hammers having criss-cross faces, with the assistance of water or some mucilaginous fluid. Practically the process is one of felting. Polynesia produced better *tapa*-cloth than any other region in the world.

The use of skins for clothing is naturally of greater importance in high latitudes; but, owing to the many uses to which dressed hide may be put, skill in its preparation is by no means confined to the cold regions of the world. The skin of an animal—usually a goat, with its natural shape preserved—is a primitive, and in warmer climates at the present day still a common, receptacle for carrying water or other liquid. The Australians used the skin of the opossum for this purpose. Among other uses to which skin or leather was put was the making of skin boats by the Eskimos, of shields, bags, and *parfleches*, or meal-bags, by the North American Indians, while the skin of the buffalo or bison furnished the material for the wigwam or tipi as well as the well-known buffalo robe. In Patagonia the tents were made of the skin of the guanaco. Hides are used for the walls of huts among the pastoral tribes of the Upper Nile.

The skins of the thinner-skinned animals and of birds were used chiefly for ornament, but the Eskimo women made close-fitting under-coats of bird-skins, sewn together with sinew, with the feathers next the person; the skins were prepared by chewing. The skins of the smaller mammals—squirrels, foxes, and the like—were simply dried before use. A slightly more elaborate process was used for the hides of larger mammals, such as the moose, seal, elk, ox, or bear, which were to be worn with the fur adhering to the skin. The inside skin or dermis was removed with special tools, a piece of walrus ivory or an antler being used to remove the fat, and a stone being used to plane down the skin to an equal thickness. The shape of certain classes of Palæolithic flint implements justifies the assumption that they were scrapers used for the same purpose. The American Indian women used three tools—a stone knife to cut away the flesh, a hoe-shaped scraper to cut away the skin, and a hoe- or chisel-like tool with serrated edge to roughen up the inner side of the skin and render it flexible. The skins were dried on frames, and sometimes treated with a solution made from the brains of the animal.

A third process employed by the Indians, but not found among the Eskimos, is the preparation of a material analogous to buckskin or chamois

leather, which involves the removal of the hair after gradual putrefaction by heating, the dressing of the skin with a preparation of brains, and a careful manipulation and softening of the skin while drying. The Athapascan Indians were especially adept in the employment of this process.

In utilizing the skins in the making of garments, both Eskimos and Indians displayed great skill. The difficulty experienced by the furrier in cutting the skin without damaging the hair was cleverly overcome, the implement used being the woman's knife, a chert- or flint-blade, crescent-shaped on the outer edge. Among the garments made by the Eskimos may be mentioned the shoes with soles of raw hide and uppers of dressed skin, the hooded upper and the under coat, breeches, deer-skin stockings, and outer boots reaching above the knee, for the men, and for the women two frocks, two pairs of deerskin boots, of which the upper is worn with the hair outside and is shod with soles of sealskin. Much care is shown in cutting, to secure that pretty fur and fringes of hair should show as an ornament at the wrists, shoulders, and borders, sometimes varied with inserted material. Tacitus (*Germ.* 17) records that the German women ornamented their skin dress in much the same manner. The buckskin garments of the North American Indians, and especially the Algonquins, were ornamented with fringes, wampum beads, and paint. Among the Mandans the deerskin tunic was strung with scalp-locks, beads, and ermine, and the deerskin leggings were ornamented with porcupine quills and fringed with scalps.

9. Wood-working.—Our knowledge of the stage of culture attained by the peoples of the Stone Age in Europe—even of the Neolithic period—outside certain well-defined limits, is largely based upon analogies afforded by modern primitive peoples who are, or were at the time they were first described, themselves in the Stone Age. It is only in a few instances, where circumstances were peculiarly favourable, that any relic has survived which was composed of any material less durable than stone, ivory, bone, or pottery. No evidence has survived of the skill in the use of wood possessed by Palæolithic man; but the now extinct Tasmanians attained a considerable degree of dexterity in working this material with stone implements identical in character with some of the earlier forms of palæoliths.

The Tasmanians, who habitually went naked, except in winter, when kangaroo skins were sometimes worn, had as their only shelter a rude screen made by fixing strips of bark to wooden stakes; their weapons both for the chase and for war were made of wood; the spear was a product of much skill and care, the shaft, if not perfectly straight, being heated by fire, and then straightened by the aid of the teeth; it was then scraped to a point, and, after the bark had been removed with a stone scraper, it was hardened in the fire. The notched stone scrapers of Palæolithic and Neolithic times argue the use of similar weapons.

The Australians, whose culture has been compared with that of the Palæolithic Mousterian period, show a decided advance on the Tasmanians; their spear is frequently provided with barbs, and the head is a separate piece of hard wood or stone; they do not possess the bow, but use a throwing stick for hurling the spear; their best-known weapon is the boomerang, returning and non-returning, the former being a striking example of mechanical and technical skill. Their stone axes, adzes, and knives were provided with wooden handles. They used two kinds of wooden shields, one to ward off spears and one to ward off the blows of clubs. Bone was used for awls and gouges. The Bushmen also possessed a Stone Age culture of a primitive type comparable with the Palæolithic culture of Europe. They used the bow; their arrows were made of reeds unfeathered, bound with sinew, and tipped with a splinter of an ostrich or giraffe leg-bone which had been shaped with a stone spoke-shave. This bone was sharpened to form the head, or a separate flake of quartz or other hard stone was used.

Where the pottery is poor, as in Abyssinia and amongst the pastoral tribes of E. Africa, or non-existent, as in Melanesia and Polynesia, wood or horn is usually employed for vessels for carrying liquids. In S.E. Asia the internodes of the bamboos are used as water-vessels; in Melanesia and Polynesia gourds or bamboo or wooden vessels are used as a substitute for pottery.

10. House-building.—The most primitive form of artificial shelter is the screen of boughs resting against stakes, such as is used by the Tasmanians and the screen of interlaced boughs used by the Australian hunter as a temporary shelter for the night, already mentioned. The Neolithic pit-dwellings of Britain were holes in the ground, with a central pole to which a roof of boughs stretched from the edge of the pit. Californian tribes lived in dwellings made on the same plan. The Bushmen's hut consisted of a few boughs brought together and covered with mats of reed sewn together at the edges. In the Egyptian Sudan, Abyssinia, and Somaliland, the hut is circular and made of hide or mats; among the more settled peoples, of branches or clay. The hut of the Bantus is a durable structure, usually circular, and conical or beehive-shaped. In Uganda, substantial huts are made by fastening screens of reeds, carefully sewn together, to a circle of posts, the whole being thatched with reeds. In the case of the king's house the walls are built by peasants, but the roof is built by professional thatchers. Among the forest peoples of Africa, the house is a rectangular structure built of poles with a thatched roof with a pitch. The rectangular house with mud walls, a composite structure, is found among the Wa-Nyamwezi and a few other related tribes of E. Africa. The habitations of the Indians of America exhibit all stages of development—from the simplest form of windbreak used by the Hopis for temporary purposes, through the tipi of hide and the adobe building, to the massive stone architecture of ancient Mexico and Peru. Where manufactured wood was used, considerable skill and ingenuity in its preparation were displayed. The Iroquois used posts covered with bark for the three kinds of houses they inhabited, including the long-house, which was sometimes as much as a hundred feet long, and was divided internally into compartments. On the N.W. coast of America, cedar slabs were employed in house-building. These were split out of the centre of wide trees and fastened upright in a frame about ten feet high, on which rested split bark or boards laid on rafters, supported in the middle by long beams running the length of the house, and themselves supported on four posts with totemic emblems. The Iroquois long-house finds a parallel in the communal house of New Guinea and the clubhouse of Melanesia (which are not, however, divided into compartments, though each family group or, in the latter case, individual, has a separate hearth), and the houses of the Kenyahs, Kayans, and Ibans of Borneo. The Kayan and Kenyah houses are divided into compartments—one for each family. Considerable architectural skill is required in their construction; some of them are four hundred yards long; they are raised on piles, and a verandah runs down the whole of one side. Probably the best-known examples of pile-dwellings are those of the Swiss Lakes, of the Neolithic and Bronze Ages, and the pile-dwellings of New Guinea, erected on platforms built out into the water. Pile-dwellings also occur in Africa—in the Nile Valley among the Nuer, on Lake Nyassa, among the Ba Kuena, and on the West coast—and in various parts of North and South America.

The construction of the house in Samoa is a matter of considerable skill. It is sometimes thirty feet in diameter, and is supported in the middle by three or four posts. The sides are composed of a number of small posts four or five feet apart; the rafters are adzed from bread-fruit or other trees, the space between being filled with small ribs, ingeniously joined until the requisite length is attained. The rafters at the end of the house are circular, the adzing and joining of these being considered the supreme test of a workman's ability. The thatch is made from the leaves of the sugar-cane turned over small reeds.

Before leaving the subject of building, the Pueblo stone dwellings of the S.E. United States may be mentioned. They

consist of a number of rooms built adjoining or on top of one another. One or two single-room houses are first built, and then additions are made from time to time horizontally and vertically step-fashion, the lower series projecting before the upper, till the pile grows to a height of three or four stories. The entrance of the lowest story is not from the ground, but from the roof, through a hatchway, while the upper houses or rooms are entered from the roofs of the lower. The walls are of stone laid in adobe mortar, beams of small tree-trunks forming the basis of the roof.

11. Rafts, canoes, boats.—Among the most primitive means of conveyance by water is the raft made of a hurdle of reeds or papyrus (used on the Nile), or made of the leaf-stalks of the ambatch-tree (Lake Nyanza). Similar rafts are used in parts of Melanesia. The Tasmanians were not acquainted with either boats or canoes, but used as a substitute a kind of half-float, half-boat, made of the bark of various kinds of trees, but usually some species of eucalyptus made up into three cigar-like rolls. It was about nine feet in length and three feet broad in the middle, tapering to each end (H. Ling Roth, *Aborigines of Tasmania*², London, 1899, p. 154 ff.) The *balsa* of the Seri Indians (California) closely resembled the Tasmanian raft, but was of greater dimensions, sometimes as much as thirty feet in length, and was made of reeds (W J McGee, *17 RBEW*, pt. i. p. 215* ff.). In Australia, where navigation was but little known, the means of conveyance were of the frailest description. The simplest form of raft used was a single log paddled by the legs of a man sitting astride; a stage only slightly more advanced was the raft of several logs. A raft-like canoe of bark, resembling the Tasmanian raft, is recorded from Adelaide River. The commonest form of canoe was a sheet of bark, carefully removed from the tree and shaped over the fire, with the ends sewn together and caulked with mud. The usual length was ten or twelve feet. The canoe of sewn bark was also in use—two, three, seven, or even more pieces of bark being used. The gunwale was strengthened by a mangrove pole, and the body kept distended by cross pieces and ribs. The dug-out canoe, which in most parts of the world is a characteristic form of the primitive boat, was also found in North Queensland, and at Port Essington an outrigger was employed. At Cape York the double canoe was used, in length some fifty feet, and propelled with both paddles and sails. While the outriggered canoe is clearly an introduction from New Guinea, it has also been suggested that the sewn bark-canoe may be of Melanesian origin (Thomas, 83 ff.). The commonest form of canoe in the Melanesian area is the dug-out with the single outrigger. In Fiji, New Caledonia, and New Guinea, large double canoes propelled by sails were also found. In parts of the Solomon Isles finely made plank-built canoes occur. What seems to be a stage in the development of the plank-built canoe occurs in Borneo, where the freeboard of a Kayan dug-out is increased by planks along the gunwale (Hose-McDougall, i. 201). The Polynesians, who were born navigators, carried the art of canoe-making to a high degree of excellence, especially in Hawaii and in New Zealand. In Tahiti, where there were regular war-fleets, the canoes were both single and double, with an elevated prow and stern, the stern-post being sometimes as much as eighteen feet high, and ornamented with the carved figures of the gods. The elaborately carved prow- and stern-posts are characteristic throughout this region.

The Tahitian war-canoes were capable of carrying fifty fighting men. The Tahitian coasting canoe was a dug-out with a gunwale sewn on with sennit. The large double canoes were built up from the keel, the planks being carefully adzed and then polished with coral and sewn together. Religious ceremonies were performed when the keel was laid down and when the canoe was launched. In Hawaii a special deity presided over the builders of canoes. In New Zealand, canoes sixty or eighty feet long were built of huge planks cut from

the solid tree and lashed together. The figure-heads and stern-posts were painted as well as elaborately carved. Sails of rushes were used, but not outriggers.

In the Melanesian canoes various *tindalo* charms were hung up at the stern to secure calm seas and prosperous voyages. The important canoes had names, and rejoicings followed their completion. A human life was required for their inauguration. In the Eastern Solomon Islands, if no life was taken on the first voyage, arrangements were made with a neighbouring chief that a victim should be forthcoming. Further west, captives were kept with a view to taking their heads when the canoes were finished (Codrington, 290 ff.).

12. Specialization.—An important factor in the development of an industry is the tendency towards specialization. This tendency appears at an early stage in human culture, mainly in three forms: specialization of locality, specialization of sex, and specialization of workers as a class.

The localization of an industry may arise from a variety of causes, but usually is to be attributed to a plentiful or peculiarly well-adapted supply of material in a given locality. In the Palæolithic period in Europe flint implements were imported to the Channel Islands, for instance, probably from the adjacent French mainland, owing to local scarcity of suitable material. The large number of Neolithic implements of marked characteristics found at Pressigny in France, where the flint is specially suitable for making flakes of large size, suggests a localized industry, while both at Cissbury and Grime's Graves in England, where flint was mined, it is evident that there was a factory, from which partially manufactured implements were probably exported to localities which possessed either no local flint supplies or supplies of an inferior quality. Spiennes near Mons, and Caddington and Stoke Newington in England, may be mentioned among a number of sites where the character of the finds has suggested that they are the workshops of the craftsmen of the Stone Age.

In the Bronze Age, the distribution of material had a much less marked effect in promoting local efficiency in manufacture. In the earlier stages, it is true, favourable circumstances, e.g. an easily accessible supply of native copper, such as occurred in Egypt, Cyprus, and Western Asia, would determine the relative date of its utilization, and give these localities an advantage in experience. But the rapid advance in the civilization of southern Europe and the improvement in transport led to the exploitation of copper- and tin-producing localities, such as Cornwall and Spain, and the transport of the ores from these districts to the place of manufacture. The same course of development occurred in the Iron Age, where favourable circumstances for a time produced an early localized iron culture, of which evidence is found at Hallstatt.

Modern primitive races also afford examples of localized industries. The Nicobar Islands, for instance, are noted for their manufacture of clay pots. In Melanesia, canoe building was often the special work of certain towns because suitable timber was found near; other towns were celebrated for their fish-traps; the Samoans were famous for their mats (Brown, *Melanesians and Polynesians*, London, 1910, pp. 300 f., 304).

Owing to various causes—natural, economic, and religious—an early form of specialization in industry has been determined on sexual lines: i.e. certain spheres of activity have been customarily assigned to each sex. To man has fallen the provision of animal food, the care of cattle, the fashioning of weapons and most implements from stone and metal. Women, on the other hand, have been responsible for most of the useful arts in their early stages. The making of baskets, pottery, spinning, weaving, the preparation of skins, the making of clothes from cloth and skin, and the preparation of food, including the grind-

ing of corn, are among woman's duties, while agriculture was and still is among primitive races largely or exclusively woman's work, especially in Africa. On that continent, however, spinning, weaving, sewing, and the making of clothes not infrequently are the duty of the man (see E. Torday, 'The Bushongo of the Congo Free State,' *Rep. Brit. Assoc., Sheffield*, London, 1910, p. 735; and A. Werner, 195). Among the Indians of N. America, the provision of shelter, whether in the form of the skin tipi or the adobe buildings of the South-West, falls to the woman. In Borneo, among the pagan tribes, while the men build the house, the women assist in providing and bringing up the material.

In the case of most of the useful arts, it may be said that in the early stages they fall within the province of woman, and pass to man only when the machinery, even in such rudimentary form as the potter's wheel, is introduced. In Tunisia, in the country, the pottery, which is hand-made, is manufactured by women; in the towns, where wheel-made pottery is in use, it is made by men (Bertholon-Myres, 'Note on the Modern Pot Fabrics of Tunisia,' *Man*, iii. [1903] 86).

In the third form of specialization—that of manufacture by a family, class, or caste—religious and social influences predominate. Although no system of industrial organization so highly developed throughout as that of India is found among primitive races, something of an analogous character on a smaller scale is not uncommon. It is found in Polynesia, where the making of canoes was confined to a particular family. In Tikopia and Tonga, canoe-making was hereditary in certain families. In Tahiti the building of double canoes was confined to a privileged class attached to the household of the king; in Hawaii, to members of the royal family. In N. America, in many tribes only a particular class was allowed to make stone implements (Schoolcraft, *Indian Tribes*, Philad. 1853-57, iii. 81). In Tibet, occupations are hereditary. Among the Masai, to whom, as a tribe living by raiding, weapons were of supreme importance, but who held manual labour to be degrading, the smith's work was done by a servile tribe, the Elgunono.

A curious result followed from the practice of specialization in making canoes. In the Torres Islands the canoe-makers died out, with the consequence that the people were reduced to using catamarans of bamboo (Codrington, 293). It has been suggested that the present absence of pottery in Polynesia and in Melanesia, except in New Caledonia and Espiritu Santo, and to the north of these islands in Shortlands, Bougainville, and Buka, and again after an interval in New Guinea, and to the west in Fiji, is due to the dying-out of the people or caste who made the pottery of which remains have been found in Malikolo and Pentecost, Lepers Island, and Ambrym (W. H. R. Rivers, 'The Disappearance of Useful Arts,' in *Festschrift tillägnad Edvard Westermarck*, Helsingfors, 1912, pp. 109-130). The art of making stone adzes disappeared in Woodlark Island in like manner, through the dying out of skilled craftsmen (Seligmann-Strong, 'Anthropological Investigations in British New Guinea,' *Geog. Journ.*, 1906, p. 247).

An interesting example of primitive industrial organization existed in Samoa, where the trades of boat- and house-building, tatuing, etc., though not strictly hereditary, were carried on for generations by certain families, who thus acquired prestige. The trade was, however, open to any man who cared to attach himself to any craftsman until he had acquired sufficient skill to begin work on his own account. Each particular trade had its presiding god, and was governed by well-known regulations. The times of payment at different stages of the work were prescribed. In the case of building a house, a mat was presented to the master-builder, and its acceptance signified agreement to do the work. The members of the family for whom the house was being built did the unskilled labour, such as

falling trees, carting them from the bush, and the like. They also had to supply the carpenters' food, and these absented themselves from work if it was insufficient or of inferior quality. As the house progressed, payment was made for certain definite portions of the work, the principal payment being made when the two sides and one of the rounded ends were finished. It was considered a great honour to be lavish in payment. If the builders were dissatisfied with the payment, they left the work unfinished, and no other builder would complete it. If any one did, he was visited with severe punishment at the hands of other members of the craft. The regulations in trades other than building were practically the same (G. Brown, p. 305 ff.).

LITERATURE.—J. Evans, *Ancient Stone Implements of Great Britain*, London, 1897; W. J. Sollas, *Ancient Hunters and their Modern Representatives*, do. 1911; W. Gowland, 'The Metals in Antiquity,' *JRAI* xlii. [1912] 235-287; E. B. Tylor, *Anthropology*, London, 1881; *B.M. Handbook to the Ethnogr. Collections*, do. 1910; O. T. Mason, *Woman's Share in Primitive Culture*, New York, 1894, also 'Aboriginal American Basketry,' *Rep. Smith Inst. U.S. Nat. Museum*, 1902, pp. 171-648; F. S. Dellenbaugh, *The North Americans of Yesterday*, New York and London, 1901.

E. N. FALLAIZE.

HANDS, LAYING ON.—See HAND.

HANGING.—See CRIMES AND PUNISHMENTS.

HANĪFA.—See LAW (Muhammadan).

HAOMA.—1. Derivation of the word.—The word *haoma* (Skr. *soma*, Pahl. and Pers. *hom*) comes from an old Aryan root *hu* = Skr. *su*, 'to pound,' 'to squeeze.' *Hāvana*, the utensil in which the twigs of the *haoma* plant are pounded, *hāvan*, the *gāh*, or the part of the day when this plant is pounded, and *hāvanāna*, the priest who pounds it, come from the same root.

2. *Haoma* in the Avesta.—In the Avesta we meet with four *Haomas*:—(1) *Haoma*, whom for convenience' sake we may call *Haoma* the prophet. Chs. 9, 10, and 11 of the *Yasna* speak of him as well as of the plant *haoma* discovered by him. Further allusions are found in *Ys*. lvii. (19 and 20) and *Yashts* x. 88-90 and *Ashi* xvii. 5.—(2) *Haoma*, the plant; see esp. chs. 9, 10, and 11 of the *Yasna*. (3) *Haoma*, who may be called *Haoma* the hero (*Ys*. xi. 7; *Yt*. ix. 17, xvii. 37, 38).—(4) *Haoma Khvarenangha* (*Yt*. xiii. 116). In the *Fravardin Yasht* we have a long list of the departed worthies of ancient Irān who had rendered some service to the community. The group in which *Haoma Khvarenangha* is mentioned seems to be a list of the names of some of the immediate successors of Zoroaster. It appears, therefore, that this *Haoma Khvarenangha*, whose *fravashi* is invoked, was a great man of Irān, who had done some good deeds that commemorated his name.

These four different *Haomas* have one or more special names in the Avesta. *Haoma* the prophet is called *Haoma Dūraosha*. The plant *haoma* is spoken of as *haoma zāiri* (e.g. *Ys*. ix. 17, 30, 32). *Haoma* the hero is known as *Haoma Frāshmi* (so repeatedly in the *Yashts*). The fourth *Haoma*, as we have said above, is named *Haoma Khvarenangha*.

Haoma the prophet is called *Frāshmi* as well as *Dūraosha*. The *Haoma Frāshmi* of the *Gōsh* and *Ashi Yashts* is quite different from the *Haoma Frāshmi* of the *Yasna* and of *Yashts* x. and xi. The reason why these two *Haomas*, who lived at different times—one in the time of the Peshdadian dynasty, and the other in that of the Kaiānian—are called *Frāshmi* seems to be that they both belonged to the same family stock.

Just as *Haoma* the prophet had, besides his special designation of *Dūraosha*, that of *Frāshmi*, so *haoma* the plant had, besides the special appellation of *zāiri*, also that of *dūraosha* and *frāshmi* (*Ys*. x. 21, xlii. 5). It was called *zāiri*, on account of its yellow or gold-like colour. The other appellations were due to the fact of its being discovered by *Haoma Dūraosha*, who was also known as *Haoma Frāshmi*.

3. *Haoma* the prophet.—It appears from the Avesta that there lived in ancient Irān a pious man named *Haoma*. He belonged to the early

times of the Peshdadian dynasty, before the time of Vivānghant (*Vivasvat* of the Vedas), the father of Yima (*Yama* of the Vedas). He was a very learned man (*vaēdhyā-paiti*),¹ versed in the old religious literature. He had passed a good deal of his time in divine meditation on the Hukairya peak of the lonely mountains of the Elburz.² Before Zoroaster, he was the first man or prophet to proclaim to the world the Mazdayasnian religion.³ As Zoroaster had his own religious compositions, so had Haoma.⁴ He had his Gāthas⁵ (*imāosē tē haoma gāthāo*), and had as an opponent one Keresāni.⁶

It was this Haoma who gave his name to the plant, which he seems to have discovered, and to the Haoma ceremony, which he is said to have introduced. According to *Yasht* x.,⁷ he was the first man who produced the juice in a mortar (*hāvana*) on the Elburz mountain. It appears that, while absorbed in deep divine meditation in his retreat in the mountains, he discovered this plant growing on the heights, and found it to be nutritious, health-giving, and invigorating. He introduced it to the world as such; but, in order to make it doubly efficacious, he instituted a form of ritual, designed to absorb the mind of the people in holy and religious thoughts. A plant, in itself health-giving and vigorous, when partaken of under a partial inspiration of divine thoughts, was likely to be beneficial to the mind as well as to the body.

4. The Haoma plant.—*Haoma* is a medicinal plant which grows in Persia and in Afghanistan. It is a species of *Ephedra* (Nat. Ord. *Gnetaceæ*).

(1) *The Avestan description of the plant.*—Mountains and mountain-valleys are mentioned as places where the plant grows luxuriantly. In some passages, Mount Elburz (called in the Avesta *Hara Berezaiti*) is specially mentioned as its habitat. But it must be borne in mind that the name Elburz not only denoted the present Mount Elburz, a peak of the Caucasus, but was applied to the whole range of mountains extending from the Hindu Kush in the East to the Caucasus in the West. The *haoma* is described as a plant with branches and sprigs,⁸ as possessing medicinal properties, and as 'golden-coloured.'⁹

(2) *The properties of haoma.*—The religious or spiritual properties attributed to the *haoma* plant are described in a rich poetical style, and in a tone overflowing with heartfelt admiration and praise. *Haoma*, prepared and drunk in a state of pious, spiritual inspiration, is believed to give wisdom, courage, success, health, increase, and greatness.¹⁰ In such a state the devotee becomes as powerful as an independent monarch, and is able to withstand many dangers coming from ill-disposed persons.¹¹ Heaven, health, long life, power to contend against evils, victory against enemies, and fore-warnings against coming dangers from thieves, murderers, and plunderers are the six gifts bestowed by *haoma* when adequately praised and prepared.¹² *Haoma* is specially sought for by young maidens in search of good husbands, by married women desirous of being mothers, and by students striving after knowledge.¹³ It affords special protection against the jealous, the evil-minded, and the spiteful.¹⁴ It is a check upon the influence of women of loose char-

¹ *Ys.* ix. 27.

² *Ib.* x. 10; *Yt.* x. 88; *Ys.* lvii. 19.

³ *Ib.* ix. 26.

⁴ *Yt.* xvii. 5.

⁵ *Ys.* x. 18.

⁶ *Ib.* ix. 24.

⁷ *Yt.* x. 90.

⁸ The Avesta word for this is *frasperega*, in which *fra* is a prefix, and *sperega* is the same as English 'sprig.'

⁹ The Avesta word is *zārt-gaona*, which some Orientalists take to mean 'green-coloured.' But, as green is the usual colour of vegetation, there was no apparent necessity to say so. The writer seems to mean 'yellow' or 'gold-coloured,' in which sense the word is also used elsewhere.

¹⁰ *Ys.* ix. 17.

¹¹ *Ib.* 18.

¹² *Ib.* 19, 21.

¹³ *Ib.* 22, 23.

¹⁴ *Ib.* 23.

acter, who change their affections as frequently as the wind changes the direction of the clouds.¹ For all these reasons, *haoma* is called *nmāna-paiti*, *vis-paiti*, *zantu-paiti*, *danghu-paiti*, i.e. 'Lord of the house, the village, the district, and the country.'²

(3) *Qualifications required of the man who would drink haoma with advantage.*—These are: good thoughts, good words, good deeds, obedience to God, and righteousness.³ On the other hand, Haoma curses those who are sinful and evil-disposed. 'I, Haoma, who am holy and keeper away of death, am not a protector of the sinful.'⁴ 'May thou be childless, and may evil be spoken of thee.'⁵

5. Antiquity of the Haoma ceremony.—It appears from the Avesta that the Haoma ceremony was in existence as early as the time of the Peshdadian dynasty. It is as old as the time when the ancestors of the Parsis and the Hindus, and even of the ancient Romans, dwelt together. It seems to have been always accompanied by the Barsom (*g.v.*) ceremony, as it is even at the present day. Now, it appears that the ancient *flamines*, who were the Roman fire-priests, and many of whose practices resembled those of the *āthravans*, or Iranian fire-priests, used twigs of a particular tree, whenever they went before the sacred fire. This practice resembles that of the Parsi priests, who also use twigs of a particular tree when performing the Yasna ceremony before the fire. The twigs are now replaced to a certain extent by metallic wires.

6. The plant used after purification.—We said above that the twigs of the plant are brought from Persia. They are not used directly in the ceremony. On being taken to a temple, or *dar-i-meher*, they are washed and purified, and then laid aside for a period of at least thirteen months. A qualified priest takes a quantity of these twigs, and washes and purifies them with water, reciting the formula of *Khshnaothra Ahurahē Mazdāo, Ashem Vohu*, etc., which means: 'Pleased be Ahura Mazda. Piety is the best good and happiness. Happiness to him who is pious for the best piety.' After being thus purified with water, the twigs are kept in a metallic box, similarly washed and purified, for at least thirteen months and thirteen days before being used in the ceremony. When so prepared and purified, they can be used several years afterwards. This ceremony has no direct connexion with the Yasna ceremony.

The *Vendidad* (vi. 42, 43) enjoins the purification of those *haoma* twigs which have come into actual contact with filth and impurities; but present custom, which is designed to make assurance doubly sure, demands the purification of all *haoma* twigs intended for use in religious ceremonies. Again, the *Vendidad* requires the twigs to be laid aside for one year; but present custom prescribes a period of thirteen months and thirteen days.

7. Description of the Haoma ceremony.—This falls under four heads: (1) the preliminary preparations; (2) the ceremony of purifying or consecrating the *haoma* twigs; (3) the ceremony of preparing and straining the *haoma* juice; (4) the ceremony of drinking the *haoma* juice.

(1) *Preliminary preparations.*—Two priests take part at this stage, as in the whole of the Yasna ceremony. One of them with the *khub* (i.e. ritual for qualification), either small or great, duly observed, first prepares the *aiwoyaōnghana* (strips of date-palm), the *urvarām* (twigs of a pomegranate tree), and the *jivām* (fresh goat's milk). All the *ālāt* (the necessary sacred utensils) are emptied, washed, and put into the *kundi* (the large water vessel on the stone slab supplied for it). The fire is kindled in the vase, and the *aēsam* (fragrant wood) and *bui* (frankincense) are placed on the adjoining stone. Two water-pots—one small and the other

¹ *Ys.* ix. 32.

² *Ib.* 27.

³ *Ib.* x. 16.

⁴ *Ib.* xi. 3.

⁵ *Ib.* 1.

large—are placed on the *khirān*, or stone slab for the *ālat*. The cup containing the *aiwyaōnghana* and the *urvarām* is placed on a small stone by the side of the stone slab on which the priest sits. The *haoma* twigs are also ready by his side in a cup. The officiating priest (*zaota*) now takes his seat on his stone slab, which is covered with a carpet. He makes *pāv* (ceremonially pure) the smaller of the two water-pots, and with the water of that pot makes the *kundi* containing all the utensils *pāv*. He then prepares the *zaothra* water and ties the *barsom* wires. Having done all this, he next proceeds to make the *haoma* twigs *pāv*.

(2) *The ritual of purifying the haoma twigs.*—The priest takes a few pieces or twigs of the *haoma* plant out of a cup, and, holding them between the fingers of his right hand, washes them thrice with the *pāv* water. While doing so, he recites the *Khshnaōthra* formula three times. He then commences the *bāj* and the *khshnuman* of *Haoma ashavazangha*, wherein he says that he does this for the homage, glory, pleasure, and praise of *Haoma*, the giver of the strength of purity. Then, reciting the *Ashem* four times, he dips both his hands, together with the twigs, in the *kundi* on his right hand. He dips them four times into the water—thrice in the direction pointing from his position to the opposite side (i.e. from north to south), and once in the opposite direction. Having thus made the twigs *pāv*, he finishes the *bāj*, and dips the purified twigs in the *zaothra* water. Then, drawing the *hāvana* before him, he inverts it and places on it three pieces of the consecrated *haoma* twig; the rest are placed over the foot of the *māh-rui* ('moon-faced'; two crescent-like stands). He next places a piece of the *urvarām* beside the *haoma* twigs.

(3) *The ceremony of preparing and straining the haoma juice.*—The priest begins by saying: 'I invoke all the belongings (i.e. the requisites for the performance of the ceremony) of the *Haoma*, for the sake of *Ahura Mazda*.' Then he enumerates some of the important requisites which lie before him on the stone slab. While reciting their names, he looks at them. The requisites which he enumerates are: *haoma*, *myazda* (i.e. the *darun*, or sacred bread, which is spoken of as *kharethem myazdem*, 'appropriate or sacred food'), the consecrated water (*zaothra*), the twigs (*baresma*), some product of the cow such as fresh milk (*goshudō* or *gēush hudhāo*), a twig of the pomegranate tree (*urvarām hadhānaēpatām*), pure good water (*aiwyo vangunhibyō*), mortar for pounding the *haoma* (*hāvana*), fragrant wood (*aēsam*) and frankincense (*baoidhi* or *bui*), and fire (*āthra*). The prayer, in which he invokes or enumerates the requisites, and, while reciting their names, looks at each of them as they lie before him on the stone slab, forms a part of the 24th chapter of the *Yasna*. He recites that chapter from section 1 to section 12, omitting therefrom, in sections 1 and 6, the words, *imāmcha jivyām ashaya uzdatām* ('this *jivām*, or fresh milk, held up with righteousness'), because, at the time when he recites this prayer, the *jivām* is not yet placed on the stone slab. Sections 9 to 12 of this 24th chapter are the same as sections 4 to 7 of the fourth chapter.

The *Haoma* ceremony may be performed either in the *hāvan-gāh* or in the *hushain-gāh*, i.e. during the morning or the midnight hours. So, after reciting the first 12 sections of the 24th chapter, the priest recites the 13th section if he prepares the *haoma* juice in the *hāvan-gāh*, or the 17th section, if he prepares it in the *hushain-gāh*. Having thus recited the *khshnuman* of the particular *gāh* during which the ceremony is performed, he recites the *khshnuman* formula of the particular day of the month and the particular month of the year on which he performs the ceremony. Then he proceeds

to recite the prayers contained in the 4th chapter of the *Yasna* from section 17 to 25 up to the word *vahishtad*, omitting the portions which refer to *rathwō berezato* and *sraoshahē ashychē* (in sections 22 and 23). Next he recites the prayers contained in the 25th chapter of the *Yasna*, from section 1 to 3, omitting the reference to *gām jivyām* (fresh milk) in section 1. On reciting the words *Ameshā spentā* (ch. xxv. sect. 1 of Spiegel), the priest holds between the thumb and the forefinger of his left hand the twigs of the *haoma* and pomegranate plants which were on the foot of the inverted *havanā* and, lifting the latter with his right hand, knocks it thrice in its inverted position on the stone slab, and places it in its proper position. Then, reciting the words *imām Haomem*, etc. (*ib.* sect. 2, Spiegel), and taking the *haoma* twigs into his right hand from his left hand, he places them in the *hāvana*, or mortar. Next, reciting the words *imāmcha urvarām*, etc. (*ib.* sect. 4), he similarly places the *urvarām*, or pomegranate twigs, in the mortar. Reciting the words *aiwyo vangunhibyō*, etc. (*ib.* sects. 5 to 11, Spiegel), he pours into the mortar, with his right hand, a few drops of the *zaothra* water which lies before him. He now invokes the *Fravashi*, or Guardian Spirit, of *Zoroaster* by reciting *Yasna* xxvi. 11 (Spiegel). Then, reciting the words *iristanām urvānō* (*ib.* 35) and the *yēnghē hātām* prayers, he takes out of the *kundi* the *surākhdār tashā* (i.e. the plate with holes which serves as a strainer) and places it on the *haoma* cup at the foot of the *māh-rui*. Reciting *athā ratush ashātchit hachā*, etc., he removes the *lālā*, or pestle, from the *kundi*, passing it round in a circle within the vessel, touching its rim from within. The circle begins from the north and passes in the direction of west, south, and east. Then, reciting the words *aētaḥ dim*, etc. (*Ys.* xxvii. 1, Spiegel), he lets the lower end of the pestle, and, while reciting the words *ratūmcha yim*, etc. (*ib.* sect. 1), the upper end of the pestle, touch the stone slab. As he recites the words *snathāi*, etc. (*ib.* sect. 2, Spiegel), which signify that the *Daēvas*, or evil influences, may be beaten or struck, he strikes the metallic mortar with the pestle, making sonorous sounds. At first he strikes it from without, i.e. strikes the pestle on the outer rim of the mortar. The sonorous blows are given in the order of east, south, west, north. When striking on the north side, he gives three more strokes. Then both the priests say, *Shekaste Ganāminō*, etc., in *bāj*, i.e. 'May the Evil Spirit be broken! May 100,000 curses be on *Ahriman*!' The priest then recites *Fradathāi Ahurahē Mazdāo* (*Ys.* xxvii. 3-7, Spiegel). Next he recites four *Yathā ahū vairyōs*. While reciting the first three, he pounds the *haoma* and the *urvarām* twigs in the mortar; and, while reciting the fourth, he strikes the *hāvana* on the outside with the pestle. In like manner he recites *Mazdā at mōi* (*ib.* 8, Spiegel; or *Ys.* xxxiv. 15) four times, to the accompaniment of a similar pounding during the first three recitals and a striking of the *hāvanim* during the fourth. This is followed by a recital of *Ā Airyamā ishyō* (*ib.* 9, Spiegel; or *liv.* 1) with like pounding and strikings. Next comes the recital of three *Ashem vohus*, during which the priest pours a little of the *zaothra* water into the mortar three times. Then, while reciting the words *Haoma pairi-hareshyante* (*Ys.* xxvii. 10, Spiegel), he gives a little push to the pestle which is within the mortar, and causes it to turn a circle in the direction of north, west, south, east.¹ While reciting the words *atha, zimē, humayō, tara*, which

¹ This part of the ritual is a relic of the old practice, when, after being pounded, the *haoma* twigs were regularly rubbed in the mortar with the pestle to extract the juice further—a process now known as *gūntvā*.

form the last part of this passage, he takes up the twigs of the *haoma* and the *urvarām* from the mortar between his thumb and fingers; and, holding the pestle also, he touches or brings these in contact with the *barsom*, the plate of *jivām*, the *haoma* cup at the foot of the *māh-rui*, and the stone slab. At the last word *anghen* he places the twigs and the pestle in the mortar again. He then recites four *Yathā ahū vairyōs*, during the recital of the first three of which he pounds the twigs. He strikes the *hāvana* during the recital of the fourth. During each of the first three recitals and poundings, he pours a little of the *zaothra* water into the mortar with his left hand at the recital of the words *athā*, *ashāt*, and *hachā*. At the end of each *Yathā ahū vairyō*, he pours the *haoma* juice so pounded over the pestle, which is held with the left hand over the strainer. From the strainer the juice passes into the *haoma* cup below. The recital of the fourth *Yathā ahū vairyō* is accompanied by the striking of the mortar. At the end of this, the whole of the *haoma* juice is passed into the cup, as described above. If any particles of the twigs still remain unpounded, they are removed from the mortar and placed in the strainer, where they are rubbed with the hand to make all the extract pass into the cup below. During this process of rubbing, the priest recites thrice *yē sevishō*, etc. (xxvii. 11, Spiegel, or xxxiii. 11). The strainer is then washed and placed over the mortar. The particles of the twigs still left unpounded or undissolved are removed and placed in an adjoining clean corner. The pestle is washed and placed in the *kundi*.

The next ceremonial process is that of straining the *haoma* juice again with the help of the *varas ni viti*, i.e. the ring entwined with the hair of the sacred bull. The *varas* is put over the strainer (*surākhār tashta*, 'perforated plate'). The priest holds the cup containing the *zaothra* water in his left hand, and places his right hand over the knotty part of the *varas* in the strainer. He recites *us mōi uzāreshvā*, etc. (*Ys.* xxxiii. 12-14), at the same time pouring the *zaothra* water over the *varas*, and rubbing the knots of the *varas*. He recites two *Ashem vohūs*, the second of which is in *bāj*. He then holds the strainer with the *varas* in his right hand, and the cup containing the *haoma* juice in his left hand; and, repeating *Humata*, *hūkhta*, *hvarshta* thrice, pours the *haoma* juice into the strainer, which is held in different positions over the *khwān*, or stone slab, as the different words of the triad are repeated. While reciting the word *Humata* each time, he holds the strainer over the right hand of the stone slab, so that the *haoma* juice falls over it through the strainer. On each recital of the word *Hūkhta*, the *haoma* juice is similarly dropped into the cup of the *zaothra* water, which has just been emptied into the mortar through the strainer, and the *varas* with it. At each recital of the word *Hvarshta*, the *haoma* water is allowed to drop into the mortar. The *haoma* juice-cup is now put back in its proper place on the stone slab, and the strainer with the *varas* is placed over it. Then all the juice in the mortar—a mixture of the *zaothra* water and the *haoma* juice, or, more properly speaking, the juice of the *haoma* and the *urvarām* twigs—is poured into the strainer, through which it passes into the *haoma* cup below. After its contents have been thus emptied, the mortar is once more put in its proper place. The milk-plate (*jivām no tashtō*) is placed at the foot of the *māh-rui*. The priest also sets the other cups and plates in their proper places. He deposits in their proper plate some of the spare twigs of the *haoma* and the *urvarām* which are at the foot of the *māh-rui*. He places some of these in a spare cup and lets fall over them

a few drops of the *haoma* juice prepared and collected in the cup, as described above.

It is at this stage that the other priest who is to join him in the recital of the *Yasna*, and who is now to act as the *zaota*, enters the *yazashna-gāh*. Reciting an *Ashem vohū* and a certain number of *Yathā ahū vairyōs*, the number of which depends on the particular kind of *Yasna* to be performed, he goes before the *khwān* of fire and purifies or consecrates the fire. The priest who has performed the ceremony of straining the *haoma* now takes the *zaothra* wire of the *barsom* in his left hand, and the *varas* ring in his right hand, and finishes the *bāj* of the *varas* which he had commenced some time before. To do this he recites two *Yathā ahū vairyōs* and the *Yasnemcha* with the *khshnuman* of the *Fravashi* of Zoroaster. He next dips the *varas* ring in the *zaothra* water cup and places it in its own cup. He then rises from his seat, and, taking the *haoma* cup which contains the juice prepared and strained, as above, places it in an adjoining niche of the wall. He brings the *jivām* and pours it into its plate (*jivām no tashtō*). In a plate on the stone slab he now places the *darun*, or sacred bread, which was up till now in another vessel in the *yazashna-gāh*. He then recites an *Ashem vohū* and *Ahmāi raēshchā*, etc., finishes the *bāj*, and performs the *kushti*.

This closes the ceremony of preparing the *haoma* juice, more properly spoken of as the ceremony of straining the *haoma* (*Hom gālvō*). With its completion terminates the *paragnā*, i.e. the first or the preliminary preparatory ceremony of the *Yasna*. The second priest, who has now entered the *yazashna-gāh* and who is to recite the whole of the *Yasna*, mounts the stone slab or platform which serves as a seat. As he does so, he recites two *Yathā ahū vairyōs*. While uttering the word *shyaothnanām* of one *yathā* he places his right foot over it, and, while reciting the same word of the second, his left foot.

The *Dādistan-i Dinik* (xlvi. 30-33) tries to explain part of the symbolism of the ceremony for preparing and straining the *haoma* juice. For example, the *haoma* twigs are pounded during the recital of four *Ahunvars*. These four poundings symbolize the coming of Zoroaster and his three future apostles. 'The pure Hom, which is squeezed out by four applications of holy water (*zōrih*) with religious formulas, is noted even as a similitude of the understanding and birth of the four apostles bringing the good religion, who are he who was the blessed Zaratūst and they who are to be Hūshēdar, Hūshēdar-māh, and Sōshāns.'¹ The striking of the metallic *hāvana* while pounding and straining the *haoma* reminds one of the triad of thought, word, and deed on which the ethics of Zoroastrianism rests. The *Dādistan* says on this point: 'The metal mortar (*hāvan*) which is struck during the squeezing of the Hom, and its sound is evoked along with the words of the Avesta, which becomes a reminder of the thoughts, words, and deeds on the coming of those true apostles into the world.'²

The three ceremonial processes of pouring the *zaothra* water into the *haoma* mortar for the preparation of the juice are symbolical of the three processes of the formation of rain in Nature, viz. (1) evaporation, (2) formation of clouds, and (3) condensation as rain.³

The juice, prepared as above, by pounding the *haoma* twigs together with the *urvarām* in the *zaothra* water, is called *para-haoma*.

(4) *The ceremony of drinking the haoma*.—The last ceremony in connexion with *haoma* is that of drinking it. We saw above that its preparation and straining formed a part of *paragnā*, i.e. the ceremony preparatory to the performance of the *Yasna*. The ceremony of drinking it forms a part of the *Yasna* itself. It begins with the recital of the 9th chapter, and finishes with the recital of the 11th. In these three chapters the priest sings the praises of *haoma*. The *zaota* describes in a highly poetical strain the good qualities of the *haoma* juice which lies before him. On his finishing the description and the praises of *haoma*, at the 8th section of the 11th chapter, his colleague, the *rāspi*

¹ *SBE* xviii. 170.

² *Id.*

³ *Id.* 170 t.

or *Atravakshi*, makes his hand *pāu*, and, coming to the *saota*, lifts the cup containing the *haoma* juice from the stone slab, carries it round the sacred fire in the vase on the slab opposite, at the same time taking the *aśam bui* (sandalwood and frankincense) from their stone slabs, and placing them on the fire. He then comes back to the *saota*, and, holding the cup over the *barsom-dān*, says to the *saota*: 'May the *haoma* juice be of twofold, threefold . . . ninefold efficacy to you.' Next he hands the juice-cup to the *saota*, who, holding it in his hand, looks into it, again addresses a few words of praise, and prays that the drinking of it may bring spiritual happiness to him. Finally, he holds up his *padān*, or cloth veil, to his mouth and drinks the *haoma*. He does not drink the whole quantity at once, but in three draughts. In the interval between each of the three draughts the *rāthwi* recites an *Ashem vohū*.

During the recital of the *Yasna*, the *haoma* juice is prepared and strained twice. As described above, at first it is prepared and strained by one priest in the preparatory *paragnā* ceremony. It is drunk by another priest during the recital of the 11th chapter of the *Yasna*. Then the priest who drank it prepares it a second time during the recital of the three chapters of the *Yasna* from the 25th to the 27th. The process of pounding the *haoma* twigs and striking the mortar continues during the recital of the 32nd, 33rd, and 34th chapters, with which the second preparation terminates. Though the ceremony proper commences for the second time during the recital of the 25th chapter, it may be said to begin with the 22nd chapter, because all the requisites of the ceremony are enumerated and invoked at its commencement. These two preparations and poundings are spoken of in the *Avesta* (*Ys.* x. 2) as *fratarem hāvanem* and *uparem hāvanem*, i.e. the first and the second squeezing of the *haoma*.

LITERATURE.—For an analysis of the three chapters of the *Yasna* on *Haoma*, etc., see *Journal of the Bombay Anthropological Society*, vol. vii. no. 3 (1904), p. 203.

JIVANJI JAMSHEDJI MODI.

HAPPINESS.—This term belongs to the ethical rather than to the psychological sphere, though referring to a condition of mental life. In ethics its use has been almost universal, yet in such varying senses that the substitution for it of its more definite equivalents is much to be desired. A formal and a material meaning may be distinguished, the latter subject to a threefold division.

1. Formal meaning.—The practical human good, the ultimate end of action. In this sense 'happiness' is a mere abstract term for the desirable in life, implying nothing as to its concrete constituents.

Thus Zeller: 'This conception is in itself a purely formal one, admitting of any desired material interpretation' (*Vorträge*, 1865-84, iii. 209). Also Sorley: 'To say that the ethical end is happiness, is, to use Locke's terminology, "a trifling proposition"; for in so doing we merely give it a name' (*Ethics of Naturalism*, 1885, p. 7).

Aristotle (*Nic. Ethics*, i.) assumes that all men agree in calling the good 'happiness,' but differ widely as to what constitutes it. This was true for the ancient world, and for some modern thinkers of the Greek type, but is no longer universally the case. Happiness has come to include various specific concrete meanings which are particular and debatable interpretations of the good, and not merely equivalent names for it, though the latter is sometimes claimed by Hedonists for their own interpretation (J. S. Mill, *Utilitarianism*, ch. iv.). Kant and his successors, especially, deny the possibility of happiness being either the only or the supreme good, though it is an element in the complete good. This formal use of the term

should therefore be abandoned in favour of the more abstract term 'good' or 'ultimate end of action.'

2. Material meaning.—(a) *Pleasure, or the absence of pain.*—This is the meaning which has been given to the term by Utilitarians since Gay, and which has been advocated by Sidgwick (*Methods of Ethics*⁶, p. 120) as the only legitimate and unambiguous interpretation. Pleasure is to be taken in this definition in its psychological sense, as pleasurable feeling, not as pleasant object. J. S. Mill, by his assertion of qualitative differences in pleasure, and hence in happiness, forms an exception to the Utilitarian tradition, using the term 'happiness' in its second (material) meaning as the pleasure of an objectively higher order of activity (*Utilitarianism*, ch. ii.). Kant's usage agrees with that of the orthodox Utilitarians, although he puts an opposite ethical value upon the idea (*Werke*, ed. Rosenkranz, 1838-40).

'The notion of happiness . . . is only a general name for the subjective determining principles' (viii. 137). 'A rational being's consciousness of the pleasantness of life uninterruptedly accompanying his whole existence is happiness' (*ib.* 129).

This happiness, as merely the feeling accompanying the satisfaction of desires, is qualitatively alike, irrespective of the nature of the objects causing the satisfaction. As such, it furnishes no objective and necessary law for conduct, but is only a name for the satisfaction of any and every desire.

(b) *The feeling accompanying the systematic activity of the whole self, the feeling of self-activity or self-realization.*—In this sense, 'happiness' is distinguished from 'pleasure,' which is limited to the feeling accompanying partial or limited activities.

'It is the form of feeling which accompanies the harmonious adjustment of the various elements in our lives within an ideal unity' (J. S. Mackenzie, *Man. of Ethics*⁴, 1900, bk. ii. ch. v. § 14). 'Happiness is not the sum or aggregate of pleasures; it is their harmony or system—or rather, the feeling of this harmony' (J. Seth, *Ethical Principles*¹⁰, p. 203). 'Pleasure is transitory and relative, enduring only while some special activity endures, and having reference only to that activity. Happiness is permanent and universal. . . . Happiness is the feeling of the whole self, as opposed to the feeling of some one aspect of self' (J. Dewey, *Psychology*, 1887, p. 293). Mill's conception of happiness as consisting in the pleasures of the exercise of the peculiarly human or higher faculties belongs to the same category.

This distinction between happiness and pleasure has been criticized by Kant (viii. 130) and others, on the ground that it is based upon the nature of the objects causing the feeling rather than upon the nature of the feeling itself, and, therefore, that happiness does not differ qualitatively from pleasure, inasmuch as it allows no end of action other than that of pleasure. As Ladd puts it (*Philosophy of Conduct*, p. 479):

'Ethics can divide pleasures into higher and lower, noble and ignoble, or difference [*sic*] pleasure from happiness or even from blessedness, only by introducing into the psychological conception of pleasure-pains something from the outside. That something is a standard of moral values.'

While this criticism is valid psychologically against the attempt to distinguish qualities in pleasure, and is also valid ethically against the attempt to make happiness, as a distinct kind of feeling, the moral end, it does not necessarily invalidate this use of the term in the authors criticized. Although the pleasure of partial and that of systematic activity may be alike in kind, it may still be convenient to use the term 'happiness' to denote the latter, even though its moral significance be derived wholly from the character of the activities which condition it. Happiness would thus denote the affective side of the virtuous life. So Spinoza: 'Happiness is not the reward of virtue, but virtue itself' (*Ethics*, bk. v. prop. 42). This use of the term, however, while justifiable, is too susceptible of misinterpretation to be retained.

(c) *Welfare, the right condition of activity, the harmonious life itself.*—'The good of man [or happiness] is an activity of the soul in accordance with excellence, or, if there are more excellences than one, in accordance with the best and most perfect excellence' (Aristotle, *Nic. Ethics*, i. ch. vi.). The emphasis here is upon the complete life rather than upon any one aspect of it, such as pleasure. The doing perfectly what one is fitted to do constitutes happiness, which will be accompanied by pleasure though not constituted by it. This use of the term is becoming infrequent, save as the translation of Aristotle's *eudaimonia*, and even here the term 'welfare' (*q.v.*) is being recognized as more appropriate.

3. The moral significance ascribed to happiness furnishes a principle for the classification of ethical systems. Kant's division is the basis for most modern classifications: (a) *autonomous* (end as self-given); (b) *heteronomous* (end as given from without), subdivided into (1) *empirical*, including all systems which make happiness the end, and (2) *rational*, including all which make perfection the end. Happiness and perfection thus constitute the two material ends as opposed to a formal conception which places the good in the bare form of will rather than in any end to be attained by it. The idea of happiness as an end carries with it all the ambiguities of its definition, and systems which propose this end receive different names accordingly.

(i.) 'Hedonism' (*q.v.*) is the term applied to systems which propose happiness in the first sense as the end. It may be *universalistic* or *egoistic*. (ii.) 'Hedonism' should also be the term applied to systems in which the second meaning of happiness is taken as the end, since a kind of pleasure is still pleasure. Such systems, however, are few. J. S. Mill is representative in that professedly, at least, he takes a special kind of feeling as the end. Those who use the term 'happiness' in this sense are usually careful not to assert it as the ultimate end, but to make it only an aspect or concomitant of the end (Mackenzie, Seth). (iii.) 'Eudæmonism' (*q.v.*) is a name adopted by some who posit happiness in the sense of welfare as the end. 'Complete Eudæmonism is the doctrine that the Good is found in the complete rationalisation of desire' (J. Seth, *op. cit.* 233). 'Self-realization' states the same position from a more Hegelian point of view. 'Energism' is Paulsen's title for his revived Greek position. In this third use of the term it includes, rather than excludes, perfection as an end. It is equivalent to the complete enjoyment of perfection as well as perfection itself. It is the bloom of perfection. It is only in its first two meanings that happiness excludes perfection as an end. Zeller (*op. cit.* 210) defines the term as the equivalent of 'Hedonism'; so also Wundt (*Ethics*, 1897-1901, ii. ch. iv.).

Cf. also artt. BLESSEDNESS (Christian), CULTURE, ETHICS, PLEASURE, SUMMUM BONUM.

LITERATURE.—Aristotle, *Ethics*, bk. i. and bk. x. chs. vi.-ix.; F. Paulsen, *System der Ethik*, Berlin, 1891, bk. ii. chs. i. and ii.; Dewey-Tufts, *Ethics*, New York, 1908, chs. xiv. and xv.; H. Sidgwick, *Methods of Ethics*, London, 1901, bks. ii. and iv.; E. Albee, *Hist. of Eng. Utilitarianism*, do. 1902; J. S. Mill, *Utilitarianism*, do. 1897; J. Bentham, *Principles of Morals and Legislation*, do. 1823; J. Seth, *Ethical Principles*, Edin. and Lond. 1908, pt. i. ch. iii.; T. H. Green, *Prolegomena to Ethics*, Oxford, 1890, bk. iii.; G. T. Ladd, *Philosophy of Conduct*, London, 1902, ch. xix.; J. R. Angell, *Psychology*, do. 1906, ch. xiii.; also any systematic treatise on Ethics.

NORMAN WILDE.

HAPPINESS (Buddhist).—The word *sukha* in Buddhism covers, in extension, both the relatively static state which we name happiness or felicity, and the conscious moments of such a state, to which our psychology refers as pleasurable or pleasant feeling. There are other terms of happy import, but none so broadly comprehensive. *Sukha*

is applied alike to physical health, material well-being, and spiritual beatitude. Etymologically the word has no connexion with hap, happening, or luck. Grammarians assume that the second syllable, *-kha*, is a substantival affix to *su*, 'well' (= Greek *εὖ*). The word would then be equivalent to the original meaning of our 'weal-th.'

In Buddhist psychological analysis, feeling, or emotional sentience (*vedanā*), is resolved into three phases: *sukha*, *dukkha* (pain), and *adukkhamasukha* (neutral feeling). The last of these, to which modern psychology in the main ascribes a mere zero point between positive degrees of the first and second phases, is in Buddhism ranked as an equally distinguishable constituent of consciousness (*Majjhima*, i. 302; *Samyutta*, iv. 223 f.). We do, indeed, meet with a layman who pronounces a twofold division of feeling more orthodox (*Maj.* i. 59; *Sam.*, *loc. cit.*). But the Buddha, when appealed to, explained that he divided feeling variously, according to the aspect under which he was treating of it in his teaching (cf. his method in another connexion, *Maj.* iii. 62). When, *e.g.*, he distinguished feeling under two heads, he was treating of sensuous feeling and spiritual emotion, to both of which the term *sukha* was applicable.

We may pause, before considering the teaching attributed to the Buddha on *sukha*, to note the way in which, in one of the canonical dialogues, the psychological analysis of feeling is applied to ethical training. The teacher is the noted woman apostle Dhammānā. (She finally refers her interlocutor—her husband—to the Buddha, who endorses all she has said.) She first gives the orthodox division (as stated above), and then adds a dictionary definition of each kind. She is then asked: 'In happy feeling, what is happy, what is unhappy? In unhappy feeling, what is unhappy, what is happy? In neutral feeling, what is happy, what is unhappy?' She replies: 'In happy feeling, the static (element) is happy, change is unhappy; the inverse for unhappy feeling. In neutral feeling, knowledge is happy, want of knowledge is unhappy feeling'—an answer that reveals the weakness of the threefold division as an analysis of bare feeling. She is then asked: 'What is our latent bias (*anusaya*) when experiencing each of these three modes?' The answer is: passion (or lust, *rāga*), aversion (or resentment, *paṭigha*), and ignorance (*avijjā*) respectively. But, she adds, when questioned further, not all feeling, of any of the three kinds, is thus tainted. Ethically, she goes on, it is these three forms of bias that we have severally to eliminate from the three modes of feeling. This may be accomplished by the practice of *jhāna* (see *DHYĀNA*). In the first stage, sensuous desires and immoral or wrong ideas are banished, the intellect being engaged with happy zest about a certain selected object. In the second and third stages, through the strong yearning to attain the blissful serenity of the saints (*ariyā*), all resentment and opposed feeling melt away. And in the fourth stage, wherein all positive feeling fades into indifference and perfect clarity of mind is attained, ignorance is banished. She is finally asked: 'What is comparable to happy feeling, to painful, to neutral feeling?' She replies: '(1) Happy and painful feeling are mutually comparable; (2) neutral feeling is comparable with ignorance; (3) ignorance again is comparable with knowledge; (4) knowledge with spiritual emancipation, and this again with Nibbāna. Nibbāna alone is incomparable, as being *suī generis*.' Hereon Buddhaghosa comments that the comparison (*paṭibhāga*, cf. *Milinda*, ii. 186) in (1) and (3) is of opposites, but in (2), because of the vagueness of neutral feeling, and again in (4), the comparison is of similars.¹

Bearing this archaic but authoritative analysis in mind, we may proceed to consider the explanation which the Buddha is said to have given concerning his treatment of feeling under a twofold aspect of pleasure or happy emotion. The dissenting layman, mentioned above, had alleged that 'neutral feeling' was identical with happiness, namely, with happiness of a loftier kind. Warning his two interlocutors that discords might arise, if the mere framework of his various discourses on feeling—two heads, three, five, six, eighteen—was taken as essential, Gotama briefly stated the sources and kinds of sensuous pleasure and desire. 'The pleasure and happiness arising from these five senses we call happiness of worldly desire' (*kāmasukha*; see *DESIRE* [Buddhist]). He then proceeded to soothe and elevate his two disputants by affirmations of the loftier joys arising in con-

¹ Neumann, in his tr. of the Sutta, has mistaken the meaning of *paṭibhāga*.

nexion with the practice of *jhāna*. The brief discourse has been set down by the compilers with the rhythmic progress and iteration of the Suttanta refrains, suitable for oral teaching. He commences with this refrain :

'With him who should say : "This is the supreme happiness and pleasure (or joy, *somanassa* = mental happiness) that beings experience," I do not agree. And why? Than such happiness there is another happiness sweeter and more excellent. And what is that?'

In successive replies it is pointed out that the stages of *jhāna*, four of *rūpajhāna*, five of *arūpajhāna*, are each of them a sweeter and loftier happiness than *kāmasukha* and each preceding mode of *sukha*. The last stage of *arūpajhāna* was the attainment of catalepsy or trance, described in the usual formula, elsewhere amplified, as 'the cessation of perception and sensation.' Nevertheless, of this also 'happiness sweeter and more excellent' is predicated. Then, to defend the position and to withdraw the original bone of dissent, Gotama concluded :

'Other teachers may say : "The Samāsa Gotama predicates happiness of the trance-stage: what and how is that?" Thus are they to be answered : "Friend, the Exalted One does not predicate happiness only where there is happy (pleasurable) feeling; he also predicates happiness wherever and whereinsoever happiness is found to exist."'

These observations, referring his hearers, as always, to the spirit rather than to the letter, were the Buddha's method of teaching that the word *sukha* could represent concrete states of being, activities, ideas, memories associated with happy consciousness and genuine 'well-being,' no less than the pleasurable feeling discerned by analysis. He might have extended his final remark to most of the preceding stages of *jhāna*; for whereas, in the first three stages, the happy feeling, accompanied in the first two by that zest of pursuit known as *pīti*, is the prevailing factor, the fourth *jhāna* is explicitly defined as a state wherein all positive feeling, joyous or melancholy, is merged in neutral feeling, so that the consciousness is one of complete equanimity and clarity of mind.

A unique compound may here be adduced—*upekkhāsukha*—occurring in *Āṅguttara*, iv. 412, as the conscious state which was to cease when the fourth *jhāna* was attained, and which can, therefore, only be taken to mean the happy feeling of, or belonging to, or accompanying equanimity.

Sukha was, moreover, the predominating nature of celestial existence, so far at least as the six realms of *devas* in the *Kāmaloka* extended. To re-birth in these heavens the moral average layman aspired, believing that he would there enjoy pleasures of a sensuous sort, but intenser, more numerous, and less fleeting than those of earth (cf. Rhys Davids, *Dialogues of the Buddha*, ii. 353 ff., 242 ff., 265). Nor would he, as *deva* or *devaputto* (son of the gods), be incapable of loftier emotions and satisfactions to which the term *sukha* might equally apply; witness the behaviour, in many Buddhist legends told in *Nikāya* and *Jātaka*, of the sentiments of Sakka, god of a *Kāma*-realm, and of those of the many *devas* who flocked to earth to hear the Buddha and his saints preach, or to commune with and admonish here and there a saint *in spe*.

Sukha, then, we repeat, is of very wide import, covering all three: pleasure, pleasurable feeling, and happiness; and it is equally applicable to the lowest and loftiest kinds of experience so designated. We have also seen that the neutral feeling accompanying vague intellection merges into positively happy feeling when the vagueness passes; and, again, that absorbed reverie and abstract contemplation, if rightly induced and persisted in, lead to emotionless quasi-ecstatic states which can also be described as *sukha*, because they are a means whereby the saintly life is nourished and advanced.

In the next place, the natural desire of mankind

to attain happiness and avoid pain and sorrow is fully recognized, believed in, justified, and exploited by Buddhism. As a system of ethical philosophy, it may be classed as frankly eudæmonistic or hedonist, i.e. neither egoistically nor altruistically so, but of the kind termed by H. Sidgwick 'Universalistic Hedonism.' It recognizes in happiness an ultimate to which every human aspiration is in the last resort reducible. Accepting the current proverbs of the day, it sees in happiness the crowning result of mundane wisdom (*Theragāthā*, 293). Happy re-birth, as a *deva* or as a fortunate human being, is the legitimate quest urged on the laity and the simpler-minded, less saintly *bhikkhu* (*Digha*, iii. 181, 185, 191 f.; *Āṅg.* i. 58, ii. 192, iii. 76 ff.). Meritorious acts are justified as happiness-bringing (*sukhāvahāni*) for self and others, and the latter is the ultimate test of the worth of a practical doctrine (*Āṅg.* i. 190 f.; tr. in *Buddhist Review*, April 1911). Again, it is only the quest of the highest good that gives adequate opportunity for ending sorrow (*Maj.* iii. 245; *Āṅg.* i. 249). The mission of a Buddha is frequently declared to have as its object not only, in negative terms, the revealing of how ill (*dukkha*) may be overcome, but also, in positive terms, the attainment of the good, or weal, and the happiness (*hitāya sukhāya*) of all beings. In the wrestling and toil of mind for the enlightenment (*bodhi*) whereby he could qualify for that high mission, Gotama admits that the quest of *sukha* was the ground wave that bore him along (*Maj.* i. 246 f.), and in the midst of his self-devoted career he claims that this quest is won for good and all :

'Ay, young sir, I verily am of those who fare happily, even though you see me exposed in this hut to the chilly nights of winter. Your well-housed citizen, happy after his kind, nay, the king himself with all his pleasures, is not so happily at ease as I. They may be smitten with torments through greedy desire, enmity, or blunders. But one who has cut off at the root all those sources of suffering dwells at ease, for he has won peace' (*Āṅg.* i. 136-8; *Maj.* i. 93 f.).

A fortiori, happiness is commended not only for the babes in religion, but also for earnest disciples as a reasonable and sufficient aim of the religious life (e.g. *Maj.* i. 140 f.). And, adopting as a name for their *summum bonum* a word which would seem to have been applied to the easeful cool organic consciousness of physical well-being (*ib.* 75th Sutta), the Buddhists qualified Nibbāna as supreme happiness (*paramasukha*) :

'These things to know e'en as they really are :

This is Nibbāna, crown of happiness' (*Dhammapada*, 203).

The happiness thus commended and extolled for and by saints and those qualifying for saintship was, of course, neither the *kāmasukha* referred to under *vedanā*, or feeling on occasion of sense, nor the *sukha* associated with ideas of the same. The attitude enjoined with regard to such feeling was very uncompromising :

'Pleasant (*sukha*) feeling, *bhikkhus*, is to be considered as (equivalent to) pain (or ill); painful feeling is to be considered as a javelin; neutral feeling is to be considered as the impermanent. A brother by whom these are thus considered is an Ariyan of supreme vision; he hath cut through craving; he hath rolled back his bonds; through supreme grasp of vain conceits he hath put an end to sorrow' (*Iti-vuttaka*, § 53; *Sam.* iv. 207).

Coming next to ideal emotion, or the three modes of feeling when associated with ideas (*somanassa*, *domanassa*, *upekkhā*), we find the admission that, for spiritual health, these three modes of feeling are not at all condemned as such, but are preferable when unaccompanied by such thought as is engaged upon sense-experience (*vitakka-vichāra*). (Such is the implication of the phrase translated 'pre-occupation and travail of mind' in Rhys Davids, *Dialogues*, ii. 312 f., the terms *vitakka*, *vichāra* being essentially terms of sense-cognition, and used only in the first stage of *jhāna*, when the mind is not yet abstracted from such cognition.)

Finally, the most general affirmations as to that happiness which the candidate for saintship and the saint or *arahant* might legitimately aspire to and feel may best be sought in the body of testimony ascribed to such men and women. For them, as for all the earnestly religious, holiness meant a radical alteration of values. The forms of *kāmasukha*, which had once excited and pleased, were become nauseous and pestilential, terrible, or merely devoid of all attractive power. The Christian saint's 'I do count them but dung' (Ph 3^o) has many a prototype in the poems of the Buddhist *theras* and *theris* (cf. *Sutta-Nipāta*, 59-61, 762). The zest (*pīti*) of pursuit and advance, the relaxation, ease, exultation, and peace of vantage-points and mastery won (*sukha*, *somanassa*), are now transferred to and associated with the religio-philosophical ideal of *arahant*-ship and *Nibbāna*, the spiritual supramundane *summum bonum* (*sadāttha*) of oneself and all beings. Into this new objective of happiness, the prospect of celestial joys did not enter.

'The very heavens delight them not; how then
Should aught that's merely earthly please?'
(*Therag.* 397; *Dhamm.* 187).

'... I want no heaven of gods—
Heart's pain, heart's pining have I trained away'
(*Therig.* 82).

But the happiness actually attained is claimed as very positive and not as 'neutral feeling':

'Not music's fivefold wedded sounds can yield
Such charm (*ratī*) as comes o'er him who with a heart
Intent and calm rightly beholds the Norm'
(*Therag.* 398; cf. *Dhamm.* 35, 36).

'This never-ageing, never-dying Path—
No sorrow cometh here, no enemies,
Nor is there any crowd; none faint or fall,
No fear cometh, nor aught that doth torment. . . .'
(*Therig.* 512).

'Now have they prospered all my highest aims. . . .
The holy love and liberty, my quest. . . .
I what 'twas well to do have done, and what
Is verily delectable, therein
Was my delight; and thus through happiness
Has happiness been sought after and won (*sukhen' anu-
gatam sukham*)'
(*Therag.* 60, 63; cf. 211 f., 386, 518 ff.).

That the 'seeking' or pursuit of the goal was itself happy as contrasted with the ascetic practices of many Indian religionists was claimed by Buddhists from the first (*Maj.* i. 93 f.). 'This happiness by happy ways is won,' exclaims another saint, once a faqir (*Therag.* 220). This was naturally the experience of those who were unhampered by a sensual or sluggish temperament, e.g. the younger brother of the chief disciple Sāriputta:

'The will to learn bringeth of learning growth;
Learning makes insight grow, and by insight
We know the Good; known Good brings bliss along'
(*Therig.* 141).

With many others the training and the transference involved great toil and travail of spirit. The poems quoted from above often reveal this, and the later *Milinda*, while it calls *Nibbāna* 'entirely happy' (*ekanta-sukham*), speaks of the quest as 'alloyed with pain' (ii. 181 ff.).

In connexion with the use attributed to the Buddha of the term 'entire (or absolute) happiness,' two remarks may be added in conclusion. Consulted by Mahāli the Licchavi about the anti-causationist doctrine of a rival teacher, Gotama affirmed causation. There was a cause, and a sufficient cause, for the wickedness, as for the regeneration, of the world. Were sense-experience, he went on, productive of absolute happiness, no one would ever be converted from it to purer ideals. Were it absolutely painful, no one would be engrossed by it, as are the majority. It was the mixture of pleasure and pain in human life that constituted at once the hindrance to, and the guarantee of, spiritual progress (*Sam.* iii. 68 ff.; cf. ii. 172 ff.).

But, when pressed by Udāyin the Jain to de-

scribe what he considered to be the sphere of absolute happiness and the way thereto, the Buddha first repeats the current belief that practice in the fourfold *jhāna* may bring about re-birth among *āevas* in entirely pleasurable conditions. He then repudiates such aspirations for his Rule, and enumerates the attainments in self-mastery and intuitive vision won by the *arahant* as far loftier and more excellent than such a hedonistic ideal (*Maj.* ii. 79). The moral of this, confirmed by the general context of the *Nikāyas*, seems to be that he also held the ethical view that happiness may best be secured when not it, but its cause, is aimed at.

LITERATURE.—This is quoted in the article; references are to the PTS editions; the *SBE* (*Milinda, Dhammapada, Sutta Nipāta*); the *Sacred Books of the Buddhists* (*Dialogues*). See also the present writer's *Buddhism* (Home Univ. Library), London, 1912, chs. vi.-viii., *Psalms of the Early Buddhists*, do. 1909, 1913. Modern psychology on 'neutral feeling' is concisely represented in H. Höfding's *Psychology*, Eng. tr., London, 1891, p. 287. On Universalistic Hedonism and happiness as end, cf. H. Sidgwick's *Methods of Ethics*, London, 1901.

C. A. F. RHYS DAVIDS.

HAPPINESS (Greek and Roman).—I. GENERAL.—I. Greek teleology: happiness attends fulfilment of function.—*εὐδαιμονία*, when critically appraised, could not mean to the Greeks 'a happy temperament,' to which a genius was propitious. This might be very well, but it was not of *knowledge* (as Socrates and Plato would say) or of *faith* (as St. Paul). The term was applied to well-being judged from outside by a certain agreed standard of perfection. The Greeks, however serious their practical doubts, never showed any hesitation, save in the Atomic School, in accepting teleology: everything was made for some end and found its satisfaction in fulfilling its function, in realizing its idea or its notion; only in so far as it did this was it real, good, and therefore happy. Man was contrasted, as a single type, with the rest of creatures; never (oddly enough) with other and different members of his own species; his *differentia* lay in reason, implying self-consciousness and self-criticism, above all, recognition of a law—and that a universal one, beyond the private and the particular. Thus, the only state deserving the title 'happy' in the truest sense was that of the philosopher, who alone used *formative* or *speculative* reason aright, and so fulfilled the end for which he was made. It is clear that, like Kant's categorical imperative, this vague axiom can give no special guidance for individual cases, no help to men of different character, aim, and station. In the end, then, Greek ethics set up in the various schools an ideal of life singularly alike, a purely typical excellence which was bound to end in a negation rather than in any positive content. Except the early Cynic model, which soon passed out of favour, there is little to choose, in essential detail, between the 'sage' of Plato and Aristotle and that of the Stoic and Epicurean schools; indeed, the Cyrenaic model, significantly enough, tended later to approach this common standard. Happiness, then, in every Greek system of religion or philosophy, is singleness of aim, uprightness of heart, and the undisturbed peace of one who rests in ultimate truth, and has hold of reality. It is always set in contrast with the aims of the worldly-wise, cumbered with much serving or the pursuit of many ends. Not within the limits of our period do the modern features appear, which direct human activity towards the conquest and enjoyment of the world, and complexity of life; or towards social service, 'the love of mankind,' 'the greatest happiness of the greatest number,' multi-form legislation to secure better conditions for the poor.

2. Enemies of happiness: impulse and convention.—Happiness, then, as above described, lay in

reason (as private judgment, which mirrored an external order and laid hold of objective truth), not in impulse or custom. The body and conventional society were the two great enemies of wisdom and, therefore, of happiness. The ascetic and anti-civic tendency of Hellenic morals is now well-established, in spite of some feeble protests. The dualism between the soul's true welfare and all earthly concerns begins in Pythagoras and Heraclitus, and only increases in intensity down to Aristotle and the later Stoics. The conventional order, *πολις*, the State, was never really the true home of the sage who desired to be perfect and therefore happy. Happiness lay 'in understanding and accepting the world-order,' not in average honesty or public life in a small city. It was, then, directly dependent upon knowledge, as wide as that postulated by Plato in his 'Idea of Good.' Upon this Epicurus, the anti-teleologist, insists as strongly as the rest: his last advice was 'to remember the *dogmata*,' which explained the physical world by science. The Atomic theory, which put accident above providence, had existed from early times as a heresy defying the orthodox belief in a rational world-order. But, if the axioms of Democritus and Epicurus sound startlingly unlike the rest, there is substantive agreement in actual life and in their portrait of the wise and happy man; he, too, 'understood and accepted' the world-order, by taking his proper place in it; and, it need scarcely be said, even this accidental system assumed a half-personal look. Nature was even deified in Lucretius (*q.v.*), to the loss of all logic and consistency, and to the gain of that moral unction and earnestness without which ethical theory is dry bones.

3. Happiness in knowledge of Nature or the world-order (*κατὰ φύσιν = κατὰ λόγον*).—Happiness therefore lay merely in living according to Nature, in finding the wider law which was higher and more imperious than the customs of a city, or the edict of a tyrant. Except some sophist, perhaps, in empty theory, or Aristippus for a short time, none believed that the individual could stand alone, or be safe in following impulse and running counter to convention. There has never been much disagreement in the whole of history on the virtues, on what makes a 'gentleman,' and the like; the indecency of the Cynic was reprobated by all, and Epicurus soon turned aside from pleasures to find a unique satisfaction in the simple life, in a temper permanently cheerful. But the sanction demanded was from the Universe itself, not from any local or partial authority; the happy wise man was the cosmopolitan. And here we meet two questions: Does Nature, after all, recognize the goodness and respect the happiness of the 'sage'? And, if not, is the consciousness of duty done and right defended at the cost of life sufficient for happiness? It is clear that these doubts were at the root of the movement which gave a welcome to Christianity, turned the self-poised independence of the Stoic into pious resignation to the Heavenly will, and brought back in countless forms the cult of various tutelary beings.

4. Virtue to be self-sufficing or found in union with God.—When the Porch became a practical guide instead of an academic paradox, men like Posidonius and Panætius had to come to terms with average men; like Aristotle and the Peripatetics, they postulated for happiness not bare virtue but a moderate equipment of external goods. Where Zeus had shut the door on everything but the 'good will,' they let in the (uncertain) elements (*Diog. Laert. vii. 65*) of health, competence, and strength. So Adam Smith admits as constituents of happiness health, a good conscience,

and freedom from debt; Lucian makes equally merry over those who demand a good deal from the world and fortune and those who pretend to despise any such alliance and to deem virtue self-sufficing. With the collapse of the city-State system, the correspondence between merit and receipt was disputed and explicitly denied. The Stoics, professing to 'rationalize' the world-order (see Bussell, *The School of Plato*, 1896, *Marcus Aurelius*, 1909), ended in pronouncing it unknowable and incommensurable with man's specific ideals of right and wrong. They still adhered to the axiom that the *Λόγος* spoke in everything; the cruelty of lion and tyrant was quite in place, like death or disease; but there was no real interrelation between these several units, each displaying its nature. The sage could help feeling dissatisfied only by steeling his heart with a few maxims to be kept ready against doubt. Nature, whether as the actual system around us or as its ideal perfection conceived by the thinker, made no allowance for the virtues of the good: the world lay in the 'Evil One,' as St. John said (1 Jn 5¹⁹), or, as Seneca preferred to say, under Fortune. *Flight from the world*, instead of the Platonic attempt to embody the ideas in the actual, became the text. The self-sufficingness of virtue was an article of faith, because it was the last and only certain possession of the wise man (*ἴδιον καὶ ἀναφαιρέτον*), and he could not stoop to make terms with an alien and immoral power. Hence pious resignation and religious prayerfulness and ecstasy, or self-loss, became the distinguishing marks of the School which ended all free development of the classical mind. It was a quite legitimate evolution: it is needless to suppose a conscious borrowing from Eastern sources; and there is nothing explicit in the final form which was not implicit in the earliest utterances of Greek wisdom. Every school prepossessed with the belief that the soul is prior to and alien from the body rejected any sort of external aid. The modern aim, to improve by better environment and early physical and mental training, would have been abhorrent. The old self-reliance was gone, and only in surrender to a divine order or to a tutelary god, as with Apuleius, were safety and happiness to be found.

II. DETAILS.—1. All Greek philosophy sought the permanent in the fleeting and changeable; and, in human life emerging into self-consciousness and purposive intent, called the end *εὐδαιμονία*, from which pure subjective feeling and impulse was ruled out as self-defeating. All schools were agreed (as soon as the question was once posed) that (a) well-being is the aim of all effort and all inquiry; and (b) wisdom, or knowledge of the good, can alone give security and guidance; that (c) 'none can sin against the light' or his own good if he knows it; that (d) ethical conduct, already personal and un-social, is a pure matter of insight; and that (e) to know good is to follow it, and to attain it is the highest happiness or satisfaction known to man.

2. It is noteworthy that no Greek school placed the ideal of perfection (and, therefore, of happiness) in active social service; the end was always self-realization, and everything was regarded from the individual's standpoint, though the subject was conceived objectively; the very frequency of classical protest that 'man is a social being' bears witness to their profound doubts on the subject.

3. Side by side with a purely rational, non-transcendental belief in virtue as self-poised independence and consistency, went from the first a vein of mysticism which issued, as we saw, in the pietism and resignation of the Roman age. Man, to be truly himself, must 'live the life of the gods,' however conceived—from the crude demonology of Empedocles and perhaps of Heraclitus to the Aris-

totelian text ἐφ' ὅσον ἐνδέχεται ἀθανατίζειν and the curious paradox τοῦς ἑαυτοῦ, while τοῦς is at the same time God Himself.

4. Roman 'virtue' was very early conscious that reflexion was dangerous to the ethics of custom, the traditions of a proud ruling class, inured to hardship and State-service, with no keen desire to distinguish private from public life. The Senate expelled the philosophers, as they expelled the Bacchanals—both symptoms of unruly or sceptical subjectivity. They had all Hegel's distrust of the man who sets up his ideal of perfection (*Moralität*) against the slow-growing fabric of social convention (*Sittlichkeit*). Both in religion and in ethics they were content to follow their fathers. How subversive reflexion might prove is seen in Cicero. Where he is perhaps most original and sincere, he is still, of course, under heavy debt to his Greek master; but he speaks with conviction in the *Somnium Scipionis*, when he makes politics and State-service not an end in itself but a means to future blessedness—a hard but divinely appointed condition and discipline, work in the vineyard in the burden and heat of the day. When Rome was overrun by rich men and cosmopolitans, when tribal and ancestral sanctions broke down, no guide for conduct was left except private sectarian religion, and, in practical matters, obedience to law issued by an autocrat.

III. SUMMARY.—We may sum up the doctrine and practice of the ancient Greeks thus: happiness or well-being as the avowed object of our human activity is *twofold*—higher and lower, positive and negative. Man is the 'instrument of a Divine reason'; but, owing to the complex and accidental character of his body, he is hindered in the pursuit of goodness and truth. The first stage is, therefore, to order the passions. Plato saw happiness to consist in a harmony between the three parts of the soul (reason, spirit, and appetite); Aristotle was equally clear that moral virtue (or human excellence) involves a control of those desires, of that which all thinkers and teachers have called 'our lower nature.' Above this negative victory over the disorderly elements in our self, which gave a certain domestic peace, was a far higher realm of truest happiness. Every one is familiar with Plato's portraits of the soul, freed from earth and sense and communing in heaven with eternal forms. Aristotle only gave definite shape and object to this ideal yearning. However far he diverged from Platonic supernaturalism, he never swerved from the doctrine of highest happiness in contemplation alone. He passed from the docetic and mystical stage of his Eudemus (quoting Silenus' maxims, 'Best of all not to be born,' and calling death 'going home'), from the devout theological attitude of the *Eudemian Ethics*, to a cooler tone in his praise of *θεωρία*, and of a god who is the last term in science rather than in religion; to a far more sympathetic attitude to the actual world of men and things. But, though he changed the highest ideal from devotion to inquiry, he always placed happiness in intellect, saw in social life a *δύττερος πλοῦς*. In his admiration for virtue, as excellence won by endeavour, he was quite as sincere as Kant in his reverence for Duty: witness his poem, 'Ἀρετὰ πολύμοχθε γένοι βροτείῳ | θήραμα κάλλιστον βίῳ; but, as with an absolutist like Bradley, this dualism and striving denoted an imperfect sphere, and had to be transcended by that which alone gave freedom—science. He believed the best to be within the grasp of a few only whom Fortune had equipped with competence, health, and leisure. In his Platonizing *Protreptic*, he calls worldly goods (strength, beauty, and honours) mere semblances or shadow-pictures (*σκιαγραφία*); and compares the soul in the body to a living prisoner yoked with a corpse. How far

he transcended the ascetic dualism of principles is known to every reader of the *de Anima*. Quite clear is the negative (or cathartic) character of moral as distinct from intellectual 'virtue'; it prepares the way for the chief good, but is not to be identified with it. Aristotle reverences Eudemus, *ὁς μόνος ἢ πρῶτος θνητῶν κατέδειξεν ἐναργῶς | οἰκείῳ τε βίῳ καὶ μεθόδοισι λόγων | ὡς ἀγαθὸς τε καὶ εὐδαίμων ἄμα γίνεται ἀνὴρ*. In his earlier and more devout phase, this happiness was a divine gift or recompense; later, the sage became independent and worked out his own salvation; only afterwards did the precarious tenure and uncertain title come to light, throwing a man back on his own inner resources and reviving the old Platonic asceticism. Peripateticism was throughout a compromise with the worldly and social spirit. Aristotle was quite sincere, for instance, in holding that human good is specific and attainable in this life by an activity of the soul, not needing a comprehensive knowledge of the universal good which is in Plato supernatural. But how imperfect and provisional is his portrait of the natural man, and with what unction he speaks of the highest life of God and of man! For the average man in the world neither Aristotle nor his school gave any real guidance in the management of conduct or the pursuit of happiness. When Theophrastus stoutly defended the value of external good (leisure, security, and affluence), he was speaking on behalf of a privileged aristocracy, the elect of wisdom.

The weakness, then, of ethical appeal in the Greek world was due to (1) the small number who could reach the ideal; (2) the ascetic and transcendental character of the happiness promised to them; (3) the increasing sense of the instability of fortune, the submerged props on which rested that joy which should be man's surest and most unchanging possession; (4) the confusion of moral and intellectual good (to the detriment of the former), and the permanent entanglement of right action with 'knowledge of the good.' Impulse and custom still regulated the life of ordinary men. Philosophers taught no striking novelties in ethics, and merely laid stress on a negative goodness, aloof and remote, which could have no public influence. The lower happiness was allowed by Plato in the *Republic* to those who implicitly obeyed authority; it was clear that they were outside the pale of truly reasonable beings, of those who thought for themselves. This (socialist) belief, that happiness for the mass can come by regimentation from above, prevented the spread of private judgment or any sense of responsibility. The Hellenic conception of happiness gave way, therefore, before the new religious personal faith of which Christianity was the chief, but by no means the only, symptom; and it was the belief in 'regimentation' that helped to arm the Roman Emperor with such ample powers.

See also artt. ARISTOTLE, EPICUREANS, PLATO, STOICS, SUMMUM BONUM, and the literature cited there.
F. W. BUSSELL.

HARAKIRI.—See CRIMES AND PUNISHMENTS (Japanese), vol. iv. p. 286.

HARDENING.—See PREDESTINATION, and cf. the artt. ELECTION, FREE WILL, LIBERTARIANISM AND NECESSITARIANISM.

HARDWAR.—An ancient historical town, and one of the most famous places of pilgrimage in N. India; situated on the right bank of the Ganges, close to the point at which the river debouches into the plains through a gorge of the Siwālik or sub-Himalayan range; lat. 29° 58' N.; long. 78° 10' E. It is claimed as a sacred site by the

followers of the two great Hindu sects, the followers of Śiva giving the name as *Haradvāra* ('gate of Hara,' or Śiva, the destroyer), those of Viṣṇu calling it *Haridvāra*, after Hari, 'the tawny one,' a title of Viṣṇu Kṛṣṇa. The place was also at one time known as *Kapila*, after the saint Kapila Muni, the scene of whose devotions and austerities at the Śaiva shrine of Kapileśvara, 'Lord of Kapila,' is shown at Kapilasthāna in the hills adjoining Hardwār (Atkinson, *Himalayan Gazetteer*, Allahabad, 1884, ii. 806). Hiuen Tsiang, the greatest of the Chinese Buddhist pilgrims (A.D. 629-645), visited a place called Mo-yu-lo, or Mayūra, which Cunningham identifies with the neighbouring village of Māyāpur, which now forms part of the sacred town. But the distances from fixed points do not agree, and this identification, like others made by the same archæologist, which necessitate a revision of the Chinese text, must be accepted with caution (S. Julien, *Hiouen Tsiang*, Paris, 1851, ii. 330; Beal, *Si-yu-ki*, London, 1906, i. 197 f.; Cunningham, *Arch. Rep.* ii. [1871] 231). Hiuen Tsiang calls the Ganges at this point *mahābhadrā*, 'very propitious'; and even in his time vast numbers of pilgrims used to bathe in the sacred stream. It seems also to have been the scene of a cult of Buddha, because, among the broken sculptures at the Nārāyaṇaśīla or Nārāyaṇabali temple, Cunningham identifies one small figure of Buddha the ascetic, surrounded by smaller images of ascetic attendants. Doubtless this is only one survival above ground of many images of the Master. Hiuen Tsiang speaks also of a neighbouring site, known as Gaṅgādvāra, 'gate of the Ganges'; and here undoubtedly a cult of the river-goddess prevailed from a very early period.

'There is mention,' says Cunningham (*loc. cit.*), 'of Haridvāra, which, indeed, would seem to have risen on the decay of Māyāpur. Both Abū Rihān and Rashīd-ud-dīn mention only Gaṅgādvāra (Elliot, *Hist. of India*, London, 1867-77, i. 52). Kālidās also in his *Meghadūta* says nothing of Haridvāra, although he mentions Kankhal; but, as his contemporary, Amarasīṅha, gives Viṣṇupadī as one of the synonyms of the Ganges, it is certain that the legend of its rise from Viṣṇu's foot is as old as the 5th century. I infer, however, that no temple of the Viṣṇupada has been erected down to the time of Abū Rihān. The first allusion to it of which I am aware is by Sharf-ud-dīn, the historian of Timūr, who says that the Ganges issues from the hills by the pass of Coupele, which I take to be the same as Koh-pairi, or "the hill of the feet" of Viṣṇu.'

At any rate, the place was well known in the time of Akbar, because Abū 'l-Faẓl speaks of 'Māyā, known as Haridvāra' on the Ganges. It is held sacred for 18 *kos* in length (about 27 miles). Large numbers of pilgrims assemble on the 10th of Chaitra (March-April) (*Āin-i-Akbarī*, tr. Blochmann and Jarrett, Calcutta, 1873-94, iii. 306).

Both Śaiva and Vaiṣṇava sectaries are thus agreed upon the sanctity of this place. In fact, as is generally the case in India, the most famous sacred places are those whose sanctity dates from a period antecedent to the rise of the present religions. Hardwār, as the place where the great river issues from the hills, was naturally regarded as sacred from the very earliest times, and thus became a fitting abode of the deities who in succession acquired the devotion of the people. The first was the river-goddess; then Buddha; then the Hindu gods of the later period. Besides this, in the *Mahābhārata* we have a hint that a serpent-cult prevailed. Arjuna, one of the Pāṇḍava princes, is said to have come here to bathe, and met Ulūpi, daughter of the Nāgā king, who besought him to marry her (*Mahābh.* i. 214). Both Śaivas and Vaiṣṇavas rest their belief in the holiness of the place on rival legends describing the birth of the river. The former allege that the river springs from Kailāsa, the paradise of Śiva; the latter, that it falls from the toe of Viṣṇu—in support of

which they point to the impression of the footprints of the god, the *Hari kā charan*, or *Hari ki pairi*, which they display to pilgrims. The *Viṣṇu Purāna* tells of the holiness of the place as follows:

'The offences of any man who bathes in this river are immediately expiated, and unprecedented virtue is engendered. Its waters, offered by sons to their ancestors, in faith, for three years, yield to the latter rarely attainable gratification. Men of the twice-born orders who offer sacrifice in this river to the lord of sacrifice, Puruṣottama (Viṣṇu-Kṛṣṇa) obtain whatever they desire, either here or in heaven. Saints who are purified from all soil by bathing in its waters, and whose minds are intent on Keśava ["the long-haired one," Viṣṇu-Kṛṣṇa], acquire thereby final liberation. This sacred stream, heard of, desired, seen, touched, bathed in, or hymned, day by day, sanctifies all beings; and those who, even at a distance of a hundred leagues, exclaim, "Gaṅgā! Gaṅgā!" atone for the sins committed during three previous lives. The place whence this river proceeds, for the purification of the three worlds, is the third division of the celestial region, the seat of Viṣṇu' (tr. Wilson, London, 1864-77, ii. 272 f.).

A remarkable legend, told in connexion with Kankhal, a town close to Hardwār, has been interpreted to represent a conflict between the rival cults of Viṣṇu and Śiva, in which first the former, but finally the latter, acquired the ascendancy. The story as told in the *Purānas* (Wilson, *Viṣṇu Purāna*, i. 120 ff.; Dowson, *Classical Dict. of Hindu Mythology*, London, 1879, p. 76 ff.) relates that Dakṣa made a great sacrifice here, and invited all the gods except Śiva. But his consort, Satī or Umā, jealous for the honour of her lord, induced him to create a monster, Virabhadra, who was ordered to mar the sacrifice. Accompanied by the terrible goddess Rudrakālī and her train, Virabhadra attacked the assembled gods, with the result that Yama, god of death, had his staff broken, and Sarasvatī, goddess of learning, and the Mātṛi, or mother-goddesses, had their noses cut off. Yajña, lord of sacrifice, was decapitated, and he now forms the constellation Mṛigaśiras, the antelope's head. A variant of the tale makes Satī in her wrath destroy herself on the scene of sacrifice by leaping into the sacrificial fire. An ancient temple, dedicated to Śiva as *Dakṣeśvara*, 'Lord of Dakṣa,' marks the scene of the tragedy.

Hardwār, from its vicinity to Delhi, naturally attracted the attention of the Muhammadans; and Timūr, in his *Memoirs* (Elliot, *Hist. of India*, iii. 458 ff.), describes a terrible massacre of Hindus in the neighbourhood. In the course of this and later raids the ancient temples were probably destroyed. The present town and the ruins of Māyāpur, to the sanctity of which it seems to have succeeded, lie on the right bank of the river, which is here divided into several channels. One of those, which now possesses the greatest sanctity, flows past the town, and from it the Ganges Canal is supplied. The Brāhmins at the time of its construction declared that the waters of the holy river would never enter the canal or serve the utilitarian purposes of irrigation. The prediction was not fulfilled, and the benefits resulting from the project have induced the Brāhmins to accept the inevitable.

Cunningham supposes that he has identified the remains of the older sacred town, *Māyāpur*, 'city of illusion'; and this site contains three old temples. That of Māyā Devī he believes to date from the 10th or 11th cent. A.D. The principal image is a three-headed and four-handed deity, which is probably Durgā. Close by is a nude male image which probably belongs to the Jain sect. In Hardwār itself all the temples are modern, and none of them displays any architectural beauty. The chief shrine is the Gaṅgādvāra, or 'gate of the Ganges,' near the present sacred bathing-place. This temple is small, and the idol, dressed in tawdry robes, is surrounded by a number of attendant images of other gods. The

original stone marked with the footprints of Viṣṇu is said to have disappeared under water some time ago ; but a substitute has been provided.

The bathing steps have been the scene of more than one tragedy. In 1819, in the early days of British rule, before the method of regulating these enormous gatherings of pilgrims had been discovered, the rush of bathers was so great that no fewer than 430 lives were lost. These dangers have now been removed by widening the steps and regulating the numbers which enter the sacred pool. The chief risk at these crowded fairs is an outbreak of infectious disease. In 1892 a sudden epidemic of cholera made it necessary to disperse the pilgrims before the end of the fair. This led to much local agitation, and an inquiry was held, the result of which was that the charges made against the officials were found to be without foundation. The pilgrim priests (*panda*) are an ignorant, extortionate class. It was only a selfish regard for their own interests that led to this agitation, and at a later period they were active opponents of the plague regulations enforced by the Government. The chief fair occurs when the sun enters Aries. Every twelfth year, when Jupiter is in the sign Aquarius, the Kumbh Melā (Skr. *kumbha*, Aquarius), a specially large fair, takes place. Hardwicke estimated the attendance in 1796 at 2½ millions ; Raper in 1808 at 2 millions. In more recent years the attendance has diminished, chiefly because railway facilities allow of pilgrimage throughout the year, and local devotees are able to visit other and more distant holy places. The fair has sometimes been the scene of conflicts between rival bodies of ascetics. In 1760 a fierce battle occurred between the Bairāgi or Vaiṣṇava ascetics and the Gosāin, or followers of Śiva, in which the former were defeated, with a loss, it is said, of some 1800 lives. After the close of the Hardwār fair some pilgrims make their way by the difficult route to the Himalayan shrines of Kedārnāth and Badarināth (*qq. v.*).

LITERATURE.—The above account is largely based on personal observation. The report by Cunningham (*Arch. Rep.* ii. (1871) 231 ff.) is valuable, and has been to some extent summarized by A. Führer in his *Monumental Antiquities and Inscriptions*, Allahabad, 1891, p. 15f. Early accounts are those of T. Bacon, *First Impressions . . . in Hindostan*, London, 1836, II. 152 ff. ; T. Skinner, *Excursions in India*², do. 1833, i. 128 ff., 180 ff. Some of the temples and images are illustrated in W. Crooke, *PR*², London, 1896. W. CROOKE.

HAREM, HARĪM.—See WOMAN (Muslim).

HARISCHANDIS.—The Hariśchandis are a sect of Indian Vaiṣṇava ascetics. Their name is derived from that of an ancient king entitled Hariśchandra, who is said to have lived in the *Tretā Yuga*, or Silver Age. Many legends are recorded concerning him. In the *Aitareya Brāhmaṇa* (vii. 13-18) it is told how he purchased Sunahśepha to be offered in vicarious sacrifice instead of his own son.¹ This is the oldest reference to him. In later literature he is best known for his piety and his sufferings. He was a sort of Indian Job, who passed through inconceivable and undeserved woe, and had to sell even his wife and child in order to pay the dues of the rapacious saint Viśvāmitra. He finally sank to be the servant of a Dom, his duties being to collect the clothes that covered the corpses at the Benares place of cremation, and to deliver them to his master. At the climax of his sufferings in this degrading occupation, he had to steal the clothes from the corpse of his own son, which was brought thither for cremation by his mother, Hariśchandra's long-parted wife. The parents resolved to end their sorrows by dying on the son's funeral pyre. The

¹ Cf. Max Müller, *Hist. of Anc. Skr. Literature*, London, 1859, p. 408 ff.

gods then intervened. His Dom master, who was really the god Dharma, or Virtue, taking human form on purpose to test Hariśchandra's sense of duty, expressed himself satisfied. Hariśchandra and his wife were translated to heaven, and his son was resuscitated and restored to his kingdom, where he reigned in his father's stead. The whole story is told with much pathos in the seventh and following chapters of the *Mārkaṇḍeya Purāna*,¹ and is a favourite subject of modern vernacular literature.

The Hariśchandis are nearly all of very low caste, mostly Doms. They claim to practise the tenets handed down to them from Hariśchandra's Dom master, who was taught piety by his servant in the intervals of his employment. They worship Viṣṇu as the Creator of the universe ; and, if they have any other definite doctrines, they are those of the *Bhakti-mārga* (see *ERE* ii. 539 ff.).

LITERATURE.—H. H. Wilson, *Religious Sects of the Hindus*, London, 1861, i. 181 ; M. A. Sherring, *Hindu Tribes and Castes*, Calcutta, 1872-81, i. 267 ; W. Crooke, *TC*, do. 1896, li. 491 f. G. A. GRIERSON.

HARMONY SOCIETY.—See COMMUNISTIC SOCIETIES, vol. iii. p. 780 f.

HARPIES.—Rarely does a mythological figure express so unmistakably its nature by its name. The Harpies are 'Ἀρπυιαί, 'Snatchers,' creatures of rapine, and rapidity. On a black-figured vase in the Berlin Museum (Cat. 1682, *Arch. Zeitung*, 1882, pl. 9) two Harpies are figured, and against them their name in the dual, Ἀρπυιαί, 'the two Snatchers' (see fig. 1). From this vase we are certain that in the 6th cent. B.C. the Greeks conceived of the Harpy as a winged *daimon* of human female form. The vase is of special interest because, though the two winged figures are inscribed as 'Harpies,' the scene of which they form part is the slaying of Medusa. This shows that Harpies were apt to be confused with another type of monster, the Gorgon. The Gorgon is always differentiated from the Harpy by the mask-like face with tusks and protruding tongue (see GORGON), but the Gorgon is sometimes figured in Greek art as performing the functions of a Harpy, i.e. snatching away human beings.

The function of the Harpies as Snatchers comes out clearly in Homer (*Od.* xx. 77 f.) :

τόφρα δὲ τὰς κόρας Ἀρπυιαί ἀνρῆψαντο,
καὶ ῥ' ἴδουσαν στυγερῆσιν Ἐρινύσιν ἀμφιπαλεύειν.

Penelope is telling the old Lycian story of how the daughters of Pandareos waited in their father's hall while Aphrodite planned for them in Olympus a goodly marriage ; but they never came to marriageable age, for

' Meantime the Snatchers snatched away the maids, and gave them o'er

To the hateful ones, the Erinyes, to serve them evermore.'

The Harpies here are little more than ministers of untimely death ; they are only half-way towards impersonation ; and to give them a capital letter is really to crystallize their personality prematurely. It must always be remembered that to the Greek, even when the Harpies became fully personalized, their name carried its adjectival sense of 'snatchers' in a way lost to us.

To Homer, in the passage cited, they are death-demons near akin to the Erinyes, the angry ghosts. But here, as so often, Homer has moved somewhat away from primitive conceptions, of which, however, in this very passage he betrays a haunting remembrance. The Snatchers were originally not death-demons but simply winds. Penelope, just before the passage cited, prays in her desolation that the 'storm' (θύελλα) may 'snatch her away'

¹ F. Pargiter's tr., p. 32 ff. The story also occurs in the *Padma Purāna*.

(δραπέζασα), just as the 'storm-winds' (θύελλαι) snatched away the daughters of Pandareos :

ὡς δ' ὅτε Πανδάρου κόρας ἀνέλοντο θύελλαι (Od. xx. 66).

Clearly the Harpies are equated with the storm-winds. It is only incidentally as Snatchers that they perform the functions of death-demons.

cylix (fig. 2) in the Würzburg Museum (*Inv.* 354). Phineus, to the right, reclines at his banquet, attended by the women of his family, one of whom holds a large flower in token of plenty and fertility. The Harpies, the sirocco-snatchers, have been at their work fouling the feast, but for the last time



FIG. 1. Painting on Berlin vase.

As winds the Harpies have a double function : they not only snatch away to destruction ; they give life. Homer (*Il.* xvi. 150) tells us that a Harpy, Podarge ('Swift-foot'), was the mother of the horses of Achilles by Zephyros the West Wind. Both parents are winds ; but, as was natural in a mare-breeding country, the Harpy was conceived of not as a woman, but as the creature who was swiftness embodied—a fleet horse. The notion that winds could impregnate was wide-spread in antiquity. Vergil (*Georg.* iii. 274 f.) says of mares : ' . . . saepe sine ullis conjugis vento gravidae, mirabile dictu.' The winds are breaths and souls (πνεύματα); and, when breezes are spoken of as 'life-begetting' (ζωογόνοι) and 'soul-rearing' (ψυχοτρόφοι), this was not to the ancients a mere metaphor. Winds, says the author of the *Geoponica* (ix. 3), 'give life not only to plants but to all things.'

It depends, however, on what quarter of the world one lives in which wind will be beneficent

they are chased away seawards by the two sons of Boreas the clean North Wind, Zetes ('Life Blower') and Kalais ('Fair Prosperity'). North Winds (beneficent) and South Winds (maleficent) have alike four great curved wings. The sea towards which the North Winds are blowing—the topography is Thracian—is clearly indicated by dolphins. No one who has felt the blight of a sirocco will fail to understand the pestilential wind-demons.

Unquestionably in the nature and function of the Harpy the maleficent element prevailed. For this reason 'Harpy-tomb' is probably a misnomer for the famous monument in the British Museum. The bird-demons figured on it are too gentle in nature. At the same time it must be remembered that the monument comes from Lycia, the home of the myth of the daughters of Pandareos and the 'Snatchers.'

LITERATURE.—Roscher, s.v. 'Harpyia'; Cecil Smith, 'Harpies in Greek Art,' in *JHS* xiii. [1892-93] 103 (esp. for the vexed



FIG. 2. Würzburg cylix.

and which maleficent. The principal myth in which the Harpies are concerned was a Thracian one—that of the feast of Phineus; and here the Harpies clearly stand for pestilential winds which come from the South—in a word, for the sirocco, which blights man, beast, and vegetation. The feast of Phineus is clearly depicted on the famous

question of the 'Harpy-tomb' and for the interpretation of the Cyrene cup with supposed figures of Harpies); J. E. Harrison, *Prolegomena to the Study of Greek Religion*, Cambridge, 1903, pp. 176-225 (on the almost inextricable confusion between Keres, Gorgons, Harpies, and Sirens, and for the various art-monuments). Among the modern Greeks some functions of the Harpies, but not their name, are exercised by the Nereids (q.v.); but, as the Nereids perform all the functions of Nymphs in general, to discuss them here would only cause confusion.

For Nereids as active in whirlwinds, see J. C. Lawson, *Modern Greek Folklore and Ancient Greek Religion*, Cambridge, 1910, p. 142.
J. E. HARRISON.

HARRANIANS.—The Harranians were a Syrian religious community named after their headquarters, Harrān (the Haran of the OT, and Carrhae of the classical geographers). The first mention of them as a sect seems to be in the Chronicle of Dionysius of Tell-Mahré (ed. Chabot, Paris, 1895, p. 69), composed about A.D. 840; he confuses them with the Manichæans, and records an occurrence of the year 764 in which they were concerned. Owing to the fame acquired by various professional men and writers belonging to this community, they attracted the attention of Muslim authors, who composed numerous monographs about them and their tenets. Some of these are preserved, at any rate in part, in the *Fihrist*, or Bibliography, of Ibn al-Nadīm, composed A.H. 377 (A.D. 987); and accounts of them are given in the *Murūj al-Dhahab* of Mas'ūdī, composed A.H. 332 (A.D. 943), and in his later work, the *Tanbih*, composed A.H. 345 (A.D. 956). Much is also heard about them in the 6th cent. of Islām, especially in the treatise on Sects by Shahrastānī († A.H. 548 [A.D. 1153]) and the 'Guide of the Perplexed' of Moses Maimonides († A.H. 601 [A.D. 1204]). The community seems to have disappeared during the devastation of Mesopotamia by the Mongols in the 7th cent. of Islām.

Islāmic writers usually call them Sabians (*Ṣābi'ah*)—a name which occurs in the Qur'an, where those who bear it are treated with some respect; and, according to some of the Muslim authorities, the Harranians adopted it in A.H. 218 (A.D. 833), in order to obtain recognition as a tolerated cult. The name itself, it is thought, really belonged to quite a different community, viz. the Mandæans. This account of the appellation, which was first enucleated by Chwolsohn in his monumental treatise on the *Ssabier* (St. Petersburg, 1856), has ordinarily been accepted; but it is not free from difficulty, for Ṭabarī († A.H. 310 [A.D. 922]), in his Commentary on the Qur'an (i. 243, Cairo, 1321), after Yūnus b. 'Abd al-A'la († 264 [877]) after Abdallah b. Wahb († 197 [812]) after Usāmah b. Zaid († 153 [770]), locates the Ṣābi'ah in the Jazīrah of Mauṣil, which, though somewhat vague, is a correct location of Harrān, but would not suit the Mandæans. If these authorities are correctly given, the connexion between Harrān and the Ṣābi'ah must have been three-quarters of a century earlier than the date given in the *Fihrist*; and the earliest geographer Iṣṭakhrī (c. A.H. 300 [A.D. 912]) mentions Harrān as the city of the Ṣābi'in (p. 76, ed. de Goeje, 1870), without any suspicion that the connexion was less than a century old. 'There,' he says, 'are their seventeen sacristans (*sadanah*).' Neither of these authorities was accessible to Chwolsohn. Further, it would appear from good traditions that the followers of Muhammad were known by their enemies, and even to some extent among themselves, as *Ṣābi'ah*, and this seems to bear some relation to the title which Muhammad connects with Abraham, *Hanif*, and which he gave his own community. For Christian writers frequently speak of the Harranians as pagans, *hanpē*, and Abraham is connected with the city of Harrān in Ac 7⁴ rather more decidedly than in the narrative of Genesis. The controversial but decidedly learned writer, Ibn Ḥazm († 456 [1063]), in his *Fīṣal wa-Mīlāl* (Cairo, 1317, i. 35), has no hesitation in identifying the Harranians with the *Ṣābi'ans* of the Qur'an, and supposes that Abraham was sent to convert them, and that during his time they took the name *Hanif*. According to him, they believe,

like the Mazdæans, in two eternal elements; they honour the seven planets and the twelve constellations, and paint them in their temples; they offer sacrifice and incense; but they have five prayers similar to the Muslim ceremony, they fast in Ramaḍān, turn to the Ka'ba in prayer, and regard the same meats as unlawful as are so regarded by the Muslims; their religion was then identical with that afterwards restored by Muhammad, except that they had introduced the worship of the stars and of idols, which Abraham endeavoured ineffectively to abolish.

Although this account has many inaccuracies of detail, it is confirmed in some important matters by the others; and it seems to solve one of the puzzles of Islāmic history, viz. the adoption by Muhammad of the name *hanif*, while he himself was called *ṣābi'* by his contemporaries. But this would imply that the latter name was used either by or for this community in his time, whence we should suppose that the story adopted by Chwolsohn was a fiction invented by its enemies—a supposition which is by no means unlikely. The origin of the appellation *Ṣābi'ah* is obscure. Ṭabarī in his history (i. 178) derives it from one Ṣābi', a son of Methuselah, but in his Commentary (i. 243), like the lexicographers, he supposes it to come from a verb *ṣaba'a*, 'he changed his religion,' which appears to be an inference from the application of the name to Muhammad and his followers. A rather better etymology seems to be that put into the mouth of a Ṣābi'an by Shahrastānī (p. 203), from *ṣabā*, 'to desire,' since that verb is also found in Syriac, and would have an exact analogue in the name *murīdūn*, 'aspirants after the knowledge of God,' which is taken by Ṣūfī novices, and has even been used as the title of a sect.

The accounts of the Harranian system preserved by the Muslims purport to come either from members of the sect with whom the authors came in contact, or from Arabic translations of their sacred books. One of the latter was made by order of a *qādī* of Harrān, and, according to the author of the *Fihrist*, was widely read; of another, called the 'Book of the Five Mysteries,' he had come across a mutilated copy. A Harranian calendar was composed by Abū Sa'id Wahb b. Ibrāhīm, the Christian contemporary of Ibn al-Nadīm, who gives it *in extenso*; and another is embodied by al-Bīrūnī in his *Chronology of ancient Nations* (A.H. 390 [A.D. 999], tr. Sachau, London, 1879, pp. 314–320). The *Fihrist* also embodies a list of Harranian gods, and some other matter of an analogous kind. A magical treatise called *Ghāyat al-Ḥakīm*, of about A.H. 440 (A.D. 1048), also contains what is ostensibly a lengthy extract from a Ṣābi'an book. Finally, Shahrastānī reproduces a lengthy dialogue between the Ṣābi'ans and the Hanifs.

From a comparison of these documents, Chwolsohn inferred that the Harranians were, as the Christians called them, pagans, i.e. a community who had retained a mixture of Babylonian and Hellenic religion, over which there had been superimposed a coating of Neo-Platonic philosophy (chiefly among the educated), while certain features had also been adopted from one of the monotheistic cults, possibly through the influence of the surrounding Muslims. This view perhaps harmonizes the evidence before us as well as it is possible to harmonize it; yet the Muslim authors seem to call attention with justice to certain features which Ṣābi'ism shares with Islām, especially three daily prayers measured by inclinations and prostrations, which imply that they were a real sect, i.e. followers of a system founded by some person or persons, rather than that their worship was a survival modified by unconscious syncretism. The 'prophets

whom they professed to follow were Hermes and Agathodæmon, whom they identified in Shahrastāni's time with Seth and Idris (Enoch); these names appear to belong to the Hermetic period of Hellenic religion (G. Murray, *Four Stages in Greek Religion*, 1912, p. 95).

Of the documents mentioned above, the most authentic appears to be the list of gods, which, however, is so seriously corrupted or mistranslated that little can be made of it; in another account the Harranians are said to sacrifice to the gods of the seven week-days, whose names are partly Babylonian, partly Greek. To these the sacrificial calendar adds 'demons, *jinn*, spirits, the god of the *jinn*, the lord of the hour, the god who makes arrows fly; the god Tawūz (or Tammūz), who was slain by his master, who then ground his bones in a mill, and scattered them to the winds; Haman the prince, father of the gods, the prince of the *jinn*, the greatest god, the god North, the lord of fortune,' etc. The account of their sacrifices contains much that is incredible; the sacrificial animals were, according to it, in many cases burned alive; and on one day they would sacrifice a child, whose flesh was thoroughly boiled and made into cakes, which were then eaten by a certain class of the worshippers. On a particular day they prayed for the destruction of the Mosque of Harrān, the Christian Church, and the Women's Market; to be followed by the restoration of their kingdom. It seems clear that the calendar is the work of an enemy of the sect. The story, however, of the human sacrifice appears to have been brought up as frequently as the modern accusation of the same kind against the Jews. Dionysius (*loc. cit.*) asserts that they annually entrapped a victim, whom, after keeping for a year, they decapitated with a view to divining by his head; and this story is separately told in the *Fihrist*, where, in lieu of decapitation, they are said to have boiled the body so long that the head came off. The victim, according to this account, was a person who displayed 'mercurial' qualities, which are explained in the *Ghāyat al-Hakim*. In the story of Dionysius, one of their victims succeeded in escaping and invoking the Muslim authorities, who severely fined the delinquents; we may, however, be sure that the practices described in this calendar would never have been tolerated by the Muslim rulers. Al-Bīrūni's calendar agrees in some respects with that of the *Fihrist*, but contains many more names. The chief accounts agree in making the Harranians pray towards the north, and fast for thirty days, distributed between December, February, and March. They had a law of purity resembling in several respects that of the Jews, and they had a table of unlawful meats, wrongly identified by Ibn Ḥazm with that of the Qur'ān, since they tabued the camel.

Most of the accounts make star-worship a chief characteristic of the Sābi'an system, and in the magical treatise published by Dozy they are credited with an elaborate astrological theology. As, however, the author gives reasons why no Sābi'an can ever divulge the mysteries of his faith, the authenticity of this document is self-condemned. The 'Book of the Five Mysteries,' from which extracts are reproduced by the author of the *Fihrist*, appears to be a service-book, in which there are versicles and responses repeated by the *kāhin* (priest) and a congregation of youths, apparently identified with the *bughdārī* (an uncertain word, which may be Persian). The matter of this service-book is so poor that the author of the *Fihrist* suggests that the translator was either a bad scholar or translated too literally.

Mas'ūdī and Shahrastāni treat the Sābi'ans as philosophers rather than as pagans; besides temples

to the planets, which, according to Mas'ūdī, were in a variety of geometrical figures, they had temples of the First Cause and the Reason, of the Chain, Matter, and the Soul. In Mas'ūdī's time only one temple remained—that of *μεγάλη θεά*, 'the great goddess,' which, however, the Muslims supposed to be dedicated to Abraham's father, called in the Qur'ān Azar. The knocker of the door bore an inscription in Syriac characters which Mas'ūdī was told meant 'Whoso knows himself is religious,' supposed to come from Plato. He also tells of a ceremony of initiation undergone by the Sābi'an youths in the vaults of this temple, similar to one described in the magical treatise. Shahrastāni's 'Debate' makes the Sābi'ans defend by metaphysical arguments their practice of approaching the First Cause indirectly by sacrifices and prayers to the intermediaries, who are the powers attached to the celestial spheres.

Many works by Sābi'an authors are still extant, but they appear to throw no light upon their tenets. Their most famous man of science was Thābit b. Qurrah (A.H. 211–288 [A.D. 826–900]), who translated various Greek scientific works into Syriac and Arabic. Equally distinguished as a secretary of state was Ibrāhīm b. Hilāl (313–384 [925–994]), many of whose letters and poems are preserved. We learn from his biography (Yāqūt, *Dict. of Learned Men*, ed. Margoliouth, 1910, i. 324–358) that the family profession was medicine, as was the case with other Sābi'ans of note. Ibrāhīm was famous for his accurate acquaintance with the Qur'ān—a qualification indispensable in his vocation. The private letters of this personage do not appear to differ in their religious expressions from those of professed monotheists.

Until some discovery is made of genuine works belonging to the sect, their origin and tenets must remain obscure. A certain amount of veracity is attested for the Muslim accounts by the number of Syriac words which they contain; and it is noticeable that some Muslims call them 'Chaldæans' and others 'Chasdæans' (so Fakhr al-dīn Rāzī, † 606 [1209]), which perhaps was a title that they assumed. The polemic put in the Qur'ān (vi. 74–83) into the mouth of Abraham, who endeavours to convert his father from the worship of idols, and himself repudiates the worship of the heavenly bodies, bears a curious likeness to that which Shahrastāni ascribes to the 'Ḥanīfs' in their reply to the Harranian Sābi'ans.

LITERATURE.—Besides Chwolsohn's work mentioned above, there is text and tr. of the extract from *Ghāyat al-Hakim* by Dozy and de Goeje, in the *Actes du sixième Congrès des Orientalistes*, Leyden, 1888, ii. 285 ff.

D. S. MARGOLIOUTH.

HARTMANN.—See PESSIMISM AND OPTIMISM.

HARVEST.—The ceremonies and observances of primitive races before, during, or after harvest belong to a group of customs which have gathered round the critical seasons of the year. The exact date at which such celebrations or ritualistic observances are carried out varies according to the character of the community. Among tribes whose chief occupation is hunting, the opening of the hunting season will, as a rule, be found to be marked by a ceremony which has for its object to secure a plentiful supply of game and the success of the hunters. In agriculture, the most critical season to the primitive mind is the time of sowing. This period of the year is marked by magical rites and practices intended to ensure the growth and fertility of the crop. As the year goes on, various means are employed to influence the course of natural phenomena or avert the evil consequences of untoward conditions, such as an inadequate

rainfall. Harvest observances, though in their most obvious aspect in a civilized community they celebrate only the turn of the year and the fruition of the labours of the preceding months, depend, to the primitive mind, upon the same principles as the rites of the earlier stages; and consequently the harvest is not simply an occasion for rejoicing, but a time at which natural forces have still to be propitiated.

Taking harvest rites as a whole, the essential elements resolve themselves into three: (1) propitiatory rites; (2) observances to secure fertility; (3) communion, and the offering of firstfruits, usually accompanied or followed closely by a feast, a period of licence or rejoicing, which in the course of development tends to become simply a celebration of the end of the labours of the year. These elements do not necessarily all appear in all harvest practices, nor are they always clearly distinguishable. A rite may exhibit features which would justify its classification under more than one head.

1. Propitiatory and cognate rites antecedent to the harvest.—At a stage of belief which attributes a soul or spirit to objects both animate and inanimate, the act of destruction involved in plucking fruit or killing an animal for human consumption is one of peculiar danger. In both cases the spirits of the animal or vegetable world must be propitiated to avert the evil which would otherwise inevitably follow assimilation. In the case of corn, which impresses the mind merely by the regularity of its growth and the effect of space it gives, the feeling of danger is intensified by the fact of human interference with the course of Nature in cultural operations, as well as by the organized and prolonged effort required to secure the crop. This deduction from the general character of religious beliefs among primitive people is fully borne out by their practices at the opening of the harvest.

Among the ancient Egyptians, the reaper, after cutting the first few blades of corn, atoned for the impiety of his act by beating his breast and uttering the lament which the Greeks called *Μαυίρα* (Herod. ii. 79); in Greece, just as the death of vegetation was bewailed in the *Linus* song, a song was sung over the corn-stack (*Ίουλος*), and in Babylonia the death of Tammuz (obviously, from the legend, a personification of the corn) was bewailed by the women. The feast of Demeter Chloë, which was held at Athens on the sixth of Thargelion, at about the time when the corn was ripe, was a solemn feast of purification and of mortification, and probably was originally the feast of atonement and propitiation before the gathering of the harvest (L. R. Farnell, *CGS*, Oxford, 1896-1909, iii. 34). The Nandi woman, when she goes with her daughters to pluck the first ears of eleusine grain in her plantation, is actuated by the same motive: the plucking is a solemn function with a regular ritual, and the crop as a whole can be gathered only when the corn has been accepted by the spirits (A. O. Hollis, *The Nandi*, Oxford, 1909, p. 46).

Among the Thangkuls of Manipur, no work other than that of attending the crop is done from the time of the first *genna*, or *tabu* period, which follows the sowing. Among the Mao group of the same district, a *genna* lasting for four days is observed at the beginning of the harvest (T. O. Hodson, *The Naga Tribes of Manipur*, London, 1911, p. 167 ff.). Any action which might prove prejudicial to the crops is thus prevented. A ritual must be observed at the time of plucking the first fruit or seed, before the real harvest begins, to secure a plentiful crop and to avoid offence to the spirits (see art. *FIRSTFRUITS*).

Another indication of the sacrosanct character of the crop is that the first sheaf is sometimes cut by some one specially designated. In Ceylon, among the Burghers, the first sheaf is cut by a Kurumba, a man belonging to a tribe whose members are looked upon as magicians. Among the Kurgs of Southern India, the man who has to cut the first blades of corn is chosen by an astrologer, and in the ceremony which follows he is not allowed to mix with other members of the tribe until the loaf made from the grain of the blades he has cut has been eaten. In one part of Yorkshire, the first corn was cut by the vicar, and from this corn the bread for the communion was made.

(1) *The 'corn-spirit.'*—Customs connected with the gathering of the harvest and the threshing of the corn which are practised, or were practised until recently, among the European peasantry point to the survival of a belief in a spirit immanent in the corn, or closely connected with its fertility. The existence of this belief is affirmed by the epithets 'corn-mother,' 'pea-mother,' and 'rye-

mother,' according to the nature of the crops. In Lithuania it was believed that an old woman sat among the corn; both in Germany and in Poland, children were warned against entering the cornfields or treading down the corn because of the 'corn-mother.' The 'corn-mother' is sometimes identified with Death, and the children are warned against entering the cornfield because 'Death sits among the corn'; the last sheaf is sometimes known as 'the Dead One,' and in a children's game played in Transylvania Death is represented by a child dressed in maize leaves. At Dinkelsbühl in Bavaria, the corn-mother was said to punish the farmer for his sins by giving him a bad harvest.

The precise character of the beliefs is still more clearly indicated by customs followed at various stages of the work. The spirit is supposed to reside in the last sheaf of corn, the object of the reapers or threshers being to drive it away or catch it. In Hanover, the reapers beat the last corn with sticks until all the grain has fallen from the stalks, when the corn-spirit is said to have gone. A more common practice is to make the last blades of corn into a doll—the 'corn-mother.' At Dantzic, the doll is brought home in the last waggon. Frequently the doll is dressed in women's clothes, as in Holstein. When the 'corn-spirit' is conceived as an old woman, the doll is made by one of the elder women, but when the corn-spirit is thought to be young, a 'maiden,' the task usually falls to the lot of a young girl. This presents an analogy to the Mexican belief that the corn-spirit aged as the crops grew and approached maturity: victims of appropriate age were offered at different seasons, varying from young children at the first growth to old men sacrificed at harvest time.

At Bruck in Styria, the ideas of youth and age were combined. The doll was appropriately bound, usually by the oldest married woman under fifty-five in the village, but the finest ears of this sheaf were plucked out to make a wreath for the prettiest girl, who carried it to the farmer. The 'corn-mother' was either placed in the barn at once or carried on a pole behind the girl who took the wreath to the farmer, and then placed on a pile of wood to form the centre of the harvest supper and dance; it was afterwards hung up in the barn until the threshing was over. Sometimes the man who cut the last blades of corn from which the doll was made was wrapped up in the corn-mother and carried round the village by the other reapers. The wreath was dedicated in church on the following Sunday, and at Easter the grain was rubbed out by a seven year old girl and scattered among the young corn, while the straw was given to the cattle at Christmas to make them thrive.

The customs described present, on analysis, several elements which are closely akin to the animistic beliefs of more primitive races. Briefly, these elements may be stated to be: (a) the immanence of a spirit in the crop and especially in the last corn cut, to which material expression is frequently given by an emblem or figure, usually human; (b) the conception of maturity in the corn-spirit, accompanied, however, by a parallel conception of youth; (c) the idea of sympathetic connexion in the performers of certain rites, shown, for instance, by the age of the binder of the doll and the wearer of the wreath; (d) the sacrosanct character of the act of cutting the last blades of corn, the reaper being sometimes identified with the corn, sometimes treated as though guilty of a crime; (e) the vitality of the corn-spirit, as signified by the preservation of its material representation, which ensures fertility in the future when given in part to the cattle and in part mixed with the crop of the following year.

The ritual of Osiris and Isis in ancient Egypt and the myth on which it was based, as well as the epithets *Μάκαιρα*, *Τελεσφόρος*, *Καρποφόρος*, applied in Greece to Gaia, and *Καρποφόρος*, *Μεγδαρτος* ('goddess of the great loaf'), and *Χλόη* ('the verdure'), to Demeter, whose name, it is suggested, means 'barley- or spelt-mother' ($\Delta\eta = \Gamma\eta$ or *Zeíd*), and the legends and ritual of worship of Gaia, Demeter, and Kore, seem to point to an earlier belief, in which these deities were identified with the corn in the same manner as the 'corn-spirit' of more primitive races—a phase in a general belief in a vegetation-spirit out of which grew the worship of Adonis, Attis, and Dionysus, as well as of the deities more specifically connected with the corn (see *GB* ii. ; and *CGS* iii. chs. i.-ii.).

(2) *Various forms in which the corn-spirit is conceived.*—

Among the Slavs, the last sheaf is known as the 'Wheat-mother,' the 'Rye-mother,' the 'Oats-mother,' the 'Barley-mother,' etc. At Westerhüsen in Saxony, the last corn cut is made into the shape of a woman and decked in ribbons and cloth. In the district of Tarnow in Galicia, while known by the same name, it is made into the form of a wreath. In Auxerre in France, the last sheaf is known as the 'Mother of the Wheat,' etc., and is left standing in the field until the last waggon is about to go home. It is then made into a doll and dressed in clothes belonging to the farmer, a branch is stuck in its breast, and it is set in the middle of the floor at the dance in the evening. At Osnabrück, the last sheaf is known as the 'Harvest Mother.' In Erfurt, a very heavy sheaf, but not necessarily the last, is known as the 'Great Mother.' In East Prussia, the sheaf is known as the 'Grandmother.' Near Belfast, the last sheaf is known as the 'Granny,' its special character being shown, as is not infrequently the case, not merely by a name being given to it, but also by a special manner of cutting: the reapers stand a little distance away, and cut the corn by throwing their hooks at it. In Pembrokeshire, the same method of cutting is followed. At Altisheim in Swabia, all the reapers stand before the last strip of corn and all cut together.

In some parts of England, the last sheaf was known as the 'Kern baby.' The name given to it in the North Riding of Yorkshire was the 'Mell sheaf,' while in Kent it was known as the 'Ivy Girl.' In many places in Scotland it was known as the 'Maiden,' and was usually decked with ribbons; it was also known as the 'Carlin' or 'Carline,' i.e. the 'old woman,' especially where it was cut after Halloween. If cut before sunset, it was more usually known as the 'maiden'; while, if cut after, it was called the 'witch.' Another name commonly used both in Scotland and in Germany is the 'Oats-bride' or 'Wheat-bride.' In Germany, an 'Oats-bridegroom' and 'Oats-bride' are sometimes fashioned with garments of straw; these garments are then plucked from them straw by straw 'till they stand as bare as a stubble field' (Frazer, *GB* ii. 186). In Silesia, the male and female puppets were conducted to the farm house with all the ceremony of a wedding procession.

This method of personification of the crop was not confined to the European peasantry. It is recorded of the ancient Peruvians that they took a portion of the most fruitful of the maize and put it in their granaries. This was dressed up in new garments and known as the 'mother of the maize' (Acosta, *Nat. and Moral Hist. of the Indies* [Hakluyt Soc., 1880], ii. 374). In the Panjáb, a specially fine cotton plant is selected, which is known as the 'mother-cotton,' and anointed with buttermilk and rice-water. The Malays, the Dayaks, and the Karens of Burma, at harvest time, perform rites to secure the 'soul of the rice,' and thus ensure the fertility of the crops. Among the Dayaks, the chief priest goes through a performance with a bundle of charms in his hand; while gazing in the air, he makes a rush at some invisible object; and then, when he shakes his charms over a cloth, a few grains of rice fall into it which are carefully folded up and placed on an altar specially prepared. Among the Minangkabau of Sumatra, Saning Sari, the goddess of the rice, is represented by stalks known as the 'mother of the rice,' grown from special grain, which has been planted and harvested with special ceremonies, and cut only after the firstfruits have been eaten in a festal meal. The rice-mother is fetched home in a neatly worked bag and under an umbrella by persons in gay attire, and placed in the barn. In the Malay Peninsula, the 'rice-mother' and her 'child' are represented by sheaves or bundles of ears in the harvest field (W. W. Skeat, *Malay Magic*, London, 1900, p. 225f.). The 'bride' and 'bridegroom' of Silesia find their parallel in Java, where the priest picks out a number of ears, ties them together, smears them with ointment, and adorns them with flowers. When the harvest is being carried in, they are provided with a bridal chamber in the barn.

In these customs the last sheaf has appeared as a human being. It is not infrequently described as an animal.

In Germany, when the wind makes the corn wave, it is said to be a 'wolf in the corn.' The children are told that the 'rye-wolf' will eat them up. The wolf is also said to be in the last

sheaf. Near Cologne, the last sheaf was made up in the form of a wolf, and was kept in the barn until the whole crop had been threshed. At Wanzleben, the wolf was driven out of the corn with the last strokes of the flail. Both in Austria and in Germany a cock was sometimes hidden under the last sheaf, and the man who caught it could keep it. In Hungary and Poland, a live cock was sometimes buried in the ground, and its head struck off with the scythe. In Galloway, 'the hare' was cut by the reapers throwing their hooks. In Prussia, Sweden, Holland, and France, the reaper who cut the last sheaf was said to kill the hare, while near Kiel the animal was the cat, or, near Grünberg, the tom cat. At Straubing, horns were stuck in the sheaf to represent a 'horned goat,' while sometimes a live goat was brought on the field, chased by the reapers, and killed by the farmer, as at Grenoble. In the district of Bunzlau, the last sheaf was made up in the form of an ox or cow, stuffed with tow, and wrapped in corn ears. In Bohemia, a sheaf in human form was called the 'buffalo bull.' So also the name 'cow' is given to the last sheaf in Swabia and in Switzerland. An ox is killed on the field in parts of France, and on the threshing-floor the last stroke of the flail 'kills the bull.' Among other animal forms taken by the last sheaf, or connected with harvest beliefs, may be mentioned the horse or mare, which appears at Stuttgart and in Shropshire; the quail, in Normandy; the fox, in Poitou; and the pig and sow, in Swabia, Upper Bavaria, and other parts of Germany.

(3) *Connexion between the last sheaf and the reaper.*—Reference has already been made to the custom whereby the last sheaf is bound or made into the form of a puppet by a woman of an age appropriate to the conception that it represents an old or young woman. By an extension of the custom, the person who performs the office is frequently known by the same name as the doll, or is specially identified with it.

In East Prussia, the reaper who cuts the last blades is said to 'get the grandmother.' In Swabia at Altisheim the man who makes the last stroke when the last strip of corn is cut by all together is said to 'have the old woman.' The same assimilation of the sheaf and the reaper takes place where the sheaf is known by the name of an animal, and in numerous instances the reaper is said to 'have the dog,' the 'pig,' etc. At Neusaass (West Prussia), both the last sheaf and the reaper who cuts it are called the 'old woman.' At Hornkampe (West Prussia), on the other hand, the last sheaf is known by the name of any one who lagged behind in his or her work. At Coburg it is believed that to cut the last sheaf entails marrying an old woman or old man within the year. Where the last sheaf is thought to embody youth, it is sometimes believed that the woman who cuts it will have a child within the year. Brand records (*Pop. Ant.*, ed. W. C. Hazlitt, London, 1905, s.v. 'Harvest') that in the north of England both the girl who cuts the last sheaf and the sheaf itself, which is decked out with ribbons and carried home with great rejoicing on the last waggon, are called the 'Harvest Queen.' The 'wheat bride' of Müglitz in Moravia cuts the last sheaf and wears the ears; it is said that she will be married within the year. In the ceremonies of the Mandans and Hidatsa of North America, at the maize harvest, the 'old woman' who looks after the crops is represented by old women who dance with ears of maize in their hands.

The identification is made still more complete when a man or woman, usually the reaper or binder of the last sheaf, is not only made the subject of derision, but is wrapped up in the last sheaf. The explanation of this may be found in the belief that, when the spirit is beaten out of the last standing blades of corn, it enters into one of the bystanders. The rough horse-play of the harvest field thus embodies one of the most primitive forms of belief, viz. that anything coming into contact with what is filled with a mysterious 'power' and is therefore tabu will itself be filled with that 'power' and likewise become tabu.

At Neusaass, the 'old woman,' which is dressed up with hat, ribbons, and jacket, and the woman who gets it, i.e. the binder of the last sheaf, are carried home together; so also at Hermsdorf in Silesia. In Poland, the woman who bound the last sheaf was wrapped up in it and carried home; she sat in the sheaf throughout the supper and dance, and, as was common in many districts, was known by the name given to the sheaf—in this case *baba*—throughout the following year.

Similar customs appear in the practices attendant on threshing the corn.

In Bavaria, the last sheaf threshed was known as the 'old woman,' and some person was dressed up in the last straw carted, and carried through the village. The practice of La Vendée shows the almost complete identification of a person and the corn. There, the farmer's wife was tied up in a sheet with the last sheaf and carried to the threshing machine, under which she was pushed with the corn. She was then pulled out and tossed in the sheet—an obvious simulation of winnowing. Sometimes, in Lithuania, corn is threshed on the back of a man who lies down under the last sheaf. At Wanzleben, after the

wolf has been driven out by the last stroke of the flail, a man is led through the village with a chain round his neck, as though he were the wolf caught in escaping. In Poland, a man in a wolf's skin is led about in a similar manner at Christmas.

The practice of carrying a live cock, pig, or ox on the harvest field is another phase of the transference of the spirit of the corn to a material object.

2. Fertility charms.—The importance of an adequate rainfall for the proper growth and nourishment of the crops being so great, it is not surprising to find that many of the customs connected with the harvest should appear to have as their object the securing of such a rainfall by means of sympathetic magic. The custom of drenching the corn-mother with water as it was carried home is an instance of such a rain charm.

In Neusaass, both the sheaf and the reaper who cut it, when brought home together, were drenched with water. In Poland, the woman known as the *baba* was drenched as she was carried home. Sometimes men were stationed behind the farm-gates with pails of water ready for the home-coming. In Rutlandshire, where children were carried on the last cartload of the bean harvest, a regular pitched battle with water and apples was fought between the maidservants and the men, from the gates of the farm until the waggon came to rest in the bean-yard (Brand, *loc. cit.*). In Bulgaria, the corn effigy was thrown into the river after it had been carried round the village. In Carinthia, the man who has been wrapped in straw to personate the corn-mother on the threshing-floor is rolled in a brook. The 'gardens of Adonis,' the small bowls of sprouting grain which the Athenian women planted and tended with special care for eight days at the time of the springing of the corn—a practice intended to secure the fertility of the crop by sympathetic magic—were thrown into the river to ensure rain.

Frazer (*GB*² ii. 225) suggests that the throwing of the corn-mother into the river may be a survival of the practice of throwing the body of a human victim into a river, just as the custom of burning the 'Ceres' at Auxerre after the harvest dance and of burning the corn-mother in Bulgaria and scattering the ashes recalls the practice in Egypt of burning a human victim and scattering his ashes on the fields to secure the fertility of the crops.

Many customs are intended to secure a plentiful crop in the following year.

In Westphalia, the 'harvest-mother' sheaf is made heavy with stones, in the hope that all the sheaves in the next year will be equally heavy. At Alt-Pillau, eight or nine sheaves are bound together to make one huge sheaf. In Scotland, in the Isle of Lewis, the 'old wife' is dressed up, her dress including an apron tucked up to make a pocket, which is stuffed with bread and cheese and a sickle.

Frequently it is believed that the same object will be attained by preserving the material embodiment of the corn-spirit—the 'hag,' 'old woman,' or 'corn-baby'—throughout the year.

In Pembrokeshire, the 'hag' is carried home by one of the reapers; the other reapers handle him roughly, throwing water at him. If he is successful in carrying the 'hag' to the farm dry, the farmer pays a small fine, and the 'hag' is kept in the farm until the next year. The 'Kern-baby' in England is kept in the farm-parlour for the rest of the year. At Balquhider, in Scotland, the 'maiden' is kept in the house until the next 'maiden' is brought in. Near Cologne, where the last sheaf is known as the 'wolf,' the wolf is supposed to be at the farm throughout the year.

The corn-spirit is supposed to live throughout the year; and the practice of mixing part of the grain from the 'corn-maiden' with the seed ensures the presence of the spirit in the crop of the following year.

On the Styrian farm, the wreath which formed part of the last sheaf and has been kept through the winter is scattered among the springing crops in the following year; its influence on the wellbeing of all forms of life is shown by the straw being placed in the manger of the cattle at Christmas. In Tarnow, in Galicia, the wreath is mixed with the seed corn. In the north of Scotland, the 'maiden' was given to the cattle on Christmas morning, at Balquhider to a mare in foal, or the oldest cow. On Islay, the 'old wife' is kept throughout the winter. When the men first go out to plough in the spring, they carry the grain taken from her in their pockets, and give it to their horses to eat, in order to secure a good harvest. The marriage procession in Silesia is obviously intended to bear on future fertility. The Zapoteca, after keeping the maize sheaf through the winter, buried it in the fields from seed time to harvest to quicken growth. The old Prussians suspended a goat skin in the field from sowing time to harvest to superintend the

growing of the corn; in Upper Bavaria the last sheaf is called the 'goat.' In the course of the maize harvest dance of the Akikuyu, in which all the performers were dressed in maize leaves, a small image of dried clay was unwrapped from banana leaves and held at the level of the face by an old man for adoration. It was then put away in its usual resting-place—a store of flour (W. S. and K. Routledge, *With a Prehistoric People*, London, 1910, p. 188). At the close of the Nandi harvest ceremony, after the old men have eaten a pregnant goat, the women take two pebbles from the nearest water, one of which is kept throughout the year in the water jars and the other in the granaries. In the Malay Peninsula, where the 'rice-child' and the 'rice-mother' appear together, the 'child' is kept to be mixed with the seed in the following year. The Chams of Binh-Thuan, Indo-China, keep three ears of corn to form three furrows in the 'field of secret tillage' in the following year. A custom which bears some analogy to the 'child' or 'rice-mother' of the Malays appears in Normandy, where a small sheaf is wrapped up inside the big one. In West Prussia, a simulated birth takes place on the field. With this may be compared the legend in Greek mythology of the intercourse of Demeter and Iasion in a corn-field, which resulted in the birth of Ploutos. At Dijon, where 'Death' cuts the last ears of corn and slaughters an ox, part of the ox is eaten at the harvest supper, and part is pickled to be eaten on the first day of spring. In Berry, the corn-spirit is born on the field as a cow-calf.

On the other hand, the 'hag' is sometimes passed to other farms. In some parts of Pembrokeshire, after the 'hag' had been cut by the reapers throwing their sickles at it, it was taken, usually by the ploughman, to the field of a neighbour, where the work was still in progress, and thrown at the foreman from behind a hedge. The ploughman immediately ran away, pursued by the reapers working in the field. In parts of Scotland both an 'old wife' and a 'maiden' were cut. According to one account, this was the result of a competition between two sets of reapers, those who finished first getting the 'maiden,' while the others got the 'cailleach' or 'hag.' According to another account, the competition was between neighbouring crofters, the 'cailleach' being passed on from farm to farm and retained by the farmer whose harvest was completed last. In North Uist the 'cailleach' was put overnight among the standing corn of lazy crofters. The same custom was followed in threshing; e.g., in Thuringia, when the corn had been threshed, the last sheaf was taken to a farm where the threshing was still unfinished.

Sacrifice and fertility.—It appears that cutting or binding the last sheaf entails certain penalties, while the farmer who finishes his harvest later than his neighbours is in some districts penalized with the custody of the 'hag.' The obvious explanation is that the consequences are decreed by rustic wit for lack of dexterity. On the other hand, the close identification of the last sheaf and the reaper, when viewed in the light of other practices, suggests a less obvious reason. In the Romsdal and in other parts of Norway, when all the hay has been cut, the 'old hay-man' is said to have been killed. In Bavaria, the reaper who cuts the last sheaf is said to have killed the 'old man.' In Lithuania, 'Boba's head is cut off.' Sometimes a straw pygmy is put under the last sheaf, and the 'old woman is struck dead.' A stranger who crosses the field is pursued and tied with straw-bands, and must pay a ransom before he is released, or the farmer himself may be bound when he enters the field. In Mecklenburg, the reapers advance in a body towards the farmer, shouting and sharpening their scythes as if preparing for a sacrifice; and so also on the threshing-floor. At Wiedingharde, in Schleswig, any stranger on the threshing-floor is nearly throttled with the flail, which is put round his neck as if he were a sheaf of corn.

The custom of human sacrifice to secure the fertility of the crops appears to have been widespread. In the earlier stages of the practice the victim appears to have been regarded as the embodiment of the corn-spirit. This must be held to be the reason for scattering his ashes on the field, or throwing his body in the river; while the solemn feasts at which the victim's body was eaten by the ancient Mexicans lend support to the view that they also believed that by partaking of the body of the corn-spirit they ensured a good harvest. It has been conjectured that the head-hunting practices of the Nāgas of Manipur, and their custom of setting up a straw figure at which they

shoot with arrows at certain times, may be connected with agriculture. When the figure is hit, the one who hits it in the head, it is said, will take a head, but the one who hits it in the stomach will have good crops (T. C. Hodson, 119). The connexion between human sacrifice and fertility is also shown in the custom of the Indians of Guayaquil of scattering human blood on the fields at the time of sowing, while at the Mexican harvest a criminal was crushed between two falling stones when the firstfruits were offered. The Mexicans, as already stated, offered a series of sacrifices to make the maize thrive, culminating in the sacrifice of an old man at harvest time. Among the Pawnees and Sioux, human sacrifice was offered in the spring; and, in one case described among the latter, after the heart of the victim had been eaten, the flesh was cut in small pieces and scattered on the fields.

Instances of human sacrifice to secure good crops are recorded in West Africa, at Benin, and among the Bechuanas and other races, usually in connexion with the sowing of the crops, or at the time of their early growth, to promote fertility. Among the Khonds, part of the victim was buried as an offering to the earth-goddess; if the victim wept copiously, it was a sign of a plentiful fall of rain (S. O. Macpherson, *Memorials of Service in India*, London, 1865, p. 113). Among an agricultural tribe in Uganda, the sacrifices took place at about the time of the harvest. The Tshi offered a human victim at the yam harvest, pouring his blood into a hole in the ground (A. B. Ellis, *The Tshi-speaking Peoples*, London, 1887, p. 230).

Greek ritual and belief preserve traces of human sacrifice in connexion with fertility. The legend of Aglauros casting herself down the precipice of the Acropolis, it has been suggested, may have arisen out of a misrepresentation of a primitive custom of casting an effigy of the vegetation spirit down a steep place. In a rite of Aglauros, later consecrated to Diomedes, a human victim was sacrificed at the altar by the *ephebi*. A legend at Haliartos of the type of the story of Jephthah's daughter (Jg 11^{34ff.}) speaks of water springing up wherever the blood of the victim dripped (CGS iii. 19, 21). The ceremonial of the Bouphonia suggests the substitution of an ox for a human victim at a 'firstfruits' ceremony.

Frazer (*GB*² ii. 222 ff.) suggests that, when the European customs are considered in the light of the practices followed by primitive races, we are justified in concluding that it was the practice at one time in Europe to offer a human sacrifice on the harvest field, the victim being identified with the corn-spirit. The penalty paid by the last reaper was death, as, he being nearest at the time the spirit was driven from the corn, it would be natural to conclude that it had entered into his body.

3. Communion, harvest supper, firstfruits, and the seasonal festival.—It remains to consider the question of the harvest supper and the offering of firstfruits, which are closely connected, although by no means identical. Attention has already been called to the custom that the 'harvest maiden,' in which a man or woman is sometimes wrapped, should be present at the dance or supper which usually follows the taking of the harvest.

In La Vendée, the 'Ceres,' before being torn to pieces and burnt, was the centre of the dance. In the North Riding of Yorkshire, the 'mell doll' was present at the mell supper. In Lewis, the farmers and reapers drink to 'the one that helped us with the harvest.' At Dantzic, the 'old man' was carried to the supper, and a portion of everything was given to him; but this was eaten by the woman who bound the sheaf, had it as her partner at the supper and dance, and was known by the same name for the remainder of the year.

The presence of the harvest figure at the supper, and the importance attached to it, suggest something more than a mere feast of rejoicing at the successful completion of the year's work. Instances have already been quoted of the killing of an animal, such as a cock, a pig, or a bull, on the harvest field as an embodiment of the corn-spirit. The bodies of these animals were sometimes given to the reaper who killed or caught them; sometimes, especially in the case of a larger animal, its flesh was eaten at the harvest supper, as in the case of the goat killed at Grenoble.

At Dijon, the ox killed on the harvest field was partly eaten at the supper, and partly pickled and kept until the spring. In Bavaria, the man who made the last stroke in threshing had to

carry the pig to a neighbouring barn where the threshing was still going on. He ran the risk of being beaten, but at the harvest supper he received a number of dumplings in the form of pigs.

From the numerous instances of eating the body of the slaughtered animal, bearing in mind their special relation to the harvest and the significance of other customs, it would not be unreasonable to conclude that the harvest supper is a survival of a form of solemn feast, of which the great festivals in Greece connected with the worship of Demeter and Kore, the Haloa (the threshing-floor festival), and the Eleusinia were probably a development. Hippolytus (*Philosoph.* v. 3) says that in the Mysteries the Epoptæ were shown the mystery of perfect revelation—a cut corn-stalk.

The animistic beliefs which give rise to the conception of a corn-spirit are evident when the corn of the last sheaf provides the material for a cake in human form to be distributed among the members of the household or the harvesters, or when, as among the Aztecs, a human victim was identified with the god. When, however, special ceremony attaches to the eating of the new corn, either in fact or in symbol, the ritual, in the course of development, tends rather to be concerned mainly with averting the danger of breaking the tabu involved in cutting or eating the corn for the first time, or in propitiating or offering thanks to the spirits which might affect the crops adversely (see art. FIRSTFRUITS).

The ritual and beliefs serve to bring out several points of interest in connexion with the harvest supper. (1) It is a survival or descendant of a solemn meal, (a) at which the spirit of the crops was present, or (b) for which the material representation of the corn-spirit furnished the food, or (c) with which human sacrifice was connected. (2) It is not merely a feast of rejoicing after the harvest, but it is either a necessary antecedent to the harvest, or, when it follows or accompanies the harvest, it must precede the general use of the crops for ordinary consumption. (3) By a logical extension of idea the sacramental feast grows into an offering of firstfruits to the powers that preside over the crops. (4) The solemn ritual of the harvest meal is frequently accompanied or followed by a period of licence, in which the ordinary rules of conduct and respect for superiors are disregarded, or in which an inferior may even take the place and usurp the authority of his superiors. On this point it may be recalled that these changes of personality and irregular conduct are frequently adopted for purposes of disguise, and that, even when such saturnalia are not the concomitants of ceremonies held at harvest time to drive away the spirits of the dead—as, for instance, is the case after the harvest among the Hos of Assam, and in the 'devil driving' of the Hindu Kush tribes, when the evil spirits are expelled from the granaries—the harvest is a critical period of the year when malign influences may be expected to be especially powerful.

The harvest supper observances as a whole, taken in conjunction with the beliefs which underlie other harvest customs, point to an origin in a belief that the crop is tabu, and that to cut it or eat it is a dangerous act, of which the risk can be averted only by the process—familiar in the practices of magic—of a solemn covenant based upon a communion in which that which is feared is brought into the closest relation with the one who is afraid. In this case, by eating the material manifestation of the dangerous element after special precautions, the primitive mind of the savage believes that he becomes one with it and immune from its influence.

LITERATURE.—J. G. Frazer, *GB*², London, 1900, esp. ii. 168 ff., also *GB*², pt. iii. (1911), 'The Dying God,' pp. 20-25, pt. iv. (1907), 'Adonis, Attis, Osiris,' p. 196 ff.; W. Mannhardt, *Ant*

Wald- und Feldkulte, Berlin, 1877, also *Baumkultus*, do. 1875, and *Mythol. Forschungen*, Strassburg, 1884; cf. also *Literature at the end of art. FIRSTFRUIT*.
E. N. FALLAIZE.

HASAN 'ABDĀL.—A village and ruins in the Attock District of the Panjāb; lat. 33° 48' N.; long. 72° 44' E.; forming part of the great city known to Greek and Roman authors as Taxila (Τάξιλα), a close transcription of the Pāli or Prakrit name *Takṣaṣilā*, Skr. *Takṣaṣilā*, 'hewn rock or stone' (McCrimble, *India as described by Ptolemy*, London, 1885, p. 118 ff.). It takes its present name from that of a Muhammadan saint, Bābā Ḥasan 'Abdāl, who lived under Mirzā Shāhrukh, son of Timūr (Elliot, *Hist. of India*, London, 1867-77, i. 239; *Āin-i-Akbarī*, tr. Blochmann and Jarrett, Calcutta, 1873-94, i. 515). The sanctity of the place—still a resort of considerable numbers of pilgrims—dates from early times. Hiuen Tsiang, the Buddhist pilgrim of the 7th cent. A.D., describes the tank of the Nāga Rājā, or snake-king, Elāpatra, to which, when the people wanted rain or fine weather, they used to go in company with some Buddhist ascetics (*samāna*), and, snapping their fingers, invoked the aid of the Nāga, and at once obtained their wishes (Beal, *Si-yu-ki*, London, 1906, i. 137). The place seems originally to have owed its sanctity to a holy spring which gushes into the fountain of the modern saint. Round this, as is common in India, a serpent-cult grew up, the Nāga, or dragon, being supposed in particular to have control of the weather (Crooke, *PR*², 1896, ii. 128 ff.). The Buddhist legend was succeeded by a Brāhmanical version; and that again by a Muhammadan story, of which the saint Bābāwālī is the hero; finally, the Sikhs connected the site with a miracle of their *guru*, Nānak, who, coming to the place fatigued and thirsty, invoked Bābāwālī for a cup of water. The saint, indignant at the presumption of an unbeliever, flung at him a stone several tons in weight, which the *guru* caught in the air, leaving the impression of his fingers on it, which are visible to this day. The whole series of legends is an interesting example of the manner in which a place, owing its sanctity to some natural feature, is adopted in turn by the followers of rival faiths. The importance of the place in Buddhist times is shown by a *stūpa* and the remains of a temple discovered by Cunningham.

LITERATURE.—A. Cunningham, *Archaeological Reports*, ii. [1871] 136 ff.; W. Moorcroft, *Travels*, London, 1841, ii. 319.
W. CROOKE.

HASAN AL-BASRI.—Ḥasan al-Basri (Abū Sa'īd) was born at Wādi 'l-Qurā near Medina in A.H. 21 (A.D. 641-642), two years before the end of Omar's khalifate, and died at Basra in the month of Rajab, A.H. 110 (October-November, A.D. 728). Ibn al-Athir says that his age was then eighty-seven, in which case the date of his birth would be A.H. 23. Both his parents were originally slaves. His father, Yasār, was a native of Maisān in the neighbourhood of Basra, was taken prisoner in A.H. 12, during the conquest of 'Irāq by Khālid ibn Walīd, and became a freedman of one of the inhabitants of Medina—of Zaid ibn Thābit, the Prophet's amanuensis, according to some authorities. Tabarī (i. 2029, 1) states that the name of Hasan's father was Ḥabīb, and that he was a Christian, while al-Sha'rānī (*Tabaqāt al-kubrā*, i. 51. 13) declares that he was of Nubian extraction. These statements are significant, in view of the great influence which Ḥasan and his pupils exerted on the early development of Muslim theology; and it may be recalled that the famous Egyptian mystic, Dhū 'l-Nūn, who died in A.H. 245 (A.D. 859-860), is said to have been the son of a Nubian slave. Hasan's high reputation for orthodoxy was possibly gained, as Dozy has suggested,

at the expense of his pupils, who gave currency to his speculations. At any rate, he was in touch with all the religious movements of the period, and must have taken a leading part in the theological controversies which were then agitating the Muhammadan world. We are expressly told that he disputed on the subject of free will (*qadar*), but afterwards returned to the more orthodox doctrine (Ibn Qutaiba, *Kitāb al-ma'ārif*, ed. Wüstenfeld, 1850, p. 225. 12). A commentary on the Qur'ān is ascribed to him (Brockelmann, *Gesch. der arab. Litteratur*, Leipzig, 1901, i. 67), and he is said to have explained the meaning of Apostolic Traditions, whereas the older generation were content with reciting them (*Qūt al-qulūb*, Cairo, A.H. 1310, i. 147, line 6 from foot).

Whatever may be thought of the well-known story which attributes the origin of the Mu'tazilite school to a difference of opinion between the master and one of his pupils—Wāsil ibn 'Aṭā or 'Amr ibn 'Ubaid—there can be little doubt that in Ḥasan's circle the dogmas of Islām were freely discussed and expounded; it was this freedom that caused his activity as a teacher to have such fruitful results. But if, in fostering the spirit of inquiry, he overstepped the limits of traditional authority, the sayings and anecdotes recorded by his biographers show that his religion was intensely real. His ordinary demeanour was that of a man under sentence of death, and he looked as though hell had been created for him alone. Like many of his fellow-Muslims, both men and women, he found in asceticism the only means of escape from the wrath to come. No man, in his opinion, deserved the name of theologian (*faqīh*) unless he had renounced the present world and fixed all his desires upon the future life. Muslim asceticism soon developed mystical tendencies, and Ḥasan seems to have gone some distance in this direction. It is asserted that he was the first pioneer of mystical science in Islām, and that he made it a subject of discussion, and explained its ideas in terms that were not used by any of his contemporaries (*Qūt al-qulūb*, i. 150. 2). He was the founder of the Basrite school of mystics, who maintained that the knowledge which, according to a maxim of the Prophet, it behoves every Muslim to seek consists in knowledge of the heart, and in a scrupulous examination of the thoughts that enter it, so as to discern whether they are spiritual or sensual, intuitive or intellectual (*ib.* i. 129. 16). Prayer-meetings (*majālis al-dhikr*) were held in his house at Basra (*ib.* i. 148. 18). Those who attended them were persons inclined to quietism, interested in communicating to one another their spiritual experiences, in studying the Qur'ān together, and in conversing about religious questions. While it is easy to believe that Ḥasan, as Qushairī and other Sūfi writers mention, attached more value to inward piety and humility than to outward acts of devotion, like fasting and prayer, there is no evidence that he was a Sūfi in the full sense of the word. He was driven to righteousness by the goad of fear, not drawn, as the true mystic always is, by a spontaneous and irresistible rapture of Divine love. His character appears in a legend told by 'Aṭṭār in the *Tadhkirat al-Auliya* (ed. Nicholson, 1905-07, i. 57. 17). 'Utba al-Ghulām, one of his disciples, had crossed a river on foot, while Ḥasan himself remained on dry land, amazed and powerless to follow. Ḥasan asked him how he was able to work such miracles. 'For thirty years,' 'Utba replied, 'thou hast done what God commands, but I have done what He desires.'

LITERATURE.—Besides the references mentioned in the article: Ibn Khallikān, tr. de Slane, Paris, 1843-71, i. 370; *Kashf al-Mahjūb*, tr. Nicholson, London, 1911, p. 86 f.; A. von Kremer, *Gesch. der herrschenden Ideen des Islams*, Leipzig, 1868, pp. 22 f., 56; R. P. A. Dozy, *Essai sur l'histoire de*

Islamisme, tr. V. Chauvin, Leyden, 1879, pp. 201-204, 319-320; R. A. Nicholson, *A Literary History of the Arabs*, London, 1907, pp. 225-227.

REYNOLD A. NICHOLSON.

HASIDÆANS, HASIDISM.—The Hasidæans (Χασιδαῖοι or Ἀσιδαῖοι, from Heb. חַסִּדִּים, *ḥasidim*, plur. of חַסִּד, *ḥasid*, 'pious') were the precursors of the Pharisees. The names of the two religious parties have practically the same meaning: *ḥasid* = 'pietist,' and 'Pharisee' (פְּרִישִׁי, *pārūsh*, 'separated') means 'separatist.' During the period of the Seleucidæ in Palestine the Hasidæans were the enemies of Hellenism, and opposed the introduction of Greek ideas and manners into Israel. As shown by the name they bear, they were an exclusively religious party; they were rigid zealots; they formed an association, a company of rigorists. In reality they were the descendants of Ezra and Nehemiah, who expelled the foreign wives; they continued the tradition of the Scribes.

As far as the meagre information we possess concerning them enables us to judge, the Hasidæans did not differ essentially from the Scribes. They were men completely devoted to the Law (πᾶς ὁ ἐκουσιαζόμενος τῷ νόμῳ), even so far as to take up arms in its defence when it was threatened by sinners and lawless men (1 Mac 2⁴²⁻⁴⁴); but, as soon as peace was restored, they threw aside their weapons, as their hands were better suited to handle the sacred scrolls than to fight with the sword.

According to 1 Mac., the Hasidæans played only a very minor part in the Maccabæan wars. The events which took place in Palestine at the beginning of the national revolt against the Seleucidæ show this very plainly. The high priest Menelaus, who had been put to death in 163 B.C. by command of Antiochus v. Eupator, was succeeded by Alcimus (Ἄλκιμος, Ἰάκειμος, Ἰάκιμος, אֲקִים, *Yāqīm*), who was of priestly stock, but did not belong to the ruling branch of the Onias family. Josephus (*Ant.* XX. x.) tells us that Antiochus Eupator nominated Alcimus chief priest in 162. According to 1 Mac., when Demetrius Soter dethroned Antiochus Eupator, Alcimus came to him offering his services against the patriotic Jews who were trying to shake off the Syrian yoke. The king, we are told, entrusted him, along with his general Bacchides, with the pacification of Judæa, and at the same time raised him to the high priesthood (1 Mac 7⁵⁻⁹). It is at the time of this mission that the part taken by the Hasidæans appears clearly. The comparative study of parallel fragments from the first and second Books of Maccabees sheds clear light on their attitude in the national revolt.

If we had only the account in 2 Mac., we should be left in no doubt that the Hasidæans took part in the national war, in spite of the obvious errors contained in the narrative. It is there stated that 'being called by Demetrius [Soter] into a meeting of his council and asked how the Jews stood affected and what they purposed, he [Alcimus] answered thereunto: "Those of the Jews that be called Hasidæans, whose leader is Judas Maccabæus, keep up war, and are seditious, not suffering the kingdom to find tranquillity"' (2 Mac 14^{5f}).

Thus, according to this account, the Hasidæans were under the command of Judas Maccabæus, and are represented as the promoters of the war.

In 1 Mac., on the other hand, the Hasidæans are the peace party; it was to obtain peace that they sought Bacchides and Alcimus, the deputies of King Demetrius. This is how the author describes that mission:

'And there were gathered together unto Alcimus and Bacchides a company of scribes to seek for justice (ἐκζητῆσαι δίκαια). And the Hasidæans were the first among the children of Israel that sought peace of them; for they said, "One that is a priest of the seed of Aaron is come with the forces, and he will do us no wrong"' (1 Mac 7¹²⁻¹⁴).

The Hasidæans, then, were not the instigators of the war. In reply to their request for peace, the

royal envoys, thinking they would make an example, had sixty of them put to death. Thus, according to 1 Mac., the Hasidæans, grouped round the Scribes (from whom the Pharisees also spring), form an independent party, acting in opposition to Judas Maccabæus and his followers, as they acknowledge Alcimus not only as high priest but as the lawful representative of Syrian authority.

From the seemingly contradictory texts which we have just quoted it is easy to understand the rôle of the Hasidæans. At the outset the Maccabæan war was essentially and exclusively religious: the Jews were fighting with the Syrians to defend the Law endangered by the persecutions of Antiochus IV. Epiphanes. Hence the participation of the Hasidæans, a very rigid and exclusively religious party, in the national revolt. The religious aim pursued by the patriots was attained on 25th Chislew 165, when Judas Maccabæus purified the temple defiled by Antiochus Epiphanes, and restored the Jewish religion. The treaty of Lysias (162), which ensured the religious liberty of the Jews, thus gave full satisfaction to the Hasidæans, who are not again mentioned among the belligerents. Henceforth the Maccabæans alone and their soldiers continued the struggle against the Syrians for the political liberty of the country. We hear nothing more of the Hasidæans, and we have every reason to believe that those forerunners of the Pharisees became blended with them.

In any case an incident which happened during the reign of John Hyrcanus I. (135-105 B.C.), and which exhibits Pharisaism and Sadduceism at that time fully developed and in direct opposition, proves that the Pharisees of that period, engrossed solely with religion and its immediate interests, were indeed the heirs of the Hasidæans. John Hyrcanus was entertaining the Pharisees at a feast, when one of the guests named Eleazar demanded that the royal high priest should lay down the priesthood and rest content with the civil and military power (*Jos. Ant.* XIII. x. 5). That is precisely the position which the Hasidæans took up at the beginning of the national revolt—the absolute separation of the religious from the political domain.

See also ASCETICISM (Jewish), vol. ii. p. 97 f.

LITERATURE.—J. Wellhausen, *Die Phariseer und die Sadducaer*, Greifswald, 1874; E. Montet, *Essai sur les origines des partis saducéen et pharisien et leur histoire jusqu'à la naissance de Jésus-Christ*, Paris, 1883, also 'Le premier Conflit entre Pharisiens et Saducéens d'après trois documents orientaux,' in *JA*, 1887; E. Schürer, *GJV*³, Leipzig, 1898-1901; J. Wellhausen, *Isr. und jud. Geschichte*⁶, Berlin, 1901.

E. MONTET.

HASTINĀPUR (Skr. *Hastināpura*, 'elephant city'; or, according to other authorities, named after a mythical Rājā Hastin).—An ancient city in the Meerut District of the United Provinces of India, situated on the Būrh Gangā, or 'old Ganges,' an old course of the river; lat. 29° 9' N.; long. 78° E. The legendary account of Hastin will be found in the *Viṣṇu Purāna* (tr. Wilson, London, 1864-77, iv. 139 f.), which states that the old city was washed away by the Ganges. This, the capital of the Kaurava tribe, figures largely in the epic of the *Mahābhārata*. The buildings, which were probably built of clay and wood, have now disappeared; and nothing remains to mark this famous site but some shapeless mounds.

LITERATURE.—A. Führer, *Monumental Antiquities and Inscriptions of the N.W. Provinces*, Allahabad, 1891, p. 10.

W. CROOKE.

HATRED.—I. Psychological analysis.—The term 'hatred' designates a mental state of revulsion from something that offends us—a dislike or feeling of ill-will, intensified by the desire to harm or injure or make a speedy end of the object hated. This applies in chief to hatred of persons by persons, at the root of which lies the desire to

destroy. 'Hates any man the thing he would not kill?' asks Shylock (*Merch. of Ven.* IV. i. 67); 'whosoever hateth his brother,' says St. John (1 Jn 3¹⁵), 'is a murderer.' But it applies also to hatred of things (including in that term not only inanimate objects, but opinions, beliefs, and the like). Even when a schoolboy says that he 'hates lessons,' he means to express, not merely his feeling of aversion to them, but also his wish to make a summary end of lessons, if only he could; and, likely enough, he gives embodiment to his wish by tossing his books to the other end of the room.

The intensity and duration of hatred in general bear no definite or fixed proportion to the amount of injury received. Much depends upon the nature and temperament of the individual hating; and, especially, upon his private estimate of himself, and his sensitiveness to any affront to his dignity.

The outward corporeal expressions of hatred are clearly marked and well known: biologist, psychologist, and poet alike have duly recognized them; and how they show themselves in the lower animals, as well as in man, has been strikingly brought out by Darwin in his book on *The Expression of the Emotions in Man and Animals*. The menacing attitude of the body, the lowering countenance, the suspicious and unsympathetic look, the leer, and the coldness of behaviour are some of the modes of its objective embodiment; and these objective signs (it is important to observe) have much psychological significance, inasmuch as they react on the emotion proper, intensify it, and tend to keep it alive.

Hatred is not designative of a mere passing mood (like some forms of anger), but of a settled attitude or disposition, which cherishes ill-will and can bide its time and plan means for the injury or discomfiture of its object. It must be distinguished from *antipathy*, which is a merely sentimental or constitutional dislike (for the most part irrational) of an object, leading to shrinking from or avoidance of the object but not to its destruction—as we see, for example, in the antipathy to inoffensive crawling creatures which affects many people.

Hatred attaches itself to the malevolent side of human nature, and is to be classed along with such reprehensible emotions and settled dispositions as envy (*q.v.*), jealousy, revenge. It is essentially anti-social and self-centred.

The great antithetic emotion is love (*q.v.*), and the characteristics of the one are best seen in contrast with those of the other. If, then, (1) we view the two *in themselves*, we find that love is a conserving and attractive force, while hatred is destructive and repellent. Again, (2) regarded *from the side of the subject*, love is a feeling of pleasure or satisfaction with the person loved, together with the desire to do him good or to promote his welfare; hatred is a feeling of dissatisfaction with the object of it, mixed with pain but frequently intensely pleasurable, together with the desire to harm or to secure his ill-fare. Hence, love clothes its object with all amiable qualities and is apt to be blind to faults and defects; hatred clothes its object with all detestable qualities, and refuses to see any good in it. Further, love to a person is prone to make him who entertains it well disposed towards all with whom (or with which) that person associates—even towards his status in society, or the nationality to which he belongs; while hatred produces the exactly opposite effect. Next, (3) *taken in connexion with the object*, love is one great means of turning an enemy into a friend (hence the supreme wisdom of the injunction, 'Love your enemies, bless them that curse you, do good to them that hate you' [Mt 5⁴⁴]);

hatred is prone to turn a friend into an enemy. Love begets love, but hatred breeds hate. Once more, (4) *viewed as successive states*, the two show psychological peculiarities of a very interesting kind. (a) If, from whatever cause, we come to hate a person whom we have greatly loved, our hatred will be intensified by the fact of our previous love, and greater than it would have been if we had not loved before. This, no doubt, arises in part from the fact that we have lost a source of pleasure and are pained; but it involves also the fact that we feel ourselves injured by unrequited affection, and the further fact that we are chagrined at having expended our affection on an unworthy object. On the other hand, when we come to love a person whom we previously hated, our love will be proportionate to our previous hate, and all the greater that hatred has preceded it. One reason for this is that, in the circumstances supposed, we are conscious of having got rid of a source of pain; but two other things have to be taken into account, viz. the newly-aroused feeling that by formerly hating the person we have done him an injury or an injustice, and the consequent desire to make amends for this injustice. Again, (b) our love for a person is apt to be diminished, and even, perhaps, turned to dislike of him, if he does not love, much more if he actually hates, the things and persons that delight us; while community of likings or of interests goes some way towards making us well disposed towards one whom we hate.

All these are psychological facts, revealed in our actual experience of life, which must be taken into account by the ethicist in determining the value of hatred, and by the legislator, who cannot with impunity ignore the working of any human emotion as it shows itself either in the individual or in the community.

2. *Ethical and religious aspects.*—As a source of pleasure, hatred has undoubted potency. But this does not necessarily mean that it is to be ethically commended and the development and growth of it encouraged. On the contrary, character is one thing, pleasure is another; and it is the function both of ethics and of religion to emphasize the fact that 'the life is more than meat,' and that the higher aspirations of man and his spiritual ideals count for most. Hence, the psychological fact that the intensity of love may be increased by the circumstance that we have been previously hating does not justify the conclusion that *therefore* we ought to hate. For, if hatred is in itself deleterious to character, it must both restrict the power of loving and lower the kind of love. The increase of love that is dependent on hate is an increase on the level of a being to whom hate seems in itself desirable; but, if perfect love ruled as between man and man, such a conception would be impossible. Love would then be greatest of all, because it implied the abolition of hate and, therefore, substituted the higher pleasure for the lower, or the highest pleasure of all, from which the lower, having degradation in it, is excluded. It is a matter of quality, then, not of quantity or degree. Psychological experience is not an infallible guide to ethical and religious estimate.

(1) From the ethical standpoint, it is easy to see why hatred, in so far as it is expended by persons on persons (or even on the lower animals) is condemned. Its pleasure may be intense, but it is too dearly bought. The consequences it entails are far-reaching and disastrous. It lets loose many of the most malignant of the human passions, such as retaliation and revenge—hence, we apply to hatred such epithets as 'cruel,' 'deadly,' 'fierce,' 'vindictive'; it aims at injuring or even destroying the object hated; and it cramps and distorts the

nature of the person harbouring it, blunting his sympathy and perverting his judgment. Above all, it is the mark of deep-seated alienation of one man from another, ignoring the fact of the universal brotherhood of mankind, and transgressing the fundamental law of love, or mutual affection and mutual helpfulness, on which the existence of society depends. As its object is destruction, it repels instead of binding together, it dissolves instead of cementing.

That there is such a thing in man as a natural and legitimate resentment of injury received, ethics fully allows; and this, when rationalized, becomes the powerful thing we know as 'moral indignation'—which is the spontaneous protest of the conscience against wrong inflicted. But it demands more than a conscientious protest: it requires hatred—hatred, however, not of one man by another, but of everything that would interfere with the proper and higher development of a man's nature or of human nature in general; hatred, therefore, of vice or wickedness or wrong. But even then, while it enjoins hatred of vice, it will not allow hatred of the man who practises vice: it is the transgression, not the transgressor, that is to be abhorred. Hence the condemnation by ethics of misanthropy. 'Hatred of mankind' is selfish and abnormal, and destructive of the very idea of 'mankind,' which presupposes *society* and, therefore, unity among the members; otherwise, it would be meaningless. In like manner, ethics condemns war, taken in itself: war is man's hatred of man, with the lust of blood. Carried out to its full extent, it would become a state of universal hostility, which would speedily mean the extinction of the race. Once more, vindictive punishment is condemned by ethics because it is founded on hate, and is meant only to gratify the malignant nature of him who inflicts it. Men—private individuals or legislators—who punish because they hate stand self-condemned.

(2) All this, which is enforced by ethics, is accentuated and strengthened by religion; for, to the ethical reprobation of vice as destructive of the higher moral qualities in man, and the insistence on our loving the evil-doer while condemning his deeds, religion adds the ennobling and vivifying conception of man—of *every* man—as made in the image of God, and thereby sets him forth as an object of reverence, not of hatred, even in his degradation. Thus viewed, he is to be loved for the *possibilities* that are in him, and encouraged to have his potentialities actualized. This at once raises the notion of personality to a higher level than ethics attains. The idea of the individual as a spiritual being, akin to the Divine, invests him with a greater dignity and worth than that of the individual simply regarded as a moral person. And, while the religious consideration thus raises the estimate of the value of the individual, it also intensifies the hatred of everything that would lower the estimate; and so it goes beyond the mere ethical concept of 'vice' or 'evil' as the thing to be hated, and substitutes for it that of 'sin' or 'guilt,' thus bringing out man's essential relationship to God as the supreme fact. In this way the consequences of transgression are presented on their most serious and impressive side. Evil-doing is to be hated, strenuously opposed, and, if possible, exterminated, because it blurs the Divine image in man, and because it severs man from God, the rational creature from his Creator, the son from his heavenly Father. The full meaning of this is to be seen only in the light of the work and death of Christ—which is at once the revelation of the Father's love and the manifestation of the 'exceeding sinfulness of sin.' This is the Scripture view of hatred; and it goes even farther, and clinches

the injunction about brotherly love by excluding the hater from communion with the Divine altogether; for, 'If a man say, I love God, and hateth his brother, he is a liar: for he that loveth not his brother whom he hath seen, cannot love God whom he hath not seen' (1 Jn 4²⁰).

3. *Diverse views.*—On all sides, then—psychological, ethical, and religious—hatred of persons is seen to be irrational. But there are somewhat different views among philosophers as to whether it should be recognized to any extent and, if so, how far. Some have refused to give it any legitimate foothold at all. Spinoza, for instance, roundly declares: 'Hatred can never be good' (*Ethica*, iv. 45); and he goes farther and maintains that 'everything which we desire because we are affected by hatred is base and unjust in the State.' This is how it appears in the light of pure reason. Others, like Butler, have allowed sudden and instinctive resentment of an injury to be natural and, therefore, not reprehensible, but have refused to accord the same privilege to deliberate or calculated resentment. In this Butler is followed by the Scottish School of philosophy generally. Others, again, have maintained that what we find in actual fact to be a source of pleasure to men must be taken account of and allowed its place in estimating human happiness, according to the utilitarian standard. Bentham led the way here. While condemning vindictive punishment, on the principle that the pain outweighs the pleasure, and urging that the legislator should not punish from revenge (on the same principle), he yet urged the necessity of allowing something, in the apportioning of punishment to a criminal, to the personal pleasure or gratification that such punishment gives to the individual injured. This is vindictive satisfaction, or the pleasure of vengeance, of which he says:

'This pleasure is a gain: it recalls the riddle of Samson; it is the sweet which comes out of the strong; it is the honey gathered from the carcase of the lion. Produced without expense, net result of an operation necessary on other accounts, it is an enjoyment to be cultivated as well as any other; for the pleasure of vengeance, considered abstractedly, is, like every other pleasure, only good in itself. It is innocent so long as it is confined within the limits of the laws; it becomes criminal at the moment it breaks them' (*Principle of Penal Law*, pt. i. ch. xvi.).

In like manner, A. Bain strongly maintained the existence of malevolent affections as native to human nature, and the need of reckoning with them in ethics. His doctrine was best brought out in his famous controversy with F. H. Bradley in *Mind* (reproduced in his *Dissertations on Leading Philosophical Topics*)—a sufficient account of which has already been given in art. ANGER. In that article also will be seen the bearings of evolution on malevolence.

There is still a position to be noted, midway between the extremes. As its representative may be taken Thomas Brown.

'We are formed to be malevolent in certain circumstances,' he says (*Philosophy of the Human Mind*, Lect. ix.), 'as in other circumstances we are formed to be benevolent; but we are not formed to have equal enjoyment in both. . . . The moral affections which lead to the infliction of evil are occasionally as necessary as the benevolent affections. If vice exist, it must be loathed by us, or we may learn to imitate it. If an individual has injured another individual, there must be indignation to feel the wrong which has been done, and a zeal to avenge it. The malevolent affections, then, are evidently a part of virtue as long as vice exists; but they are necessary only for the occasional purposes of nature, not for her general and permanent interest in our welfare. . . . We are made capable of a malevolence that may be said to be virtuous when it operates for the terror of injustice, that otherwise would walk, not in darkness, through the world, but in open light, perpetrating its iniquities without shame or remorse, and perpetrating them with impunity. But, that even this virtuous malevolence may not outlast the necessity for it, it is made painful for us to be malevolent even in this best sense.'

What must determine as between these different views are clearly (1) consideration of what actually

obtains in our experience of human nature; (2) how this stands related to the ideal, which must test its value; and (3) determination of consequences, based on the fact of the solidarity of mankind.

LITERATURE.—All the books specified under 'Literature' in the art. ANGER. In addition: Descartes, *The Passions of the Soul* (tr. E. S. Haldane and G. R. T. Ross, vol. i. pt. 2, Cambridge, 1911); Spinoza, *Ethica*, esp. pt. iii., which is really a striking treatise on the Emotions (tr. W. H. White and A. H. Stirling, 3rd ed., London, 1899); Jeremy Bentham, *Works*, ed. J. Bowring, Edinburgh, 1859, i. 83, 382, and x. 69; James McCosh, *Psychology: the Motive Powers, Emotions, Conscience, Will*, London, 1867; James Martineau, *Types of Ethical Theory*, Oxford, 1885, ii. 160, etc.; Th. Ribot, *The Psychology of the Emotions*, London, 1897, p. 268, etc.; William L. Davidson, *Christian Ethics*, London and Edinburgh, 1907, pp. 53, 79-85; W. McDougall, *Introd. to Social Psychology*, London, 1908, p. 164.

WILLIAM L. DAVIDSON.

HAWAII.—The Hawaiian group of islands lies in the Pacific Ocean between lat. 18° 54' and 22° 15' N., and long. 154° 50' and 160° 30' W., and is of purely volcanic origin. On the Island of Hawaii the twin volcanoes Mauna Loa and Kilauea are in constant activity, while the extinct crater of Haleakala, on the Island of Maui, is one of the largest in the world. The natives are of pure Polynesian type, and constitute the extreme north-western outpost of this family, the Islands having been colonized in three great migrations from the Samoan group. The language has undergone little change, a native of Hawaii being able to converse with a Tahitian, New Zealander, or Samoan with little difficulty.

On this, A. H. Keane writes as follows (*Man, Past and Present*, Cambridge, 1899, p. 563 f.; cf. also Waltz-Gerland, *Anthropol. der Naturvölker*, v. 202 ff.): 'Migrating at an unknown date eastwards from Malaysia (for further details, see art. ETHNOLOGY, vol. v. p. 531), the Indonesians appear to have first formed permanent settlements in Samoa, and more particularly in the island of Savaii, originally Savaiki, which name, under divers forms and still more diverse meanings, accompanied all their subsequent migrations over the Pacific waters. Thus we have, in Tahiti, *Havaii*, the "universe," and the old capital of Raiatea; in Rarotonga, *Avaiiki*, "the land under the wind"; in New Zealand, *Hawaiki*, "the land whence came the Maori"; in the Marquesas, *Hawaiki*, "the lower regions of the dead," as in *to fenua Havaiiki*, "return to the land of thy forefathers," the words with which the victims in human sacrifices were speeded to the other world; lastly, in *Hawaii*, the name of the chief island of the Sandwich group.'

In conformity with this, the native belief obtains that the soul of a Hawaiian leaves the Island of Kauai from the promontory looking towards Samoa, and in Samoa a similar story turns the soul towards New Zealand. In Hawaii, oral tradition itself clearly gives the details of the first landing of the Samoans on the shores of Kauai; and, while no accurate dates can possibly be given, this migration is supposed to have taken place as early as the 2nd cent. A.D. A Samoan chieftain, having been defeated in battle, refused to submit to his victorious rival, and, embarking his followers in his remaining war-canoes, set his matting sails for the unknown ocean. The Polynesian knowledge of astronomy is remarkable, and it enabled them to steer a straight course; but it has been surmised that a chain of islands existed which have since been submerged by volcanic disturbances, and that the fugitives were thus able to obtain fresh water and supplies; otherwise, the journey seems well-nigh a miracle.

The Hawaiians counted time by the generations of their principal chieftains, beginning with Wakea, who was the semi-mythical progenitor of all the royal families (cf., further, CALENDAR [Polynesian]). Events were counted thus: 'So it was in the time of . . . ' giving the name of the *alii nui*, or high chief. The length of a generation was roughly approximated at thirty years. Fifteen generations from Wakea is the time of Naua-ulu, and fifteen generations more brings the chief Maweke (A.D. 1030).

The native Hawaiian is tall, well formed, very

strong, and possessed of great endurance. He is an expert cliff-climber, swimmer, and sailor. His national sports are sledging and surf-riding, while the dance is considered the necessary accomplishment of both sexes. In colour he is a dark reddish-brown. The nose is clear-cut and wide of nostril, the lips large, but well chiselled, the hair straight, abundant, and black, and there is a marked tendency toward brachycephaly. Tatuings was general, and survives at present in ring-marks on the finger. All inheritance came through the female line, ancestry being traced through the mother only.

In the families of very high chiefs (*alii nui*), the practice of incestuous marriage was common, and was regarded as sacred, the offspring of brother and sister being treated with more than royal honours. The sun was never allowed to shine upon them; and, if the shadow of a low-born vassal fell across their threshold, the offence was punishable by death. The tabu stick—a staff surmounted by a ball wrapped in white tapa cloth—was placed by the hut, and warned the passer-by that the ground was the possession of kings or priests, and must not be profaned upon pain of death. The tabu was strictly enforced by the chiefs, and is one of the most widely-known institutions of the Islands. The royal colour was yellow; the next in rank was red. The king's badge of office was a feather cloak, made from yellow feathers found under the wings of the *oo*, and woven with infinite skill and care into a web of coco-nut fibre. The *lei*, or wreath, was also of the precious yellow feathers. The red feathers of the *iwili* made wreaths and decorations for the nobility of the second order, though kings by no means disdained them. A few scarlet feather helmets are still preserved, which have almost the shape of the Greek helmet, but are larger and without the nose-guard. The *kahili*, or royal staff, was of wood, or wood and bone, topped by a tuft of bright-coloured feathers. It was carried as a standard, or like the mace of European royalty. At a royal funeral, the *kahili* bearers never left the corpse until it was finally given in charge of the friend designated to give the final rites and concealment.

The greatest importance was attached to aristocratic birth, Kauai, the island where the first migration landed, claiming the greatest purity of blood. Upon coming of age, the children of a chief, boys and girls alike, were required to appear before the elders assembled in solemn conclave, there to recite their genealogy and the deeds of their ancestors. In this oral fashion, the history of each great family and the history of the race were preserved with surprising accuracy and wealth of detail. The neophyte's recitation often took two whole days to repeat; and, if he failed to be letter-perfect, he was remanded, to appear the following year before the historians to the tribe. Such a disgrace seldom occurred, for the child began his lesson in earliest infancy, and pride of race induced ardent study. At the close of the ceremony a feast was held; and the youth, now supposed to have reached maturity, received gifts, was permitted to enter the councils of the elders and to give advice, and was released from many of the irksome services devolving upon children. At this time the novice selected his own *hamakua*, or household god, or was permitted to wear sacred relics.

The natives were never cannibals, as has been erroneously believed. Tradition tells of the coming of a tribe of exiles, probably negritos, in war-canoes, who took possession of a promontory in Ohau; when the inhabitants discovered their custom of eating human flesh, they fell upon the little colony and exterminated it.

There being no metals in the Islands, wood was

used for weapons—clubs, spears, shields, etc.—and for such simple implements as were used in cultivating the 'taro' (a lily root), their chief food staple.

Tradition tells of the wrecking of a junk upon one of the Islands, probably in the 16th cent., and the rescue of a man and woman, evidently Japanese. The one possession the captain saved from the ship was a sword, which won him great renown in the metalless land. The mere touching of the blade was supposed to ensure victory, and the sword became the hereditary treasure of the tribe into which the castaway was adopted. It was traceable in legend for several generations, when it disappeared, having been buried with the chief who possessed it at the time.

When, upon Captain Cook's first voyage, the natives learned the possibilities and powers of metal, it became the one object of desire; and it was owing to the theft of nails from the long-boat, upon Cook's return journey, that a sailor killed a native, bringing about the fight in which the explorer lost his life.

The moral code of the community was remarkable, owing to the importance of the woman. Marriage was dissolvable by mutual consent. In the families of chiefs, if the wife insisted upon a separation, the husband was bound to return her in all honour to her nearest of kin, together with the marriage portion she had brought, or its equivalent. Except for its aristocratic value, marriage apparently had no sacred aspect; but a wedding was, of course, an excuse for prolonged revels. The *kava*, the only fermented drink of the primitive people, was but slightly intoxicating; but of this they drank large quantities, further excitement being supplied by *hulas* and the music of wooden drums and gourd rattles. Funerals were always attended by feasts and prolonged ceremonies. The natives differ as to the promiscuity attending these feasts—some admitting that the utmost licence formerly existed, others denying the tradition. It is, therefore, probable that the customs varied in the different tribes. The body of a chief must on no account fall into the hands of his enemies, the possession even of a bone or a lock of hair ensuring power over the soul; hence extraordinary precautions were taken. The flesh was cut from the skeleton and destroyed. The remains were then wrapped in matting, a few of the choicest treasures of the deceased were added, and the whole, packed in a wooden calabash, or hidden in a canoe bow, was carefully concealed by the closest surviving friend. Tradition tells of one devoted follower entrusted with his chief's body, who ground the bones to powder, which he mixed with the *poi* served at the funeral feast to the assembled warriors, thus ensuring his master's future safety. To make fish-hooks of the bones of a rival chieftain was the greatest insult one tribe could offer another; hence, between enemies every effort was made to learn the whereabouts of a grave, and put its contents to base use. Among the people it was, and still is, the custom to place the dead man, wrapped in tapa and matting, in the bow of his canoe, which is cut in half, and carried to one of the numerous cliff-caves. At present the custom is falling into disuse, owing to the desecration of graves by foreigners, who seem unable to feel respect for the dead, unless they are interred after their own fashion.

With the exception of the *heiau*, lava-built temples, the Hawaiians erected no permanent structures. Their houses were of palm or grass bound to poles, with finely woven matting for floors and curtains, the Island of Niihau being famous for its weavers. The door must face no other opening, the belief being that, if such be the case, 'what goes in must immediately depart,' meaning that no rest or permanent residence is possible in a dwelling thus constructed. A raised platform, covered by a mat, served as the bed.

Very little privacy was maintained. The house was preferably built over or near a beneficent *hamakua*, or household divinity, which might be personified by a stone, a tree, a bush, or any natural object. Any one might thus be under the protection of a spirit. Chiefs owned their own *hamakua*, sometimes curiously painted logs, in which some resemblance to an animal or man could be traced; though sometimes these *hamakua* were bits of stone or wooden tokens. These the chief took with him always, and they were part of his family insignia.

The favour of the sea being most necessary to the community, it was invoked through Ukupanipo, the shark-god, who, with his followers, could drive the fish to or from the shores, giving or withholding the daily food of the native. The red fish were the perquisite of royalty; but, if they ran within the reefs in great numbers, it was considered an omen of death in the family of the chief. The last recorded run preceded the death of Kalakaua, which occurred in San Francisco, 20th Jan. 1891, and which had been predicted by the natives upon the appearance of the fish several weeks before the event. Ukupanipo is credited with occasionally adopting a human child, to whom he gives the favour of the sea, and who has the ability to change into a shark at will. These sea-children possess the ravenous mien and dangerous temper of the god. The mark which Ukupanipo places upon them is a mouth-like orifice below the shoulder-blades, garnished with teeth. The phenomenon is said to have appeared recently. Algaloa, the sky-god, received little attention except among the cloud-diviners.

In ancient times the sick and aged were made away with. This fact has often been denied; but statements continually occurring in the native folk-lore make it more than probable, though the Hawaiian is kindly, gentle, hospitable, and given to generosity and self-sacrifice. Great importance is attached to friendship. A chief gave his closest friend the privilege of wearing his *malo*, or matting loin-cloth, woven as beautifully as linen. Gifts of hair were highly considered, and were plaited fine and worn with the whale-tooth charm, shaped like an inverted question-mark, called *puloa*. There is implicit belief that articles closely associated with a person retain something of the spirit of their owner.

The soul after death was supposed to journey to Kauai, and to leap from a cliff into the sea, descending until it fell into the under world, whose sky is the bottom of the ocean, there to lead an aimless and shadowy existence under the supervision of Milu—god of the under world. But spirits, particularly those of chiefs and *kahunas*, or witch doctors, continued to haunt the earth, and the Hawaiians lived in terror of these visitations. Victims slain in human sacrifice reappeared and haunted the site of any temple fallen into ruins. These apparitions were always heralded by the rolling of *pahus*, or temple drums. The ghosts set upon and immolated any man who chanced to cross their path. Evil spirits play a far greater part in the religion of the people than beneficent influences, good fortune and happiness being the direct gift of some particular local or household deity. The chief gods (*akua*) actually take a secondary rank to the *hamakua*, or household gods, with the exception of *Pélé*, the goddess of volcanoes, who completely overmasters all others with her fiery presence.

The legends concerning her are very numerous. She shows herself now as a girl, beautiful and young, who, suddenly appearing at a feast, dances so divinely that her identity is guessed; now as a hag, demanding impossible services of the wayfarer. The most famous story is of her defeat in sledging, when, furious at being beaten in her favourite sport, she turned

Puaanui, the literally pig-headed demi-god with whom she was contending, into a lava pillar, together with all the onlookers. Strangely shaped lava-heaps in the district of Puna are pointed out by the natives as the ill-fated members of that coasting party. The sport resembles *skiing*, the skate boards being long, narrow, up-turned, and highly polished; the smooth incline of a steep hill is all the surface required.

Pélé always resented the penetration of any of her numerous disguises, and dealt out volcanic vengeance with savage impartiality. Fine spun lava, shredded from the molten throat of Kilauea, is known as Pélé's hair, and three small, extinct craters, leading from the ocean to the lake of fire, are known as Pélé's footsteps. When she rose, like Aphrodite, from the sea, she sought a permanent resting-place, but her first three steps sank deep into the earth, and the sea entered, forming a pool. At last, when the fourth foot-step formed Kilauea, fire sprang about her feet, and the goddess had found her home.

Pélé was supposed to be partial to the house of Kamehameha I. (born A.D. 1736), the first chieftain to bring all the Islands under one rule. When, in 1881, the town of Hilo was threatened by a vast lava-flow from Mauna Loa, the Princess Ruth, great-granddaughter of Kamehameha the Great, made a pilgrimage to the devastated district, cast gifts into the fiery river, and implored Pélé, in the name of the ancient friendship of her race, to withhold her vengeance; within an hour the lava ceased to flow, the city was saved, and multitudes of natives who had embraced Christianity returned to the ancient beliefs.

The temples, or *heiaus*, were seldom dedicated to any one particular deity (they were temples where any one of the gods might publicly be invoked), two groves, sacred to the Poison-goddess, and a *heiau* to Ukupanipo, being the exceptions. The *heiau* was an enclosure, usually oblong, formed by walls of lava rock. At the side, facing the entrance, was the altar. The house of the priests occupied one corner. Between the two, but situated in the centre of the square, was the *anu*, or place of oracles, from which the prophecies were issued. Only the *alii*, or high-born, might converse thus directly with the gods after suitable gifts had been made to the temple. The people had to fall back upon the intermediation of the *kahuna*, who exercised a power only second to the chief. They claimed the power, known as *anana*, of praying to death any one who offended them. They could blight crops, cause storms, bring down pestilence, and interpret the will of the gods. They could cure all forms of sickness, hold communication with the dead, invoke the favour of the sea, and interpret the omens. The earliest traditions show that these omens were taken chiefly from the clouds, the flight of birds, and the actions of fish. In later times, after the introduction of foreign animals, a black pig became indispensable to the diviner, both the condition of the vital organs when killed and his instinctive selection of some symbolic food being indications from which the future was predicted. Much also was to be learned of impending events by dissecting a fowl.

Bits of coloured cloth, or *tapa*, were supposed to concentrate influences. A *kahuna* employed to torment an enemy first sought to gain entrance to his hut, and there to hide some malefic charm. The next move was to obtain some portion of the victim—a nail-paring, a lock of hair, spittle, or anything intimately connected with his physical being. In praying to death, the *kahuna* retired to some isolated place, and there remained in continuous prayer and incantation, until the victim languished and died. In this case the doomed person suffered no pain. If it was desired to inflict agony, a piece of cloth, containing earth from the doorstep and various charms, was beaten, stabbed, burned, etc. *Kahunas* effected their cures by reversing the method, though occasionally they administered some nostrums. Their influence continues to be strong among the natives,

though every effort has been made to stamp out the *kahuna* and his practices.

The Poison-goddess inhabited the two groves set aside for her; and her images, carved from the sacred trees, are supposed to have cost the life of their sculptors. Naturally all sacred groves and temples were protected by tabu.

The first attempt to collect and translate the more popular legends was made by King Kalakaua himself (*Legends and Myths of Hawaii*, New York, 1888), with the aid of one of the American missionaries. It has been claimed that in order to poetize the stories, he departed from the traditional texts; but they are sufficiently close to the originals, in spite of their strange resemblance to the Greek hero-stories, to be seriously considered. The epic of the Hawaiian Helen is undoubtedly authentic, notwithstanding its analogy to the Trojan myth, carried out even to the taking of the city on the cliff, by the rescuing party, according to the oracle that told them to besiege with moving walls. This was accomplished by the advance of the besiegers bearing wooden shields that touched each other, enabling them to approach under protection, and cleated within to enable their bearers to scale the ramparts by their aid.

The first Europeans to visit the Islands were shipwrecked Spaniards in 1527. In 1555 the group was officially discovered by Juan de Gaytan, on a voyage from the Moluccas to New Spain, and received the name of Los Majos. In 1736, Kamehameha the Great was born on the Island of Hawaii. During this period continual intestinal wars distressed the people of the various Islands, until Kamehameha brought them under one government.

In 1778, Captain James Cook, commander of H.B.M. ships *Resolution* and *Discovery*, landed at Waimea, Kauai, whence he proceeded to Niihau, departing thence for the north. Upon his return in November, Cook sighted Maui, and, off Kona, entertained the chief on board the *Discovery*. On 11th Feb. 1779, Captain Cook was killed by the natives, in reprisal, the Hawaiian tradition tells, for an attempt to take an idol from a neighbouring *heiau*. On 26th May 1786 the English ships *King George* and *Queen Charlotte* touched Kona, and, in May of the same year, a French exploring expedition, under La Perouse, reached Maui. In 1787, Kaiana-a-Ahunla accompanied an English captain on the ship *Nootka* to China. The relations with foreigners remained friendly until the wilful massacre of the natives at Olowalu, Maui, by the American, Captain Metcalf, of the *Eleanore*, resulted in a reprisal by the chieftain, Kamuiamoku, in the capture of the tender of the *Eleanore* and the killing of all the crew, except an Englishman, Isaac Davis, and John Young, boatswain of the *Eleanore*. Davis became councillor, and received great consideration. In 1791, Kamehameha was proclaimed king of all the Islands. In 1792, Captain Vancouver, with the *Discovery* and the *Chatham*, cast anchor at Kealakekua Bay, on his way north. On his return he presented the first live stock ever landed in Hawaii. He was well received by the natives upon his third visit in 1794; but in Jan. 1795, Captain Brown, of the *Jackal*, and Captain Gardner, of the *Prince Leboo*, with some of their men, were killed in Honolulu harbour.

Several revolts against the power of Kamehameha were suppressed. In 1815 the Russians arrived, entrenching themselves in the forts at Haualei and Waimea, and in 1816 they erected a stronghold at Honolulu. The *Rurick*, commanded by Captain Kotzebue, the first battleship to enter that harbour, brought reinforcements to them

there. In the same year the national flag, designed by an Englishman, was adopted. In May 1819, Kamehameha I. died and was succeeded by his son Kamehameha II., who broke away from traditions, and, in Oct. of that year, openly proclaimed the abolition of the tabu. This departure, angering many of the lesser chiefs, resulted in a revolt, which, though at first successful, was suppressed by Liholiho. Several chieftains having received baptism, a reaction set in against the old religion, and, in 1820, a general destruction of idols and temples took place at the instigation of the American missionaries, who arrived on the brig *Shaddens*, in company with four Hawaiians, who had been sent to Cornwall Institute—Honolulu, Hopu, Kanui, and George Hume, son of the Kauaiian chieftain.

Though the Hawaiians are now avowedly Christianized, the old beliefs persist. It is difficult, however, to obtain access to any of the secret ceremonies, though traces of the *kahuna* are to be found in every walk of life. Their gods they take lightly, but the priests are a serious matter. Evil ghosts take the place of devils, and are under the control of the witch-doctor, who may direct their destructive influence upon whom he will. Health, happiness, and even life itself can be given or taken at the will of the *kahuna*.

LITERATURE.—Many of the older explorers and missionaries in Polynesia refer to Hawaii, notably J. Cook, *Voyages*, London, 1773-84, and W. Ellis, *Polynesian Researches*, do. 1853; the most important of this material is collected in T. Waitz and G. Gerland, *Anthropol. der Naturvölker*, Leipzig, 1860-77, v., vi. See, further, J. J. Jarves, *Hist. of the Hawaiian Islands*, London, 1843; S. S. Hill, *Travels in the Sandwich and Society Islands*, do. 1856; J. Remy, *Ka Moolelo Hawaii: Histoire de l'archipel hawaïien*, Paris, 1862 (text and tr. of a native history); M. A. Donne, *Sandwich Islands and People*, London, 1870; A. Fornander, *Account of the Polynesian Race, and the ancient Hist. of the Hawaiian People*, do. 1877-85; A. Bastian, *Zur Kenntniss Hawaiis*, Berlin, 1883; R. Anrep-Elmpt, *Die Sandwich-Inseln, oder das Inselreich von Hawaii*, Leipzig, 1885; A. Marcuse, *Die hawaiischen Inseln*, Berlin, 1894; T. Achelis, *Über Mythol. und Cultus von Hawaii*, Brunswick, 1895; S. Culin, 'Hawaiian Games,' in *Amer. Anthropol.*, new ser. i. (1899) 201-247; J. Rae, 'Laieikawai: a Legend of the Hawaiian Islands,' in *JAFI* xiii. (1900) 241-260; E. Tregear, 'The "Creation Song" of Hawaii,' in *Journal of the Polynesian Soc.* ix. (1902) 38-46; A. Krämer, *Hawaii, Ostmikronesien, und Samoa*, Stuttgart, 1906; D. Logan, *Hist. of the Hawaiian Islands, their Resources and People*, Chicago, 1907; T. G. Thrum, *Hawaiian Folk Tales*, do. 1907; H. H. Gowen, *Hawaiian Idylls of Love and Death*, New York, 1908; N. B. Emerson, *Unwritten Lit. of Hawaii; the Sacred Songs of the Hula* (*Bull.* 38 BE), Washington, 1909; and the *Bulletins of the Bernice Pauahi Bishop Museum of Polynesian Etymology and Natural History at Honolulu*, 1899 ff. ETHEL WATTS MUMFORD.

HAZM.—See IBN HAZM.

HEAD.—I. Importance of the head.—Innumerable rites performed on or in connexion with the head show the importance which is universally attached to it. As the uppermost member of the body, that which contains the organs of sight, hearing, taste, and smell, it is naturally much honoured; while, as containing such a vital organ as the brain, which, however, is connected with the process of thought mainly at comparatively late stages of civilization, it is regarded as a seat of life or of the soul. The head, with its many apertures—nose, mouth, ears, sutures of skull—is a chief spirit-entry, either for a divine spirit or a god (as in the process of inspiration)¹ or for evil spirits. In either case it must be carefully guarded. Hence among many savages and also in the higher culture the head is regarded as peculiarly sacred, and is the subject of many tabus. When a Maori touched his head, he at once put his fingers to his nose and sniffed up the sanctity adhering to them from the touch.² In Tahiti, Burma, Melanesia, etc., this sacredness of the head makes it tabu to

¹ Cf. Crooke, *PR* i. 158.

² R. Taylor, *Te Ika a Maui*, London, 1870, p. 165.

the touch of woman, or it must never be below any place where a woman is.³ Hence also the head must be covered, veiled, or protected,⁴ lest evil should fall on it (see § 7 (d)). For the same reason heads are treasured relics, or sometimes, in the case of an enemy, are treated with contempt (see § 5 (a); and cf. Egyptian representations of enemies' heads as a footstool).⁵ In many cases the head is thought to be a seat of the soul or life, or, where a plurality of souls is believed in, of one of the souls, as, e.g., in Indonesia, where the soul material of man resides partly in the head, and, when it has left the body, it may be restored to it by a sorcerer through an invisible aperture in the skull.⁶

This belief is also found among the Caribs, Nutkas, Malays, Bataks, people of Celebes, Papuans, the Ga of W. Africa, the Maoris, etc.⁷ The soul can therefore be drawn out of the head, e.g. through the sutures of the skull, or it departs thence at death; hence the cracking of the skull at cremation in India (see *ERE* iv. 480). So, too, the soul returns after absence through the head, or is introduced into it by the medicine-man.

More usually, such a particular part of the head as the eye is the seat of the soul, because of the tiny reflexion seen in it by any one looking at it.⁸ The presence of the soul in the head is illustrated by the statement in *Śatapatha Brāhmaṇa*, vi. i. 1, 2-6, that the life-sap or excellence (*śrī*) of the seven males (*puruṣa*) out of whom Prajāpati was created became his head, *śiras*.⁹ In modern Hindu beliefs different gods reside in different parts of the body, and the top of the head is the seat of the Supreme Being.¹⁰ The Persians dedicated the head to Haoma, that at death he might receive the immortal part.¹¹ Similar ideas are seen among the Hebrews. Achish says to David, 'I will make thee keeper of mine head for ever' (1 S 28²); cf. Ps 140⁷ 'Thou hast covered my head in the day of battle,' and the custom of swearing by the head (Mt 5³⁶). Such beliefs as these explain the value placed upon the head, whether of friend or enemy. The head, as a very important part of the body, may also come to represent it, as, e.g., where heads of gods or mortals appear on monuments; or, as in Christian baptism, the earlier rite of more or less complete immersion was later limited to affusion on the head. The importance of the head has also given rise to metaphors signifying supremacy, beginning, and the like.

Before discussing wider groups of customs connected with the head, some references to sporadic ceremonies performed on it and showing its importance may be cited. In many healing rites the head of the patient is touched with various objects, generally of a sacred kind,¹² or charms and the like are bound upon the head,¹³ or the hand of the healer is laid on it.¹⁴ Among the Peruvians, at the ceremony for the expulsion of evils, a paste mixed with blood from the forehead of a child was rubbed on the head of each member of the family.¹⁵ Smearing the head with earth and water is a firstfruit rite among the Hos;¹⁶ and among the Nandi new grain is rubbed on the forehead.¹⁷ The ashes of a dead person mixed with gum are smeared

¹ C. H. Letourneau, *Sociologie*, Paris, 1880, p. 173; A. Bastian, *Der Mensch in der Gesch.*, Leipzig, 1860, ii. 150; R. H. Codrington, *The Melanesians*, Oxford, 1891, p. 233.

² Cf. the use of the sacred umbrella in China (*FL* i. (1890) 365).

³ J. G. Wilkinson, *The Ancient Egyptians*, ed. London, 1878, iii. 403.

⁴ *ARW* xii. (1909) 128.

⁵ See A. E. Crawley, *The Idea of the Soul*, London, 1909, *passim*; J. G. Frazer, *GB* i. *passim*.

⁶ E. B. Tylor, *PC* i. 388 ff.; Monseur, 'L'Âme pupilline et l'Âme poucet,' *RHR* li. (1905) 1 ff., 361 ff.

⁷ *SBE* xli. (1894) 144.

⁸ Monier-Williams, *Brāhmanism and Hindūism*, London, 1891, p. 405.

⁹ W. R. Smith², 379.

¹⁰ China (J. Doolittle, *Social Life of the Chinese*, London, 1866, p. 114); Borneo (Frazer, *GB* i. pt. v. vol. ii. p. 101); Mosul (R. C. Thompson, *Semitic Magic*, London, 1908, p. 106 f.); Italy (F. T. Elworthy, *Evil Eye*, London, 1895, p. 413).

¹¹ India, Babylonia (Thompson, 161, 165 f.).

¹² Thompson, p. xxiv; J. Napier, *Folk-Lore or Sup. Beliefs of the W. of Scotland*, Paisley, 1879, p. 36; see also *HAND*, § 2.

¹³ C. R. Markham, *Rites and Laws of the Incas*, London, 1873, p. 164.

¹⁴ J. Splith, *Die Ewe-Stämme*, Berlin, 1906, p. 304 f.

¹⁵ A. O. Hollis, *The Nandi*, Oxford, 1909, p. 46 f.

on the head to absorb his virtues, by the Digger Indians;¹ and rubbing the head with the brains of a dead man who was wise gives success in business, according to the Matabele.² Smearing the head with the blood of a sacrifice, probably to identify oneself with it, is found, *e.g.*, in Palestine,³ among the Arabs of Muhammad's time,⁴ the Romans at the Lupercalia,⁵ and the Lendu.⁶ The same application of sacrificial blood is also used as a cure for disease in Palestine and among the Jews of Algiers.⁷ The so-called 'Eucharist' of Lamaism is poured out into the hands of the worshippers by the Lama, and each person anoints his head with it, after which the Lama places the 'Vase of Life' on the bowed head of each, repeating a spell. The head is then touched with other sacred objects.⁸ Where blood is shed on the grave as a mourning custom, it is sometimes drawn from cuts on the head (see *ERE* iv. 431^a). Similarly, in Samoa, if a man found a dead owl, or if he committed transgression, he beat his forehead till it bled; and at ritual combats where the heads were beaten with clubs, the blood was an offering to the deity.⁹

2. Heads of deities, etc., with nimbus.—Here, again, as illustrating the importance of the head as the chief member of a god as of a man, it is often represented with rays shooting out in all directions, or with a circular disk behind or surrounding it. These were undoubtedly suggested by the sun and its rays, and were intended to typify the Divine power shining and radiating from the head. Hindu divinities have often such a nimbus, of a more or less elaborately shaped form. In Greek and Roman art it is also given to divinities, especially those representing sun and moon, and Teutonic and Slavic deities have often rays or stars around their heads. Mithra has a circular nimbus with pointed rays. It was also given to emperors and kings, to Oriental heroes or saints, etc. Buddhist art in India and Tibet shows Gautama as well as the saints with a nimbus.¹⁰ But it is in Christian art that the nimbus is most wide-spread. It is of different forms, usually circular, but occasionally triangular, bi-triangular, or square, and in some cases a series of rays emanates from the head. The field of the nimbus is ornamental or plain; and it surrounds the heads of the three Persons of the Trinity, the Virgin, angels, saints, prophets, living persons, allegorical figures, etc. In the case of the Divine Persons, the nimbus is usually cruciform, this being properly distinctive of them.¹¹

3. Many-headed gods, etc.—The custom of representing gods with several heads, like that of representing them with several hands, is probably the result of the current conception of the importance of these members. It was natural that in a god they should be multiplied. Nowhere is this more common in art and myth than in India. Siva is said to have a thousand heads, or sometimes three, and is thus represented.¹² Brahmā has four heads. Among the Egyptians and Semites this is not found, but a male Phœnician deity is occasionally two-headed.¹³ In Greek and Roman art and myth it is again merely sporadic. Hecate is three-headed, possibly representing Artemis, Selene, and Hecate; Hermes at cross-roads (*q.v.*) had two, three, or four heads, like the Roman Janus. The Celtic god of the under world is sometimes represented as a triple head, and some Slavic deities have four or five heads.¹⁴

¹ *JAI* iii. (1874) 530.

² R. H. Nassau, *Fetichism in W. Africa*, London, 1904, p. 178.

³ S. I. Curtius, *Prim. Sem. Rel. To-day*, London, 1902, p. 201.

⁴ W. R. Smith², 328.

⁵ W. Warde Fowler, *The Roman Festivals*, London, 1899, p. 311.

⁶ H. Johnston, *Uganda Protect.*, London, 1902, ii. 553.

⁷ Thompson, 211; *JE* xi. 600.

⁸ L. A. Waddell, *Buddhism of Tibet*, London, 1895, p. 448.

⁹ G. Turner, *Samoa*, London, 1884, pp. 21, 27, 57.

¹⁰ See A. N. Didron, *Christian Iconography*, Eng. tr., London, 1851, i. 22 ff.; J. Grimm, *Teutonic Mythology*, tr. Stallybrass, London, 1882-88, p. 323; A. Grünwedel, *Buddhist. Kunst in Indien*, Berlin, 1900, p. 63; Waddell, 337, 376.

¹¹ Didron, i. 22 ff.

¹² *Mahābhārata*, vii. 80, 54 f., iii. 39, 74 f.

¹³ Frazer, *Adonis*, London, 1906, p. 82.

¹⁴ J. A. MacCulloch, *Rel. of Ancient Celts*, Edinburgh, 1911, p. 34; Grimm, 322.

Tibetan Buddhist divinities are occasionally many-headed, like Padmapāni with eleven heads—probably a borrowing from Indian art.¹ Such monstrous forms do not occur among Teutonic deities, though they are sometimes given to heroes.² Monsters, giants, dwarfs, and dragons in myth and *Märchen* often possess many heads, which cause considerable trouble to the heroes who fight them. The Greek Geryon had three heads, Hydra nine, Briareus fifty, and the giants of Norse mythology have three, six, or even nine hundred heads.³ In *Märchen* the usual numbers are three and seven.

In Christian representations of the Trinity the Godhead is often depicted as a being with three blended heads, or three faces appearing on one head with four, three, or two eyes.⁴ Satan is also occasionally depicted with three faces—the trinity of evil—and with heads on chest, stomach, and knees.⁵

4. Men and deities with animals' heads.—In various acts of ritual men often wear the heads of animals, usually those of sacrificial victims. Among savages these are often worn at sacred dances, *e.g.* before hunting. Thus, at the Mandan buffalo dance, each dancer wears the skin of a buffalo's head with the horns attached, and imitates the movements of the animal, in order to procure good hunting.⁶ Similar customs were followed among the Celts and Teutons. At the New Year festival, riotous processions of men dressed in the heads and skins of animals took place, and these continued in Christian times, though forbidden by the Church.⁷ Figures of horse-headed men appear on old Gaulish coins, and these, as well as numerous Irish legends of cat-, dog-, or goat-headed men, doubtless reflect actual custom.⁸ In modern European folk-festivals, dances are sometimes performed by men wearing antlers or skulls of deer, etc., and these may be traced to older rites resembling those of the Mandans.⁹ In all such customs there had originally been some idea of assimilating the wearer of the head to the animal, and in some instances this was connected with totemism. The same purpose was served where a mask representing an animal's head was worn, as among many savage tribes.

Where earlier worshipful animals tended to become anthropomorphic, or where a divinity was blended with a worshipful animal, there was often a fusion of the two in myth or artistic representation. The god had some part of him in animal form, and very often possessed an animal's head. Probably in all religions this has existed to a greater or less extent. Some, however, were able to shake themselves entirely free of such monstrous forms, though they may still be found associated with demoniac beings; in others they continued to play an important part, as, *e.g.*, in the Egyptian religion.

In India, Gageśa has an elephant's head, and in China a god called the 'Divine Husbandman' has a human body with a bull's head. In Greece, where such compound forms generally came to be disliked, traces of them were still to be found. The Phigaleian Demeter had a horse's head, and in Arcadia excavations have revealed representations of female figures with heads of sheep or cows.¹⁰ Figures of Pan with a goat's head, of Apollo(?) with a ram's head, and others are also known. But it is in Egypt that this method of representing the gods was most conserved from pre-historic times onwards. Some of them invariably have animals' heads, others only occasionally (see *EGYPTIAN RELIGION*, vol. v. p. 245^b).¹¹

In some instances a divinity is represented wearing an animal head-dress, and sometimes also the skin of the animal—a custom perhaps connected with the practice of placing the head and skin of a sacrificial victim on the image of a god,

¹ Waddell, 367.

² Grimm, 387.

³ *Ib.* 527.

⁴ Didron, ii. 22, 52 ff.

⁵ *Ib.* 21 ff.

⁶ *FL* viii. (1897) 70.

⁷ MacCulloch, 260.

⁸ *RA* xii. (1902) pl. v.; MacCulloch, 217.

⁹ See *FL* iv. (1893) 174 ff.

¹⁰ Paus. viii. 42. 4; *BCH* xxiii. (1899) 635.

¹¹ Wilkinson, iii. 6 ff.

as well as with the assimilation of a god and a worshipful animal.

Conversely, human-headed divinities or genii with animal bodies occur sporadically—*e.g.*, in Babylon the fish-god Oannes (Ea), winged bulls with human heads, etc.; in Egypt the Sphinx; while there also the soul was represented as a hawk with a human head.

5. The head as trophy or cult-object.—(a) *Trophy*.—As the head is the most prominent part of the body, the seat of several of the senses and, in the belief of some peoples, of the soul, life, wisdom, etc., and as it is severed from the trunk with comparative ease, it has almost universally been taken as a trophy in war. The victor thus triumphs over his enemy; at the same time he is able to bring back a proof of his prowess, and, as a result, the greater number of heads he can show, the more is he honoured as a valiant man, and the higher respect and status does he obtain. The practice is thus analogous to the cutting off of an enemy's hands (see HAND, § 5(c)).

The Babylonians and Assyrians not only left dead enemies unburied, but, as a further method of insult and hurt to their ghosts, cut off their heads; and this practice is frequently referred to in the inscriptions or is portrayed on monuments; *e.g.*, vultures fly off with heads of the slain. The god Ningirsu is shown clubbing such heads collected in a net.¹ In Egypt a similar custom prevailed, and kings are represented holding a bunch of heads, or headless corpses are shown lying before a god. So also in the other world one of the punishments of the enemies of Râ and Osiris was beheading by Shesmu.² Among the Hebrews the practice was also followed. The heads of Oreb and Zeeb were brought to Gideon (Jg 7²⁵); David cut off Goliath's head and brought it before Saul; the Philistines cut off Saul's head, and the sons of Rimmon that of Ish-bosheth, bringing it to David (1 S 17⁵⁴⁻⁵⁷ 31⁹, 2 S 47; cf. 20²¹). The heads of Ahab's 70 sons were struck off and piled in two heaps (2 K 10⁶). In later times the head of Nicanor was brought by Judas Maccabæus to Jerusalem as a trophy (2 Mac 15³⁰). The Scythians presented their king with heads of slain enemies, those having none to show receiving none of the booty. The scalp was hung on the bridle.³ Among the Karmanians no one might marry until he had brought a head to the king, which was hung up in his house.⁴ Among the Celts, heads were cut off and carried at the saddle-bow or on spears, or strung on a withy and brought home. After a battle a pile of heads was made, and the number of the slain counted.⁵ Among American Indians, heads were sometimes placed on poles and carried as trophies through the village, or, as among the Abipones, were tied to the saddle.⁶ The taking of the scalp, which was brought home in triumph, the number of scalps possessed being proof of a warrior's prowess, was universal among the tribes. Among the Polynesians, heads of enemies were also struck off and used as trophies. The heads were piled before the chiefs, those of slain chiefs being placed on the top.⁷ The Tshi preserved the heads of hostile chiefs slain in battle.⁸ Head-hunting among the Dayaks and in Formosa has also for one of its purposes the taking of heads as trophies, to show bravery and manliness and to please the women of the tribe.⁹ Among modern Oriental nations—Persians, Turks—slain enemies were often decapitated and sent to the king to make a show.¹⁰ Timûr erected a pyramid of 90,000 heads on the ruins of Baghdad.¹¹ This was a common Oriental custom. Salmanassar made pyramids of the heads of the slain,¹² and the practice has probably given rise to the *Märchen* incident of a tower built of men's skulls.¹³ The triumphant placing of aristocratic victims' heads on pikes was common during the French Revolution.

(b) Various parts of the head sometimes take its

¹ L. W. King, *Hist. of Sumer and Akkad*, London, 1910, pp. 131, 138; Schrader, *KTB* ii. 181, 213; M. Jastrow, *Aspects of Rel. Belief and Practice in Bab. and Assyria*, New York, 1911, p. 360 (plate 31).

² H. Spencer, *Cer. Inst.*, London, 1879, p. 38; G. Foucart, *Hist. des rel.*, Paris, 1912, p. 65 f.; E. A. W. Budge, *Guide to the Egypt. Collections in the Brit. Mus.*, London, 1909, p. 144.

³ Herod. iv. 64 f.

⁴ Strabo, xv. p. 727.

⁵ Sil. Ital. iv. 213; Diod. Sic. xiv. 115; Livy, x. 26; Strabo, iv. p. 198; and Irish texts, *passim*.

⁶ NR I. 629; M. Dobrizhoffer, *Abipones*, London, 1822, ii. 408.

⁷ A. Featherman, *Oceano-Melanesians*, London, 1887, pp. 91, 204 f.; Turner, *Samoa*, 193.

⁸ A. B. Ellis, *Tshi-speaking Peoples*, London, 1887, p. 266 f.

⁹ S. St. John, *Forests of Far East*, London, 1892, ii. 28; H. Ling Roth, *Nat. of Sarawak and Borneo*, London, 1896, ii. 145, 163; *L'Anthrop.* x. [Paris, 1899] 96.

¹⁰ J. J. Morier, *Second Jour. through Persia*, London, 1818, p. 186.

¹¹ Gibbon, *Decline and Fall*, London, 1906, vii. 63.

¹² RP iii. [1874] 95.

¹³ See F. Liebrecht, *Zur Volkskunde*, Heilbronn, 1879, p. 406.

place as trophies, *e.g.* the ears; thus after the battle of Liegnitz nine sacks were filled with the right ears of the slain.¹ Jaw-bones or even mouths were also used as trophies, and generally the more a man possessed the more valorous was he deemed, as among the Papuans of Boigu,² the Tahitians,³ the Tshis and Ashantis,⁴ and the Chinese.⁵ The Tupis wore the mouth of the slain as a bracelet.⁶ Noses served the same purpose, and were worn with ears as necklets among the Arabs.⁷ Montenegrin soldiers presented noses to their chiefs as a sign of bravery as late as 1876;⁸ and of a Christian emperor, Constantine V., Gibbon relates (v. 220) that 'a plate of noses was accepted as a grateful offering.' Again, teeth were pulled out and triumphantly worn as necklets, bracelets, or anklets. This was common among many S. American tribes,⁹ the people of the New Hebrides, Ashantis, and other African tribes.¹⁰

In most of these cases the heads or parts of the head are sent to the chief or king or displayed before him as a sign of prowess, or as a symbol of victory. But they are occasionally dedicated to a divinity. This is suggested by the Bab. and Egypt. instances cited above, and it is also found among the Celts, who in cutting off a head saluted the gods and offered it to them or to ancestral spirits.¹¹ Skulls have also been found under an altar devoted to a Celtic Mars; and in Ireland heads were called 'the mast of Macha,' a war-goddess embodied in the scald-crow haunting the battlefield, just as in the Bab. stele birds fly off with heads.¹²

(c) *Preservation of trophies*.—These trophies serve a more permanent purpose than that of immediate tokens of victory, as some care is taken to preserve them, and they are usually placed on the walls of houses, on stakes, or on trees, or kept in some more or less sacred place. Thus they are a standing witness to the prowess of individual or tribe.

Herodotus (iv. 103) relates of the Tauri that they impaled the heads of shipwrecked persons and fixed those of enemies on a long pole above the roofs of their houses. Among the Celts, townships and palaces were filled with these ghastly trophies, over doors, on walls, or on stakes, to such an extent that Posidonius tells how he grew sick at the sight. A room in the palace was kept as a store for heads, and those of slain chiefs were preserved in cedar-wood oil or in coffers, and proudly shown as a record of conquest, large sums of money being refused for them.¹³ Up to a comparatively late time heads of private foes were placed on stakes in front of doorways,¹⁴ and Malcolm II. built into the walls of the church of St. Mortlach, at Keith, heads of Danes after their defeat. Among modern savages such customs are also found. In the Congo district heads are cleaned and placed on poles at the entrance to a town or on a hill.¹⁵ Among the Niam-Niam they are kept on posts round the houses.¹⁶ In Dahomey they were placed on roofs or gates of the king's palace, or paved the floor of his sleeping-place; and, when war was ordered, it was said that the king's house wanted thatch.¹⁷ The Maoris kept skulls in houses as trophies, or fixed them on poles; and in Tahiti walls were made up of human skulls.¹⁸ In the Solomon Islands there were set up two skulls of enemies on a post at the launching of a canoe, the canoe-houses being also decked with them, while the scalp and

¹ Gibbon, vii. 16.

² JRGS xiv. [1875] 167.

³ J. Hawkesworth, *Voyages*, London, 1773, ii. 161; Turner, *Samoa*, 393.

⁴ Ellis, 267; F. A. Ramseyer and J. Kühne, *Four Years in Ashantee*, London, 1875, p. 130.

⁵ JAI xxii. [1893] 172 f.

⁶ R. Southey, *Hist. of Brazil*, London, 1810-19, i. 222.

⁷ W. R. Smith, *Kinship*², 1903, p. 296.

⁸ *Times Report*, Dec. 14.

⁹ Tupis (Southey, i. 222); Caribs (B. Edwards, *Hist. of Brit. Colonies in W. Indies*, London, 1801, i. 45); Moxos (T. J. Hutchinson, *The Parana*, London, 1868, p. 34).

¹⁰ A. H. Keane, *Man, Past and Present*, Cambridge, 1899, p. 437; J. Beecham, *Ashantee*, London, 1841, p. 76.

¹¹ Sil. Ital. iv. 215; Lucan, *Phar.* i. 447.

¹² W. Stokes, *Three Ir. Gloss.*, London, 1862, p. xxxv; *CIL* xii. 1077.

¹³ Diod. Sic. v. 29; Strabo, iv. p. 198.

¹⁴ *Salic Law*, lxiv. 9.

¹⁵ Weeks, *FL* xx. [1909] 36.

¹⁶ G. Schweinfurth, *The Heart of Africa*, Eng. tr., London, 1873, i. 617.

¹⁷ A. Dalzel, *Hist. of Dahomy*, London, 1793, p. 76; R. F. Burton, *Mission to Gelele*, do. 1864, i. 218.

¹⁸ Featherman, 204; W. Ellis, *Polyn. Researches*, London, 1832, i. 309; A. S. Thomson, *The Story of N.Z.*, do. 1859, i. 130.

hair were put on a coco-nut and hung in the common hall.¹ In N. Guinea among the Wagawaga the *potuma* was decorated with skulls taken by the men to whom it belonged. In Babaka they were hung on platforms outside the villages.² In S. America the same customs were followed, e.g. among the Mundrucus, who placed skulls on their rude huts, and among the Abipones.³ Among the Nāgas the chief's house is hung round with skulls;⁴ and, among the Bontoc of Luzon, heads obtained at the period of planting and sowing are exposed on trees in the villages, and kept as relics once the flesh has decayed.⁵ The Wa of Upper Burma take heads for the benefit of the crops, place them in the 'spirit house,' and, after they are bleached, set them on posts in an avenue of trees. Thousands of skulls may thus be seen.⁶ In Formosa, Celebes, and Sumatra, and in other classic regions of the head-hunter, heads are dried and hung up in the huts or on chiefs' houses, and often ornamented with carved designs. Among the Land Dayaks, special houses are built for them, which form the bachelors' quarters and council chambers.⁷

In some instances, heads or skulls are treasured in a sacred building; e.g., in Mexico the head of the captive sacrificed to Tezcatlipoca was cut off and preserved along with heads of earlier victims in the sacred place.⁸ Again, heads are offered to dead ancestors (see below). Many of the instances cited above are connected with cannibalism, the body or brains being devoured; and the taking of a head is always the occasion for feasting, the head itself being fed and propitiated.⁹

(d) *Purpose of the preservation.*—Among actual head-hunting tribes and with some other peoples also who preserve heads of enemies, the reasons alleged for the practice show that they are something more than mere trophies, and that they are preserved primarily for animistic reasons, and in order to obtain the helpful presence and power of the spirit-owner of the head, whose soul-substance was stronger in the head than in any other part of the body. The Dayaks feast at each head-taking, lavish terms of endearment upon the head, and thrust food into its mouth. Its spirit-owner is told that he is now adopted into the captor's tribe, and must hate his old friends. By this means the ghost, which might otherwise have been dangerous, is supposed to be rendered not only harmless, but helpful. By the spirit's power, acting through the head, rice will grow abundantly, the forests will teem with game which will be easily taken, women will be fruitful, and health and happiness will abound.¹⁰ This influence of the head, or, rather, of the spirit acting through the head, is also seen in the case of the Bontoc, who obtain a head for every farm at planting and sowing; the Wa of Burma, who hunt for heads to promote the welfare of the crop; and the Lhota Nāga of N. E. India, who place head and feet in the fields for the same purpose.¹¹ Similarly, in New Caledonia, heads of old women are set up on poles as charms for a good crop,¹² and a like idea is seen in the Teutonic folk-belief that a skull buried in the stable makes the horses thrive.¹³ The spirit whose good wishes are invited is expected to become the guardian, friend, and benefactor of the tribe or family, and to be always with them.¹⁴ This is precisely the reason given by the Tauri for placing heads over their roofs.¹⁵ Other reasons are

¹ O. M. Woodford, *A Naturalist among the Head-hunters*, London, 1890, pp. 92, 152; H. B. Guppy, *The Solomon Islands and their Natives*, do. 1887, p. 16.

² J. Chalmers, *Pioneering in N.G.*, London, 1887, p. 325; O. Seligmann, *The Melanesians of Brit. N.G.*, Cambridge, 1910, pp. 21 f., 459; cf. 462.

³ J. Henderson, *Hist. of the Brazil*, London, 1821, p. 475; Dobrizhoffer, ii. 408.

⁴ J. Owen, *Nāga Tribes*, Calcutta, 1844, p. 12.

⁵ Schadenburg, in *ZE* xx. [1888] 39.

⁶ Scott and Hardiman, *Gazetteer of Upper Burma*, Rangoon, 1900-01, l. 493 ff.

⁷ Ling Roth, ii. 145 f.; Featherman, *Malayo-Melanesians*, London, 1881, pp. 318, 335, 502; *L'Anthrop.* x. 96.

⁸ J. de Torquemada, *La Monarquía indiana*, Madrid, 1723, ii. 259 f.

⁹ Ling Roth, ii. 170; *L'Anthrop.* v. [1894] 118.

¹⁰ Ling Roth, ii. 140, 170; W. H. Furness, *Home-Life of the Borneo Head-Hunters*, Philadelphia, 1902, p. 59.

¹¹ See above, and G. M. Godden, *JAI* xxvii. [1893] 9.

¹² Turner, *Samoa*, 342.

¹³ Grimm, 1810.

¹⁴ Furness; St. John, *loc. cit.* ¹⁵ Herod. iv. 103.

alleged, but these also show the animistic basis of the custom.

The Dayaks believe that those whose heads are taken will be the slaves of their captors in the next world—an idea which is shared by the Lhoosai of India, who cut heads off after a battle.¹ Again, heads are taken by the Dayaks after a death, because it is supposed that a man of consequence cannot be buried or that a dead relative will not rest until this is done in his name; or by the Formosans, because the spirits of ancestors are pleased to see the huts adorned with heads.² The Kukis also take heads at the death of a chief, and in Celebes a chief's tomb is supplied with two heads of enemies or of slaves.³ This custom also obtained among the Celts, since skulls have been found buried with the dead.⁴ Sometimes in Borneo the spirit of the head is expected to persuade its former friends to come and be slain, and a prayer to this effect is addressed to it nightly,⁵ while in the Congo district the spirit of the head cut off in war is believed to haunt members of its family.⁶

(e) There can be no doubt that, whether in conjunction with preserving the skull or not, where the custom of eating the brain is found (e.g. among the Dayaks, in Luzon, in New Guinea, in New Ireland, in the Torres Straits Islands⁷), or of eating a mass of food in which a head has been cooked (as among the Batonga and the Garos⁸), this has also an animistic basis. It is usually expressly stated that it is done to acquire the courage or wisdom of the dead man. In some cases it is enough to eat some part of the head—the eye (Sandwich Islands, N. Zealand, Marquesas Islands) or the tongue (Torres Straits, ancient Karmanians)⁹—to acquire these qualities. The same purpose underlies the practice of using the skull of an enemy as an occasional or usual drinking-vessel. The liquid is the medium through which the powers of the owner of the skull or his spirit are transferred.

This was done by the Gauls,¹⁰ Irish (milk drunk from a skull restores to warriors their pristine strength),¹¹ Scythians,¹² the ancient Arabs,¹³ Fijians, peoples of the Congo,¹⁴ Uganda (priest drinks beer from skull of king to be possessed by his spirit),¹⁵ Muskhooges (because good faculties of mind come from the brain).¹⁶ A similar custom occurs sporadically in folk-medicine and magic. In Germany other people's pigeons will come to your cot if you give your pigeons drink from a human skull.¹⁷ In the W. Highlands to drink from the skull of a suicide is a potent cure for certain ailments.¹⁸

(f) A distinction must be made between the practices already referred to, where an enemy's skull is concerned, and those connected with the *heads of relatives or ancestors*. Here also, however, the animistic basis is obvious, and it appears quite clearly from the Calabar custom of cutting off the head of a great chief at burial and keeping it secretly lest it and therefore the spirit of the chief should be stolen from the town,¹⁹ and from

¹ Ling Roth, ii. 140; G. L. Gomme, *Ethnol. in Folk-Lore*, London, 1892, p. 154.

² Ling Roth, ii. 140; H. Low, *Sarawak*, London, 1848, p. 335; *L'Anthrop.* x. 96.

³ *JASB* ix. 836.

⁴ Roget de Belloguet, *Ethnogenie gauloise*, Paris, 1861 f. iii. 100.

⁵ J. Brooke, *Letters*, London, 1853, i. 303.

⁶ Weeks, *FL* xx. 37.

⁷ St. John, i. 123 f.; Featherman, *Oceano-Mel.* 501; R. Neuhaus, *Deutsch Neu-Guinea*, Berlin, 1911, iii. 131; H. H. Romilly, *The W. Pacific*, London, 1886, p. 58; J. MacGillivray, *Voyage of 'Rattlesnake'*, do. 1852, li. 4 f.

⁸ Nassau, 177 f.; *JAI* ii. [1873] 396.

⁹ Strabo, xv. p. 727.

¹⁰ *Sil. Ital.* xiii. 482; Livy, xxiii. 24; Florus, i. 39.

¹¹ *ZCP* i. 106.

¹² Herod. iv. 65.

¹³ W. R. Smith, *Kinship*², 296.

¹⁴ Weeks, *FL* xx. 36.

¹⁵ J. Roscoe, *JAI* xxxi. [1901] 129.

¹⁶ J. Adair, *Hist. of Amer. Ind.*, London, 1775, p. 135.

¹⁷ Grimm, 1823.

¹⁸ Cf. also *ERE* iv. 511^a for the similar Tibetan custom in the case of a relative's skull.

¹⁹ M. H. Kingsley, *Travels in W. Africa*, London, 1897, p. 449 f.

the Polynesian idea that the spirit acts from the skull and is a guardian of the family.¹ Whatever the method of burial, the preservation of the head or skull of dead relatives out of affection, or in order to obtain communion with them, or to gain their good offices because of their pleasure at the respect shown to them, or for actual cult purposes, was probably an early custom, and is found in many parts of the world. It is met with mainly among the Melanesians and Polynesians, but it exists also in Africa and sporadically in America, chiefly in the southern part of the continent.

Bodies buried without heads were found at Cranbourne Chase, dating from Neolithic times, and these suggest separate preservation of the head. Elsewhere skulls have been found buried alone.² Herodotus reports that the Issedones made bare and cleansed the head, and, having gilded it, treated it as sacred and sacrificed to it (iv. 26). In Egypt the myth of Osiris told how, after the dismemberment of his body, his head was buried at Abydos or at Memphis. The sanctuary at Abydos was therefore holiest of all, and the symbol of the city was the coffer containing the head. This may point to some separate treatment of the head in early Egypt, especially if Egyptian civilization and religion were indigenous in Africa, where the head is often venerated. Before the rise of the custom of extracting the brain through the nose in mummification, the head was cut off for this purpose and filled with spices, and a formula was used to prevent the head of one man being confused with that of another.³ Among some African tribes a chief is buried with his head above ground. After the flesh has decayed, the skull is either buried or kept for magical purposes.⁴ Such skulls are usually preserved out of sight. Heads of distinguished men among the Mpongwe are hung up, and the decomposed matter is allowed to drip on a piece of chalk. The brain is the seat of wisdom, and this is absorbed by the chalk, which is then applied to the heads of the living that they may obtain wisdom.⁵ Among the Baganda a part of the head, the jaw-bone, especially of the kings, was carefully preserved because the ghost clung to it, and hence could be worshipped or its help obtained through the jaw-bone as long as that was honoured. Those of kings were preserved in the temples of the kings, and some jaw-bones were a thousand years old.⁶ Among the Taveta, E. Africa, the preservation of a skull preserves the spirit of the dead, and the accumulated skulls of a family or tribe thus guarantee future reunion.⁷

The custom of the widow carrying the husband's skull or jaw as a memento or amulet is found among some Australian tribes, Andaman Islanders, and in New Guinea.⁸ In New Caledonia the head was twisted off ten days after death, and the skull preserved, offerings of food being made to it during sickness.⁹ In various parts of Melanesia it is believed that the dead man's *mana* can be obtained, through his skull, for the benefit of the survivors. These skulls are carefully kept, and food-offerings are made to them.¹⁰ In the Solomon Islands the skull is preserved in a sanctuary, and is usually enclosed in a piece of wood fashioned in the form of a fish, or in a miniature hut. Here also the skull is full of *mana*, and through it the help of the spirit can be obtained, mainly by means of offerings.¹¹ In Tahiti the skull was preserved separately from the body, and was usually hung from the roof of the house.¹² In Nanumanga it was believed that the soul, when called on, came back to the place where the skull was kept to drive away disease, etc. Here the head was exhumed after burial. In Netherland

¹ W. Ellis, *Polyn. Researches*, i. 272, 335-336.

² *JAI* v. [1876] 146; *Brit. Assoc. Rep. Ipswich*, 1895, London, 1895, p. 519.

³ E. A. W. Budge, *Osiris and the Egyp. Resurrection*, London, 1911, i. 169, 212, ii. 1.

⁴ Kingale, 70, 479; Johnston, ii. 748 f., 828.

⁵ Nassau, 158.

⁶ J. Roscoe, *The Baganda*, London, 1911, p. 282.

⁷ *JAI* xxi. [1892] 369.

⁸ *Ib.* xiii. [1884] 190, xii. [1883] 143, 401, xxi. 432 (Kiriwina of N. Guinea, jaw ornamented with beads), xix. [1890] 307, 319, 416 (wild tribes of Torres Straits, skull carried for affection but used for divination, *s.g.* to find out the one who caused death; here also skulls were painted and adorned or fitted with nose ornaments, and gave oracles; the skull was enjoined to speak the truth; then the inquirer placed it under his pillow, and it was supposed to speak to the sleeper).

⁹ Turner, *Samoa*, 342.

¹⁰ Oodrington, 264, 267.

¹¹ Oodrington, *JAI* x. [1881] 308; *L'Anthrop.* iv. [1893] 210; *ARW* viii. [1908] 820.

¹² Ellis, *Polyn. Res.* i. 406; cf. also *ERE* iv. 359, for the Sandwich Islands custom.

Island and in Onoatua the skulls of relatives were hung up in houses.¹

Among the Celts a custom of preserving and offering some cult to heads of ancestors and a belief in their powers may have existed. This is suggested by various tales, based on earlier myths which must have originated out of some actual practice.

Thus in the *Mabinogi* of Branwen, Bran, a Brythonic god, directs his friends to cut off his head after his death and bury it in the White Hill at London, facing France. This is done, and in the long delay on their journey thither the head affords them entertainment. Finally, the head—the *Urdawl Ben*, or 'Noble Head'—is interred and protects the land from invasion until Arthur disinters it. This appears to reflect actual belief and custom. There are also tales of heads which, when cut off, went on speaking.² This recalls the myth of Orpheus, whose head sang; and its burial-place became a sacred precinct.³ In Scandinavian mythology the Vanir cut off Mimir's head; but Odin spoke spells over it so that it could not decay, and still uttered speech.⁴ Lane⁵ refers to popular Muhammadan beliefs of the heads of saints talking after decapitation. The possibility of the consciousness of the brain after beheading, and even of the head speaking, was much discussed during and after the French Revolution; and there are stories of Charlotte Corday's head speaking, and, at an earlier time, that of Sir Everard Digby.⁶

In the Christian Church, among the relics of saints or martyrs the head or skull has frequently been singled out for adoration or as possessing great miraculous power. Thus 'the head of St. Marnan, preserved at Aberchirder, was ceremonially washed every Sunday, and the water carried to the sick and diseased, who derived benefit and recovered health from its sanative properties.'⁷ Among Muhammadans a similar reverence is paid; *e.g.*, the burial-place of the head of al-Husain in Cairo is much visited by worshippers.⁸

(g) Many of the instances cited above imply a *cult of the head*, or of the spirit of whom the head is the medium or habitation. Through the head or skull the living obtain *mana* or help of various kinds, and the head is a powerful protective. But the mere representation of a head would be thought to give similar if not equal results. This may be the reason why human heads are a frequent *motif* in savage art. Such sculptured heads were also common in Celtic art, and among the Celts, as has been seen, there was a cult of human heads. Further, as the skull or head of an ancestor was the means by which *rapport* with himself was gained wherever there was a cult of heads, so it may later have been thought enough to represent the head of a divinity as a means of gaining communion with him. This may explain the existence of images of Divine heads among the Celts, often represented in triple form (see CELTS, § XIII. 2).⁹ Celtic myth has also much to tell of the power of Divine or heroic heads. It is not impossible that the Roman representations of the head of Janus may be due to similar ideas.

(h) *The representation of a monstrous and hideous face and head*, probably connected with grotesque masks used by savage peoples, has everywhere been regarded as an effective amulet against demoniac powers or, more particularly, the evil eye (*q.v.*). In antiquity, hideous masks were sometimes worn for this purpose, and monstrous heads were much in vogue in Greece. To these is doubtless due the myth of the Gorgon's head cut off by Perseus, which still retained its evil powers after decapitation.¹⁰ Cf. art. GORGON.

¹ Turner, *Samoa*, 288, 300 f.

² *RCel* xxii. [1901] 123, xxiv. [1903] 18; J. Curtin, *Tales of the Fairies and the Ghost World*, Dublin, 1895, p. 182.

³ Conon, *Narr.* 45.

⁴ Grimm, 379; cf. 1592 for other legends of talking heads.

⁵ *Modern Egyptians*, London, 1846, ii. 51.

⁶ See O. W. Holmes, *Mechanism in Thought and Morals*, London, 1871, p. 13 f., and a story by Dumas in his *Les mille et un Fantômes*, Brussels, 1849.

⁷ MacCulloch, *Religion, Its Origin and Forms*, London, 1904, p. 60.

⁸ Lane, i. 19.

⁹ MacCulloch, *Religion of the Anc. Celts*, pp. 33 f., 242.

¹⁰ Lucian, *Dial. of the Sea-Gods*, xiv.; Elworthy, *Evil Eye*, 141, 158 ff.

(i) One source of the formation of images is to be traced in the custom, found in W. Africa, Indonesia, and Melanesia, of surmounting the rough wooden figure representing the body of an ancestor with his skull. The image is thus animated by his spirit. This custom has an analogy in the Melanesian method of representing ancestors by a human performer wearing a mask in which part of a skull is inserted. With these also may be compared the Sumatran magic staves, in the head of the uppermost figure of which is enclosed the brain of a boy. A similar custom is followed in the case of the war idol made at the opening of hostilities by the Bataks of Sumatra, with a boy's brain inserted in a hole within the navel. In this way the image obtains a soul.¹

(j) A pre-historic method of burial was that of cutting off the head and placing it between the knees of the corpse. To judge by later analogies, this was probably done to prevent the deceased or his ghost from returning, but possibly only in the case of dangerous persons or enemies. In Egypt a sculptured plaque of the IIInd dynasty shows ten corpses of enemies decapitated with their heads between their legs. The custom existed in Albania in the 4th and 5th centuries of our era,² and was not uncommon in other parts of Europe in mediæval times. It has also occurred sporadically in modern folk-custom. In West Prussia, to prevent a dead member of the family from inflicting disease on the living, his coffin was opened and his head cut off.³ In England, in the case of the doer of some atrocious deed, his head was severed from the body and placed between the legs or under the arm.⁴ For a similar Lithuanian practice to prevent annoyance from the deceased, see *ERE* iv. 433^a. The practice probably had a very wide range, if we may connect with it the many stories of headless ghosts, found not only in Europe but in India.⁵

In Gloucester a headless ghost was believed to haunt a field, and here an actual interment with head beside thigh was found.⁶ Such ghosts appear with the head tucked under the arm; and it is a German superstition that the unblest spirit or the ghost of a malefactor whose crime was not divulged before his death must wander in this way. The headless ghost is often on horseback.

(k) In human sacrifice, etc., the head is often ritually cut off and receives separate treatment. This appears in the myth of Lityerses, where a stranger was taken to a corn-field to reap, and then wrapped in a sheaf, his head cut off with a sickle and his body cast into the river—a myth illustrating actual custom.⁷ The Mexican custom of preserving the heads of victims sacrificed as representing Tezcatlipoca has already been referred to (§ 5 (c)), and a similar custom of cutting off the heads of dough images prevailed.⁸ In Ashanti, at the yam 'custom,' the head of a sacrificed slave was placed in the hole whence the new yams were taken.⁹ In Bab. ritual the sacrificer speaks of giving the head of the child for his own head.¹⁰ On Karatonga the reeking human head was offered to Tangaroa, and the body consumed by the worshippers.¹¹

In some *Märchen* the vitality of the head is shown by the fact that a human head reduced to ashes, and swallowed by a

¹ Y. Hirn, *The Origins of Art*, London, 1900, p. 291; C. B. H. von Rosenberg, *Die malayische Archipel*, Leipzig, 1879, i. 60.

² *L'Anthrop.* xii. [1911] 663. ³ *FL* xi. [1900] 249.

⁴ J. O. Atkinson, *Forty Years in a Moorland Parish*, London, 1891, p. 217 f.

⁵ Crooke, *PR* 2 l. 256 ff. For such stories, see Grimm, pp. 919, 934, 943 f., 949, 981; R. Hunt, *Pop. Romances*, London, 1881, pp. 145, 244; J. F. Campbell, *Popular Tales of the W. Highlands*, Edinburgh, 1890, ii. 101.

⁶ *FL* xix. [1908] 37.

⁷ *Script. Rerum mirab. Græci*, Brunswick, 1839, p. 220 f.

⁸ F. S. Clavigero, *Hist. of Mexico*, Eng. tr., London, 1807, i. 809.

⁹ T. E. Bowdich, *Mission to Ashantee*, London, 1837, p. 226 f.

¹⁰ Ball, *PSBA* xiv. [1892] 149 f.

¹¹ W. W. Gill, *Myths and Songs from the S. Pacific*, London, 1876, p. 11.

woman, or an animal's head eaten by an animal, causes conception. In an Eskimo tale a girl is changed into a seal and cut in pieces by the hunter, but the head slips into the womb of his wife and the girl is re-born.¹ An occasional remedy for sterility is for a woman to tread on a human skull.² Reference may also be made to the power which the decapitated heads of monsters have of growing on again. Birth from the head is sporadically found, e.g., in the Greek myth of Athene born from the head of Zeus, and in Hindu stories.³

In Polynesian myths the coco-nut tree is supposed to have originated from a human head or from that of an eel.⁴ In numerous *Märchen* the incident of a tree springing from a buried human head occurs. In a Samoan myth, pigs originate from human heads flung into a cave by a cannibal chief.⁵ Various creation myths tell how part of the universe was made from this or that part of the head of a vast being or giant;⁶ while in a Chaldean cosmogony preserved by Berosus the head of Bêlos is cut off, the blood is mixed with earth, and from this men and animals are made.⁷

6. Heads of animals.—These also have a distinctive place in custom and ritual, and frequently special attention is paid to the head of a sacrificial animal. Among the Veddas, when game is obtained, the head and a portion of the flesh of each deer taken is cooked as an offering to Kande Yaka, and afterwards eaten by the community.⁸ The Wanzamwezi of W. Africa place the head of the killed beast before the huts of the *mizimu* along with a little flesh.⁹ When the Dayaks offer fowls to the water-goddess, they cut off the heads and throw them into the stream.¹⁰ Herodotus reports of sacrifices in Egypt that imprecations (averting evils) were pronounced upon the head after it was cut off and then it was either sold to strangers or thrown into the river. No Egyptian would eat the head of any animal.¹¹ But this is not confirmed by monumental evidence, and the head appears as an offering quite as often as any other part of the animal.¹² Probably some particular sacrifice only is referred to by Herodotus. Among the Hebrew sacrifices occasional directions are given for the treatment of the head. That of the Passover lamb was to be eaten along with the flesh (Ex 12⁹). In the case of the burnt-offering the head is mentioned as one of the parts which must be laid on the altar and burnt (Lv 1⁸, 12, 13). In the case of the sin-offering of ignorance, the head is one of the parts which are not sacrificed but taken outside the camp and burnt (Lv 4¹¹; cf. 8¹⁷). Among the Teutons and Scandinavians, heads of sacrificed animals were sometimes the important part of the offering assigned to the gods; but, again, they were sometimes suspended on trees in the sacred grove and thus 'consecrated by way of eminence to the god.'¹³ Similar customs obtained among the Celts, and are referred to in Acts of Saints, who tried to combat the popular pagan cults of Gaul.¹⁴

Among those peoples with whom the bear is an object of reverence—Ainus (*q.v.*), tribes of northern Asia, some American Indian tribes—when one is killed in the hunt, its head has particular care bestowed upon it.

Thus among the Gilyaks (*q.v.*) the head and skin are borne solemnly through a smoke opening into the *yurta*. Women receive it with solemn music, and the head is set on a platform

¹ A. Leskien, *Litauische Volkslieder*, Strassburg, 1882, p. 490; T. F. Crane, *Italian Pop. Tales*, London, 1885, p. 208; H. de Charencey, *Le Fils de la Vierge*, Havre, 1879, p. 20; A. de Gubernatis, *Le Novelline di S. Stefano*, Turin, 1869, p. 41; H. Rink, *Tales and Trad. of the Eskimo*, London, 1875, p. 450.

² E. B. Cromer, *Modern Egypt*, London, 1908, ii. 505.

³ Hesiod, *Theog.* 924 f.; E. S. Hartland, *LP*, London, 1894, i. 130.

⁴ E. Modigliani, *Un Viaggio a Nias*, Milan, 1890, p. 618; Turner, 245; Gill, 80.

⁵ Turner, *Samoa*, 111.

⁶ Hindu (*Rigveda*, x. 90); Scandinavian (*Edda*, 2).

⁷ F. Lenormant, *Les Origines de l'histoire*, Paris, 1880-84, i. 42 and appendix.

⁸ C. G. and B. Z. Selligmann, *The Veddas*, Cambridge, 1911, p. 152.

⁹ L. Decle, *Three Years in Savage Africa*, London, 1898, p. 343 f.

¹⁰ H. H. Ploss, *Das Weib*, Leipzig, 1891, i. 438.

¹¹ ii. 59. ¹² Wilkinson, ii. 458.

¹³ Griim, pp. 47, 63, 67, 72; and, for later survivals, p. 1050.

¹⁴ MacCulloch, *Rel. of Anc. Celts*, 198, 204; Grimm, 77.

adorned with pine branches. Offerings are set before it, and on the next day, called 'the foddering of the head,' it is fed from every dish served at the feast.¹

The Ainu set skulls of slain bears in the place of honour in their huts, or fix them on poles and sacrifice to them, believing that the spirits of animals dwell in the skulls.² The Ostiaks hang the head on a tree and worship it.³ Among those American Indian tribes who venerate the bear, the head is tied to a tree as a mark of respect, or hung on a post after being painted. Homage is paid to it, and it is expected to bring good luck to the hunters.⁴ Analogous customs are found elsewhere.

In Timorlaut, skulls of turtles are hung under the house, and prayer and sacrifice are offered them in expectation of their assistance during turtle-fishing.⁵ The Koryaks of Siberia place heads of whales or seals on their roofs and then on the hearth where offerings are made to them, and their souls go forth to sea to induce other animals to be caught.⁶ Among the Kurnai of S.E. Australia the native bear, when slain, is duly divided, and the head, as the most honourable part, goes to the camp of the young men.⁷ In various parts of British New Guinea, skulls of animals are preserved in the *potuma* or presented to the chief and fixed on his house.⁸ In Tibet the house is guarded against demons by a ram's skull and other objects fixed above the door.⁹ Among the Greeks and Romans it was customary to nail the head of sacrificial victims, especially of the ox, above the door of the house in order to ward off evils. Such heads were called *βουκράτιον*, *bucranium*.¹⁰ The head of the October horse was cut off and decked, and, after a fight for its possession, it was fixed on the wall of the Regia or on the *turris Mamilia*.¹¹ Among the Scandinavians, Teutons, and Slavs the heads of sacrificial animals, especially those of horses, were set upon poles or on houses in order to keep off evil influences, while the significance of this custom is found in many practices recently surviving. To these actual heads fixed on houses must be traced the carved horses' or other animals' heads on gables of mediæval houses in Germany, Russia, England, etc., regarding which occasional legends are told. Where an actual skull was fixed on the building, it may have been that of an animal killed as a foundation sacrifice.¹²

It is thus obvious that the animal's head serves an analogous purpose to that of the human head, and that the similar customs with respect to both have their origin in similar ideas respecting the spirit acting through or from the head. This is apparent in the Baganda belief that ghosts of slain buffaloes are dangerous. Hence the head is never brought into a garden of plantains, but eaten in the open country, and the skull placed in a specially built hut, where offerings are made to it, to induce the ghost to do no harm.¹³

In many cases magical rites are performed with animals' heads for different purposes, e.g. to cause a large supply of the animal in question to fall to the hunter,¹⁴ to prevent disease spreading by burying the head in the grave of the deceased,¹⁵ or charms are made from animals' brains,¹⁶ or they are worn dried as amulets.¹⁷

7. Rites connected with the head.—The importance of the head is further seen in the number of rites connected with it or performed upon it. In the article HAND (§ 3) it has been seen how the laying on of hands takes place upon the head, while it is also upon the head that anointing and the affusion of sacred liquids usually take place (see ANOINTING).

(a) The head is often *shaved* at different occasions in life; and, whatever secondary purposes this or

¹ Sternberg, *ARW* viii. [1905] 268 ff.; cf. J. Batchelor, *The Ainu and their Folk-Lore*, London, 1901, pp. 352, 495.

² Batchelor, p. 486.

³ P. S. Pallas, *Reisen durch versch. Provinzen des russ. Reichs*, St. Petersburg, 1771-76, iii. 64.

⁴ J. Mooney, *19 RBEW*, pt. 1 [1900], p. 446; X. de Charlevoix, *Hist. de la Nouvelle France*, Paris, 1744, v. 173 f.

⁵ J. A. Jacobsen, *Reisen in die Inselwelt des Banda-Meerces*, Berlin, 1896, p. 234.

⁶ Jochelson, *The Koryak*, Leyden, 1908, p. 66 f.

⁷ Howitt, 759. ⁸ Seligmann, 22, 229, 455, 556.

⁹ Waddell, 484.

¹⁰ L. F. A. Maury, *Hist. des rel. de la Grèce ant.*, Paris, 1857, ii. 90.

¹¹ Fowler, *Roman Festivals*, 242.

¹² See S. Baring-Gould, 'On Gables,' *Murray's Magazine*, I. [1887] 613 ff.; *FL* xi. 322; Grimm, 659 f.

¹³ Roscoe, *JAI* xxxii. [1902] 54.

¹⁴ Seligmann, 294. ¹⁵ Turner, *Samoa*, 335 (New Hebrides).

¹⁶ P. B. du Chaillu, *Explor. and Adventure in Equat. Africa*, London, 1861, pp. 71, 260 f. (Fans).

¹⁷ W. E. Smith², 281 f.

hair-cutting (see HAIR AND NAILS) may serve, the primary purpose seems to be the removal of evil influences and impurity from the head. The hair being removed, such evils cannot cling to the head. Some of the following examples will make this clear.

The ceremonies of the Kaffirs, after lightning had struck any thing or person, included shaving the head.¹ Soon after *birth* the head of the child is shaved in China, though here the belief now is that evil spirits which might attack the child will be deluded into thinking he is a despised Buddhist priest.² The early Arabs shaved the child's head and then daubed it with sacrificial blood—a purification.³ Shaving the child's head is also a Hindu rite,⁴ and it is used in modern Egypt.⁵ Similarly, before *circumcision*, *name-giving rites*, *latuing*, and the like, shaving of the head takes place.⁶ In some regions it is also a customary rite before *marriage* in the case of the bride.⁷ In the case of the *priesthood*, shaving the head is a rite of initiation, or the head must be kept shaved as one of a series of rites to avoid impurity. This was the case with the priests of Melkart.⁸ In Egypt the priests shaved their heads every third day,⁹ and in the case of initiation to the Isis mysteries shaving the head was a necessary preliminary.¹⁰ It is also a Brâhmanic rite of initiation,¹¹ and the Buddhist rite of 'ordination' includes complete shaving of the head.¹² In order to mark off the Hebrew from pagan priesthoods, shaving the head of the priest was forbidden (Lv 21⁵, Ezk 44²⁰).

The tonsure in the Christian Church is doubtless connected with these ideas of purity and removal of evil influences. In connexion with *pilgrimages*, shaving the head is also a necessary rite either before or during the journey.¹³ The idea of removing impurity and danger is clearly seen in the Hebrew injunction to shave the head of the female captive before taking her to wife (Dt 21¹²), and of the leper as part of the ritual of his purification (Lv 14⁹), in the Arab custom of the offender appearing at the door of the injured person with shaven head as part of the ritual of reconciliation,¹⁴ and in the Chinese custom of shaving the head of the child who has fallen into a sewer, in order to let out the evil influence.¹⁵

Shaving the head as a *mourning* rite has also been a very general custom; and, although this, like cutting the hair, may have come to be regarded as an offering of the hair to the dead, which thus established a bond of union between them and the living, it originated in a desire to rid oneself of the evil contagion of death which might be clinging to the hair.

This rite was common in antiquity, but was not practised by the Egyptians, whose hair was habitually shaved,¹⁶ although in the mourning for Osiris the worshippers appeared with shorn heads, i.e. probably without their wigs, which were generally worn.¹⁷ In the mourning for Adonis at Byblus the people shaved their heads, mourning for the dead god, thus following the custom of mourning for dead relatives.¹⁸ The custom was also followed by the Hebrews, but was forbidden by the legal codes (Lv 19²⁷ 21⁵, Ezk 7¹⁸, Jer 16⁶, Dt 14¹; cf. Am 8¹⁰). It is also found among many savage tribes.¹⁹

(b) The ritual *washing* of the head is a usual accompaniment of purificatory ceremonies in many regions, and already in the Bab. Epic of Gilgamesh it is referred to as part of the outward procedure by which inward grief may be put away: 'Thy head be washed, bathe in water!' But probably with most peoples this is a very occasional proceeding on account of the sanctity of the head and the danger of detaching any of the hair from it in the process.²⁰

¹ J. Maclean, *Compendium of Kafir Laws*, Cape Town, 1866, p. 83 f.

² Doolittle, ii. 229.

³ W. R. Smith², 328.

⁴ E. W. Hopkins, *The Rel. of India*, Boston, 1898, p. 246.

⁵ Lane, i. 83.

⁶ A. C. Hollis, *The Masai*, Oxford, 1905, p. 294 ff.; Park, cited in Elworthy, *Evil Eye*, 422; Seligmann, 265.

⁷ Featherman, *Oceano-Mel.* 203 (Fiji); J. Shooter, *The Kaffirs of Natal*, London, 1857, p. 75.

⁸ Frazer, *Adonis*, 36.

⁹ Wilkinson, i. 181; Herod. ii. 36.

¹⁰ Apuleius, *Metam.* xi. 16.

¹¹ A. van Gennep, *Rites de passage*, Paris, 1909, p. 149.

¹² Waddell, 178 f., 180.

¹³ *FL* xviii. [1907] 393 (Hindus); Lane, i. 129 (Muhammadans).

¹⁴ W. R. Smith², 337.

¹⁵ J. J. M. de Groot, *Rel. System of China*, vi. (Leyden, 1910) 1103 f.

¹⁶ Herod. ii. 36; Wilkinson, ii. 326, 329.

¹⁷ Firmicus Maternus, *de Errore prof. rel.* ii. 3.

¹⁸ Lucian, *de Dea Syria*, vi.

¹⁹ *FL* xix. 283 (Balemba); Seligmann, 162, 274, 611 (New Guinea); J. R. Swanton, *Contrib. to Eth. of the Haida*, N. York, 1905, p. 34 f.; M. Lewis and W. Clarke, *Travels to Source of the Missouri*, London, 1817, p. 54 (Dakotas); Schweinfurth, ii. 34 (Niam-Niam).

²⁰ See W. E. Smith², 485; Warde Fowler, 201.

(c) The placing of ashes, dust, or earth on the head has been frequently recognized as a sign of abasement or of grief and mourning. Many African tribes adopt it as the proper method of an inferior in approaching a superior.¹ It is similarly used among Oriental peoples,² and among the Hebrews it was commonly adopted either as a method of approaching God or a conqueror in humiliation, or as a token of excessive grief, and of mourning for the dead (Jos 7⁶, 1 S 4¹², 2 S 1³ 13¹⁹; cf. Is 61³).³ The Egyptians also used it as a sign of mourning.⁴

While this action shows humility, it thus helps to propitiate either deity or superior; and, though in mourning it is a natural act on the part of those who believe that indifference to cleanliness, neatness, etc., is a concomitant of grief, there may be some idea also of thereby propitiating the ghost. The suggestion that the dust was taken from the grave or ashes from the funeral fire in the case of mourning is ingenious but uncertain.⁵

(d) The covering of the head by certain persons at certain times, or habitually, is a matter of obligation, to omit which would be to incur ill-luck and danger. As things sacred are dangerous, and as the head is regarded as sacred, there are occasions when it might be harmful to the ritual act which is being performed or disrespectful to the divinity, to uncover it. And, conversely, dangerous influences might fall on the sacred head at that particular moment. Shamans and priests frequently cover the head when performing magical or religious rites.

Among the Veddas the cloth which is held over a shaman's head, when his hair is being cut, also covers his head in the sacred dances.⁶ In Borneo, while engaged in the magic ritual of healing, the shaman has his head veiled.⁷ The priests of the Goths, according to Jordanes,⁸ were called *pileati*, because they covered the head with a hat while sacrificing.⁹ The Roman priests while performing sacrifice covered the neck and back of the head with the toga (*velato capite*).¹⁰ The custom was traced to the advice given by Helenus to Aeneas,¹¹ but Plutarch suggests other reasons—humility, the avoidance of hearing ill-omened words, or a symbol of the soul hidden by the body.¹² The Greeks, on the other hand, sacrificed with the head uncovered (*aperto capite*), and this was followed when the sacrifice at Rome was performed according to the Greek rite. There were also exceptions, as when the praetor sacrificed with head uncovered during the rites of the *ara maxima* and the *aedes Herculis*.¹³ Muhammadans regard it as abominable to pray with the head uncovered.¹⁴ Jews also cover the head at prayer out of reverence (cf. Ex 3⁶ 'Moses hid his face, for he was afraid to look upon God'), and the mantle, or *tallith*, is placed over the head at the name of God. Among Christians the head is uncovered at prayer and in church, but women have the head covered, following St. Paul's injunction (1 Co 11⁴⁻⁵), and at certain parts of the service the priest wears a biretta, and the bishop a mitre.

(e) The veiling of the bride, which takes place among so many peoples, savage and civilized, may be traced to the idea of danger to the head, which would be regarded as greater at the time of marriage.¹⁵ The ecclesiastical rite of the veiling of virgins who dedicated themselves to the religious life ('taking the veil') was connected with the idea of a mystical marriage with Christ.¹⁶ Many in the early Church held that all unmarried women or virgins should wear a veil.¹⁷ Muhammadan women must always be veiled, as it would be immodest to let any one see the head or face, especially the former.¹⁸ Among Jews, though not now in Western countries, it was considered indecorous for a woman to be bare-headed. The custom of covering the face or head with a veil or with

¹ D. Livingstone, *Missionary Travels*, London, 1857, pp. 267, 296; Burton, *Mission to Gelele*, i. 259, ii. 341.

² O. White, *Three Years in Constantinople*, London, 1845, i. 232, ii. 239.

³ Jos. BJ ii. 15.

⁴ Herod. ii. 85; Wilkinson, iii. 445, 449, 452.

⁵ W. R. Smith², 413; F. Schwally, *Das Leben nach dem Tode*, Giessen, 1892, p. 15.

⁶ Seligmann, 129.

⁷ ARW xii. [1909] 133.

⁸ *de Orig. actibusque Gstarum*, xi.

⁹ Grimm, 32, 91.

¹⁰ Arnob. iii. 43.

¹¹ *Aen.* iii. 405.

¹² *Quaest. Rom.* x.

¹³ Fowler, 194.

¹⁴ Hughes, *DI*, 170.

¹⁵ Cf. A. E. Crawley, *Mystic Rose*, London, 1902, p. 323 ff.; *FL* ix. [1898] 125.

¹⁶ L. Duchesne, *Christian Worship*⁴, London, 1912, p. 433 f.

¹⁷ Cf. Tertullian, *de Velandis Virg.*

¹⁸ Lane, *Mod. Egyptians*, London, 1846, pp. 76, 233; *FL* xii. [1901] 277.

the mantle on occasion existed among the early Hebrews, with the same idea of indecorum (Gn 24⁶⁵). The same rule has been followed in the Christian Church with regard to women since the earliest times, but it is dishonouring to his head for a man to pray covered, according to St. Paul (1 Co 11⁴⁻⁵). On the other hand, uncovering the head is often regarded as a token of respect, whether to divinities or superiors, just as it is an act of etiquette in the modern world.¹ It is not easy to reconcile this with the former practice, unless the idea was that of exposing a part regarded as sacred before those who were sacred or superior.

Van Gennepe (p. 240) regards covering the head as an act of separation from what is profane. This is undoubtedly one aspect of the custom, emphasized, e.g., in the Church ritual of marriage, where, at the benediction of the pair, a veil is held over their heads.² Covering the head is also an occasional token of grief, or mourning.³ In some instances wreaths, chaplets, and crowns are worn as protectives of the head from evil influences. See art. CROWN, vol. iv. p. 338^a.

(f) Distinctive marks are often made on the forehead by branding or painting, or they are symbolically signed with the hand. In India such marks are painted on the forehead; and, according to their form, they denote the sect to which a man belongs—Saivites have a horizontal and Vaisnavites a vertical sign.⁴ Among the Buddhists of Eastern Tibet, Lamas pass through an ordeal of initiation in which six marks are seared in their crown with an iron lamp.⁵ A similar custom must have existed among the Semites, for in Ezk 9⁴⁻⁶ there is reference to a sacred sign, the *Tau*, placed on the foreheads of those who had not given themselves over to pagan cults, and who would thus be saved from slaughter in the day of destruction. Similarly in the Apocalypse the worshippers of the beast have his mark on their foreheads (or their hands), and they are doomed to drink of the wrath of the wine of God (Rev 13¹⁶ 14⁹⁻¹⁰; cf. 20⁴). On the other hand, the servants of God are 'sealed in their foreheads' with the names of the Lamb and His Father (7³ 14¹). In the *Psalms of Solomon* 'the mark of the Lord is on the righteous to their salvation'—probably on their foreheads, since 'the mark of destruction' is placed thereon (15⁸ 10⁸).⁶ Hebrew prophets apparently bore some distinctive mark on the face or hand (see 1 K 20⁴¹). In Christian baptism, from comparatively early times, the candidates were signed with the Cross on their foreheads at various stages of the service, e.g. in connexion with exorcism, and at confirmation the same sign was made with the thumb dipped in the consecrated oil.⁷ The whole conception of baptism as supplying a 'seal' or mark by which the faithful were known to God—baptism conferring a spiritual character—is connected with these ideas of an actual mark made on the forehead, as is obvious from the language used regarding it in early writings (see *ERE* ii. 385^b, 393^a). In signing oneself with the protective sign of the Cross, sometimes called 'sealing,' it was usually traced on the forehead.⁸ Many passages in the Apocryphal Acts show that by this invisible 'seal' demons were repelled. But a later method was to make the sign by touching first the forehead, then the region of the heart, the left, and afterwards the right shoulder. In Christian usage the symbolic marking took the place of actual marking or branding. Such marks were, however, still made by some Gnostic sects—e.g. the Carpocratians (branding or marking on the lobe of

¹ Cf. Spencer, *Cer. Inst.*, 130.

² Duchesne, 429 ff.

³ ARW xii. 131 (Indonesia); 2 S 16³⁰, Jer 14³, Est 6¹².

⁴ Hopkins, 501.

⁵ Waddell, 178.

⁶ In the *Gospel of Nicodemus*, Christ signs all whom He rescues from Hades with the sign of the Cross on their foreheads (§ 24).

⁷ J. Bingham, *Ant. of the Chr. Church*, xi. ix. 4-6 (= *Works*, ed. B. Bingham, iv. [Oxford, 1855] 161-166); Duchesne, 299 ff.

⁸ Tert. *de Cor.* 3; *adv. Mara.* iii. 18.

the right ear)¹—and they were also used in Mithraism (branding the initiate on the forehead).² These marks secured the recognition of the initiate by the divinity.

8. Postures of the head.—Almost universally, at worship, before a sacred object, or in presence of a superior, the head is reverently bowed, or the person bends down or prostrates himself to the ground, touching it with the forehead. These postures are found among many savages and in all of the higher religions. But sometimes also the head is uplifted, the petitioner looking upwards to heaven—a posture which usually accompanies the lifting of the hands in prayer. In many semi-religious or magical rites the head is directed to be averted, as it is considered dangerous to see supernatural personages, sacred objects, and all that belongs to a supernatural plane (Gn 19^{17, 26}; *ERE* iv. 654^a).³ Various gestures of the head have definite significations among most peoples. The head is hung in shame, or raised in pride, or moved up and down or from side to side in token of assent or negation, or wagged in token of contempt (La 2¹⁸, Mt 27³⁰), etc. As a sign of their complete subjection a conqueror placed his foot on the head of his enemies (Ps 110¹, 1 Co 15²⁵).⁴ Hence among savages it is often a sign of respectful submission to place a superior's foot on one's neck or head.⁵

9. Of all parts of the body the skull tends to exhibit the largest proportion of clearly defined variations. As related to the brain as well as to the organs of mastication, and because of its differences in dimensions and in form, it affords an excellent index of racial affinities. Hence the science of craniology, the measurements and characteristics of the skull, has thrown great light not only upon the races of pre-historic times as revealed by their remains, and their relation to existing races, but also upon the affinities of present-day peoples⁶ (see ANTHROPOLOGY).

10. Deformation of the head in various ways, of which four principal types are distinguished, is practised by many peoples. The infant's head is submitted to the continued application of boards, bandages, stiff caps, and the like, until the deformation is finally attained. This practice is common among American Indian tribes, in the South Sea Islands, in Asia Minor, and sporadically in Europe, e.g. the 'Toulousaine' head of different parts of France.⁷

LITERATURE.—This is given in the footnotes.

J. A. MACCULLOCH.

HEAD-DRESS.—See CROWN.

HEAD-HUNTING.—See AUSTRALASIA, HEAD.

HEALING.—See DISEASE AND MEDICINE.

HEALTH AND GODS OF HEALING (Greek).—I. THE RELATIONS BETWEEN SACRED AND PROFANE MEDICINE IN ANTIQUITY.—As long as religion maintains an inherent connexion with the entire intellectual development of the age, so long does medicine continue to bear the impress of the religious factor. In the absence of the occult element from the surgical practice of the *Iliad*, we shall therefore hardly venture, with Gomperz (*Gr.*

¹ Iren. i. 25. 6.

² Tert. *Præscr.* 40.

³ Cf. Grimm, 493, 1295; Homer, *Odyssey*, v. 350.

⁴ Wilkinson, iii. 403; Frazer, *Adonis*, 52 (Hittite).

⁵ M. Laird and R. A. K. Oldfield, *Exped. into Interior of Africa*, London, 1837, i. 192; J. R. Forster, *Observations during a Voyage round the World*, do. 1777, p. 361 (Tonga).

⁶ J. Deniker, *Races of Man*, London, 1900, p. 53 ff.; G. Sergi, *The Mediterranean Race*, do. 1901.

⁷ See P. Topinard, *Éléments d'anthropologie*, Paris, 1885, p. 744; A. Hrdlicka, in Hodge, *HAI*, Washington, 1907 [30 *Bull. BE*], pt. I, s.v. 'Artificial Head Deformation'; *NR* I and II, *passim*; Turner, *Samoa*, 80.

Denker, i. 224 [Leipzig, 1896]), to decry a 'morning-blush of the Illumination.' For one thing, the significance of that absence is discounted by the fact that in the *Odyssey*, a product of the same stage of culture as the *Iliad*, the magic word is employed in the treatment of wounds (*Od.* xix. 457); and for another, the surgical art, just because the injuries it deals with are patent to the eye, and may be healed by the skilled hand, occupied a distinct position within the sphere of medicine. This is seen even in the legal enactments of ancient Babylonia, in which the healer of wounds is put alongside of the veterinary surgeon, the architect, and other artisans, while internal medicine is not mentioned at all (see below). The absence of exorcism from the surgical practice of the *Iliad* could be regarded as a symptom of the Ionic 'spirit of light' only if that epic, in its references to disease, made no mention of magic remedies at all. In point of fact, however, the warriors who deal so rationally with wounds are completely at a loss when confronted with the pestilence sent by Apollo, and have recourse to supernatural means of healing—the consultation of priests, seers, and dream-readers (*Il.* i. 63), purifications, prayers, and sacrifices (442 ff.). In the *Odyssey* likewise the illness of individuals is regarded as sent by the gods (v. 396, ix. 411), and from the gods alone is the remedy to be procured (v. 397). The prevalence of theurgic medicine in the Homeric age must thus be recognized as a fact beyond question.

Then the ever-recurring employment of religious expedients against the onset of epidemics in later times, and the vogue enjoyed for centuries by temples of healing, show us how long the power of magic held its ground in the sphere of therapeutics. It is also a significant fact that Pindar, when enumerating the subjects which Asklepios learned from Cheiron (see below, *Il. A.* 6), does not shrink from co-ordinating exorcism with external and internal medicine. Even Sophocles, whose view of *επωδαί*, as expressed by Ajax (*Aj.* 582), is read by J. Hirschberg as a condemnation of them (*Gesch. d. Augenheilkunde*, Leipzig, 1905, p. 55; he might also have adduced *Trachin.* 1001), was actually the priest of the healing hero Amaryn (II. B. 11), and, as such, successfully strove to secure the naturalization of Asklepios, the bestower of dream-oracles, in Athens.

A very different problem is raised when we ask whether the predominance of the supranaturalistic element did not act as an obstacle to practical progress in religious medicine, or whether genuine medical knowledge might not develop even under such conditions. In order to answer this question, we must turn to the two civilized peoples who practised the healing art prior to the Greeks.

(a) To the *Babylonians* a science of medicine free from the occult was always a thing unknown. At the first glance, indeed, it might seem as if at a remote period popular beliefs were assailed as mere superstition by certain outstanding rulers, but on a closer inspection this view proves to be fallacious. The ancient Sumerian *patesi* (city-king) of Lagash, Gudea, whose reign is now dated c. 2450 (A. Ungnad) or 2350 B.C. (E. Meyer), certainly says, in his report about the building of the temple of Ningirsu, that he has 'expelled the dreadful sorcerers, the [what follows is unintelligible] . . . from the city' (Statue B 3, 15 ff., as in Thureau-Dangin, *Die sumer. u. akkad. Königsinschr.*, Leipzig, 1907, p. 69; cf. Cylinder A, 13 f., p. 103). But to speak of him as on that account the earliest champion of civilization in history (J. Jeremias, *Moses u. Hammurabi*, Leipzig, 1903, p. 40, n. 3) is a misapprehension. Gudea was, in fact, anything but a rationalist. The inscriptions of his statues and cylinders record little else than his exertions in

connexion with the temples of the gods, and reveal him as a true priest-king. For the building of the aforesaid temple of Ningirsu, he asks that goddess for a special revelation (cf. his dream, on Cyl. A, 27 ff., Thureau-Dangin, p. 91 ff.), while for his administrative proceedings he resorts to omens of various kinds, as also, according to Jastrow (*Die Religion der Bab. u. Assyr.*, Giessen, 1902-05, ii. 273), to hepatoscopy. When a ruler of this type makes war upon sorcerers, it will hardly be in the interests of enlightenment.

The same holds good of Hammurabi of Babylon, who reigned some centuries later. By § 2 of his code of laws, a charge of having practised sorcery is to be submitted to a divine ordeal which involves the death of either the accuser or the accused (cf. Ungnad's tr. in Gressmann, *Altorient. Texte*, Tübingen, 1909, p. 143). Here again Jeremias recognizes the measures of an enlightened monarch against the superstitions of his day. But, while religion has indeed no place in the legislation itself, it is certainly prominent enough in the epilogue, where the king calls upon the gods to chastise the transgressors with various calamities, such as serious illness, evil Ashakku (the demon of consumption or fever), painful injury, *the nature of which is unknown to the doctor*, and which he cannot relieve with bandages. In §§ 215-221 the code applies the strictest provisions of the *jus talionis* to the doctor; but here the doctor is in reality the surgeon, and is not concerned with internal diseases, which, according to Hammurabi's ideas, are induced by demons, and can be combated only by religious means. Contemporary inscriptions show that by the time of Hammurabi the divining priests (*bārū*) had been formed into an organized gild; and this was presumably the case also with the exorcizing priests (*ashipu*), whose function it was to dislodge the demons of disease (cf. Weber, 'Dämonenbeschwörung bei d. Bab. u. Assyr.', in *Der alte Orient*, vii. [1905] 4, pp. 5 and 7).¹

Thus, as sorcery and exorcism were recognized elements in the official religion of Mesopotamia, the repressive measures of Gudea and Hammurabi could apply only to those illegal practices by which persons endowed with occult powers—sorcerers and witches—caused injury to others, and against which the priesthood in its official capacity fought with magic devices of its own (as found in the 'Maklu' inscriptions). What the priests thus did by magic, the two monarchs sought to do by law, and, accordingly, the object of their attack is not superstition as such, but what was known in the Middle Ages as 'black magic.' Hence, as the belief that disease was caused by demons was an essential feature of Babylonian religion, Babylonian therapeutics must also have borne a supernaturalistic character.

(b) The Egyptians, even by the period of the *Odyssey* (iv. 227 ff.), had carried the fame of their medical proficiency beyond the confines of their own country; and this fame is justified by the relevant portions of their extant literature. It would seem, however, as if an error had recently crept into the critical investigation of this literature. Thus, from the fact that two documents of the Middle Empire—fragments respectively of a gynæcological and a veterinary papyrus, and both from Kahun—deal only with symptoms, diagnosis, and therapeutics (F. v. Oefele, in Neuburger-Pagel, *Gesch. d. Medicin*, i. [Jena, 1901] 75), while

¹ A parallel to Gudea and Hammurabi in this respect may be found in Saul, king of Israel, who, in conformity with Ex 22¹⁸ and Lv 19³¹, expelled wizards and diviners from the country, but in his own hour of need sought counsel of the forbidden craft (the witch of En-dor, 1 S 28⁷; cf. v. 3). Divination, however, was forbidden among the Israelites, not as a harmful superstition, but as a Canaanite practice (cf. E. Meyer, *Gesch. d. Altertums*, Stuttgart, 1884-1901, I. § 313).

the Ebers Papyrus, compiled from older writings during the XVIIIth dynasty, and its nearly contemporary counterpart, the Hearst Medical Papyrus (ed. Reisner, 1905), frequently supplement the medical recipes by magic formulæ, von Oefele (*Der alte Orient*, iv. [1902] 2, p. 25) and H. Schneider (*Kultur u. Denken d. alten Aegypter*, Leipzig, 1907, p. 317 ff.) infer that Egyptian medicine was at first purely empirical, and resorted to magic only in the period of the New Empire and under Babylonian influence. But is this not too bold a conclusion to draw from such scanty data? The gynæcological text in question consists of only three columns, while the Ebers Papyrus comprises one hundred and ten pages; in the latter, moreover, the incantations are met with sporadically, and large portions of the text have none at all. Thus the absence of incantations from the Kahun fragment may be merely fortuitous. In a word, that a people with so intense a belief in the supernatural as the Egyptians—a people whose cult of the dead was completely permeated by magic even in the Ancient Empire—cultivated a purely rational medicine the present writer finds it impossible to believe.

We turn now to the question how far those two civilized peoples of antiquity, with their marked leaning towards the occult, succeeded in making progress in the science and art of healing. Modern writers on medicine have shown that the Egyptian doctrine of the vessels (*metu*) was a real contribution to science, and that the Egyptian pharmacy furnishes materials of considerable value. But the Babylonian medicine likewise, debased by the ritual of exorcism and dependent upon oracles though it was, recognizes, as has been shown by F. Kuchler in his valuable *Beiträge zur Kenntnis d. assyr.-bab. Medizin* (Leipzig, 1904), the use of rational remedies, employs the injection (Kuchler, p. 39, l. 44) and the cataplasm (*ib.* 39, 36, etc.), and gives directions as to diet (*ib.* 7, 30, 69); and, according to Oefele (in Kuchler, p. 65), the squatting position it prescribes for colic (*ib.* 3, 11, 13) does in reality afford great relief.

Alike in the Nile valley and in Mesopotamia, therefore, the healing art was a combination of the occult and the rational, and this peculiar system of medicine exercised an influence upon the Greeks at a very early period. The Egyptian doctrine of *metu* survives in the Greek theory of 'humours' (Schneider, *op. cit.* 325), the Egyptian pharmacy in that of Greece; and a striking illustration of such survival is found in the fact that, as demonstrated by Le Page Renouf (*ZÄ xi.* [1873] 123), the diagnosis of pregnancy in the 'Hippocratic' treatise *περὶ ἀφῶρων*—probably written by a Cnidian—is identical with that found in the Brugsch Papyrus. How this Egyptian diagnosis made its way to the Cnicians may be explained by the fact that, according to Diogenes Laertius (viii. 87), the Cnidian mathematician and physician Eudoxos spent fifteen months with the medical priests of Heliopolis in the reign of Nektanebos (382-364 B.C.); and Eudoxos would certainly not be the first of the Greeks to avail himself of such an experience. The avenues by which Babylonian medicine reached the Greeks have not yet been definitely ascertained; but the present writer is convinced that the practice of *incubation*, i.e. sleeping in a temple as a means of healing, which is of great importance in the religious medicine of the Greeks, was an importation from Babylonia. H. Magnus (*Abh. zur Gesch. d. Medicin*, i. [Breslau, 1902] 6 ff.) maintains, it is true, that incubation was common in Egypt from the earliest times; but the present writer has never succeeded in finding any mention of it in ancient Egyptian sources. In all probability, the practice was introduced into Egypt through the medium of the Sarapis worship

founded by Ptolemy I., and was shortly thereafter transferred to the cult of Isis. Sarapis—the subject of much discussion—is, however, as C. F. Lehmann-Haupt has shown (II. A. 18), simply the god Ea of Eridu under his customary by-name of *sar apsi* ('king of the watery deep'), the supreme healing god of the Babylonians (Jastrow, *op. cit.* i. 294 ff.). In the sanctuary of Ea at Babylon—the edifice which Greek sources call *Σαραπειον*—the rite of incubation was performed on behalf of the dying Alexander by several of his generals. The theory that Mesopotamia was the cradle of incubation is warranted also by the fact that in that region dream-oracles were sought after for all emergencies, and especially for disease (Jastrow, i. 367 ff.), from the earliest times. Unfortunately, we have as yet no work dealing with the ritual prescribed; and this is all the more to be regretted in view of the important rôle played by *dream-reading*. Jastrow's work has so far only reached the discussion of the oil-oracle; the still unpublished matter relating to dream-oracles for healing purposes is noted in Bezold's Catalogue of the Kouyunjik Collection, v. (1899) nos. 2140 ('omens, including medical prescriptions') and 2143 ('omens derived from events which seem to occur in dreams'). That incubation among the Babylonians and Assyrians was an institution with well-defined rites is shown by an incidental reference in the annals of Assurbanipal (ed. Jensen, *KIB* ii. [1890] 187), where a dreamer is said to have lain down towards the end of the night, in order to obtain an oracle on the king's behalf (cf. *ib.* 201). The Greek practice of incubation, however, also exhibits the two features here indicated, viz. *incubation on behalf of another* (cf. II. A. 15 and 17, below), and the *preference for a time towards morning*—'as the soul is then free from the effects of material sustenance' (Philostr. *Vita Apollon.* ii. 36; cf. Artemidor. i. 7). Plutarch (*Septem sap. conv.* 15) tells us that incubation was an ancient Greek practice, and the reference of the *Iliad* (xvi. 235) to the Dodonian Selloi, the *ὑποφῆραι χαμαϊεύσαι* of Zeus, may be regarded as the earliest witness to it (so Welcker, *Kleine Schriften*, iii. [1850] 90, and Dümmler, *Philol.* lvi. [1897] 6). The naturalization of a Bab. practice in Greece at so early a period is not inconceivable, as another passage of the *Iliad* (xiv. 201, 246), in its striking representation of Okeanos and Tethys as primitive forces (cf. the early Orphic theogony, in Plat. *Cratyl.* 402 B), shows dependence on Bab. cosmogony (P. Jensen, *Kosmologie der Babylonier*, Strassburg, 1890, p. 244). Incubation would seem to have reached the Greeks by way of Lydia; thus, in Assurbanipal's annals (*KIB* ii. 173), a dream vouchsafed by the god Assur to Gyges is mentioned (cf. Jensen, in Thrämer, *Pergamos*, Leipzig, 1888, p. 413), while in the valley of the Mæander there were several incubation-shrines of the subterranean gods, one of them being the Plutonion, near Nysa, the ceremonies of which were a reflexion of the Bab. practice (II. A. 17, below). Mention should also be made of the curious affinity between the Bab. haruspicy (Jastrow, ii. 213 ff.) and the Etruscan—a correspondence dealt with most recently by G. Körte (*Röm. Mitt.* xx. [1905] 348 ff.) in connexion with the bronze liver of Piacenza (see *ETRUSCAN RELIGION*, vol. v. pp. 533, 537). Here, again, we learn that we are but beginning to realize the remarkable religious influences which streamed from Mesopotamia to the West.

If the religious medicine of the older civilized peoples thus made its influence felt among the Greeks, the question arises whether its further development, after its settlement upon Greek soil, was essentially upon the same lines as before, i.e. whether the fusion of religion and medical em-

piricism can be traced also in the therapeutic practice of the Greek sanctuaries. While this, notwithstanding the ridicule poured upon incubation-shrines by Aristophanes in the *Ploutos*, and obviously also in the *Amphiaraos*, might have been confidently taken for granted until lately, the discovery of the Epidaurian stelæ recording the miraculous cures (*ἰάματα*) of Asklepios (as redacted about the end of the 4th cent. B.C.) has brought about a defection from this view, and the majority of modern investigators stigmatize these sanctuaries as hives of priestly chicanery and senile superstition. The latest discussion of the question (S. Herrlich, 'Antike Wunderkuren,' in *Progr. des Humboldt-Gymnas. zu Berlin*, 1911) comes eventually to the same negative result. The present writer, however, after renewed consideration of the subject, cannot but adhere, in essentials, to the earlier standpoint, as set forth in Pauly-Wissowa, ii. 1636 ff.

Arguing from the difference between the contents of the Epidaurian *iamata*-stelæ and the condition of medical practice in the Imperial period, P. Kavvadias (in his *Fouilles d'Épidaure*, Athens, 1893, p. 115, in the *Ἱερὸν τοῦ Ἀσκληπιοῦ*, 1900, p. 267 ff., in the *Mélanges Perrot*, 1902, p. 42, and, finally, at the Archæological Congress in Athens, *Comptes Rendus*, 1905, p. 278 ff.) has come to the conclusion that in the Greek period the curative procedure of the Asklepieia consisted entirely of miraculous acts of the god, after the style of the *iamata*, while in the Roman period, in consequence of the institution of dream-shrines, and the therapeutic methods based thereon, it received an infusion of rationality. But the inference is by no means beyond dispute. To begin with, it would be strange indeed that the Asklepieia of the most flourishing period of the Greek world should successfully resist the intrusion of rational procedure, while, in a period of growing superstition and craving for the miraculous, they should open their doors to natural remedies.¹ Kavvadias bases his theory on the Epidaurian *iamata*, but exaggerates their importance. In Pauly-Wissowa (*loc. cit.*) the present writer had pointed out that the *iamata*—according to which, e.g., persons with a vacant eye-socket incubate, and leave the shrine with a seeing eye—are not historical documents, but merely a compilation for the gratification of credulous minds, and that none of the individuals said to have been cured by the god can be historically traced. Wilhelm (*Jahrb. d. österr. archäol. Instit.* iii. [1900] 40) has certainly sought to identify Arybas, an Epirot named in stele ii. no. 31, with a Molossian chief of the period in which the *iamata* were redacted, but in that case this particular *iamata* would be severed from the group as a whole. The Greeks had, in point of fact, a great store of legends about the cures and resuscitations of Asklepios in the mythical age (cf. Pauly-Wissowa, ii. 1653 f.), and one of these miracles—the raising of Hippolytus to life—was extolled upon a stele bearing an epigram in the Epidaurian *hieron* (Paus. ii. 27. 4). Our redaction of the *iamata*, then, really preserves the substance of these tales of the marvellous in a pseudo-historical form, its object being to convince the credulous that the immediate miraculous action of the god had not ceased with the mythical age. A frequently recurring feature of the *iamata* is the statement that, when the sleeper awoke, his dream was found to have been already fulfilled; and here again the record follows a mythical pattern, as seen in Bellerophon's dream (Pindar, *Olymp.* xiii. 56). If, accordingly, the

¹ This argument is advanced in opposition to Kavvadias also by S. Herrlich (*loc. cit.* 33), though only by way of supporting the contention that the occult element maintained its ascendancy also in the Roman period; otherwise Welcker, *Kleine Schr.* iii. 75.

Epidaurian *iamata* belong to the class of miraculous stories designed for edification, such as are met with in all religions, we cannot regard them as documents drawn up from the actual practice of the Asklepieia.¹

The hypothesis of Kavvadias ignores the *mantic* aspect of incubation; and so O. Rubensohn (*Festschr. für Vahlen*, Berlin, 1900, p. 13) takes the further step of asserting that in the Greek period the cult of Asklepios was not concerned with dream-oracles, but that these were introduced at first by the Sarapis-Isis cult. In point of fact, however, *ἐγκομιμαί* was known to the Greeks long before the worship of Sarapis reached them, and was based precisely on the prophetic significance of dreams (see below, II. A. II, 14, 15, 17-20; and above, the reference to the Dodonian Selloi; cf. II. B. 1 and 8). A distinction was made between *δνειροι θεῖοι* (or *θεόπνευτοι*), 'divine oracles given in dreams,' and *δνειροι φυσικολ*, 'oracles of the soul itself in dreaming.' The author of the *περὶ διατρῆς* in the *Corpus Hippokr.*, probably a Cnidian physician, believes in both kinds, but does not treat of the former class (ch. 87 [vi. 540, Littré]), as these had already been dealt with by experts,² confining himself to the 'natural' class, in which the soul reveals what will benefit the body. Both kinds of dreams are recognized by the post-Hippocratic physician Herophilos, the anatomist (Plut. *de Placit. Philos.* v. 2). Even Democritus believed in demons who reveal themselves to the dreamer in forms (*εἰδῶλα*) emanating from themselves (Plut. *ib.*; Sext. *Empir.*, *adv. Math.* 394), and Aristotle acknowledged the mantic efficacy of 'natural' dreams (*περὶ τῆς καθ' ὄπνον μαντικῆς*, p. 462 ff.), while the Stoics, again, regarded dreams of healing as manifestations of divine providence. In view of such favourable recognition on the part of physicians and philosophers, it was, of course, incumbent upon the official directors of the practice of incubation to do all they could to ascertain the divine will as indicated in the dreams. Everything turned, therefore, on the correct interpretation. The special literature of the subject formulates two classes of revelations (Artemid. i. 2): (1) *δνειροι θεωρηματικοί*, 'dreams to be followed literally'—even there, however, interpretation had to be resorted to whenever the literal application of the prescription threatened the patient's life³—and (2) *δνειροι ἀλληγορικοί*, 'dreams which indicate the remedy indirectly.' As regards the latter, Artemidorus (iv. 22) deprecates all perversity of interpretation, and asserts that the *συνταγαί* of the gods, when given in enigmatic form, are nevertheless quite clear; thus the dream of a lamb sucking the breast of an invalid signifies an application of *ἀρνόβλωσσον*. Preposterous interpretations were a characteristic feature of the Imperial period—*e.g.* a vision of the Athene Parthenos of Phidias was fantastically interpreted as signifying the application of an injection of Attic honey (Aristid. ii. 403 [Keil]).

Again, *interpretation of dreams* and a therapeutical practice founded thereon are met with—to leave Asklepios out of account meanwhile—in the Plutonion near Nysa (II. A. 17, below), in the Dionysian dream-shrine at Amphikleia (15), in the cult of the Dioskouroi at Byzantium (14), and in the Amphiareion at Oropos (19). Now, it is quite impossible to understand why incubation, the characteristic feature of which, from its

¹ A very significant circumstance is that the supposed original votive inscription belonging to stele i. no. 15 (Hermodikos) proves to be a fabrication in a pseudo-archaic script.

² The sources used by Artemidorus are of much later date than the special literature indicated here, which, unfortunately, has not survived.

³ As, *e.g.*, the prescribed bleeding to the amount of 120 pounds (Aristides, ii. 405 [Keil]).

earliest infancy in Babylonia, was always the dream-oracle, should retain its character among the Greeks generally, and yet in particular should degenerate in the Asklepieia into a mere ornamental adjunct. Those who, in view of the Epidaurian *iamata*, accept the theory of Kavvadias overlook the fact that we have positive testimony to the dream-oracles of Asklepios during the Greek period, viz. in the *περὶ θεῶν* of Apollodorus, who in that work speaks of the god as 'praeses divinationum et auguriorum' (Macrob. *Sat.* i. 20). Apollodorus must therefore have known of the *συνταγαί* given by Asklepios in dreams, and thus also of remedies applied in accordance with them. Nor are traces of this combination wanting elsewhere. In Aelian, frag. 100 (Suid. *s.v.* Παύσων) the god, *ἐπιστάς* (the technical term for appearing in a dream; cf. Deubner, *de Incubatione*, Leipzig, 1900, p. 11), is said to have prescribed a salve of swine's fat and vinegar for diseased eyes, and the anapaestic measure of the words shows, as Pritzsche (on *Thesmoph.* 949) has noted, that they are taken from a comedy. The three-months' course of healing undergone by Aeschines the rhetor, in Epidaurus (*Anthol. Gr.* iv. 330), might be appositely cited as additional evidence, if we were certain that the patient was Aeschines the Eleusinian (cf. Pauly-Wissowa, ii. 1688); the fact that the epigram speaks of him as an Athenian forbids us, at all events, to identify him with Aeschines the Milesian, a contemporary of Pompey. Finally, an indirect testimony to the curative operations of the Asklepieia is furnished by a current tradition which is rejected solely on account of the foolish assertion with which it concludes, but which contains the quite defensible statement that the profane medicine of the Greeks was derived from their religious medicine, and, above all, from that of Asklepios. Artemidorus (iv. 22) states that many persons in Pergamos (Asklepieion), Alexandria (Serapeion), and elsewhere were treated according to prescriptions given in dreams: *εἰσι δὲ οἱ καὶ τὴν ἰατρικὴν ἐκ τοιούτων συνταγῶν λέγουσι εὐρῆσθαι*. Similarly, Iamblichus (*de Myst.* iii. 3) says that the healing art had its origin in the *θεῖοι δνειροι* of Asklepios. What is here affirmed of profane medicine in general is referred to by Strabo (xiv., of which Apollodorus is the principal source) as a current tradition regarding Hippokrates in particular: *φασὶ δὲ Ἰπποκράτην μάλιστα ἐκ τῶν ἐνταῦθα [in the Coan Asklepieion] ἀνακειμένων θεραπειῶν γυμνάσασθαι τὰ περὶ τὰς διατὰς* (p. 657. 19). But, if the medical praxis of the Coan temple embraced such miraculous proceedings as are found in the Epidaurian *iamata*, no sober-minded man could have regarded them as providing instruction for scientific medicine. We must accordingly assume that records of the medical procedure of temples were preserved in the Asklepieion of Cos, and that these provided a footing for the current opinion regarding Hippokrates. That opinion was first brought into discredit by the allegation—not found in Strabo's source—that the great Coan physician was an incendiary.

It is singular that Hippokrates, the supreme genius of ancient medicine, has left so few positive traces of his personality. For his descent from the Coan Asklepiadae, and for his rapid advance to renown, we have the explicit testimony of his younger contemporary, Plato (*Prot.* 311 B, *Phædr.* 270 C), but, as Fredrich (*Hippokratische Untersuchungen*, Berlin, 1899, p. 1) says, 'he was for Aristotle already an almost mythical personality.' The *Corpus Hippokr.* contains over seventy treatises, but none of them can be with absolute confidence ascribed to the master, while many are not even products of his school. The *Vita* compiled from Soranos and other sources (A.

Westermann, *Biographi Gr.*, Brunswick, 1845, p. 450) is a blend of fact and fancy. His birthday is attested by a reliable source—a Coan archive; while we may probably rely also upon the statement that, on the completion of his early studies, he was induced by the death of his parents to migrate to Thessaly, that he lived at Larissa, and eventually died and was buried there (cf. *Anth. Gr.* vii. 55). The name of his eldest son, Thessalos, likewise points to that country, as it is not met with in any previous generation of the Asklepiadæ. There is nothing to show that he ever returned to his native place, and Herzog's untiring researches in Cos have not yielded a single fact regarding him. It would thus seem certain that he left the island for ever at an early age. The ancients of a later day were manifestly at a loss to account for this. The *Vita* gives three distinct reasons, viz. (1) an injunction intimated in a dream (Soranos); (2) his desire to widen the horizon of his medical knowledge; and (3) his being accused of burning the Cnidian library (so Andreas, perhaps physician in ordinary to Ptolemy IV., whom Galen [xi. 795, Kühn] stigmatizes as a wind-bag). The charge implied in the last-mentioned explanation is attributed by S. Reinach (art. 'Medicus,' in Daremberg-Saglio, 1670) to the jealousy of the priests of Asklepios, but erroneously, as the relations between these and the Asklepiadæ (on which cf. Lefort, *Mus. belge de philol.* ix. [1905] 197 ff.) were always of a friendly character. The accusation could have arisen only from the antagonism between the Cnidian and the Coan schools of medicine, as it was in reality meant to brand the head of the latter as a plagiarist who availed himself of the professional literature of the former—a point which Tzetzes obliterates by transferring the burning to the Coan library, though he too makes it a question of non-religious medical literature (ἐν Κῶ βιβλιοφύλαξ δειχθεὶς τὰ παλαιὰ τῶν ἰατρῶν ἐνέπρησε βιβλία καὶ τὸ βιβλιοφυλάκιον). The statement of Andreas makes no mention whatever of the votive tablets of an Asklepieion; the earliest suggestion of these occurs in Varro, according to whom (*ap. Plin.* xxix. 4) Hippokrates first copied the records of cures deposited in the Coan sanctuary by those restored to health, and then burned the temple. This is obviously nothing but an abortive attempt to interweave the anti-Coan version of Andreas with the view of the origin of scientific medicine just noted. That the latter hypothesis, however, was not put forward wholly at a venture, but might find some support in a genuine practice of healing in the Asklepieia, is shown by the testimony of Apollodoros to the mantic functions of Asklepios, and the recipe prescribed by the god in the fragment of a comedy in Aelian, fr. 100 (above, p. 543^b). The present writer would add a reference to an Athenian votive relief of the 4th cent. B.C. published by Ziehen (*Ath. Mitt.* xvii. [1892] 232, fig. 3), representing a patient stretched upon a κλίνη, and a surgeon engaged in treating him, while Asklepios, figured on a much larger scale than either, stands passively by (in the statuary type in Roscher, i. 634, schema i.). Here, then, we have monumental evidence of the fact that the personnel of the temple engaged in therapeutic practice under the sanction of the god.

It is thus impossible to deny that genuine medical treatment—directed, it is true, by oracles of healing—was practised in the Asklepieia of the Greek age. As regards the therapeutic value of such treatment, we are not able meanwhile to judge, for investigation of the Greek period has so far yielded no original votive tablets dedicated by restored patients and containing records of the prescribed remedies, such as are supplied for the Roman period in the pathological narratives of P. Granus (Lebene) and Jul. Apellas (Epidauros), but it is at

least an allowable hypothesis that the curative methods of the earlier age, in keeping with the higher state of its medical knowledge and the less debased character of its religion, were superior to those of the later. The prestige of dream-shrines would then be at its height, while practical medicine still maintained a close connexion with the occult, as in the Cnidian medical school (cf. Gomperz, *Gr. Denker*, i. 250), and probably even more in that of Rhodes—the first to become extinct (Galen, x. 5 [Kühn]). The (Cnidian) author of the *περὶ διαίτης* (iv. [περὶ ἐνυπνίων] ch. 87) lays down the following principle: 'Prayer is certainly very good, but one who calls upon the gods must himself also do his part' (δεῖ δὲ καὶ αὐτὸν ξυλλαμβάνοντα τοὺς θεοὺς ἐπικαλέσθαι). Some of his interpretations of dreams are such as we might ascribe to an Asklepiian priest, as, e.g., ch. 88 (abbreviated): 'If in a dream one fights in opposition to the doings of the day, it signifies some bodily disaster, and this is to be counteracted by emetics, dieting, bodily movements, exerting the voice, and [last, though not least] by prayer.' We seldom meet with the case where the priestly function is discharged by a physician. Three instances are given in Pauly-Wissowa, ii. 1685; a fourth is probably to be found in Kalliphon, the father of Demokedes; he was a priest of Asklepios in Cnidus (Suid. s.v. Δημοκῆδης), and, as the healing art was then hereditary in families, probably also, like his son, a physician. But we cannot say whether the priestly office as such embraced the vocation of interpreting dreams. In the Plutonion near Nysa dream-reading was the function of the ἐμπειροὶ τῶν ἰερέων (below, II. A. 17), and we may doubtless assume that persons specially versed in this art were to be found in all dream-shrines. It was only natural that these adepts should have tried to discover a practical meaning in the dreams vouchsafed by their god. And in finding these meanings they were in no way guilty of a 'pious fraud' (Herrlich, *op. cit.* 13), but were rather the victims of self-delusion, as, in a related sphere, were also the Delphic priests in their task of moulding the incoherent utterances of the Pythia into intelligible sentences (cf. the critical estimate of this function in Schömann, *Griech. Alterth.*⁴, Berlin, 1897, ii. 318).

The facts thus adduced seem to the present writer to justify the view that among the Greeks, as among the Babylonians and Egyptians of an earlier age, religious medicine did not dispense with rational remedies. That practical modes of treatment were associated with miracle, 'faith's favourite child,' is shown not only by the craving for marvels which ran riot in the Epidaurian *iamata*, but also by the legend narrating the founding of the Asklepieia of Naupaktos (Paus. x. 38. 13) and the Insula Tiberina (Ovid, *Metam.* xv. 660 ff., etc.). We may also suppose that, alike in the waking state and during incubation, cures were not infrequently wrought quite apart from the oracular adjunct and solely by means of suggestion, and then extolled as the miraculous works of the deity. We shall not pursue the subject further here, as we are meanwhile concerned only to follow the traces of rational therapeutics within the sphere of religious medicine. From the former alone is there any real passage to the altogether rational conception of *Hygieia* in the Asklepiian cult, with regard to whom the reader is referred to the section dealing with 'Asklepios' in II. A. 20, ii. (2) below. Her radiant figure appears as something out of keeping with the mystical and, in essence, non-Hellenic dusk that surrounds the practice of incubation.

II. HEALING GODS AND HEROES.¹—A. GODS.—

¹ The following list touches only incidentally on the deities of childbirth.

The belief in gods implies also belief in their sway over health and disease; and, accordingly, in all manner of troubles, but especially in the case of loss of health, appeal is made for divine help. Originally, however, there existed no belief in special deities of healing. In *Od.* v. 397 the reference is quite general: 'the gods loosed him graciously from his trouble.' Every deity could properly exercise this power, so far at least as he was thought of as a deliverer, or as a protector against evil; though epithets like *σωτήρ*, *ἀλεξικακός*, etc., are not to be interpreted off-hand in a medical sense, for, as will appear from the following synopsis, they have usually quite a different meaning and reference. It may, in general, be taken for granted that at the outset the sufferer appealed simply to his family or tribal deity. It might seem to have been the most natural course to regard Apollo, the ancient god of pestilence, as a healing deity in the specific sense, but, in consequence of his extensive range of action, this did not take place—a circumstance due in part to the early incorporation of Asklepios in the Apolline group. The gods associated with incubation have a special affinity for the medical sphere (see 14, 15, 17-20 below), doubtless because of the mantic significance generally ascribed to dreams. Here also, however, other and for us mostly untraceable factors have operated towards specialization. Thus, e.g., Trophonios was never more than an oracle-deity in a general sense, while Amphiaraos, for reasons which we cannot discover, became, more specifically, a giver of healing oracles. In the case of Asklepios, the Gr. god of healing *κατ' ἐξοχήν*, we may probably find an explanation of his special function in his having become a son of Apollo, the god of oracles. But the contraction of his sphere of action was gradually arrested in the conflict of heathenism with the Nazarenes, and he becomes eventually the *σωτήρ τῶν θλῶν* (Aristides, Julian), and the centre of the universe (*CIL* vi. 1). Nevertheless, his principal emblem, the snake-coiled rod, remains to this day the specific symbol of medicine.

1. Zeus.—Zeus, the sovereign of the Greek pantheon, though early regarded as the sender of sickness (*Od.* ix. 411), seldom appears as a healing god. His common epithet, *Σωτήρ* (Preller-Robert, *Gr. Mythol.*⁴, Berlin, 1887-94, i. 151. 3, and O. Gruppe, in I. Müller, *Handbuch*, v. [Munich, 1897] 1108. 3), signifies the 'deliverer,' and has no traceable reference to disease—as, e.g., on the statue in the agora at Athens, dedicated to him as the 'deliverer' in the Persian troubles, and on the images with emblems of battle and victory, erected to him and Athena Soteira in the Piræus, to celebrate the restoration of Athens under Conon (H. Brunn, *Gesch. d. gr. Künstler*², Stuttgart, 1888 f., i. 270), just as the Zeus Soter and Artemis Soteira of Megalopolis signalize the achievement of Epaminondas (Paus. viii. 30. 10). The like holds good of the titles *Ἀλεξικακός*, *Ἀποτροπαῖος*, *Ἀπήμιος*, *Ἐπερδέξιος* (cf. O. Weinreich, *Antike Heilungswunder*, Giessen, 1909, p. 41), and *Ἐπήκοος* (*Ath. Mitt.* xxvii. [1912] 23). Whether the title *Παῖδρ* (in Rhodes [Hesych.]) bears a particular reference to Zeus as the queller of plague is a moot point (see below, 7). The stone on which Orestes was delivered from his madness was called *Ζεὺς κακπώτας*, i.e. *καταπαύτης* (Paus. iii. 22. 1); and we light at length upon the physician-deity in *Ζεὺς Ἐξακροστήρ* (Solon, *ap.* Pollux, viii. 142),¹ and in the *Ζεὺς Ἰψίστος* to whom were dedicated the models of limbs in the Pnyx (*CIA* iii. 150-156), and those in Melos (?) (Panofka, 'Heilgötter d. Griechen, in *ABA W*, 1843, p. 258), though we cannot definitely

¹ The *Ζεὺς Ἀευκαῖος* at Lepreum (Paus. v. 5. 5), which Gruppe, *op. cit.* 1269. 3, connects with *λεῖκη*, 'leprosy,' is ruled out by the obvious emendation *Ἀύκατος* (Curtius, *Peloponn.* ii. [1852] 117).

identify the *θεὸς ὕψιστος* to whom similar dedications were made in Cyprus (*BCH* xx. [1896] 361). The fact that Zeus was assigned a 'lot' in the altar at Oropos (19 below) brings him within the scope of such healing activities. Evidence of the existence of incubation in the primitive cult of Zeus may possibly be recognized in the Dodonian *Σελλοί* of Homer (*Il.* xvi. 235; see above, p. 542*).

2. Athena.—Athena, 'the best beloved and most congenial child of the heavenly father,' shares with him his somewhat vague relation to the healing function. Such of her epithets as some seek to interpret in a medical sense are in but few cases to the point. Thus the Zeus Soter and the Athena Soteira above referred to have to do with political matters, and the same is probably true of the oblation to these two deities and the children of Leto mentioned in Delian inscriptions (*BCH* vi. [1882] 22), as the Delians offered *soteria* also in Athens (*BCH* iv. [1880] 327). *Ἀναδὲς κοινὸς* of Athena Soteira and Poseidon near Asea (Paus. viii. 44. 4) was associated with the auspicious home-coming of Odysseus. The application of the epithet in Mytilene (*IG* ii. 111) has not been explained, nor the *Ἀθηναῖα Ἀποτροπαία* (with Zeus Apotropaῖος) in Erythræ (G. Dittenberger, *Sylloge*, Leipzig, 1883, no. 370, 70); but the Attic *Ἀθηναῖα Παιωνία* in the inner (Paus. i. 2. 4) and outer (Plut. *Decem orat.* vit. 7) Kerameikos, and at the Oropian altar as a guest (19 below), bring her within the medical sphere. The Athena Hygieia worshipped on the Akropolis even before the Persian wars is also distinctively Attic (votive inscriptions of Euphronios and Callis, *CIA* i. suppl. 362, and *Ath. Mitt.* xvi. [1891] 154). Her altar and statue by Pyrrhos stood beside the Propylæa, and were ascribed by tradition to Pericles, to whom the goddess had in a dream revealed the remedy (the wall-herb *περδίκιον*) for a workman injured by a fall (Plut. *Pericl.* 13; Plin. xxii. 43). The votive inscription on the base, however, says that the work was dedicated, not by Pericles, but by the Athenians; and, as both the base of the statue and the altar are in some way related to the Propylæa, Wolters (*Ath. Mitt.* xvi. [1891] 153 ff.) believes that the occasion of their erection was the cessation of the great pestilence. All attempts to find the Hygieia of Pyrrhos among the extant statuary types of Athena, as, e.g., in the snake-entwined Athena on the base of the Barberini candelabrum (*Mus. P. Clement.* iv. pl. 16), have failed (Wolters, *op. cit.* 163). The 'Athena Hygieia' erected in the Epidaurian *hieron* by an Athenian of the Imperial period (*Ἐφημ. ἀρχαιολ.*, 1886, pl. 12), representing her—strangely enough—as rushing to battle, is no blunder of some ignorant donor (Staës, *Ἐφημ. ἀρχαιολ.*, 1886, p. 253), but is really a derivative of the form assigned to Athena Hygieia, i.e. that which depicts her as the ancient Athena Polias brandishing her weapon. This form, as seen on prize vases for the Panathenaia (Springer, *Handb. der Kunstgesch.* i.⁹, ed. Michaelis, 1907, fig. 320b), has been manifestly used by Callis for his votive offering to Athena Hygieia (cf. *Ath. Mitt.* xvi. 154), and it seems to have been as far as possible adhered to in the statue of Pyrrhos. The Attic Athena Hygieia, accordingly, had no distinct type of its own, but simply reproduces the Athena Polias, who, on the occasion of an earlier pestilence, probably that of 500 B.C. (*CIA* I. 475), had hurried to the help of her city. If the Arcadian Athena *Alea* is connected philologically, not with 'heat' (O. Müller), but with 'protection' (Rückert), it would serve admirably as evidence for the right of sanctuary in her temple at Tegea, but would afford no proof of her being regarded as a goddess of healing. The ancient idol of Endoios is certainly flanked by statues of Asklepios and Hygieia executed by Skopas (Paus. viii. 47. 1), but this

joint cult need not be earlier than the time of Skopas himself (Dümmeler, in Pauly-Wissowa, ii. 1975). Nor, finally, does the statue of the Eileithyia—in the position of a parturient woman—in the temple of Eileithyia at Tegea, and popularly known as *Αθήνη ἐν γόρασιν* (Welcker, *op. cit.* iii. 185), afford any evidence for the Tegean cult of Athena. The title *Ἐπιπέδεια* under which Athena (together with Zeus *Ἐπιπέδειος*) was worshipped, according to Steph. Byz., s.v. *Ἐπιπέδειον*, in Lesbos may be understood quite generally as referring to the divine hand held protectively over one. A like uncertainty attaches to the *σώτρεπα ἐπήκοος* in a Cappadocian inscription (BCH xxxiii. [1909] 131; cf. Weinreich, in *Ath. Mitt.* xxxvii. [1912] 11). The title Optiletis met with in Sparta and said to refer to a cult founded as *ἀκέσως χαριστήριον* by Lycurgus (Plut. *Lyc.* xi.; Paus. iii. 18. 2) has undoubtedly a medical connotation. Gruppe (*op. cit.* 1204) quite unwarrantably infers the existence of incubation in the cult of Athena from Pind. *Ol.* xiii. 56 (Bellerophon) and Paus. ix. 34. 1 (Iodama).

3. Helios.—The links which connect Helios with health and medicine are fewer than the affinity between the ideas of light and life might lead us to expect. As he punishes by inflicting blindness (Soph. *Œd. Col.* 868), so he restores sight to Orion (Hesiod, *ap. pseudo-Eratosth. Kataster.* 32), and is therefore invoked by Polymestor (Eur. *Hekub.* 1067). His cult yields no evidence here; the invocation *Ἰεραίων* in Timoth. fr. 13 (Bergk) comes from a battle-song, while his title Soter in Megalopolis belongs to the age of syncretism (Paus. viii. 31. 4). It is worthy of note that Hermippos (schol. Aristoph. *Plout.* 701) speaks of the Heliad Lampetia as the wife of Asklepios—a detail which, as the present writer thinks (Roscher, iii. 1489), goes back to a Rhodian (in reality a Sicyonian) source. Circe, the daughter of Helios, and Agamede and Medea, his grand-daughters, are sorceresses skilled in herbs; and the Heliad Pasiphaë likewise was proficient in magic (Apollod. iii. 15. 1). For the herb-lore of the wise women, cf. Welcker, *op. cit.* iii. 20 ff.

4. Poseidon.—Poseidon's only link with healing is his having been worshipped as *Ἰατρός* among the Tenians (Clem. Alex. *Protrept.* 26). It is very curious that in the *Ἰλιον πρόθησις* the warrior-physicians Machaon and Podaleirios, who are everywhere else regarded as Asklepiadæ, are spoken of as sons of Poseidon. The verse in question is in a corrupt state—*ἀνδρῶν γὰρ σφιν ἔδωκε πατὴρ ἐνοσίγαιος κρείων*—and Welcker (*Ep. Cycl.* ii. [Bonn, 1849] 525) proposes the emendation . . . *πατὴρ νοσητῆρια παισίν*. Wilamowitz (*Isyllos*, Berlin, 1886, p. 47), however, in view of the local cult of Poseidon at Tenos, maintains the view of their descent from that deity, and the present writer expressed agreement therewith in Pauly-Wissowa, ii. 1658. But the question has meanwhile been discussed afresh by Lefort (*Musée belge de Phil.* ix. [1905] 215 ff.), who decides against Wilamowitz and in favour of Welcker; and rightly so, as the scholia to *Il.* xi. 515 cite the *Porthesis*, not with reference to the genealogy of the two warriors, but in order to establish the medical proficiency of each. Moreover, a corruptly transmitted verse does not warrant us in rejecting the constant tradition of their descent from Asklepios. To Lefort's arguments might be added the testimony of Aristides (i. 78 D): 'Their connexion with Asklepios is affirmed throughout the whole world.'

5. Aristaios.—Aristaios was an ancient Thesalian deity akin in character to Zeus and Apollo (Pind. *Pyth.* ix. 64), and was worshipped in Ceos as Zeus Aristaios and Apollo Nomios (schol. Apoll. Rhod. ii. 498). Having been reduced to the rank of hero by the poetry (*Ἔεα*), he becomes the son of Apollo and Cyrene the Lapith nymph, and the

pupil of Cheiron (Apoll. Rhod. ii. 510). Various benefits in the sphere of husbandry, and also—as a gift of the Muses—the arts of medicine and divination, were ascribed to him (*ib.* 512). He was said to have taught the Ceians how to ward off the baneful influence of Sirius by expiatory sacrifices and the clashing of weapons (Theophr. *de Vent.* 14). Pherecydes calls him the son of Paion (schol. Apoll. Rhod. iii. 467), but this name is to be understood here as a designation of Apollo, and not as the eponym of the Paones (Gruppe).

6. Cheiron.—A signal contrast to Aristaios, the representative of magic healing, is found in the local deity of the herbiferous Mt. Pelion, viz. the Cronid Cheiron, the representative of pharmacognosis, which forms a transition from the sphere of the occult to rational therapeutics. His name has been traced to *χείρ*, either as the 'hand' skilled in art (Welcker, *Kl. Schr.* iii. 1; H. Usener, *Götternamen*, Bonn, 1896, p. 157; Escher, in Pauly-Wissowa, iii. 2302), or as the 'hand' applied to the sick with magic effect (Weinrich, *op. cit.* 16). Tradition speaks more distinctly of his pharmaceutical than of his surgical achievements; in *Il.* iv. 219 and xi. 832, Asklepios and Achilles respectively receive from him *ἥπια φάρμακα* efficacious for relieving pain or staunching blood, and, on the whole, the art of the warrior-surgeons in the *Iliad*, as being free from the accessories of magic, is an inheritance from Cheiron. In a tribe dwelling near Mt. Pelion, and claiming descent from Cheiron, herb-lore was handed down from father to son as a mystery (Dicæarch. fr. 60. 12), and the Magnesians sacrificed to him, as the divine physician, the first-fruits of herbs and plants (Plut. *Quæst. conviv.* iii. 1. 3). In the Pelethronion, a district near Mt. Pelion, grew the far-famed *χειρώνειον* (Theophr. *Hist. Plant.* ix. 7), or *κενταύρειον* (schol. Nicand. *Ther.* 565), the miraculous virtues of which, when applied by a deity, are indicated by its having been called *πάνακες*. Such panaceas were ascribed also to Asklepios and Herakles, and were even adopted by non-religious medicine, though in the form of actual plants with curative properties. The Egyptian physicians likewise were acquainted with panaceas (*Pap. Ebers*, p. 173, ed. Joachim), but, in keeping with their liking for mixtures, compounded them of various ingredients. Cheiron's medical functions, as handed down by tradition (collected in Pauly-Wissowa,¹ iii. 2304), are summarized in the curriculum of his pupil Asklepios given by Pindar (*Pyth.* iii. 45), as surgery, internal medicine, and incantations (*ἐπαοιδάι*). The last-named were not, of course, used by themselves alone, but were simply a magical adjunct (cf. *Od.* xix. 457), as in Bab. and Egypt. medicine.

7. Paieon.—Paieon, the Homeric physician of the gods, heals the wounds of Hades and Ares by *φάρμακα ὀδυνήφατα* in *Il.* v. 401 and 900 respectively, but in *Od.* iv. 232 he comes into touch with the human race as the ancestor of the Egyptian physicians. He is not to be confused with Apollo.² The two deities are explicitly distinguished by Hesiod (fr. 194 [Rzach]) and Solon (fr. 13. 45). Usener (*op. cit.* 153) is thus certainly justified in recognizing Paieon as an ancient and independent god of healing, but he has not succeeded in finding any trace of this deity in Greek religion, as the 'signum Paeanis' in the Asklepieion at Syracuse (Cic. *in Verr.* ii. iv. 128) is a figure of Apollo (Eisele, in Roscher, iii. 1246). The votive inscription *Παιῶνος ἐν ἄλσει* found by Herzog in Cos (*Archæol. Anz.*, 1903, p. 198) refers either to Asklepios or to Apollo, who likewise was worshipped there.

¹ Hereafter referred to as *RE*.

² This identification was wrongly read into *Od.* iv. 232 by Crates and Zenodotus, whose view was impugned by Aristarchus; cf. Lehrs, *Aristarch.*², Leipzig, 1866, p. 179; Ludwich, *Aristarchus homer. Textkritik*, do. 1884-85, I. 541.

8. Apollo.—Apollo is a very intricate figure, and the various explanations of his name have not as yet furnished the key to his original character. This is true even of the most recent attempt—that of Usener (*op. cit.* 309), who recognizes the 'depulsor malorum' in an assumed primary form **Αππελλος*. In Homer, Apollo has as yet no connexion with medicine, though he is certainly the sender and stayer of pestilence (*Il.* i. 43 ff.), and the chant of entreaty addressed to him is called a *παιήων* (i. 473), which is simply the name of the physician of the gods just dealt with. This may be formally accounted for by the fact that the refrain of the chant was *ἦ παιήων*, but the uncertain meaning of the word renders it difficult to discover the material ground of the usage. If the word signifies 'cleanser' (Skr. *panjavan*; Pictet, in Kuhn's *Zeitschr.* v. [1856] 40), its employment as an invocation to the queller of pestilence would be satisfactorily explained. As an epithet of Apollo it occurs also in the *Hymn to Apollo Pythian*. 94 (*Ἰηπαιήωνι*); subsequently the form used was simply (*Παιήων*) *Παιών*, or *Παιών*. At first, and for centuries, the expedients used to counteract pestilence were purely theurgical—consultation of a *μάντις*, *λερεύς*, or *δνειροπόλος* (*Il.* i. 62), sacrifice, and pæan (i. 447 ff.); instances for a later period are given by Welcker (*Kl. Schr.* iii. 33 ff., 'Seuchen von Apoll'). The device of Empedokles in directing the river Hypsas into a half-dried lake is notable as an early example of a rational remedy (Diog. Laert. viii. 2, § 70, and coins of Selinus in B. V. Head, *Historia Numorum*², Oxford, 1911, p. 168). The conception of Apollo as the god of pestilence probably rests on the solar aspect of his character. He was worshipped at Lindos specifically as *Αολμιος* (Macr. *Sat.* i. 17. 15). In this relation he is the one who punishes—the death-god; and here his sister Artemis is associated with him (Niobids, Coronis). On the other hand, his benignity as the stayer of plagues finds expression in such epithets as *Οδλιος* (also at Lindos [Ross, *Inscr. gr. ined.*, iii., Berlin, 1845, no. 272], in Delos, and at Miletos [Strabo, 635]), which G. Curtius connects with *salus*; *Ἐπικούριος* (in Bassæ [Paus. viii. 30. 4]); *Ἀλεξίκακος* (in Athens [statue by Calamis, Paus. i. 3. 4], where, instead of the great plague, we should think of some earlier epidemic); *Ἀκέσιος* (in Elis, Paus. vi. 24. 6), and *Ἰπποσειαντήρ* (in a Clarian oracle [Weinreich, *op. cit.* p. 150]). But the *Paian* was also a chant of battle and victory (*Il.* xxii. 391; *Hymn to Ap. Pyth.* 339; Thucyd. vi. 32, etc.), and thus Apollo acquires a sphere of action far transcending the domain of pestilence—that, namely, of the averter of evil in general, as implied in the titles *Ἀποτροπαῖος* (Aristoph. *Vesp.* 161; *CIG* 464) and *Σωτήρ* (refs. in *RE* ii. 69). The epithet *Ἰήσιος* (Soph. *Œd. Tyr.* 1095) is not, as the Stoics thought, a derivative of *ἰάσθαι*, but is taken from the refrain of the *Paian* in its longer form, *Ἰήσιος Παιών* (*ib.* 154), and has therefore as wide a connotation as the latter. Now, though the more extensive sphere of 'deliverer' might very readily have been contracted to the narrower one of 'physician,' our available evidence of the process is but scanty. The Delphic god, it is true, delivers oracles for arresting pestilence, but, as regards his being consulted in any particular case of disease, the present writer can recall only the instance of Alyattes (Herod. i. 19), and the curious prescription (an amulet of worms from a she-goat's head) given by the Pythia for epilepsy (Alex. of Tralles, 569 [Puschmann]). The reason why Apollo did not become the physician is to be found in the fact that Asklepios was conjoined with him at a relatively early period (cf. 20 below), and the healing function could accordingly be delegated to the latter. Thus, in the heading of the Epidaurian *iamata*, Apollo, as the sovereign authority, is named

first—though he does not intervene in the actual cures; while Asklepios—as a departmental chief, so to speak—occupies the second place; so also in the 'Hippocratic' oath: *δμνυμι Ἀπόλλωνα ἰητρὸν καὶ Ἀσκληπιόν, κτλ.*

A cult confined to *Ἀπόλλων Ἰατρός* is found only in the Milesian colonies of the Scythian region (*RE* ii. 54; Farnell, *CGS* iv. 325 and 409), and here the worship of Asklepios sank completely into the background, the only Asklepieion known to the present writer being that of Pantikapaion (Strabo, 74). Apollo is sometimes called *Ἰατρός* in the poets (Aristoph. *Aves*, 584; *Plout.* 11). His title *ιατρόμαντις* in Æsch. *Eum.* 62 relates to the case of Orestes, and thus denotes, not the physician, but the *καθάρσιος*. Late writers speak of Apollo as the founder of medicine, but as having handed it over to Asklepios for its further development (Diod. Sic. v. 74; Philostr. *Vit. Ap.* iii. 44). Isolated indications of his medical activity are found in the cults of the *Κόρυδος* (Paus. iv. 34. 7; cf. *RE* ii. 57), *Ἰππερελεύτης* (Laconia; cf. *Ἐφημ. ἀρχαιολ.*, 1884, p. 81 ff.; *BCH* ix. [1885] 243), and *Ἰτακός* (Cyprus; *Comment. in hon. Mommseni*, Berlin, 1877, p. 682). As a guest at the Oropian altar (19 below), *Ἀπόλλων Παιών* was likewise regarded as a god of healing.

8a. Maleatas.—The name 'Maleatas' is, as regards its form, a geographical or ethnological adjective, and needs to be supplemented by a *nomen proprium*. Farnell (*op. cit.* iv. 236 f.) would accordingly supply the name 'Apollo' in all cases where 'Maleatas' is used by itself to designate the deity invoked, as, e.g., in two archaic votive inscriptions from Laconia (*IGA* 57, 89). This view, however, is in conflict with the fact that Maleatas and Apollo are mentioned side by side in the sacrificial rubric found in the Piræus (*CIA* ii. 1651), of which Farnell gives a somewhat forced explanation. It will therefore be more in accordance with the data to recognize, as Wilamowitz (*Jahrb.* 98 ff.) does, in Maleatas a deity originally distinct from Apollo. The identification of the two is attested as regards Sparta (Paus. iii. 12. 8: *Ἀπόλλων Μαλεάτης*), the Epidaurian *hieron* (*ib.* ii. 27. 7, and several inscriptions, *IG* iv. 932, etc.), and the Asklepieion of Triikka (*IG* iv. 950. 29). If this identification was a later development, it was probably effected in Epidauros, where Asklepios would form the connecting link. Gruppe (*op. cit.* 189. 3) is hardly successful in explaining (on the ground of Hesych.: *μάλιαν . . . ἡσυχον, πραεῖαν*) Apollo Maleatas as the 'gentle Apollo,' or in locating his place of origin, as also that of Asklepios, at Gortyna in Crete.

9. Artemis.—For the function of Artemis as a death-goddess associated with Apollo, cf. the preceding; in this capacity her special victims are females (*Il.* xxi. 483, vi. 205, 428; etc.). Gruppe (*op. cit.* 1269, 1273. 4) regards her as having been the source of psychical and nervous disorders. The other aspect of this activity is her having been the restorer of those so afflicted, as, e.g., Orestes (Pherec. fr. 97), and the Prætidæ (Bacchyl. x. 98). In gratitude for the cure of the latter, their father erected in her honour, as *Ἡμέρα* and as *Κοῖρα*, temples in Lusi (Callim. *hymn. Art.* 234)—a point so far borne out by the ordinary myth of the Prætidæ (Pausanias), which relates that the maidens were cured by Melampous (B. 5, below) in the Artemision of Lusi. Lusi is the only healing-shrine assigned by tradition to the goddess (cf. the Report of excavations in *Oesterr. Jahreshften*, iv. [1901] 1 ff., which includes several dedications to *Ἡμέρα*, p. 83 f.). Her connexion with healing fountains, however, is attested by the epithet *Θερματά* (Mitylene [*CIG* 2172, etc.], Cyzicos [Aristid. i. 503D], and Rhodos [*IG Ins.* i. 24. 4]). The panelling of the ancient Artemision of Ephesus

contained votive models of limbs in gold, silver, and ivory (Hogarth, *Excav. at Ephesus*, London, 1908, pp. 232, 238). Cf. also her title 'Επήκοος (*Ath. Mitt.* xxxvii. [1912] 7 ff.). Her obstetric function is indicated by the titles Λοχέα (Gambreion, *CIG* 3562), Σωδία (Charonea, *IGS* i. 3407), and ΕΙλειθία (especially in Beotia); cf. Wernicke, in *RE* ii. 1347. 10, who, however, wrongly regards ΕΙλειθία as the hypostasis of Artemis, while it was really an epithet of Hera, and, as personified (Preller-Robert, i. 511 ff.), still remains closely connected with her. Similarly, Μυλίττα (Bab. *Mu'allidtu*, 'she who brings about childbirth') is an epithet of Istar (cf. Schrader, *KAT*³, p. 423. 7). The Heb. *yôledeth* (Oefele, in Neuburger-Pagel, i. 70) is merely an artificial form designed to explain ΕΙλειθία.

10. **Healing Nymphs.**—(a) As presiding over medicinal springs: (1) the 'Ιωνίδες (Paus. vi. 22. 7), 'Ιαοίδες (Nicand. *ap.* Athenæus, 683), or 'Ιωνίδες (Strabo, 356)—connected with *lâsôthai*—nymphs of a healing fountain in Elis, and forming a tetrad, viz. Pegaia, Kalliphæia, Synallaxis (probably a personification of the change towards recovery), and Iasis (cf. Hesych. *s.v.* *larpol*); (2) the Anigridian nymphs, so named from the warm sulphur-springs on the lower Anigrus in Triphylia (Strabo, 346; Paus. v. 5. 10; Curtius, *Peloponn.* ii. 80), and having to do especially with skin-troubles—here we should note the combination of theurgy (prayer and vow) with rational remedies (bathing in a mineral spring); and (3) the nymphs of the alkali springs of Ischia (*IG Sic. et Ital.* 892 f., the votive offering of a physician).

(b) We have more numerous instances of the case where the refreshing properties of ordinary natural springs gave rise to the cult of local nymphs, generally in connexion with the worship of Acheloos as the father of all fresh-water springs. In their hygienic capacity these nymphs appear, together with Acheloos, as guests at the altar of Oropos (19 below).

11. **Pan.**—Pan, the Arcadian mountain and forest spirit, like his Italic counterpart Faunus, possessed mantic powers. He had an oracle in the Lykaion (schol. Theocr. i. 121), and another in the Akakesion, with the nymph Erato as his *προφήτις* (Paus. viii. 37. 12). He received the title *Λυτήριος* in Troezen, because he stayed a pestilence by means of dream-oracles (*ib.* ii. 32. 6), but he healed men also in the waking state (Kaibel, *Epigr. gr.*, Berlin, 1878, p. 802). In the Asklepieion at Sicyon, the porch was flanked by figures of Pan and Artemis (Paus. ii. 10. 2). With reference to the healing powers of Pan Ephialtes (in the mid-day sleep), see Roscher, iii. 1400. The epithet Παιάν is applied to him only in *Orph. hymn.* xi. 1. In conjunction with nymphs, Acheloos, and Kephisos, he represents the hygiene of Nature at the altar of Oropos (19 below).

12. **Hermes.**—In the case of Hermes definite traces of the healing function are scanty. The titles Soter (Amorgos; *Ath. Mitt.* i. [1876] 332) and Alexikakos (Aristoph. *Pax.* 422) are applied to him in quite a general sense. The meaning of 'Ακάκητα (*Il.* xvi. 185, *Od.* xxiv. 10, Hes. fr. 23 [Rzach]) is disputed (cf. *Etym. Magn.*, *s.v.*); if derived from *ἀκείσθαι* (schol. L to *Il.* xvi. 185 explains it by *θεραπευτικός*), it would be a specifically medical epithet, but this is scarcely conceivable with so ancient a designation; perhaps the word means 'the averter of evil' (*ἀ-κάκ-ητα*). Hermes Kriophoros was worshipped in Tanagra as the queller of pestilence, and in commemoration of his good services a youth carried a ram round the walls at his festival there (Paus. ix. 22. 1). The propitiatory action of Hermes survives in this custom, and accordingly the beautiful conception of the 'good

shepherd' derives its origin from a cathartic rite. Hermes is the 'Υγήτωρ *ὄνελρων* in Hom. *Hymn to Hermes*, 14, and the god of sleep in general (Preller-Robert, i. 404), though it cannot be proved that incubation had a place in his cult. As the god of the palaestra and the gymnasium, he was the guardian of health; and it was perhaps on this account that Hygieia was in some source represented as his wife—a detail which Cornut. 16 too artificially explains by reference to his eloquence.

13. **Herakles.**—'Born to avert the curse from gods and men' (Hes. *Scut.* 27), Herakles is pre-eminently the Alexikakos. In schol. Arist. *Kan.* 501 the image of Alexikakos, by Ageladas, in the demos of Melite is associated with the great plague, instead of with the pestilence of 500 B.C. (Robert, *Arch. Märchen*, Berlin, 1856, p. 39) or the Persian invasion (Studniczka, *Röm. Mitt.* ii. [1887] 91. 21). The shorter form 'Αλεξίς was current in Cos (Aristid. i. 60); in Delos and Amorgos he was worshipped as 'Απαλλαξικακος (*BCH* vi. [1882] 342, xvi. [1891] 671). Herakles Soter is found in tetradrachmæ in Thasos (Head, *Hist. Num.*², p. 266, fig. 164). Herakles acts specifically as a healing deity in Hyettos (Paus. ix. 24. 3), Erythræ (*ib.* vii. 5. 5), and Messana (Aristid. i. 59 D); he is the guardian-spirit of warm springs (as, *e.g.*, at Thermopylæ, Herod. vii. 176), and has a share in the Oropian altar (19 below). The *πράνακες* 'Ηράκλειον was named after him (Theophr. *Hist. Plant.* ix. 7; schol. Nic. *Ther.* 626; *Diosc.* iii. 48).

14. **The Dioscourai.**—The widely diffused cult of the Dioscourai as Soteres is sometimes connected with navigation (*Hom. hymn.* 33, Theocr. xxii. 6), sometimes with succour in war (as, *e.g.*, to the Locri on the Sagra [Justin, xx. 2 f.]), and even with the restoration of freedom (the device *Σωτήρες* on coins of Tyndaris is so explained by Head, *op. cit.* p. 189). They saved their protégé Simonides when the palace at Crannon collapsed (Callim. *ap.* Suid. *s.v.* *Σιμωνίδης*). The healing of Phormio the Crotonian at Sparta by one of the Dioscourai (Theopompus *ap.* Suid. *s.v.* *Φορμίων*) is a replica of the cure of Telephus by Achilles. The Dioscourai engaged in a regular practice of healing in their temple at Byzantium (*FHG* iv. 149, 15). The means adopted seems to be incubation combined with interpretation of dreams. Deubner (*de Incub.* 76 ff.) concludes from schol. Pers. ii. 56 that this was the case both in their sanctuary at Rome and in that at Byzantium, and, further, that in both localities their function was inherited by Kosmas and Damian, physicians and martyrs. Cf., however, below, p. 555^a, note 4.

15. **Dionysos.**—Apart from the epithets of general signification (*Σωτήρ* or *Σαώτης*, Paus. ii. 31. 5, 37. 2; *IG* iv. 1277; and Παιάν, Eur. *Lik.* fr. 480, Dindorf; 'Pæan of Philodamus,' *BCH* xix. [1895] 391, xxii. [1898] 513) applied to Dionysos, he was worshipped specially as 'Ιατρός and 'Τριάτης by command of the Pythia (Athenæus, 22 and 36; Plut. *Quæst. conv.* iii. 2). As *Βοηθὸς νόσων* he presided over the dream-oracle at Amphikleia, where his priest, as *πρόμαντις, χρά ἐκ θεοῦ κάτοχος*, *i.e.* just as the Pythia did (Paus. x. 33. 11). It is thus clear that in this sanctuary the priests were concerned with incubation and dream-reading, as in the Plutonion near Nysa (cf. 17 below). As regards the healing power of Dionysos conveyed by touching (*Διόνυσος Ἐπάφιος* in *Orph. hymn.* 50. 7), see Weinreich, *op. cit.* p. 27.

16. **Demeter.**—Demeter, worshipped as *κουροτρόφος*, was proficient in the magic of the nursery (*Hom. hymn.* iv. 227 ff.; *οὐδοτόμοιο*, v. 229, a brilliant emendation by Th. Bergk, *Gr. Literaturgesch.* Berlin, 1872-84, i. 801. 35), and in the fire-baptism which imparted eternal youth (v. 235 ff.), but the indications of her healing function are few.

In Patræ she had a *hydromanteion*, in which, however, she did not prescribe remedies, but simply revealed whether the sick would die or recover (Paus. vii. 21. 12). To cite Artemid. ii. 39 as a proof of her iatric activity (Preller-Robert, i. 764. 2) is unwarranted, as this passage deals only with rules for dream-reading, while in *Orph. hymn*, 40, she is in a quite general sense the original donor of peace, law, riches, and health. To connect the device *Tyleia* found beside the beautiful head on Metapontine coins (reproduced in Roscher, i. 2780, from the *Cat. of the Brit. Mus.*) with Demeter (Sallet), again, is precluded by the youthfulness of the head. In the medical domain, accordingly, all that we can concede to her is the function of Ophthalmitis; the three references to this are dealt with by Rubensohn, *Ath. Mitt.* xx. [1895] 360 ff., and on p. 365 her connexion with Asklepios in Epidauros, Athens, and Eleusis is correctly adjudicated. For the female breasts upon marble blocks from her temple in Cnidus, see C. T. Newton and R. P. Pullan, *Discoveries at Halicarnassus*, London, 1862-63, i. pl. 58.

17. Hades-Pluto.—The dream-oracle in the Plutonion near Nysa on the upper Mæander (Strabo, 649; Eustath. *ad Dionys. Periegetem*, 1153) is of great importance in the history of Gr. religious medicine. Here *oi ἐμπειροὶ τῶν ἰερῶν* incubated on behalf of the sick in a cave filled with earthy vapour—the *Χαρῶνιον*—and regulated their curative treatment by the dreams received in the ecstatic trance. In many cases they let the patients themselves sleep in the cave for a few days without food, but, even if an invalid was favoured with a dream, the priests still acted as *σύμβουλοι* and *μυσταγωγοί*. In the Plutonion, therefore, the task of interpreting dreams devolved exclusively, and that of incubation generally, upon the priests. Such, however, was exactly the characteristic feature of the Bab. dream-shrine, which, as we saw above (p. 542*), was the prototype of the Gr. institution. Higher up the Mæander valley, near Hierapolis, was another Plutonion, having a cave pervaded by even more potent exhalations, which only the Galloi could safely approach (Strabo, 630). Whether incubation was resorted to here as well Strabo does not definitely say, but Pausanias (x. 32. 13) states that dream-shrines of the subterranean deities were to be found in several cities of the Mæander valley. From an inscription of the Imperial period (in Heuzey, *Miss. archéol. de Macéd.* ii. [1876], Inscr. 120) we may assume that incubation was practised in a Plutonion at Eana in Macedonia. A miraculous cure wrought by water from the altar of Dis and Proserpina is related by Valerius Maximus (ii. 4. 5).

18. Sarapis and Isis.—Sarapis was a syncretistic creation of Ptolemy I.—a fusion of Hades-Pluto with Osiris and a Bab. deity whom Arrian and Plutarch designate *Σάραπισ*, and in whom Lehmann-Haupt (most recently, 1910, in Roscher, iv. 340) recognizes Ea, 'king of the ocean-depths' (*sar apsi*), the early Bab. god of oracles and healing. The Bab. name was adopted by the Egyptians in the form *Serapis*, in which they discerned their own *wesjr hapi* (Osiris-Apis), i.e. the dead Apis who had been zealously worshipped from the time of Psammetichus. The distinctive feature of the Ea-cult—the healing oracle obtained by incubation—was retained by the new Alexandrian deity, who thus became a powerful rival of the similarly endowed Asklepios. This rivalry he shared with Isis, who became closely allied with him, and who in the Egyptian period had been a healing goddess, though without incubation—an institution unknown among the Egyptians (see above, p. 541 f.). Sarapis and Isis then spread their conquests over the entire Hellenistic and Roman

world, carrying with them the assiduous cultivation of the dream-oracle. The sources used by Artemidorus (ii. 44) preferred before all other oracles the dreams vouchsafed by these two deities. Here the essential thing was the interpretation of the prescriptions so given (*συνταγὰι*), though, as we might expect, miracles of direct healing (*θεραπείαι*) were not wanting; the Greek words are the technical terms used in the aretological literature. For the healing functions of Sarapis and Isis, see Weinreich, *op. cit.* 117 ff., with Excursus iii. on Artemid. iv. 22. Of the much-frequented Serapeion in Canopus, Strabo (801) writes that persons incubated there not only on their own behalf, but also on behalf of others, and that records were kept both of the *θεραπείαι* and of the *ἀρεταὶ τῶν ἐνταῦθα λογίων* (i.e. *συνταγῶν*); the redactors of the Epidaurian *ἰάματα*, as we saw, had eyes only for the former. Models of restored limbs offered to Sarapis and Isis (cf. Tibull. i. 327) are of frequent occurrence (cf. Drexler, in Roscher, ii. 526 ff.). A relief from Thebes (Rangabé, *Ant. Hellén.* ii. [1855] 778, no. 1213) with the inscription *Εὐνοία Εἰσοῖδι εὐχὴν* depicts a youth on a *κλίση*, three nymphs dancing beside it, and, in the background, a bearded head on a larger scale (Acheloos)—probably a thank-offering for a water-cure prescribed by Isis (cf. 10).

The three chthonic gods, Amphiaraos, Trophonios, and Asklepios—the incubation-deities *par excellence*—are all closely related to Hades. Of these, however, Trophonios may be passed over here, as he shows no special development on the medical side. Amphiaraos and Asklepios, on the other hand, became healing gods in a specific sense—both, it is true, being reduced in epic poetry to the level of heroes, but maintaining their divine dignity in the cultus. Amphiaraos, as a result of his being confined to a locality, never gained any extensive sphere of influence, while the beneficent hand of Asklepios reached as far as did the influence of Greek and Roman culture.

19. Amphiaraos.—The Greek epic makes Amphiaraos a hero of Theban-Argive legend, and a descendant of the seer Melampous (below, B. 5), but even as such his originally divine (chthonic) nature finds expression in the circumstance that he was at death translated to the under world (Pind. *Nem.* ix. 24). He presided over the sanctuary of Oropos. The high regard accorded to this dream-shrine is shown by its having been consulted by Cræsus and Mardonius (Herod. i. 46, 52, viii. 134). The curative procedure of this Amphiareion, which, it is true, was as bitterly satirized by Aristophanes in his *Amphiaraos* (presented 414 B.C.) as was that of the Asklepieion in his *Ploutos* (408 and 388 B.C.), formed the central feature in the activities of the sanctuary. The code of regulations (*IG* vii. 235) fixes the client's fee at one and a half drachmæ, and makes mention of a *koimeterion* with two separate apartments beside the altar. An incubation-hall of later date, situated at the theatre (P in Dürrbach's map, reproduced in *RE* i. 1895) was similar in design to the *ἄβατον* of Epidauros. The visitor, after a period of fasting—'in order to receive the oracle with a clear soul' (Philostr. *Vit. Apoll.* ii. 37)—and the sacrifice of a ram, prepared himself for the intimation of the god by sleeping on the hide of the animal sacrificed (Paus. i. 34. 4, 5). We thus see that Amphiaraos performed his cures, not by direct miracles during incubation (as in the redaction of the Epidaurian *iamata*), but by means of dream-oracles, which were, of course, submitted to the judgment of the dream-reader. An important factor in the treatment was the *λουτήριον*, with separate compartments for men and women (*IG* vii. 4255)—which is often referred to from the days of Aristophanes and Xenophon (*λουτήριον Ἀμφ.*). The fountain of Amphiaraos, to the south of the altar

(P in map), was investigated by the physicians Erasistratos and Euenos (Athenæus, 46)—a fact which indicates that it was used for therapeutic purposes, and not, as Pausanias says, only as a receptacle for thank-offerings of gold and silver coins. Models of restored limbs are mentioned in *IG* vii. 303, 67 ff., and 3498.

The great altar (D), according to Pausanias, contained five *μοῖραι*, by which almost everything connected with healing in Attic religion was brought into relation with Amphiaraos. The third *μοῖρα*—the principal division—belonged to the god himself, to his son Amphilochos, together with Hermes (as *ἡγήτωρ δυνειῶν* [?]) and Hestia (probably as the domestic goddess of Amphiaraos). The *σύμβωμοι* were associated as guests with the other parts as follows: Herakles, Zeus, and Apollo Paion (cf. the Delphic oracle in Demosth. *Mid.* 53) with the first; heroes and heroines with the second; Aphrodite (*CIA* iii. 136; *εὐάντητος λατρίνη*), Panakeia-Iaso-Hygieia (representing the Athenian Asklepieion), and Athena Paionia (Kerameikos), with the fourth; and nymphs, Pan, Acheloos, and Kephisos (cf. *io* (b) above) with the fifth. It is quite certain that Iaso was here regarded as a guest (cf. the present writer's observations [Roscher, iii. 1486] in opposition to Usener). Aristophanes, in the *Amphiaraos*, speaks of her as a daughter of the Oropian deity, but in the *Ploutos* as the daughter of Asklepios; and as such she appears also upon a relief from the Asklepieion (*Ath. Mitt.* xvii. [1892] 243). Hygieia is first found in connexion with Amphiaraos in inscriptions of the 1st cent. B.C. (*IG* vii. 372. 412), and was therefore at that period no longer a mere guest, but a joint-possessor of the sanctuary. The healing god of Oropos had a subsidiary institution at Rhamnous (Mela, ii. 3. 6; and excavations [*Δελτιον*, 1891, p. 116], which have yielded a relief representing Amphiaraos attending upon the sick).

Alexida, the daughter of Amphiaraos, is associated with the medical function by her very name. In Argos, her descendants, the *Ἐλαδαῖοι* ('expellers'), were regarded as healers of epilepsy (Plut. *Quæst. Gr.* 23).

20. Asklepios.—Considerations of space render it impossible here to treat of Asklepios in such detail as is due to the chief god of healing among the Greeks. The writer must, therefore, be content to emphasize some of the more salient points, and for the rest to refer to his more exhaustive artt. in Roscher, 'Asklepios' (1884), 'Hygieia' (1889), and 'Panakeia' (1902), and also the art. 'Asklepios,' in *RE* ii. [1896] 1642 ff., and 'Epione,' *ib.* vi. [1906] 186 ff. The 181 localities connected with the cult of Asklepios (*ib.* ii. 1662 ff.) are only a selection from among the 410 which the writer had at his disposal, and which form a still more effective testimony to the enormous expansion of the cult.

i. *The origin and earliest spread of the cult, and the intrusion of Apollo.*—The earliest history of the cult has been distorted under Delphic influence, but may be reconstructed from the extant fragments. The name 'Asklepios' was traced by the Epidaurian writer Isyllos (3rd cent. B.C.) to *Αἰγλή* (*Ἄσγλη*) (*IG* iv. 950, line 51). Von Wilamowitz (*Isyll.* 93), combining this word with the Apollo *Ἀσγέλατος* of Anaphe, proposes the primitive form *Ἀσγλαπιός*. Gruppe (*op. cit.* 1442 ff.) agrees with this, but believes that we have in Asklepios a confluence of two distinct personages—the one a light-god, *Asgl-apis* ('mild radiance'), connected with Apollo, and belonging originally to Gortyn, in Crete, the other an earth-god in the form of a snake (this is Welcker's explanation of the name, from *δοκλάβος*), who became fused with the light-god in Bœotia and Phokis. The present

writer cannot accept these theories, and, refraining from etymological experiments, would only emphasize the originally chthonic character of Asklepios. This is indicated, indeed, by the facts that the leading symbol of Asklepios was the snake, that incubation was a characteristic feature of his worship, that a residue of the chthonic ritual (*δλόκωντα*) survived at Titane, an ancient centre of his cult, and, finally, that he had a double in Trophonios, the cave- and oracle-deity of Lebadeia, who was once identical with Asklepios, but was detached from him at an early date, when the physician deity had not yet been individualized. According to the thoroughgoing investigations of O. Müller (*Orchomenos*², Breslau, 1844, p. 183 ff.), the original home of Asklepios was Thessaly, the devotees of his cult being the Minyæ. The tradition handed down by the separating theologians (Cic. *de Nat. Deor.* iii. 22 [57]; Joh. Lydus, *de Mens.* 4, 90), according to which his parents were Ischys, the son of Elatos, and Koronis, the daughter of Phlegyas, is of great importance, as it points to a period when Asklepios had no connexion with Apollo. His surrender of a divine for a heroic rank was effected by epic poetry. Thus in Homer he is merely the 'blameless physician' (*Il.* iv. 194), the disciple of Cheiron (219), and the father of the warrior-surgeon Machaon, *Τηλέκην ἐξ ἱπποβόροιο* (202), with whom passages of later origin associate a brother named Podaleirios (ii. 732, xi. 833). On Homer's authority the Asklepieion of Triikka was regarded as the most ancient of all (Apollod. *ap.* Strabo, 437), and the river Lethaios as the birthplace of Asklepios (oracle in Euseb. *Præp. Evang.* iii. 14. 6). But Phthiotis and Magnesia were also counted among his primitive habitations, as his education under Cheiron was associated with that region, while his place of birth was located by an *Eæe* in the Dotian champaign near Mt. Pelion. His earliest migration from Thessaly was southwards to the Minyean Northern Bœotia, and here Trophonios was worshipped in Lebadeia, and Asklepios in Orchomenos, Hyettos, Thespiæ, and Thisbe (*RE* ii. 1663). He was still a stranger to Southern and Western Bœotia, as also to Attica, to which his cult came from Epidauros only in 420 B.C. On the other hand, he had at an early date gained a permanent footing in Phokis, which honoured him universally as its archagete (Paus. x. 32. 12). It was in Phokis, indeed, that the worshippers of Asklepios came into collision with the Apollinian circle at a period when, in consequence of the Dorian migration, the cult of Apollo had forcibly established itself in Delphi. The traditional implacable hostility of the Phlegyans towards the Delphic sanctuary indicates the violence of the conflict, which, however, ended in the triumph of Apollo.

A sweeping transformation of Minyean beliefs now ensued in favour of the intruder. Apollo becomes the father of Asklepios, Koronis the god's faithless mistress, Ischys the violator of his rights, but the offspring is taken into favour, so that he may henceforth act as the benignant physician of mankind under the patronage of the Delphic god; then, as he made bold to infringe the cosmic order by restoring the dead to life, he fell a victim to the bolt of Zeus. Such is the substance of an *Eæe* (Hes. fr. 122-125 [Rzach]) which dominated the mind of Pindar (*Ol.* iii.) and the succeeding age (cf. *RE* ii. 1646) until the rising prestige of the Epidaurian *hieron* led to a revision of the Asklepiian myth which had the sanction of Delphi. In this new form of the saga the connexion of Asklepios with Thessaly, and the guilt and punishment of his mother—a feature obnoxious to his worshippers—were dropped, while Apollo is no longer the Delphic god, but the Epidaurian Maleatas

(8 (a) above). In the *hieron* the latter begets Asklepios by Aigle, daughter of an 'Epidaurian' Phlegyas, and surnamed Koronis, from her beauty, and makes him joint-possessor of the sanctuary. Such is the version given in the poems of Isyllos in the first half of the 3rd cent. B.C. (Wilamowitz, *Isyll.* 18 ff.; Kavvadias, *Fouill.* no. 7; *IG* iv. 950). A somewhat closer correspondence with the *Eæe* is shown by the Epidaurian form of the myth in Pausanias (ii. 26. 7); here Koronis, being with child by Apollo, comes with Phlegyas from Thessaly to Epidauros, and upon the 'myrtle-mountain' brings forth in secret the son who fills the world with his fame as soon as he reaches maturity (cf. *RE* ii. 667, s.v. 'Aresthanas'). This version likewise won the sanction of Delphi.

Asklepios, however, notwithstanding his having been thus forcibly grafted upon the Apollinian circle, maintained his independence in his own cult. This appears most distinctly from the type assigned to him in art, which, in contrast to the representation of the son of Leto, exhibits him as the fatherly friend of men, the *πατήρ Πάτριον* (Herondas); hence the flippant jest of the sacrilegious Dionysius in Cic. *de Nat. Deor.* iii. 83 (on which cf. *RE* ii. 1679. 31 ff.). The cult of Koronis in Titane (Paus. ii. 11. 7)—a worship in conflict with the standpoint of the *Eæe*—should also be noted.

ii. *The family of Asklepios.*—This comprises two groups, which must be kept distinct. (1) *His iatric retinue.*—Here we have his consort *Epione*, a personification of the 'mildness' which popular etymology found in his name (*Ἀσκλη-ήπιος*). According to schol. *Il.* iv. 195 (*ἡ Μέποιος*), she was of Coan origin, but, on grounds of mythical chronology, we should probably read *ἡ Μεποιός* here. *Epione* is fully dealt with in *RE* vi. 186–190.¹ The first of his descendants are the two 'excellent surgeons' affiliated to him by epic poetry, viz. *Machaon* and *Podaleirios*, leaders of the men of Triikka, Ithome, and Oechalia (*Il.* iv. 202, ii. 729 ff.; for their worship in Triikka, see *RE* ii. 1682). *Machaon* had a separate cult only in Gerenia (Messenia), but in conjunction with his father was worshipped in several Greek Asklepieia, as, e.g., in Cos, at Pergamos, and doubtless also at Mitylene (cf. *RE* ii. 1680). *Podaleirios* is almost unknown in European Greece, but in Caria he is the ancestor of a famous family of Asklepiadæ, and, according to v. Wilamowitz (*Isyll.* 51), was originally a Carian hero. In the West his cult reached Apulia (dream and healing oracles among the Daunians). The assertion that the two brothers were the sons of Poseidon (frag. of the *Porthesis*) was negated above (4); the fragment in question is nevertheless of interest as the earliest Greek record of the separation of surgery (*Machaon*) and internal medicine (*Podaleirios*). A legend of Syrna (Steph. Byz. s.v. *Σύρνα*) relates that, when the king's daughter had fallen headlong, *Podaleirios* restored her by bleeding.

The outstanding iatric figure of the group is *Panakeia*, a personification of the popular notion of the miraculous all-healing herbs already mentioned in connexion with Cheiron and Herakles. As the daughter of Asklepios, she represents his omnipotence in the sphere of healing (on the centres of her cult, and her presumably Rhodian origin, cf. Roscher, iii. 1484 ff.). In the ancient oath of the physicians she alone—as a healer—is contrasted with *Hygieia*; subsequently she was associated with a sister named *Iaso* (Hermipp., Aristoph. *Plout.* 701), and, at length, with the addition of *Akeso*, we find a triad of female healers (Athenian relief, reproduced in Roscher, iii. 1490;

¹ *Lampetia*, who is named as the wife of Asklepios by Hermippus, would fall rather into the second group. See below, p. 552.

inscr. from Piræus, *CIA* ii. 1651; the Pæans of Ptolemais and Athens). The medical retinue of Asklepios is completed by the dæmons *Ianiskos* (schol. *Plut.* 701), *Akesis* (Epidauros; Paus. ii. 11. 7), and *Telesphoros* (Pergamos); the last-named is viewed in very different lights (Welcker, *Götterlehre*, ii. [1860] 740; Wroth, *JHS* iii. [1882] 283 ff.)—most recently as an incubation spirit by Ziehen (*Ath. Mitt.* xvii. [1892] 241). The hymn in *CIA* iii. 171 identifies him with *Akesis*; Pausanias (ii. 11. 7) does likewise, but at the same time identifies him also with *Euamerion* (see below, under (2)). Incubation is represented by *Hypnos* in Sicyon (Paus. ii. 10. 2), Athens (*Ath. Mitt.* ii. [1877] 242. 4), and Epidauros (Blinkenberg, *ib.* xiv. [1889] 390).

(2) *The personifications of health and eubētia.*—

The leader of this group is the maiden *Hygieia*, who by many recent writers is wrongly regarded as a healing goddess. The name has a history in part independent of the Asklepiian cult. It is found c. 500 B.C. as an epithet of the goddess of the Athenian citadel (cf. above, 2). The hymn of Licymnios (*Frag. Lyr. Gr.* iii. 599) makes reference to a maternal *Hygieia*, extolling her as 'the Queen of the august thrones of Apollo,' but does not connect her with Asklepios. It is clear also, from Cornut. 16, that in some places a *Hygieia* was associated with *Hermes* (cf. 12, above). Finally, a maidenly figure designated *Hygieia* is found among the personifications of *Euexia* (*Eudaimonie*, *Harmonia*, *Tyche*) on vase-paintings (Jahn, *Archæol. Beitrage*, 215; *AZ*, 1879, p. 95), and beside a youth named *Klytios* on the vase of Meidias (Inghirami, *Mon. Etrusc.*, Fiesole, 1824–27, v. 2, pl. xii.). But, while the representation of an abstract conception might be employed in many ways, the creation of a figure in the cultus is a different matter. Usener (*Götternamen*, 169) supposes, however, that an independent goddess designated *Hygieia* was known in Athens long before the settlement of Asklepios there (420 B.C.)—a theory which the present writer refutes in Roscher, iii. 1486. If the point in question be the medium in which the worship of the goddess of health first emerged, there are good reasons for believing that this was the Asklepiian cult. That *Hygieia* reached Athens in company with Asklepios in 420 B.C. is an assured fact (cf. the final revision of the relative inscription, *Ἐφημ. ἀρχαιολ.*, 1901, p. 98). If she did not come from Epidauros (where her connexion with the *hieron* in the 4th cent. B.C. is now attested by *IG* iv. 1329), she must have been brought from some other Asklepieion in the Peloponnesus—Titane perhaps; her ancient worship there is discussed in Roscher, i. 2776. As the guardian of health, she forms a real contrast to the medical retinue of Asklepios, and accordingly she does not appear in the healing scene of the *Ploutos*; while, again, in the well-known *Paian*, a recension of which (4th cent. B.C.) was recently discovered in Erythræ, she is, for the sake of emphasis, put last of all. The sick might approach her with petitions, the restored with thanksgiving; her name in itself signifies the stewardess of the supreme blessing of life. But this blessing was not merely a thing to be regained by healing, but rather—what was of more importance for national life—a thing to be safeguarded and strengthened by rational conduct. Now, such an idea had a natural attraction for the race that instituted the athletic contest and the gymnasium. That it was familiar also to the followers of Asklepios is shown by a saying which Plato puts into the mouth of the physician Eryximachos, viz. that Asklepios, taking account of the two tendencies of the animal body—*ἐπὶ τῷ ὑγιεινῷ* and *ἐπὶ τῷ νοσώδει*—presides over the whole art of medicine on the one hand and over gymnastics and agriculture

on the other (*Symp.* 186 B, and cf. Jüthner, in his ed. of Philostr. *περὶ γυμναστικῆς*, p. 37 ff.). This agrees with the fact that at Olympia on the table of Kolotes, upon which the wreaths of the victors were laid, Asklepios and Hygieia are seen confronting Agon and Ares, i.e. are honoured as patrons of athletic and martial contests. What artistic type, then, would be chosen to represent the patroness of the Olympic games? That, surely, of a maidenly figure, at once lithe and tense. Moreover, in all other cases where we can with certainty identify her figure, she appears as a maiden. Modern archaeology has given rise to a certain vacillation between the matronly and the maidenly form, but to the Greeks themselves 'the world under her escort bloomed in the vernal radiance of the Charites' (Hymn of Ariphron, *Poet. Lyr. Gr.* iii. 597). In the Athenian Asklepieion, the inscriptions of which speak of Hygieia as the only other partner in the sanctuary, she is sometimes (*Ath. Mitt.* ii. [1877] plates 16 and 17; Roscher, i. 2782) depicted beside her father—who is seated—as leaning against a tree and without a symbol; in other cases she is usually represented as waiting upon the sacred snake, to which she offers food, or more frequently a bowl. The statement that a bowl (of gold) was bequeathed by Olympias to the image of Hygieia worshipped in Athens (Hyperid. *pro Euxen.* § 19) prompts the conjecture that that figure exhibited her in the act of giving the serpent drink. In Epidauros, again, Blinkenberg has discovered the figure of a snake drinking from a bowl as an accessory symbol upon an offering (altar or base) dedicated to Hygieia (*IG* iv. 1329). Hygieia is the only member of the Asklepiian circle who shares his exaltation as the *Σωτήρ* of the world (Roscher, i. 2784).

The fact that *Aigle* becomes a daughter of Asklepios seems to be due to the affinity between the ideas of health and light (cf. the Laconian epithets of Asklepios: *Ἀγλαδῆς*, *Ἀγλαήρ*), and it is worthy of note that in this capacity she makes her first appearance in the curious genealogy of Hermippos, in which also her mother is not Epione, but the Heliad *Lampetia*. The children of Asklepios, according to Hermippos, are the two physicians of the *Iliad*, Iaso, Panakaia, and Aigle: Hygieia is not named, *Aigle* probably taking her place. In the recently discovered *Paian* of Erythræ (v. Wilamowitz, 'Nord-ionische Steine,' *ABAW*, 1909, p. 37), *Aigle* has been substituted, not very happily, for the Attic *Akeso* in the triad of female healing goddesses. In a painting by Nikophanes of Sicyon (Plin. xxxv. 137) Hygieia and Aigle, Panakaia and Iaso, were grouped about Asklepios.

A male counterpart to the goddess of health is found in *Euamerion*, the Titanian spirit 'of good days' (Paus. ii. 11. 7), and, if Telesphoros be identical with him, as Pausanias says, he too would, of course, be assigned to the second Asklepiian group (cf. ii. (1), at the end).

iii. *The therapeutics of the Asklepieia*.—The connexion between the therapeutics of the Asklepieia and secular medicine, as also the practice of incubation, and the alleged difference between the procedure of the Greek and that of the Roman period, were dealt with in our first section. Suffice it now to refer briefly to the three records of healing which still survive, wholly or partly, in redacted forms. (1) The Epidaurian *iamata*, consisting entirely of miraculous stories, are vitiated by the cardinal defect of making incubation a mere external accessory. In this respect, however, they find a precedent in the *Ploutos* of Aristophanes. (2) The Maffean inscriptions of the Insula Tiberina retain the mantic nature of incubation, recording the bestowal and practical application of dream-oracles. Here, however, the remedies prescribed

are wholly of a magical kind, and medicine in the proper sense is entirely absent (cf. Deubner, *de Incub.* p. 44 ff.). (3) A fragment of a redaction of pathological narratives from Lebena has been discussed to good purpose by Zingerle (*Ath. Mitt.* xxi. [1896] 67 ff.), who errs, however, in classing this redaction with the Epidaurian *iamata*, for the extant fragment records prescriptions given by the god in dreams, and the cures due to their application. This work, therefore, like the surviving originals of Granius and Apellas, would fall within the category of genuine therapeutics.

B. *HEROES*.—The heroes of Greek mythology fall into two groups, according as they derive their origin from the cult of the dead or from the worship of gods. In the former case they tend to acquire a malicious character, and need to be propitiated by acts of worship; such are, e.g., the heroes who, according to Hippokrates, *περὶ λεπῆς νόσου*, I (vi. 362, Littré), were supposed to cause epilepsy. The second class, embracing deities whom the poets reduced to the status of heroes, are, on the other hand, disposed to be helpful to man, especially in the healing of disease; and hence, in pseudo-Hippokr. *περὶ διαίτης*, 89 (vi. 652, Littré), they are invoked together with the apotropæic gods and Ge. Those of this group who retained their place in the cultus as deities were dealt with in the preceding section (A. 13, 15, 19, 20); but Achilles, though originally a water-demon (Usener, *Göttern.* p. 14), was there omitted, because he was worshipped exclusively as the hero of the Trojan legend.

1. Achilles.—The attempt to interpret his name in a medical sense (Gruppe, *op. cit.* 71. 616) has proved futile. His sanctuary in Brasiaë is mentioned by Pausanias (iii. 24. 5), not as having any real connexion with the Asklepieion situated there, but merely as being in its vicinity. His dream-shrine in the island of Leuce, opposite the delta of the Istros (Arrian, *Peripl.* 23), was specially concerned with the coasting traffic. He appears as a healing hero only in Tertull. *de Anima*, 46, where he heals Leonymus the boxer. In the Trojan legend he is a pupil of Cheiron (*Il.* xi. 832), cures Telephos with the rust of his spear (*ὁ τρώσας ἰάσεται*), and bandages Patroklos upon the Sosias bowl (Müller-Wieseler, *Ant. Denkmäler*, Göttingen, 1854, i. pl. 45, no. 210).

2. Protesilaos, a healing hero in the Thracian Chersonese (Philostr. *Heroic.* ii. 15).

3. Hektor, according to a Delphic utterance (Lykophron, 1205, and schol. 1194), was an *ἀρωγὸς λοιμικῶν τοξενμάτων* in Thebes.

4. Antikyreus, the eponym founder of Antikyra in Phokis, and the discoverer of the *ἑλλέβορος μέλας*, with which he cured Herakles of madness (Ptol. Chenn. 2, p. 14 [Roulez]; Steph. Byz. s.v. *Ἀντικυρεὺς*). The hellebore decoction was said to have been discovered by the Phokians, and was used for both cathartic and therapeutic purposes (schol. Nic. *Alexiph.* 483; Strabo, 418).

5. Melampous.—The Æolid Melampous was the founder of a famous family of seers, upon which Amphiaraios (A. 19)—as his grandson—was grafted (*Od.* xv. 225 ff.). In Pherekyd. fr. 75 he is the hero of an interesting popular legend, which tells how, in consequence of having his ears cleansed by snakes, he became proficient in prophecy and the language of animals, and by a magic remedy (*ὁ τρώσας ἰάσεται*) enabled Iphiklos to regain his lost virility. He delivers the Prætidis from their madness—either supernaturally, *θυσίαις ἀπορρήτοις καὶ καθαρμοῖς*, in the Artemision at Lusi (Paus. viii. 18. 7), or by rational means, viz. a bath in the fountain of the Anigridian nymphs (A. 10 (a) (2), the waters of which acted powerfully against skin-eruptions and herpes. On the latter alternative, the Prætidis must really have suffered from an affection of the skin, as is actually said, indeed,

in the version given in the Hesiodic *Catalogue*, fr. 28. 29 (Rzach). According to Theophr. *Hist. Plant.* ix. 10. 4, Melampous treated their case with the ἄλλεβορος μέλας, which was in consequence also called *melampodion*. Rohde (*Psyche*, Freiburg, 1894, p. 339. 3) holds that this remedy was purely cathartic; but it may quite well be regarded as therapeutic, and, therefore, as a counterpart to the *panakes* of Cheiron and others. There was a cult of Melampous at Ægosthena, but there was no practice of divination connected with it (Paus. i. 44. 5). According to Imhoof, Blumer, and Gardner ('Numismatic Commentary on Paus.', *JHS* vi. [1885] 58), the circular building upon a coin of that locality may be a representation of his shrine (ἱερῶν).

6. Apis.—According to Æsch. *Suppl.* 261 ff., Apis, the eponym founder of Apia (Argolis), and the *λατρόμαντις παῖς Ἀπόλλωνος*, came from Naupaktos, and freed the land from monsters ἀκεσι τομαίους (cathartic *pharmaka*). He was subsequently (Porphyr. *de Abstin.* iii. 15) identified with the Egyptian Apis (cf. Wernicke, *RE* i. 2810).

7. The descendants of the Asklepiad Machaon (A. 20, ii. (1)).—This group is composed partly of originally local spirits or heroes, as, e.g., his sons Nikomachos and Gorgasos, who in the time of Pausanias (iv. 30. 3) were still active as healing heroes—especially for paralysis—at Pharee in Messenia (cf. Roscher, i. 625; *RE* ii. 1668), and partly of those whose sole function it was to found Asklepieia, such as Sphyros in Argos, Polemokrates in the Thyreatis, and Alexenor in Titane (Paus.), though in the last-named locality the founder, according to schol. Arist. *Plout.* 701, was Alexenor, the son of Asklepios. On the family of Asklepiads which traced its descent from Nicomachos—and to which Aristotle belonged—and on the Asklepiads of Rhodes, Cnidus, and Cos who sprang from Podaleirios, see *RE* ii. 1684.

8. Molpadia Hemithea, daughter of Staphylus, and, after her death, heroine of a dream-oracle at Kastabos (Thracian Chersonese) much frequented by invalids; she had also an obstetric function (Diod. Sic. v. 62, 63).

9. Darron, ᾧ ὑπὲρ τῶν νοσοῦντων εἰχονται among the Macedonians (Hesych. s.v. Δάρρων). G. Curtius (*Greek Etym.*, 1897, no. 315) connects the name with θαρρεῖν. Usener (*op. cit.* 171) refers it to the Thracian tribe of the Δερραῖοι. To the latter pertains also the interesting Macedonian large silver coin with the legend Δερρονικός(ν), which denotes, not a king (Head, *op. cit.* 180¹), but a nationality (Gäbler, *Zeitschr. für Numismat.* xx. [1897] 289).

10. Eurostos: Τέμενος Ἡρώος Εὐρώστου on the Bosphorus (reference in Usener, *op. cit.* 171. 64, to Dionys. *Peripl.* 111).

Copious examples are furnished by Attica:

11. Amynos.—The 'healing hero Alkon,' whose existence had been assumed solely upon the ground of a textual emendation in *Vit. Sophocl.* 11, proposed by Meineke, may now, in view of the findings of A. Körte in *Ath. Mitt.* xxi. (1896) 311 ff., be set aside, and his place given to Amynos, a hero who had a sanctuary on the western declivity of the Akropolis even before the cult of Asklepios came to Athens, and in whose service Sophokles acted as priest. In this capacity the poet gave the Epidaurian deity a hospitable reception, and was in consequence surnamed Δεξιῶν, and honoured with a hero-cult. On the objects discovered in the sanctuary of Amynos, cf. Körte's earlier art. 'Bezirk eines Heilgottes,' in *Ath. Mitt.* xviii. (1893) 231 ff., with pl. xi. (a large leg with prominently marked varicose vein, and held in the arms of a bearded man on a smaller scale—probably the person healed).

12. The Ἡρώς λατρός in the vicinity of the Theseion

¹ But cf. the remarks of Head in his 2nd ed., p. 201.

(Demosth. *Or.* xix. 249, xviii. 129; *CIA* ii. 1, nos. 403, 404 (δ ἐν ἀσσει).

13. Toxaris, as a Ἡρώς ξένος, specially concerned with fever (Lucian, *Scyth.* 1). He is not a fabrication of Lucian (Sybel), but the object of an actual hero-cult (Deneken, in Roscher, i. 2483 f.).

14. Aristomachos, Ἡρώς λατρός, in the Dionysion at Marathon (Bekker, *Anecd. Græc.*, Berlin, 1814, i. 262).

15. A Ἡρώς λατρός ὄνομα Ὀρεσίβιος (Oresibios?) ἐν Ἐλευσίνι (Bekker, *op. cit.* i. 263).

Reference may be made, by way of appendix, to healing statues and figures representing persons who in their lifetime had nothing to do with medicine, and yet were invested by popular belief with miraculous powers, as, e.g., the statue of the Olympic victor Theagenes in Thasos (Paus. vi. 11. 3; Lucian, *Deor. Conc.* 12), that of the pancratiast Pulydamas at Olympia (Paus. vi. 5; Lucian, *loc. cit.*), that of a Ἡρώς Νερυλλίνος in the Troad (Athenag. 26), those of Alexander (Paris) and Peregrinos Proteus in Parium (Athenag. 26), and that of the Corinthian general Pelichus in the private possession of Eukrates (Lucian, *Philopseud.* 18 ff.). On these, see Weinreich, *op. cit.* 137 ff.

LITERATURE.—This is indicated in the article.

E. THRÄMER.

HEALTH AND GODS OF HEALING (Roman).

I. IN THE INDIGENOUS RELIGION.—

In the sphere of medicine the vitally religious element in the Roman character manifested itself in a partiality for supernatural, and a disparagement of rational, modes of healing. The fact that, in spite of the Roman tendency to deify special and unique occurrences and conditions, we find no distinctive gods of disease among the deities of the *Indigitamenta* (see the alphabetical list by R. Peter, in Roscher, ii. 188 ff.) is in reality an indication of the favourable conditions of health prevailing in the ancient agricultural State. Moreover, there were originally no special deities of healing among the *Di indigetes*, the gods of the State religion; and the Romans, like the Greeks of primitive times, were content to rely upon the evil-averting powers of the indigenous deities generally. Thus Mars, the god of war, is entreated in the *Carmen Arvale* (*CIL* i. 28) to avert pestilence: 'Let no plague come upon the people; be content, O fierce Mars!', and in the ancient prayer in Cato, *de Agri Cult.* 141 (the diction of which, however, according to R. Reitzenstein, in *Strassburger Festschrift*, 1901, p. 152, has been modified by the redactor), the same deity is implored not only to prevent bad weather, failure of crops, etc., but, in particular, 'uti tu morbos visos invisosque defendas averruncesque; uti tu . . . pastores pecuaque salva servassis duisque bonam salutem valetudinemque mihi domo familiaeque nostrae.' With these prayers should be compared the shorter supplication in *de Agri Cult.* 134 (to Janus and Juppiter) and 139 (addressed quite generally to all the gods: 'si deus, si dea es'). The ancient Italian *Salus*, again, is not a goddess of health or healing, but the personification of the general welfare (cf. G. Wissowa, *Religion u. Kultus d. Römer*², Munich, 1912, p. 132 ff.). She was, no doubt, confounded with the Greek *Hygieia* in later linguistic usage, but this can hardly have been the case in the official religion. In the frequently mentioned 'augurium salutis' (the leading reference is Dio Cass. xxxvii. 24, where *salutis* is improperly rendered as *ὕγιαιας*, instead of *σωτηρίας*), the word is not a proper name at all, but simply an appellative. The attempt of Böttiger ('*Medicinische Schlangengaukelei*, in *Kleine Schriften*, i. [1837] 127 ff.) to connect the 'augurium salutis' with the snake-feeding *Hygieia* is altogether fallacious. The ancient Latin goddess *Strenua* is regarded by Preller (*Röm. Myth.*³,

Berlin, 1883, i. 234) as a deity of healing, but only on the ground of an untenable etymology in Augustine, *de Civ. Dei*, iv. 11. 6: 'strenuum facere'; the *strenæ* ('twigs of trees') given as New Year's presents, however, were made use of, quite generally, as symbols of prosperity (cf. Plaut. *Stich.* iii. 2. 8).

On the other hand, the ancient *Carna*, shown by Wissowa (*op. cit.* 236) to have been a goddess of the under world, has a distinct connexion with matters of health. According to Macrob. *Sat.* i. 12. 31, she presides over *vitalibus humanis*, and she is entreated 'ut iecinora et corda quaeque sunt intrinsecus viscera salva conservet.' From the free poetic treatment of *Carna* by Ovid (*Fasti*, vi. 101-196) it would appear at least that she practised the beneficent magic arts of which the presumptive *ἑροφός* prides herself in the *Hymn to Demeter* (see above, p. 548 f.). The *Striges* who thirst for children's blood she exorcizes by touching the doorposts three times with a twig of arbutus, sprinkling the threshold with water, holding the entrails of a pig two months old (*Fasti*, vi. 161: 'cor pro corde, pro fibris fibras'—a representative spell; cf. Riess, 'Aberglaube,' in Pauly-Wissowa, i. 33 (c)), and, finally, placing a hawthorn-branch in the window as a prophylactic. The particular deities of woman's life—Juno as *Lucina*, *Diana Opifera* in Nemi, and the host of special goddesses (*Mene*, *Alemona*, etc.) named in the *Indigitamenta*—can only be alluded to here.

A specific goddess of disease is found in *Febris*, whose personification bears forcible witness to the antiquity of the fever-plague in the plains of the Tiber. Belief in disease-demons was, no doubt, quite common among the Babylonians (see above, p. 541*), and the Egyptians seem to have had a 'special god of fever' (*Pap. Ebers*, ed. Joachim, pp. 87, 93—unless the reference be rather to a god of 'inflammations'); these, however, were hostile beings, whom the people sought to exorcize by spells. The Roman *Febris*, on the other hand, was well disposed towards man, and prospered the remedies used for the disease. That these remedies were magical in their nature is shown by the 'remedia quae corporibus aegrorum adnexa fuerant' (Valerius Maximus, ii. 5. 6), obviously amulets for reducing fever, which after use were dedicated to *Febris*. There was an ancient sanctuary of *Febris* on the Palatine Hill, and two of later origin on the Quirinal and the Esquiline respectively. In later times she assumed the specialized forms of *Febris Tertiana* and *Febris Quartana* (*CIL* vii. 999, xii. 3129). Magic remedies for both kinds of fever are given in Plin. *HN* xxviii. 46.

Among the *Dii Novensides* of Italian origin there were two who are clearly associated with healing. (1) One of these was *Fortuna*, an ancient Latin goddess whose cult is said to have been established in Rome by Servius Tullius. The chief seats of her worship were Antium and Praeneste, in the latter of which she had, as *Primigenia*, an ancient oracle for sortilege. The cult of *Primigenia* did not reach Rome till 199 B.C. She was not, like the Greek *Tyche*, the goddess of fate who rules over all things, but was personified in innumerable special forms, as, e.g., 'Fortuna huiusce diei,' 'Fortuna equestris,' 'Fortuna publica' and 'privata,' 'Fortuna Collegii Fabrum,' 'Fortuna balneorum,' and the like (Wissowa, *op. cit.* 262), including 'Fortuna salutaris' (*CIL* vi. 184, 201, 202), which may have quite a general reference, but as found in the votive inscription of Godesberg (*CIL* xiii. 2, no. 7994) is certainly connected with healing: 'Fortunis salutaribus [note the pl.] Aesculapio Hygiae.'—(2) The Etruscan, originally Falerian, *Minerva* (Wissowa, *op. cit.* 247 ff.) had a temple on the Capitoline Hill even prior to the institution of the Capitoline triad (*Festus*,

p. 257, s.v. 'Quinquatrus'). As the goddess of the handicrafts and the arts she was, in particular, the patroness of physicians (L. Preller, *Regionen der Stadt Rom*, Jena, 1846, p. 133), with which fact, it is true, the remark of Cicero in *de Div.* ii. 123 ('sine medico medicinam dabit Minerva') is strangely at variance. There was a temple of *Minerva Medica* upon the Esquiline (Wissowa, 255, n. 1). A sanctuary of *Minerva Memor et Medica Cabardiacensis* (near Placentia) is often referred to in inscriptions (*CIL* xi. 1292-1310); here she prescribed medicines, healed diseases of the ear, and even condescended to restore the growth of the hair.

So much for the indigenous gods and those taken from the neighbouring peoples—deities who were worshipped in old-fashioned Roman or, it might be, in Italian forms, and, above all, in forms borrowed from the Etruscan religion.

II. GREEK INFLUENCES.—These in the end effected the Hellenization of the Roman religion. Of the gods thus borrowed from the Greeks, however, only a few are connected with our subject.

I. Apollo.—The *Sibylline Books*, which cannot be dissociated from the worship of Apollo, began, so far as we know, to make their influence felt in Rome in 496 B.C. It is certain that these books, as also the Roman worship of Apollo, came from Cumæ, as is confirmed by the fact that on special occasions the Senate caused sacrifices to be offered to Apollo in his temple there (cf. Wissowa, *op. cit.* 293 f.). The first Roman temple of the god was erected, 'pro valetudine Populi Romani,' at the Porta Carmentalis in 431 B.C., on the occasion of a plague (Livy, iv. 25). Here, accordingly, the Greek god of pestilence (see above, p. 547*) found a footing in Rome; the Romans worshipped him as *Apollo Medicus*, and in the prayer of the Vestal Virgins (Macrob. *Sat.* i. 17. 15) he is actually invoked as *Apollo Pæan*. His worship in Rome, as among the Greeks, consisted of expiations and ceremonies—supplication and procession (Livy, xxvii. 37), *lectisternium* and the appointment (by Etruscan rites) of a 'dictator clavi fingendi causa' (Livy, vii. 2, viii. 18). A Roman dedication to *Apollo Salutaris et Medicinalis* occurs in *CIL* vi. 39. According to Pliny, *HN* xxvi. 93, a remedy for abscess, compounded of seven ingredients, was given to the naked patient by a naked virgin—each of them spitting the while—with the words: 'negat Apollo pestem posse crescere cui nuda virgo restinguat.' Nakedness was believed to be a magic preventive (cf. Riess, *loc. cit.* i. 35). It is probable that the vogue of Apollo as a healing god began to decline when the cult of *Æsculapius* was adopted in Rome (291 B.C.), but in conjunction with the latter and *Salus* (*Hygieia*) he received votive gifts as far down as the pestilence of 180 B.C. (Livy, xl. 37).

2. *Æsculapius* and *Hygia*.—The reception of *Asklepios*,¹ the Greek god of the healing art, into the Roman pantheon is worthy of note as the first instance of the Romans having adopted a cult from the Greek mother-country. The occasion was the pestilence of 293 B.C., the *Sibylline Books* having recommended that *Asklepios* should be brought from Epidaurus to arrest it. The Romans did not at first go beyond a three-days' *supplicatio* (Livy, x. 47), but in 291 they sent an embassy, headed by G. Ogulnius (Valer. Vict. *Vir.* III. 22), to Epidaurus, whence it brought back 'anguem in quo

¹ The Latin form *Aesculapius* (*Aisculapius*, *CIL* vi. 2, from the *Insula Tiberina*) goes back to *Aesculapius* (*CIL* iii. 1766, from *Narona*) or *Aisculapius* (*ib.* xi. 6708), which corresponds exactly with the older Epidaurian form *Ἀἰσκαλαπιός*. The intrusive vowel between *c* and *l* in the common Lat. form has a Gr. counterpart in the Thessalian **Ἀσκαλαπιός*, which is to be inferred from certain proper names (Pauly-Wissowa, ii. 1642).

ipsum numen esse constabat.¹ A temple was erected to the god on the Insula Tiberina at the place where the serpent, quitting the ship, reached land (Livy, *Epit.* xi.). So ran the primitive, artless legend, of which we are still reminded to this day by its monumental counterpart in the boat-shaped outline of the island (cf. the ancient engraving in B. Gamucci, *Antichità di Roma*, Venice, 1580, p. 173; M. Besnier [*L'île Tibérine dans l'antiquité*, Paris, 1902, p. 42 = *Bibl. des écoles françaises*, lxxxvii.] dates the artificial shape of the island from the end of the Republic). In the diffuse account given by Ovid (*Metam.* xv. 622 ff.), and also in Val. Max. i. 8. 2, the founding of the temple is extolled as an event of great importance, but in point of fact the cult seems to have played a very modest part in the Republican period.²

As regards the internal activities of the Roman branch of the Epidaurian cult, our information is scanty. That they corresponded very closely with those of the parent institution appears from the reference of Festus (p. 110) to the sacred snakes and dogs kept in the island;³ and, in view of the fact that the Epidaurian *iamata* (see above, p. 542^b) were compiled shortly before the adoption of the cult in Rome, we may perhaps infer that here too the craving for the miraculous had asserted itself with considerable force. But there is nothing to show that incubation, which was certainly taken over with the cult itself,⁴ had lost its mantic character (as in the *iamata*). In the *Curculio* of Plautus, the scene of which is laid in Epidaurus, but which is full of allusions to Roman conditions, the procurer to whom the god has paid no attention in his dream is supplied with an improvised interpretation of it (246 ff.). This goes to prove that there were professional 'conjectores' in the Roman Asclepieum in the time of Plautus, but direct evidence of incubation is not found until the Flavian epoch (*CIL* vi. 8: 'Flavius Antyllus ex viso Asclepio aram consecravit'; cf. *ib.* 14, 'Sancto Aesculapio ex jussu numinis dei'). A dedication (discovered in front of the *Porta Appia*) by a

¹ This was the specific mode of founding branches of the Epidaurian cult; cf. Paus. ii. 10. 3 (Sicyon), iii. 23. 6 (a consignment of sacred snakes intended for Cos, but retained in Epidaurus Limera)

² It certainly comes but little into notice: see dedications to Apollo, Aesculapius, and Salus (i.e. Hygia), in 180 B.C. (Livy, xl. 37); head of Aesculapius on denarii of Acilius the mint-master (E. Babelon, *Monnaies de la République rom.*, Paris, 1886, i. 107, no. 11); figure of 'Valetudo' (i.e. Hygia) feeding the snake (*ib.* 106, no. 8); mural paintings in 'Aesculapii aede vetere' (Varro, *de Ling. Lat.* vii. 57; 'vetere' here in contradistinction to the later sanctuaries in the iv. and v. *regiones* of the city); the Naples marble statue of Aesculapius (illustration in Roscher, i. 634) is said to have been found in the Insula Tiberina; probably, too, the group of Asklepios and Hygieia executed by Nikeratos (who flourished in the period of the Attalids), and afterwards transported to Rome (Plin. *HN* xxxiv. 80), had found its place in the temple of the island (the charming group in the Vatican [illustr. in Roscher, i. 2779] is in all likelihood a copy of this); the architectural work of two aediles 'de stipe Aesculapi' (*CIL* vi. 7). The statue of Antonius Musa, physician to Augustus, was set up 'juxta signum Aesculapi' (Suet. *Aug.* lix.), perhaps on the Insula Tiberina.

³ The statement of Festus that the sacred dogs were kept 'quod is [Aesculapius] uberibus canis sit nutritus' is a distortion of the Epidaurian legend, and is probably due to Tarquinius (cf. *Lact. Div. Inst.* i. 10. 1).

⁴ From the dream-oracles of Faunus, as described in Verg. *En.* vii. 71 ff., and, in imitation of them, in Ovid, *Fasti*, iv. 644 ff., Preller (*Röm. Myth.* i. 382) argues that incubation was practised in Rome long before the cult of Asklepios was established there, but in n. 2 Jordan refers to the Hellenizing spirit of Roman poetry, while R. Heinze (*Vergils epische Technik*, Leipzig, 1903, p. 172, n. 2), on the ground that the alleged Faunus oracles would be an isolated phenomenon in early Italian religion, denies that the descriptions in question had any foundation in fact. The present writer is of the same opinion. The earlier oracular system of the Romans depended upon Etruscan influences, and incubation was unknown in Etruria. What is said of dream-oracles in Hellenized Rome outside the Aesculapian cult—the oracular statues of the Danaids in the temple of the Palatine Apollo (founded 28 B.C.), and the healing oracles of the Roman Dioscuri (schol. on Pers. *Sat.* ii. 56)—is open to doubt (Wissowa, *op. cit.* 270, n. 2).

certain M. Ulpus Honoratus to Aesculapius and Hygia, 'pro salute sua suorumque et L. Juli Helicis medici, qui curam mei diligenter egit secundum deos,' is of special interest as showing the co-operation of physician and deity. A Greek parallel to this is found in a dedication to Asklepios in Kibyra: here the person healed gives thanks to the god, to the Tyche of the city, and to Dionysios, the doctor who had treated him (*Wiener Akademie, Anzeiger*, xxx. [1893] 104). The 'Mafesian inscriptions' of the Insula Tiberina date from the age of the Antonines, and are a redaction of four narratives of healing (*CIG* 5980); an interpretation will be found in L. Deubner, *de Incub.* Leipzig, 1900, p. 44 ff. We read in these that oracles were bestowed in dreams, and practically applied, but the directions given are of a purely theurgic character. A revival of interest in the cult of the god of healing in the reign of Antoninus Pius is indicated by the latter's memorial coin bearing a representation of the legendary foundation of his temple (H. Cohen, *Méd. impér.* Paris, 1880-85, ii. 271, fig. 17; cf. also the reliefs in *Röm. Mitt.* i. [1886], plates 6 and 7).

Of the diversified figures in the retinue of the Epidaurian god (see above, p. 551), 'Hygia' alone appears in Rome. She was there also called 'Valetudo,' and is first mentioned in connexion with the year 180 B.C. (Livy, xl. 37, where the 'Salus' conjoined with Aesculapius must, of course, be meant for Hygia); while she is referred to as Salus also in Ter. *Hecyra*, 338. Conversely, the temple of the early Roman Salus is erroneously called *vaδs rñs* 'Tyelas' by Plutarch (*Cato Major*, 19). The confusion is explained by the affinity of the terms *salus* and *valetudo*. From the Roman Salus, however, the daughter of Aesculapius is explicitly distinguished in *CIL* vii. 164 (Chester) as 'Salus ejus'; other inscriptions usually call the latter 'Hygia' (*CIL* vi. 17-19, and 20234—the last dating from the reign of Antoninus Pius). It is true that in the temple erected by Marcus Aurelius and L. Verus in honour of the divine father and daughter in Lambæsa (Numidia) we again find the dedication 'Aesculapio et Saluti' (*CIL* vii. 2579a). But the proper Latin designation of the daughter of Aesculapius, as regards both her name and her character, is *Valetudo* (*CIL* iii. 7279), and the goddess is so designated on a denarius of Acilius (see preced. col., note 2), as the name 'Valetudo' which is there attached to a female figure attending to a serpent can refer only to Hygia. Compare also *CIL* v. 6415 (Pavia): 'Aesculapium Bonam Valetudinem Martem'; and viii. 9610 (Mauretania): 'Bonae Valetudini sacrum.'¹ A pre-Hellenic goddess 'Valetudo' occurs (*CIL* ix. 3812 [Marsi]).

The diffusion of the Aesculapian cult through the vast Roman Empire cannot be traced here, but reference may be made to a remarkable representation of the god in a military type. He appears thus on several reliefs from Syria (Jalabert, in *Mélanges de la faculté orientale*, Beirut, i. [1906], pl. i. 1 and 2, pl. ii. 3-5: 'Aesculap en officier romain'). This is to be explained by reference to the worship of the emperors. The Cameo St. Albans (C. W. King, *Antique Gems and Rings*, London, 1872, ii. 9) depicts an emperor (probably Constantine) in warlike attire, and bearing the eagle of Jupiter

¹ Hygia had a rival in *Bona Dea*, a Greek goddess worshipped in Argolis, Sparta, and Tarentum, under the name of Damia, and in Rome identified with Fauna—*Bona Dea* (Wissowa, *op. cit.* 216). *Bona Dea*, in her temple on the Aventine, which was restored by Livia, seems to have exercised the function of a healing goddess, inasmuch as her devotees stored in this temple 'omne genus herbarum ex quibus antistites dant plerumque medicinas' (Macrob. *Sat.* i. 12. 26). Wissowa (218, n. 1) associates with her the inscriptions *CIL* vi. 72: 'Bonae Deae Hygiae,' and viii. 20747: 'Dea [Bona] Valetudo'; but, on the other hand, the *Bona Dea* there referred to may be an epithet of the daughter of Aesculapius.

and the snake-entwined *hasta*. King wrongly interprets the latter symbol in a Christian sense ('the old serpent' overcome by Constantine). But in reality we find here a transference of the regular symbol of Asklepios to the deified emperor as the incarnation of the *Σωτήρ*. This is the type used in the Syrian reliefs, and these accordingly portray the face in all cases as beardless.

Concluding note on Cato the Censor.—Did the Romans, who, as we know, assumed at first a suspicious and adverse attitude towards Greek rational medicine, frame a popular medicine of their own for ordinary needs, in addition to their general supplications to the gods? And was Cato, the opponent of Greek culture, and especially of the Greek physicians (Plin. *HN* xxix. 14; Plut. *Cato Major*, 23), a champion of such indigenous medicine? That he was versed in medical matters is shown by his having inserted rules of health in his *Præcepta ad M. filium* (Plin. vii. 171, xxviii. 260; Plut. *loc. cit.* 23; Priscian, vi. 84), and by the portions of his extant work *de Agri Cult.* which deal with medical dietetics. It is a common opinion that he derived his knowledge of such things from the medical practice of the Italian peasantry (W. S. Teuffel, *Gesch. der röm. Litteratur*⁴, Leipzig, 1882, § 55; Jordan, in Preller, i. 243, n. 3; F. Münzer, *Beiträge zur Quellenkritik der Naturgesch. des Plinius*, Berlin, 1897, p. 68: 'Die primitive Heilkunst des sabinischen Bauern'), and the curious spells recommended for dislocations (*de Agri Cult.* 160) possibly come from a similar source. But the 'apsinthium Ponticum' prescribed as an amulet against footsoreness (159) is an exotic feature. To what source, again, shall we trace the long excursus (156-7) dealing with the dietetic and therapeutic merits of the various kinds of cabbage? The *Brassica Pythagorea* (157. 1) cannot well have belonged to the pharmacopœia of the Sabine peasantry, and the Greek name *Silphion* is used only in this section (157. 7), while in ch. 116 Cato employs the Lat. term *lasericum*. Finally, his remark that the assimilation of food tends to prevent perspiration of the veins has a distinctly professional ring. Now, we know that the Cnidian physician Chrysippus (M. Wellmann, in Pauly-Wissowa, iii. 2510, no. 15), who accompanied Eudoxos (see above, p. 541^b) on his Egyptian journey of research wrote a monograph on the various kinds of cabbage, and showed in that work the great importance of the species for therapeutics and dietetics (Plin. *HN* xx. 78). And that this Cnidian work was, directly or indirectly, Cato's source for chs. 156-8¹ appears not only from Cato's partiality for the cabbage tribe, but also from the curious prescription (157. 14) recommending *Brassica 'erratica'* with water for fistula, and with honey for sores—precisely the same directions having been given by Chrysippus (in Plin. *HN* xx. 93). It is quite possible, too, that the *Commentarius* (Plin. *loc. cit.*), or the *γερραμύτων ἰσχύρημα* (Plut. *Cato Major*, 23), according to which Cato was wont to treat himself and his family in sickness, may have been simply that work of Chrysippus. The Cnidian school of physicians fostered the relations between medicine and *τὸ θεῖον* (see above, p. 544^b), and was on that account more acceptable to the religious sentiment of the Roman people than were the Hippocratics with their purely scientific methods. But it is certainly a curious circumstance that the chief opponent of Hellenism in Rome should thus turn out to have been the adherent of a mere *Græculus*.

LITERATURE.—This is given in the article. Cf. also the authorities cited in the 'Greek' article. E. THÄMER.

¹ The purgative prescribed in 158—a mixture which with its numerous ingredients reminds us of Egyptian pharmacy—belongs also to the excursus, as it includes *Brassica*.

HEART.—1. Heart, soul, and life.—In primitive thought the liver was probably regarded as a primary seat of life, but the heart generally came to be looked upon in this way, as its physiological functions were better understood. The beating of the heart, as well as the cessation of that beating at death, may well have prompted man to associate life itself with it or to regard it as the seat of the soul, or, where several souls are assigned to man—a not uncommon belief—as the seat of one, usually the chief of them. The result has generally been that 'heart' signifies not only the physical organ, but also soul, life, intellect, emotion, will, and the like; and it is not always easy to say whether or not a metaphorical use of the word is intended. This is illustrated in the common phrase 'died of a broken heart,' which goes back to a time when grief of itself was supposed to act injuriously upon the physical heart.

The Ahts believe that the soul, a sort of mannikin, lives in the heart and head.¹ The Caribs, who believed in several souls, assigned one to the heart, or regarded it as the chief soul.² The Tongans thought that the soul extended through the body, but was mainly manifested in the heart, the pulsations of which were the power of the soul. The right auricle of the heart was the seat of life.³ Among the natives of Nias a belief in three souls exists, and the third and most important of these is *nosododo*, 'the soul of the heart.' The heart is the source of all feeling, understanding, and emotion.⁴ The Bataks sometimes assign souls to each place in the body where pulsation is observed, one of these being the heart.⁵ In Celebes the Gorontaloese believe in four souls, two of which are in the heart.⁶ Examples may also be cited from Africa, where generally the heart is looked upon as a vital centre, and the seat of emotion, passion, etc., of the intellect, or of the soul. 'Soul' and 'heart' are expressed by one name among the Ba-huana.⁷ Where several souls are believed in, the heart is the seat of the life-soul, and it may be drawn thence by sorcery, whereupon the body dies. The Baluba of S. Congo think that death is caused by a messenger of Kabezza-Mpungu compressing the heart until it stops beating.⁸

Among peoples of a higher culture, similar beliefs prevailed. The Egyptian word *ab*, in its narrower sense of 'heart,' signified longing, desire, will, wisdom, courage, etc.; and the heart was regarded as the seat of life, and of all its activities. There was also a soul connected with the heart, the *hāti*, or 'heart soul,' or 'the state, or quality, or mental condition of the heart.' Both of these, the *ab* and the *hāti*, could be stolen, with the result of death, and the deceased is represented adoring the *hāti*, which may also have been that which was weighed in the judgment. Five chapters of the Book of the Dead concern the preservation of the heart, without which the deceased was helpless, but with which his soul would not be 'fettered at the gates of Tuat.' But it was liable to be stolen by various 'stealers of hearts'; hence the greatest precautions were taken to prevent this; e.g., a scarab amulet was often placed over the region of the heart.⁹

With the early Babylonians the liver had been regarded as the seat of the soul or life, and it was only at a later period that a knowledge of the part played by the heart was arrived at. Many traces of the earlier idea survived, 'liver' being used instead of, or along with, 'heart' to signify the seat of life; and hepatoscopy was constantly practised. A frequent refrain in the hymns is, 'May thy heart be at rest, thy liver be appeased.'¹⁰

¹ G. M. Sproat, *Scenes and Studies of Savage Life*, London, 1868, p. 173 f.

² J. G. Müller, *Amer. Urrel.*, Basel, 1855, p. 207 f.; C. de Rochefort, *Iles Antilles*, Rotterdam, 1681, p. 429.

³ W. Mariner, *Tonga Islands*², London, 1818, ii. 99, and *passim*.

⁴ A. E. Crawley, *Idea of the Soul*, London, 1909, p. 120 f.

⁵ *Ib.* 112.

⁶ A. C. Kruijt, *Het Animisme in den ind. Arch.*, The Hague, 1906, p. 13.

⁷ E. Torday and T. A. Joyce, *JAI* xxxvi. [1906] 291; cf. A. B. Ellis, *Ewe-speaking Peoples*, London, 1890, p. 99 f., *Yoruba-speaking Peoples*, do. 1894, p. 126 f.

⁸ H. H. Johnston, *George Grenfell*, London, 1908, ii. 642.

⁹ E. A. W. Budge, *Osiris and the Egypt. Resurrection*, London, 1911, ii. 131, 137, *Book of the Dead*, chs. 28-30.

¹⁰ M. Jastrow, *Aspects of Rel. Belief and Practice in Bab. and Assyria*, New York, 1911, pp. 149 ff., 196, *Rel. of Bab. and Assyria*, Boston, 1898, p. 324.

Among the Hebrews, traces of the same idea of the liver being the seat of life and emotion are to be found (Pr 7²³, La 2¹¹, Ps 16⁹ [read 'liver' for 'glory']). But an advance had been made, and generally in the OT the heart is at once the source and the symbol of life in its various aspects. This is well seen in Pr 4²³, 'keep thy heart with all diligence, for out of it are the sources of life.' The heart is the seat of both intellectual (to the exclusion of the head) and emotional life, including thought, memory, perception, will, imagination, joy, sorrow, anger, etc. (Ps 33¹¹, Gn 8²¹, Dt 29⁴ 4⁹, Ex 14⁵, Ps 104¹⁵, Dt 19⁶, 1 K 8³⁸, Is 30²⁹ 66¹⁴). Hence such phrases as 'men of heart' (=men of understanding, Job 34¹⁰, 24, Three⁶⁶; cf. Pr 10¹³, 'void of heart'), 'out of heart' (=forgotten, Ps 31¹³). The heart is also the seat of religious feeling (2 Ch 17⁶, Ps 37²¹, Jer 24⁷ 32⁴⁰, Dt 11¹³, 1 K 8⁶¹, etc.); hence change of heart, a clean heart, or a heart of flesh instead of a heart of stone (Ezk 18³¹ 11¹⁹, Ps 51¹⁰) signifies newness of life and character, and purity of conscience. Most of these usages are found in the NT (cf. Mt 5⁸ 12³⁴ 15¹⁹, Lk 24³², Jn 14¹, Ac 5³³ 8²¹); but St. Paul has particularly developed some of them, and with him the heart is the organ of belief as well as of disobedience and impenitence (Ro 2⁹ 10¹⁰), and the immediate receptacle in human life of God's light and knowledge and love (2 Co 4⁶, Ro 5⁵; cf. Eph 1¹⁸, 'the eyes of your heart being opened'). There also is the indwelling Christ (Eph 3¹⁷). These various usages, whether literal or metaphorical, have passed into religious speech, while in the majority of languages the word 'heart' has most of the meanings ascribed to it in Hebrew.

For the Arab meaning of 'heart' as = 'life,' see ARABS, vol. i. p. 671^b.

Among the Greeks and Romans the heart took the place of the liver as the seat of life, soul, intellect, and emotion. Even Aristotle regards the heart as the centre to which all sensory impressions were transmitted, though Plato assigns the mortal soul which governs the intellect and emotions to the heart, making the brain the seat of the immortal soul, and the liver the seat of the lowest soul and source of sensual desires.¹

Similarly, with the ancient Mexicans the word for 'soul' denoted primarily 'heart.' The heart survived death—not the actual heart, but something within, which caused life and quitted the body at death by the mouth.² The complex psychology of the Chinese assigns many *shen*, or souls, to the various parts of the body; that of the heart is supposed to be in the shape of a red bird.³

The importance of the heart as the seat of life is well illustrated by numerous *Märchen*, like the Norse tale of 'The giant who had no heart in his body,' in which a giant or some other personage secretes his heart, or, in other tales, his life or soul, in some exterior object, and until it is found and destroyed he is deathless.⁴ But it is also illustrated by other tales in which the heart, restored to a dead body, resuscitates it. The oldest of these is the Egyptian story of 'The Two Brothers,' in which Bata hides his heart in a tree. His wife causes the tree to be cut down, and he dies; but his brother, having discovered the heart, makes him swallow it in water, and he revives.⁵ Similar tales are found among the Basutos, Hottentots, Australians, Samoyeds, Hindus, and others; but in the Hottentot instance the heart of the dead

¹ E. Zeller, *Phil. der Griechen*², Leipzig, 1875-81, ii. 2, 483; Plato, *Timæus*, 69 ff.

² E. J. Payne, *Hist. of the New World called America*, Oxford, 1892, i. 468.

³ Crawley, 164.

⁴ G. W. Dasent, *Popular Tales from the Norse*, Edinburgh, 1859, p. 47; J. A. MacCulloch, *CF*, London, 1906, p. 133 ff.

⁵ G. Maspero, *Contes pop. de l'Égypte ancienne*, Paris, 1882, p. 5 ff.

girl increases in size and takes her form.¹ In other folk-tales the heart of a dead person or animal, if eaten or even smelt by a woman, causes conception.

Thus in a S. Slavic tale a youth burns himself. A maiden discovers his heart, smells it, and bears a son.² In a Lithuanian story a hunter finds the heart of a hermit who has burned himself alive, and gives it to his daughter to cook for supper. She eats it herself, and has a son in two hours.³ In another instance it is the heart of a sea-dragon which causes conception.⁴ These stories recall the myth of Zeus, who, having swallowed the heart of Dionysos, begot him again by Semele. In another version the heart was pounded up and drunk by Semele in a potion, whereupon she conceived.⁵

Such a view of the heart as makes it the seat of religious experience, emotion, enlightenment, or Divine indwelling is common to most of the higher religions; while they also regard it as capable, in wicked persons, of being the seat of quite opposite desires and resultant effects. Here, of course, what is a metaphorical use of the word is based on earlier views regarding the physical heart itself. The mingling of the two conceptions is perhaps seen best in Egyptian religion, where the weighing of the heart before the judgment-seat of Osiris decided the fate of the deceased. While it was the heart of the deceased that was weighed, it represented his conduct or his conscience, or his whole ethical outlook and the result of his life. The words of the appeal to the heart not to witness against its owner show clearly the physical basis of the conception (see *ERE* iii. 432^a, v. 478). This two-fold view is also seen in the Brāhmanic discussions on the heart as the seat of Brahman. The city of Brahman is the body; in it is the palace, the small lotus of the heart, and in that palace is the 'small ether.' What exists within that ether is to be sought for, meditated, and understood. This 'ether' is sometimes held to be the soul or the individual self, but the general conclusion is that it is Brahman, present there for the benefit of his devotees. This view is not unlike the Christian conception of the indwelling Christ.⁶

Here also some reference must be made to the Roman Catholic cult of the Sacred Heart of Jesus. This cult, which has stimulated some of the highest devotion of Roman Catholicism, is directed not merely to the physical Heart of Jesus, but to that Heart as representing His whole Person, and symbolizing His infinite love for mankind. The Heart suggests the Love; the Love is centred in the Heart. This form of devotion was at first occasional and sporadic, and passages in the works of St. Bernard and St. Bonaventura point to it as one which they favoured. St. Gertrude († 1302) had a vision in which she seemed to rest her head on the Saviour's wounded side and heard the beating of His heart. This occurred on St. John's day, and she inquired of the saint whether he had experienced this. His reply was that he had, but that the revelation had been held over for later ages.⁷ In the 17th cent. Margaret Mary Alacoque had a similar vision by which Jesus revealed to her the wonders of His love and bade her make them known. Other visions followed, and, being published in the journal of Father de la Colombière in 1684, these experiences became widely known. Meanwhile the devotion had become popular, and in 1693 certain indulgences were granted by the Holy See to Confraternities of the Sacred Heart. In 1765, Clement XIII. permitted the Church in

¹ W. H. I. Bleek, *Reynard the Fox in S. Africa*, London, 1864, p. 60 ff.; *CF*, p. 128 ff.

² *Arch. per lo studio delle trad. pop.*, Palermo, xii. (1893) 276.

³ A. Leskien, *Litauische Volkslieder und Märchen*, Strassburg, 1882, p. 490.

⁴ G. Basile, *Il Pentamerone*, tr. Burton, London, 1893, i. 122.

⁵ Hyginus, *Fab.* 107.

⁶ *SBE* i. (1879) 125 f., xxxiv. (1890) 174, xviii. (1904) 816.

⁷ *Revelationes Gertrudæ*, Paris, 1877.

France to have a Feast with a special Mass and Offices. But it was not till 1856 that this was permitted to the Church as a whole. In 1899 this Feast was made a 'double of the first class.' It is held on the Friday after the octave of Corpus Christi. Many confraternities and even States are devoted to the Sacred Heart, and innumerable churches have been specially dedicated under this title.

The devotion to the Sacred Heart of Mary is of an analogous kind, though in her case the love which is symbolized by the heart is her love to God and to her Son, which this devotion seeks to make the faithful imitate. The cult may also be traced back to the 12th cent., but Papal recognition in a partial form did not occur until 1799. In 1855 an office and mass were appointed by the Congregation of Rites, but these were not imposed on the whole Church, nor has any universal Feast yet been granted.¹

2. Eating the heart.—Since the heart is regarded as the seat of life, soul, and wisdom, as well as of courage and of similar virtues desired by the savage, the heart of a slain man, usually an enemy, is often eaten in order that his life, soul, courage, etc., may pass over into the eater and benefit him. This custom, which is a form of cannibalism (*q.v.*), exists not only where the actual eating of bodies takes place, but also where this wider form of cannibalism does not exist. It is conjoined sometimes with the eating of other parts which are also supposed to contain similar virtues, *e.g.* the liver.

In order to obtain courage the Kamilaroi ate the heart and liver of a brave man.² Among the tribes of N.W. Australia the fat of the heart of great hunters or warriors was eaten in order to acquire their cunning or courage.³ Young men among the Eskimos of Bering Strait, when they kill an enemy for the first time, eat a portion of his heart.⁴ In Africa the custom is universal among the tribes, and always with the same intention, *viz.* to acquire courage or whatever other qualities may be ascribed to the heart. It is unnecessary to give references, since every work on native customs mentions this practice, but a few particular instances of it may be cited (see also *ERE* iii. 198^b). Ashanti medicine-men cut out the hearts of several of the enemy; and these, being mixed with blood and consecrated herbs, were eaten by all who had never killed an enemy before. If they did not eat them, their vigour would be sapped by the ghosts of the slain.⁵ Here, besides the purpose of acquiring courage, referred to by other writers, it is obvious that the eating of the heart, like the possession of an enemy's head (see *HEAD*), gave the eater power over the ghost. A similar reason underlies certain Eskimo customs of eating the heart (see *CANNIBALISM*, vol. iii. p. 200^a). Among the Yoruba the priest of the war-god Ogun took out the hearts of sacrificial victims, dried them, reduced them to powder, and mixed them with rum, and sold them to those who desired courage.⁶ The custom was also wide-spread among the American Indians, and was sometimes associated with sacrifice of a human victim. When the Pawnees made the periodic sacrifice of a Sioux girl, the chief tore out her heart and devoured it.⁷ Here there was doubtless the intention of assimilating whatever peculiar properties the victim was supposed to possess.

Traces of these customs occur in folk-lore. In the *Mabinogion*, Gwyn forced Kyledi to eat his own father's heart; this resulted in the latter's madness.⁸ The Wends believe that the heart of a maiden or infant brewed in herbs will cure disease or inspire love. Hence graves are often violated to obtain the heart of a corpse.⁹ Possibly the old German belief that 'a dying man's heart could pass into a living man, who would then show

¹ See Granger, *Les Archives de la dévotion au Sacré-Cœur de Jésus et au Saint-Cœur de Marie*, Paris, 1892-93; E. Bougaud, *Hist. de la bienheureuse Marguerite Marie*, do. 1880; J. V. Bainvel, *La Dévotion au Sacré-Cœur de Jésus*, do. 1908; *Catholic Encyclopædia*, s.v.

² L. Fison and A. W. Howitt, *Kamilaroi and Kurnai*, Melbourne, 1880, p. 160.

³ Clement, *AE* xvi. [1904] 8.

⁴ *JB RBEW*, pt. i. [1899] p. 328.

⁵ T. E. Bowdich, *Mission from Cape Coast Castle to Ashantee*, London, 1819, p. 300.

⁶ Ellis, *Yoruba-speaking Peoples*, 69.

⁷ de Smet, *Annales de la prop. de la foi*, xv. [1843] 277.

⁸ J. Rhys, *Celtic Heathendom*, London, 1889, p. 561.

⁹ *FLR* iii. [1880] 187.

twice as much pluck,' is derived from this savage custom.¹ The belief that witches removed and ate the hearts of men while still living, thereby causing their death soon after, may also be traced to the same custom.²

The hearts of certain animals are often eaten in order to acquire their strength, courage, cunning, wisdom, etc. Among these the lion, the bear, the leopard, the wolf, and certain birds are the most usual. On the other hand, the hearts of such animals as are timid or slow are carefully avoided, though they may be given unawares to some one whom it is desired to injure. In Africa the heart of the lion is eaten by hunters or given to children so that they may acquire its courage.³ Among the Ainus and other tribes of Northern Asia who sacrifice the bear, its heart is eaten, but the Gilyaks will not allow a woman to taste it.⁴ In ancient times the hearts of such animals or birds as were believed to possess prophetic powers—mole, hawk, crow—were eaten by those who wished to obtain such powers or to have their power of divination increased.⁵ Traces of these customs are also found in Norse saga. Ingjald, until then timid, became very fierce through eating a wolf's heart. Siegfried, having eaten the heart of the dragon Fafnir, understood the language of birds. Wise-women are said to have eaten, as their special food, the hearts of all animals slain.⁶ In Syria and Asia Minor, eating the heart of a live pigeon is a remedy for heart-disease.⁷

3. The heart in sacrificial rites.—The heart, as a vital centre, is often the object of special care in sacrifice, whether of animal or human victims. It is either offered separately, or, having been removed from the body, is offered with it or with selected parts of it. The Ainus, at the sacrifice of the sacred bear, sometimes placed its heart before it to assure it that it was still alive.⁸ Among some of the Veddas, when an animal is killed, its heart is removed, roasted, and offered on a stick to Vedi Yaka, the spirit who is supposed to help them in killing game.⁹ In the island of Sumba the hearts and livers of victims are offered with rice to the ghosts of the dead, and then eaten by the offerers.¹⁰ The ancient Mexicans, when a human victim was offered, usually cut open the breast and tore out the palpitating heart, which was offered either separately or with the body, on the altar of the gods. Among the Egyptians, when the animal victim was slain and cut up, its heart was offered on the altar with the other parts, and the heart as an offering is often depicted on the monuments.¹¹ At the rite of 'Opening the Mouth' in connexion with the ritual of death, a bull was sacrificed, its heart was torn out and offered to the deceased, and then the relatives ate it raw.¹² A curious custom is referred to in a Bab. atonement rite for a sick man. The body of a sucking pig was placed at the patient's head, its heart removed and placed above his heart, apparently as a substitute for it as containing the life—'Give the pig in his stead. . . . Let the heart be as

¹ J. Grimm, *Teut. Myth.*, tr. Stallybrass, London, 1880-88, p. 1548.

² Grimm, 1078 ff.

³ H. Cole, *JAI* xxxii. [1902] 318 (Wagogo); Johnston, *Brit. Cent. Africa*, London, 1897, p. 438; H. Callaway, *Rel. System of the Amazulu*, London, 1884, p. 438.

⁴ B. Scheube, *Mittheil. der deutschen Gesell. bei S. und S. Ostasiens*, xxii. 50; *ARW* viii. [1905] 458.

⁵ Porphyry, *de Abst.* ii. 48; Pliny, *HN* xxx. 19.

⁶ Grimm, 690; L. W. Faraday, *FL* xvii. [1906] 414.

⁷ *FL* xii. [1901] 191.

⁸ H. v. Siebold, *Studien über die Aino*, Berlin, 1881, p. 26.

⁹ O. G. and B. Z. Selligmann, *The Veddas*, Cambridge, 1911, p. 177.

¹⁰ J. G. Frazer, *Adonis*, London, 1906, p. 245.

¹¹ J. G. Wilkinson, *Ancient Egyptians*, London, ed. 1878, ii 458, iii. 410.

¹² Budge, i. 176.

his heart.¹ With regard to sacrificial offerings among the Teutons, Grimm is of opinion that among the nobler parts assigned to the gods the heart was one.² This was also the case among the Romans, with whom the *exta*, the parts burned in fire as an offering to the gods, included the heart.³

Analogous to the separate treatment of the heart in sacrifice is the custom of giving it separate treatment in death and burial rites. The myths of the relics of Osiris—one of these being his heart—buried at different places, the heart at Athribis, may point to some earlier custom of separate heart-burial in Egypt. But the usual custom was to remove the heart and embalm it, placing it in a Canopic vase under the charge of Tuamutef, or binding it on the leg. In order to renew the heart in the future life and provide the *ka* with it, the four chapters of the Book of the Dead were recited and written on amulets, some in the shape of a heart. The 80th chapter was written on a scarab, which was placed over the place of the heart, its words being recited by the deceased at the weighing of the heart. There were also formulæ for recalling the heart or preventing its being stolen.

In Christian custom the separate burial of the heart, sometimes in sacred ground, has now and then occurred. Bruce's heart was intended to be buried in Jerusalem; that of Livingstone was interred under a tree near where he died.

4. The heart in magic.—Like other important parts of the human body, the heart, as a seat of life, gave its form to heart-shaped amulets, which were worn to repel evil influences. This custom already existed among the Etruscans and Romans, many of the *bullæ* having the form of a heart,⁴ and heart amulets are often found in Egyptian graves. Such amulets are still worn in Southern Europe—in Spain, Italy, and Portugal—usually as a charm against the evil eye; and they were also known in Scotland as 'witch-brooches.' Here also the custom of 'casting the heart' was known. On the head of a sick person was placed a sieve with a comb and a pair of scissors set in the form of a cross. On this rested a wooden cup of water, into which molten lead was poured. Search was then made for a heart-shaped fragment, and this, sewn in a piece of cloth, was worn by the patient.⁵ An animal's heart was sometimes carried as an amulet for luck or to ward off evil influences. In Germany it was thought that an owl's heart gave luck in play, while to have a wolf's heart about the person would prevent one's being eaten by a wolf.⁶ In Mossul it was thought that 'the heart of a black cat dried and steeped in honey, and worn either at the beginning of the month or with the waning moon,' would cause the wearer to become invisible.⁷ The famous instance of Tobit (8²⁴) shows that the smoke of the heart and liver of a fish with the ashes of perfumes drives away the evil spirit. In W. Africa, fetishes often contain the heart of an ancestor.⁸

The heart of an animal was also useful to counteract disease or repel the evil influences of witches. In the Highlands, during cattle disease, the heart and part of the liver and lungs of one of the stricken animals were cut out and hung over the fireplace or boiled.⁹ Sometimes, as in Sussex and Germany, the heart of an animal overlooked by a witch was stuck full of pins and roasted. The witch was then visited with misfortune, or, being tortured in the heart, came and confessed.¹⁰ In Dorset a bullock's heart hung in the chimney was supposed to keep off fairies,¹¹ and in Lincoln an

¹ R. C. Thompson, *Semitic Magic*, London, 1908, p. 208.

² *Teut. Myth.* p. 67.

³ G. Wissowa, *Rel. und Kultus der Römer*, Munich, 1902, p. 351.

⁴ Pauly-Wissowa, I. 89.

⁵ *FL* xvii. 464, xx. [1909] 231; W. Gregor, *Notes on the Folk-Lore of the N.E. of Scotland*, London, 1881, p. 43. For a curious piece of symbolic magic in connexion with the heart among the Caddo Indians, see *ERE* iii. 404^a.

⁶ Grimm, 1787, 1810.

⁷ Thompson, lxxvi.

⁸ R. H. Nassau, *Fet. in W. Africa*, London, 1904, p. 82.

⁹ Gregor, 187.

¹⁰ *FL* xx. 65; Grimm, 1824; cf. W. Henderson, *Notes on the Folk-Lore of the N. Counties*, London, 1879, *passim*.

¹¹ *FLJ* vi. [1888] 116.

animal's heart full of pins concealed within the fabric or walls had great protective virtue.¹ In these and similar instances elsewhere, when the heart is stuck full of pins, there is probably also an intention of hurting witches.²

In cases where the image of a victim is made by an evilly-disposed person with a view to causing his hurt or death, the region of the heart is often pierced with a pin, and the victim then feels intense pain at the heart, of which he often dies.³

LITERATURE.—This is cited in the footnotes.

J. A. MACCULLOCH.

HEARTH, HEARTH-GODS.—I. Evolution of the hearth.—A hearth is, technically, 'a piece of floor prepared to receive a fire.'⁴ The Eng. word 'hearth' and its synonyms in other languages are reminiscent of an early stage of culture, of one-roomed houses, in which one fire served for cooking and for warmth. Central in the primitive round-hut, as in the neolithic huts of Italy, it was merely a part of the beaten-earth floor, a depression, or small, shallow pit. In this form the fire-place is an oven, such as is made in camping-grounds to-day by wild peoples. The use of pottery tended to replace this depressed hearth by a level or raised area. Meanwhile the original oven was lined with stone, brick, or tiles. In another development a movable receptacle or firepan was placed in the pit. From this came the brazier or chafing-dish, the portable grate employed for heating purposes, and the stationary grate itself. In early times the sieve-form is often modified for either use. Sieve and grate are ventilated fire-pans, and as such differ from the closed oven. A third development, also denoted by the term 'hearth,' is the plate of tiles or of iron, originally the level area round the fire.⁵ The evolution of heating- and of cooking-apparatus and methods follows these three lines. The closed receptacle has such forms as the porcelain heating-stoves of northern Europe. This method is also that of the plate, and the modern radiator is an extension of the same principle to hot water. Similar was the Roman system of hot air circulating in the hollow brick wall. Cooking follows the two chief methods of the oven and the grill. One of the first developments of domestic architecture involved the removal of the fire to the side-wall or a corner of the room. Later, the multiplication of rooms split up the hearth; the original combined cooking and heating centre remained as the kitchen-fire and oven, a mere 'office,' the social sentiment of the 'fireside' being transferred to the chief of the living-rooms, and later vaguely distributed over the house as a whole.

At that stage of early culture which was marked by the organization of religion, the methods and sentiments of the domestic system were applied to the houses of the gods. The altar of burnt-offering is a magnified kitchen-hearth, the fire-altar a magnified heating brazier, luxury being shown in the scented fumes rather than in the comfort of its warmth.

Among primitive peoples who have not developed the permanent hut, and in their camping-grounds, continually changed, employ a mere shelter or *wurley* (Australian) of brushwood, the pit-oven

¹ *FL* xii. 176.

² Cf. F. T. Elworthy, *The Evil Eye*, London, 1895, p. 53 f.

³ G. L. Gomme, *Ethnol. in Folk-Lore*, London, 1892, p. 51 (Ceylon); *FLJ* ii. 220 (Highlands); Grimm, 1629 (medieval witches).

⁴ R. Sturgis, *Dict. of Architecture and Building*, London, 1901, s.v.

⁵ 'The hearth includes properly the entire floor from the back lining of the fireplace to the outermost edge of the incombustible material. . . . In builder's language the hearth is a slab of stone . . . which is outside the fireplace proper.' On this rest the supports of the mantel (which is derivable from the louver [see below]), the fender, and the fire-irons. This latter meaning is the popular modern connotation of 'hearth,' as distinguished from fireplace (Sturgis, s.v.).

and the camp-fire are distinct. The camp-fire here has the associations of the 'fireside'; the natives sleep close to it, and spend hours talking together in the warm sphere of its influence. The embers are carefully guarded from extinction during the day. But, as the civilized hearth was for ages a combination of cooking-stove and heating-apparatus, and its form is evolved from the primitive oven, it is necessary to describe the latter.

To make his cooking-oven, the Australian native digs a hole in the ground, and makes in it a fire of wood. When this is burning well, stones are placed on it. The moment these are red-hot, the food to be cooked is placed on them; green leaves are used to prevent scorching. Grass is spread over the food, and water sprinkled. The mass is then tightly covered with earth.¹ Throughout the South Seas this method is universal; in many cases the oven is permanent, and generally is of a more elaborate character than the Australian. The pit is about 2 feet in diameter, and varies from 6 inches to a foot in depth. Its walls and floor are beaten hard; in clay soil the texture soon becomes that of burnt brick. Charcoal as well as wood is used for the fire. Stones of the size of the fist are placed in a layer above the fire. When they are red-hot, the woman-cook removes them and clears the embers out of the oven, in which the stones are now placed. A layer of green leaves on the stones is sprinkled with water; green leaves are also placed round the sides of the oven. The food being put in, mats are laid upon it; earth covers these, and is well pressed and beaten to prevent any escape of steam.² The principle is a sort of dry boiling.

The stage at which a fire-receptacle is placed in the hearth-pit may be illustrated by the modern Bedawin. The oven is a vessel sunk in the ground, above which is an iron plate, the *tajen*, 'hearth.' This is specially employed for baking bread. The hot-stone method also is used for cooking various food-stuffs. Both methods are common throughout the East.³

The ancient Hebrews used the hearth-pit both for cooking and for warmth. Like the fire-place still used by many of the poor in Eastern Asia, it was in the centre of the one-roomed house, and its smoke escaped through an opening in the roof. This method may be regarded as practically universal at a certain stage of culture. Early Greece and early Italy possessed it. The *atrium* of the Italians was originally dining-room and kitchen in one; it was developed from the neolithic round-hut. The early Greek *μέγαρον*, or one-roomed house, which later was the hall, had the *έστια* or *έσχαδα* in the centre of the floor. When the *παράς* took the place of the *μέγαρον*, the *έστια* was possibly retained there, or may have been transferred to the dining-room, *άνδρων*, since food-offerings were placed in it before meals.⁴ In the same way the Italian *atrium* lost both of its functions: the kitchen, *culina*, received the cooking-fire; the living-rooms were warmed by braziers, *foculi*,⁵ until the hypocaust system was introduced. The sacred associations of the *focus* were preserved in the lamp which always burned before the Lares, whose original place was on the hearth. A niche

¹ K. L. Parker, *The Euahlayi Tribe*, London, 1905, p. 116.

² R. Taylor, *Te Ika a Maui*, London, 1870, p. 389 f.; G. Turner, *Samoa*, do. 1884, p. 195.

³ J. L. Burckhardt, *Notes on the Bedouins and Wahabys*, London, 1830, l. 58; O. Landberg, *Proverbes et dictons du peuple arabe*, Leyden, 1883, pp. 73 f., 455 (gives a good description of a modern Syrian hearth); Hughes, *DI*, London, 1895, p. 179.

⁴ L. Whibley, *Companion to Greek Studies*, London, 1905, p. 553.

⁵ The modern four-legged dishes for keeping food warm on the table reproduce in form the ancient *foculus*, which was also used for the purpose. Bronze *foculi* were found in great numbers at Pompeii.

was often retained for them by the side of the kitchen hearth. Both Greek and Latin houses of the well-to-do in the most highly developed periods possessed private chapels. Possibly this was, in some Greek instances, a room of the *θόλος* type. This was not the case with the Roman *lararium*. The developed kitchen fire-place was a structure of masonry or brick, a foot above the floor. But it still retained the primitive fire-pit character, since a rim of masonry converted it into a receptacle. An arched opening at one side served as a 'tender' for fuel.¹

In Teutonic lands the central hearth of the one-roomed house lasted among the poor into the later Middle Ages. Its previous universal employment cannot be understood unless we take into account the large size of the central hall in the houses of the well-to-do. The differentiation of the one house-fire into hall-fire and kitchen-fire was here of early date. The introduction of the chimney involved the change of position to the side-wall of the room. Till the 16th cent. the fire-place was built without a recess; a hood, or louver, above the hearth and containing the entrance of the flue, solved the problem of smoke.² The large recess admitted of a semi-circular gathering round the fire (the primitive gathering round the central hearth was circular), and such pieces of furniture as the 'settle' assisted the 'fireside' sentiment, as they ministered to the comfort of the hearth.

The evolution of the fire-place among the Hebrews was similar to that among the Greeks and Latins. The fire proper was relegated to the kitchen. In the houses of the rich the brazier or chafing dish was used for warmth.³

The Hindus have preserved longest the combination of kitchen and dining-room⁴—a fact ultimately not unconnected with the climatic conditions of India. The portable clay fire-pan is the eastern brazier. The kitchen is divided into two unequal parts, the smaller serving for the culinary operations.⁵

2. The hearth in religion.—The conception of the hearth as the centre of the house and home lends itself to metaphor. A remarkable case is the employment in the modern science of optics of the Latin word for a 'hearth,' *focus*, to denote the central point at which rays of light converge. The use of the term as a verbal 'focus' for sentiments of domesticity and family solidarity is notable in the Latin phrase *pro aris et focis*. In English 'hearth and home' is representative of what is perhaps the strongest example of the association. 'Hearth' was also a synonym for 'home.'

Hearth-cults emphasize in some cases the combination of fire-place and fire, in others the fire, in others again the figures of divine beings brought into connexion with the hearth. Among the latter, the sacredness of both components is derived from ideas of family life. They thus appropriately meet at its material centre.

The original connotation of the Greek term *έστια* seems to have been the hearth with its fire. (See the 'Greek' article below.)

The worship of Vesta by the Romans was purely public. It has the look of a revival from a Græco-Italic cult, if the goddess was not actually borrowed from Greece. (See the 'Roman' article below.)

The Scythians honoured Hestia, whom they called *Ταβίρι*, as chief of all deities (Herod. iv. 59).

In Indo-Iranian cultus the sacred fire assumes greater importance than the hearth or altar, so far as personalization is concerned. But the receptacle is sacred. Sacredness also attaches to the house-fire and cooking-apparatus of the modern Hindu

¹ R. Sturgis, *loc. cit.*

² Jer 36²², Zec 1²⁶, Jn 18¹⁸ 21⁹.

³ J. E. Padfield, *The Hindu at Home*, Madras, 1896, p. 18.

⁴ *Ib.* 44.

⁵ *Ib.*

(see FOOD), whose kitchen is usually his dining-room. Orthodox Brāhmins still maintain a special room for fire-sacrifices, the *homa-sālā*, on the ground-floor. Ancient custom distinguished two degrees of piety, the one being represented by the *homa-sālā*. In ordinary circumstances the 'householder' was satisfied with a single hearth of burnt clay for his sacrifices. This was the *grihyāgni*, 'household fire.' Its close connexion with family sentiment is shown by the important part it played in marriage-ceremonial. The details show its connexion with the preparation of food, and, generally, with the well-being of the future family. The sacred fire was kindled for the marriage-ceremony by friction of the sacred *arāni* wood. West of it were placed the millstones for corn-grinding, and a set of the indispensable condiments. At its north-east was a water-jar. The groom led the bride round the fire and the water, saying, 'I am male, thou art female; come, let us marry.' At each circuit she stepped upon the stones. *Ghī* was offered in the fire. Various ceremonial 'steps' for various forms of well-being were taken by the bride, in auspicious directions. The fire was taken by the young couple to their new home, and installed in a special room. No one might breathe upon it; nothing impure was thrown into it; and it was never used for warming the feet. This fire and room were sufficient for ordinary domestic ceremonies during life. The Vedic ceremonies, *śrauta-karman*, called for the *homa-sālā*. Three differently shaped hearths or fire-pans, *ukhā*, were here required. The erection of any fire-altar was *Agni-karman*. The three hearths were the *gārhapatya*, the *āhavanīya*, and the *dakṣiṇa*, the fire in each having a different name. The primitive pit appears here; in it the *ukhā* was placed. The *gārhapatya* is a term applied to the ordinary householder's single hearth. It was built of bricks, laid according to the way of the sun, the *deasil* of Celtic custom. Eight bricks were laid in a cruciform formation within a circle. The *Satapatha-Brāhmaṇa* gives elaborate details. The clay was bound together with resin and goat's hair. A lotus leaf was a frequent ornament of the centre of the *ukhā*. The symbolism was equally recondite, and curiously echoes that of the fire-sticks. The receptacle is female, the fire male. The *ukhā* is a womb. *Prajāpati* was poured into it, as seed. The *gārhapatya* corresponds to the world; it is the hearth of the ordinary man. The *āhavanīya* corresponds to the sky, the *dakṣiṇa* to the air. The sacred fire was a symbol of present divinity, of 'God with us,' the 'brilliant guest' in the heart of the family. Morning and evening the household worshipped round it, feeding it with consecrated chips of *samidh*, sacred wood, from the *palāsa* tree, and sharing a ceremonial meal of rice and *ghī* with it. This is the *homa-sacrifice*. The fire had to be kept burning always. The theory was that the flames which witnessed the union of man and wife should also light the pyre for the burning of their bodies after death.¹

The Zoroastrian religion consecrated both the public fire-altar and the domestic hearth. Still, wherever Parsis are found, an everlasting fire, the *Bahrām* fire, is maintained 'by a more than Vestal care.' It is fed with perfumes and perfumed wood. To extinguish it is a mortal sin. The spreading of its flames slays thousands of demons, as *Bahrām* slays them in Heaven. If it should be put to profane uses, it must be taken for rehabilitation to 'the Right Place of the Fire,' *dāityō gātu*.²

If in Zoroastrianism fire overshadowed in de-

¹ *SBE* xii. [1882] 6, xxvi. [1895] 148, xxxviii. [1896] 261, xii. [1894] 229, 244, 298, 302, 316, 320, xliii. [1897] pp. xiii, xx, 143 ff., 341; Monier-Williams, *Brāhmanism and Hindūism*⁴, London, 1891, pp. 363-366.

² *SBE* iv. [1895] p. lxxvi.

velopment the hearth, in Teutonic belief and custom religion has been overshadowed by domestic sentiment. In early times the roof-tree had almost the sacred characteristics of Vesta's laurel at Rome. Grimm compares with the *lar* and *penas* the *hūsing* or *stetigot*, a sprite that dwells beneath the hearth, and is seen issuing thence by the peasants' imagination.¹ The repeatedly recurring notion that the spirits of the dead dwell beneath the hearth may be attributed to its central position in the primitive dwelling, and to its being sunk in the ground. In Homeric religion, communication is made with the under world by digging pits, as with the upper world by raising altars. Thus the two forms of hearth, the fire-pit and the raised fire-place, not only serve as centres of family worship and of public cultus, but bring together the gods above and the gods below, after differentiating them.

Among the Damaras (Ovaherero) of South Africa there was a remarkable cult of the hearth.

'The chief's daughter,' says Andersson, 'is to the Damaras what the Vestal was amongst the ancient Romans, for, besides attending to the sacrifices, it is her duty to keep up "the holy fire." Outside the chief's hut, where he is accustomed to sit in the daytime, a fire is always kept burning; but, in case of rain or bad weather, it is transferred to the hut of the priestess [*sic*; this is the chief's hut], who, should it be deemed advisable to change the site of the village, precedes the oxen with a portion of this consecrated fire, every possible care being taken to prevent it being extinguished. . . . A portion of such fire is also given to the headman of a kraal when about to remove from that of the chief. The duties of a Vestal then devolve on the daughter of the emigrant.'²

The girl is probably the daughter of the chief's favourite wife. Later accounts supplement this, while correcting it. The residence of the chief is the *otyizero*, the 'holy house,' corresponding to the fetish-houses of West Africa. In front of this is kept perpetually burning the *okuruo*, 'holy fire.' A usual phrase, corresponding to the Greek *εστία*, is 'the place of the holy fire.' The fire is made by means of two sticks (see art. FIRE, FIRE-GODS), the one of which is the *ondume*, and the other the *otyiza*. The *ondume* represents the *omkuru*, 'ancestor deity'; the *otyiza* his wife. The symbolism of male and female is as marked here as in the Aryan *arāni* sticks. When a death has occurred, the soul of the dead is vaguely identified with 'the ancestor deity.' We might put it that his personality is merged in the *omkuru*; thus a series of ancestors may be regarded as one individual. The 'embodiment' of the dead man's soul in the fire-stick is equally vague, but really believed, just as is the embodiment in snakes which belongs to the creed of the Kaffirs. The *otyizero* is technically the principal house of the chief. The chief's eldest unmarried daughter, *omuatye ondangere*, has charge of the sacred fire, which must never be allowed to go out. She officiates in certain social ceremonies like a priestess. The chief himself is similarly a priest for his people. Her popular name is 'the big girl'; another title is 'Favourite.' With the ashes of the sacred fire she or her mother, 'the big woman,' paints the faces of the warriors before they set out on expeditions. Near the sacred fire is a stone seat for the use of the chief and the medicine-man. Often there is more than one holy fire in a village. Every head of a household also possesses one, at which he performs the ceremony of naming his children. This may also be performed at the *otyizero*. The child is perhaps 'introduced' to the *omkuru*. The father takes it in his arms and announces the name. For the ceremony of circumcision, performed between the ages of 4 and 7, the meat (which is holy, *zera*) is cooked at 'the place of the holy fire.' A portion of it is kept in the holy house for some weeks. Ap-

¹ J. Grimm, *Teutonic Mythology* (tr. Stallybrass), London, 1890-88, ii. 456, 500.

² C. J. Andersson, *Lake Ngami*, London, 1856, p. 223 f.; G. Fritsch, *Die Eingeborenen Süd-Afrika's*, Breslau, 1872, p. 232 f.

parently this is an offering to the *omkuru*; at the end it is eaten by the chief ceremonially. All the meat at the circumcision ceremony is presented to the *osondume*, the fire-sticks representing the ancestor and his wife, that they may 'consecrate it without tasting'—the ceremony of *tova*. The ceremony of mutilation of the teeth, which is performed when a boy is 8 or 10, takes place in front of the holy hearth. The ceremony of anointing and dressing the bride for the bridal feast is also performed here, and the meat to be eaten is consecrated, as before, at the place of the holy fire. When the husband has brought his bride to his own village, he and she go through ceremonies at his native *okuruo*. Sick persons are carried to the *okuruo*. A prayer is chanted to the *omkuru*: 'See, Father, we have come here, with this sick man to you, that he may soon recover.' Meanwhile meat cooked on the holy fire is carried round and round the patient. When death occurs in a *werft*, the inmates desert it for a time, after burying the dead within it. When they return in due time to rebuild on the old site, the ceremony of 'approaching the ancestor deities' is performed, as is also the case with the place of the holy fire belonging to the chief, in times of drought, or war, or pestilence. The holy fire of the *werft* which they have now deserted is extinguished. No brand of it is taken; the fire in the new *werft* on the old site must be made 'from the *omkuru*,' i.e. with the *ondume* and the *otyiza*. On arriving they make the lamentation for the dead, and exclaim: 'See, Father, we are here!' The dead man is now the *omkuru*. New fire is then made on the holy place, and a sheep is slaughtered near it. This is termed 'the sheep of the holy fire,' and persons of all ages and of both sexes are allowed to eat of it. Meat is consecrated and placed on the grave. The medicine-men take the opportunity of knocking on the floor to elicit information as to the future from the *omkuru*. The ceremony is termed *ondyamberero* or *okuyambera*, 'approach to the deities.'¹

The connexion of the hearth with ancestor-worship is natural and inevitable. It is found in China.² According to the Taoist books, there is a Spirit of the Hearth, who periodically reports to Heaven all ill deeds of the household. Here, too, is found the tabu against stepping over sacred objects. To stride over food or the hearth is a sin.³ The figure of an ancestor is carved on the pillar of the Maori fire-place.⁴ It is suggested that the Latin male divinity of the hearth may have been an ancestor.⁵ In Borneo the hearth of the Bahau chief is 'sacred to spirits.' From it each householder takes a morsel of earth to build his own hearth, and lights from its flames the first fire in his new home.⁶ In Russian folklore the hearth has its connexion with the family ancestors.⁷ The Southern Slavs believe that the extinction of the fire on the hearth means the extinction of the family.⁸ This people, like the Hindus, make the family-hearth play a conspicuous part in such family ceremonies as marriage.⁹ The Lithuanians possessed a 'domestic god,' *Dinstipan*, who directed the smoke up the chimney.¹⁰

The common family-rite of flinging portions of the family-meal into the hearth-fire is probably an act of ancestor-worship. This 'worship' may

¹ Viehe and Palgrave, in *S. Afr. FLJ*, Capetown, 1879, l. 40-44, 48 ff., 59 ff., 62 f.; E. Dannert, *ib.* ii. 61, 66 f.; H. Beiderbecke, *ib.* ii. 83 f.

² Farnell, *CGS* v. [1909] 354. ³ *SBE* xl. [1891] 236, 243.

⁴ Frazer, in *JPh* xiv. [1885] 168. ⁵ Farnell, v. 360.

⁶ Nieuwenhuis, quoted by Farnell, v. 354.

⁷ W. Ralston, *Songs of the Russ. People*, London, 1872, p. 84.

⁸ F. S. Krauss, *Sitte und Brauch der Südslaven*, Vienna, 1885, p. 592.

⁹ *ib.* 386, 399 f., 430 f.

¹⁰ G. L. Gomme, *Folklore Relics of Early Village Life*, London, 1883, p. 90.

exist without ever being formulated into a cult; it is a testimony, in all its stages, to the central importance of the family in human life and society. The connexion of the hearth with both sentiment and cult is to be regarded as an irreducible psychological association. To name a few cases of the offering to the hearth—it is found among the ancient Greeks, Latins, and Slavs, the Mexicans, and the Hindus.¹ The principle followed by the last-mentioned people is

'that before a man begins eating he ought to consecrate and purify his food by making offerings of small portions of cooked rice and other food to all the deities through whose favour he is himself fed, and more especially to Fire, who is the bearer of the offering to heaven . . . the whole ceremony resolves itself into a form of homage offered to the gods who give the food, and to the god of fire without whose aid this food could not be prepared for cooking.'

In this *Vaiśvadeva* ceremony, Vedic gods are worshipped, chief among them being Agni, the fire-god. The cooked food, *siddhānna*, is cast into the fire, as the worshipper prays, 'for the purification of that food and for my own purification, and to make expiation for the five destructive domestic implements (*pañchāsunā*), and to obtain the reward prescribed by the *Śruti*, *Smṛti*, and *Purānas*.' The movable fire-pan, *ukhā*, is employed, and a particular form of sacred fire, viz. *rukṃaka* (bright as gold), is placed in it. Consecrated fuel is put on, and the fire is fanned. Then the fragrant sandal, *vilepana*, is flung into the fire, also flowers, as offerings to Agni. A portion of cooked rice, about a mouthful, is next offered to all the gods in turn. Lastly, ashes from the fire, *vibhūti-grahaṇa*, are taken in a deep-bowled spoon, *darvi*, and are applied with the finger to various parts of the body, with a prayer to Śiva; and, with the prayer, 'May I enjoy the triple life, *tryāyusam*, of *Jama-dagni*, of *Kaśyapa*, of *Agastya*, of the gods; may I altogether live for a hundred years,' the ashes are applied to the neck, navel, shoulders, and head.² The Hindu cult has followed a special line of development: ancestor-worship is merged in polytheism; hearth-worship is differentiated into polytheistic burnt-offering and fire-worship. But the idea of a central family-rite remains.

In the theory of sacrifice, enough has not been made of the fact that the altar is technically and in principle a hearth. This was recognized clearly by the Greeks (*εσχάρα* = *βωμός*) and the Hebrews. The top of the Hebrew altar of burnt-offering was its 'hearth.'³ The altar, in short, is the combined fire and cooking-place of the people's representatives. There was thus brought into the great sacrificial religions the idea that the people, and later the human race, are one great family. The Greek notion of a hearth centrally placed in the universe has been referred to. The Hebrews applied to Jerusalem the mystical title of *Ariel*, 'the hearth of God.'⁴ The Hindus represented the fire-altar as symbolical of the Universe.⁵

LITERATURE.—This is fully given in the footnotes.

A. E. CRAWLEY.

HEARTH, HEARTH-GODS (Greek).—The reverence paid by the Greeks to the hearth (*εστία*) appears from its personification in the goddess Hestia, who is first mentioned in Hesiod (*Theog.* 454) and the Homeric hymns (*Aphr.* 21 f., and *Hymns* xxiv. and xxix.). In each Greek city the town-hall, or *prytaneum* (originally the king's house), was sacred to Hestia, and a perpetual fire was maintained on the 'common hearth.' The custom of preserving a sacred fire in a chief's house is wide-spread (see Frazer, in *JPh* xiv. 145 f., and *GB*², 'Magic Art,' vol. ii. ch. 17); and in Greece,

¹ Frazer, in *JPh* xiv. 164; Monier-Williams, *Religious Life and Thought in India*, London, 1883, p. 416 f.

² Monier-Williams, *Brāhmanism and Hindūism*, 417-421.

³ *Lv* 69, Sir 501².

⁴ *Is* 29¹⁴; see A. R. S. Kennedy, in *HDB*, s.v. 'Hearth.'

⁵ *SBE* xliii. p. xix f.

as at Rome and elsewhere, it probably originated from the practical difficulty of re-kindling fire by the primitive method of rubbing two sticks together (see FIRE). It has also been suggested that the maintenance of the sun's heat was associated with the upkeep of a perpetual fire on earth; if the flame was extinguished, the sun might fail (A. B. Cook, in *FL* xv. [1904] 308 f.). In any case the custom must have become a religious duty at an early period. At Athens and Delphi, if the sacred fire was extinguished, it was re-kindled from the sun's rays (Plut. *Numa*, 9). The fires on the common hearths of these two cities were tended by widows, who corresponded to the Vestals at Rome; but there was never a religious order of Vestals in Greece, and the great importance of these virgins has no analogy in Greek religion. The virginity of Hestia herself is, however, a noticeable feature in ritual and myth. The goddess took a vow of perpetual chastity (Homer, *Hymn to Aphr.* 21 f.), and sexual intercourse was forbidden in front of the hearth in private houses (Hes. *Op.* 733). At Sparta there was a priestess called *Ἑστία πύλαις* after the goddess (*CIG* i. 1253, etc.); but generally the public worship of Hestia was in the hands of men (cf. Aristotle, *Pol.* 1322b). In some cities the hearth-fire in the *prytaneum* seems to have given place to a lamp (Theocr. *xxi.* 36; Athenæus 700 D); otherwise (as at Elis [Paus. v. 15. 9]) the ancient form of the hearth was retained. Certain hearths were of importance beyond the limits of the particular State, e.g. at Delphi and Delos. After the battle of Plataea the Delphic oracle commanded that all fires, as being polluted by barbarians, should be extinguished in the country, and new fire brought from the common hearth at Delphi (Plut. *Arist.* 20). From Delos sacred fire was brought every year to Lemnos, all fires in that island being extinguished for nine days during the voyage of the vessel (Preller-Robert, i. 179, 426). When a colony was founded, it was supplied with fire from the common hearth of its mother-city (Herod. i. 146; schol. on Aristides, iii. 48. 8 [Dindorf]; *Et. Magn.* p. 694. 28 [Gaisford]; Aristoph. *Av.* 43, where fire for a new city is carried in earthen vessels). The custom has savage parallels (see Frazer, *op. cit.* 215 f.). It is probable that, in imitation of this practice, the fire of a new house was lighted by the mother of a bride from the parental hearth; but this is only a conjecture (see Gomperz, *Greek Thinkers*, Eng. tr., London, 1901, i. 117).

While the maintenance of perpetual fire on the public hearth is proved, it is doubtful whether the same custom prevailed in private Greek houses. Frazer admits that direct proofs are wanting for ancient Greece, but quotes many instances, both in Europe and in other parts of the world, in which private householders keep a fire always burning on their hearths. In modern Greek houses the lamps before the sacred icons are never allowed to be extinguished; and this may well be a survival from pre-Christian times. Artemidorus (*Oneirocr.* ii. 10) considers it a bad omen to dream of putting out the hearth-fires; but this need not imply that the fire was never suffered to die of its own accord. A Homeric hymn to Hestia (xxix.) addresses the goddess as one who has an eternal seat in the houses of god and men; but this passage must not be pressed too far. Preuner (in Roscher, i. 2609) thinks the custom improbable, owing to the lack of evidence which would probably have been forthcoming, as for the public hearth. In any case, great sanctity was attached to the private hearth from the earliest times. Even in Homer (although the personification of the Hearth-goddess is later) an oath taken in the name of the hearth was of peculiar force (cf. *Od.* xiv. 159, etc.). In

later times such an oath was common, especially when the interests of the family were concerned (see Jebb on Soph. *El.* 881; Roscher, i. 2623). Prayer was also offered to the hearth (or to Hestia) on solemn occasions, as on returning home after long absence (cf. Eur. *Herc. Fur.* 599), or when death was imminent (Eur. *Alc.* 162 f.). The Orphics prayed to Hestia for health and wealth, and for all moral or material well-being (*Orph. Hymn* lxxxiv.). The first libation of wine was regularly offered to Hestia in public and private feasts; hence the proverb *ἀφ' Ἑστίας ἀρχεσθαι*. So, at Olympia, the first sacrifice was in honour of Hestia, who took precedence even of Olympian Zeus (Paus. v. 14. 5). In public sacrificial feasts the last as well as the first libation seems to have been poured to the goddess (Homer. *Hymn* xxix. 4; Cornutus, *de Nat. Deor.* 28). For other details of sacrifice, see Preuner, in Roscher, i. 2617.

In private life the hearth was the centre of the family. In Attica, a child when five days old was carried by persons who ran round the hearth. At this festival, which was called Amphidromia, the child received its name (see Aristoph. *Lys.* 757; schol. on Plato, *Theæt.* 160 E; S. Reinach, *Cultes, mythes, et religions*, i. [Paris, 1905] 137; *ERE* ii. 648^b). On the meaning of *ταῖς δ' ἀφ' Ἑστίας* in the Eleusinian Mysteries, see Farnell, *CGS* iii. [1907] 164.

Perhaps the chief importance of the hearth, both public and private, lay in the fact that it was an asylum of refuge. A suppliant who entered the house of another and sat at his hearth could claim protection (cf. Herod. i. 35; Æsch. *Ag.* 1587; Pind. *fr.* 49; Soph. *Oed. Col.* 633; Eur. *Herc. Fur.* 715; and Thuc. i. 136, where Themistocles obtained protection, even from an enemy, by sitting at the hearth of Admetus, king of the Molossians, and taking the child of Admetus in his arms). Sometimes, however, the rights of asylum were violated; Theramenes was dragged from the hearth in the Athenian senate-house, at which he had taken refuge (Xen. *Hellen.* ii. 3. 52).

As the earth was commonly held to be the centre of the universe, we find that poets and philosophers identified the Earth-goddess with Hestia, the centre of the home (Preller-Robert, i. 427; J. E. Harrison, in *JHS* xix. [1899] 243). Just as there was no statue of Vesta in the temple at Rome, even in the time of Augustus, so in early times the Greeks had no image of Hestia; the hearth, with its fire, was itself worshipped. Later, at Athens, there was an image of Hestia in the *prytaneum* (Paus. i. 18. 3), but evidence for other cities is lacking. Pausanias notes (ii. 35. 1) that there was no image of Hestia in her temple at Hermione; sacrifice was made on an altar. Temples of the goddess were rare, as her chief sanctuary was the *prytaneum* of a Greek city.

In general art the Hearth-goddess was represented under the form of a woman either seated or standing in a restful position, appropriate to a deity who, in Plato's myth, alone never leaves the house of the gods (*Phædr.* 246). The Greeks themselves derived her name from *ἔσθαι* ('sit'), though it is certainly cognate with *Vesta*, and may mean the 'bright' or 'shining' fire (Skr. *vas-*).

LITERATURE.—Preller-Robert, *Gr. Mythologie* 4, Berlin, 1887-1894, i. 422 f.; J. G. Frazer, 'The Prytaneum, the Temple of Vesta, the Vestals, Perpetual Fires,' in *JPh* xiv. [1886] 145 ff.; N. D. Fustel de Coulanges, *La Cité antique* 18, Paris, 1890, ch. iii.; A. Preuner, *Hestia-Vesta*, Tübingen, 1864 (valuable mainly for the facts), and his article in Roscher, i. 2605 ff.; O. Gruppe, in I. von Müller's *Handbuch der klass. Altertumswissenschaft*, 29th half-vol., Munich, 1906, p. 1401 f.; J. G. Frazer, *GB* 2, pt. i. 'Magic Art,' London, 1911, vol. ii. chs. 14-17.

E. E. SIKES.

HEARTH, HEARTH-GODS (Roman).—The fire-place, hearth, or *focus* was originally the centre of the Roman dwelling-house, both in a literal and in a figurative sense, and was situated in the pos-

terior portion of the *atrium*,¹ which served generally as a parlour and a public room,² and was so named because its roof was blackened by the smoke rising from the hearth-fire.³ In this chamber the inmates of the house took their meals, sitting at long tables,⁴ as was the practice also in rural districts at a later period,⁵ and portions of the food were cast upon the fire as oblations.⁶ In later times the scraps that fell to the floor were similarly disposed of,⁷ or were set in little pans (*patellæ*) upon the hearth.⁸ In the house, accordingly, the hearth supplied in every respect the place of the altar, and the frequently recurring phrase *aræ focique*⁹ embraces the whole sphere of *sacra publica privataque*. The importance of the hearth as the religious centre of the house appears very prominently in the ceremonial of marriage. Thus the bridal torch was kindled at the hearth-fire of the bride's home,¹⁰ and the bride herself was received by the bridegroom with a torch lit at his own hearth,¹¹ while, again, the young wife had to lay an *as* upon her husband's hearth as a sacrificial gift,¹² thereby, so to speak, purchasing a share in the religious fellowship of her new home.¹³ As mistress of the house it was her special task to keep the hearth clean, and to deck it with garlands at the Kalends, Nones, and Ides—duties which in her absence devolved upon the stewardess (*vilica*) as her representative.¹⁴

The fact that the hearth was the shrine of the household gods, ancient and modern writers, proceeding upon the assumed identity of these with the ancestral spirits, have sought to explain by the hypothesis that in primitive times the dead were interred within the house, just beside the hearth.¹⁵ We have, however, no evidence that this was ever the practice in Rome; the reference of Serv. *Æn.* v. 64, vi. 152, 'apud maiores . . . omnes in suis domibus sepeliebantur,' is intended simply to justify the worship of the household Lares and Penates, and is thus obviously a mere theory, which the laying open of the ancient cemeteries in the Forum and on the Esquiline has in no way confirmed.

The household deities worshipped at the hearth all bear in common the name *di penates*.¹⁶ The term *penates* is derived from *penus*, the store-room off the *atrium* and close to the hearth;¹⁷ the contents of this chamber were guarded by the Penates, who in this way guaranteed the continued existence of the house. Among the Penates the chief place is held by Vesta, who is simply a divine personification of the hearth-fire,¹⁸ and, in fact, her

¹ Varro, *ap. Non.* p. 55: 'in postica parte [atrii]'; hence Verg. *Æn.* v. 660: 'foci penetrales.'

² Ovid, *Fasti*, vi. 301 f.: 'focus . . . qui tamen in primis aedibus ante fuit.'

³ Serv. *Æn.* l. 726.

⁴ Ovid, *Fasti*, vi. 305 f.: 'ante focos olim longis considere scamnis mos erat et cenæ credere adesse deos.'

⁵ Hor. *Sat.* ii. vi. 66; Colum. xi. 1. 19: 'consuescatque rusticos circa Larem domini focumque familiarem semper epulari.'

⁶ Serv. *Æn.* l. 730: 'quoad ea, quae de cena libata fuerant, ad focum ferrentur et in ignem darentur.'

⁷ Plin. *HN* xxviii. 27.

⁸ Pera. iii. 26: 'cultrixque foci secunda patella'; Varro, *Sat. Menipp.* fr. 265 [Buecheler]: 'quocirca oportet bonum civem legibus parere, deos colere, in patellam dare $\mu\epsilon\pi\alpha\delta\epsilon\nu$ $\kappa\rho\iota\alpha\varsigma$, etc.'

⁹ Found first in Plaut. *Amph.* 225 f.: 'victi . . . urbem agrum aras focos seque uti dederent.'

¹⁰ Varro, *ap. Non.* p. 112: 'cum a nova nupta ignis in face afferretur e foco eius sumptus.'

¹¹ *Id.* p. 302; on the custom of 'aqua et igni accipere,' cf. E. Samter, *Familienfeste der Griechen u. Römer*, Berlin, 1901, p. 14 ff.

¹² Varro, *ap. Non.* p. 531.

¹³ Samter, *op. cit.* p. 19 ff.

¹⁴ Cato, *de Agri Cult.* cxliii. 2.

¹⁵ As regards Greece, cf., e.g., E. Rohde, *Psyche*, Tübingen, 1894, p. 210, n. 3.

¹⁶ Serv. *Æn.* xl. 211: 'cum focus ara sit deorum penatium'; cf. iii. 176.

¹⁷ Varro, *de Ling. Lat.* v. 162.

¹⁸ Cic. *de Nat. Deor.* ii. 68: 'vis autem eius [Vestae] ad aras et focos pertinet'; Non. p. 53: 'Vestae hoc est arae et foci'; Ovid, *Fasti*, vi. 291; Firmicus Maternus, *de Err. Prof.*

name is actually used metonymically as equivalent to *focus* or *ignis*.¹ But, in addition to Vesta, all the deities regarded by a particular household as the special guardians of its fortunes were worshipped as Penates; and the wall-paintings and bronze figurines of Pompeian domestic chapels show that in later times such homage was very frequently accorded to Juppiter, Fortuna, Hercules, Mercury, etc. Originally, however, the term *Penates* was not used with reference to particular divine personages at all, but was applied quite generally to all the tutelary *numina* of the household. This more primitive conception still survived in the State worship of the gods at a later day; thus the circular temple of 'Vesta publica populi Romani Quiritium' in the Forum did not contain images of the gods, but enclosed only the sacred fire of the national *focus*, and the *penus* attached to it; here, in fact, the national worship of Vesta and the Penates always remained an imageless cult.

Like the national worship in the temple of Vesta, the cult associated with the domestic hearth was at the outset also confined to Vesta and the Penates. It was only at a later period that the worship of the Lares became incorporated with the domestic hearth-cult. The worship of the *Lar familiaris*, originally localized at the *compita* (cf. art. CROSS-ROADS [Rom.], vol. iv. p. 335 f.), was gradually—and in reality for the sake of the household slaves, who had a strong interest in the cult of the Lares²—allowed a place beside that of Vesta and the Penates at the domestic hearth. Hence in Plautus³ the treasure entrusted to the keeping of the *Lar familiaris* is buried 'in medio foco'; and, later, people even spoke of the 'focus Larum,'⁴ while the food that was formerly presented to the Penates came at length to be offered to the Lares.⁵ In the re-organization of the Lar-cult by Augustus⁶ the tutelary spirit (*Genius*) of the master of the house was also added to this group, and in the wall-paintings of Pompeii we see the figure of the *Genius* standing between the two Lares and conjoined with Vesta and the Penates.⁷ By this time, however, the hearth had long been removed from the *atrium* and placed in a separate room for cooking in the rear portion of the house;⁸ the shrine of the household deities (often called *lararium*)⁹ was in some cases transferred with it to the kitchen,¹⁰ while sometimes it was still retained in the *atrium*,¹¹ or else placed in other rooms of the house,¹² so that its connexion with the hearth was now for the most part a thing of the past.¹³

Just as in the private house the hearth supplied the place of the altar, so we occasionally find *foci* or *foculi*, either in addition to, or as substitutes for, the altar, in the sacrificial ritual of the State religion.¹⁴ These were sometimes used as *aræ temporales*, i.e. altars for temporary occasions¹⁵, some-

Rel. xiv. 3: 'Vesta . . . ignis est domesticus, qui in focus cotidianis usibus servit.'

¹ e.g. Verg. *Georg.* iv. 384: 'ter liquido ardentem perfudit nectare Vestam', *Morel.* 52: 'dumque suas peragit Vulcanus Vestaque partes'; Sil. Ital. vi. 76 f.: 'renovata focus et paupere Vesta lumina.'

² Cf. W. Warde Fowler, in *ARW* ix. (1906) 529 f.

³ *Aulul.* 7.

⁴ Plin. *HN* xxviii. 267.

⁵ Ovid, *Fasti*, ii. 634.

⁶ Wissowa, *Rel. u. Kult. d. Röm.* 2, p. 172 f.

⁷ e.g. in W. Helbig, *Wandgemälde*, Leipzig, 1869, no. 67 ff.

⁸ H. Nissen, *Pompejan. Studien*, Leipzig, 1877, p. 648 f.

⁹ *Script. Hist. Aug.*, 'M. Ant. Phil.' iii. 5, 'Alex. Sev.' xxix. 2.

¹⁰ Serv. *Æn.* ii. 469: 'singula enim domus sacra sunt dis ut culina penatibus'; cf. Arnob. ii. 67.

¹¹ Blümner, *Röm. Privataltertümer*, Munich, 1911, p. 35, n. 9.

¹² De Marchi, *Culto privato*, i. 82.

¹³ On the domestic chapels of the Romans, cf. Blümner, *op. cit.* p. 51, and De Marchi, *op. cit.* l. 82 ff.

¹⁴ Serv. *Æn.* iii. 134: 'sane Varro rerum divinarum refert, inter sacratas aras focos quoque sacrari solere . . . nec licere vel privata vel publica sacra sine foco fieri.'

¹⁵ Ovid, *Metam.* iv. 752 ff.: 'dis tribus ille focus totidem de caespite ponit; | laevum Mercurio, dextrum tibi, bellica virgo; | ara Iovis media est.'

times in circumstances where a portable apparatus was employed for the introductory libations of wine and incense,¹ or for the burning of the entrails.² Hence the occasional use of the phrase 'foculoposito' as designating an accompanying sacrificial act.³ The assertion that the use of *foci* was confined to the worship of particular classes of deities⁴ rests upon an arbitrary hypothesis of Roman writers. On monuments showing representations of sacrificial ceremonies we find the *foculus* in the form of a collapsible metal tripod supporting a vessel for holding the fire.⁵

LITERATURE.—A. Preuner, *Hestia-Vesta*, Tübingen, 1864, pp. 91 ff., 232 ff.; A. De Marchi, *Il Culto privato di Roma antica*, I., Milan, 1896, pp. 79 ff., 125 ff.; G. Wissowa, *Religion u. Kultus d. Römer*, Munich, 1912, pp. 156 ff., 161 ff.

G. WISSOWA.

HEAVEN.—See COSMOGONY, STATE OF THE DEAD.

HEBREWS.—See ISRAEL.

HECATE'S SUPPERS.⁶—'Hecate's suppers' (δείπνα Ἐκάτης, or, as they were sometimes called, Ἐκαταΐα,⁷ or Ἐκατήσια⁸) were the offerings laid at the cross-roads every month for Hecate. Their purpose was to placate not only this dread goddess of the under world, but also, as we learn from Plutarch (*Moralia*, 709 A), the ἀπορροαῖοι, i.e. the ghosts of those who for some reason cannot rest easy in their graves, and come back to earth in search of vengeance.⁹ An army of these invisible and maleficent beings follows in the wake of its leader and queen as she roams at large through the midnight world.¹⁰

In reality, then, these offerings are a specific variation of the primitive cult of the dead. And to a certain extent this specific variation is due to the well-known fact that the Hecate with whom we have to deal is a composite deity. She was a moon-goddess, and possibly even a goddess of the roadways,¹¹ as well as a goddess of the under world; and which of the three was her original function is a matter of dispute. This, however, need not concern us here, inasmuch as the amalgamation had evidently taken place long before the *Plutus* (594 ff.) of Aristophanes, in which occurs the first surviving reference to our subject.

Hecate's suppers were naturally deposited at the cross-roads. The triple goddess is so clearly identified with the place where three roads meet that

¹ Ovid, *Fasti*, iv. 935: 'tura focis vinumque dedit'; Henzen, *Acta Frat. Arval.*, Berlin, 1874, p. 93.

² Macr. *Sat.* iii. 2, 3: 'exta porriciunt, dis danto in altaria arasve focunive, eove quo exta dari debebunt.'

³ Cic. *de Domo*, 123; Plin. *HN* xxii. 11; cf. Plut. *Crass.* 16: ἴθην ἐσχαρίδα καλομένην.

⁴ Varro, *ap. Serv. Ecl.* 6. 66: 'diis superis altaria, terrestribus aras, inferis focos dicari'; differently, Serv. *En.* iii. 134: 'quidam aras superiorum deorum volunt esse, medioximorum id est marinatorum focos, inferiorum vero mundos.'

⁵ Marquardt, *Röm. Staatsverwaltung*, Leipzig, 1885, iii. 164.

⁶ Modern discussions of this subject are all very brief, and the only ones of real value to the student are W. H. Roscher, *Ausführl. Lex. der gr. und röm. Mythologie*, vol. i. pt. ii., Leipzig, 1886-1890, p. 1888 f.; E. Rohde, *Psyche*, Tübingen, 1903, vol. i. p. 238, n. 2, p. 276 n., and vol. ii. p. 79 n. 1, p. 85, n. 1; Heckenbach, in Pauly-Wissowa, vii. (Stuttgart, 1912) 2780 f.; and the notes on Demosthenes, *Against Conon*, 39, in Demosthenes, *Private Orations*, ed. Sandys and Paley⁴, pt. ii., Cambridge, 1910, p. 226. The first modern discussion of any consequence is by Tiberius Hemsterhusius, on Lucian, *Dial. Hort.* i. 1. Hemsterhusius cites the earlier authorities (all of no value). Others, as a rule, content themselves with a passing reference or ignore the subject altogether.

⁷ Demosthenes, liv. 39; Bekker, *Anecdota Graeca*, Berlin, 1814-21, p. 247, 27; *Stymal. Magnum*, Leipzig, 1816, p. 626, 44.

⁸ Pollux, i. 37; Stephan. *Byzant.* s.v.

⁹ These are the βιασθέντες, ἄσπροι, and ἀταφοί (cf. Rohde, i. 264 f., and notes, 275-277, ii. 362, and note, 411-413, 424-425), whose ἐσθμίον, the quasi-technical word designating their longing for vengeance, was much dreaded. See Heckenbach, p. 2776, and references.

¹⁰ See Abt, *Apol. des Apuleius v. Madaura und die antike Zauberweihe*, Gießen, 1908, p. 128.

¹¹ See Heckenbach, p. 2775.

she is often known as Τριόδιτις, Trivia. The cross-roads, too, have always been haunted by ghosts of the unquiet dead (see CROSS-ROADS).

As regards the day of the month upon which these offerings were made, the testimony appears at first sight to disagree, and the result has been a certain amount of confusion in the statements of modern investigators. We are told, on the one hand, that the date was 'at the new moon,'¹ or, as stated more exactly by the scholiast on Aristophanes (*Plutus*, 594), κατὰ τὴν νομηνίαν . . . ἐσπέρας, which, in this connexion, ought to mean 'on the eve of the new moon.' The statement is entirely in accordance with the character and functions of the goddess. Beyond a doubt, the date of this sacrifice was determined, at least originally, by the first appearance of the new moon: that is, by the first appearance of Hecate herself as she comes up again from Hades. Offerings to the dead were also made on this day.² On the other hand, we are told that the sacrifices to Hecate and the ἀπορροαῖοι fall on 'the thirtieth,'³ i.e. on the last day of the month according to Greek reckoning. This day was also given up to the service of the dead.⁴ Indeed, at Athens the last three days of the month were sacred to the powers of the under world, and hence were counted ἀποφάδες, nefasti. Δείπνα were given to Hecate and the ἀπορροαῖοι; libations were offered to the dead, etc.

The discrepancy of dates, however, is only apparent. So long as the Greeks reckoned time by lunar years, which was the case during the earlier history of these sacrifices, the eve of the new moon always fell on the thirtieth of the month as a matter of course. The reformed calendar took no account of the phases of the moon. Nevertheless, the old habit of calling the first of the month νομηνία, 'new moon day,' still persisted for an indefinite time, and to an indefinite extent. Hence, when the scholiast quoted above said 'on the eve of the νομηνία,' he doubtless had in mind the thirtieth of the month according to the new calendar. It seems certain then, partly no doubt because 'three' and all its multiples are peculiarly sacred to Hecate, that the sacrifice still clung to the thirtieth, despite the fact that, when the calendar was reformed, the original reason for selecting that date ceased to exist. It is possible, of course, that the rite was also performed at the actual appearance of the new moon as well as on the traditional thirtieth, but this cannot be proved on the basis of evidence now available.

A reference in the *Hecate* of Diphilus and a passage from Philochorus—both quoted by Athenæus, 645—show that on the eve also of the full moon (the 13th of the month Munychion [cf. C. A. Lobeck, *Aglaophamus*, Königsberg, 1829, p. 1062]) Hecate was remembered at the cross-roads⁵ with a cake surrounded by lighted torches, and known as an ἀμφιφῶν. This striking prototype of our birthday cake was also a regular article of diet.⁶ It seems likely, however, that this observance at the full moon came over to Hecate from Artemis at a later date.

As is usually the case with offerings to the dead, the regular Ἐκάτης δείπνον on the thirtieth of the month consisted of food. The specific articles, so far as they are mentioned, were: (1) μαγίδες,⁷ a kind

¹ Porphyrius, *de Abstinencia*, ii. 16: κατὰ μῆνα ἕκαστον ταῖς νομηνίαις.

² Rohde, i. 234 n., and references.

³ Schol. on Aristophanes, *Plutus*, 594; Athenæus, vii. 325 A; Harpocration, s.v. τριακῆς.

⁴ Rohde, i. 234, n. 1, and references.

⁵ Roscher, p. 1889; Heckenbach, p. 2780, and literature mentioned.

⁶ Pherecrates, i. 194 K; Eustathius, on the *Iliad*, 1166. 14; Lobeck, *Aglaophamus*, Königsberg, p. 1062; *SBAW*, 1904.

⁷ Sophocles, frag. 668 N, and references; cf. a schol. on Aristophanes, *Plutus*, 594: ἄσπρους καὶ ἄλλὰ τινά.

of loaf or cake, the shape and ingredients of which are not clear; (2) the *μαίρις*,¹ or sprat; (3) *σκόροδα*,² or garlic; (4) the *τρίγλη*,³ or mullet; (5) *ψάμμητα*,⁴ a sacrificial cake described by Harpocration as 'somewhat like the *ψαϊσά*'; (6) eggs;⁵ (7) cheese;⁶ (8) possibly the *βασυρίας*, a kind of cake, for which Semus, in Athenæus, xiv. 545 B, gives the recipe.

Certainly some, perhaps all, of the articles in this ceremonial bill of fare were thought to possess some peculiar virtue or association commending them to Hecate and her crew. Ancient and widespread, for example, is the belief that the cock is the herald of the sun, and that all vagrant ghosts must obey his summons and return to their place.⁷ Possibly this is one of the reasons why eggs are so regularly associated with the cult of the dead.⁸ In most cases, however, it is likely that the choice of a given article for a given sacrifice is the cause, not the result, of the properties and associations ascribed to it. The belief, for instance, that garlic was sovereign against vampires⁹ was probably the result of, instead of the original reason for, its use in this service. So, too, the evident fact that the *τρίγλη*, or mullet, was sacred to Hecate is sufficiently explained by religious conservatism. Various authorities quoted by Athenæus give reasons for it, but these were evidently second thoughts, and due to later theorizing.

However that may be, the food thus offered was meant to be prophylactic—to avert the *ἐνθύμιον*, the easily roused wrath of Hecate and the ghosts. Hence, if Roscher is correct, the title of Eucoline given her by Callimachus¹⁰ really embodies the worshipper's fervent prayer on these occasions that 'good digestion wait on appetite.'

With the regular *Ἐκάτης δειπνον* just described should be included the so-called *καθάρματα*, *καθάρσια*, and *δξυθύμια*. All three were connected with the purificatory and expiatory sacrifices to Hecate that were performed at regular intervals for the house and household. They were, therefore, left at the cross-roads for Hecate, and, as was usually the case with offerings made to spirits present and easily angered but invisible, the worshipper retired *ἀμεταστρεπτή*, 'without looking back.'¹¹ Finally, all three, as Rohde suggests (*Psyche*, ii. 79, n. 1), were doubtless more or less confused with each other and with the *Ἐκάτης δειπνον* at an early date.

In its general sense *καθάρματα* means garbage, trash, offscourings of any kind. In this connexion, to judge from a passage in Ammonius (p. 79, Valckenaer), *καθάρματα* (*καθάρματα καὶ ἀπολύματα*, as Didymus says in Harpocration, s.v. *δξυθύμια*) means all those portions of the sacrifices for the house which were not actually used in the ceremonial. Such, for instance, would be the *ἀπόνιμα* (Athenæus, ix. 49 E), the waste blood and water. Though merely *καθάρματα*, they were sacred to Hecate, and were deposited at the cross-roads.

¹ Antiphanes, in Athenæus, 313 B (2. 39 K), and 358 F; Melanthius, in Athenæus, 325 B.

² Theophrastus, *Char.* xvi. (28, p. 147, 2nd ed. Jebb).

³ Plato, *Com.* (l. 847. 19 K), Apollodorus, Melanthius, Hegesander, Chariclidea (iii. 394 K), and Nausicrates (*Frag. Com. Græc.* iv. 575, Meineke), in Athenæus, vii. 325; Antiphanes, in Athenæus, 358 F; Hippocrates, *de Morbo Sac.* 2.

⁴ Semus, in Harpocration, s.v. *Ἐκάτης νησος*.

⁵ Lucian, *Tyrannus*, vii., *Dial. Mort.* i. 1, with schol. *ad loc.*, p. 251, Rabe; Clem. Alex. *Strom.* vii. 844; schol. on Aristophanes, *Plutus*, 596. They appear to have been raw (cf. Clem. Alex. and schol. on Lucian, *loc. cit.*).

⁶ Schol. on Aristophanes, *Plutus*, 596.

⁷ O. Gruppe, *Gr. Mythol. und Religionsgesch.* II. (Müller's *Handbuch der klass. Altertumswissenschaft*, v. 2), Munich, 1906, p. 795, n. 5.

⁸ J. Marquardt, *Privatleben der Römer*, Leipzig, 1886, pt. 1, p. 266, n. 4, and references, 380, n. 4, etc.

⁹ Gruppe, p. 839, n. 7, and references; Titinius, in Serenus *Sammonicus*, 1044.

¹⁰ Callimachus, ii. 356, Schneider; Roscher, p. 1889; Crusius, in Roscher, vol. I. pt. I. p. 1400, s.v. 'Eukoline.'

¹¹ Rohde, ii. 79, n. 1; Gruppe, 876, n. 1; P. Stengel, *Kultus-Altertümer*, Munich, 1898, p. 111.

The *καθάρσια*, on the other hand, appear to have been whatever was left of the sacrifices themselves after the ceremonial in and about the house had been completed. Among the articles probably belonging to this class are eggs, and especially the body of the dog used in the sacrifice.¹ Dogs, as is well known, were peculiarly sacred to Hecate, and played a very important part in these ceremonial house-cleanings among both the Greeks and the Romans. Before they were sacrificed, for example, they appear to have been touched by every member of the family. This process, the *περισκυλακισμός*, seems to indicate that on such occasions this oldest of the domestic animals acted as the *φαρμακός*, the scapegoat of the entire household.

Another important detail in this ritual, as in all similar rituals the world over, is evidently alluded to by Plutarch (*Moralia*, 709 A), but it is described only by the scholiast on Æschylus, *Choeph.* 98 (Kirchhoff). This was the fumigation of the house. After this was done, the censer, which was always of baked clay, was deposited at the cross-roads. In other words, in this particular ceremony the *καθάρσιον*, the only thing surviving, was the censer itself, and it was therefore treated accordingly.

We have called this ceremony 'fumigation,' because of the scholiast's own words: *καθαίροντες τὴν οἰκίαν ὀστρακίνῳ θυματηρίῳ*, 'purifying the house with a censer of baked clay.' No mention is made of what was actually burned in the censer—the operation was too familiar to require it. A somewhat different interpretation of these words, however, has had a considerable influence upon the modern discussion of the *δξυθύμια*. It has been assumed that what was burned in the censer was not the ordinary fumigating materials, but the actual *καθάρματα* or *καθάρσια* themselves, as the case may be; that this process was itself the *δξυθύμια*; and that, in fact, it was reflected in the derivation of the word (i.e. *θύμον*, 'thyme'). If this is true, the best ancient authorities were at fault. The majority of them identify the *δξυθύμια* with the *καθάρματα*, or, less often, with the *καθάρσια*.² So far as we know, none of these were burned. Irrespective of the *ἀπόνιμα*, which could not be burned, we know that after the dog was sacrificed his body was taken to the cross-roads. We are also told not only that the eggs used were raw (schol. on Lucian, *Dial. Mort.* i. 1, p. 251, Rabe), but also, if we may believe that Clemens Alexandrinus (*Strom.* vii. 844) is referring to this sacrifice, that they sometimes proved to be *ζωογονούμενα*, able to fulfil the function for which nature had originally designed them. Certainly, too, the theory that *δξυθύμια* is connected with *θύμον* serves to confuse rather than to explain. The idea usually connoted by *δξυθύμος* is a high temper, a disposition easily roused to wrath. The present writer prefers, therefore, to adopt the suggestion of Rohde (i. 276 n.) that *δξυθύμιον* would really be a more emphatic statement of the idea contained in *ἐνθύμιον*—a word which, as we saw above, is quasi-technical in this particular sphere; *δξυθύμια*, then, would be 'ceremonies to avert the wrath' of Hecate and the ghosts. As such, it would naturally be a generic term for either *καθάρματα* or *καθάρσια*, and we see why the old lexicographers identified it now with the one, now with the other.³

Any interference with offerings to gods is naturally counted as sacrilegious, and renders the culprit liable to the punishment for sacrilege. This

¹ Roscher, 1889; Heckenbach, 2781; Rohde, ii. 79, n. 1.

² Harpocration, Photius, *Lez.*, and Suidas, s.v.; Bekker, *Anecdota Græca*, 288. 7, and 287. 24; Pollux, ii. 231; *Etymol. Magnum*, 626. 44.

³ The *ὄρχεις ἐκ τῶν χοίρων* used in the expiatory sacrifice prior to a public assembly (Demosthenes, liv. 19) are generally included among the *καθάρσια* regularly deposited at the cross-roads (cf. Sandys' note on Demosth. *ad loc.*).

was especially dreaded in the case of all offerings to the dead.¹ For example, as we saw above, the worshipper retired *ἀμετασπερτί*. This was because he was afraid that the spirits would be angry if he appeared to be looking at them. Hecate was supposed to 'fasten at the cross-roads upon the guilty wretch who had gone after her foul supper,'² and to punish him with madness,³ or with some similar affliction, of all which she was popularly supposed to be the primary cause. Indeed, a curious passage in Petronius, 134, shows that merely stepping accidentally upon the *καθάρματα* (*purgamentum*) at the cross-roads was considered dangerous. The superstitious man, says Theophrastus (*Char.* xvi.), 'if he ever observes any one feasting on the garlic at the cross-roads, will go away, pour water over his head, and, summoning the priestesses, bid them carry a squill or a puppy round him for purification.'

In spite, however, of the supposed peril involved, as well as of the fact that they were proverbially foul and unpalatable,⁴ Hecate's suppers were frequently eaten by some one else. The most common motive, of course, was poverty. Our first reference to it is found in Aristophanes, *Plutus*, 594, where Penia claims that wealth always has the best of it. Chremylus counters with the statement that 'Hecate can tell us whether it isn't better to be poor or hungry. She says that well-to-do or rich people send her a supper every month; whereas poor people snatch it away when it has hardly been put down.' A truly Aristophanic argument! But it was taken literally by the scholiast, and hence apparently the quite impossible statement, still to be found occasionally in modern commentaries and handbooks, that Hecate's suppers were 'meals set out at the cross-roads every month by the rich for the benefit of the poor.' The Cynic philosophers frequently replenished their wallets from Hecate's suppers, or pretended to have done so, and reference to the practice was evidently a literary commonplace especially characteristic of their writings.⁵ We should expect it of a school whose doctrine of a return to nature led them to scoff at all conventionalities—religious or otherwise—and to ape the life and manners of the lowest stratum of society. Sometimes Hecate's suppers were taken merely in a spirit of bravado. Such was the case with the gang of Athenian 'Apaches' whom Demosthenes attacks in his speech against Conon (liv. 19).

Nevertheless, Hecate was deeply rooted in the hearts of the people. Of all the ancient cults, none has exhibited a greater vitality. As late as the 11th cent. the Church was still trying to break up the practice of leaving offerings at the cross-roads.⁶ Even now, not all have forgotten that the cross-roads are uncanny, and that dogs can see things invisible to human eyes. Hecate herself led the famous witch ride of the Middle Ages, while in Germany the Wild Huntsman, and in Touraine the heroic figure of Foulques Nerra, that great ancestor of the Plantagenets who still roams through the darkness with his immaterial host, are a clear indication that Hecate and her goblin crew are only disguised, not outworn.

LITERATURE.—This is fully given in the article, esp. in the footnotes.
KIRBY FLOWER SMITH.

HEDONISM.—Hedonism (from Gr. *ἡδονή*, 'pleasure') properly denotes the creed or theory that pleasure is or should be the sole end and aim of human action or conduct, and that to

¹ Sandys quotes Ps 106²⁸; cf. Catullus, lxx. 3, Ellis.

² Cinesias, in Plutarch, *Moralia*, 170 B.

³ See K. F. Smith's note on Tibullus, l. 5, 56.

⁴ Pollux, v. 163: τῶν ἐν ταῖς τριόδῳ καθαρμάτων ἐκβλητότερος.

⁵ Lucian, *Tyrannus*, vii., *Dial. Mort.* i. 1, xxii. 3.

⁶ Rohde, ii. 84, n. 2, and references.

it all good or well-being is ultimately reducible. The theory may be, and historically has been, held in a variety of forms. In the first place, we must distinguish what is known as *Psychological Hedonism* (the theory that every man either always or normally and regularly acts with a view to attainment of pleasure) from *Ethical Hedonism* (the doctrine that it is right and reasonable for men so to act, and that every man 'ought' to aim at securing for himself or for mankind the greatest possible sum of pleasure or balance of pleasures over pains). It is possible to be a psychological hedonist without adopting hedonism as an ethical maxim; indeed, as has frequently been urged, unqualified psychological hedonism leaves no room for ethical injunctions; for, if everybody always in fact aims at his own greatest pleasure, it is superfluous and meaningless to tell him that he ought to do so. On the other hand, ethical hedonism may be held by persons who do not accept psychological hedonism; which, in truth, is now either abandoned by hedonistic moralists or maintained with drastic reservations.

1. Historically, ethical is older than psychological hedonism, and was first explicitly propounded by Aristippus of Cyrene, a disciple of Socrates and founder of the Cyrenaic School (see CYRENAICS), who held that pleasure is the highest good, and that it should be one's aim to secure at every moment as much of it as possible. It is this simple and unaffected form of hedonism which is combated by the Platonic Socrates in Plato's *Philebus*. A more discriminating theory, formulated by Eudoxus (who introduced the observation that all creatures, rational and irrational, aim at pleasure), is criticized and rejected by Aristotle (*Eth. Nic.* x. ii.). A generation later, the doctrine that pleasure is not only the highest, but the only, good 'for gods and men' was preached by Epicurus who, however, unlike the Cyrenaics, insisted (a) that pleasures of the mind and of friendship and intercourse are greater and of more value than bodily pleasures; and (b) that the perfection of pleasure and the most desirable state is 'freedom from pain and care' (*ἀραξία*). This negative type or conception of pleasure, though never formally repudiated by the disciples of Epicurus, was, as their critics were not slow to remark, very far from being retained in practice as a standard of conduct by adherents of the School; nor was it easily reconciled with other sayings of the founder. The Roman poet Lucretius expounded the Epicurean philosophy with extraordinary earnestness and literary power; and it became very popular in the Græco-Roman world. But it naturally found no favour with the Christian Fathers or the Schoolmen. It was alien to the spirit of the New Testament (cf. ETHICS [Christian]).

2. In the 17th cent., hedonism was revived by Hobbes (*q.v.*), who, identifying pleasure with desire, was apparently the first to combine the view that there is no good other than pleasure with the psychological position that men in fact always seek it. Locke (*q.v.*), while adopting and defending the latter, i.e. the psychological tenet, rejected hedonism as an ethical method, and founded his standard of conduct in obedience to the commandments of God—an obedience motivated by prospect of 'the different state of perfect happiness or misery that attends all men after this life, depending on their behaviour here' (*Essay*, ii. 21, § 60). A hundred years later, Paley expresses the same view in even more uncompromising terms: 'Private happiness is our motive, the Will of God our rule' (*Mor. Phil.* ii. ch. 3). In the 18th cent. the main opposition to the 'selfish' philosophy came from the school of Shaftesbury, Hutcheson, and Hume.

who asserted the naturalness and pleasure-bringing power of 'sympathy.' Here it may be well also to note that from the days of Plato and Aristotle onwards, side by side with 'pleasure' as an object of pursuit, the somewhat vaguely related concept of 'the profitable' or 'advantageous' (τὸ συμφέρον, *utile*) had been recognized—often by English moralists under the name of 'interest.' That in a general way it signified deferred, or diffused, pleasure had been taken for granted by many writers; otherwise it stood apart.

3. A new chapter in the history of hedonism opens with Jeremy Bentham (1748-1832), the apostle of purely mundane hedonistic utilitarianism. Discarding the support of theological sanctions and denying all qualitative differences in pleasure, he furthermore blended in one panegyric the praises of 'pleasure' and 'utility,' and made it clear that the latter consists wholly in balances of the former after deduction of necessary 'pains.' But he at the same time universalized his hedonism by importing into it the non-hedonistic axiom, 'everybody to count for one and nobody for more than one' (see UTILITARIANISM). Since the days of Bentham, the doctrine and the axiom have frequently parted company. It could hardly be otherwise. Pleasure-seeking and equitable distribution are apt to pull contrary ways. If one tries to spread pleasure everywhere, the layer of delight becomes so thin that nobody is delighted. Practically, under hedonism, not everybody, but a certain fraction of the community, gets the pleasure. It may be one class, or 'the classes,' to the exclusion of the masses; or, in a democratic age, it may be numerous masterful individuals, or groups of individuals, who 'like' one another, to the exclusion of those who fail, or do not try, to ingratiate themselves with the dominant type. Hedonism, it is true, would seek to remedy or obviate this unsatisfactory result by promoting a perpetual multiplication of means and opportunities of pleasure. And in this undertaking the philosophers have the enthusiastic support of the unphilosophic populace, no enterprise being more popular than discovery or invention of a new or improved source of pleasure. But, although pleasure is doubtless more widely distributed as a result of increased production, there is little or no evidence of its being more evenly distributed. As a matter of fact, Bentham's successors have not concerned themselves greatly about the axiom of equality. Rather they have endeavoured, by accepting and developing the doctrine of 'sympathy,' to magnify the value of social and altruistic pleasure. Moreover, J. S. Mill (*q.v.*) (1806-73), by recognizing qualitative differences in pleasure, further ennobled the ethics of hedonism, but at the cost of its fundamental hypothesis; for, if some pleasures are higher, and therefore better, than others, there must be something good besides pleasure to constitute the difference. Mill was no psychologist; and, while his eloquent advocacy of 'utilitarianism' did much to propagate a hedonistic view of ethics, his attempted inference of ethical from psychological hedonism has been often and effectually refuted. The psychology of hedonism found an abler and a thoroughgoing exponent in A. Bain (*q.v.*) (1818-1903), who held that pleasure or avoidance of pain is always the object of desire and the aim of action, excepting in so far as men are abnormally under the influence of a 'fixed idea.' This important exception virtually concedes all that is commonly urged by opponents of psychological hedonism.

Refutation of ethical hedonism is a larger matter. Nor is it practicable to summarize the arguments that have been advanced against it. They all rest ultimately on a conviction, of which (it would

appear) some men are, and others are not, conscious—that good, or 'what ought to be,' is something *sui generis*, and not the same as what is pleasurable to me or to anybody; in other words, that the ethical value of what I like, or of what anybody or everybody likes, is to be determined by, and does not determine, what is good or right. The hedonist accounts this belief, or utterance of consciousness, an illusion. To the intuitionist it is a fact, real and ultimate, and a disproof of hedonism.

Within the camp of the hedonists, egoism may be said to be now discredited—on paper, at all events. This already appears in H. Sidgwick's *Methods of Ethics* (6th ed., London, 1901), where Egoism, Utilitarianism (Universalistic Hedonism), and Intuitionism are severally examined and compared, an endeavour being made, in conclusion, to transcend the antithesis between the two last.

It would be out of place here to discuss the effects of the wide and increasing acceptance of hedonism as a philosophy of life. But it is permissible to remark that observation of those effects tends entirely to controvert the view, once prevalent, that the conflict of theories is mainly academic, and that there is practical agreement among intelligent persons as to what conduct is good and admirable. There is not and cannot be any such agreement. The victory of hedonism means a transmutation of all ethical judgments.

The incompatibility of hedonism with the biological principle of evolution is convincingly shown in W. Sorley, *Ethics of Naturalism*², London, 1904.

LITERATURE.—See ETHICS and the literature there cited.

J. M. SCHULHOF.

HEGEL. — 1. Life. — Within Hegel's dates (1770-1831) fell the most eventful epoch in modern history since the Reformation. In literature, philosophy, and politics, humanity was enriched and adorned with a galaxy of men of brilliant and daring genius. While Hegel occupies a foremost place amongst the men of this period, his own personal life was quite uneventful. He gave himself exclusively to the task of the philosopher—that of severe concentrated reflexion on ideas and historical movements. The mental aloofness which this required left neither time nor place for practical participation in the changes that were occurring around him; and he never sought directly to influence the current of events. The rapid succession of political and social crises only interrupted the even tenor of his way by slight personal inconvenience. The quiet waters of academic life were perhaps less affected by the revolutionary storms than any other region; and Hegel was from first to last an academic man.

Georg Wilhelm Friedrich Hegel was born in Stuttgart on 27th Aug. 1770. His ancestors had long been connected with Swabia, and Swabian in mind and character Hegel always remained—naive and simple in nature, genial in temperament, with a strong vein of good sense embedded in sardonic caustic humour. Various members of the family had been craftsmen, officials, scholars, and pastors; one of the latter is said to have baptized Schiller the poet. Hegel's father, Georg Ludwig Hegel, was an under-official in the service of the Duke of Württemberg; of him or of his wife, Maria Magdalena Fromme, nothing seems to be known. Hegel was the oldest son; a brother, Ludwig, entered the army, took part in an expedition to Russia, and died unmarried; a sister, Christiane, to whom, as to his mother, Hegel was greatly attached, also died unmarried. Hegel, after attendance at a 'Latin School,' entered the usual Gymnasium at seven years of age, was the model industrious pupil who took prizes in every class, read methodically and intelligently in many direc-

tions, and left school with a sound classical training and considerable miscellaneous knowledge. His mind developed very slowly, and his achievements were always the result of hard work and inexhaustible patience. To the end of his life the path from thought to expression, whether in speech or writing, was more or less blocked; his utterance was always awkward, and even his gestures were clumsy and angular. These peculiarities were not overcome with advance of years; on the contrary, the advance in his mental development seemed to increase the difficulty in finding the appropriate expression for his ideas.

At eighteen (1788), he entered the theological seminary at Tübingen as a ducal bursar, and here he remained till 1793. He graduated master of philosophy in 1790 with a scholastic dissertation 'On the limits of human duties, assuming that the soul is immortal'; and passed the examination for clerical orders in 1793 by an academic thesis on what seems an insignificant topic in Church history—the calamities affecting the Church of Württemberg. At Tübingen his abilities seem to have made no great impression on his teachers or on his fellow-students. He spent the next seven years as a private tutor, partly in Switzerland (1793-96), and partly at Frankfurt (1797-1800). From the fragments of his early writings collected by his biographer Rosenkranz, and from his early letters, there can be little doubt that this was the formative period in his intellectual life. His tutorships left him apparently plenty of time for his own work; he read widely, made himself master of the new philosophy, and through his friend Schelling came directly into touch with the leaders of the new movement. By the time his apprenticeship ended, he emerged from obscurity with an unusually well equipped intellect, re-entered academic life at Jena in October 1801 as lecturer, and at once took his place as a leader in philosophy. After a brief adherence to the views of Fichte, he came into line with the early philosophy of Schelling, with whom he edited the *Journal für Philosophie* (1802-03). He definitely broke away from Schelling about 1803 and took up his own independent position in his first work, the *Phänomenologie des Geistes*, which was given as a course of lectures to his students in 1806 and appeared in published form in 1807. He was appointed 'extraordinary' professor in February 1805, and received his first and last salary of 100 thalers in July 1806. Hegel began to feel life at Jena University too narrow, and his eyes turned to Heidelberg. For a few years after 1806 he drifted from university circles. He took up the editorship of the *Bamberger Zeitung* in 1807 and remained there till 1808. In the autumn of 1808 he was appointed Rector of Nürnberg Gymnasium, where he remained till 1816. In the autumn of 1811 he married Marie von Tucher. While in Nürnberg he drew up for his pupils his first draft of his philosophical system, afterwards published as the *Propädeutik*; here, too, he composed and published his *Logik*, which occupied him from 1812 until 1816, when he moved to Heidelberg as Professor of Philosophy. In 1817 appeared the first edition of his *Encyclopädie* which was published for the students attending his lectures. In December 1817, at the instigation of Solger, overtures were made to him by the Prussian minister of Education, Altenstein, which led to his migration to Berlin in Jan. 1818 to occupy the chair of Philosophy. Hegel was liberally treated by the Prussian minister, was given a salary of 2000 thalers and 1000 thalers for removal expenses, and anything further he might require to make him comfortable in his new post. Here Hegel remained till his death in 1831. The chair in Berlin was the summit of his academic career, and constituted

him the acknowledged leader of philosophical thought in Germany. His work prospered, his influence with his students steadily grew, as a spiritual force he became predominant, and his circle of friends made life happy and complete. He was appointed Rector of the University in 1830; otherwise the record of his life in Berlin is the record of the successive courses of lectures on the different parts of his system, as this gradually grew and took shape under his unremitting reflection. He published *Naturrecht und Staatswissenschaft im Grundriss*, otherwise called *Philosophie des Rechts*, in 1820, the 2nd edition of the *Encyclopädie* in 1827, and the third edition in 1830. None of his other lectures in Berlin were published till after his death, when the courses on History, Religion, and Art were edited and produced by his pupils. His death took place on 14th Nov. 1831. He was seized with cholera in one of its subtlest and most dangerous forms, and died very suddenly after a day's illness. He was buried, at his own request, beside Fichte and close to the grave of Solger, his friend.

Throughout his life Hegel showed no outstanding distinction of personality of any kind. He never seems to have gone through any intense spiritual conflict, he had no period of storm and stress, and had no quarrel with persons, passions, or principles. His was a life without misfortune, without adventure, without a great friendship, without the elevation of a great love or the tyranny of a great ambition. Science was the consuming occupation of the whole energy of his mind. He had in an unusual degree that supreme intellectual detachment, combined with complete and intense concentration, which marks the philosopher *pur sang*. In private life he was sociable, and on terms of friendship with a few simple and genial people—a natural being without personal affectations, despising all pose, and with none of the self-consciousness which makes a man a prey to the flattery of success or to the morbidity of failure. He was always reconciled to life as he found it, accepting without demur the institutions and even the fashions of his social environment, meeting the serious demands of the day with sober good sense, and the trivialities with good-humoured irony; a good citizen, a good patriot, a good churchman, a man of unbending rectitude and unswerving consistency of purpose.

2. The historical sources of Hegel's philosophy.—It is characteristic of most philosophers to support their own theory by assuming a hostile attitude towards their predecessors, more especially their immediate precursors in the common task. Sometimes the hostility is open, sometimes veiled in indifference; at times the attitude is critical, at other times neglectful or even grudging; but the more comprehensive the new system, the more does it usually claim acceptance at the expense of those who have gone before. This reluctance to acknowledge intellectual ancestors creates a self-conscious independence, which may be necessary to maintain complete freedom of thought, and devotion to objective truth, but contrasts curiously with the trust in tradition and respect for the past so characteristic of religion and social life. It makes every philosopher an intellectual Melchizedek, and the company of philosophers a pure democracy contemptuous of forefathers and genealogies.

Hegel was one of the few who recognized that such a negative attitude towards the past was not necessary in the interests of either speculative freedom or philosophical truth. He was the first philosopher in modern times to treat the history of philosophy as a specific philosophical problem, and to offer a clue to interpret and connect the different philosophical systems which the history of human culture had brought to light. He sought to show

that all philosophers had a single purpose in view and were dealing with a single principle, and again that each expression of that principle, being incomplete or one-sided, demanded and gave rise to a further interpretation of its meaning. The different systems were thus essentially connected in two ways: on the one hand, all were endeavouring to unfold the meaning of a single object or 'idea,' as Hegel called it; on the other hand, each successive system was a progressive advance on its predecessor. Each fresh attempt to grasp the fundamental 'idea' required and made possible the speculative freedom of each thinker, his detachment from his predecessors, immediate and remote; the progressive evolution of philosophical truth involved and ensured the intimate unity between past and present systems.

This conception of the history of philosophy throws direct light on the sources of Hegel's own philosophy. It is, indeed, the only assistance he gives to those who wish to know what those sources are. Hegel's development was almost entirely internal; he apparently made no attempt to work out tentatively philosophical ideas which must have occurred to him at the various stages of initiation. If he did make any bridges over the various currents of thought which he encountered on the way to his system, he must have burnt them; but the chances are that he waded across in silence and did not pause for intellectual experiments. In his earliest philosophical essays published in *Das kritische Journal der Philosophie*, edited by himself and Schelling, his mind is already made up on the main points at issue; and, when his first philosophical treatise (the *Phänomenologie des Geistes*) appeared in 1807, his system was already formed and henceforth remained unchanged in principle and method. The only indications we have of the course of his ideas in the preparatory years are a few isolated fragments and remarks on different topics, political, religious, and philosophical, which in part were first published in Rosenkranz's 'Life of Hegel,' and which have recently been published in complete form. From these scattered sources, taken along with the conception of the history of philosophy above described, we are able, however, to specify some of the more important influences which helped to determine the form of Hegel's philosophy.

(a) Hegel was a student of theology, and for some time seriously contemplated a clerical career. This of itself would have turned his mind to the study of religion, but in any case the subject of religion was one of absorbing interest throughout his whole life. His mind was, so to say, constitutionally of a deeply religious cast. This affected his attitude towards philosophy from the first, and helped very largely to shape the philosophical problem as he understood it. There is no topic to which he so constantly recurs as that of the intimate relation of religion, especially the higher types of religion, to philosophy; and in no part of his analysis of ideas is he more happy than when he illustrates the community of thought between the two. The religious aspect of experience was, then, one of the most important factors determining the form and principle of his philosophy.

(b) A second and hardly less important influence was derived from his study of history, the history of ideas, and the history of social and political institutions. There seems little doubt that he early realized the importance of a study of the history of philosophy, both for the due appreciation of the form and content of speculative thought and for the comprehension of its purpose and place in the history of mankind. This furnished him with a knowledge of philosophical problems and conceptions unrivalled and indeed unap-

proached by any of his contemporaries or predecessors in modern philosophy. It gave him perspective and breadth of view in the construction of his own system, and thus at least tended to counteract the one-sidedness which is the danger of all abstract thinking, and which so often arises from too exclusive concentration on the pressing problems of the moment. It enabled him to see whether a new form of philosophy was justifiably required in his own time, having in view all that had already been done, and, if so, what form that philosophy should assume. It showed him the vital relation between philosophy and general history, and so revealed the inner connexion of philosophy and human life, in a way hardly realized before and only imperfectly conveyed by historians, and philosophies of history such as that of his contemporary Herder in the *Ideen zur Geschichte der Menschheit* (1784). Above all, it led him 'back to Greece' with its wells of undefiled philosophy; and there he found an abiding fount of inspiration, to which he constantly returned and from which he drew a great part of what was best and most valuable in his own philosophy. If there is one element more than another in Hegel's study of history which gave him a unique place amongst his contemporaries and led him to take a distinctive line and make an independent contribution to philosophy, it is his intimate knowledge at first hand of the mind and thought of the Greeks. Just as from one point of view his philosophical aim may be said to be to harmonize the apparently conflicting attitudes of religion and philosophy, so from another point of view it may also be described as an attempt to recast Greek ideas in the mould of modern thought, and reconcile the contrasted human ideals of Greek civilization and of Western Europe in modern times.

(c) Another very important influence which guided the direction of Hegel's philosophical development was derived from the peculiar forces which were at work in all departments of human life at the time when he lived. Not only in the domain of literature, but in social and political life, traditions, conventions, the accepted principles of order, were set aside in favour of the spontaneous tendencies of the individual as a 'naturally' distinct and separate unit of humanity. The supreme outcome of this movement in the sphere of politics was the French Revolution, and in the sphere of letters Romanticism. On its negative side we have civilized society dissolved into its ultimate constituents and rejecting its ancestral ideas and organized institutions; on its positive side we have the attempt made to carry out the purpose of human life under the guidance of individual freedom. It was impossible for any man of insight, endowed with a sympathetic appreciation of the higher ideals of humanity, to remain unaffected by such a highly electrified spiritual atmosphere. Hegel as a son of his time was closely in touch with and profoundly influenced by the forces which were changing the features of modern civilization and creating new worlds for old. His unique contribution to the movement was derived from a reflective understanding of its governing ideas, as the result of which he sought to place it in its proper setting within the drama of human history, to correct its one-sided intensity, and to reveal it as a phase of the general life of the human spirit. Here once again his study of history came to his assistance, and his knowledge of the philosophical ideas of the past enabled him to grasp the inwardness of the thought of his own time in a way impossible to those who were completely under the control of its immediate influences.

(d) Finally, there can be no doubt that the Kantian

philosophy, with its succeeding development under the hands of Fichte and Schelling, was the immediate philosophical source of Hegel's own system. This was due partly perhaps to Hegel's conception of what development of philosophy involved, but much more to the fact that there was no escape from the influence of a scheme of thought which had taken complete possession of the philosophical minds of his time, which in its principle was profoundly important and in its full significance was not understood, much less exhausted, by those who had as yet undertaken to expound it. It was thus natural and inevitable, if Hegel was to take his place amongst the philosophers of his time, that he should fall into line with the Kantian movement, and in the first instance make himself thoroughly acquainted with its principle, with the development of that principle at the hands of his immediate predecessors and contemporaries, and with the latent philosophical possibilities of the principle unrealized by its originator or by any of the exponents who had as yet adopted or adapted it.

Other influences there may have been in the final shaping of Hegel's system, but those enumerated seem the most prominent and the most effective. All of them have to be borne in mind if we are to give an approximate explanation of the sources of his philosophy; for it seems superficial and inaccurate to describe his system as 'Spinozism recast in the mould of the principle of Kant,' or 'systematized Romanticism,' or again as a revised form of the philosophy of Schelling.

3. Hegel's view of philosophy.—Hegel differs from other philosophers in nothing more than the care which he bestowed on the consideration of the place of philosophy in the plan of human experience. In this he reminds us of Plato and Aristotle rather than of any modern thinker. Hence no statement of Hegel's system is satisfactory which does not at the outset explain his view of the object and method of philosophy. In a sense one might say that his conception of philosophy contains a kind of epitome of his whole system. He constantly recurs to the topic whenever a relevant opportunity arises, and had no doubt as to what precisely he meant by philosophy.

The distinctive character of his conception of philosophy may conveniently be brought out, to begin with, in relation to Kant's theory of knowledge. On Kant's view, metaphysics was a failure and a futility. It failed in the sense that the knowledge it pretended to give was not, and apparently could not be, verified by experience, did not secure common assent even from those who cultivated it, and showed no signs of any progressive advance in the comprehension of the object or objects with which it professed to deal. It was futile in the sense that it was a mere formal manipulation of the most general concepts *in abstracto*, the connexion of which was merely analytical and was secured by the purely logical principle of consistency or non-contradiction, the origin and validity of which were accepted without criticism or challenge, with the result that such a system of concepts, being in no way subjected to the only criterion of truth—agreement with experience—could not be regarded as either true or false, as anything more than an intellectual castle in the air without any serious claim to be called knowledge. The pretence of metaphysical knowledge stood in glaring contrast to ordinary scientific knowledge; and this would be admitted were it not for the apparently ineradicable instinct which induces reason ceaselessly to undertake the task of supplying such knowledge. Kant therefore sets himself to examine the nature and conditions of true knowledge in order (1) to show the limits within which knowledge is valid and successful; (2) to account for both the failure

and the apparent inevitableness of the task of metaphysics. Kant's theory of knowledge in its scope and its outcome was controlled by the purpose which determined it: true knowledge, he maintained, was concerned solely with experience which always involved the content of sensibility; metaphysics was the result of the operation of reason untrammelled by experience.

Hegel regarded Kant's whole undertaking as logically impossible from the start, for Kant's own theory is meaningless if his view of knowledge is correct. Kant's theory is itself a kind of knowledge; it is the knowledge which philosophy supplies; but it finds no place or explanation in his theory. It does not start from nor deal with experience in Kant's sense. But it is not permissible to have a standard of knowledge by which to judge metaphysics, without equally demanding a standard by reference to which the criticism of the validity of knowledge is itself made possible. The criticism of *all* knowledge implies a criterion, just as much as the criticism of a part of it. The philosophy of the limits of knowledge must in some way be unconditioned by those limits; and hence either such a philosophy is not knowledge, or else knowledge must have a meaning beyond that implied by such a philosophy. Kant as the guardian of the limits of knowledge overlooked the inevitable question, 'Quis custodiet ipsos custodes?' Logically, then, Hegel's criticism of Kant is unanswerable from Kant's point of view. There is only one way of determining what knowledge can or cannot do, and that is by following knowledge wherever it leads: as Hegel frequently remarked apropos of Kant's theory, we can learn to swim only by entering the water.

But it is clear that we cannot swim in any kind of water, and we must have some preliminary general idea of our own strength. Hegel rejects Kant's conception of knowledge, virtually because it is too restricted in scope, and because it does not give any explanation of that kind of knowledge involved in constructing his own theory, viz. philosophical knowledge. But Hegel, too, starts from a conception of knowledge, and also takes a certain type of knowledge as a standard by which to determine the value of other kinds of knowledge. His general conception of knowledge is wide enough to embrace all forms of knowledge: his standard type of knowledge is that by which all forms of knowledge must be interpreted, the ideal of all knowledge; and this is the idea of knowledge as realized and developed in philosophy. Thus he dismisses Kant's arbitrary limitation of knowledge to 'scientific' knowledge; he regards philosophical knowledge as a necessary and definite type of knowledge with a distinctive character of its own, but at the same time intimately related to all other forms of knowledge. Being that type by which all kinds of knowledge are interpreted, it must in some sense be a higher embodiment of the nature of knowledge than any other. But it cannot be obtained from an empirical examination of other types given in experience: it is not a mere aggregate of the other types, nor a generalization from them. It has a unique function to perform, which must be capable of precise definition as a preliminary to carrying out the task of philosophy: without this we shall not know how to proceed. And in so far as it requires justification, this must somehow be supplied by philosophy itself.

The essential elements in Hegel's conception of philosophy are determined by reference to (1) the object with which philosophy deals, (2) the medium in which it works, (3) the method by which it carries on its process to a final result. These factors are closely connected, but each is distinct from the other.

On Hegel's view the object of philosophy is described in general terms as the Whole, the Absolute, or God. This is reality without qualification, and hence, abstractly considered, can only be described as what is simply, or what is not finite, not a part. The specific meaning assigned to this object varies with each philosophy, but it is one and the same object with which all philosophies deal. Even when a philosophy denies that any definite meaning can be attached to such an object, it is just the reference to this object which makes such a denial a contribution to philosophy. Whatever philosophy may or may not achieve, it has always been concerned with what is ultimate. This does not require demonstration; it is so much historical fact.

Again, the medium in which philosophy moves is that of the supreme achievement of thought—a notion. This has certain characteristics, negative and positive. Negatively, it is not derived from nor dependent on sensation or perception, and hence is not a mere general concept: it is not a purely formal abstract universal, and hence a notion has no rigid fixity of outline, empty of all specific content and applicable to any, and does not exclude all relationship with other notions. Positively characterized, a notion operates freely and independently within itself and under its own conditions. It is the ultimate principle controlling and penetrating all thought wherever it appears, whether in sensation, perception, or abstract reflexion; it is universal, but is a concrete universal, that is, holds within itself the particular and is the organic unity of universality and particularity; it is a single identity in and through difference, is, in fact, thought as an operative individual unity; and each notion directly refers to and connects itself intimately with other notions, so as to form an organically articulated system, a self-contained structure of notions.

The method by which philosophy proceeds is that of development of the notion. Development here does not mean development in time, but development in expression and coherence of the elements involved in the notion; it is a development in terms of and for the purposes of complete thought. The notion is an operative individual unity, and thus is a process which can be realized with more or less completeness. The unity of the elements in the notion may be implicitly asserted or explicitly affirmed; it may be immanent or fully unfolded. The elements in the notion may be taken by themselves, and each may in turn be said to be the whole notion; but each inevitably calls for the other as soon as the one-sided affirmation is clearly made and seen, because nothing short of the whole notion can express its meaning, and its unity is indissoluble. One partial affirmation, therefore, gives rise to another, till the notion is fully unfolded and installed as an explicit unity of all its elements. The partial affirmation of the notion is, relatively to the whole, an abstract affirmation; the complete explicit co-ordination of all the elements within the unity of the whole notion makes impossible any abstract isolation of elements, and so cancels all one-sided affirmations; relatively to these abstract affirmations, the whole notion, as explicitly containing and co-ordinating all its elements, is concrete. From this point of view the development of the notion is described by Hegel as a process of the notion from abstract to concrete.¹ The notion itself determines these stages; it is these stages, and it is the process of removing the one-sidedness of each till the unity of the whole is completely realized. Looking at the process as a growth from a lower to a higher degree of articulation of the nature of the whole,

¹ See *Gesch. der Philos.* xiii. 54.

it is spoken of as a process from 'potentiality' to 'actuality.' Looking at the notion as an individual concentration of the highest activity of mind, which is essentially self-consciousness, the process is described as the notion gradually 'coming to consciousness of itself.' Taking the stages of the notion as stages in a self-distinguishing and self-relating principle, the identity as such of the notion is spoken of as the notion 'in itself,' the notion 'implicit'; the diversity as such, which the notion contains, is described as the notion 'for itself,' the notion 'explicit'; while the union of these two aspects in a single articulate totality is the notion 'in and for itself,' the notion completely 'realized.' These different ways of regarding the process in the life of the notion are closely connected, and are, in fact, alternative expressions for the process which are employed according to the context and to suit the convenience of the exposition.

The conception of philosophy above delineated marks off philosophy as a form of knowledge from all other forms in which knowledge exists, and is from first to last the region within which philosophy in Hegel's sense lives and moves and has its being. It no doubt requires justification, and Hegel gives a justification of this conception; but it is a justification in terms of and satisfactory to philosophy itself, not one that any other form of knowledge would accept or give. And indeed no other form of knowledge except philosophy requires or is able to guarantee the point of view of philosophy. Each form of knowledge takes its own way and keeps within its own conditions and limits, without giving any other justification of itself except the success with which it accomplishes its aim. Philosophy alone must try to justify its own conception, because it is and claims to be the most comprehensive type of knowledge; and without such a justification from itself it would require a still higher form of knowledge to justify it, and so on *ad infinitum*. The only way it can prove that it is the final or 'absolute' form of knowledge is by showing that it can account for its own conception; and if it can do so there is no further form of knowledge possible or required. In that sense philosophy is without presuppositions (*ἀνεπιπροσβέτων*), because it leaves nothing, not even itself, unexplained and external to the control of its own principle. What this justification is, we shall presently see.

The conception of philosophy is of importance not merely to make clear from the outset what Hegel means by philosophy, but also to understand his manner of treating the different parts that fall within his scheme of philosophy. The treatment is throughout uniform in character. The Absolute is the fundamental object from first to last. The Absolute is one and is apprehended in the form of the notion: it is the notion *par excellence*. But the Absolute expresses itself in different ways, each of which is an embodiment of the notion. And conversely, wherever we have a notion, there in some way we have an expression of the Absolute, the ultimately real. The process of revealing what the notion contains is, as just indicated, that of development. Hence in every part of philosophy the same mode of exposition is adopted. This principle of development has to deal sometimes with material which has no temporal nature at all, sometimes with material which has a temporal character, or only exists in a temporal sequence. In all cases the development is a logical sequence, for only so is the content of the notion coherently and systematically connected in the way demanded by philosophy. In the case where the content is bound up with temporal conditions, the development of that content in logical form consists either

in adopting the content which time offers and arranging it to meet the requirements of the logical development of the notion considered, or in regarding the temporal sequence of the content as in essence following the same course as the logical sequence of the notion. An illustration of the former appears in the treatment of the various historical forms assumed by the idea of freedom in human history; the course of the history of philosophy in Europe is an illustration of the latter.

Following this clue of the inseparable connexion of the notion with the principle of logical development, we can see how it comes about that in every part of Hegel's scheme of philosophy there are only two questions to be considered: What is the notion dealt with in the part in question, and how is the development of the content of that notion to be expressed in terms of the peculiar character of the notion in question?

Thus we have (1) the notion of philosophy itself as a factor in the life-history of the human experience of the individual mind. The development of this notion in and through the various forms of concrete human experience gives us the philosophical interpretation and vindication of the place of philosophy in experience. This part of the system of philosophy is worked out in the 'Phenomenology of Mind.'

(2) Philosophy, as a human effort to express the ultimate notion of the Absolute, is subject to the conditions of race, culture, and civilization in the midst of which it appears. The one notion is, as already said, dealt with all along, but it expresses itself differently owing to the variety of conditions just mentioned. It is thus one philosophy which works itself out under these conditions; the different expressions of this one philosophy constitute a variety of philosophical systems. These systems appear at different times, and necessarily make philosophy take on a historical character. Taken together, they constitute the history of philosophy; and these systems are but forms of one philosophy, being the work of the one notion which animates them all. The logical development of the expressions of this one system through all its historical conditions constitutes what Hegel understands by the 'History of Philosophy.' The logical development here is inseparable from the direct historical sequence in which the different systems have appeared. The historical direction is the logical direction, because there is one notion or one absolute system working through all and animating the various minds concerned; and the way in which its content actually appears is a historical sequence. Thus Hegel's 'History of Philosophy' is not a mere narrative of theories succeeding each other in time, but an integral part of his own philosophy; it is a philosophical interpretation of the history of philosophical theories.

(3) The notion of the Absolute, which is the ultimate object of philosophy, has, like every other notion, its own moments or aspects, each of which is the Absolute, but is capable of distinction from the others, and capable of separate logical development. Its very concreteness makes it necessary for philosophy to take it in detachments, so to say, in order exhaustively to express its content. But its single concrete reality cannot be broken up into separate components. It remains in its concreteness as the all-comprehensive and supreme principle operating in each of its aspects, and containing all the results of the development of each in turn. It is the presupposition and final result of that development. The aspects are themselves, therefore, but stages in the evolution of its concrete single reality, and must be so treated; and the development of the different stages forms a

continuous development of the entire content of the notion of the Absolute. This comprehensive development of the notion of the Absolute is the entire system of the philosophy of the Absolute. It forms a single body of philosophical science, with distinct members. This constitutes what Hegel calls the 'Encyclopædia of the Philosophical Sciences.' It is thus not a mere collection of sciences, or a dictionary of philosophical knowledge; it is a philosophically connected whole of Science.

(4) It has just been said that each of the aspects of the notion of the Absolute can be treated by itself, but that each must be looked on as a specific embodiment of that notion. The first aspect logically is that of the notion in its bare concentrated universality, the notion 'in itself,' the notion as self-identical. This aspect must cover the whole domain of the Absolute, but must do so always with this character of universality, and formal self-identity. Whatever the Absolute contains must be expressible from this point of view; and, since the Absolute is the totality of all reality, there will be a multiplicity of universals within it. The notion as self-identical, in short, is capable of logical development in terms of its universality alone; such development will unite all its universals into an organized whole or Science of all the ultimate universal elements of the Absolute as it is or was 'in itself before the creation (i.e. differentiation) of nature and finite spirit.' This is carried out in the science of 'Logic'—the science of the merely universal principles by which the Absolute lives and moves in a uniformly coherent intelligible system. Such a system is the ground-plan of the whole of reality, the network of notions which holds together and constitutes the essence of all that is.

(5) The second aspect of the notion of the Absolute is the sheer opposite of the first, is the aspect of pure dispersion, the notion 'for itself' (i.e. out of itself), the notion as self-differentiated. This again covers the whole domain of the Absolute, is the Absolute in this peculiar form. The fundamental oneness of the Absolute must not therefore be lost sight of when viewing this phase of its differentiation; it is a differentiation *within* the one, or the one resolved into pure self-externality. Without this implication of the oneness of the Absolute, it would be impossible to have a science or intelligible system of the Absolute in this form of pure difference. The Absolute in its aspect of self-dispersion is the world of Nature, inorganic and organic, as realized in space and time, the universal media of thoroughgoing externalization, whose very essence consists in keeping its contents apart from one another down to the minutest particular detail. Nature, however, makes a whole by itself, and that wholeness of Nature is once more the unity of the Absolute as such expressed in and through the form of Nature. This makes possible an intelligible system of Nature, and such a system is the 'Philosophy of Nature'—the philosophical development of the notion in the form of self-externalization.

(6) The third aspect of the notion of the Absolute is the explicit union of the first (pure universality) and the second (pure difference) in a synthesis which avoids these abstract extremes and expresses the concreteness of the Absolute in its highest possible form. It contains the principle that gives rise to each of the preceding extremes. It is, therefore, a principle of universality, and also a principle of self-differentiation. The term combining these two functions in one reality is that of mind or spirit, which, being essentially self-conscious, is at once a conscious unity in all its processes and the conscious source of endless

differences and distinctions within itself. It is supremely an identity which maintains itself through its differences and refers them to itself. It is thus the realized embodiment of the concrete form of the notion, and the type of all such concreteness. The notion of the Absolute fully realized, 'in and for itself,' is thus 'Mind,' and the logical evolution of the notion as mind is the 'Philosophy of mind.' This completes and exhausts the notion of the Absolute; it contains all that fell within the content of the other stages of that notion, for mind is the source of universals, and mind as the soul of an organized body sums up in its organic embodiment the processes of nature. In the logical evolution of mind, therefore, the philosophy of the Absolute comes full circle; and the crowning stage in the development of mind is the philosophy of the Absolute itself; the final outcome and expression of Absolute Mind is the truth of the Absolute revealed in and through philosophy.

(7) Since the notion of the Absolute is embodied with varying degrees of completeness throughout all the system, any part may be taken by itself and worked out into systematic form in exactly the same way that reality as a whole is developed. Each part forms a realm by itself, and its detailed contents can be logically evolved from it. Hegel dealt with four parts or stages in the philosophy of mind in this way. One of these has already been mentioned—the 'Phenomenology of Mind,' mind as creating 'experience.' The other three are (a) mind as 'objective,' as the source of social and moral activity, (b) mind as expressing itself in the realm of art, (c) mind as realized in the life of religion. These are respectively worked out as subforms of his comprehensive system, under the titles 'Philosophy of Law,' 'Æsthetic,' and 'Philosophy of Religion.' In each case exactly the same plan is pursued: we have the notion of 'social mind' delineated and then logically developed through all its forms and stages; and similarly of art and religion.

Whether these minor systems are capable of giving rise to still further systems, Hegel gives no indication. He seems to make an independent treatise of human history, though this is undoubtedly a subject which falls within the scope of the logical development of objective mind, for objective mind, society, is essentially a historical reality. But the separate treatment of history, apart from the treatise on the logical development of social life, is of no real significance, and was probably due to the exigencies of academic work. Strictly speaking, the 'Philosophy of History' occupies the same relation and position in the philosophy of objective mind as the philosophical treatment of the various historical aspects of art and religion occupies in the 'Æsthetic' and 'Philosophy of Religion.' The 'Philosophy of History' must be regarded as a continuation of the 'Philosophy of Law,' as the logical evolution of the notion of freedom (which is the principle of objective mind) in the various historical forms assumed by objective mind in the life of mankind.

4. The nature and meaning of Hegel's 'notion.'—It is evident that for the proper understanding of Hegel's system it is essential to make clear what the notion means, for the notion is the root-principle from which the whole system springs. Hegel no doubt expounds the principle repeatedly, but always in terms of his own theory, and thus takes for granted precisely what the interpreter of the system wishes to have explained. Nowhere does he trace how he personally arrived at this principle, and nowhere does he show how it is derivable from thought as commonly accepted. On the contrary, he proceeds in the opposite way; he recasts the meaning of

ordinary thought by reference to the notion previously accepted as true and as having a specific significance from the outset. Yet there can be no question that this principle was not arrived at without a struggle, and did not arise out of his head, like Minerva from the head of Jupiter. The principle is not self-evident, and needs both explanation and justification.

In default of any historical evidence of how Hegel reached this principle, we must fall back on the epistemological grounds for adopting it. These are mainly two, and are not strictly separable. In the first place, Hegel regarded the world as a single unified whole, which maintained its unity through endless multiplicity of real individuals, and in a certain sense could itself be looked upon as the supreme form of individuality. The world was not a mere process, nor a static reality; for the former makes unity or singleness impossible, and the latter is in contradiction with the plain facts of life in Nature and man. The world is a process that is self-contained, and so as a whole is at rest with itself: it is a process *sub specie temporis*, but a unified whole *sub specie æternitatis*. Its unity is all-pervading, and is maintained in and through the process of its finite parts. The question for philosophy is how best to conceive the principle which thus constitutes the nature of the Absolute a self-complete and self-contained single whole. This resolves itself into the further question what form of finite reality furnishes the most adequate homologue, is nearest in structure, composition, and process to this supreme individual. For man the solution must be found in the highest individuality known to him. But for man the central individuality in all finitude, that which supplies him with the very standard for determining the nature and degree of individuality among finite beings, is the human individual as a realized self-conscious mind. This must be the clue and the basis for the comprehension of the Absolute, as it is the final source of the interpretation of all that is finite.

But self-conscious mind (or spirit) reveals its activity in many ways, through sensation and perception as well as through ideas. To make use of mind as a working principle of explanation we must therefore find the highest and at the same time the most universal function of its activity, that which is the controlling essence of its individuality, dominating all its modes of expression, making them what they are, and holding them together as phases of its own individuality. This is nothing other than its supreme function of consciously uniting its own differences in a single focus of self-hood: not 'referring its content to the unity of the self,' but realizing singleness of being or self-hood through the function of combining differences in a unity. The conscious operation of that function is the reality of the self; the self of the individual mind is at once the unity and the differences, is a concrete function, and is single from first to last. As Hegel puts it (*Gesch. der Philos.* xiii. 45), 'the being of mind is its *act*, and its act is to be aware of itself.' This supreme function is not an abstract operation; it is the essential principle operating throughout all the processes and expressions of the life of mind, and such an essence is in no way and in no sense separate from its expressions. The statement of this essence is no doubt formal; but the essence itself is only a form in the sense that form is inseparable from content. We never have the form 'by itself' in experience, and hence can never treat it as abstract when making use of it for purposes of explanation. It is not admissible, therefore, to start from it as an abstract form and try to deduce out of it analytically further principles or forms of unity. For, if we take it as abstract

at all, we can extract nothing out of it; at best we can only repeat it; and, if we seem to derive further principles from it, we have not, to begin with, taken it as abstract.

It is by the use of this supreme function of mind, then, that we have to proceed when we employ self-conscious mind as the clue to interpret reality, finite and absolute. This highest function Hegel, following the traditional usage of philosophers, calls 'reason.' Since in it the self always operates in a conscious way (it is the conscious unifying of differences), reason is essentially cognitive in character, but 'cognitive' only in the general sense of full awareness. Reason does not here mean simply reflective activity, nor merely intuitive activity; it is both at once in an indivisible act. It can be called reflective when we consider the aspect of distinguishing and relating the elements involved; and intuitive when we consider the aspect of uniting these differences into a single whole. But these are, after all, aspects; the function is one and individual. Reason is therefore 'mediate' and 'immediate' in its operation, and wherever it operates this holds true. This means, however, that as a function it is self-complete, directing itself and determining itself according to its own law or method of procedure: it is its own world and the law of its world. It is the realized limit of knowing. In other forms of knowledge, something is 'given' as an 'immediate,' and 'received' by reflexion as material to be worked upon or 'thought about'; and these factors in the process are assigned to distinct sources. Both factors must exist if knowledge in any sense is to take place; and the aim of knowledge is to transform and permeate the 'given' by the process of reflexion. The limiting case of such a process is when the immediate and the mediating activity are merely aspects of a single operation. Such a limit is reason. But it is an actual limit, not an imaginary or 'ideal' limit; for reason is but the highest function of mind, and mind is through and through actual. Reason is thus not a point of view, but an active function, not external to its contents, but holding its contents (its immediate) within itself. It is in this sense that reason is described as 'concrete' and not abstract. It is concrete, as the essential function of mind must be; and mind is, as already indicated, the very type and standard of what is concrete and individual.

But a further stage is required before we can make effective use of this principle. So far we have treated reason as a function. Now that function operates within a certain range and for an end. It is a function which operates in an individual way, grasps a whole in its singleness, as a unity in and through differences. The end is its product, the outcome and summary of its operation. In a sense this product may be described as the function itself, the function in its single completeness. The distinction between them, such as it is, consists in the product being regarded as the function brought to rest, while the function is the product in course of being brought about. This product Hegel calls a 'notion' (*Begriff*). A notion may be called the object of reason, but only if the connexion between reason and its object be considered as close as that between function and product just mentioned. A specific notion is reason in one of the manifestations of its function; and, if we look at reason simply as the most general function of self-conscious mind, we can speak of reason itself as 'the notion' (*der Begriff*) *par excellence*. Hence we often find Hegel using precisely the same expressions in describing the operation of 'the notion' as when describing the function of reason. The notion is spoken of as 'conscious of itself,' and 'determining itself,' and as 'uniting its differences,' etc.—expressions which

seem to create difficulty until we see that for Hegel 'the notion' is reason, in the sense just described. He does not mean that the notion, like an abstract shade of substantial self-conscious mind, works independently of the vital energy of mind; for the notion in his sense is not a shadowy ghost of mind at all. The notion is reason in the full plenitude of its power, and is indistinguishable from it except as function and end are distinguishable in the operation of reason. The notion is thus not 'endowed' with energy by reason, nor again is the notion the 'expression' of reason, if this implies that the expression is separable from the source or force from which it proceeds. And what is true of 'the notion' *par excellence* holds good of any notion in which reason is embodied.

This step is highly important for Hegel's view. For now it becomes possible to link his theory with the language in which philosophy from its inception has clothed its thoughts in detail. For philosophy has itself created and creates that language, because it is the function of grasping a unity with its differences. That language is animated throughout by the activity of reason; and the results of its activity appear in the manifold 'categories' with which philosophy deals. Wherever we have a function of thought-unity in and through differences, there we have a category, and there we have the operation of reason. Hence we can treat a category as a specific realization of the operation of reason, and can trace its source to the one supreme function of self-conscious mind. Hegel does not require to create the world of reason out of his own mind, nor to dictate to experience the kind or number of categories which constitute reality. The work has been already done in the course of the history of philosophy, and he has but to put the results together; while experience alone can let us see what the categories are which constitute reality. The complicated culture of European life is, so to say, strewn with categories, some having names derived from one language, some with names derived from another. Again, he does not require to be constantly appealing to the nature of reason to verify or justify his categories; he is sure that reason is present wherever this function of unity in and through difference is exercised and concentrated into the summary form of a category. And, finally, reason, while the supreme essential function of mind, must articulate itself into a plurality of categories, because mind is the absolutely concrete with an endless variety of content due to the fact that it gathers up into itself the entire realm of finitude. It is, as already said, the standard of all individuality, and is the standard because it contains all that the other types of individuality contain, and more than is contained by any other single type.

The plurality of categories referred to, being all in the long run expressions of the one supreme activity of reason, are necessarily connected with one another through their common derivation from a single source. Together they form a system so organically connected that any one category involves all the others, and can be clearly interpreted only in the light of the entire system. Each mirrors the whole system in itself; and the whole system can be said to be the unfolding of 'the notion' *par excellence*. This supreme notion gathers up into itself all the plurality of the various categories, and in this respect assumes a distinct name—'the Idea.' Such a system is, again, self-complete and self-contained, because, as we saw, reason is a self-complete and self-determined function carrying its own 'immediate' within itself. Such a system can thus constitute an organic whole of 'knowledge,' the knowledge which reason has of itself in its character of the essence of mind. This

does not mean that the system defies or is independent of experience and reality; for the notions are the controlling principles of experience and reality. It means simply that, since the notions are concrete in the sense explained, they can and do form a distinctive subject-matter for systematic treatment.

Recurring to our starting-point, we can now see how Hegel proceeds to work in interpreting the Absolute. Self-conscious mind is the clue, and the activity of reason is its essence and supreme function. The Absolute is interpretable only in terms of mind, for mind is the highest type of individuality with which we have any acquaintance. It is useless to ask what the Absolute may be over and above mind; for over and above mind there is nothing higher to which to appeal in an intelligible way. To be intelligible is to be mentally constituted, and intelligibility is the presupposition and result of philosophy in the sense of complete knowledge. Moreover, mind *qua* mind is homogeneous with itself, whether mind be finite or absolute. This is especially so if we take the essence of mind, for that essence is identical in all the shapes and forms of mind. The essence of mind is, as said, reason. The operation of reason is thus the same in finite and absolute mind; it is the function that grasps individuality in its concrete singleness. If the Absolute is the supreme individual, reason *qua* reason is adequate to its comprehension. But not only is reason adequate to the comprehension of the Absolute, in the sense of being able to undertake this task. It might make this claim and still be a mere unrealized point of view, or at best enunciate merely abstract propositions identical in significance. But we are not left in darkness regarding the detailed content of the Absolute. For we are able to evolve coherently and in terms of reason the varied content of finite mind. And, if we accomplish this, we *ipso facto* have expressed the content of the Absolute, for the result so realized is the articulation of the one supreme function of reason, which constitutes finite and absolute mind alike. The evolution of such a result is made possible because mind, and therefore reason, is the spokesman and interpreter of the totality of finite individual things, the whole realm of *natura naturata*. Mind supplies the standard of their individuality in each case, and brings to the consciousness of its own individuality the constitutive principle of each. All individuals, so to say, come to light in finite self-conscious mind. But *natura naturata* is the Absolute itself expressed in terms of the whole of finitude; and, when the Absolute is viewed as mind, its expression is not merely inseparable from but is identical with itself, for mind is conscious self-expression. Hence, if reason is adequate to the comprehension of the totality of finitude, and accomplishes this result in coherent systematic form, the result so achieved can be taken as the evolved and connected content of absolute reality. And this is just what Hegel means by comprehending the Absolute. Thus it is through the notion and in terms of the notion—which is the form with which reason works, the language of its activity—that the Absolute is expressed. The notion, as above explained, is the beginning and end of Hegel's system. Wherever reason grasps individuality in its singleness, there we have a notion; and, since its function is to grasp in this and in no other way, the totality of finitude is for it a realm or system of notions; while again the system of notions is the comprehension and indeed the self-comprehension of the Absolute.

The second line of thought by which Hegel reaches his notion, and secures its validity as a

principle of interpretation, is equally important. The distinction of subject and object, within which human conscious experience exists, is held to be a distinction within a single unity, and the form in which this unity in difference reaches its highest expression is self-consciousness. In this form the distinction in question becomes a self-distinction, and the unity is the single self functioning in and through both factors alike and at once; while, as already indicated, the essential nature of self-consciousness is the activity of reason. By this line of thought Hegel seeks, on the one hand, to avoid the dangers of subjective idealism to which his principle is liable, and into which certain of his immediate predecessors, notably Fichte, fell when developing the implications of Kant's theory; and, on the other, to steer clear of the abstractness of the bare unity of subject and object propounded by Schelling, which possessed objectivity at the price of being inarticulate.

The argument by which he establishes this position is contained in the first half of the *Phänomenologie des Geistes*. Briefly stated, it consists in showing that, wherever subject and object stand in the relation which constitutes experience, the unifying principle is that of thought. This is at once a function of the subject and the controlling centre of the reality of the object; and these are inseparable in the life of experience. This unity is not apparent, but is only implicit at the lower levels of experience, where subject and object seem more opposed than united, as, for example, in such levels as those of sensation and perception. But analysis of these types of experience brings to light the underlying principle of unity. The very process of experience from the lower to the higher forms is necessitated by the demand for the explicit in place of the implicit unity, and is at once the gradual evolution of the essential unity of subject and object and the growing awareness of the universality of thought which permeates the component factors constituting experience. We cannot say that the subject dominates the object any more than that the object directs the activity of the subject: they are inseparable elements and develop *pari passu*. It follows that the process reaches its goal, and experience its truest type, when subject and object are transparent to each other, when the subject is aware of itself in its object, and the object responds and corresponds to the functions of the subject. The distinction between the two is as real as ever, but the unity now contains them as factors of one conscious process. This stage is that of consciousness of self. From this point of view, so attained in the course of experience, the levels below this stage are now seen to be not merely preparatory steps to the attainment of self-consciousness, but are themselves implicitly constituted by self-consciousness, which was operative in them from the first, and from which, in fact, by abstraction they obtained their place as forms of experience and as stages in the evolution of experience. Experience is thus constituted and permeated by self-consciousness; indeed its significance consists in its being the process of manifesting or evolving consciousness of self, in the subject's becoming gradually aware of or finding itself in its object, and so coming to be 'at home' in its world.

In this way the principle of reason, which, as we saw, was taken to be the essential activity of self-consciousness, is liberated from all one-sidedness, especially the one-sidedness of finite subjectivity, and is adequate to meet the mind's demands for unity with its object, whatever the object may be. There is no need for distrust or hesitation on the part of reason in dealing with the world; it

has but to 'let itself go,' and the whole domain of concrete individuality in all its manifold forms will straightway give up its essential meaning without reserve, and without retaining the least part of the only secret worth knowing, the secret of the 'thing itself.' Reason is the open secret of the world, because it opens all secrets. It makes the world after its own image, because it finds its own likeness in the face of the world.

'The fast-bound substance of the universe has no power within it capable of withstanding the courage of man's knowledge: it must give way before him, and lay bare before his eyes, and for his enjoyment, its riches and its depths' (Hegel's Address to his Students in Berlin, 22nd Oct. 1818).

In the light of the foregoing we can see at once the central position which Hegel's logic holds in his theory. For logic, as he understands it, is the science of the notions which constitute the sole and only outcome of the activity of reason. The totality of all the notions is the totality of the constitutive principles of reality in all its forms of individuation; and the science of this totality thus must cover the whole of reality, finite and absolute. And, since these notions so systematized exhaustively reveal all that reason can obtain in the way of complete knowledge, the science of logic is straightway identical with metaphysic.

If such a view is called 'Panlogism,' there can be no objection to the term as long as it is understood to imply no objection to the theory. Those who apply the term, however, often speak as if there were some other way of comprehending the Absolute than that which reason affords. What other way there is of 'comprehending' except by and in terms of reason is not clear from their statements. There seems, on the face of it, no other way of being rational except by exercising reason; and, if reason does work in the form of notions, it seems useless to object that the outcome of its work is only a system of notions. One may object to Hegel's way of rationalizing; but no one can maintain both that the universe must be intelligible in terms of reason, and also that the outcome of rational thinking is an illegitimate interpretation of reality. The only valid objection to 'Panlogism,' properly understood, is to insist that there is some other and better way than reason for approaching the Absolute. But this objection is equivalent to philosophical nescience, which, indeed, is the only alternative to rational interpretation. Some critics of Hegel's system frankly adopt this position. Their position is clearly consistent as against Hegel, but it involves the abandonment of the philosopher's task, as Hegel understands it.

Much more serious and important objections can be urged against Hegel's scheme of notions than the accusation of 'Panlogism.' A few may be mentioned at the present stage. It may be readily granted that the function of reason is the supreme central operation of self-conscious mind, and that reason seeks to grasp the individual in its singleness. It is quite another matter to admit that any finite mind is capable of exercising this function with unfailing accuracy and success throughout the whole domain of reality. Hegel seems to proceed as if, having extracted the essence of mind, the essence could be left to itself and would straightway work with inevitable certainty and necessity wherever and whenever it might be set in operation. But this is to identify the finality of the function with finality in its exercise, the finality of a claim with finality of every assertion of the claim, the finality of a point of view with absolute accuracy of vision. The two are evidently distinct in fact, at least in the case of every mind short of omniscience. The essence of a finite mind is never exercised except under the complex conditions and in the complex setting

of a finite individuality; and these conditions are both obstacles to the perfectly free exercise of reason, and constant sources of failure or error throughout the whole operation of its activity. To maintain anything else is to ignore the plain facts of human frailty which are found in every other phase of man's experience. If illusion and imperfection haunt the efforts of man in the minor matters of everyday concern, it can hardly be expected that they will suddenly disappear when he undertakes the unique and supreme task which strains the consummate powers of his mind to the uttermost. Hegel in describing the working out of the notions of reason frequently uses the expression that in the development of the operation of the notion the individual thinker has merely to 'look on' (*zuschauen*). But the individual cannot be regarded as merely a still mirror reflecting with infallible accuracy a process in which he does not actively participate. Even to 'look on' he must concentrate his vision, and to see correctly his sight must be clear and uninterrupted. The point need not be laboured here. When we examine Hegel's way of carrying out his ideal of rational thought, we find that he constantly starts from the conventional terms embodied in ordinary speech and science, takes their meanings as he finds them, and proceeds to invest them with the dignity of the notion. At times he appeals to etymology to help out the operation of reason, and constantly makes use of the varied applications and *nuances* of a term to give vitality and movement to the notion. His procedure may be described in some cases as an attempt to infuse the spirit of the notion into the terms of ordinary thought, in other cases as the sublimation of ordinary thought into the ethereal realm of the notion, in much the same way as, in the hands of the pure mathematician, the ideas of measurable quantities of physical phenomena are volatilized into elements of a rational ordered manifold held together by their purely logical connexion.

Another criticism of considerable importance is that which challenges Hegel's attempt to identify the rational coherence of the whole realm of finite individuality with the system of absolute truth, the whole truth as it is for the Absolute Mind. The former is the reasoned system of *natura naturata*; the latter is the reasoned system of *natura naturans*. It may be that the former is all we can know of the Absolute; but, so long as the distinction remains between the Absolute and its manifestations in the total realm of finitude, it cannot be all that the Absolute can know of itself. To confound the two is to adopt the attitude of what may be called metaphysical positivism; and, whether positivism be scientific or metaphysical, it is open to the charge of affirming as an absolute truth what can never be more than a system of truth which is relative in every sense of the term. If, on the other hand, the distinction between the Absolute and its appearances is insisted on, the rational system of finitude may indeed bear the image and superscription of the Absolute, but it must always be regarded as at best but an approximation to, never a substitute for, the final truth, as the medium of exchange used by mortals in order to handle conveniently and profitably the wealth of absolute knowledge. Hegel never explicitly draws the distinction just referred to; the tenor of his argument is against admitting that the distinction is vital for philosophical thought; and he constantly claims that the system of truth revealed through the free activity of reason is the same truth and the whole truth for finite mind and Absolute Mind alike.

The third charge against Hegel's view is that, while, as we have seen, he approaches his position

by the avenue of human individuality, he claims to have eliminated all traces of anthropomorphism from his system. The explanation of such a claim is simple, but the justification of the claim is unwarranted. He finds his foothold in the reality of human individuality, and from this he extracts the essential principle of activity and movement—reason. He then takes this essence by itself, regards it as a self-contained agency working itself out by its own laws and conditions, and lets it loose, so to say, to accomplish its end, viz. the grasping of reality, in all forms, in terms of the constitutive nature of reason. The individuality from which it comes to begin with is thenceforward eliminated: the individual only 'looks on' while it works. The function is hypostatized, and operates as if it were itself the concrete individual. Hence all the limitations, which in every other aspect qualify the action of the human individual, are held to apply no longer to the function itself. The very success with which the function is exercised is unaffected by the conditions of human individuality: it always works correctly and without interference. Reason is in this way deanthropomorphized. But it seems plain that such a contention overshoots its mark. The essence of finite self-consciousness does not cease to be finite because it is the essence; an essence must, if it is really the essence, still be characterized by the limitations which encompass and permeate all finitude. Finite limitations are not an accident of finitude; they are of the essence of it. It is paradox to regard the essence of finitude as something other than a finite essence; and mere assumption to treat the essence of finitude as infinite in nature and function. If this assumption is correct, it is impossible to account for error; and the assumption gives place to presumption if it is maintained that the working out of the essence makes the system faultless, final, and unalterable. Moreover, the whole value of the principle, as a way to interpreting reality, is lost, if the essence is thus hypostatized. For reason is the same, whether it be realized in a tree or a tadpole or a philosopher. It is, however, just the peculiar significance of the essence in man's individuality which is the source of its value as a clue to the interpretation of reality: the peculiar nature of human individuality in all its concreteness cannot, therefore, be eliminated without endangering its importance as a clue. This means that the essence cannot be taken in abstraction from its source, if it is to be of value. But, if it is taken *with* all the qualities and qualifications of human individuality, the limitations of an anthropomorphic point of view must necessarily affect its whole operation and characterize the result obtained. In short, its value depends on its being anthropomorphic; the elimination of this point of view, however much we may gain in generality and abstractness, lessens the value of the result.

5. Hegel's method.—Equally important with the fundamental principle of the 'notion' in Hegel's system is his view of the nature of the method by which the system is constructed. The peculiar characteristic of all philosophical thinking lies, no doubt, in the consistent operation of a single method of procedure, and most of the great thinkers have recognized this. To Hegel, method was of the essence of system, not merely in the sense that the two were inseparable, but in the sense that the system was nothing but the successful operation of a method clearly conceived from the outset and consistently applied at every step throughout it. He maintains that the value of his own system stands or falls with its method, and not so much by the perfect accuracy in detail with which the system is wrought out. In the introduction to the 'Logic' (*Werke*, iii. [1841]) he says:

'I cannot presume that the method . . . is incapable of being worked out with still greater completeness and elaboration in detail, but I do know that it is the only true method.'

In his first piece of constructive work (the *Phänomenologie*) he pointed out the fundamental necessity of having a carefully formed idea of the method by which philosophy should proceed; and to the last he looked on the method as the soul of a philosophical system. His method, quite as much as its principle, differentiated his own position from that of his predecessors.

Hegel always insisted that the nature of the method was to be found by an analysis of the nature of the notion. The method was not imposed externally on the notion, but was the vital nature of its process. No doubt the formal character of the method was suggested by certain aspects of the work of Kant and of Fichte; much also was due to Plato. But the historical aspect is altogether subordinate to the specific meaning and procedure assigned by Hegel to his method.

Stated in general terms, the method is the way by which the notion, through its own activity as above described, gradually articulates and coherently connects into a single explicit system the component differences involved in its nature as a concrete function of self-conscious mind. A notion, being the essence of self-conscious mind, is a self-closed whole. This is true, whether we take the supreme notion or any notion of a lower grade of significance. In its procedure, therefore, it is self-directed, and not externally determined. Its procedure is immanent and constitutive of its own activity. It unfolds itself because it is a function of a self.

But, again, a notion so completely permeates its own content that its component elements are its own differentiations, are its own expressions, or, as Hegel calls them, its own 'moments.' In each, therefore, we have in a sense the notion in a specific form; and the notion asserts itself in each in turn, as truly as it is the synthesized whole of all the parts. In some cases, *e.g.* the higher notions in the 'Logic,' the parts are themselves notions of a subordinate significance which again contain 'moments' within themselves. In the limiting cases, a notion, on the one hand, is a bare self-identity, and the attempt to assert itself in its content merely brings out the fact that it is incapable of differentiation and so has no content specifically to assert, its content is indistinguishable from absence of content—the assertion of pure being is equivalent to the assertion of pure nothingness: on the other hand, at the other extreme, the notion is so concrete, so replete with content, that it is incapable of asserting itself specifically and at the same time truly; every differentiation is a self-limitation and so incomplete and inadequate to itself; its full meaning is realized only as a comprehensive intuition which gathers into itself the totality of its differentiations, or the 'absolute idea' melts into the organizing process, in and through which its varied content rounds itself into a single self-complete system incapable of further development.

Now, the source of the method lies in this self-regulative character of the activity of the notion in its organic relation to its moments. The procedure is positive in its beginning and positive in its outcome, for a notion is a positive principle from first to last: it loses nothing by the process and gives up nothing in the result. The purpose of the process is to make the notion consciously realize the totality of its content as an articulated individual whole; the necessity of the process lies in the nature of reason, which, being self-consciousness, must become explicitly aware of what its unity contains and controls. This necessity is the

same whether the reason be embodied in the finite human mind or in an absolute mind; and the connexion of content established is the same for both alike so far as it is valid at all. Hence the question of time does not enter into the nature of the process and is indifferent to the process, even if time be required to carry it out, as is obviously the case when a finite mind engaged with the process passes from one stage to another. In contradistinction from the process of time, this process of establishing connexion between the moments of the notion may be described as a cognitive or logical process pure and simple. So far as time as such is concerned, it must itself be handled by the same logical process, if it is to have a place in the compass of the absolute notion, the notion of absolute individuality.¹

A notion, then, aims at realizing all its content as controlled by its own unity. It seeks to affirm its differences separately and together as its own. Its differences are for it ultimate, otherwise it would really be a bare self-identity. The differences are thus, *within the compass of a given notion*, extreme opposites to one another: what the one is the other is not. *Per se* the differences are absolutely opposed; but, being differences within the same notion, they are for the notion only relative differences, no matter how strongly they appear opposed. It is only such differences that the notion is concerned with, for it is such differences that above all challenge the unity of reason, the singleness of self-consciousness. And, further, only in the case of such differences do we have the type of that opposition in which self-consciousness itself consists, the opposition of subject to object within the unity of the same self. As reason is the essence of self-consciousness, each notion of reason must carry within it elements as opposite as subject and object. A notion, then, being concerned with differences which are thus ultimate for one another, there can be only two such differences within the same notion: the opposites within a notion are *per se* contrary the one to the other. And indeed it seems a matter of indifference whether we say that contrary opposites constitute a single notion or that a notion is a function of uniting contrary opposites; whether we start from the one or the other is of no importance for purposes of explaining a notion. A notion is called for wherever there is this contrary opposition, and a notion consists in the unity of such opposites; for both unity and such differences constitute the individuality of a notion.

An illustration from the 'Philosophy of Law' will help to make this clear. The notion of property is that of will expressed in a more or less permanent outer form, in an object of nature over which, by some means or another, will has exercised its force and so embodied its act. It means, therefore, identification of will with a natural object. A will is always a personal will, and property is thus essentially personal property. The ultimate factors composing this notion are thus active personal will in relation to an external object, and passive external object in relation to a personal will. The first appears as ownership of a thing, the second as the use of a thing. Those differences *per se* are diametrically opposite to one another: ownership is not use, for the thing in being used up passes from the owner; left to themselves the opposition between them is absolute. Yet they have such an opposition only because and in so far as they fall within the notion of property. But for this they would be merely outside one another, and could not be even intelligibly contrasted and compared with each other. The very fact of their opposition being a real and reciprocal opposition

¹ It is treated as part of the 'Philosophy of Nature' (*Naturphilosophie*, §§ 257-259).

implies the singleness of the notion containing them; the singleness of the notion creates the contrariety existing between the different elements taken *per se*. But in virtue of the unity of the notion the differences are, from the point of view of the concrete notion, relative: they are both moments of the same notion, and are related on that account. However absolute, therefore, the difference is between the moments taken *per se*, these differences are, in the light of the one notion, merely relative.

The first step in the process of the notion is, then, the recognition that the differences within it are *per se* contrary and ultimate, and that, because of the unity of the containing notion, the differences are related to the same notion and so are relative to one another.

From this follows the important aspect of the process, on which Hegel constantly lays stress—the function of negation. In a sense this is the vitalizing power in the process, its driving force, so to say. Each difference is the contrary of the other, and is 'negative' of it. But this negative relation is not bare or 'infinite' negation, but *specific* negation, negation within a certain field, and negation in a certain definite direction. Thus the 'use' of a thing is not simply 'not-ownership'; if so, it would have no qualities in itself at all, and not to have qualities is equivalent to being in fact nothing. Or again, if it were merely 'not-ownership,' it might well be a fiction, for a fiction is 'not-an-owner.' It is 'use' of a thing within the field of property; and 'use' is not ownership in the sense that whatever within this field is involved in 'ownership' is not found in 'use.' An owner, *e.g.*, has a will, a thing used cannot have a will; hence a slave is not, *qua* slave, a personal will. So a thing as used can be alienated because it is an external object, a personal will as owner is not used and cannot be alienated. In short, the negative relation between the two component differences is a negation with a specific content peculiar to each side of the opposition in question. And it is this definite and positive content which at once makes the negation possible, and constitutes the particular kind of opposition in which they stand to each other. The positive content of each difference enters into and shapes the character of the negative relation of the one to the other. Hence it is that, while in every notion the differences are negative of each other, the precise character of the negation and of its procedure varies with each notion.

Now, this positive content which makes the negative relation definite is derived from the notion itself, which is altogether positive. The notion affirms itself in each moment, and this makes the moment what it is. Moreover, the notion finds itself in each moment, and, so to say, endeavours to concentrate its entire meaning into each moment. For that reason each takes its stand with all the weight of the notion behind it, and in the name of the notion denies the right of the other to be itself, or even to be the notion. The negation is thus not a passive but an active relation, not a condition of quiescence but of conflict between the moments. But this active opposition presupposes and requires a common basis, and that is found in the positive content which each possesses. The positive content which makes the negation definite in character is the source of the union between the opposing moments of the notion. Or, in other words, the conflict is not so much between the moments *per se* as between moments each of which claims to embody the one whole notion. The tension between the moments is a tension within the unity of the notion which is articulate in each. It is this tension which sets up the process of interrelating

the moments in such a way as to break down the opposition and connect the one with the other, and establish an explicit union between them—a union which was implicit from the first and becomes articulate in the organic connexion of the moments. This process of interrelation is what Hegel calls thinking, or rationally unifying, 'contradiction.' To think, or rather think out, contradiction, he says, is the very nature of reason: true thinking can do nothing else, and has nothing else to do. By 'thinking contradiction,' he obviously does not mean thinking 'logical contradictories' in the formal sense; but thinking into a harmonious unity the real contrariety of moments in a notion which are negatively opposed to each other. Since this way of thinking is in a sense the core of the whole process, he rightly regards the procedure as the consciousness of contradiction and the removal of contradiction. The term usually employed to designate this process—dialectic—Hegel adopts from his predecessors, more especially Kant and Plato; though Hegel constantly points out that the dialectic method was imperfectly understood and imperfectly applied in every system but his own, and mainly because the nature of negation, on which the process turns, was not properly grasped.

When we ask how the opposite elements are brought into harmony, the answer is—by the ordinary operations of analysis and synthesis characteristic of all thought and indeed of mind itself. These two operations are inseparable, and are inherent in the function of reason. Starting from an implicit synthesis, we find by analysis the moments of the notion; we discover in the same way the positive content of each moment, and by continuing the analysis far enough we come to a point where the very content of each moment suggests its relation to the other, and the further analysis gradually passes over into the explicit synthesis of the separate moments.

So far we have regarded the moments as if they had the same value for the notion. In a certain sense this is true. Each is essential to the notion; and from this point of view the affirmation of one moment, the 'thesis,' cannot be regarded as higher than the affirmation of the other, the 'antithesis.' But the process of interrelating these two brings out a result which contains more truth than either moment separately, and issues in a stage which is higher than both taken together. In the final stage in which the process culminates, the explicit synthesis of the two separate moments, we have a form of the notion which combines the two and at the same time removes the one-sidedness in which each subsists. It is not a mere amalgam of the two preceding moments; it is a transformation of them, and is thus a further stage in the process of the notion, and is in that sense a new 'moment' in that process. Since it unites in itself the positive substance of the two preceding moments, and since these were the ultimate differences contained in the notion, this third moment completes the process of the notion, and brings into prominence the reality of the unity underlying those differences from the start. It reveals this unity in explicit form as the controlling principle of the differences, and reveals the differences explicitly as factors in the same single unity. In this third 'moment,' therefore, the notion has completely expressed itself, it has 'come to itself,' it has 'become conscious of itself.' In that sense the third moment is on a higher level than the preceding moments, and its truth is a higher truth regarding the nature of the notion. But it is not higher at the expense of the preceding stages; it is higher only by containing their truth, and, indeed, because it contains their truth. It cancels their isolation from each other, and also

their consequent opposition to each other. These, the isolation and opposition, are certainly removed; for, in the final stage or moment, the two preceding elements are so completely interwoven that their opposition has no longer any significance for the notion. Each so permeates the other that only a regressive process of analysis can even distinguish them. In so far, then, as their negative relation to each other was the result of their fundamental opposition, this negation, essential as it is to the process of the notion, is the transitional aspect of the process, and disappears in the resulting final moment. Contradiction, then, which is vital to the process, exists only in order to be removed; it is not final but transitional: to think out contradiction is to abolish it. Hence it is that the final or absolute notion is entirely free from and entirely cancels all the contradictions involved in and incident to the lower 'finite' notions. Hence Hegel's view, that contradiction is of the essence of finitude. The complete removal of contradiction is identical with 'true' infinitude, the self-closed and self-contained whole or absolute notion; conversely, wherever there is finitude there is process, and wherever there is process there is contradiction. The contradiction is thus not accidental to the nature of finitude, but inherent in it, and is, in fact, the very reason of its connexion with infinitude, the presence of which, again, in the finite may be said to be the source of the negative movement, the contradiction, in finitude as such. If the process were endless, if infinitude were an infinite progress or regress, there could be no contradiction and so no removal of it: we should have indefinite process in time, and not process in thought. Hence he names such a process the 'false' infinite, 'false' because it makes the attainment of a rounded system of truth, or indeed truth at all, meaningless and impossible.

How the 'higher unity' or 'higher truth' is arrived at, it is not difficult to see. We may best bring this out by recurring to the illustration previously referred to. The notion of property, we saw, is resolvable into the two ultimate factors of 'ownership' of a thing and the 'use' of the thing, these being opposed to each other. They are opposed because the ownership means the detention of the thing as the correlate of exercising a permanent or identical personal will in regard to the natural object, while the use of the thing means the dissipation of the thing, the evanescence of it, and hence the gradual loosening of the hold of the personal will over it. In the former element the notion of property is expressed in terms of the nature of personal will, in the latter it is expressed in terms of the nature of a thing or natural object. Personal will provides the aspect of identity or universality in the situation, the thing provides the aspect of diversity or particularity. Sharply opposed as these are, the analysis of the first, which is logically the prior element—since will must be exerted before a natural object can become a thing and enter into a self-conscious situation as property—brings out the second. For ownership to be effective, will must be repeatedly and continuously exerted over it, and the continuous exertion of will over a thing is precisely what is meant by 'using' it. But the continuous use of a thing means that, since the thing is particular and the will universal, the thing destructible and the will indestructible, ultimately the thing is exhaustible and therefore our hold over it is terminable. The termination of property in a thing is thus involved in the very nature of property. In fact, the complete termination of property in a thing is the very highest expression of what property means for a will. This termination may be brought about in two ways, either by exhausting it so that it is no longer of

'use' and so no longer our property, or by openly giving it up as our property. The capacity to do either is involved in complete ownership, 'complete ownership involves complete use'; the explicit surrender of ownership is the highest proof of complete ownership, the complete exhaustion of our interest in the thing is the complete surrender of its significance as our property and the return of the thing once more to the sphere of nature from which it was taken to begin with. This, the final stage in the process of the notion of property, is, in legal phraseology, the moment of 'relinquishment' of property. This moment therefore contains the positive substance of ownership in its purest and completest form, for we cannot relinquish what we do not own completely; and, on the other hand, it contains the positive substance of what is involved in 'use' in its completest form, for we cannot truly use a thing unless we can make it independent of ourselves at choice, unless we are completely free to 'do as we like with our own'; otherwise the thing determines our will and not our will the thing. Thus in relinquishment of a thing the will most clearly reveals its complete freedom in relation to the thing, and most clearly manifests that the thing has no will of its own but is absolutely subordinate to a personal will. Relinquishment in that way is the 'higher unity' of the separate elements involved in the notion of property. Yet it does not destroy their positive significance, for this is retained in the result; it removes their antagonism in a form in which that antagonism can no longer exist, because both the elements go to constitute what that form itself is, and are inseparably interwoven in this highest moment. This moment is the culmination of the process, or 'dialectic,' of property, for the notion of property is exhaustively expressed in this moment; and the notion of property can have further significance only as a part of a wider notion altogether, i.e. a notion expressing more fully the nature of self-conscious will which is at the basis of property. This further notion, as Hegel interprets the matter, is that of contract.

Such then in outline is the nature of the process, or 'method,' of the notion. Only one further question seems to be worth raising: How does Hegel know where to start the process, what element in the notion to place first? The answer to the question is obtained if we bear in mind that the aim of the process is the complete explicit realization of the whole of what a notion contains. The complete truth is the most concrete and systematic, the most or the highest individual. We cannot learn this all at once, and by mere intuition. It is a result. The result of the process determines the aim of the process, and the aim regulates the procedure. The procedure is thus from the simplest, most abstract, to the most articulated and complex, the most concrete. Hence the first moment is always the logically simpler, more ultimate, and more abstract. It is that without which no other stage in the process would be possible at all, and no advance capable of being made to the concrete result. What this is in the case of a given notion can be revealed only to logical analysis, exercised in the light of the result to be achieved. In general it may be said that the notion in its aspect of identity as such is taken as logically prior to and the condition of all further development of the notion; the aspect of diversity is then directly suggested and gives the second abstract moment. This holds good whether the notion we are seeking to unfold be such a comprehensive notion as that of the State, or a minor subordinate notion, like that of property.

The method of procedure above analyzed is precisely the same in essentials throughout the whole

of Hegel's system. It governs the process of evolving notions wherever they appear and whatever they be. The process of connecting all the content of the notion of the State, for example, is essentially the same as that of connecting the aspects of contract, or conscience, or a free constitution. And the process of connecting the constituents of the whole Absolute notion, the notion of Absolute Individuality, is precisely the same as that required to connect the content of any part of the system—Religion, the State, or Nature. No doubt the method varies with the notions considered, but only in the sense that form varies with content, and yet is inseparable from content. Doubtless, again, Hegel may have been more successful in carrying out his method in the case of certain notions and certain departments of philosophy than in others. Sometimes he may have failed altogether, and often his analysis is obviously strained, artificial, and forced. But these are necessary incidents of the inevitable fallibility of genius, and must be so regarded. It seems a mistake to treat, as McTaggart does, the variations in success of Hegel's use of his method as so-called 'changes of method' in the system. Misapplications are not deliberate changes; and the assumption that alterations were deliberate either convicts Hegel of insincerity in the construction of his system, or regards him as working out his system with mechanical and infallible success.

In the light of the method as above explained there is no difficulty in accounting for the fact that the process of connecting the elements of a given notion is the same in character as that which connects the variety of notions involved in a given sphere of the system and the totality of notions required to unfold the content of the whole system. For, just as from the point of view of a given notion its elements are 'moments' in the realization of that notion, so any given notion, short of the notion of Absolute Individuality, is a 'moment' in a wider notion, and is thus a stage in the realization of a completer truth. Property, for example, is a notion with subordinate 'moments,' but property itself is a moment in the realization of the notion of 'contract,' just as contract again is a moment which helps to unfold the complete content of 'abstract Right' as an expression of free personal will which is the basis of the notion of the State; and so throughout the whole system.

It is impossible to go over the ground covered by the operation of the dialectic throughout all the notions which emanate from reason in its interpretation or reconstruction of individuality in all its forms. To do this would require a re-statement of the whole system, and if given in outline would convey little concrete information. The whole value of the argument lies in its close association with the actual substance of reality; the vitality of the dialectic draws its energy from each concrete form of individuality in turn, and works with its content as the indwelling organizing agency. There is nothing formal in the procedure; the form of the method in fact takes on the colour and quality of the content. The principle that the notion of reason is the core of things being once for all adopted, it is henceforward throughout the system accepted as the truth of things, and reality is simply asked, so to say, to render up its meaning in terms of the notion and its method of procedure. The individual mind of the philosopher merely 'looks on,' as Hegel puts it, and records the result in the various spheres of truth into which reality naturally, or rather according to historically accepted divisions, falls.

6. Hegel's view of ethics.—The ethical life in its most comprehensive sense is a particular aspect

of a more general reality, that of finite mind. It is not the highest expression of finite mind, nor is it the lowest level at which mind exists. It arises at that stage in the process of mind's activity where, having reached consciousness of itself as a concrete reality, finite mind utters its substance in an objective form. It presupposes the conscious continuity of itself with nature, and freely commits the ends of its own being to the objective processes of nature, and finds nature supporting its own purposes. It determines nature by its own ends; it 'acts,' and does not in so doing feel any sense of loss, but, on the contrary, feels enlarged and enriched. Similarly, it presupposes the conscious continuity of finite mind with finite mind, the identity of self with self, the acknowledgment of self by other selves, and the open, concrete recognition of intercommunion of self with other selves, so that one self shares the life of another in definite ways, and is expanded in so doing. It presupposes, in short, the conscious universalization of mind, brought about and sustained through intersubjective intercourse which is carried on by all the means at the disposal of each mind—desire, emotion, end, etc. Of these forms of objectification—that through conscious union with nature, and through conscious communion of finite mind with finite mind—the latter is infinitely the more important, because of the more explicit and complete identity of the component factors in the situation, and because the first form is involved as a necessary means to the complete attainment of the second. Without 'nature' intercommunion of conscious selves would be impossible; without other selves mind would never rise above the limits and limitations of 'animated nature.'

When the resources of finite mind have been evolved to this level where it finds and accepts mind (finite mind) as its own object, an object responding to the call of the subject and evoking its potentialities, then mind is in a condition where the open and free interrelation of self with self is possible; and in this interrelation consist essentially the ethical process and the ethical life of man. It thus forms a level of the life of mind quite by itself. Compared with the previous stages of mind, it may be justly spoken of as 'objective'—explicitly universal and permanently embodied finite mind; the previous stages by contrast being spoken of as 'subjective' mind. And further, because this level of mind is its own creation and product, using nature, but not itself the outcome of nature, it is self-constituted and self-determined, and therefore free.

Thus the region of the life of mind where ethical life exists is that of free objective finite mind. This is the form of reality, the type of 'notion,' which has to be evolved by the science of ethics, and its parts logically connected by its inherent dialectic.

In the order of reality the whole comes before the parts, the complete before the incomplete; and in the whole we see most clearly the nature of that individuality with which we are dealing. The whole where finite mind is expanded and objectified in its completest way is historically the State. This is the most concrete phase of objective mind; this, in fact, is the concrete reality to which the notion of objective mind primarily refers, and which contains all other ways in which that notion is expressed. But in the order of exposition we must begin with the most elementary way in which this notion of objective mind is embodied, the simplest form in which the notion of free objectified mind is expressed. In every form, from the simplest and most abstract to the most complex and concrete, essentially the same principle is realized, but the fullness of its content, or its

'realization,' varies in degree of 'truth' or adequacy to the nature of the notion in question. What this simplest phase of the notion is can again be found only by experience; but this means no more than that the philosopher, observing the nature of the notion considered, is in touch with all the appearances of its reality.

The primary subordinate notions into which the concrete notion of objective mind falls are arrived at by a logical analysis of its content. Objective mind, free will, may sustain itself directly (a) through the external relation of will to will, (b) through the inner life of each self-conscious individual will being aware of itself as a self-contained unit of objective mind, and, (c) finally, through the free and unreserved intercommunion of mind with mind, an intercommunion which avails itself of both external and internal attitudes of will, but is a fuller realization of the objective mind than either. In each case we have the same factors, mind conscious of itself through explicit relation to other finite selves, and realizing itself in this relationship. The first is the sphere of the legal relationships of wills; the second, that of inner moral sentiment, purpose, all that is summed up in the term 'moral conscience'; the third is that of social institutions. These are stages in the fulfilment of the same end, and are only logically separable moments of that one end. Thus legal relations are impossible by themselves; no social order, no objective mind, could subsist by them alone, for the obvious reason that in them the notion of mind is not fully realized. The inner side of mind—what the individual is 'for himself'—is ignored in law, or considered only as relatively subordinate, as having significance only in so far as it throws light on 'acts,' on the external expressions of will which are alone the sphere and interest of law properly understood. Yet the inner side is of supreme importance to the individual, and also of supreme importance to the complete life of society. It is at least of equal importance with law as a realization of mind, and is in any case as necessary for the complete expression of the mind's nature. The fullness of intercommunion of mind with mind demands that the powers of response within the individual shall reflect and correspond to the demands made upon it by others. The third stage is equally necessary, and cannot subsist apart from the two preceding; for the complete intercommunion involved in social institutions is as impossible and incomplete without legal relations as it is without the inner adjustments of the individual mind to the inner life of others.

Taking these primary elements in the constitution of the complete notion of objective mind, Hegel analyzes them as successive stages, and under the general designations of (1) abstract law, (2) morality (*Moralität*), and (3) the social order (*Sittlichkeit*). Each of these is a notion, a subordinate notion in the whole, but a notion none the less, because each has an individuality all its own, is a unity in difference.

(1) The forms assumed by the external relation of mind to mind constituting the sphere of law are easily stated, and are more or less familiar in every historical code of laws. Individual wills may be legally related and combined indirectly or directly, positively and negatively. (i.) They are related externally and in an indirect manner when some external, 'natural' object is the common centre of their interest and of the activity of their separate wills; this is the sphere of property, essentially an objective realization of mind and a relation of one mind to another, *meum* and *tuum* being correlative and inseparable terms; it is primarily positive and only in a secondary sense negative. (ii.) They are directly related when two or more wills have

a mutual hold over each other as regards certain actions of their respective wills, and on certain explicit conditions mutually and freely arranged between the separate wills so related; this is the notion of contract. Only a limited range of the activity of an individual will can be contracted away; hence, no matter how close the contract, the individual wills as such still retain their independence; a will cannot contract itself entirely away without self-contradiction and without contradicting the notion of a contract. It is a fuller realization of objective mind than property, because contract enters more deeply than property into the structure of the individual will; the very powers of a will, as such, are made the basis of the contract. It is both positive and negative in explicit terms, for a contract explicitly limits as well as unites the contracting wills. (iii.) The third form in which wills are related externally is primarily negative, and only in a secondary way positive. One will may, of itself and without the acknowledgment of another will, invade the domain of individuality of another, and to some extent curtail the activity of this will. The invading will may do so to any extent, even to the destruction of the existence of the invaded will, and may do so unconsciously or deliberately. The relation is here primarily negative, because one of the wills thrusts the other aside and does not admit its reality, while the other (invaded) will in its turn reacts on the first and denies the reality of the invading will as regards the specific action of that will. This is the notion of wrong-doing in all its forms, 'civil' and 'criminal.' It is obviously an external relationship; still it is a relation, and a relation of an objective kind, for each acts and expresses his will before the eyes of the other.

The above notions exhaust the possible external relations of wills to one another, and the last stage enters even more deeply into the substance of will than either of the others, more especially when the wrong-doing is deliberate. For in wrong-doing the agent and the sufferer call upon the inmost claims and resources of their personality in order to assert and defend their respective positions; and the process of removing the wrong makes further demands on the concrete nature of their individuality in order to reinstate their true relations to each other. Their value in their own eyes and their significance for the society to which they belong are called in question, and force them to bring out more explicitly their real nature as wills, and establish as the result a concord which has an inner side as well as an outer. This appears very clearly, for example, in the effect of punishment on the wrong-doer.

It is probably because of this effect of the process of wrong-doing and of its removal that Hegel finds the logical connexion between 'law' and 'morality' at the point where wrong is righted. The logical transition seems indeed forced and artificial, as so many of his transitions from one fundamental notion to another can be shown to be; and certainly it is by no means so convincing as that between the successive stages of the analysis of law.

(2) Morality, or the inner side of realized mind, likewise has its various modes of expression. The analysis of morality is one of Hegel's richest and most subtle contributions to the interpretation of the moral life, even if we add that its value lies less in the framework of its logical order than in its insight into concrete moral experience. An individual's morality is the working plan through which the inner processes of his mind are brought into the service of an objective life with other individual minds. It is not therefore a private preserve of individuality, within which he shuts him-

self off from society; it can be so applied, no doubt, but when so applied it becomes the source of evil and not of good for the individual. The true conscious good of the individual lies in the subordination and regulation of the functions of his inner life in the interests of a systematic unity with his fellows. The conception of such a unity, consciously operating upon the inner conditions of his activity, relative to his peculiar place in the objective system, and growing into definiteness and clearness with the success of his efforts to attain it—this is the good of and for the individual as a specific centre of finite mind. This region of morality may therefore be described as the individual's conscious perspective of his objective life with his fellows, and is the process of realizing and reflecting in his inner life the objective system of social well-being with which he, as a special centre, is bound up. It covers such facts as intention, conscious purpose, happiness, duty, emotion, and, highest of all expressions of this attitude, the individual 'conscience' with its possibilities for good and for evil to the individual. The whole inner life of the individual is in this way a moral microcosm of the objective self-contained macrocosm of a historical society, and is realized directly on its own account, indirectly as an embodiment of complete objective mind.

(3) The third stage of objective mind—the social order—covers all that we mean by the institutional aspect of the life of a society. Here we have the free unreserved interaction of individual mind with individual mind, the interweaving of interests and purposes within and without the conditions of universal law, with and without the sanctions and guidance of individual conscience. Institutions are the utmost individuals can achieve in the relations they establish with one another; and they contain all the human interests of which their finite individualities, so far as intercommunicating, are capable. From one point of view they are expressions of finite mind, from another point of view finite minds are the living particular foci of the objective concrete spirit embodied in institutions. More than all else in objective mind, therefore, institutions are 'ends in themselves.' They are in no sense creations of 'nature,' because institutions use nature as instrumental for the continuous intercommunion of finite spirits. They are, however, created by self-conscious mind at its highest level, created as universal embodiments of mind, and created for the maintenance of universal and constant relations between individuals. They are always 'instituted,' set up by deliberate resolve; and, once established, are maintained rather by the universality of the ends they embody than by the clear conscious resolution of their component individuals. They have a kind of life of their own once they are set going; and they continue in being by their own single reality, whose complete significance any given individual may be only partially aware of, and as a rule only partially shares. Much of the life of institutions is for the component individuals unknown, much is carried on by conscious automatism, and in some cases, *e.g.* the State, the institution is maintained even against the judgment of the individual regarding his conscious interests. Still this unconsciousness in the life of institutions is at most a mere matter of degree, and rather a psychological condition of carrying on the institution than a logical aspect of its structure. Consent and intelligence are always presupposed, and the self-consciousness in which the institution is rooted may break out at any time into criticism and lead to further initiative and progress in the life of the institution.

In a word, then, the institutional stage of ob-

jective mind is the direct and conscious operation of a definitely realized collective unity of individual minds upon the individual components sharing in its life; a unity maintained through each, but more concrete than any; a unity secured on certain expressed formulated conditions and therefore implying 'law'; a unity permeating the inner processes and well-being of its components, and therefore involving what the stage of 'morality' contains. It is logically higher in value than the preceding stage, and ethically higher in authority and significance. It is historically prior in existence to the component individuals, and prior therefore to both 'law' and individual morality. In its earliest forms its mode of regulation is that of 'custom,' and custom is at first the source of law and the ruler of conscience. In its highest forms the social order is a blend of custom and self-conscious regulation, the former acting as the conserving, quasi-unconscious method of procedure, the latter as the principle of criticism, initiative, and progress.

The institutional condition is capable of indefinite development, and there is, strictly speaking, no practical limit to the number of institutions. But historically and in principle some institutions are more rooted in the natural conditions of man, more lasting in character, and more universal in their purpose than others, and so more fundamental in the structure of objective mind. Such are the institutions of the family, the city, and the State, and these again are in the order of their ethical importance. The first is based on the natural organic fact of sex; provides the sphere for inter-communion of particular minds in terms of natural affection, sympathy, and direct personal helpfulness; and has its larger ethical significance in the rearing and moulding of new individuals for the wider life of the whole community. The second rests on the natural need of varied organic sustenance; gives rise to and makes possible the complex interdependence of co-operating individuals each and all engaged in obtaining a livelihood; and finds its larger ethical significance in the organization of economic relations in such a way as to give free opportunity of self-expansion to all and protection to each in the fulfilment of his function. The third rests on the need of forceful security from interference from without the community, of regulated security from interference as between individuals and minor institutions within the society, and of concentrating the whole resources of objective mind in a single all-comprehensive dominating unity, which is capable of acting on every part and giving rounded completeness to the ethical life of finite objective mind.

The State is thus the culmination of the reality of objective mind as an organized ethical whole of human purpose consciously acting on the individuals and fulfilled by them. As an ethical whole each State is or should be a single individuality, self-contained, and therefore sufficient for the ethical life of its component individuals. The finitude of any given State is inseparable from it, and is a limitation as regards its capacity to exhaust the life of humanity as such. Each State is but one State amongst other States, all expressive of humanity. The ethical life is therefore a restricted area of reality, and not an exhaustive expression of the Absolute, or, for that matter, even of humanity. When, however, we pass beyond the State and consider the life of humanity as embodied in all States, we pass from the ethical life proper to the drama of human history. This is inseparable from the course of the world in all its aspects. The treatment of States from this point of view is undertaken by the more comprehensive part of Hegel's system, the 'Philosophy of History,' an interpretation of States as realizing

in various degrees the idea of freedom of will embodied in each State.

7. Hegel's view of religion.—Religion occupies a peculiar position in Hegel's philosophy. Philosophy as a whole and in its parts is determined by its object; it always has a definite form of individuality to deal with. Reality as the absolutely individual whole is the supreme object of philosophy; the evolution of its content is the systematic development of the Absolute Idea, the reason-constituted essence of Absolute Spirit. The various divisions and subdivisions of the philosophical system, nature, finite mind, etc., are dealt with as specific individuations of this ultimate reality; their content is evolved in detail as 'moments' of the supreme truth, and thus gives rise to the various parts of the absolute philosophy, the various 'philosophical sciences.' Beyond the one complete absolute science and the various subordinate 'sciences' in that system, beyond reality as a whole and reality in its parts, there is nothing for philosophy to deal with. A philosophical science is the systematic evolution of the real in terms of its fundamental essence or notion; and the real is a whole of parts, a unity of diverse elements.

Now religion is not an object in the sense of a sphere of reality: it is an attitude towards an object. The only form of object possible is either the Absolute or some specific sphere of the Absolute. As Hegel continually asserts, the object of the religious attitude is the Absolute in its unity, in its completeness, in its 'truth.' But this reality is also the peculiar domain of philosophy, or speculative science; and speculation in Hegel's view is alone necessary and sufficient to give the complete truth about the Absolute. Here then lies an obvious difficulty. It cannot be met by saying that the Absolute in philosophy is not the same as the Absolute in religion. The latter, as well as the spirit, of Hegel's system is against such a view: the Absolute in philosophy is emphatically identified with God in religion, and in the highest religion there is not even the semblance of contrast. Nor are there two truths about the Absolute; the Absolute is the supreme truth and the supreme truth is one. Hegel's solution of the difficulty is found in drawing a distinction between the 'form' in which the Absolute is grasped in the case of religion and of philosophy, and the 'content' which they both deal with. The 'form' is different in the two cases, the 'content' is precisely the same. The same Absolute is present in both and in the same sense, viz. as Spirit, self-conscious and rational; and its mode of realization is the same, viz. it is 'conscious of itself' in the religious mind as well as in speculative philosophy. But the medium through which its realization is effected, the 'form' in which the 'content' is expressed, is in religion that of feeling, of sensuous intuition, and of significant sensuously symbolical general ideas, whereas in philosophy the 'form' is that of the notion *quâ* notion (as above explained, p. 572 ff.).

This solution, however, only raises a further difficulty. The notion, as we have seen, is the final form in which truth appears, and the notion alone is entirely adequate to convey absolute truth. Is the 'form' used by religion an approximation to the notion, or is it co-equal in value with it for the Absolute which expresses itself in the religious life? There is no doubt that Hegel's view is that the religious 'form' is not in itself completely adequate to the essential nature of Absolute Spirit, and that the religious 'form' calls for and is compelled by its own 'dialectic' to pass to the supreme form in which truth is embodied—the 'notion.' Hence it is that on his view philosophy, and not religion, is the highest expressor

of self-conscious spirit; and that speculation is the final stage and 'crown' of the life of spirit.

It is difficult to resist drawing an obvious inference. If it is possible, as Hegel maintains, to convey the truth about the Absolute in the form which is the essence of the Absolute (self-conscious reason), and thus perfectly adequate to the nature of the Absolute, then religion is simply the way of error; if, on the other hand, religion is not the way of error, the claim of philosophy to express the final truth about the Absolute is untenable, since the Absolute requires to express *itself* in the sphere of feeling, intuition, and representative ideas, *as well as* through the notion. On the former alternative, religion is in strictness unnecessary, and philosophy is all that God requires to convey His truth to finite spirit; on the latter alternative, religion is necessary and philosophy has no claim to priority of value over religion, since the Absolute is its own standard of value and one form of self-expression is as needful as the other. Either philosophy fulfils a purpose altogether different from religion, or else philosophy is not by itself the highest and completely concrete expression of the Absolute.

The ambiguity involved in Hegel's position was not merely a source of great perplexity to his followers, and led to diametrically opposite interpretations of the religious significance of his doctrine, but it was clearly a source of trouble to himself when he came to define the boundaries of religion and philosophy. It is easy to see how the difficulty arose. Hegel claims that it is possible in virtue of the principle of his system to take up a theocentric position, and to express not simply what the finite spirit thinks of the Absolute Spirit, but how the Absolute Spirit must itself think. Thought, in the sense of the 'notion,' is absolute thought, thought as it is *for* the Absolute. In religion and pure speculation we have before us what the Absolute Spirit is in and for itself and how it articulates itself. Religion is the 'self-consciousness of God,' not simply how finite spirit is conscious of God, but how the Absolute Spirit is conscious of itself in finite spirit: the Absolute Spirit 'manifests itself' in man, and the manifestation does not conceal but openly reveals its very nature. The revelation of God to man in religion and God's revelation of Himself to Himself in finite spirit are one and the same revelation, much in the same sense as Spinoza maintained that the 'intellectual love of God' was at once 'God's love of Himself' and 'man's love of God.' Similarly, with the necessary change of 'form,' speculative philosophy is the 'self-consciousness of the Absolute Spirit,' the notion of Absolute Mind articulating itself to itself and to finite mind at the same time, since finite mind adds nothing and detracts nothing in the process, but merely 'looks on' at the process of self-articulation. In the result, therefore, the system of notions constituting the substance of the Absolute Reason is the thought of God, as He was or is in the beginning 'before the creation of nature and finite spirit.' Self-manifestation in religion, self-articulation in speculative science—both proceed from the same Spirit; both are therefore necessary to it, as indeed both are commonly considered inevitable in the life-history of finite experience. How then can the two be distinguished? More especially how can the two be distinguished in terms of and by the necessity of the 'notion,' so as to satisfy the demands of a philosophy which lives and moves within the sphere of the 'notion'? How can the notion dialectically exhibit the necessity of two separate self-revelations of the Absolute Spirit? How can the notion justify by its own procedure an 'inferior' and less adequate expression of the

nature of the Absolute than that supplied by the notion? How, in short, can the notion find a place within its own form for a non-notional representation of the absolute truth?

It is not surprising, when we view the matter in the light of the above, that Hegel's efforts to draw the line between religion and philosophy should show considerable vacillation. Thus we find at one time art treated as a part of religion, at another time religion treated as separate from art; at one time art and religion are distinguished as regards their form of expression, at another the form adopted by art is used as a means to give substantiality to the religious attitude. Again, religion is regarded as independent of philosophy and as a vitally necessary moment of expression; at another time religion is treated as a prelude to philosophical truth, yielding up its claims to be truth when the higher point of view of philosophy is reached; at one time religion is a phase of philosophy, at another philosophy is a phase of religion, since philosophy is 'also the service of God'; at one point 'feeling,' 'intuition,' and 'symbolic representation' of God are cancelled and superseded in the 'notion,' as indeed in a sense they must be since they are lower levels of conscious life; at another time these forms are treated as individual forms embodying in themselves the notion like any other individual mode of reality, and so capable of being interpreted and dialectically developed in terms of the notion.

This uncertainty of treatment seems almost inevitable in a system which claims as philosophy to interpret the Divine mind and also to give a philosophical interpretation of a religious, or non-philosophical, apprehension of the same reality, which seeks to be a religious philosophy and yet to find an independent place in its scheme for a philosophical religion, which asserts that the 'Logic,' or general ground-plan of the system, is 'theology,' and at the same time tries to justify the claims of historical theology. Religion was accepted as a fact of history, and its nature had to be traced to its source in the Absolute. In the religious life, finite spirit claims to be in communion with Absolute Spirit. Hegel's view of philosophy required him to prove that such communion arises from the necessary procedure of Absolute Spirit, and that it was thus a stage in the evolution of the Absolute Idea as expounded by philosophy.

Enough has perhaps been said to indicate that whatever value attaches to Hegel's analysis of religion, his attempt to fit religion into the dialectical construction of his system cannot be regarded as either successful or logically satisfactory. However we interpret his position, it appears unconvincing. On the face of the matter, it seems as unaccountable that the Absolute should adopt the confessedly imperfect media of 'feeling' and 'symbolic ideas'¹ to convey its truth *to itself* as it is for finite spirit, when, so to say, it always has in its grasp for the same purpose the perfect medium of self-expression, the 'notion.' On the other hand, the elimination of all personal qualities in the logical coherence of the notion is a consummation of the religious life which is attained at the cost of the intimately personal communion of finite spirit with Absolute Spirit, in which, as Hegel asserts, religious experience is rooted; and, if the choice has to be made at all, there is little doubt that the religious mind, even in the highest form of religion, will not regard Logic as an adequate substitute for Love. When, again, we consider the endless varieties in mood and expression assumed by religious life in the course of the

¹ This symbolic character of religious ideas is never transcended; it is found in the highest or 'absolute religion' as well as in the 'religion of nature.'

history of mankind, it seems nothing else than grotesque to treat all the creations of the religious attitude, from the phantoms of primitive fear to the aspirations of the saints, as expressions of the self-consciousness of God in the soul of man. Dialectical necessity of that kind does more than justice to the folly of man at the price of doing less than justice to the wisdom of God. In the history of religion, as in history generally, it may be true to insist that the *'Weltgeschichte ist das Weltgericht'*; but a judgment of the world is not a justification of it.

Setting aside, then, the difficulties presented by Hegel's attempt to build religion into the logical structure of his system, the success of his analysis of religious experience is not seriously affected by its somewhat artificial association with the exigencies of his method. Religion in his view is a conscious relation of finite spirit to the Absolute as spirit, and from this fundamental principle everything else follows. The relation is double-sided, and is maintained through spiritual activity of both the terms involved. God as the supreme spiritual unity of man's world (nature and finite spirit) communes with man as spirit, and this communion takes the form essentially of 'manifestation,' 'revelation.' The activity of spirit is necessarily self-manifestation, manifestation to a self, and manifestation of a self. This manifestation constitutes the truth, the substance, the reality of religion. Being not merely truth about God, but truth of God, God as truth, this manifestation is at once God's consciousness of Himself in man, and man's consciousness of God in himself. The truth is one and the same on both sides, and both are aware of the same truth. The peculiarity of the religious life just consists in this essential unity of man's spirit with God's spirit, a unity that defies separation. The imperturbable 'certainty' in the religious mind of its direct intimacy with Absolute Spirit is the psychological effect of this fundamental unity. This certainty is found in all religious experience, and is so complete that it can and does take the form of mere 'feeling,' as well as the form of thought. Its 'beliefs' are often a blend of feeling and idea, and its beliefs are always immediate to the religious consciousness.

In maintaining this attitude, however, man never confuses the position of God in the relation with that of man. God is the self-revealer, man is the recipient of the manifestation. Man does not create the reality, the truth, revealed to him; he accepts it. His attitude is that of 'submission,' 'worship,' 'acquiescence,' 'expectancy'; God's attitude is that of the 'all-giver,' the 'all-wise,' the 'all-powerful,' the 'deliverer.' The immediacy of the communion never cancels the distinction of the terms related, finite spirit and Absolute Spirit.

The relation, again, is that of the concrete human spirit to the Absolute. The union may be effected through any element of nature or finite spirit; and the manifestation may adopt as its vehicle of communication with man's spirit any level or function of conscious life, whether in the sphere of feeling, ideas or volition, theoretical or practical. These together—the feature of nature or finite spirit by which God is expressed, and the mode of conscious life which constitutes the form of conscious communion with God—determine the different kinds of religious attitude which can be assumed, and the different types of religions which historically appear. Thus God 'appears' in and is identified with the realm of sense, with objects and powers of nature inorganic or organic, with the purposes of man's moral life, with the purposes that keep man and nature together, and with self-consciousness in its purest expression. Similarly God communicates with man's mind through pure feeling,

through 'intuition,' through symbolic general ideas, through the 'notion' of reason. And, just as it is not the part of nature, or of man's life as a part, that is the objective reality for the religious mind, but the one Absolute Spirit as focused in the part, so the mere feeling or idea is not looked upon as conveying an impersonal systematic truth about God, but as a channel of communication with God, and indeed as a *consciously* imperfect medium of conscious communion, a symbolic language of human apprehension, a figurative human suggestion used to make vivid and personal the concrete consciousness of the Divine presence in man's soul. If the idea used is taken as literal systematic truth, it is not merely on critical analysis found to be untrue, but it loses its religious significance: it becomes an attempt at speculative impersonal interpretation, not a channel of spiritual personal communion.¹ This can be illustrated from the ideas found in any religion, viz. the 'wrath' of God, God as 'Creator,' God as 'Father,' and even more abstract ideas, such as God as 'First Cause.'

In the religious life there is a constant process taking place in the soul of man by which the communion is effectively realized and sustained, an activity by which that union is kept up, or restored when interrupted. In contrast to the way in which God is presented to the soul, which Hegel describes in one passage as the 'theoretical' aspect of religion, this process of supporting the union and restoring an interrupted union is called the 'practical' aspect of religion. This practical aspect is the cult; it constitutes an inseparable element in every religion, and varies with each religion as the idea of God varies.

The foregoing is in brief Hegel's general notion of religion with the essential elements found in one form or another in every religion. It will be seen at once that this notion owes quite as much of its contents to psychological analysis of religious experience as to logical analysis of the nature of Absolute Spirit. Still more close is the connexion between the history of religion and his 'notion' of religion, when we consider the further development of the argument in the 'Philosophy of Religion.' While no doubt Hegel intended to portray the logical evolution of the stages required to realize the above notion of religion in its completeness, the evolution owes as much to psychology and history as to logic; and it is not easy to say which is the most important. The notion of religion is realized; i.e., man is conscious of God or God becomes conscious in man, at all the levels at which finite consciousness exists—sense, understanding, reason, spirit. These levels form together a succession of stages in the fulfilment of the life of human consciousness, the connexion and evolution of which constitute in part the 'Phenomenology of Mind.' The evolution of the notion of religion follows the course taken in the development of the stages of consciousness. Again, by what seems to the student of Hegel's system a piece of good fortune, but which is doubtless the background of Hegel's own thought, there is a historical type and form of religion corresponding to each of these stages in the morphological development of consciousness. This historical material is drawn from the history of mankind in general and the history of religions in particular. Each specific religion has its place determined in the evolution of religion in general by the stage in the evolution of consciousness to which it corresponds and at which it is realized. Thus the evolution of consciousness mediates the connexion between the general notion of religion and the general history of religious experience in mankind. By this means Hegel's development of

¹ This confusion is precisely the source of the 'conflict between science and religion,' or between philosophy and theology.

the notion of religion is at once a statement of the way in which the notion of religion is gradually evolved and exhaustively realized in finite spirit, and also a genetically constructed system of the historical forms in which religion has appeared. In a word, his notion of religion is evolved in its concreteness by giving a morphogenetic construction of the forms assumed by religious experience in human history. It is 'logical' in the sense that the forms are arranged so as to show an ever-increasing advance in the notion from abstract to concrete; it is 'historical' in the sense that specific religions are extracted from human history because they typify in actual form and reveal to analysis the stages in this advance.

We have therefore in the working out of Hegel's 'Philosophy of Religion' a plan adopted which is the same in principle as that followed in his 'History of Philosophy,' or again in his 'Philosophy of History.' Just as the 'History of Philosophy' may be described as philosophy itself 'taking its time,' or at least taking time for its unfolding, and history in general as human 'freedom' in the making, so we may describe the history of religion as the notion of religion working itself out under the conditions of time and human limitations. It is altogether in the spirit of Hegel's system to demonstrate the inseparable unity of notion and reality, to establish the notion as the essence of the real. In the case of religion the real is cast in the mould of history, and bound up with the course of time. Hence the evolution of the notion of religion must necessarily be the evolution of an historical reality.

We need not trace here in detail the analysis Hegel gives of the various historical religions. Suffice it to say that he finds the simplest forms of religion to be the religions of Nature, i.e. with natural objects of sense as their media; the middle forms of religion to be those of Greece and Rome; the highest or absolute form of religion to be Christianity. The outcome of his argument would thus seem to be the philosophical defence of the place claimed for Christianity amongst the peoples of Western Europe. The critical student may suspect such a result of savouring of predilection and partisanship rather than of abstract impersonal logic, and may find more than traces, in such an argument, of the spirit of all theodicies. But on the first count Hegel claims that to be a sound Lutheran is to be on the side of reason, and on the second he does not hesitate to maintain that all philosophy is in the long run a theodicy.

LITERATURE.—I. BIOGRAPHY.—K. Rosenkranz, *Hegels Leben*, Berlin, 1844; *Hegel als deutscher Nationalphilosoph*, Leipzig, 1870; K. Hegel, *Briefe von und an Hegel*, do. 1887; R. Haym, *Hegel und seine Zeit*, Berlin, 1857; K. Köstlin, *Hegel in philos., polit., und nation. Beziehung*, Tübingen, 1870; Kuno Fischer, *Hegels Leben, Werke, und Lehre*, Heidelberg, 1901; *Hegel-Archiv*, ed. G. Lasson, vol. i., Leipzig, 1912.

II. WORKS.—*Werke*, 18 vols., Berlin, 1840 ff. (the volumes containing the different parts of the system were edited by different pupils and friends of Hegel); some of the volumes have been translated into English: *The Philosophy of History*, tr. J. Sibree, London, 1857; *The Logic of Hegel*, tr. W. Wallace, Oxford, 1892 (=vol. i. of Hegel's *Encyclopædie*); *The Philosophy of Mind*, tr. W. Wallace, do. 1894 (=vol. iii. of Hegel's *Encyclopædie*); *The Philosophy of Religion*, tr. E. B. Spiers and J. B. Sanderson, London, 1895; *The History of Philosophy*, tr. E. S. Haldane and F. H. Simson, do. 1892-96; *The Philosophy of Right*, tr. S. W. Dyde, do. 1896; *The Phenomenology of Mind*, tr. J. B. Baillie, do. 1910; *The Introduction to Hegel's 'Philosophy of Fine Art'*, tr. B. Bosanquet, do. 1886; *The Philosophy of Art*, tr. W. Hastie, Edinburgh, 1886.

III. EXPOSITION AND CRITICISM.—(1) General.—F. A. Staudenmaier, *Darstellung und Kritik des hegelischen Systems*, Mainz, 1844; K. P. Fischer, *Speculative Charakteristik und Kritik des hegelischen Systems*, Erlangen, 1845; R. Haym, *Hegel und seine Zeit*, Berlin, 1857; J. H. Stirling, *The Secret of Hegel*, 1865, new ed., London, 1898; Kuno Fischer, *Hegels Leben, Werke, und Lehre*, Heidelberg, 1901; A. Ruge, *Aus friherer Zeit*, Berlin, 1867; E. Caird, *Hegel*, Edinburgh, 1883; R. Mackintosh, *Hegel and Hegelianism*, do. 1903; general essays on various topics by A. Vera, E. Scherer, C. J. G. Bartholmess, J. M. E.

McTaggart, A. Seth Pringle-Pattison, H. Ulrici, G. Biedermann, K. Rosenkranz, H. Hadlich, C. L. Michelet, F. Rehm, G. A. Gabler, W. T. Harris, G. A. Wyneken.

(2) Special.—(a) On the *Phenomenology of Mind*: W. Purpus, *Zur Dialektik des Bewusstseins nach Hegel*, Berlin, 1908; M. Rackwitz, *Hegels Ansicht über die Apriorität von Zeit und Raum und die kantischen Kategorien*, Halle, 1891; G. A. Gabler, *Kritik des Bewusstseins*, ed. Bolland, Leyden, 1901; A. Bullinger, *Hegels Phänomenologie des Geistes*, Munich, 1904; introductions to the editions of G. Lasson (Philos. Bibliothek, Leipzig, 1907), G. J. P. J. Bolland (Leyden, 1907), J. B. Baillie (London, 1910).—(b) On the *Logic*: W. Wallace, *Prolegomena*, Oxford, 1894; J. M. E. McTaggart, *Commentary on Hegel's Logic*, Cambridge, 1910, *Studies in the Hegelian Dialectic*, do. 1890; A. Schmid, *Entwicklungsgeschichte der hegelischen Logik*, Regensburg, 1858; J. B. Baillie, *The Origin and Significance of Hegel's Logic*, London, 1901; G. Noël, *La Logique de Hegel*, Paris, 1897; H. S. Macran, *Hegel's Doctrine of Formal Logic*, Oxford, 1912; W. T. Harris, *Hegel's Logic*, Chicago, 1890; J. G. Hibben, *Hegel's Logic*, New York, 1902; F. A. Trendelenburg, *Die logische Frage in Hegels System*, Leipzig, 1843, *Logische Untersuchungen*, do. 1862; A. Bullinger, *Hegels Lehre vom Widerspruch*, Dillingen, 1884, *Hegelsche Logik*, Munich, 1900; K. Werder, *Logik*, Berlin, 1841; C. L. W. Heyder, *Darstellung und Kritik der hegelischen Dialektik*, Erlangen, 1845.—(c) On the *Philosophy of Nature: Philosophie de la nature*, tr. A. Vera, Paris, 1863-65; J. M. O'Sullivan, *Vergleich der Methoden Kants und Hegels auf Grund ihrer Behandlung der Kategorie der Quantität*, Berlin, 1908; O. Closs, *Kepler und Newton und das Problem der Gravitation in der Kant., Schelling., und Hegel. Naturphilosophie*, Heidelberg, 1908; J. H. Stirling, *Lectures on the Philosophy of Law* (Appendix: *Whewell and Hegel, and Hegel and Mr. W. R. Smith, a Vindication*), London, 1873.—(d) On the *Philosophy of Law*: G. S. Morris, *Hegel's Philosophy of the State*, Chicago, 1887; J. A. Marrast, *La Philosophie du droit de Hegel*, Paris, 1869; C. M. Kahle, *Darstellung und Kritik der hegelischen Rechtsphilosophie*, Berlin, 1845.—(e) On the *Philosophy of History: Die Philosophie der Geschichte*, ed. F. Brunstäd, Universal-Bibliothek, Leipzig, 1907 (Einleitung); P. Barth, *Die Geschichtsphilosophie Hegels und der Hegelianer*, do. 1890.—(f) On the *Philosophy of Religion*: L. Noack, *Der Religionsbegriff Hegels*, Darmstadt, 1845; M. Ehrenhauss, *Hegels Gottbegriff in seinen Grundlinien*, Wittenberg, 1880; C. A. v. Eschenmayer, *Die hegelische Religionsphilosophie verglichen mit dem christlichen Princip*, Tübingen, 1834; E. Ott, *Die Religionsphilosophie Hegels*, Berlin, 1904; H. Richert, *Hegels Religionsphilosophie*, Bromberg, 1900; J. Werner, *Hegels Offenbarungsbegriff*, Leipzig, 1887; G. J. P. J. Bolland, *Hegels Philosophie der Religion*, Leyden, 1901; J. M. Sterrett, *Studies in Hegel's Philosophy of Religion*, London, 1891.—(g) On the *Philosophy of Art*: J. S. Kedney, *Hegel's Aesthetics*, Chicago, 1885; T. W. Danzel, *Über die Aesthetik der hegelischen Philosophie*, Hamburg, 1844.

J. B. BAILLIE.

HEINE.—I. Life and writings.—Heine was born on the eve of the 19th cent.; whether the year was 1797 or 1799 has been a matter of dispute which can never be finally settled, since all the records have been destroyed by fire. He himself insisted that 13th Dec. 1799 was the correct date, and, erroneously regarding 1st Jan. 1800 as commencing the new century, spoke of himself as the first man of the 19th century. He was born at a time when the despotism which had tyrannized Europe was rapidly breaking up and yielding before the approaching forces of democratic freedom. He was a supreme illustration of that close alliance between tragedy and comedy which stamps all periods in which new wine is fermenting in old bottles. Düsseldorf was his native place, and this circumstance perhaps partially accounts for the spell which France cast over him, and for his satiric attitude towards the Teuton peoples; for the French were dominant in the Rhenish provinces during his earliest years. Yet he was in a sense without nationality. His parents were Jewish. The father, Samson Heine, was easy-going and unintellectual, unlike his brother Solomon, who became one of the richest men in Germany, but he was fond of art and music, and gained the deep affection of his son; the mother, who came of a cultured, originally Dutch family, was full of energy, well-educated, an admirer of Goethe and Rousseau, and had the greater influence on the mind of Heine. Harry, as he was christened, was their eldest child; his nature seemed to embrace the most contradictory of traits, for 'in soul he was an early Hebrew; in spirit, an ancient Greek; in mind a republican of the nineteenth century' (Sharp's *Life*, 12). He

was a quick boy, an energetic and appreciative lover of books, and he availed himself of opportunities for study which were given him by an uncle who was a studious physician and minor author.

From his early attempts at verse Heine was sent to the drudgery of a bank at Frankfort. After a period of business life in Hamburg with his uncle Solomon Heine, an unsuccessful venture on his own account, and the disappointment of a rejected proposal to his cousin Amalie, he left Hamburg to study law at Bonn in 1819, his maintenance being provided by his rich uncle. Thence he moved to Göttingen, and then to Berlin, where his first volume of poems appeared in 1821. Hitherto he had paid little attention to law, being engrossed in German history, literature, and æsthetics, but under Ed. Gans he eagerly studied the history and theory of jurisprudence, and even began a treatise on the *Constitutional Law of the Middle Ages*. Here, also, he came under the influence of Hegel, and he was admitted into literary coteries which gave him opportunities of meeting the most eminent men of letters. He formed a friendship, which became very intimate and lasted all his life, with Moses Moser, a man possessing a wide knowledge of men and affairs, and well versed in literature and philosophy. After a period of ill-health, he returned to Göttingen in 1824 and resumed the study of law. In that year he took a walking tour through the Harz Mountains and wrote an attractive account of his journey, partly in verse and partly in prose. The journey included a brief visit to Goethe, which he describes in one of his letters to Moser.

In 1825, with the sole view of being promoted to legal office, Heine was baptized into the Christian Church, much to his regret in later years, for his action served only to render him suspect among Christians and Jews alike. Shortly afterwards he took his degree of Doctor of Laws, and in that year and the following Julius Campe published his *Reisebilder* (*Travel Pictures*) in two volumes, an autobiographical sketch called *Ideen: Das Buch le Grand*, and more poems. Heine now visited England (from April to August 1827), but formed only a poor impression of London. 'Send a philosopher to London, but on your life not a poet,' he wrote in his *Englische Fragmente*. On returning to Germany he found that his *Reisebilder* had created a very favourable impression, and that the official ban, placed on the books in Prussia and North Germany on account of his freedom of expression in treating current religious and political questions, had served as a valuable advertisement. He now confined his attention to journalistic work in Munich, and had great hopes of an academic position of importance from King Ludwig I., who was reorganizing Bavaria. Indeed, considering himself certain of his appointment, he left for a tour in Italy, which supplied materials for a further volume of *Reisebilder*, conceived after the same plan, or absence of plan, as the earlier volumes, but even more bold in criticism, directed against all conventions which he regarded as antagonistic to human liberty. He failed to obtain the professorship on which he had set his hopes, and the disappointment coincided with the news of his father's death.

Heine now engaged in literary work, but was interrupted in 1830 by the news of the July Revolution in Paris, which raised extravagant hopes among the German Liberals. Heine gave forcible expression to these hopes, and, when the effect of the Revolution in Germany proved disappointing to the Liberals, he was singled out and given the hint that he would be well advised to leave Germany. In May 1831 he arrived in Paris.

He received a generous allowance from his uncle, and his health greatly improved. He found himself admitted into circles of celebrities which included Mendelssohn, Chopin, Balzac, Hugo, Sainte-Beuve, and Michelet. He set before himself the aim of promoting greater sympathy and closer understanding between Germany and France, and wrote letters to a German periodical which gave a vivid description of the movements of thought in Paris. He attached himself for a time to the school of Saint-Simon, finding its 'Religion of Humanity' extremely congenial, and he dedicated to *Enfantin*, then head of the school, his essay, *Zur Geschichte der Religion und Philosophie*. In its German form it was mutilated by the censor, but it had previously appeared in the *Revue des Deux Mondes* under the title, 'De l'Allemagne depuis Luther.' Turning to literature, he critically described for the French people, in *Die Romantische Schule*, the origins and aims of German Romanticism. These works rank among his best contributions to literature, but they were not very successful when first published. *Der Salon* (which included *Florentinische Nächte*), in four volumes, the last of which appeared in 1840, consisted of ten pictures and sketches on a variety of topics of current interest, varying greatly in merit. In 1835, however, Heine's works had been banned in Germany and Austria by a decree of the German Parliament, along with all the productions of a group of writers referred to as 'das junge Deutschland.' The decree was afterwards repealed, but the works of these authors were subjected to a rigid censorship.

Some time after his arrival in Paris, Heine entered into intimate relations with a simple, illiterate shop-girl, who was never able to read a word of his writings. Legal marriage did not follow till some years had passed, and then only to secure a comfortable position for Mathilde Mirat if Heine should fall in a duel which followed his personal attack upon the deceased Ludwig Börne, which was resented by one of the latter's admirers. But Mathilde filled a large place in Heine's life, and in his last years was a most devoted and indispensable nurse. He secretly accepted a small pension from the French Government as one of those 'who had compromised themselves in the cause of liberty.' When the Government changed on the abdication of Louis-Philippe and, the pension being discontinued, the names of the beneficiaries under the secret funds were made public, Heine's opponents openly charged him with bartering his patriotism for 4800 francs per annum. Further financial difficulties faced Heine, for his uncle Solomon died and his cousin Karl refused to continue the annual allowance of 4000 francs which his uncle had given him. Not long before, he had paid an extended visit to Hamburg, taking his wife with him, in order to persuade his uncle to continue the allowance to his wife after his death. This blow, mitigated though it was two years later by the renewal of the allowance, so excited him that a disease which had for some time threatened him came on apace. Paralysis soon gave him all the appearance of a dying man; and, though he lived for two years, with his mind undimmed and his keen critical interest unimpaired, he endured intense agony as he lay on a pile of mattresses—his mattress-grave he called it—and needed all the soothing power of morphia. The loss of his savings by a bank-failure, his anxiety for his wife's future, and the difficulty of concealing his condition from his mother never overwhelmed his eager spirit; his literary work maintained its virility, though it was necessarily less constant

He died on 16th Feb. 1856, and was buried silently in Montmartre.

The character of Heine defies analysis. Of himself he said: 'I am a Jew, I am a Christian; I am tragedy, I am comedy; a Greek, a Hebrew; an adorer of despotism in Napoleon, an admirer of communism in Proudhon; a Latin, a Teuton; a beast, a devil, a god.' His friend Gérard de Nerval extended this antithetical by-play by saying that he was 'at once cruel and tender, naïf and perfidious, sceptical and credulous, lyrical and prosaic, a sentimentalist and a mocker at sentiment, impassioned and reserved, *spirituel et pittoresque*, an ancient and a modern, *moyen-âge et révolutionnaire*.' His letters reveal a poet sceptical of poetry itself, an infidel haunted by the conviction of the spiritual. 'I am positive I have a soul,' he says, quoting Sterne's words with approval. Matthew Arnold it is who has best defined the master of irony (in *Heine's Grave*):

'The Spirit of the world,
Beholding the absurdity of men—
Their vaunts, their feats—let a sardonic smile,
For one short moment, wander o'er his lips.
That smile was Heine's!'

We are here concerned with Heine not as a poet but as a personality who left a marked impression on the religious life and political practice of his age. As such, if we take Heine's own words seriously, he is, indeed, nearer to us than to the purely literary critic. He says:

'Poetry, however much I love her, was to me but a divine play-thing, or a consecrated means for a heavenly end. I have never attached great value to a poet's fame, and whether my songs be praised or blamed, that troubles me little. But a sword shall ye lay upon my coffin, for I was a brave soldier in the war of the liberation of humanity' (*Faust, Heine's Prose*, p. xivi).

2. Religious interests.—Kingsley once referred to Heine as 'a bad man, my dear, a bad man'; and Carlyle spoke of him as 'that poor blackguard Heine.' True, he hated priestcraft in all its shapes and forms, and he held in abhorrence 'State-Religion, that monster born of the intrigue between temporal and spiritual power,' but he was the friend of all sincere religion. 'I may not be over partial to anthropomorphism, but I believe in the Glory of God.' In his last will he humbly asks pardon of God and men for any offences against good manners or morals in his writings.

Despite all the attempts to attribute to cynical irony his allusions to the matter, it remains true that in his later days he became aware of a 'heavenly homesickness.' He himself has something to say of this in his preface to the second German edition of *Religion und Philosophie* (1852): 'In my latest book, *Romancero*, I have explained the transformation which took place within me regarding sacred things. Since its publication many inquiries have been made as to the manner in which the true light dawned upon me. Pious souls, thirsting after a miracle, have desired to know whether, like Saul on his way to Damascus, I had seen a light from heaven; or whether, like Balaam, the son of Beor, I was riding on a restive ass that suddenly opened its mouth and began to speak as a man. No, ye credulous believers, I never journeyed to Damascus; nor have I ever seen an ass, at least any four-footed one, which spake as a man, though I have often enough met men who, whenever they opened their mouths, spake as asses. In truth, it was neither a vision, nor a seraphic revelation, nor a voice from heaven, nor any strange dream or other mystery that brought me into the way of salvation, and I owe my conversion simply to the reading of a book. A book? Yes, and it is an old, homely-looking book, modest as nature and natural as it is; a book that has a work-a-day and unassuming look, like the sun that warms us, like the bread that nourishes us; a book that seems to us as familiar and as full of kindly blessing as the old grandmother who reads daily in it with dear, trembling lips, and spectacles on her nose. And the book is called quite shortly—the Book, the Bible. Rightly do men also call it the Holy Scriptures; for he that has lost God can find Him again in this book, and towards him that has never known God it sends forth the breath of the Divine Word.'

In his *Essay on Religion und Philosophie in Deutschland*—the first edition of which appeared in French in 1833, when Heine was in the full vigour of early manhood—it is his aim 'to explain what Christianity is, how it became Roman Catholicism, how from this it became Protestantism, and how German Philosophy is the offspring

of Protestantism.' The Christian idea he takes to be the eternal conflict of the perverse Satan and the good Christ, of the body and the soul. He looks forward to a day in which happier and fairer generations, nurtured in a religion of joy, will smile with pity when thinking of their poor ancestors, whose lives were spent in melancholy self-mortification. But he declares that Christianity has been a blessing for suffering humanity during eighteen centuries; 'it has been providential, divine, holy.'

'All that it has done in the interests of civilization, curbing the strong and strengthening the weak, binding together the nations through a common sympathy and a common tongue, and all else that its apologists have urged in its praise—all this has been as nothing compared with that great consolation it has bestowed on man. Eternal praise is due to the symbol of that Suffering God, the Saviour with the crown of thorns, the crucified Christ, whose blood was as a healing balm that flowed into the wounds of humanity. . . . The whole system of symbolism imposed on the art and life of the Middle Ages must awaken the admiration of poets in all times.'

He deals in an illuminating way with the real significance of the Reformation in Germany. It was not merely a war against Roman Catholicism, and its motive was essentially different from that of the conflict in France. In Germany the Reformation was a war begun by Spiritualism when it was perceived that Roman Catholicism possessed merely the title of authority and ruled only *de jure*, whilst Sensualism, by means of a long-established fraud, was exercising actual sovereignty and ruled *de facto*. The retailers of indulgences were expelled, and a Puritanism utterly hostile to the pleasures of the senses swept over the land. In France, however, the conflict of the 17th and 18th centuries was opened by Sensualism 'when, though *de facto* sovereign, it beheld every act of its authority derided as illegitimate by a Spiritualism that existed only *de jure*. In Germany the conflict took place in theological discussion; in France it proceeded in wanton jests and merry satire.' This statement as to the Reformation in Germany applies only to the commencement of the conflict; for, when Spiritualism had made its breach in the edifice of the Church, Germany became the arena of combatants intoxicated with liberty. Heine's irony is often delicious and salutary. After declaring that, since the great progress of the natural sciences, miracles have ceased, he proceeds:

'Perhaps the new religions that God may henceforth establish on earth are to be based solely on reason, which indeed will be much more reasonable. At least in the case of Saint-Simonianism, which is the newest religion, no miracle has occurred, with this exception, perhaps, that an old tailor's bill owing by Saint-Simon himself was paid by his disciples ten years after his death. Young grocers were amazed at such supernatural testimony, but the tailors began at once to believe.'

In the second part of the book, Heine deals with the philosophical revolution which, as the offspring of the religious revolution, is nothing else than the last consequences of Protestantism. While he has in his first part spoken of Spiritualism and Sensualism—regarded as the rival social systems—he now refers to Idealism and Materialism, taking account of the corresponding philosophical systems. He refers to his own religious convictions as embodying 'not indeed the dogmatism, but the spirit of Protestantism.'

The French edition amplifies this statement: 'Protestantism was for me more than a religion, it was a mission; and for fourteen years I have been fighting in its interests against the machinations of the German Jesuits. My sympathy for dogma has, it is true, of late become extinguished, and I have frankly declared in my writings that my whole Protestantism consists in the fact that I was inscribed as an evangelical Christian in the church registers of the Lutheran communion. But a secret predilection for the cause in which we have formerly fought and suffered always continues to nestle in our hearts, and my present religious convictions are still animated by the spirit of Protestantism' (*Rel. and Phil. in Germany*, tr. J. Snodgrass, p. 86).

Heine at one point becomes enthusiastic in proclaiming the theoretical overthrow of Deism and the rise of Pantheism among all Germany's

greatest thinkers and best artists. Germany has outgrown Deism; Pantheism is her open secret. Deism is the religion for slaves, for children, for Genevese, for watchmakers. Kant's *Critique of Pure Reason* is the sword that slew Deism in Germany. But in the preface to the second German edition of *Religion und Philosophie*, Heine exercises 'the inalienable right of openly acknowledging his error.' He confesses that everything in this book referring to the existence of God is as false as it is ill-advised.

'No, it is not true that the Critique of Reason, which has destroyed the arguments for the existence of God, familiar to mankind since the time of Anselm of Canterbury, has likewise made an end of God Himself. . . . The fine-spun Berlin dialectic is incapable of enticing a dog from the fireside, it has not the power to kill a cat, much less a God.'

The *Romantische Schule*, which also first appeared in French, contains many interesting passages more relevant to our interest in Heine than to that of the literary critic. Not denying that Christian-Catholic discipline, as a wholesome reaction against the colossal materialism of the Roman Empire, conferred benefits on Europe—a hunger-cure he calls it—he sees in it the origin of a wide-spread hypocrisy; men praised what had become but a pretence of asceticism. This discipline had taught the renunciation of all worldly pleasures, branding as sin the most innocent gratification of the senses; Heine would now replace it by a vindication of our inalienable heritage, by the 'rehabilitation of the flesh.' The book abounds in acute analyses of the relations between German literature on the one hand and Roman Catholicism and Protestantism on the other.

'Alas! we must confess that Pantheism has often led men into indifferentism. They reasoned thus: if everything is God, if everything is divine, then it is indifferent whether man occupies himself with clouds or ancient gems, with folk-songs or the anatomy of apes, with real human beings or play-actors. But that is just the mistake. Everything is not God, but God is everything. He does not manifest Himself equally in all things, but He shows Himself in different degrees according to the various matters. Everything bears within itself an impulse to strive after a higher degree of divinity, and that is the great law of progress throughout all nature. The recognition of this law, which has been most profoundly revealed by the disciples of St. Simon, now makes pantheism a cosmic, universal theory, which not only does not lead to indifferentism, but, on the contrary, induces the most self-sacrificing endeavours. No, God does not manifest Himself in all things equally, as Wolfgang Goethe believed, who through such a belief became an indifferentist, and, instead of devoting himself to the highest interests of humanity, occupied himself with art, anatomy, theories of colour, botanical studies, and observations of the clouds. No, God is manifest in some things to a greater degree than in others. He lives in motion, in action, in time. His holy breath is wafted through the pages of history, which is God's true book of record' (Heine's *Prose Writings*, ed. H. H. Ellis, 108 f.).

The subject of Goethe's *Faust* (*Der Doktor Faust: ein Tanzpoem*) gives Heine an opportunity for preaching the gospel of his own earlier life—'the rehabilitation of the flesh.'

'Knowledge, science, the comprehension of nature through reason, eventually gives us the enjoyment of which faith, that is, Catholic Christianity, has so long defrauded us; we now recognize the truth that mankind is destined to an earthly as well as to a heavenly equality. The political brotherhood which philosophy inculcates is more beneficial to us than the purely spiritual brotherhood, for which we are indebted to Christianity. . . . The German people had, for a long time, felt a profound presentiment of this, for the Germans themselves are that learned Doctor Faust; they themselves are that spiritualist, who, having at last comprehended the inadequateness of the spiritual life alone, reinstates the flesh in its rights. But still biased by the symbolism of Catholic poetry, in which God is pictured as the representative of the spirit, and the devil as that of the flesh, the rehabilitation of the flesh was characterized as an apostasy from God, and a compact with the devil. But some time must yet elapse ere the deeply significant prophecy of that poem will be fulfilled as regards the German people, and the spirit itself, comprehending the usurpation of spiritualism, become the champion of the rights of the flesh. That will be the Revolution, the great daughter of the Reformation' (*Die romantische Schule*, bk. i.; Leland, v. 306 f.).

3. Political aims and influence.—Heine's aims in his political journalism and in his personal influence are plainly expressed in his will: 'La

grande affaire de ma vie était de travailler à l'entente cordiale entre l'Allemagne et la France, et à déjouer les artifices des ennemis de la démocratie, qui exploitent à leur profit les préjugés et les animosités internationales.' The result at which he aimed was not the forced equality desired in France 'by the decapitation of the tallest stalks,' but active freedom. The Romantic School rested on the foundation of an active slavery; Goethe had preached and lived a passive freedom. Opposed to these was Heine's ideal of active freedom, of emancipation—

Emancipation 'not only of Irishmen, Greeks, Frankfort Jews, West Indian blacks, and such like oppressed peoples, but the emancipation of the whole world, especially of Europe, which has attained its majority, and is now breaking loose from the iron leading-strings of Privilege, of Aristocracy' (cf. L. A. Montefiore, in *Fortnightly Review*, new ser., xxii. [1877] 838).

Cosmopolitan Heine was, but patriotic too, for he believed in the mission of individual nations; he could not, however, view patriotism and national spirit as based on racial suspicion and international hatred. He was much attracted to communism, saying of it that its propaganda 'boasts a language universally intelligible. The alphabet of this international dialect is simple as hunger, envy, and death; it is readily learned, and will develop into a world-revolution, the great struggle between the possessionless and the oligarchies of possession.' His treatment of political questions reveals most clearly his strange combination of traits. His critical perspicacity is most sure when his wit is most sharp. Much of his self-contradiction, which is, after all, but the outward aspect of this rare combination, springs from the circumstance that he was essentially a poet, whose song was interrupted by the distant rumblings of a fast-approaching storm. 'The world-wide conflict between the powers that be and those that are to be' awakened a conflict within himself which found expression when he came into contact in Paris with the school of Saint-Simon.

'Yes! I declare it with full conviction: our descendants will be a happier and fairer race than we are. For I believe in progress; I believe that happiness is the goal of humanity. . . . Even here on earth I would strive, through the blessings of free political and industrial institutions, to bring about that reign of felicity which, in the opinion of the pious, is to be postponed till heaven is reached after the day of judgment.'

Much credit that belongs by right to men of prophetic insight and incisive expression is given to men of action. The latter are 'nothing but unconscious hod-men of the men of thought who, often in humblest stillness,' have appointed them their inevitable task. Heine has appointed to modern Europe, and to Germany in particular, several 'inevitable tasks.' Among the direct fruits of the ideals which he cherished and fearlessly advocated are the greater freedom of political expression and action, through parliamentary institutions and by personal influence, the religious emancipation, and the national unity which Germany to-day enjoys.

LITERATURE.—I. *WORKS*.—Heine's *sämmtliche Werke*, ed. A. Strodtmann, 23 vols., Hamburg, 1861-84; Heine's *sämmtliche Werke*, ed. E. Elster, Leipzig, 1890; Heine's *Lieder und Gedichte*, selected with introd. by C. A. Buchheim, London, 1897; Heine's *Prose* (Selections), with introd. by A. B. Faust, New York, 1899.

ii. *TRANSLATIONS*.—*Works of Heine*, tr. C. G. Leland and others, 12 vols., London, 1892-1905; *The Poetical Works of Heine*, tr. J. Payne, do. 1911; Heine's *Book of Songs*, tr. J. Todhunter, Oxford, 1907; *English Fragments*, tr. Sarah Norris, Edinburgh, 1880; *Travel-Pictures*, tr. F. Storr, London, 1887; *Religion and Philosophy in Germany*, tr. J. Snodgrass, do. 1882; *Prose Writings of H. Heine*, with introd. by H. Havelock Ellis, do. 1887.

iii. *BIOGRAPHIES AND ESSAYS*.—G. Karpeles, *Heinrich Heine: aus seinem Leben und aus seiner Zeit*, Leipzig, 1899; R. Proelss, *Heinrich Heine: sein Lebensgang und seine Schriften*, Stuttgart, 1886; A. Strodtmann, *Heine's Leben und Werke*, 2 vols., Berlin, 1867-69; W. Stigand, *The Life, Works, and Opinions of H. Heine*, 2 vols., London, 1875; W. Sharp, *Life of H. Heine*, do. 1888; Matthew Arnold, *Essays in Criticism*, do. 1875, Essay v.; George Eliot, *Essays and*

*Leaves from a Note-book*², do. 1884, pp. 79-141; R. M. M. Houghton, *Monographs, Personal and Social*, do. 1873, pp. 293-339. See also *London Quarterly Review*, lviii. [1882] 411; *Quarterly Review*, clxix. [1889] 399, clxxxix. [1899] 424; *Living Age*, ccxlviii. [1906] 799.

iv. *MEMOIRS AND LETTERS*.—Heine's *Memoiren und neugesammelte Gedichte, Prosa, und Briefe*, ed. E. Engel, Hamburg, 1884; *Briefe von H. Heine an seinen Freund Moses Moser*, Leipzig, 1862; *Heine's Familienleben*, ed. Ludwig von Embden, Hamburg, 1892; G. Karpeles, *Heine's Memoirs*, tr. G. Cannan, 2 vols., London, 1910; W. S. Sichel, 'The Letters of H. Heine,' *Nineteenth Century*, xvi. [1884] 118.

HAROLD E. B. SPEIGHT.

HELL.—See COSMOGONY, STATE OF THE DEAD.

HEMACHANDRA.—A prominent Jain author of the Svetāmbaras who is popularly called 'the Omniscient one of the Iron Age' (*Kalikālasarvajña*). He is famous in the history of his sect because he induced Jayasimha Siddharāja, one of the most powerful kings of Gujarāt (A.D. 1094-1143), to favour the Jains, and actually converted his successor Kumārapāla, the consequence being that Gujarāt has ever since been a stronghold of Jainism. Born in Dhandhūka, Ahmadābād collectorate, in 1088 or 1089, he early became a Jain novice under Devachandra, and was ordained as *sūri* in 1110. For the greater part of his life he lived in Anhilvād Pātan, the capital of Gujarāt. There he won the king's favour in 1125, and became an influential person at court, especially after the conversion of Kumārapāla. Through his exertions the ethical ideals of Jainism were brought to bear on the government of the State, at least for a time. In order to consolidate the Jain influence he revised the Indian system of politics (*nītiśāstrā*) according to the Jain principles of ethics and the political conditions of his time, and wrote the *Arhannīti*, or Jain Politics. Hemachandra's very busy career ended in 1173.

In his literary activity also he seems to have had practical aims in view. He provided his sect with text-books of the principal Indian sciences, so that the Jains were enabled to compete successfully with their Brāhmanical rivals. He wrote a complete Sanskrit and a Prakrit Grammar (the latter ed. and tr. Pischel, Halle, 1877-80), two Sanskrit Dictionaries (*Abhidhānachintāmani* and *Anekārthakośa*, ed. respectively by Böhtlingk and Rieu, St. Petersburg, 1847, and by Zachariae, Vienna, 1893), a Dictionary of peculiar Prakrit idioms (*Deśināmamālā*, ed. Pischel, Bombay, 1890), manuals of Poetics and Metrics, an exposition of ethics and asceticism (*Yogasāstra*, ed. and tr. of first 4 sections by E. Windisch, *ZDMG* xxviii. [1874] 185-262), a work on Philosophy (*Pramānachintāmani*), and a number of minor treatises. In addition, he composed detailed commentaries on most of these works, and illustrated his theoretical rules in two poems, a Sanskrit and a Prakrit one, both called *Dvyāstraya Kāvya*. He also composed a long epic poem in Sanskrit, the *Triṣaṣṭīśalākāpuruṣacharita*, in which he sets forth the mythical and legendary history of the world as conceived by the Jains.

Hemachandra has a very extensive, and at the same time accurate, knowledge of many branches of Hindu and Jain learning, combined with great literary skill, and an easy style. His strength lies in encyclopaedical work rather than in original research, but the enormous mass of varied information which he gathered from original sources, mostly lost to us, makes his works an inestimable mine for philological and historical research.

LITERATURE.—G. Bühler, 'Über das Leben des Jaina-Mönches Hemachandra, des Schülers des Devachandra aus der Vajrasākhā,' *DWAW*, philos.-histor. Classe, Vienna, 1889; T. Zachariae, *Die ind. Wörterbücher* (=GIAP i. 3b [1897]), pp. 80-85.

HERMANN JACOBI.

HENOTHEISM.—See MONOTHEISM.

HERACLITUS.—1. Life.—The well-accredited facts of the life of Heraclitus are very few. He was the son of Blyson or Blosson, and was descended from the most aristocratic family in Ephesus. In his family the patriarchal kingship, which was traced back to Androclus the son of Codrus, continued in the priestly rank of the *basileus*; the office of priest to the Eleusinian Demeter was also connected with it. The tradition that he persuaded the tyrant Melankomas to abdicate his rule, and returned a point-blank refusal to an invitation from Darius, is doubtful. It is certain that he was dissatisfied with the democratic government in his native city, and that he violently attacked his countrymen on account of their moral (fr. 125a [Diels, *Fragmente der Vorsokratiker*, i.³ 102]) and political (104, 121) conduct. He especially censured the banishment of his friend Hermodorus, whom later writers have connected (perhaps wrongly) with the Hermodorus who had a share in the Decemviral legislation of the Romans (450 B.C.). Ancient chronology gives Ol. 69 (504-501 B.C.) as the period when he flourished, which seems to depend on his traditional connexion with Darius. He is said to have lived to the age of sixty, and (fabulously) to have died of dropsy. His date is more certainly ascertained from the fragments of his writings. For, on the one hand, he rejects the multifarious learning of his Ionic countrymen, Pythagoras, Xenophanes, and Hecatæus, who were all at the height of their influence when the 6th cent. was passing into the 5th; on the other hand, he says nothing of his bitterest opponent, Parmenides. Now, since the latter, as most modern scholars agree, clearly combats the antithetical method of Heraclitus in his verses (fr. 6, 6-9 [*Vorsok.* i.³ 153]), and the period of his chief influence is to be fixed somewhere about 480 B.C., it follows that the work of Heraclitus should be dated about 490 B.C. The obvious parody of the Heraclitic philosophy in Epicharmus (fr. 2 [*Vorsok.* i.³ 118]) is of no use as a clue to his date, as under the name of the latter were collected not only later forgeries, but also old Sicilian comedies of different periods.

2. Writings.—Heraclitus's work, of which 130 genuine fragments are preserved to us, is composed in the Ionic dialect, and is archaic, often poetic, in character. Its aphoristic form is borrowed from the Gnostic writings which were widely circulated in the 6th cent., and which, composed partly in poetry and partly in prose (e.g. the sayings of the Seven Sages), gave pithy expression to their experience of life.

In Heraclitus there is added, on the one side, an intense bitterness springing from his tone of mind and experience of life, and, on the other, an intentional obscurity taken over from the religious poetry (oracular and prophetic) of the 6th century. There is, lastly, a modern regard for rhetorical effect in the antithetic form of composition, which shows itself also in his contemporary Simonides, and was further developed in the writings of the Sophists. The division of his work into three books, treating of Nature, Politics, and Theology, either is due to later recensions, or gives the main heads of his philosophy. In the time of Heraclitus books were neither divided into chapters nor possessed titles. His successors referred to his work, as they did to those of all the pre-Socratic philosophers, under the title 'Concerning Nature.'

3. Philosophy.—Heraclitus is the profoundest thinker before Plato, and is a joint-founder with him of the Idealism which under the influence of Plato and Christianity has prevailed over other systems. It is to the profundity of his thoughts that the misunderstanding of them is due, both in his own times and later, down to the present

day. The positive character of 19th cent. thought especially has shown itself incapable of grasping the daring transcendence of his view of the Cosmos. At the very beginning of his work (fr. 1), Heraclitus complains, with bitter dejection, that, in spite of his revelation, men make themselves insensible, both before and after hearing it, to the apprehension of a homogeneous, eternal, omnipotent, invisible, spiritual Power which with the swiftness and force of lightning rules the world, the inner world of man as the outer world of nature, from one end to the other. The philosopher's system has a 'husk' and a 'kernel.' In the 'husk' he condescends to depict the world, as men are wont to fashion it for themselves from their ephemeral experiences; he portrays the mutable, inconsistent, unconscious, and childish world of change. He rejects the polymathy of his contemporaries, i.e. the conclusions of the Milesian physicists and mathematicians since Thales, which were deepened and expanded by Xenophanes and Pythagoras; for they led to a knowledge of contradictory details, not to a homogeneous conception of the world.

Therefore he demands, in place of the method of natural science and mathematics prevalent hitherto, a psychological one, proceeding not from without but from within, not from Nature but from the soul of man. 'I have inquired of myself' (fr. 101)—'To all men it is given to know themselves, and to direct their thoughts accordingly' (fr. 116). Thus it is the task of philosophy, as Socrates taught later, to obey the Delphic precept *Γνώθι σεαυτόν*. Both Socrates and Heraclitus turned away from the superficial interpretation of Nature represented by the Ionians. But, while ethical problems chiefly attracted Socrates, the more comprehensive mind of the Ephesian directed itself vigorously to metaphysics, to 'the Invisible,' which represents the kernel of his philosophy. 'Wisdom consists in one duty and only one—to understand the Intelligence (*γνώμη*) which governs all things' (fr. 41). 'Of what profit to men is the knowledge of Nature? The fairest Cosmos is merely a rubbish-heap poured out at random' (fr. 124). Time, which drives onward everything earthly in ceaseless change, is 'like a child who plays at draughts and moves them hither and thither—a child's government' (fr. 52).

The philosopher's business, therefore, is to discern the Eternal. For 'the human mind (*ἦθος*, i.e. that portion of intellectual being which falls to man's share) has no clear understanding or aims, but the Divine has' (fr. 78). Inasmuch as Heraclitus is the first thinker to grasp the idea of the transcendental, he is, before Parmenides, Anaxagoras, and Plato, the founder of Idealism in philosophy. He is himself conscious of the far-reaching importance of his discovery. For he makes the statement (which Positivists cannot understand): 'None of all those whose words I have heard attains to recognize that Wisdom is something separated (*κεχωρισμένον*) from all' (fr. 108). What this Wisdom (*τὸ σοφόν*) is he explains (fr. 32): 'One, the only Wisdom, does not wish, and yet again does wish, to be called by the name of Zeus' (fr. 32). The new concept may be called by the old and venerable divine name, provided the latter carries with it the idea of absolute mind in the Heraclitic sense. On the other hand, to think of the Homeric Zeus in this connexion is blasphemy against the divine nature. For, in consequence of the thoroughgoing religious reformation of the 6th cent., which is represented by the names Xenophanes, Pythagoras, Orphicism, the traditional conception of religion can no longer be maintained.

But, while poets like Pindar and Æschylus,

imbued with that spirit of reform, tacitly introduce the new conception of Zeus into the ancient popular legends, contemporary philosophers like Xenophanes and Heraclitus set themselves dead against popular beliefs. Like the Colophonian, Heraclitus scornfully attacks the demoralizing aspects of the ancient Epos (fr. 42). But he also attacks the pietism of the Mysteries which had sprung up luxuriantly in the 6th century. The cult of Dionysus and of Demeter, with its ceremonial purification and coarse symbolism, is utterly repugnant to him (fr. 5, 14). It is, therefore, quite credible that, as reported (*Vorsok.* i. 68, 24), he resigned his hereditary office of King-priest, or *basileus*, after his breach with the orthodox religion. He went even so far as to reject prayer altogether, as something childish—a step which no Greek philosopher after him ventured to take. 'They pray to the images of the gods, as though they wished to converse with buildings; just because they are ignorant of the true being of the gods and supernal powers' (fr. 5).

All religious names and notions, which occur frequently in his work, are not to be interpreted in the popular religious sense, but as symbols of the higher idea of the divine nature, of which he is full. His eternal and universal God is not confined to temples or temple-rites, but is omnipresent. 'How can one escape that which never goes down?' (fr. 16). His notion of God also is not split up, as in the Homeric Olympus, into countless individual deities. 'He who perceives the law of the world, the Logos, must confess that all things form one unity' (fr. 50). This universal spirit 'unites conflicting opposites, just as one harmony is formed from various tones' (fr. 8). Here he expresses his monistic belief, in one of the figures familiar to the Pythagorean school. He speaks still more clearly in fr. 67: 'God is day and night, winter and summer, war and peace, plenty and want.'

On another occasion he seeks to render intelligible the universally operative energy of the divine Logos by a hylozoistic figure especially congenial to the science of his time. As Jeremiah had said a hundred years earlier (*Jer* 23²⁹), 'Is not my word as a fire? saith the Lord,' so the prophet of Ephesus proclaims (fr. 30): 'This system of the world (*κόσμος*), the same for all, neither any of the gods nor any man has made, but it always was and is and shall be an ever-living fire, kindled in due measure, and in due measure extinguished.' This conception of 'the due measure' is essential for the interpretation of Heraclitus. The modern physical theory assumes that different forces (heat, electricity, magnetism, chemical force, etc.) are convertible into each other. They are all connected by the invariable law that exactly as much force of one kind (e.g. heat) disappears as force of another kind (e.g. electricity) comes on the scene. In a similar manner Heraclitus conceives of the divine cosmic force. Just as our modern physicists assume the æther as a common substratum whence forces proceed, so Heraclitus speaks of the divine cosmic fire which is always confined within the same limits. 'The sun will not overstep his bounds; for, if he does, the Erinyes, helpers of justice, will find him out' (fr. 94). And, although the sun is kindled every day anew (fr. 6), he observes his limits.

So also the changes of fire into water and earth always take place in fixed proportions. At first the ætherial vapour is condensed into sea-water, from which the solid earth is precipitated. This is 'the way down.' In the same proportion the transformations of the solid, liquid, and gaseous states proceed upwards. Earth deliquesces into water at a time of deluge, water exhales skyward as ætherial vapour.

Of course the periods occupied by these changes are not always alike. On the contrary, the great pendulum describes smaller and greater arcs. The rotations of day and night, of seasons, of years, of great cosmic periods between a general flood and a general conflagration, vary in length, but not in quality and proportion. Opposites must always be resolved into 'the invisible harmony' (fr. 54). All that men can see is the war between them. Thus with Heraclitus war is 'the father of all things' (fr. 53), and the one thing clear and worth taking into account is change. He never becomes tired of illustrating this popular way of conceiving the flux of things by ever fresh examples. 'To him who enters the same river, other and still other waters flow' (fr. 12). 'One cannot twice descend into the same river' (fr. 91). 'Into the same river we descend, and we do not descend; we are, and we are not' (fr. 49 A).

So, for later thinkers the uniform light of the Heraclitic system appears broken up into the brilliant colour-play of relativism, the prismatic ambiguity of a materialistic scepticism (*παλιτροπος ἀρμονία*, fr. 51) which threatens to turn into nihilism. 'Sea-water is very pure and very foul, for, while to fishes it is drinkable and healthful, to men it is unfit to drink and deadly' (fr. 81). Of course, in the empirical region of sense-perception everything is inconsistent and relative; on the contrary, in the realm of pure thought the Absolute is enthroned. 'To God all things are beautiful and right and good; but men suppose that some are right and others wrong' (fr. 102).

Thus Heraclitus comprehends, as exactly as his opponent Parmenides, who indeed only partially understood him, *noumena* and *phenomena*, truth and illusion (*ἀλήθεια, δόξα*), in his system. The sad fact with both is that the dull-witted world has comprehended their illusion better than their truth. But so it fares with all prophets.

It is necessary, after the monistic doctrine of the Logos and its counterpart, terrestrial dualism, have been made clear as the kernel and husk of his system, to expound briefly how Heraclitus applies his theory, in its metaphysical and material aspects, to the doctrine of man's constitution.

The human soul, with which the hitherto prevailing Ionian and Pythagorean philosophy had but little concerned itself, is of cardinal importance to the prophet of the *Γνωθι σεαυτόν*. At first, indeed, it seems a very materialistic view that the soul should be involved in the elemental changes of the twofold way upward and downward. 'For the soul it is death to become water, and for water it is death to become earth. But from earth comes water; and from water, soul' (fr. 36).

As might be expected, the acme of human existence is identical with the physical fire-æther. As fire descends, the soul passes through the intermediate stage of water into earth, i.e. into flesh, and this way signifies joy and life. Conversely, when flesh again dissolves into water (hence the legend before mentioned of Heraclitus's dropsy) and from thence returns to the cosmic æther, death takes place. 'For souls it is joy or death to become wet' (fr. 77 A). Thus, just as in the Orphic-Christian theory, soul and body are already conceived of as contraries, which stand in direct opposition to each other. 'We live in the death of souls, and again they (i.e. souls) live in our death' (fr. 77 B).

But neither in the macrocosm nor in our microcosm is a complete extinction of the primordial fire possible. In the living body also a spark of ætherial fire is preserved (Macrob. in *Somn. Scip.* i. 14, 'scintillam stellaris essentiae'; *Vorsok.* 12 A, 15, p. 74), and the freer from moisture this ingredient is kept, the wiser and the better is the

man. 'The dry beam is the wisest and best soul' (fr. 118). Of course, this divine spark is identical in essence with the God who governs, illuminates, and warms the universe. Therefore the soul rests on the deepest foundation of the Divine Logos. 'The limits of the soul thou canst not discover, though thou shouldst traverse every way; so profoundly is it rooted in the Logos' (fr. 45).

This identification of the spiritual and essential characteristic of man (to which the Greeks give the hardly translatable name *ἦθος*) with the essence of Deity interprets for us the fine saying of Heraclitus, 'A man's character is his dæmon' (fr. 119)—a saying repeated by Democritus and Menander. Therefore it follows that man's happiness cannot consist in sensual enjoyment. 'Oxen are happy when they have peas to eat' (fr. 4). 'For the best men choose one thing above all else; immortal glory above transient things. But the masses stuff themselves like cattle' (fr. 29). 'To the soul,' on the contrary, 'belongs the self-multiplying Logos' (fr. 115). The Logos, however, is not merely the special characteristic of man alone; it is at the same time the universal cosmic law, which energizes and controls everything. 'Therefore it is a duty to follow the common law. But although the Logos is common to all, the majority of people live as though they had an understanding of their own' (fr. 2). 'All human laws are dependent upon one divine law. For this rules as far as it wills, and suffices for all, and overcomes all' (fr. 114).

Thus, not only physical but moral science also is closely connected with metaphysics. The divine law (as later among the Stoics) is identical with the conscience of the individual. Men who obey this inner law, however, are extremely rare. That is a matter of course for the aristocrat of Ephesus: 'One is to me worth ten thousand, provided he be the best' (fr. 49).

From these premisses it is easy to understand the way in which Heraclitus undertakes to remodel the Greek belief in immortality. 'Gods and men honour those who have fallen in war' (fr. 24). This principle of the popular hero-worship he applies to his heroes, the heroes of the Logos. The body, as such, deserves no honour. 'Corpses should be thrown away sooner than excrement' (fr. 96). But just in proportion to the degree of purity with which a man has guarded and intensified the inner flame in his life is the fierceness of the attack on him from the terrestrial sphere, and at the same time the greater is the prize beyond. This seems to be the meaning of the saying in fr. 25 which has been torn from its context: 'Greater fates gain greater rewards,' for 'man kindles a light in the night when he is dead' (fr. 26).

To explain this better, we add a remark of G. T. Fechner, whose 'panpsychism' contains much Heraclitic doctrine: 'At the moment of death, when everlasting night seals up the eye of man's body, the dawn awakens in his spirit. Then the focal centre of the inner man will blaze out to a sun which will illuminate all that is spiritual in him, and at the same time, like an inner eye, look through things with unearthly clearness' (*Leben nach dem Tode*², Leipzig, 1866, p. 42). So Heraclitus also appears to have conceived of the *new* light which the spiritual man kindles for himself after the death of the body. 'There awaits men after death what they neither hope nor think' (fr. 27). Thus, starting from an idea of Hesiod, he suggests a deliverance of elect heroes of the spirit from the night of death, who now, as he believes, lead a higher life as 'watchers of the living and the dead' (fr. 63). In this sense he could say, with antithetical point: 'Immortals become mortals, and mortals immortals' (fr. 62).

For there awaits the spirit of fire, which has fallen down from aetherial heights, and appears doomed to mortality in an earthly frame, an ascension after death. This doctrine reminds us of the prophetic utterances of Empedocles, and of the Stoic doctrine of continued existence for the virtuous. Of course, even to these elect heavenly guests an endless life is not allotted. For when, finally, all things pass into fire, and the 'Great Year' of 30×360 years has completed its revolution, a universal conflagration will usher in Doomsday. 'For the fire which comes on all things will judge and condemn them' (fr. 66).

This doctrine of the 'last things' has been doubted, because, at the arrival of this *dies iræ*, the constant interchange between the two poles of existence disappears. This is wrong, however; for this moment, when everything melts in the universal conflagration (i.e. when God ceases to work), is only the extreme point to which the cosmic pendulum swings on one side, to which, on the other side, the Deluge, or rather a universal torpor, corresponds. That a final amalgamation of the other two elements (earth and water) is not implied in the reports of his doctrine which we possess, and probably was not taught by Heraclitus himself, is shown by the fact that the form of the fire is conceived of as the normal and primitive one, so that the end of the Cosmos, like the beginning, is linked on to the primordial principle. 'For in rotation the beginning and the end are common' (fr. 103).

4. Posthumous influence.—Heraclitus, one of the most original writers and profoundest thinkers of antiquity, has had a powerful influence on all succeeding times, from Alcmaeon and Parmenides, past the time of Democritus, Protagoras, Euripides, and the authors of the *Corpus Hippocraticum*, to the Stoics, whose popular version of his philosophy conquered the cultured Greek and Roman world. Especially important is the direct or indirect influence of Heraclitus on Philo, the Johannine Gospel, and the theology of the early Fathers (Clement of Alexandria and Hippolytus). Among the moderns, Hegel and Nietzsche in particular, the latter especially in the aphoristic form of his writing, show the deep influence of the sage of Ephesus.

LITERATURE.—I. EDITIONS.—*Heracliti reliquiae*, Bywater, Oxf. 1877 [the most complete collection of the fragments]; H. Diels, *Herakleitos von Ephesos*² [Greek and German], Berlin, 1909, also *Fragmente der Vorsokratiker* [Greek and German], i.³, Berlin, 1912, pp. 67-113 (ch. 12) [quotations are made from this collection].

II. SYSTEM OF HERACLITUS: F. Lassalle, *Die Philos. Herakleitos des Dunklen v. Ephesos*, 2 vols., Berlin, 1858; P. Schuster, 'Heraklit von Ephesus,' in *Acta Soc. philol.*, lii. (Leipzig, 1873); E. Zeller, *Philos. der Griechen*, i.², do. 1892, pp. 623-750; J. Burnet, *Early Greek Philos.*², London, 1906, pp. 129-179; T. Gomperz, *Griech. Denker*², Leipzig, 1911 [tr. of 1st ed. by Magnus, London, 1901], i. 49.

H. DIELS.

HERDER.—1. Life and times.—The century of enlightenment, the century of Locke and Hume in England, of Voltaire and Rousseau in France, re-enacted that turning of thought towards its own nature, that desertion of metaphysical subtleties, that development of empirical interest in human life and enthusiastic discussion of the problems of society, which characterized the Greek Sophistic movement. But, whilst in England the current of thought lost itself in the stagnant backwaters of a theoretical scepticism, and in France transformed itself into the motive power of political agitation, in Germany it maintained its course with little distraction, refreshed by the influx of a new stream of influences. In the interests of individual culture, without application to social revolution, the philosophical principles of Leibniz and Wolff were carried into the realms of psycho-

logy, epistemology, morality, political science, and even religion. But it was due to the assertion of the claims of poetry and a whole new world of literature that the intellectual life was re-vitalized. Lessing (q.v.) and Herder were the heralds who announced these claims.

Johann Gottfried von Herder was born at Mohrungen, East Prussia, on 24th Aug. 1744, the third child of humble parents. The father, who was sexton and master of a small school, was an earnest, strict, upright man of undoubting piety. Herder's paternal grandfather had been an immigrant from Silesia, a refugee from Roman Catholic rule, and it was no doubt from him that the boy derived his warm, imaginative spirit. As a boy, Herder was 'always grave and always alone'; he never enjoyed very good health, suffering to the end of his life from a fistula in one eye. He became even more quiet and shy during his school-years under the severe old rector of the town school, and devoted himself to reading. After a miserable period in the house of a young pastor, Trescho by name, who was blind to the boy's ability and unsympathetic towards his inclination for a clerical career—a period during which he became excessively reserved and subject to nervous depression—Herder succeeded in making his way to Königsberg. He welcomed an opportunity of studying medicine which came in his way, simply because it took him away from his cramped and wretched life as amanuensis and message-boy to a man whom he loathed. After fainting at a dissection in the hospital, he abandoned medicine, and by means of the help of a few friends and his own earnings he was able to enter the University (1762) with a view to a clerical training. He had already written some poems, and one he had surreptitiously introduced into a parcel sent by Trescho to a Königsberg publisher, who had recognized its merit and taken pains to discover the identity of its author.

Attending Kant's lectures, he was stimulated to critical inquiry and read widely; Plato, Hume, Leibniz, Diderot, and Rousseau he studied with special care and enthusiasm. But a greater influence on his mind was the friendship of J. G. Hamann, who aroused in him a deep appreciation of poetry and early national literature. He contributed poems and reviews to the *Königsberger Zeitung*. Then we find him at Riga, first as assistant-master at the Cathedral School, and later as 'additional curate'; while he was there, in 1767, he published *Fragmente über die neuere deutsche Literatur*, which rapidly reached a wide and sympathetic public and attracted Lessing's attention. Various writings followed, but their advanced views on literary and artistic topics aroused a storm of opposition, and such suspicions were rife as to his orthodoxy that he left Riga. Anxious to make certain experiments in social reform which were to rest on a reform of educational methods, he commenced a tour. With a view to investigating educational systems in different countries, he made his way to Holland and France, but his intention of visiting England and Italy was not carried out. In order to secure an independent position, he accepted a post as travelling tutor to the son of the Prince-Bishop of Lübeck, and abandoned his social schemes. He found himself in the course of his duties at Darmstadt, where he met Caroline Flachsland and became betrothed to her. In that year and the following, 1770-1771, he was in close contact at Strassburg with Goethe, who was then revelling in the exuberance of early manhood. The friendship that sprang up between the two is of great importance for the history of German literature, for Goethe frequently acknowledged, in the most definite lan-

guage, that a great change passed over him during those days.

'New vistas opened to my sight every day, nay, every hour. . . . The more I swallowed, the more Herder had to give. . . . He imparted to me the germs of all that he carried out in after life.' 'It was he who set me in the right way. No utterance of his ever failed of its effect. I do not remember ever having torn up a single paper on which his magical handwriting was to be found.'

In 1771, Herder threw up his tutorship, and for five years was Court-Precacher at Bückeberg. Opposition on the part of the orthodox clergy, renewed and severe eye-trouble, financial straits, and the consequent delay of marriage combined to depress him abnormally. He continued his literary studies, however, and was so much affected by his reading of 'Ossian,' Percy's *Reliques*, and Shakespeare that he openly deserted the classical school and took a prominent place in the *Sturm und Drang* reaction. He and Goethe, with some others at Darmstadt and Frankfort, issued a journal which was to be the organ of their revolt. He was able to marry in 1773, and in 1776 was appointed Court-Precacher and Superintendent of the Clergy in the duchy of Weimar.

In Weimar he spent the rest of his life in close proximity to Goethe, Wieland, and Jean Paul Richter, but suffering much loneliness of spirit. The conventional atmosphere was far from congenial, and the six other members of the Weimar Consistory opposed every reform that he projected. The story of his later years—the strained relations with Goethe, his disappointment as those whom he had influenced gradually outgrew their discipleship, illness overpowering his bodily strength—is not a pleasant one; it is relieved by his wife's devotion and his popularity among the scholars of the Gymnasium at Weimar. Some of his most powerful—though also many of his less valuable—works belong to the Weimar period. His collection of folk-songs (*Stimmen der Völker in Liedern*) appeared in 1778-79, and his famous work *On the Spirit of Hebrew Poetry (Vom Geist der ebräischen Poesie)* in 1782-83. Then came his most important achievement, *Ideen zur Philosophie der Geschichte der Menschheit (Ideas on the Philosophy of the History of Human Life)* from 1784-91. His closing years he devoted to speculations on theological and philosophical subjects, but he went to what were regarded as extremes by such friends as Jacobi, Lavater, and even his early friend Hamann, who became alienated from him. When he died on 18th Dec. 1803, aged only fifty-nine, he was planning fresh literary ventures.

Herder's influence lay in two main directions. Lessing had stimulated independence of French literature and art, but himself remained loyal to the classical canons. Herder championed the revolt against classicism, or, in other words, led the Romantic movement. But he further provided the Romantic movement with its theoretical justification. He was the founder of the genetic method of explanation, though it is somewhat misleading to speak of him as a pre-Darwinian evolutionist. This was the great achievement of his life, the fruit of his keen, synthetic imagination and equally ready appreciation of inductively important characteristics.

2. Writings.—Herder's chief writings may best be indicated by considering them in relation to the special subjects which he investigated, and as leading up to his great synthetic work, which had for its thesis the whole of human development treated as the subject of purely natural history.

(1) *Poetry*.—In the *Fragmente über die neuere deutsche Literatur*, published in Riga in 1767, he endeavours to demonstrate the relation of poetry to circumstances, environment, and national in-

dividuality. He illustrates his theme by sympathetic and original studies of Homer, Hebrew poetry, Shakespeare, and 'Ossian.'

(2) *Art*.—Here again his thesis is the importance of natural character; Gothic art is shown to have its own peculiar merit and significance. His chief works in this category are *Kritische Wälder* (1769), and *Plastik* (1778).

(3) *Language*.—Herder was an eighteenth-century Max Müller, and to him is due the credit of founding the comparative study of language especially in regard to its nature and origin. His treatise, *Über den Ursprung der Sprache* (1772)—an argument directed against the theory that language was divinely communicated to man—demonstrates the inevitability of language, given the complex of powers we find in man.

'If it is incomprehensible to others how a human mind could invent language, it is as incomprehensible to me how a human mind could be what it is without discovering language for itself.'

In matters of fact this treatise, like several others which he wrote, is open to the charge of inaccuracy and crudeness, but the important feature is the consistent use of the comparative method of investigation. Herder's view is that 'language arose with the first spark of consciousness,' and, like every other production, gradually became more perfectly developed. Language is not the mere sound of words, for every sign and action is language. Language, indeed, relates us closely to the whole of sentient Nature.

'It seems that the last maternal touch from the modelling hand of Nature infused the following law into all, at their entrance into the world, "Feel not for thyself alone, but let thy feeling resound." As this last creative touch was the same to the same species, the following law became a blessing: "Let thy feeling resound in unison with thine own race, and be heard with sympathy by one and all."'

(4) *Religion*.—The comparative method of study was applied also to religion, and Herder wrote under the conviction that religion in its historical development has been closely related to man's wants and impulses. His studies in religion are found in his volumes entitled *Vom Geist der ebräischen Poesie*, *Briefe über das Studium der Theologie*, and *Christliche Schriften*. In the second of these works he laid down the principle that the Bible must be read 'in a human way,' as we should read the Greek historians and dramatists, with constant effort to interpret its contents in relation to their temporal and local setting. He made bold attempts to occupy a middle position in regard to certain doctrinal questions, having for his reward only the hatred of dogmatists and the suspicion of extreme rationalists. But he clearly distinguished religion from the realm of dogmatic into which his published opinions carried him.

'Religion is that which binds our conscience; it is an inner certainty, incapable of mathematical demonstration; religion is the awareness of what we are as parts of the world, what we ought to be as men, and what we have to do. We strive over opinions, but opinions are not religion, for there is but one religion, though it appears under many forms.'

In *Vom Geist der ebräischen Poesie*, Herder investigates the earliest opinions of mankind concerning the Deity, Creation, Providence, etc. Among other things he exposes the absurdity of those who have represented religion as originally derived from the apprehensions and terrors of mankind.

Alciphron: Philosophers have explained the strong emotion occasioned by that religious veneration of which you speak. It was ignorance, say they, that gave existence to the gods; stupid and servile astonishment produced the first oblations to them, whom terrified fancy represented as powerful beings, as invisible demons, from whom mankind had everything to fear.

Eutyphron: On the contrary, it is the essential and distinctive character of man, and that which places him above all classes of beings merely animal, that he is susceptible of religion. The propensity to worship one or more superior beings is known to have been present among men in all nations

and periods of the world, and why must this be derived only from anxiety and fear? Our existence, surely, is an act of beneficence and not a punishment, otherwise the love of life and the ardent desire for its duration would be unaccountable. The Great Being, therefore, to whom we are indebted for it, and by whom we subsist, must be considered as good. Daily experience must convince us of His benignity. . . . At the same time, I am willing to admit that the religion of many ancient nations was mixed with painful feelings of apprehension and terror. This was more especially the case with those who had their dwelling in rude climates, in dark caverns, amidst burning mountains, or on barren shores of unfrequented and tempestuous seas, or of such as were accustomed to frequent views of dismal objects, and of revolution accompanied by inhuman scenes of devastation and carnage.'

The primitive religions, which Herder refused to attribute to the sentiment of fear, were based, he suggested, on the need for explanation; hence, for example, among the primitive peoples whose dæmon-worship is revealed in Genesis, from the observance of 'the works and beauties of Nature,' from the sight of 'energy, wisdom, and self-renewed power of production and reproduction in all things' (seen in particular objects, however, and not connected 'in a general point of view') the inference was made that there existed 'separate and particular causes of particular objects, distinct creating spirits, of which each produced a particular object and contributed to its preservation with intelligence and care.' The higher, later religions Herder attributes to the persistence of deep-seated moral feeling. But his treatment of the history of religions derives its importance from his application to it of the genetic method of study rather than from his own data or conclusions.

Herder's sermons were only occasionally printed, but we have evidence to show that he preached in a manner 'straightforward, popular, and natural'—to borrow Schiller's description; and in his farewell sermon at Riga, where he had filled a church whenever he preached, he stated his own aims:

'Most of my own sermons, all my best, have been human. I have tried to show that our only happiness is to remain true to the foundations of our nature, and to follow no guide but reason and conscience. Humanity, therefore, in its widest circle, with all its noblest ideas of God, its self, and Nature, with all its feelings of brotherhood and sympathy, with all its charming duties, and high dispositions and capacities for happiness—humanity in this wide scope was always the main theme of my sermons, instruction, and exhortation.'

(5) *Human culture*.—Herder went further still in the application of his central idea, so far indeed that, had it not been for essential differences in the general level of scientific culture and in the accuracy of observation, a short step on his part would have led him to the pinnacle later occupied by Darwin. We might, indeed, have spoken to-day of Herderism rather than Darwinism. A volume has been written by Bärenbach under the significant title, *Herder als Vorgänger Darwins*. His *Ideen zur Phil. der Gesch. der Menschheit* applies the genetic method to the whole of human development. Whereas Kant had opposed to Nature an absolute free will, rational and independent, Herder placed human life in a natural setting; history he regarded as a natural science, investigating and describing the human powers, impulses, and activities. His work is the foundation-stone of the modern study of primitive culture, which now receives support from the sciences of anthropology, archaeology, philology, and comparative psychology. It is simple in style and impartial in tone.

(a) The first part—the science of man's place in the universe—discusses the earth's position in the stellar system, its crust as influenced by the atmosphere, and the various forms of life produced on it. The motto of the whole is the unity of creation; and with ample illustration, in which the whole field of natural science as then known is laid under contribution, we are shown how closely we are bound by nature from our earliest hour to our possessions, our country, and its language and

customs. Several passages are remarkably suggestive of nineteenth-century evolutionist theory.

'The less a nation is pressed upon, and the more truly it is obliged to abide by its simple and savage way of life, the more exactly does it also maintain its original conformation or type' (bk. vi. ch. 1). But 'nothing in Nature stands still; everything strives and struggles onward. Could we only see into the first periods of creation—how one realm of Nature is built up on another—what a procession of forces ever struggling onward would be displayed in early development' (bk. v. ch. 3). Before ever the earth took its present form, 'millions of creatures were of necessity overwhelmed; what could maintain itself has remained, and has been standing now for thousands of years in the great harmonious order' (bk. xv. ch. 2).

Herder even makes a deduction which sounds essentially modern. He sees that advance in organization means a differentiation of parts in the organism. 'The higher we go, the more various and distinct do the parts become' (bk. iii. ch. 1). This principle, accepted to-day in its application to physiology, he applies even to society. He was gifted with a penetrating, imaginative insight that would undoubtedly have led him to the far-reaching hypothesis of 'evolution' in the modern sense had the greater range of fact been accessible to him as it was to Darwin. But his emphasis was upon things as they have been, and necessarily have been, rather than upon things as they are, interpreted by the past.

(b) In the second part of the work, the science of history—of man's development in time—is the subject. We have here an account of primitive peoples. China, Tibet, Hindustan, then Babylon, the Medes and Persians, the Hebrews, and the Egyptians, are amongst the topics to which chapters are devoted. Greek life and history and Rome and its decline are next discussed. We then retrace our steps and reflect upon the growth of the human mind and of human customs. The Northern peoples are passed under review, and we are led to a whole book, brilliant but unsympathetic, on Christianity and its propagation. We return to the Northern kingdoms of mediæval Europe, the Romish hierarchy, and the influence of the Arabs; the discussion is closed by chapters on Commerce in Europe, the Crusades, and the Cultivation of Reason in Europe. Thus we have a comprehensive series of studies in Comparative Mythology, Sociology, Ethics, and Education.

The work had a mixed reception; Goethe was one of those who gave high praise to its aims and spirit, Kant one of the scoffers who stigmatized it as 'a collection of hints,' a book of travellers' tales. The boldness of the scheme, apart from its actual achievement, was in itself a powerful stimulus which is not even yet exhausted. But in a purely theoretical direction the work exercised a great influence. It emphasized the living unity of human life, spiritual and mental, and showed that reason (or understanding) and feeling (or sensibility) are not two distinct sources of knowledge, but different stages of that one activity in which the individual lives the life of the whole. One influence—negative, perhaps, but vital—exercised by this work is seen in Kant's theory of history, which was formed in view of the opposition between Herder and Rousseau. To Rousseau, history depicts the departure of mankind from an original 'natural' state of perfection. To Herder, history lays bare the necessary, natural, and self-explanatory development of an original constitution. Kant steered between the Scylla and Charybdis, carried through by a philosophical conception of the 'Fall' which explained how natural inclination, once ethically neutral, became an enemy of the Good Will. It may be noted here that in his insistence on the completion of human life through its development, Herder was probably influenced by the works of the English philosopher Shaftesbury, to whom the ethical is

the flower of human life, the natural and complete development of man's natural endowment.

(6) *Metaphysics*.—Herder's late metaphysical speculations are of less interest. In *Vom Erkennen und Empfinden der menschlichen Seele* (1778), and *Verstand und Vernunft, eine Metakritik zur Kritik der reinen Vernunft* (1799), he attacks the critical philosophy of Kant. The first of these was written under the influence of Shaftesbury, whose poetic glorification of the universe as it is and æsthetic appreciation of the artist's master-hand in Nature influenced Schiller as well as Herder. These works aim at a reinstatement of 'sensibility,' at an overthrow of the analytic tendency of Kantianism, with its apparent rather than real 'dissection' of human life. *Kalligone* (1800) opposed the theory of Kant's *Kritik der Urteilkraft*, arguing the close connexion of Beauty and Good. In opposition to Kant's theory and to the practical worship of form and style among the Weimar poets, Herder urged that the content of art is more real than its form.

LITERATURE.—i. *WORKS*.—*Sämmtliche Werke*, 45 vols., ed. J. G. Müller, Tübingen, 1805-20, 2nd ed., 60 vols., Stuttgart and Tübingen, 1827-30; *Herders Werke*, ed. H. Düntzer, 24 vols., Berlin and Leipzig, 1868-79; critical and best edition, *Herders Werke*, ed. B. Suphan, 32 vols., Berlin, 1877-90.

ii. *TRANSLATIONS*.—*Outlines of a Philosophy of the History of Man*, tr. T. Churchill, 2 vols., 2nd ed., London, 1803; *Treatise upon the Origin of Language*, do. 1827; *Oriental Dialogues on the Spirit and Beauties of the Sacred Poetry of the Hebrews*, do. 1801; *The Spirit of Hebrew Poetry*, tr. J. Marsh, Burlington, 1833.

iii. *LIFE*.—R. Haym, *Herder nach seinem Leben und seinen Werken*, 2 vols., Berlin, 1877-85; E. Kühnemann, *Herders Persönlichkeit in seiner Weltanschauung*, Berlin, 1893, also *Herders Leben*, Munich, 1895; R. Bürkner, *Herder, sein Leben und Wirken*, Berlin, 1904; H. W. Nevinson, *A Sketch of Herder and his Times*, London, 1884.

iv. *MEMOIRS AND LETTERS*.—*Erinnerungen aus dem Leben J. Gottfrieds von Herder*, collected by Carolina von Herder, ed. J. G. Müller, Tübingen, 1820; *Aus Herders Nachlass*, 3 vols., Frankfurt, 1856, and *Von und an Herder*, ed. H. Düntzer, 3 vols., Leipzig, 1861; *Briefwechsel mit Nicolai*, Berlin, 1887, and *Briefe an Hamann*, do. 1869, ed. O. Hoffmann; *J. G. von Herders Lebensbild* (with correspondence), ed. E. G. von Herder, 4 vols., Erlangen, 1846.

v. *ESSAYS AND STUDIES*.—C. Joret, *Herder et la renaissance littéraire en Allemagne au XVIII^e siècle*, Paris, 1875; R. Wielandt, *Herders Theorie von der Religion und den religiösen Vorstellungen*, Berlin, 1904; F. v. Bärenbach, *Herder als Vorgänger Darwins*, do. 1877; G. Hauffe, *Herder in seinen Ideen zur Phil. der Gesch. der Menschheit*, Borna-Leipzig, 1891; J. Sully, art. 'Herder,' in *EBR* xiii. 347.

HAROLD E. B. SPEIGHT.

HEREDITY.—Exact knowledge of the process by which one generation comes into being from another and of the relations between them is essentially a growth of the 19th century. A precise knowledge of heredity was not possible as long as the respective parts played by the sexes remained obscure. It was not until the 19th cent. that the nature of the sexual cells and of the process of fertilization was established beyond a doubt, and a sure foundation provided upon which the student of heredity could build. The earlier history of heredity is the history of attempts made to unravel the nature of the sexual process, for the account of which the reader is referred to the art. **SEX**.

1. The experimental study of heredity may be said to have begun with Kölreuter, who published the results of his researches on the hybridization of plants in a series of papers between 1761 and 1766. In spite of the earlier discoveries of Camerarius, the theory of the sexuality of plants was at this time still an open question, and Kölreuter's experiments were designed chiefly to establish this theory. He crossed different species of plants which differed from one another in definite characters, and used the fact that the hybrids so produced resembled the pollen parent in some respects and the seed parent in others as an argument for regarding both parents as making a definite contribution to their offspring. In this

he clearly succeeded, though it was not for some years that his contributions received proper recognition.

2. Much hybridization work in plants was done during the earlier half of the 19th century. Among the workers of that time the names of Knight, Herbert, Wichura, and Gärtner are specially prominent. But their efforts were not directed primarily to the discovery of laws of heredity. The problems of the nature of species, of their possible fixity or transmutability, were much in the air about this time, and it was towards these problems that the efforts of this group of hybridizers were chiefly directed. Many interesting and curious facts were brought to light, but that they were never followed up was due to an event which seemed to solve the problem they had set out to investigate.

3. This was the publication of the *Origin of Species* in 1859. The views as to the interrelation of species there put forward by Darwin rapidly gained the support of the great majority of biologists. The problem of species appeared to have been solved, and the work of the hybridizers came to a sudden standstill. Heredity and variation were the corner-stones upon which Darwin erected his edifice. Yet Darwin himself deplored the prevailing ignorance both of the one phenomenon and of the other. Had a Darwinian been challenged for a definition of heredity, he would probably have replied to the effect that it is an innate force in virtue of which offspring tend to resemble their parents more than other individuals of the species. That offspring also differ from their parents was set down, where such differences are relatively small, to an innate tendency to variation, whether induced by the environment or in some other manner. By unduly favouring the action of either of these two forces—heredity and variation—selection, whether natural or artificial, was held to be able gradually to mould the race to a different form. Where the difference between parent and offspring was very marked, as, for instance, in the production of a white animal from two coloured ones or *vice versa*, a new principle was invoked, and the appearance of the unusual progeny was explained by the law of reversion. This phenomenon was regarded as due to the crossing of distinct varieties, whereby the descendants, even after a number of generations, tend to exhibit characters found in one or other of the original parents, but not evident in the intermediate generations.

The observation of such cases depends upon a continuity of records over several generations; and for this reason the most striking cases of the phenomenon were confined to domesticated animals and plants. Hence arose the belief that the process of heredity in domesticated creatures is essentially different from that operating in wild races—a belief which is not without supporters even at the present day. For Darwin himself this hypothetical difference between the wild and the domesticated did not exist. Indeed, he used the facts of variation among domesticated forms as an argument for his views as to the nature of the process of evolution in the non-domesticated. Heredity and variation, whatever their exact nature, were throughout living things held to be phenomena of essentially the same character. This view Darwin sought to express in his well-known hypothesis of Pangenesis. He suggested that in the cells of an organism there exist particles or 'gemmules' corresponding to the individual cells, each of the different cells having its own peculiar form of gemmules. Of the gemmules it could only be said that they were larger than chemical molecules but smaller than

any known living unit. Like the latter, however, they were capable of multiplication through the normal process of growth and division. During cell-division they were distributed to the daughter-cells. Normally certain gemmules only were active in the cells of a given tissue, but under exceptional conditions other gemmules might be present in these cells, and on becoming excited lead the cell to take on other characters. Generally speaking, these abnormal gemmules would have been present in some ancestor, and would have remained latent for a variable, often a very great, number of generations. By means of this capacity for remaining latent on the part of the gemmules, Darwin sought to explain the phenomena of reversion and atavism.

The gemmules derived from some remote ancestor might remain dormant for many generations, until, under the influence of some stimulus, whether of a cross or otherwise, they were re-awakened into fresh activity, and the organism exhibited ancestral characteristics. The germ-cells Darwin supposed to contain representations of all the various gemmules corresponding to the different cells of an individual, while at the same time they might also contain gemmules derived from ancestors more or less remote. Further, in order to explain the inherited effects of use and disuse in which he firmly believed (cf. art. ENVIRONMENT), Darwin supposed that gemmules were capable of transportation from one cell to another. In this way the cells of the germ-plasm were continually receiving gemmules from the cells of the different tissues of the body. Stimuli, more especially those resulting from increased use and disuse, altered the character of the cell and also of its contained gemmules. Some of these were transported to the germ-cells, and so the altered character was transmitted to a further generation.

4. Darwin's hypothesis of Pangenesis failed to carry conviction among biologists, who regarded the assumption of the transportation of gemmules as resting upon no firm basis of fact. Nevertheless, the idea of material particles for a basis of heredity was felt to be sound and was revived a few years later by de Vries (cf. below, p. 599*). Meanwhile, however, the attention of naturalists was being diverted elsewhere. Darwin's great achievement in the promulgation of Natural Selection was not only a landmark in biological thought; it inaugurated a new era in biological work. Thenceforward the efforts of the biologist, whether botanist or zoologist, were devoted almost entirely to inquiring whether the doctrine of community of descent would serve to explain the existing forms of animals and plants.

The study of morphology became the keynote of biological thought during the last third of the 19th cent., and its students directed their efforts to the construction of elaborate schemes which should demonstrate the genetic relationship between the various groups into which the systematist had divided the existing forms of life (cf. art. EVOLUTION). Experimental work upon the living organism practically ceased; and, where the phenomenon of heredity came up for discussion, it usually received the perfunctory treatment accorded to a subject in which there is little or nothing fresh to be discovered. It has been well called the period of the essayists, chief among whom was August Weismann. In his work on *The Germ-Plasm* (1892), Weismann elaborated a complicated system to explain the hereditary transmission of characters. He insisted upon the sharp distinction between germ-plasm, or reproductive tissue, and somato-plasm, or body tissue. Hitherto it had been considered that the germinal gland was formed from the body, and, of course, separately formed for each indi-

vidual. The body of the individual intervened between the germ-plasms from which that individual arose and the germ-plasm to which it itself gave rise. Weismann, however, regarded the germ-plasm as the essential tissue, from which the somato-plasm was derived during the process of embryological development. The individual at first existed as germ-plasm derived from the commingling of parts of the two parental germ-plasms. As development proceeded, part of this germ-plasm was sacrificed to the formation of the somato-plasm, undergoing various modifications resulting in the formation of the various body tissues. But part of the germ-plasm remained undifferentiated in the sexual gland, until its turn came to produce germ-cells. The essential feature of Weismann's views was that the continuity between successive generations was provided by continuous germ-plasms mingling at intervals with one another. Wherever these germ-plasms mingled—wherever two fragments of the germ-plasm of opposite sexes came fruitfully together—the shock of their union led to the detachment of a portion of the combined germ-plasm, which became differentiated into the various body tissues and served as a carrier of the rest of the germ-plasm which had not undergone differentiation. The main current of the species lay along the track of the germ-plasm; the body was merely a side-track from that germ-plasm, arising under special conditions from time to time, whose destiny was to carry and protect that from which it itself had sprung.

5. At the time when Weismann promulgated his views, the majority of naturalists, following Darwin, believed that the effects of use or disuse of particular structures in the organism were transmitted to the direct descendants of that organism. The changes wrought in the body tissues by stimuli from the outside world in some way or other so affected the reproductive tissues that the organisms developing from them bore the impress, in a more or less marked degree, of the changes which had occurred in the parental body. It was in order to provide a basis for this possibility that Darwin had framed his hypothesis of Pangenesis. Underlying this hypothesis was a definite conception of the relation in which the germinal and body tissues stood to one another. They were imagined as alternating with one another, the body tissues being formed from germinal tissues and these again from body tissues. Since the germinal tissue was continually being derived from the body, it was not difficult to understand why definite changes in the body should have their counterpart in definite changes in the germinal tissue, and that these changes in the germinal tissue should in their turn become impressed upon the body tissues of the next generation. In this way changes induced in the body by some modification of external conditions—'acquired characters,' as they are often termed—might be supposed to be transmitted through the germ-cells to the next generation (cf. art. ENVIRONMENT). It is evident, however, that such a conception of the relation of the germinal tissue to the organism was opposed to the view which Weismann had put forward, and this led him to challenge the evidence for the transmission of 'acquired characters.' From experiments of his own, and from a critical examination of the evidence adduced by others, he came to the conclusion that 'acquired characters' are not transmitted, and the result of more recent work may, on the whole, be said to have confirmed Weismann in the position which he then took up. It is true that cases are on record in which a change induced in an organism was evidently followed by corresponding changes in the offspring produced by that organism. But it is not improbable that in such

cases the stimulus which acted upon the parental organism acted at the same time upon the germ-plasm contained in that organism, and that the cause of the corresponding change in the offspring was not the change in the parental organism, but a change in the constitution of the germ-plasm which occurred at the same time and under the same stimulus as that in the parent.

This conception of the relation between germ-plasm and somato-plasm may be regarded as Weismann's most important contribution to the study of heredity. In the exceedingly elaborate theory which he put forward in *The Germ-Plasm*, Weismann attempted to formulate a theory of heredity which should be in accordance with recent discoveries on the minute structure of cells and their contained nuclei. He regarded the nucleus of the germ-cells as the bearer of hereditary characters, and more especially that portion of the nucleus which, from its reaction to certain dyes, is known as *chromatin*. The chromatin was held to be a heterogeneous substance composed of numbers of minute entities, or groups of entities—the determinants. Upon the number and variety of the determinants depended the variety of the characters exhibited by the organism which arose from the fusion of two sexual cells derived from two germ-plasms. Moreover, it was supposed that the union of two dissimilar germ-plasms with different sets of determinants could bring about a state of affairs under which some form of natural selection within the cells decided whether certain determinants should be eliminated.

To follow Weismann's theory in detail would be hardly profitable. More modern work has demonstrated that his conception of a heterogeneous germ-plasm and of discrete determinants in the germ-plasm corresponding to characters in the developed organism probably approximates to the truth. Nevertheless, his theory lacked compulsion because it was not based upon the facts of heredity—the one class of facts upon which such a theory could have rested firmly.

6. To the essayist period belongs one other work of some importance. In 1889, Hugo de Vries formulated his views in a work on *Intracellular Pangenesis*. He accepted Darwin's view that the individual hereditary qualities are dependent on individual material bearers in the living substance of cells, but he differed from Darwin in refusing to believe that these material bearers, or pangens, could be transported in the blood stream about the body. According to de Vries, the nucleus of every cell in an individual contains the sum-total of the pangens found in that individual, but only some of them occur in the extra-nuclear protoplasm of the cell. The nature and properties of the cell, whether muscular, nervous, glandular, etc., were held to depend upon the nature and variety of the pangens which were to be found in the extra-nuclear protoplasm. This stimulating essay may be regarded as marking the close of a period in the study of heredity, for but a few years were to elapse from its publication before a new light was suddenly flashed upon the whole subject, and heredity took its place among the experimental sciences.

7. While biologists and philosophers who were interested in these matters had been busily weaving new theories, an Austrian monk had turned aside and quietly experimented for himself. The results of his investigations were communicated by Gregor Mendel to a Natural History Society in Brünn, in the *Proceedings* of which they were published in 1865. In 1900, nearly twenty years after Mendel's death, his paper was discovered, and the remarkable nature of his achievement was rapidly appreciated. Mendel's success was largely

due to the fact that he planned his experiments on lines different from those of any of his predecessors. Instead of making numbers of somewhat random and haphazard crosses among the plants studied by him, he concentrated his attention on certain characters in which allied varieties differed from one another, and persistently followed their distribution over a succession of generations. He was careful also in his selection of a plant with which to work, choosing the edible pea (*Pisum sativum*) on account of its hardiness, its annual habit, its faculty of self-fertilization, and the number of sharply differentiated characters found in it.

The nature of Mendel's discovery may best be explained by considering some of his own results. In one set of his experiments with the pea he chose length of internode as the character with which to work. In some peas the internodes are long, and such plants reach an average height of 6-8 feet. In others, again, the internodes are short, and the plants average but 1½-2 feet. Having obtained true breeding strains of each of these varieties, Mendel proceeded to cross them, and in this case it made no difference whether the tall was used as the pollen parent or *vice versa*. In either case the result was the same; only tall plants, at least as tall as the original tall parent, resulted from the cross.¹ The seeds of these plants, which are normally self-fertilized, were collected and sown in the following year. The generation so produced (F_2) consisted of both tall and dwarfs, but no intermediates. Careful counts on large numbers showed that the proportion of tall to dwarfs was 3:1. The dwarf character receded in the F_1 generation, but reappeared in a definite proportion in the F_2 generation following. For this reason Mendel termed the dwarf character *recessive* and the tall *dominant*.

The experiment was continued into a further generation, the seeds of a number of F_2 plants being sown and special care taken to keep those from each individual entirely separate. The nature of the resulting F_3 generation showed that the dwarfs all bred true, but that the tall belonged to two classes, viz. those which bred true and those which gave tall and dwarfs in the ratio 3:1 (cf. fig. 1), behaving like the F_1 plants. Of these two classes that which threw dwarfs was found to be twice as numerous as that which bred true.

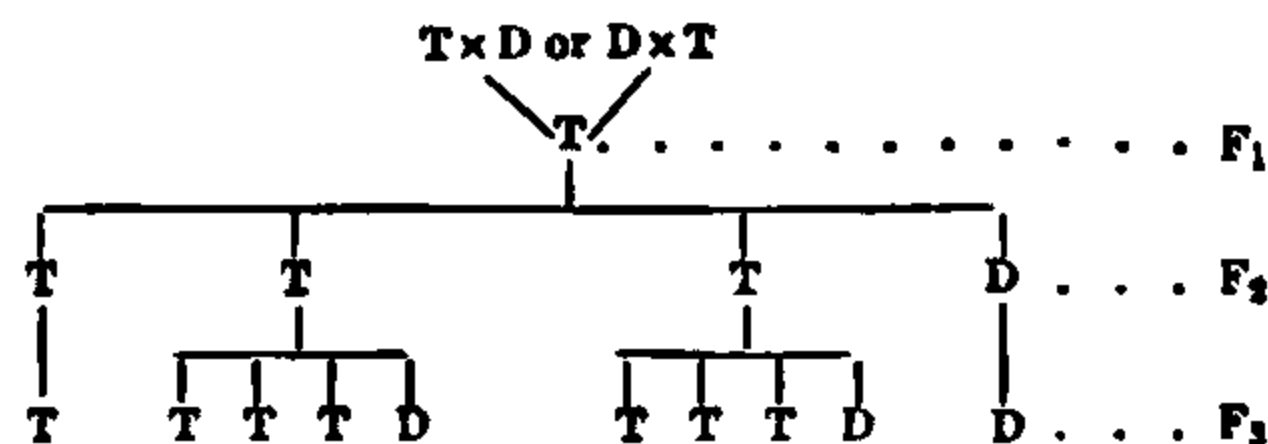

FIG. 1.

Throughout these and further generations, Mendel encountered only three classes of plants in so far as the pair of differentiating characters, tallness and dwarfness, were concerned, viz. (1) pure tall breeding true to tallness; (2) impure tall throwing tall and dwarf in the ratio 3:1; (3) dwarfs which always breed true. Moreover, the relation worked out for this pair of characters was found to hold good for other pairs. Thus the yellow colour of the cotyledons of the ripe seed was found to be dominant to green, round seed shape to wrinkled, tough parchment-like pod to soft pod, etc.

By looking at the pea in this way it was possible to express much of the variety of forms under which they occur in terms of alternative characters, each pair of which taken separately followed the scheme of inheritance outlined above. Mendel not only provided the scheme; he also suggested the explanation. He supposed that the various characters shown by his peas existed in alternative pairs. The pea could be either tall or dwarf; the seed could be either yellow or green; the flower could be either coloured or white; and so on. The characters belonging to such alternative pairs were mutually exclusive. Every pair of characters was represented by something in the germ-cells, but any given germ-cell could carry only the representative of either one or the other of a given pair of characters. To these representatives of the characters in the germ-cells it is now usual to apply the term *factor*. On Mendel's idea there was a factor corresponding to tallness, and another corresponding to dwarfness, but a given germ-cell could carry only either the factor for tallness or

¹ It is customary to denote the result of a first cross as the F_1 = first filial generation. Similarly the offspring from the F_1 individuals form the F_2 (second filial generation), the offspring of these last the F_3 generation, and so on.

that for dwarfness—but not both. All the germ-cells of the pure tall carried the factor for tallness, and all the germ-cells of a dwarf carried that for dwarfness. The cross between the tall and the dwarf meant the union between a tall-bearing germ-cell, or *gamete*, and a dwarf-bearing *gamete*, so that the individual, or *zygote*, produced by the yoking together of these gametes contained both the factor for tallness and that for dwarfness.

Such a zygote, which is produced by the union of two unlike gametes, is termed a *heterozygote*, as distinguished from a *homozygote*, which is produced by the union of two like gametes. In the case of the peas the tall factor is completely dominant over the dwarf factor, and the heterozygous tall is in appearance indistinguishable from a homozygous tall. But the difference comes in when it forms its gametes. Its own cells must be supposed to contain both of the factors for tallness and dwarfness. But, as Mendel assumed that these cannot enter into the same gamete, a separation then occurs so that half the gametes contain the tall, and half the dwarf factor. In other words, a *segregation* of the factors occurs during the production of the gametes, and the gametes themselves are pure for either the one factor or the other (see fig. 2).

The F_1 heterozygous pea, therefore, is producing equal numbers of tall-bearing and of dwarf-bearing gametes, and this is true for both the male and the female gametes. Self-fertilization of the F_1 plant means the bringing together of two such series of gametes.

Let us suppose that the number of ova is $4x$, $2x$ of which are 'tall' and $2x$ 'dwarf.' Any 'tall' ovum has an equal chance of being fertilized by a 'tall' or a 'dwarf' pollen-grain. Of the $2x$ tall ova, therefore, x will give rise to homozygous tall, and x to heterozygous tall. Again, any dwarf ovum has also an equal chance of being fertilized by a 'tall' or a 'dwarf' pollen-grain.

found by actual experiment. The nature of the gametes given off by the F_1 plant may, as Mendel showed, be further tested by crossing such plants with the pure recessive. If the F_1 tall plants are producing equal numbers of 'tall' and 'dwarf' gametes, they ought, when crossed with dwarf plants, to give both tall and dwarfs in equal numbers, and of the tall so produced all should throw dwarfs. Here, again, the hypothesis was confirmed by the experimental results.

More recently these experiments of Mendel have been confirmed many times over, and it has been shown that the same scheme applies generally to animals as well as plants.

8. One modification of Mendel's view was suggested a few years ago, and has since been generally accepted by students of this subject. This is the so-called 'Presence and Absence' hypothesis. Mendel had shown that the characters of his peas could be arranged in alternative pairs, and recent work has proved that this is general for the characters of both plants and animals. Of all the many cases now worked out there is none in which there is a clear reason for supposing the existence of series of three or more characters each of which is alternative to any other. This remarkable fact has led to a modification of Mendel's original view. According to Mendel, there is a factor for tallness and one for dwarfness, and the relation between them is such that it is impossible for them to enter the same gamete. According to the 'Presence and Absence' hypothesis, there is also a factor for tallness and one for dwarfness, but there is no reason why they should not enter into the same gamete. It is supposed that every pea at present known is homozygous for the factor for dwarfness, D , and that the difference between the dwarf and the tall is that the latter possesses an additional factor, T , in virtue of which it becomes tall. If the factor T is brought in by both the gametes which make a tall plant, the result is a homozygous tall; if only by one gamete, then a heterozygous

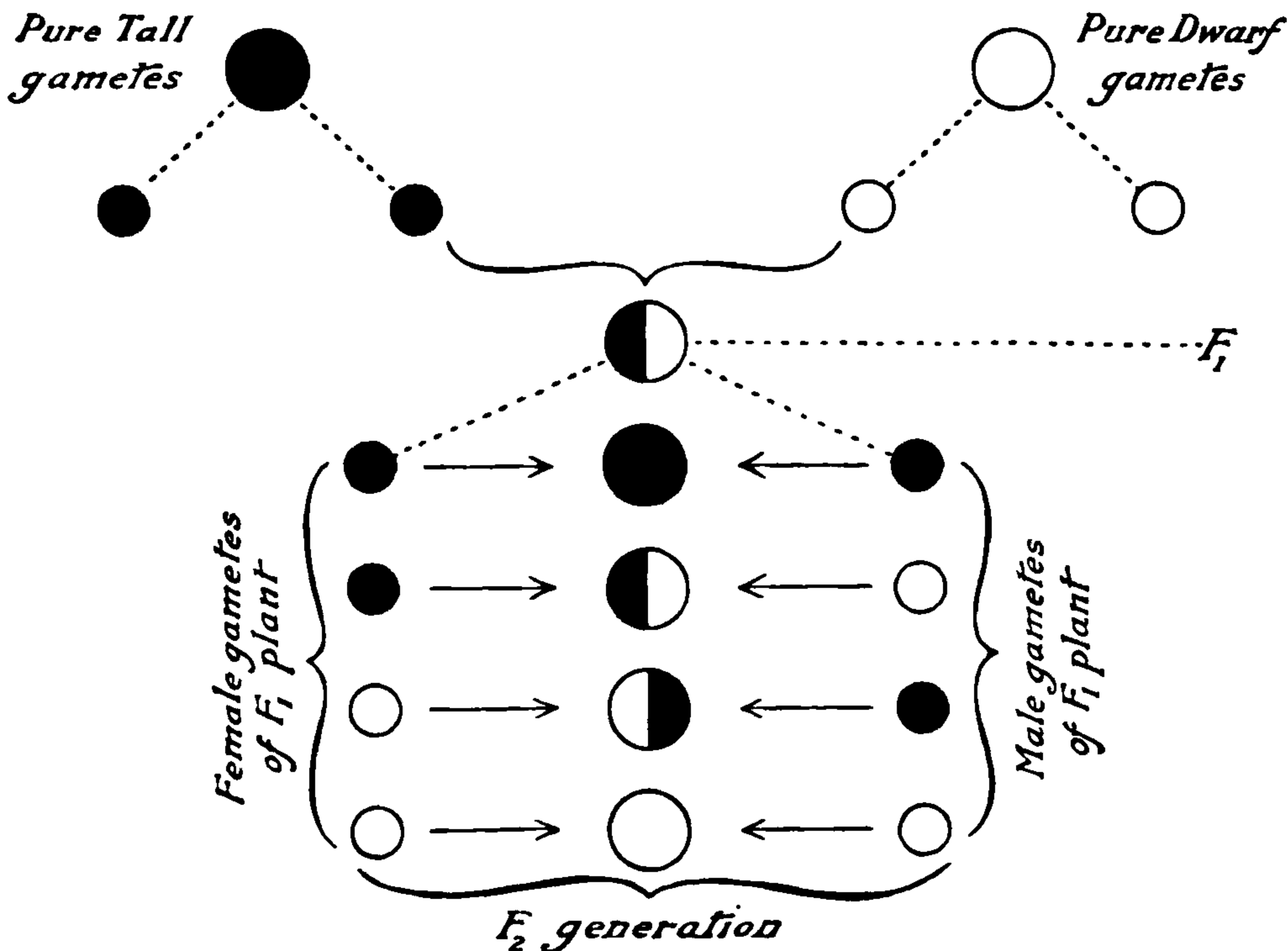

FIG. 2.

Of the $2x$ dwarf ova, therefore, x will give rise to heterozygous tall, and x to homozygous dwarfs. Hence, on this hypothesis of the relation of characters and factors in plant and germ cell, the F_2 generation should consist of x homozygous tall, $2x$ heterozygous tall, and x dwarfs—proportions which Mendel

tall results. The essential difference between the two views may perhaps be rendered more clear by the help of the accompanying diagrams (fig. 3).

In this way the Presence and Absence hypothesis

offers a simple explanation of the remarkable fact that experimental analysis has shown, that the characters of plants and animals may be expressed in terms of alternative pairs. This apparent

tween a plant containing both of these factors and a plant containing neither. Since one of the plants is homozygous for both *A* and *B*, we may represent it as *AABB*, and all its gametes as *AB*. The other plant contains neither *A* nor *B*, and for convenience we will express such a condition as *aabb*, the small

Mendel's Original View

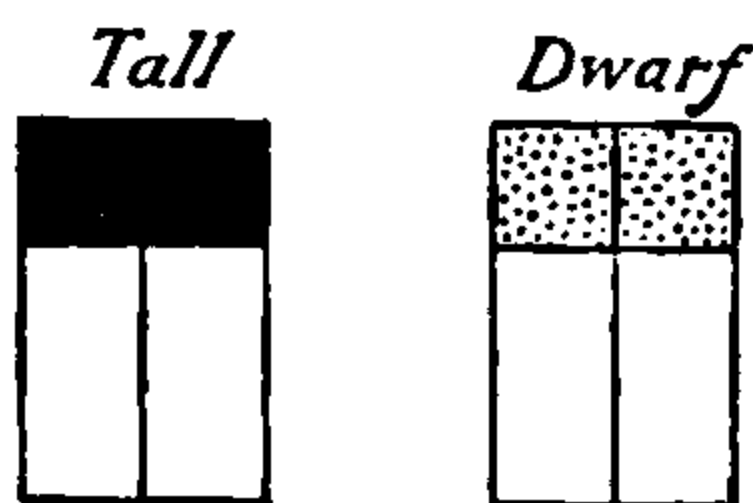

'Presence & Absence' View

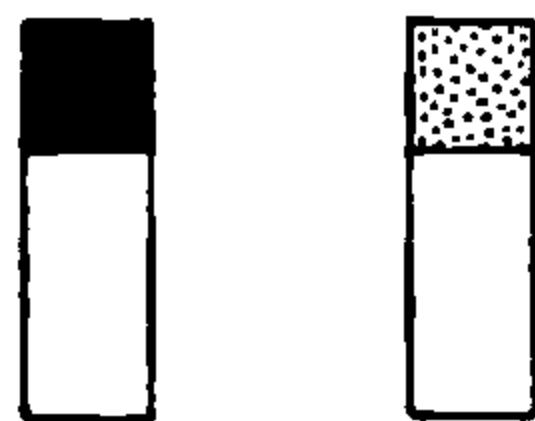
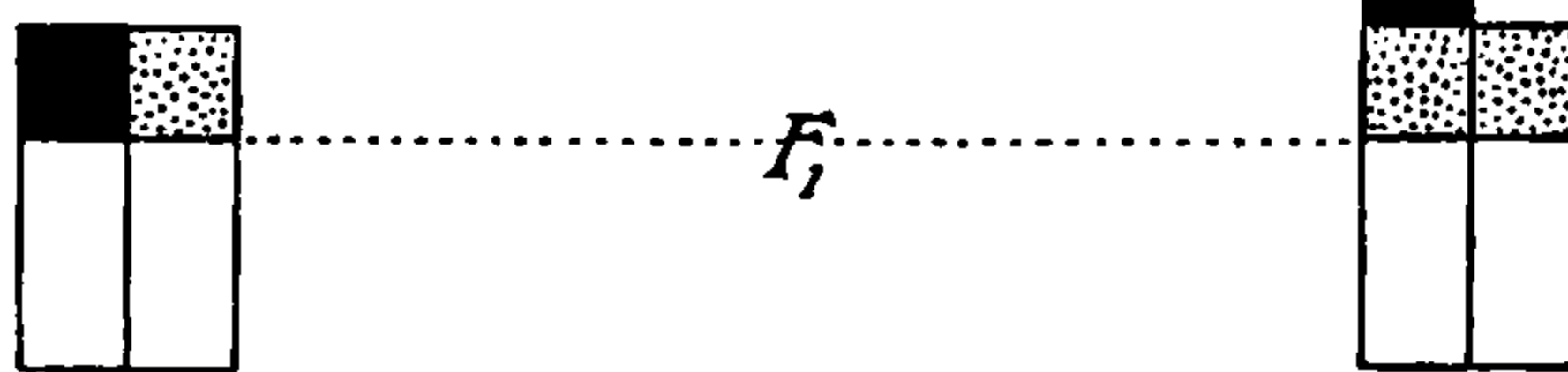
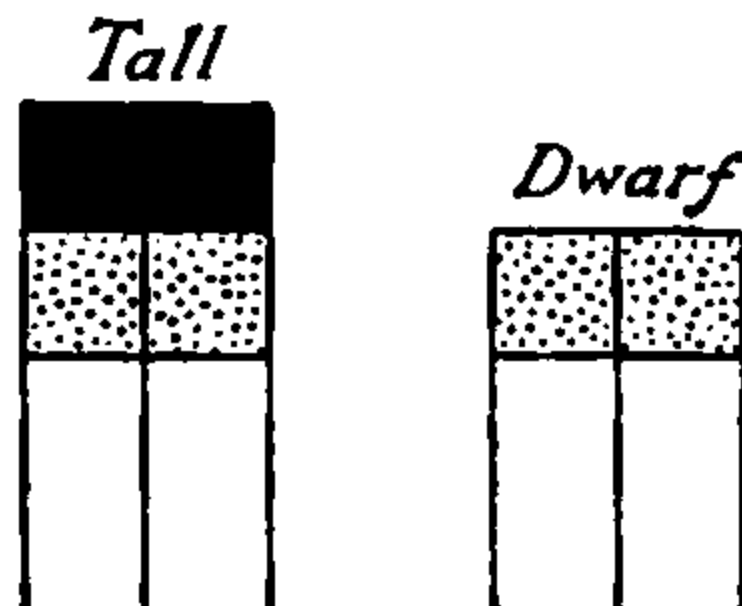

Gametes produced by F_1

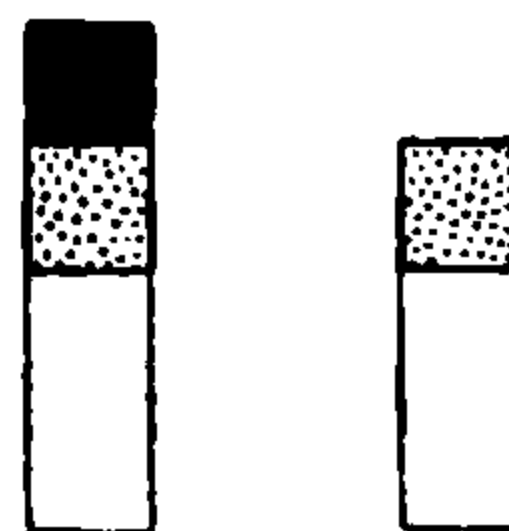

FIG. 3.—A black square represents the factor for tallness and a dotted square that for dwarfness. The unshaded portion represents the rest of the characters comprised in 'peaness.'

alternativeness is due to the fact that a given factor can enter into relation with a gamete in two ways only—it may be present or it may be absent. Mendel's own results can be explained equally well on either hypothesis. It was only when more complicated cases came to be worked out, and more especially cases where several factors affected the same structure, that the difficulty of affording an explanation on his original view became evident.

9. So far the only type of case considered is that in which the two original parents entering into the cross differ by a single character. Mendel, however, worked out instances in which several characters are concerned, and found the transmission of each character to be independent of any other, but always on the same scheme. For example, in the case where the characters round seed as opposed to wrinkled and yellow cotyledon as opposed to green were involved, a cross between a yellow round and a green wrinkled gave an F_1 generation composed entirely of yellow rounds.

Self-fertilization of these plants resulted in the formation of four classes of seeds, viz. yellow round, yellow wrinkled, green round, and green wrinkled; and the relative proportions in which these four classes appeared were as 9 : 3 : 3 : 1. The yellows are to the greens as 3 : 1, and the rounds are to the wrinkled as 3 : 1 with the factor for yellowness and the factor for roundness each being transmitted according to the same scheme, but quite independently of one another. The analysis of such cases as these is perhaps rendered more simple by regarding it in the following way:

Let *A* stand for one of the two factors brought into the cross, and let *B* stand for the other, and let the cross be made be-

letter in each case being used as a symbol denoting the absence of the particular factor in question. The F_1 individual resulting from the cross, being heterozygous in both factors, must be represented as *AaBb*. Every one of the gametes formed by such a plant has an equal chance of containing *A* or of not containing it, and each of these two kinds of gamete has an equal chance of containing or of not containing *B*. Such an individual will therefore form the four sorts of gamete *AB*, *Ab*, *aB*, *ab* in equal numbers. The F_2 generation results from the meeting together of two such series of gametes, and the result can be simply expressed by writing the series horizontally and vertically in the same order in a system of 16 divisions, as is shown in fig. 4. In this way is shown not only the nature

<i>AB</i>	<i>AB</i>	<i>AB</i>	<i>AB</i>
<i>AB</i>	<i>Ab</i>	<i>aB</i>	<i>ab</i>
<i>Ab</i>	<i>Ab</i>	<i>aB</i>	<i>ab</i>
<i>AB</i>	<i>Ab</i>	<i>aB</i>	<i>ab</i>
<i>aB</i>	<i>aB</i>	<i>aB</i>	<i>aB</i>
<i>AB</i>	<i>Ab</i>	<i>aB</i>	<i>ab</i>
<i>ab</i>	<i>ab</i>	<i>ab</i>	<i>ab</i>
<i>AB</i>	<i>Ab</i>	<i>aB</i>	<i>ab</i>

FIG. 4.

of the F_2 generation, but also the zygotic constitution of the various individuals. A point of some interest is that 4 individuals lying along the diagonal drawn from the left top to the right bottom corner are homozygous either for the presence or for the absence of both factors. In other words, of the four visible zygotic classes there will be a definite proportion in each case breeding true subsequently, viz. 1 in 9 of the class containing both dominants, 1 in 3 of the two classes containing one dominant, and, of course, all of those containing neither dominant. The point is of considerable economic importance in connexion with the building up and fixing of new varieties of domesticated plants and animals.

This method of analysis for cases involving the presence or absence of two distinct factors is, of course, applicable to cases involving a larger number of factors, and many such cases have now

been worked out for various characters in plants and animals and shown to accord with the theoretical scheme. The nature of the F_2 generation, the number of forms which appear with it, and their numerical proportions form the first stage in the determination of the number of factors involved in a given cross, and so of the experimental analysis of the constitution of living things.

There are, however, cases in which the same scheme of heredity holds good, but in which a fresh complication is introduced by the fact that the factors concerned may interact upon one another. The factors A and B may in conjunction produce an effect which is absent when only one or other alone is present. Instances of this have been shown to occur among plants where two strains of whites, each breeding perfectly true to white, will nevertheless, when crossed, give rise only to plants with red flowers. The colour in such cases is due to the interaction of two things A and B , and colour can be produced only when they are simultaneously present in a plant. The crossing of the two whites brings together the two constituents necessary for the production of colour, and the F_1 plant is consequently coloured, being heterozygous for both A and B . Reference to fig. 4 shows that the F_2 generation from such a zygote should contain 9 individuals out of every 16 in which both A and B are present. The remaining 7 have either A or B alone or neither. Hence, from such coloured F_1 plants hypothesis would lead us to expect an F_2 generation consisting of coloured and whites in the ratio 9:7. And this is what experiment has shown actually to occur. Moreover, chemical evidence quite independent of breeding tests is gradually accumulating, suggesting that in such cases as this we are dealing with two definite substances—a ferment, and a colourless chromogen which can give rise to colour when acted upon by the ferment. One of the original whites must be regarded as carrying the chromogen and the other the ferment; whether the gametes actually carry these substances is uncertain, but in any case they carry something which is capable of developing them.

10. Analysis of these cases, which are to be interpreted by the interaction of factors, has thrown an interesting light upon what was formerly the puzzling phenomenon of reversion or crossing. Two white sweet peas may, on being crossed, give rise to a purple which is practically identical with the wild purple as it grows to-day in Sicily. The offspring of a chocolate brown and a yellow rabbit may be all of the wild grey colour. In such cases each of the two parents lacked one or more from the sum-total of the factors which go to make up the wild form. Together, however, they can make up that sum-total with the consequence that reversion at once occurs. Reversion is due to the coming together again of factors which had become lost at some point or other in the history of the species. The study of reversion opens up interesting questions in connexion with the relation between domesticated forms and their wild prototypes. It is only in some cases, of course, that we are certainly acquainted with the wild species which was the ancestor of domesticated races. Where such is the case, genetic analysis has shown that these domesticated varieties must be supposed to have arisen through the loss of one or more factors. Such is the case with almost all the many colour varieties of the rabbit and the mouse. Such is the case with all the colour and structural varieties of the sweet pea. It is probable that the change originated somewhere in the cell-division, giving rise to the germ-cells.

Asymmetrical divisions occurred such that some germ-cells obtained less than their full quota of

factors, and from these germ-cells sprang the recessive varieties. The sequence of such new 'sports' or mutations has been observed with some care in certain instances, such as that of the primula (cf. art. EVOLUTION), but at present we are without definite evidence as to the original seat of the change. There are other instances where the domesticated form possesses a character which is dominant over the wild form. The English pattern in the rabbit, the yellow coat colour in the mouse, and the rose comb of poultry are all dominant to the condition found in the wild form. The gain of a new factor is a more difficult conception to formulate than the loss of one old one, but it is not improbable that it may eventually be expressed in terms of some rearrangement of the elements already present. But, in whatever way they may eventually be interpreted, there seems no reason to doubt that new dominant characters may arise from time to time.

11. One further complication sometimes occurring in cases where the factors are concerned may be mentioned here. We may have a pair of characters due to the presence or absence of a factor A , and it may be that neither character can show itself except in the presence of a second factor B .

As an example we may take a case relating to coat colour in some rodents. The wild grey or agouti colour in mice is dominant to black, and depends upon an additional factor A which is not found in the black mouse. Animals heterozygous for A , when mated together, will produce offspring consisting of agoutis and blacks in the ratio of 3:1. Now, albinism is recessive to colour, and coloured mice must, therefore, be regarded as possessing a general colour factor B which is absent from the albino. When animals which are heterozygous for these two factors are mated together, the scheme of distribution of the factors A and B will be that already shown in Fig. 4. Of the 16 possibilities there are 12 containing A and 4 without A —the expected ratio 3:1. But 3 of the 12 containing A lack the factor B , as also does one of those which is without A . Since they lack a factor which is necessary for the production of colour of any sort, these four mice will be albinos. Judging, therefore, by visible attributes, three classes of mice should appear from this mating, viz. agoutis, blacks, and albinos in the ratio of 9:3:4. And these are the proportions actually found by experiment. The albinos are really of two different sorts, viz. those containing A and those without A —'agouti' albinos, and 'black' albinos in the proportion 3:1. That this is so can also be tested experimentally by crossing these F_2 albinos with pure black, i.e. blacks which are homozygous for the factor B . Some of the albinos, i.e. those homozygous for A , give only agouti offspring; others, which are heterozygous for A , give agoutis and blacks in approximately equal numbers; while the 'black' albinos which lack A give nothing but blacks. The 9:3:4 ratio obtained in the F_2 generation is really a 9:3:3:1 ratio, but it is not possible to distinguish the four classes by the eye, owing to the fact that the agouti factor produces no visible effect unless the factor B is also present.

That the above four classes exist is evident from appropriate breeding tests, and cases of this nature are in no way different from those already considered with regard to the complete independence in transmission of the different factors concerned. Nevertheless, there are cases in which factors must be supposed to influence one another in their distribution among the germ-cells. Cases of this nature have further been worked out most fully in the sweet pea, and it is from this plant that the following illustrative examples are taken:

Two kinds of pollen are to be found in the sweet pea, an oval or 'long' pollen which has 3 pores, and a smaller 'round' pollen which has only two pores. Only one sort, of course, occurs on any given plant. In heredity, long pollen (L) behaves as a simple dominant to round (l). Again, with regard to colour, sweet peas may be arranged in two main groups, purples and reds. To each red there is a corresponding purple, the difference between the two being that the purple contains an extra factor (B) as compared with its corresponding red. When a long pollinated purple (BLL) is crossed with a round pollinated red ($bbll$), the F_1 plants are all long purples; and, were the case similar to those that have already been considered, we should look for an F_2 generation consisting of long purples, round purples, long reds, and round reds in the ratio 9:3:3:1. Such, however, is not the nature of the F_2 generation. The four expected classes appear, it is true, but they appear in proportions very different from those expected. The long purples are about 12 times as numerous as the round purples, while the round reds are rather more than 3 times as many as the long reds. The 3:1 ratio of purples to reds and of longs to rounds

is undisturbed, but the distribution is peculiar in that there is a great deficiency of rounds among the purples and a great excess of rounds among the reds. This, then, is the nature of the F_2 generation when the cross is so made that both the factors L and B are brought into the cross by the same parent. When, however, one of these factors is brought in by each parent, a round purple being crossed with a long red, the nature of the F_2 generation is quite different. The reds are now almost all long pollened, while the round pollened plants are almost all purples. This case, as well as others in the sweet pea, is explicable on the hypothesis that two of the four classes of gametes are produced by such plants in greater numbers than the other two classes. In the special instance just considered the experimental numbers are in accordance with the view that the F_1 plant made by bringing both factors from one side ($BL \times bd$) produces its four kinds of gametes in the ratio $7BL : 1Bl : 1bL : 7bl$, whereas the F_1 plant made by bringing both factors from one side ($Bl \times bL$) produces its four kinds of gametes in the ratio $1BL : 7Bl : 7bL : 1bl$. In the former case B is said to be 'coupled' with L , while in the latter case there is said to be repulsion between B and L . In both cases the two kinds of gametes representative of the original parents are produced in excess. Several other cases recently worked out in the sweet pea and other plants suggest that this excess of certain gametes is part of an orderly scheme, the nature of which may be best indicated by the following table.

consists only of singles, and these when bred from behave alike, all throwing doubles as well as singles. When, however, the double-thrower is used as the female parent, the F_1 generation as before consists only of singles; but whereas some of these singles throw doubles when subsequently bred from, others of them breed perfectly true. From this and other facts of kindred nature it has been inferred that the female and male reproductive cells on the same hermaphrodite plant differ in their hereditary properties, one set being, as it were, associated with certain factors which are not found in the other set. It is not inconceivable that different portions of the germ-gland of an animal may differ in hereditary properties, but at present there is no definite ground for supposing this to be so. The solution of such problems as these depends largely upon whether it is possible to determine the exact stage at which segregation occurs. Perhaps the view most widely accepted at present is that it

No. of Gametes in Series.	Classes of Gametes.				No. of Zygotes in Series.	Classes of Zygotes.			
	AB	Ab	aB	ab		AB	Ab	aB	ab
$2n$	1	$n-1$	$n-1$	1	$4n^2$	$2n^2+1$	n^2-1	n^2-1	1
32	1	15	15	1	1,024	513	255	255	1
16	1	7	7	1	256	129	63	63	1
8	1	3	3	1	64	33	15	15	1*
4	1	1	1	1	16	9	3	3	1*
8	3	1	1	3	64	41	7	7	9*
16	7	1	1	7	256	177	15	15	49*
32	15	1	1	15	1,024	737	31	31	225*
64	31	1	1	31	4,096	3,009	63	63	961
128	63	1	1	63	16,384	12,161	127	127	3,909*
256	127	1	1	127	65,536	48,897	255	255	16,129
$2n$	$n-1$	1	1	$n-1$	$4n^2$	$3n^2-(2n-1)$	$2n-1$	$2n-1$	$n^2-(2n-1)$

In the table n is half the total number of gametes in the series. (Thus, in the case just considered the number of gametes in the series $7BL : 1Bl : 1bL : 7bl$ is 16, and n here = 8.) The right-hand side of the table indicates the nature of the F_2 generation arising from the cross. In the table n is represented throughout as some power of 2 (i.e. 2, 2², 2³, etc.). Where there is coupling in F_2 , the 2 forms of gamete AB and ab are $(n-1)$ times as numerous as the 2 forms Ab and aB ; where there is repulsion in F_2 , the reverse is the case. There is reason for supposing that for the same pair of factors the value of n for both the repulsion and coupling series is the same. Most of the cases hitherto discovered in plants may be regarded as belonging to one or other of the series shown in the table, and those already discovered are marked with an asterisk. It is not improbable that other series may exist, but not enough is yet known to justify any definite statement as to their exact nature. What is clear, however, is that, in the process of cell-division which leads to the formation of the gametes, factors may become linked together, or the reverse, according as the cross is made, and that the resulting 'coupling' or 'repulsion' is part of the same orderly process.

Phenomena of apparently similar nature have been witnessed in a few instances among animals, and there is little doubt that, when they come to be fully worked out, these processes will be found to play an important part in heredity. More especially is this likely to be the case where we are concerned with characters which are, as a rule, peculiar to one or other sex, for it is not improbable that the so-called secondary sexual characters are linked in this way with a sex factor. For further discussion of these matters the reader is referred to the article SEX.

12. A phenomenon of some interest in this connexion is exhibited by certain hermaphrodite plants. It has been known for many years that some strains of single stocks throw doubles as well as singles, and that, as the doubles are sterile, the only way to get them is to breed from such singles. When crossed with ordinary pure breeding singles, these double-throwing singles give a different result according to the way in which the cross was made, i.e. whether the double-thrower was used as the male or as the female parent. The F_1 generation

occurs at that stage in the formation of gametes which is termed the 'reduction division'—a phenomenon peculiar to the vast majority of plants and animals. The nuclei of the cells composing the tissues of animals are characterized by the presence of small bodies which stain deeply with certain dyes and are consequently termed *chromosomes*. It has been found that, as a rule, the number of chromosomes in any given species is constant or nearly so, though differing for different species. Were the gametes to contain the same number, the total number of chromosomes would be doubled each time two gametes fused to form a fresh generation. This is avoided by a complex process leading up to the 'reduction division,' by which the number of the chromosomes in the gametes is reduced to one half of that found in the nuclei of the body tissues. It is plausible to suppose that the segregation of factors occurs at this stage, though it cannot be said at present that the evidence in favour of this view is sufficiently strong to put other possibilities out of court. Indeed, there are certain classes of evidence which tell markedly against it, more especially the phenomena of coupling and repulsion, and the fact that in certain heterozygous plants the ova and spermatozoa may differ in the factors which they bear. It is not altogether impossible that in these matters there may be a difference between plants and animals, but at present the question must be left open.

13. At this point mention should be made of a phenomenon which may serve to complicate the process of genetic analysis. It has been assumed in the foregoing account that any given gamete of one sex is capable of being fertilized by any gamete of the other sex, and of giving rise to a fresh individual. There is, however, some evidence to show that in certain cases fertilization may occur, but that some of the zygotes formed are incapable of developing very far.

In the mouse, yellow is dominant to the wild agouti colour, but heterozygous yellows when bred together produce yellows and agoutis in the ratio 2 : 1 instead of the expected 3 : 1 ratio. On further testing these yellows it has been found that none of them is ever homozygous for the dominant yellow factor. One of two things must therefore occur: either there is repulsion between a 'yellow' ovum and a 'yellow' sperm, so that they refuse to unite; or else they unite to form a zygote which is incapable of development. On the former hypothesis there is nothing to prevent all the 'yellow' ova from being fertilized by agouti spermatozoa: and, since there is an equal chance of an 'agouti' ovum being fertilized by a 'yellow' or an 'agouti' sperm, the expectation, on this hypothesis, of mating yellows together would be 3 yellows : 1 agouti—all the yellows being heterozygous. But in many hundreds of mice so bred the ratio of yellow to agouti is definitely 2 : 1. Hence it must be supposed that the 'yellow' sperm can unite with the 'yellow' ovum, but that the resulting zygote is incapable of developing, at any rate beyond a comparatively early embryological stage.

This peculiar case in the mouse has recently been paralleled by an interesting one in the snapdragon (*Antirrhinum*). A form is known with light green foliage which will not breed true when self-fertilized, but always produces light green and normal green plants in the ratio 2 : 1. Careful examination, however, showed that three different kinds of seedling made their appearance among the progeny of such plants, viz. normal green, light green, and white in the ratio 1 : 2 : 1. The white, however, being without chlorophyll, were incapable of development and perished almost as soon as they raised their heads above the ground. The 'white' gametes fertilized one another, but the resulting zygote, though capable of a certain amount of development, was unable to attain any size owing to the absence of the chlorophyll upon which the plant depends for its nutrition. The case of the snapdragon, even more than that of the yellow mouse, points to the non-viability of certain zygotic combinations, and it is not impossible that such cases may eventually help to throw light upon some of the phenomena of sterility.

14. The opinion is held among many breeders that, in certain cases at any rate, a character may be intensified or diminished by a process of long-continued selection—in other words, that the effect of this process is a cumulative one. On the other hand, it is well recognized that there is a definite limit to the effects produced by the process of selection. There is no reason for supposing that the last half-century of careful breeding has materially increased the speed of the racehorse, or that the yield of any food-plant can be indefinitely augmented merely by saving and growing on the seed from the best plants. However the theorist may regard the matter, the practical breeder realizes that there is a limit to improvement, and that in most cases this limit is reached after comparatively few years' work.

Some confusion has been introduced into discussion on the effect of selection owing to the fact that the word conveys a somewhat different meaning to the biologist and to the practical breeder. The aim of the breeder is to obtain some more profitable type of animal or plant, and his first step is to cross two strains possessing desirable qualities, usually with the idea of uniting these qualities in a single strain. He then breeds on the individuals resulting from the cross for several generations, or else crosses them back with one or other of the parents, and from the mixed lot so obtained he picks out those he wants for subsequent breeding from. Having found a useful type, he goes on breeding from it until it breeds true, or becomes 'fixed.' The result of this combined process is generally termed 'improvement through selection.' Translated into modern terms, it means recombination of characters by means of a cross, and subsequently establishing a homozygous strain of the combination required. Neither part of this process is strictly comparable with what the biologist understands by the term 'selection.' For him the word has been coloured by the invention of the term 'natural selection'; and, as natural selection was originally conceived of as the gradual accumulation of very small variations leading slowly to a change of type (cf. art. EVOLUTION), so the term 'selection,' even when applied to alteration of type among domesticated animals and plants, was more or less unconsciously

assumed to be a similar process. Hence, when the breeder spoke of a given result having been achieved by selection, the biologist was often apt to put his own interpretation upon the process, and to attribute to the gradual accumulation of minute variations a result which was certainly not brought about in that way.

Nevertheless, there is evidence that, in certain cases at any rate, a character may be to some extent intensified through crossing, and subsequently choosing for further breeding such individuals as exhibit the character in the most marked degree; but, as has been pointed out, more especially by Nilsson-Ehle, such cases may also be interpreted in terms of factors.

Working with wheat, this observer showed that red colour in the grain is dominant to white. But in different families three distinct proportions of reds and whites may occur. The reds may be to the whites as 3 : 1, as 15 : 1, or as 63 : 1. The inference is that in the first case we are dealing with the presence or absence of one factor, in the second of two, and in the third of three factors. And since each of these factors produces what is apparently precisely the same effect singly, it is probable that we are concerned with a single factor throughout. It must be supposed that a gamete can bear either one, two, or three doses of this factor, and that each dose behaves in heredity independently of the others, segregating in every case in the normal way. Thus, for example, a plant may be triply heterozygous for the factor R which turns white into red, and of the constitution $R_1 r_1 R_2 r_2 R_3 r_3$. Such a plant produces equal numbers of eight sorts of gametes, $R_1 R_2 R_3$, $R_1 R_2 r_3$, $R_1 r_2 R_3$, $R_1 r_2 r_3$, $r_1 R_2 R_3$, $r_1 R_2 r_3$, $r_1 r_2 R_3$, $r_1 r_2 r_3$. Hence, when such plants are self-fertilized, only one in 64 will be without any red factors; and this plant ($r_1 r_1 r_2 r_2 r_3 r_3$) is, of course, a white. The reds, however, differ considerably in the number of doses of the red factor which they may contain. Among them will be such forms as $R_1 R_1 R_2 R_2 R_3 R_3$, $R_1 R_1 R_2 R_2 R_3 r_3$, $R_1 R_1 R_2 R_2 r_3 r_3$, $R_1 R_1 R_2 r_2 r_2 R_3 R_3$, $R_1 R_1 R_2 r_2 r_2 r_3 r_3$, etc. A red plant may have from one to six doses of the reddening factor, and Nilsson-Ehle found by further breeding that the red colour was deeper in those plants which contained the greater number of doses of the reddening factor ($R_1 = R_2 = R_3$). The differences, however, were not sufficiently sharp to permit of accurate sorting. Now, selection of the reddest grains from such a family would mean the picking out of those grains with perhaps 6, 5 or 4 doses of R to the exclusion of those with less. Were these reddest grains sown indiscriminately and the reddest again sorted from them, there would result a higher and higher proportion of the 6 dose grains in the sample. Repetition of this process would in a few generations eliminate the 5 and 4 dose grains; and, as the 6 dose grains are homozygous, the intenser red colour would be fixed.

At first sight it seems not unnatural to attribute this result to the action of selection taking effect much in the same way as the biologist conceives the operation of natural selection on minute variations. But it must be carefully noted here that, although the variations are small so that the various classes of reds grade into one another, yet each class has a specific constitution depending upon the number of doses of the factor R which it contains. Each class can be analyzed and identified by crossing with the white and subsequently breeding from the crosses. The net result is the intensification of the red; nevertheless, what has happened in such a case is merely the picking out of what had already come into existence as the result of the cross, and the intensification of the colour owes nothing whatever to the so-called selective process. There is no reason for supposing that such cases as these lie outside the scope of analysis, or that they cannot be expressed in terms of genetic factors.

15. From all the various investigations that have been carried out since the re-discovery of Mendel's work, there emerges one fact of cardinal importance. So far as these investigations have proceeded, it is possible to express the results in terms of definite factors segregating sharply from one another in the way that Mendel first disclosed. A new science has been brought into being—a science of which the aim is to express the composition of living things in terms of factors, just as chemistry expresses the composition of dead things in terms of molecules. How complete that expression may ultimately become it is not as yet

possible to say. Fresh data may any day make their appearance which will present the old phenomena in a new light. For the present, however, there is every reason to suppose that the properties of animals and plants depend upon the presence or absence of definite factors which in transmission follow definite and ascertained laws. Moreover, these factors are, so far as we can see to-day, clear-cut entities which the creature either has or has not. Its nature depends upon the nature of the factors which were in the two gametes that went to its making, and at the act of fertilization are decided, once for all, not only the attributes of the creature that is subsequently to develop, but also the nature and proportions of the gametes to which it itself must eventually give rise. That the nature of the environment influences the living thing is beyond doubt. Better soil, more moisture, more stimulating manure may sometimes effect a striking alteration in the habit of a plant. Better hygiene and education may largely influence the nature of a human being. But to the supposition that by such means a radical change can be brought about in the living organism the facts of heredity as we know them to-day certainly lend no countenance. Within limits the organism is plastic, and upon that plasticity alterations in the environment may play, producing changes within those limits. But there is no unequivocal evidence for supposing that those changes can be transmitted, or that a beneficent change brought about in the organism through altered circumstances can in any way alter the constitution of the germ-cells which that organism contains. It is true that strong, healthy plants generally produce better seed than those which are poorly nourished. But this is because the seed is really a larval form parasitic upon the mother plant. The parent plant not only produces the gametes from which the seed develops, but is for some time part of the environment of the developing seed; and it is in this capacity that the better nourishment of the parent is apt to lead to better formed and more vigorous seeds. Better nutrition of the mother plant has not affected the constitution of its gametes; it has only afforded a better chance to the developing embryo in the seed.

16. Another effect which must be carefully distinguished from that of heredity is that of *tradition*. Where the young of animals live for some time with their parents, they profit during early life by their parents' experience. There is little doubt that in this way modifications in behaviour may be gradually brought about, and the species become gradually adapted in certain respects to changed conditions. Rooks will avoid a man with a gun, though perhaps they have never been shot at. So also it is said that the behaviour of many wild animals differs according as they are in the presence of a white or a brown man. But of all animals the effect of tradition is strongest in man, where the intelligence and means of communication are most highly developed, and the young remain longest with their parents. Moreover, man alone has devised methods of storing up his experience. With each generation the store is added to, revised, and improved; and each generation comes into the world endowed, through the efforts of its forbears, with greater control over the conditions under which it has to live. This is sometimes spoken of as 'the inheritance which one generation receives from another.' The expression is in some respects misleading, for it cannot be too strongly emphasized that this passing on of accumulated tradition has nothing whatever to do with heredity in the strict biological sense. What may or may not be inherited is the brain capacity to take advantage of the accumulated

store of experience. Without such capacity the store becomes of no account.

In discussing questions involving evolution and progress in man, it is of the first importance to disentangle the effects of tradition from those of heredity proper. That heredity in man is of the same nature as in other animals and in plants there is no reason to doubt. Mendelian inheritance in its simplest form has already been demonstrated for a number of characters. These, it is true, are mostly of abnormal nature, because the student of genetics is at present largely dependent on the medical man for his data, and must deal with such characters as have been adequately investigated, whatever their nature. Among such characters may be mentioned congenital cataract, brachydactyls, *tylosis palmæ*, and others, while of so-called normal characters brown eye is dominant to blue; and, in certain cases at any rate, red hair is recessive to black. A peculiar feature in human heredity would appear to be the large number of characters showing sex-limited inheritance (cf. art. SEX). Though for the present man is too imperfectly known to be of much service in the elucidation of problems in heredity, there are yet two cases in the species of the highest interest, because the records in either case extend over several centuries. One of these is the well-known Hapsburg lip so characteristic of certain royal houses. The eminence of those affected has ensured a succession of portraits and documentary evidence, and there is little doubt that this character has behaved throughout as a simple Mendelian dominant over the normal form. To-day, after more than four centuries, it is as well marked as ever in the House of Spain. The other example is a case of night-blindness near Montpellier, which began to excite interest two centuries ago, and of which there exists to-day one of the most complete of human pedigrees, a pedigree numbering more than 2000 individuals and extending over ten generations. During all this time the affection has behaved as a simple dominant, and, like the Hapsburg lip, it has persisted in its full intensity in spite of continual crossing with the normal type.

17. Heredity is a new science, and its students are well aware of the magnitude of the labours in front of them. Yet enough is clear to force upon us the question whether our attitude towards many social problems is in accordance with facts. Many of those who to-day are anxious to reconstruct society lay it down as an axiom that men are all born potentially equal, and that the differences between them are due to differences in upbringing and opportunity. To this doctrine the biologist must offer an unqualified denial. The developing human body is no mere plastic thing which can be moulded by treatment to give it this or that desired character. Even from its earliest stages each embryo is endowed, by the germ-cells that made it, with a collection of factors which must inevitably develop in a given way. Hygiene and education are influences which can in some measure check the operation of one factor or encourage the operation of another. But that they can add a factor for a good quality or take away the factor for an evil one is utterly opposed to all that is known of the facts of heredity. Men are in some measure what circumstances have made them, but in far higher degree they are what they were born. Moreover, as regards parents, circumstances count for nothing in the inherent qualities of their offspring. Two things there are that go to mould society, of which the one is tradition that is handed on from one generation to another, ever changing and gathering as the generations flow, while the other is the genetic constitution of man—that collection of factors given him at his making, differing from in

dividual to individual, essentially independent of circumstances, inevitably passing on to posterity according to immutable and orderly law. Which of these two influences is the stronger there can be little question, nor can it be doubted that a social system based upon the inherent nature of man would have greater stability and a better chance of surviving than one resting upon religious or ethical tradition alone, however high the source whence that tradition sprang. The best type of social system is doubtless that combining the two, but the question of how far the one or the other is to predominate must be left for the future to decide. Before it can be settled, the inherent nature of man must be probed by deeper and more searching analysis. Cf., further, the following article.

LITERATURE.—The most important works are: W. Bateson, *Mendel's Principles of Heredity*, Cambridge, 1909 (contains a full bibliography and a translation of Mendel's original paper); E. Baur, *Einführung in die experimentelle Vererbungslehre*, Berlin, 1911 (contains a clear account of Nilsson-Ehle's researches); C. Darwin, *The Variation of Animals and Plants under Domestication*, London, 1869 (in vol. ii. will be found Darwin's statement of the theory of Pangenesis); L. Doncaster, *Heredity in the Light of Recent Research*, Cambridge, 1910; R. H. Lock, *Recent Progress in the Study of Variation, Heredity, and Evolution*, London, 1909; G. Mendel, 'Versuche über Pflanzen-Hybriden,' *Verh. Naturf. Ver. in Brünn*, vol. x., 1865 (Eng. tr. in Bateson); R. C. Punnett, *Mendelism*, London, 1911; H. de Vries, *Intracelluläre Pangenesis*, Jena, 1889 (Eng. tr. by C. S. Gager, Chicago, 1910), also *Die Mutationstheorie*, Leipzig, 1901-03 (Eng. tr. by Farmer and Darbishire, London, 1910); A. Weismann, *The Germ-Plasm*, tr. Parker and Rönnefeldt, London, 1893, *Essays upon Heredity and Kindred Subjects*, Eng. tr., Oxford, 1891-92.

R. C. PUNNETT.

HEREDITY (Ethics and Religion).—The purpose of this article is to select, from the great array of facts and considerations connected with heredity (cf. preceding art.), some which may prove of present importance to ethics and religion. Race penetrates the whole of life; it influences powerfully nations, families, individuals. It is a counterpoise or partial complement of that manifold environment whose influence was mainly regarded by Buckle and the great naturalistic historians. The known facts are not yet marshalled by a science which, though growing fast, is young; and recent more rapid increase of knowledge indicates that there is much more to know than we thought. Sometimes it seems almost certain that *race* is the most powerful force in history. At other times we are inclined to follow the writers who, like Bernard Shaw, think race unimportant and environment (climatic, political, social) all-controlling. Probably the relative importance of these factors varies in different parts of the field. There are races, like the Jewish, which by a more subtle elasticity rather than a greater stiffness remain unchanged in all lands. There are countries, like North America, which bring many races to a common appearance. But all that environment effects is effected in and by the responding power of an inherited organism.

Moreover, ideas about heredity touch morals and religion at many points. The wide range of these ideas—many of them familiar through all ages—is not yet viewed as a whole, and misconceptions are mixed with traditional and popular, and even with instructed and critical, opinion. The time, therefore, for definite conclusions has not yet come; but none the less some decided opinions and resolutions are possible and necessary. For the modern attention to heredity has produced a movement, and may produce results; and the results will be welcome or unwelcome to Christian moralists in so far as they foster or discourage responsibility, prudence, and unselfishness. But of these results the most important will be primarily in the sphere of thought, and will illustrate the truth that opinion may be

more effective than material fact, and a change of ideals of greater consequence to a race than a change of blood.

In view of the vigour and merit of the new movement, some opinions familiar to tradition and common sense acquire a new importance; and some decisions negative in form become positive for morals. Recognizing the great difficulty for thought in our subject, we recognize in it also a burden of sorrow, a difficulty for courage. If the problem of race is dark, the influence of race plainly includes menacing elements; and the facts of inheritance, like the rest of the world of force, put a strain upon the conviction of freedom from which there is no ready escape. That conviction must here, as everywhere, rest upon the experience or the contemplation of virtue; for the good will is the free will. The Christian student approaches that part of the frame of things which we call blood, believing in the freedom which morals require. His business is to take care that new knowledge may lead to a conception of duty at once more extended and more intense; never to the relaxation of moral effort either in self or in others; never to a lower appreciation of the value and power of ideals.

(1) *Distinctive elements in present thought.*—We have learned to look beyond the succession of individuals in a race to the changes of a race as such. Organisms change from age to age, and man as a species is changing; he can, it is alleged, control his own change. The general principles of transformism include him; the special machinery of natural selection is valid for his case; the methods of Mendelian inquiry ought to yield results in human life; the hopes of selective breeding should have a version about man and human society. The moral question about the science of heredity is, in fact, the question of the application to man of its conclusions and methods. Can we and may we use for man the investigations and the methods by which the process of improving subject-breeds is shortened through the application of a relatively certain knowledge of the sequences of variation and the exclusion of useless steps? We can do better with our sheep than by a crude elimination. May we not do better with man than leave him to 'chance'? This is the moral problem on the practical side. But behind it is a problem of knowledge. Do we know what is improvement for man? And, if we could secure this improvement, should we in the process lose something of the truly moral life, for the sake of which alone it is worth while that man, improved or unimproved, should survive? Is the knowledge that races change a ground for humility and for hope? Or is it a warrant for self-reliance and a new ambition?

And then, besides the social or political question, there is a question for the individual. Does our knowledge of the behaviour of race tend to rob a man of the conviction and the responsibilities of freedom? What scope is there in a fixed constitution for the action of that personal choice which on other grounds he has come to believe in?

(2) *Causes of the present interest.*—The existing interest in problems of heredity is (a) part of what at its highest is an interest in the 'Reign of Law,' and at its lowest an abandonment of the essential task of man in life and thought, in face of the mechanical conception of the universe. It is worth noting that all the interest of a materialistic sort exists in our society side by side with a great development of psychical studies, a belief in new continuous influences other than blood, and a greatly extended conception of the powers of personality. In this 'New Thought,' the patent facts of heredity are accounted for by re-incarnation. All this speculation, so remote from naturalism, has not in any way been co-ordinated with the

thought movements called scientific in the biological sense.

(b) In the second place, the interest is due to recoil from the exaggerated equalitarianism of the immediately preceding age. In that age, so practical and so sentimental, silk purses were to be made out of a variety of materials; and a sort of moral transformism expected the Ethiopian to change or not to need to change his skin. A just criticism of the quite imaginary superiority of some strains led to the conviction that all strains were alike in potentiality; and, when destroying a fictitious aristocracy of accident, Britain forgot that there might be a real aristocracy of health, brain, and disposition.

(c) A third cause is the reaction from an almost exclusive reliance upon the environment, physical, intellectual, and moral, which we thought we knew how, and had means, to improve indefinitely. This confidence has been destroyed, partly by the critical activity of thought, and partly by our too manifest failures in practice. The results confidently promised are not forthcoming. There is now a contrasted belief, equally dangerous when it is held exclusively, that the improvement of the environment (housing, health, air, education, training, travel) has been carried as far as possible; that the best has been done with and for the existing human material; and that for further improvement we must look not to nurture but to nature, not to education in its widest sense, but to selective breeding, by which we may get rid altogether of some mischievous features, and obtain progressively more of the best types and fewer of the worse. There is a recoil from an unreasonable reliance upon the environment alone. The value of influence is discredited, and men look to elimination instead.

(d) Fourthly—and this cause alone will be further examined—the movement in religious and popular educated thought has received its direction from the emphasis upon the subject in biology; and has been animated by the advances of biological knowledge and practice, sometimes well, but more frequently not very well, understood. In illustration of the last sentence it may be remembered that some educated persons still believe that heredity means (even exclusively) the direct inheritance of acquired characters—an occurrence denied by most biologists; or they set inherited qualities in contrast with 'innate' ones; or speak of 'cases of heredity' as if among the children of men there were some who escaped the operation of the influences of descent. All cases of human life are cases of heredity. And we may take it as certain that, at least in respect of the body, men are not born with any but inherited properties and powers. What seems and is original in a human physique is the original result of a mingling of inherited influences. Reference will be made again to the innumerable surprises of descent—the unlikeness between children and parents; the re-emergence of a remote ancestral type, recognized only in families of celebrity or enduring possessions; the incalculable appearance of genius in an ordinary stock—which are sometimes accepted as disproving the general truth of heredity. One of our interests is to escape from unbalanced studies, which exhibit the case of the Bachs or the case of the Jukes, to establish heredity as a sufficient explanation of human life; or reject it as unimportant on the evidence of genetically isolated genius and heroism—the prophetic art of Beethoven sprung of unmusical stock, the military power of men born of subject and unwarlike races. On the one hand, we must remember that what is uncalculated and uncalculable by our present means is not therefore in actual fact irregular; and, on the other, that, though race and circumstance are undoubtedly factors in the pro-

duction of a person, it does not follow that they are the only factors concerned.

If it is impossible to deny the place of nature, it is unwise to deny the force of nurture because the tremendous power of nature is recognized. Well-born must no doubt be well-bred if he is to take his place in succession to worthy forbears. But the breeding requires a fit nature for its subject; and there must be many different forms of good training, to fit the many varieties of good race. Moreover, for training, there must be—as a factor growing in importance with advance—the consent and co-operation of the subject. 'I have,' says the Countess, of the gentlewoman Helena,¹ 'those hopes of her good that her education promises; her dispositions she inherits, which makes fair gifts fairer; . . . she derives her honesty and achieves her goodness.'

It must be remembered, besides, as correction, that distinctions originated by racial difference are maintained by other causes when the racial difference has ceased to act. A county, a district, gets character from the race that inhabits it. Other races entering the region take by association a varying share of the regional character. In England, say (for we have not much certain knowledge), the ancient stock was first driven from the seaboard. The coast, and especially the East coast, was inhabited by Teutons—Saxons, Normans, Danes. At present there are dark-haired men of the older race in some coast-places. But they have acquired the social characteristics of the seafarers who once drove out their dark forefathers. Aristocracy still has some of the features of Norman society. The country gentleman still exhibits what is probably the Saxon type. And yet no blood-relationship is concerned here. The old Universities of Oxford and Cambridge—as has been shown or suggested by W. C. D. and C. D. Whetham—though now drawing almost equally from the same mixture of stocks, still exhibit divergent characteristics which in their origin may have been determined by the different races on which they respectively drew.

General reflexions of this sort are practically required before turning to some particular heads of discussion. The moral and religious problems will fall under the heads 'individual' and 'social'; and we must in each case consider the bearing both of speculative ethics and natural religion on the one hand, and on the other of the statements and precepts of Christianity considered as based upon an accepted revelation of truth and duty. These divisions must be related to existing biological knowledge in general, to Mendelian work in particular, and to the proposals as well as the propositions of Eugenic Reform.

1. The individual. — With respect to the individual, it will be convenient to ask first what we may think of him in view of the general doctrine of heredity, and then to examine the effect, upon our provisional conclusion, of Mendelian work.

(1) *General doctrine of heredity.* — Of Original Sin (see SIN) it is impossible here to say more than that, whatever was the change or failure indicated by that doctrine, it was not an acquired character in the sense of biology. What is indicated is a fall, or failure to rise, in the relation between the spirit of man and God. The doctrine itself is not a gratuitous accusation of the race of man. It is the utterance of optimism under pressure of the experience of moral paralysis and temporal suffering. Its positive equivalent is the statement that we cannot measure either the dignity of man's origin or the splendour of his destiny by his present position and his present moral accomplishment. A will better than the will he exhibits is the

¹ *All's Well that Ends Well*, Act I. Sc. I.

origin of his being, and a virtue beyond his own present power is the end of his calling. It is not the Christian who declares the misery of man. What all men acknowledge the Christian interprets as the eclipse of a dignity which, through the moral effort made possible by Divine gift, man is invited to regain.

It is now necessary to exhibit the influence of biological thought; and to inquire (a) what is its bearing for morals upon the question of the individual, his responsibility, and his opportunity; and (b) what is its bearing upon the control or influence of individuals in small or large groups, in the education of the child, the management of the family, the organizing of the nation, and so forth. Under both these heads it is desirable to distinguish between the *general* influence of the study of heredity and the *particular* influence or bearing of the Mendelian researches which constitute at present its most active and promising department. Finally, turning to practice, we must ask what is the effect and what are the credentials of the eugenic proposals with which quite lately we have become more or less clearly familiar.

In speaking of the *general* effect or influence of biology, we refer not to the carefully acquired generalizations of Pearson, or Galton, or the writers in *Biometrika*, but to the strong general impression left by these studies on the minds of thinking men—that the qualities of a man are, in some sense, certainly fixed by inheritance. His ultimate character, we all admit, is a function of at least two variables, disposition and circumstance; but his disposition, it is contended, is the result of inheritance and is fixed at his birth. Moreover, at his birth it is the result of facts in his ancestry. We can no longer suppose that, while the physical frame, the diathesis in respect of disease and health, and so forth, are fixed by inheritance, the mental qualities and the personal temperament are excluded from the influence of blood. At any rate for our purpose we are content to allow—what certainly has not yet been proved—that throughout his whole complex organization a man is, in a certain sense, the result of natural inheritance. He is born what he is. *Poeta nascitur*, but not less the man who cannot enjoy the poetry is *born* with that incapacity.

If we do not seek, then, to exclude from the range of hereditary influence any part of the complex constitution of man, what room can be found for the freedom that is required for morals? May not a man conclude that, his character being fixed by inheritance, he has no responsibility for its improvement or for his actions? A doubt of the reality of responsibility on such grounds may have practical bad consequences for a man or for a generation after the doubt has passed away. It is certain that moral effort is gravely hindered in some men by the suspicion of its uselessness, and that thus—through the channel of an idea—more hindrance to improvement comes than from unfavourable inheritance. There are subjects in which a theoretical mistake when corrected leaves the life undamaged; for the apparent waste of time in unprofitable reflexion may be actually necessary to the process of discovery. But, when the theoretic mistake refers to the very possibility of 'conduct' in the real sense, then the escape from error may leave a man with diminished power of self-control to correct an increased force of unfavourable habit. And the loss which may not appear in the individual will become evident in the generation or the society.

It must be noted, however, that it is not only an abstract determinism that is unfavourable to moral effort. There is also a thoughtless libertarianism which, regarding moral events as un-

caused and without result, pursues a bad course in the belief—if the great word may be used in such a connexion—that it may be retraced whenever the agent chooses. But, when we allow this, it must be said that the despondency and irresponsibility arising from the idea of racial determination are very real; and not less real in quarters where determinism as a philosophic system is unfamiliar and unexamined. What can be said in answer to these impressions or suspicions?

(i.) First, there is an *argument from ignorance* (reduced in force, as will be presently pointed out by Mendelian research), which may be stated thus. The facts of heredity are grave enough. The drawbacks of evil inheritance are real. But, in the first place, the exact state of a man through inheritance is unknown. Older thinkers, relying principally upon the male line, and reckoning that as indicated by the patronymic, relying also upon knowledge of nearer ancestors alone, thought that the hereditary predisposition might be easily known. *Fortes creantur fortibus et bonis*. 'Like father, like son.' But the modern conception of parenthood—and it is a true one—recognizes the two parents as equally important, and knows that there are as many males in the female as in the male line. The patronymical stock, therefore, may or may not be important. To the excuse of the father-beater in Aristotle, *συγγενὲς γὰρ ἡμῖν*, 'It runs in our family' (*Nic. Eth.* vii. 6, 1149b, 11), the answer would be, 'In which family?' The stock is almost infinitely mixed. The emergence of a given ancestral strain is incalculable. The immediate forbears and the more remote are but collaterally related to the descendant. It is the stock, the germ, that matters. Little of importance can be learned by the study of father and mother alone. If you have bad qualities by inheritance from bad ancestors, you have many good ones in the same entail; your great-great-grandfather, like almost every one's great-great-grandfather, was by modern standards intemperate; but his wife was by modern standards a recluse and an ascetic. You cannot tell which influence is strongest in you; at any rate the result is mixed. And since you cannot tell that you have not the most favourable inheritance, it is your duty to act as if you had, and not to run the risk of debasing, under the cloak of a bad strain which you do not possess, fine qualities which may actually be yours.

This argument from ignorance is at any rate inadequate to meet a reasoned determinism. It does not touch the facts, whatever they are. But the argument is strong forensically and practically. And, whatever the facts are, the duty indicated is plain. Fate may defeat the righteous man from without; it may defeat him from within. But his effort will still have been righteous; and, if we turn for a moment to the language of positive religion, we must add that the 'judgment' upon the man will not be determined by his achievement measured on an external standard without regard to heredity, any more than by such achievement measured without regard to circumstance.

(ii.) But further—and still in spite of what will presently be advanced as resulting from Mendelian work—the inherited qualities are certainly *too numerous all to find expression in a single life-history*. They are too numerous, and, besides, they are practically incompatible *inter se*. A man inherits capacities for a dozen different lines of life. One among these is realized by suitable training. The power of training is such that it appears at first sight to originate the whole character formed. We cannot doubt that it really effects what it does by acting upon an innate capacity. Nurture develops and 'brings out'

faculties which without nurture remain not only hidden but incomplete. But nurture can only develop what is there; and it draws out one or more of a multitude of capacities. And, if this is true of the broad and definite capacities which are required by certain modes of life and livelihood, it is also true of the very numerous and subtle capacities which are used or left unused in the cultivation of virtuous or evil character. For character is not the same thing as temperament. Character is both defined and realized by the manner in which a given temperament is managed in given circumstances. The vast excess of heritable qualities affords the field for such a choice. The relatively fixed external scene does not preclude a certain limited freedom of action, because the scene, though fixed, is greater than can be used or occupied by the life confronting it. Choice must be made. In the same way a relatively fixed internal constitution does not preclude a limited freedom of choice. For the possibilities are too numerous for realization. The potentialities cannot all find room on the narrow scene of one life-history. A man is capable of refinement and of bonhomie, of luxury and of self-denial. He cannot in the same life principally exhibit good-nature and principally exhibit an exclusive sensitiveness. He encourages one of the sets of qualities, and this partly by a direct fostering of them through thought and desire, guided by ideals; and partly, and in a more important degree, by carrying out, on account of the same ideals, the actions which are the natural outcome of these qualities and which nourish the qualities as the leaves of a plant nourish the root. The results of training in armies and various professions of men drawn from a stock fairly evenly mixed show both by the contrast of different professional types and by relative uniformity within a profession that life is the result of the development by action of one or other set of qualities out of many such sets present in the subjects of training. The contrasted set of qualities, left without expression or result, is inoperative for the man, and is quite possibly *pro tanto* atrophied for the stock; for the orthodox denial of the inheritance of acquired characters does not quite for certain apply to the specific case of starvation.

Again, besides the want of room—to use a figure—for all the inherited qualities in one life, there are some qualities that are mutually exclusive of one another. A man may be both extravagant and niggardly, both shy and boastful, both arrogant and servile, both rash and cowardly. But he cannot be both proud and humble, both predominantly devoted to self and predominantly forgetful of self. Many of those inheritances which are in our view not moral, but the raw materials of morals, are in their own nature ambiguous, and can be turned to virtue or to vice. Such are irascibility, caution, self-regard, the power of admiration. But even of these some are incompatible, in exercise and cultivation, with other qualities inherited by the same person. Life is the story not only of the management of circumstance but of the management also of these interior equipments. It is the abandonment of anti-impulsive management that constitutes moral failure. Moral failure is the failure to be moral.

Using once more at this point the language of positive religion, we may say that sinful action is not always action having any moral character in itself. Sleeping, eating, striking, speaking, are morally neutral; and their wrong occurrence is the result of impulse only. Sin in such cases, and probably in all, consists in the declining of free and moral action and lapsing into the un-moral plane where action is the resultant of impulses.

VOL. VI.—39

A suggestion may be useful of some inheritances which are markedly disadvantageous, but which are best known as such precisely by those men who, having them, are overcoming them.

(a) The inheritance of qualities which are in themselves distinctly unfavourable, such as the tendency to deceit or cowardice. These may be correlated with helpful qualities, but in themselves they appear unfavourable. There are some others which it is difficult to believe correlated with any compensative quality.

(b) The inheritance of qualities in themselves favourable in circumstances which render them practically unfavourable; for example, the inheritance by a courtier of an indifference to unpleasant contacts, which is useful to a person born in more primitive circumstances; the inheritance in humble life of what is roughly the aristocratic temperament—pride, fierceness, the rapid concentration of attention, the expectation of swift obedience. A most practical moral disadvantage is the inheritance of warrior blood or of pleasure-seeking tendencies in persons born to dependence. It may be seen on a large scale in South Africa, where whole nations inheriting magnificent qualities for primitive war are born into an alleged civilization under which the warrior temper leads a man to the indignities of a gaol; or a whole race, as at Thaba N'Chu, to disinheritance. The adventurous spirit which was once noble wears among subject races the squalid face of 'I.D.B.,'¹ evasion of taxes, or aggravated assault.

(c) The inheritance in combination of qualities all or some of which might separately be favourable. This is probably the commonest cause, if we take the physiological calculus, of all our moral defects; the discordance of impulses within, the discordance of a generous impulse with a saving impulse, of the parental impulse with the economic one. In fact, to take a large view, it might be said that of the moral difficulties of a nation, or indeed of man as a race, the largest single part arises from the discordance between the inherited impulses which make us men and the inherited prudential qualities which make some rich and others in consequence poor.

(d) Possibly also—and indeed experience seems to indicate it—there is in some cases a successive emergence in the course of one life-history of violently contrasted ancestral strains; so that, besides that conflict of impulses which at any one time occupies the conscience of the man, there may also be a *succession* of different types of prevailing impulse; and this results in the baffling of an acquired prudence, a destruction of what seemed a man's self-knowledge, and also in the disturbance of external conditions or social obligations which were fit for the earlier train of impulses, but unfit for the later.

Every one is familiar with the fact that what is undertaken in youth is not always easy to bear in old age, and that 'tasks in hours of insight willed' are only with extreme difficulty and many groans 'in days of gloom fulfilled.' But this does not adequately account for the difficulties which beset at least some individuals inheriting markedly diverse strains. A man who in youth and early manhood shares the prudent and industrious temperament of a Puritan ancestry seems to experience in middle life the sudden emergence of another set of relatives, hard-riding and money-scattering squires. It will be remembered, of course, in contrast with this, that such dislocated inheritance may be practically very favourable and act as a store of energy in societies which need explosions.

¹ Illicit diamond-buying, a crime of white men in which the native labourer is an accomplice.

Unfavourable conditions may in some cases practically eliminate a quality by refusing it sufficient expression—as the root is starved by the cutting off of the leaf. Sometimes, viz. when the quality is very robust, the conditions appear rather to concentrate energies which might have been exhausted had they received betimes their full exhibition. Thus, the influence of religious Puritanism spread so widely in the England of the 17th cent. as to cover with its sombre and austere habit of life much of the rough fighting blood of an older England, which, thus confined by the circumstances of what we now call the middle class, was released in the irresistible fierceness of the New Model Army.

The circumstances which thus strikingly alter the practical effect of an unchanged heredity may be local, national, economic, ethical, religious; depending on fashion, station, vocation.

Sometimes it seems very probable that half the surprises of public life and of private encounter arise from the introduction of rare or exotic elements of race into the familiar lines of society—a Lambton in Parliament; a Carlyle in Chelsea; the French descendants of Henri IV. through Charles II. found in the Whig aristocracy; the Cromwellian soldiers who are to this day boycotted as Catholic squires in Tipperary; Disraeli the Castilian, living in the circumstances of the lawyer son of a literary man. A man inheriting qualities unfavourable in themselves, in their combination, or their situation, nevertheless may, and often actually does, carefully avoid the occasions which give opportunity for their unfavourable effect; and they are weakened by the refusal of expression. And, though it would appear that he cannot hand down by blood to his son the improvement thus secured, and the son inherits by blood not the gain but the heirloom—not his father's acquisitions but a share of his father's patrimony—yet the father can and does leave to his son even by blood greater general strength, and he may leave, besides, better surroundings, and better ideals; thus he sets about his son the influences of a good man's home.

With some of these, indeed with all, the struggle may be lifelong. For the Christian this is a foreseen difficulty, for he has been led to put no trust in 'the flesh'; and to believe that high conduct must come not from the absence of difficulty there or from removing such difficulty, but in being delivered from the sphere of those influences. The consideration of these higher counsels does not belong to the present article. But it falls to us here to mention that the existence even of immeasurable difficulties in the blood ought not to daunt Christian thought any more than it defeats, however much it harasses, the Christian life.

(2) *Effect of Mendelian researches.*—The effect of these upon ethics is not so great as it is supposed to be in some quarters, but the impression made is prodigious and the legitimate effect is very considerable. In speaking of the impression one must confess that it has sometimes been exaggerated in the common conception of biology as well as in the common conception of morals. In respect of biology, non-naturalists believe that naturalists have deserted Darwin in a body, and have found in Mendelism a new theory of the origin of species. The real fact is that naturalists still, on the whole, follow the line that Darwin traced, but at present are engaged not in reconstructing the past history of species but in observing the present behaviour of hybrids.

With regard to morals and sociology, it is supposed that Mendelism itself is a new method of procedure, promising better results than religious conduct; or else that Mendelists have cleared up to a very large extent the facts of human inherit-

ance. These opinions are not shared by biologists. But the impressions made, first by regular results capable of tabulation, and secondly by the exhibition of a practical method of inquiry, are legitimately very great; and the actual acquisitions for anthropological thought are considerable. They can only be enumerated here.

(a) Mendelian research has reduced the force of the argument for practical freedom which was based on the fact of our ignorance—the argument in which we criticize the naive confidence or the naive despondency based upon the consideration of one line of ancestry alone, or upon the somatic life-history of immediate ancestors. This argument from ignorance retains great force, and it is certain that we have no such knowledge as can dissipate the obligation of effort for every individual. But the regular distribution through descent of such qualities as are Mendelian (that is, so unitary as to answer to the Mendelian analysis) certainly tends to a prospect of knowing one day much more of the order in which human qualities are reproduced in descent. Certain supposed laws of that reproduction had long been familiar. The repeated falsification of these laws tended to encourage those who had been daunted by their confident assertion. It was observed again and again that ancestral features, and even a complete assemblage of such features, reappeared in a family at intervals which defied all calculation and disconcerted all expectation. When the knowledge of the stock's history was small, as in ordinary private families, there was the appearance of total originality in the offspring—a strangeness of feature and temper which was only quite gratuitously traced to a forgotten ancestor; and the phenomena of a mixed race in this matter are so irregular that they appear subject to no law at all. It is certain that they really exhibit a law, which is perfectly strict and regular, if only we knew it; and the Mendelian short steps to discovery (taken within a short gamut of variation within a species) give hope of advance towards the finding of that law. To this extent the argument from total ignorance and from the impossibility of discovering the facts loses force—an argument which was practically effective for moral encouragement. For that ignorance depended upon the proposal of a law to which the exceptions were too numerous and too obvious to be ignored. Mendelian work has shown that the distribution of qualities is more complex than was supposed, and this gives promise of discerning a regular sequence in appearances which were formerly the most evidently incalculable.

In the interest aroused by the still recent re-discovery of Mendel the work of Weismann is partly forgotten. By his description of the continuous germ-plasm he showed that comparison with immediate forbears is an insufficient method for estimating the force of heredity in an individual, those forbears being in Weismannic thought collateral relations, like the leaf on a twig next above the leaf under consideration. The widening of our outlook in this matter and the more complex sequences shown by Mendelian study give a fresh hope of discovering regular sequences in inheritance, and so far lessen the appearance of physical originality in individual human lives. We have learned how a pure racial life may be found in some offspring of a mixed race; how some features may be completely eliminated by breeding; and how original heterozygotes may arise from the interbreeding of two contrasted varieties.

(b) Secondly, and more particularly, Mendelian research has upset the doctrine of the average or proportional representation of ancestral qualities in the offspring. This is perhaps the most important difference for ethics. Under the guidance of

Galton we looked for a quasi-mathematical representation of different stocks in a given descendant. A man whose great-grandmother was Swiss was eighth-part Swiss. We now know that the system of proportions within the individual does not hold; that, given a Mendelian human character, it ought, whether as dominant or recessive, to reappear uncombined in a certain proportion of the descendants of a stock. If virtue or any particular virtue could be conceived of as a Mendelian feature (which by reason of its complexity it cannot be), its non-appearance in a particular individual might be due to its recessive character. And, besides, we could no longer argue as confidently as before from the enormous excess of moral qualities inherited by every individual from his mixed ancestry. If we could distinguish the Mendelian units of a moral temperament, we might expect to find those displayed in the course of an ancestry to be manifested in an individual not in combination but pure, as a result of the process of sorting. But how far we are from such discoveries is plain when we remember the actual existence of great saintliness, great heroism, or great genius, as these appear in every variety of stock.

Major Leonard Darwin, in considering this question of the appearance of genius in the midst of families otherwise at a disadvantage physiologically, says with reference to the students of genetics:

'If you credit us with the power of being able to predict . . . sickly children, may we not also be credited with at least some power of prophesying the appearance of rare ability?'¹

The answer is in the negative. How perilous for practice may be such ill-founded expectation is illustrated when the same writer says:

'Surely segregation for life with kindly treatment must in the interests of posterity be the fate of all who both fall in life in consequence of some signal heritable defect and have no redeeming qualities to compensate for such a defect.'²

In our present state of information such language is no doubt used by a thoughtful man only in irony or challenge. But irony needs a trained audience. The subject is very serious, very delicate, and very new to the public. And it is better to say simply and directly with Punnett:

'Except in very few cases, our knowledge of heredity in man is at present far too slight and too uncertain to base legislation upon.'³

Who foresaw, and who would now foresee, with all the materials for judgment and with all the assistance of Mendelian observation, the emergence—to take no saint or hero—of Voltaire, 'si vif, si malingre, et si peu masculin'? To look at Houdon's bust in the Louvre is to recognize a mystery of personality which stands undiminished by the generalizations of science. Art, with its power to represent now and again a mixed effect of epoch, race, profession, and personality, corrects the narrow conception which rightly and, within its sphere, usefully arises from the rigid attitude and selective contemplation of science.

By Mendelian work, then, the argument from ignorance and the argument from excess of equipment are alike reduced in force. But virtue and vice are not allelomorphs, and the moral agent is not as such a heterozygote. The qualities which are the raw material of morals are not unitary in the Mendelian sense. And, in spite of the reducing process which is exhibited in Mendelian observation, and which possibly corresponds to a certain stage in karyokinesis, every man finds in himself a large excess range of possibilities; so that, even if the materials for morals are inherited as such, the life-history is the scene of an enforced exercise of a real selection, often carried out under the influence

¹ 'First Steps towards Eugenic Reform,' in *Eugenics Review*, Apr. 1912, p. 31.

² *ib.*

³ 'Genetics and Eugenics,' *ib.*, Oct. 1912, p. 133.

of ideals which found their first strength in people of another blood. Both 'blood' and circumstance closely condition the moral effort, but they do not determine it. A man cannot choose whether he will be a Teuton or a Slav. If he is born Arab, he cannot reach the excellence of the Celt, or the Celt his. But he can choose between being the best Arab he can be and the worst Arab he may be. A man cannot choose whether he will be trained at a Public School or not; but he chooses between doing there as well as he can or as badly as he dares.

Religiously, we should say that a man is called upon to make the best of inherited qualities as of circumstance. He can make the worst. To surrender to temptation is to decline to the plane of the natural impulses so that behaviour becomes the resultant of their contest. The life of grace is a life in which the will declines to re-enter the sphere of necessity and is capable of an anti-impulsive effort. And, if we use the language of dogma, we must say that a man will be judged not according to his moral accomplishment, measured on an external scale but according to the degree of his fidelity under conditions moral and material, external and internal.

2. Society.—From the case of the individual we turn to the case of influence exercised by man on man, by education, and government, in the family and larger groups. Here we shall discuss (1) the non-inheritance of acquired characters, and (2) eugenic proposals.

(1) *Non-inheritance of acquired characters.*—At first sight it seems that our judgment must be greatly affected by belief in the inheritance or non-inheritance of acquired characters. Something is still said on behalf of their inheritance on *a priori* grounds. Popular thought and the thought of practical breeders still affirm this inheritance. But we have to take account here of the biological denial of such inheritance or of its occurrence in a sufficient number of cases to affect the course of variation. The importance of this difference of opinion is not so great as it may appear, for there is certainly another nexus of moral and mental inheritance besides that of the blood. Tradition and the current of ideals, religion, education, public opinion—in one word, institutions—form a link between man and man and between generation and generation, by means of which the moral ideals of one are inherited by another; and here, more securely than in the germ-plasm, we can accept the analogy between memory and heredity which has been taught by Samuel Butler and by Dr. James Ward.¹ Those ideals may find their best opportunities in a given race, but they also pass from race to race. Formed in one racial soil, they may be carried on in another.

The results of character in different races seem to show that, while race remains a factor of real importance, the divergencies of society in mental standing are to be accounted for in the main by the differences of culture. When the stock is fairly mixed, as in Britain, the results of a given culture appear to an external observation startlingly regular and uniform. It is only when viewed from within, by a member of the cultured class, that the differences of race within the class appear important.

The other bond, the bond of ideals, is the one in which the acquisitions of culture are passed on. The task of education is the same whether or not there be any such inheritance in the physiological sense. If improvement can be passed on by blood, then we must improve each generation as far as we can; and we must equally do this if every generation starts with a clean sheet, uninfluenced by the

¹ James Ward, *Heredity and Memory*, Cambridge, 1913.

behaviour or the experience of ancestors. Weismann has shown, even in the case of musical ability, that it is capacity and not accomplishment which is handed on hereditarily.

The case for care in its wider sense remains unshaken—care for the progressive improvement of the environment, in such matters as food, water, air, housing, medicine; care for the elimination of disease; above and beyond all, for the securing of greater liberty, greater justice, more equal opportunity, less unequal rewards. And here it may be remarked that in a recent volume of *The Practitioner*, exhibiting very fully the present condition of the study of tuberculosis, hardly anything is said of inheritance. Physicians, and indeed physiologists like Starling, assert that the future of the race depends mainly upon our care of the rising generation.

(2) *Eugenic proposals.*—Two rival schemes are in existence for supplementing or even replacing the work which we may generalize under the names of education and influence.

(a) The first, which may be associated with the name of Archdall Reid, and which suggests affinities with the thought of Nietzsche, is that of giving free play to the forces of elimination so as to secure improvement by means analogous to those of natural selection. The consideration of this need not be expanded, for it is not at present prominent. All that need be said is that we have no security that the natural forces which are dangerous or inconvenient tend by their eliminating energy towards the survival of those human forms which are fittest to promote the essential aims of human life. To invite a man, for the sake of improving the race, to diminish the force of pity within himself by lessening the action dictated by pity, is like inviting a breeder of racehorses to seek their improvement by refusing to cultivate the character of swiftness. It is an attempt to improve the race of man at the cost of those elements of character, individual and social, for the sake of which alone it is worth while that the race of man should survive.

(b) In broad contrast with this is the movement of Eugenic Reform which is animated by the desire to find some method more merciful than that of the dog-breeder, who said in explanation of his success: 'I breed a great many, and I kill a great many.' The Eugenic Movement has for its base the idea that we have done our best with the existing human material; that the improvement of environment is no longer the hopeful path; that we cannot face the alternative of allowing the free play of any destructive forces; and that the line of improvement is to be found in getting better lives as the material for nurture—more of the best and less of the worst.

This movement is both educative and legislative, both restrictive and positive; and its different aspects engage the attention of different persons. From our point of view the merits of the movement differ in its different parts. Its educational work, supposing guidance can be relied upon, must be almost entirely good. But any efforts in the direction of legislation must be surrounded with peril. While education is safe and legislation at present dangerous, it must be remembered that the educators and the moderates give the opportunity of influence to the legislative and extremest elements of the movement. It is unsafe to suppose that this movement, because of its academic character, is practically unimportant. All revolutions are prepared in studies, and carried out by minorities. Majorities always suffer.

In order to reach the more difficult consideration that is part of our subject, the case of the feeble-minded may be briefly dismissed. The control of the really and permanently feeble-minded is morally

justifiable because they are not at present free. They lack the self-control which freedom requires, and they are also open to the mischievous control of other persons. There is a strong case for their segregation, if a safe judgment can be reached in defining their condition. But it is not certain that segregation must be by legal action. It would be best at the present stage to extend very largely the voluntary help that is being given to such persons, and to supplement it by public funds. And, if further steps must be taken, they must only be taken: (i.) not at the cost of a general extension in the community of suspicion and fear, especially in the more dependent classes; (ii.) not at the cost of human dignity as such; (iii.) not as an introduction to what are known as positive movements in the improvement of the race. If by a general improvement of the environment (in which we include a general rise in wages) a greater actual freedom was given to all classes, it is probable that in the majority of cases families would take due care of their own feeble-minded members. When the whole family is feeble-minded, a case for compulsion arises; and the legislation which met this case could be framed so as to meet also the case of criminal neglect by natural guardians. The weak point in all suggested legislation so far is that it is in effect a legislation providing for the poor to be controlled by the rich.

The point for calling a halt, even in cases concerning the feeble-minded, is reached when we come in sight of a lowering of public *morals* by action giving offence even to the ill-instructed conscience; and, if the conscience is ill-instructed, it is for the educational section of the Eugenic Movement to remedy this. When we turn to the positive reformer, the moral and practical difficulties which confront us are many and grave. The reformers would have to seek the cultivation of *different kinds* of excellence. A general or average improvement would destroy the work of society. If we have only sinewy men to drive the car, where shall we find the heavy man for navy work? Different breeds would have to be formed along widely different lines of specialization. This would check the interchange of life; for, if there were free interchange, the enterprise would be defeated by 'panmixia.' We should impair still further the social unity of the human race. Instead of nations differentiated by history we should have races, as in Wells's horrible dream of the Time Machine, differentiated for menacing work and helpless pleasure. Certainly all Christian effort should be in a direction diametrically opposed to this. Moreover, in eliminating this or that bad factor we know not what good one is correlated with it; and physiological correlation is not yet exploded by Mendelism.

Further, even if eugenic methods were certainly applicable to man, even if we could count on knowing what is good for him, and could shorten the process of evolution by avoiding unprofitable variation, yet every such application of method would carry with it a diminution of that unconscious or spontaneous element in life which has undoubtedly great gains attached to it. To marry for health—in itself a nobler enterprise than marrying for money—would even more directly militate against spontaneity, because the considerations involved come nearer to the heart of the matter. In a curious and interesting study of the higher forms of affection, von Hartmann shows that their action is not to be accounted for on mechanical or consciously rational grounds. They owe nothing to calculation of benefit, nothing to mechanical or physiological necessity. It seemed to von Hartmann that a cosmic reason, not apprehended by the personal mind, produced results which are in the true interests of the race and of the mass of

individuals. Whether this speculation be true or not, there can be no doubt of the loss to human life involved in anything which unnecessarily replaces uncalculating affection by calculations extraneous to the personal attraction. It may conceivably be necessary to make such a substitution. In any case it must carry this loss. And the interest of true progress seems to be in securing the good—supposed provisionally to be certainly recognizable and securely aimed at—by means which reduce as little as possible the spontaneous element.

Such means are found when definite encouragements and prohibitions are discarded, and we have instead some system that puts on good unions a small, hardly perceptible, but constantly repeated, premium. Is not such a system found precisely in a good social code which requires in all the cultivation of what is best; not avowedly for the sake of offspring, but for the sake of social life itself in its general aspects? Is it not precisely the better environment in its truest sense—better ideals, more liberty, more self-respect, more respect for every citizen—that secures more surely even those special ends to which eugenists recall us? And is not a particular part of this really good society, and the part that most surely reacts upon parenthood, the institution of marriage itself? Where marriage is rare, or late, or mercenary, or hindered by the prejudices of caste, fashion, display, there it is least likely to be real. Where the true nature of marriage is well taught and firmly believed in, where the rule of marriage is faithfully obeyed, there, in constantly increasing effect, it tends powerfully to set a premium upon the best lives.

It is probable that monogamy made its way by reason of its genetic worth, giving an advantage in the competition of races and nations to the monogamous. Christian marriage, if only it were entirely true to its definition, would give this advantage in a much higher measure. The business of exchange, in the proportion in which it is true to its definition, steadily produces a society of men marked by industry, honesty, mutual consideration. Christian marriage, true to its definition, requires high degrees of self-government, respect for the partner of marriage, respect for other marriages, industry, sacrifice for offspring. And the qualities thus fostered are in point of fact found to be correlated, on the whole and in the long run, not only with moral excellence of all sorts, but with the other human qualities coveted, including intellectual excellence.

For Christians, in this connexion as in all others, the task undoubtedly is to guard the ideal view of life against every advance of materialistic conceptions, and to preserve in activity the spiritual forces of life, against every application of methods which are, in a bad sense, mechanical. But the difficulty is to determine what conceptions are materialistic, and what methods mechanical in the bad sense; or, rather, what use of the methods which must in every human activity involve mechanical elements falls under the reproach of being unspiritual. It is easy to declare that, when once we admit that human life is to be improved from outside—either, as in older plans, by management, or, as is now proposed, by improving, directly and physiologically, 'the pig which makes the sty'—we abandon our own peculiar quest, in which has actually been found all former real advance. But such a statement cannot pass, as it stands, among Christians who are pledged, by the doctrine of the Incarnation, to the faith that it is the business of the spiritual forces, with respect to the material, to redeem the latter from fruitlessness, and make them serve the purpose of the spiritual adventure.

It has been said, again, that the ends which

eugenists set before them may be altogether moral, and that the most powerful advocacy of the movement is animated by motives the most honourable and unselfish; but that the method recommended is in its nature mechanical and, therefore, undesirable. And it might be added that the method is undesirable on two grounds; first, as being in itself mechanical, and, secondly, as being unlikely to enlist for long the services of those whose interests are distinctly idealistic; and that it must at least tend to put ideal and spiritual methods out of sight. But such a statement as this, again, will not bear the closer criticism of a Christian philosophy. Nearly all the methods of social reform involve a mechanical element; and Christians will be the last to admit that sanitation is unworthy of Christian effort because it involves the direction of water currents, or that the healing arts are less Christian because they lay under contribution the treasures of the mine and of the field.

How can we then better define the causes of the distrust which Christians certainly, and rightly, feel in the presence of the adventurous practical proposals connected with the study of heredity? We must say, in the first instance, that we are pledged to the protection of liberty. We have to declare that society has no moral right to invade personal liberty for the ends proposed. It has already been stated that, in the case of the feeble-minded, where such moral liberty is absent, or its slender vestiges endangered, the case is different. But we are pledged against all real invasion of personal liberty; and we have to guard against all disrespect for human nature, and all that tends to lessen the sense of responsibility even in those least richly endowed. Taking this as a basis, we add that the methods of instruction and persuasion are, in an indefinite degree, more removed from the peril of invading responsibility than are external or physiological methods. Let the duties connected with race be preached; let us endeavour to extend in that direction the range of a felt responsibility, in so far as this can be done without disturbing the invaluable, unconscious element of life. But let us not provide by external restraint for an advance which might be obtained by an appeal to the mind and to the spirit.

In the second place, we have to say that in all employment of the phenomenal it is the order that is of most consequence—the order in which the spiritual and the phenomenal forces are brought into play. If the material is used in consequence of an inward change of will, then the sacramental redemption of the phenomenal is in progress; but the case is otherwise when material means are employed for the purpose of saving the cost of a truly moral change. Moreover, in a state of society in which the spiritual ambitions are faint, and the spiritual forces neglected, every addition of mechanical method to our armoury must be watched with suspicion, and with the anxious question whether we have spiritual energy to afford the use of a new weapon. Now, in the case of heredity-reform, we have the proposal to apply a method which is in its nature physical, just where hitherto persuasion and influence alone have been supposed legitimate. And we have need of a much fuller supply of spiritual force and light in our society, before we can venture on such a change. Again, we have to ask ourselves many times whether the authority is available to which such powers can rightly be trusted.

A few days before this page was written a new Mental Deficiency Bill (55. 3, Geo. v.) was brought into Parliament, and with it a Bill (no. 60 of the same year) relating to the Education of Defective Children. A careful study of the measures shows that it is impossible in such an article as this

to express a reasoned judgment on their general effect. Controversy upon them has already begun, and will secure as it proceeds an examination of the actually possible results of the proposed laws in concrete cases.¹ On the one hand, urgency is pleaded by those who are convinced of the danger to the race of leaving defective persons in freedom; and who are sure that large powers of detention will always be prudently used. On the other hand, men not less well acquainted with the facts point to the danger of including under the compulsory powers children who are merely backward; and Sir James Crichton-Browne, one of the Visitors in Lunacy, says: 'The tendency seems to be at the present moment, in England at any rate, to concentrate attention far too exclusively on heredity as the cause of degeneracy, and to look to segregation too hopefully as the one sure means of its prevention.'

The opinion of Dr. Auden, the School Medical Officer for Birmingham, is also worthy of attention, especially in view of what Sir J. Crichton-Browne calls 'almost a scare' on the subject of feeble-mindedness. Dr. Auden says that of 159 children presented to him as mentally deficient, 64.8 per cent made such progress as to fit them for the ordinary schools; and adds: 'In view of the social disabilities likely to accrue to a child under this Act (*sic*), it is of the utmost importance to determine whether the intellectual retardation is temporary'; and he speaks of the difficulty of diagnosis (*Report for 1912 to the Birmingham Education Committee*, pp. 54-71).

To conclude, while it is with hesitation that Christians may oppose reforms which have much of good in their motive, they must present a direct and unhesitating resistance, even at the cost (could it be proved) of grave delays in physical improvement and immense national expense and suffering, to all methods which can be justly described as offending the instinct of reverence which has become natural to Christians, or as inconsistent with the method of salvation we have received to believe—a method which seeks good not by the forcible elimination of evil, but by the long road of a sacrifice in which the Highest is involved.

LITERATURE.—The literature directly concerned with this part of the subject is not extensive; while, from another point of view, there is hardly a production of genius which is not concerned in some part with problems of race and conduct, and the general range of biography and history may be read with special attention to those problems. The works of Weismann and the other biological works upon which the ethical study depends are given in the preceding article. A few are named here as specially interesting to the general student.

The *Journals of the American Breeders' Association*, Washington, 1904 ff., are a convenient means for acquaintance with the current of publications and researches.

Out of many handbooks on Genetics may be named: W. E. Castle, *Heredity in Relation to Evolution and Animal Breeding*, London and New York, 1912. A student of Ethics inclined to believe the biological work unimportant or inexact might look through one of the monographs of the Eugenics Laboratory, e.g. 'Hæmophilia,' by Bulloch and Fildes, London, 1911; H. E. Walter, *Genetics*, New York, 1918; W. Bateson, *The Methods and Scope of Genetics*, Cambridge, 1908; R. H. Lock, *Recent Progress in the Study of Variation, Heredity, and Evolution*, London, 1908. (This book treats (p. 187) of the application of Genetics to human affairs. 'Education and training, however beneficial they may be to individuals, have no material effect upon the stock itself.' Lock quotes Bernard Shaw (*Man and Superman*, p. xxiii) as saying first that 'the bubble of heredity has been pricked,' and then (with an obscure consistency), 'we must either breed political capacity or be ruined by democracy.')

Under the head of Eugenics, the following are important: *Heredity and Eugenics*, a course of lectures, etc., by Castle, Coulter, Davenport, East, and Tower, Chicago, 1912; two series edited by Karl Pearson, *Questions of the Day and of the Fray*, London, 1911 ff., and *Eugenics Laboratory Lectures*, do. 1909 ff.; *Problems in Eugenics*, papers communicated to the First International Eugenics Congress, held in London, July 24-30, 1912, published by the Eugenics Education Society, London,

¹ The first of these two measures (the Mental Deficiency Bill) has become an Act; and the operation of the Law as now provisionally defined is expected with very general confidence and approval.

1912; W. C. D. and C. D. Whetham, *Heredity and Society*, do. 1912, also *The Family and the Nation: A Study in Natural Inheritance and Social Responsibility*, do. 1909, and *An Introduction to Eugenics*, do. 1912; E. Schuster, *Eugenics*, do. 1913. Dr. Archdall Reid's books illustrate a different view: *Alcoholism: A Study in Heredity*, London, 1901, and *The Principles of Heredity with some Applications*, do. 1906. The thought of Sir Francis Galton, the founder of Eugenics, may be studied in his *Natural Inheritance*, London, 1889, *Hereditary Genius*, new ed., do. 1892, and *The Possible Improvement of the Human Breed under the Existing Conditions of Law and Sentiment* (Huxley Lect. 1901). C. W. Saleeby, *Parenthood and Race Culture*, London, 1909, should also be consulted. For criticism of the extreme Genetical view of mental infirmity the following publications are useful: J. Crichton-Browne, 'Child Study and School Hygiene,' in *The Child*, iii. (1912) no. 2, p. 113; and B. Hart, *The Psychology of Insanity*, Cambridge, 1912, p. 170 ff. (Speaking of the hypothesis that a vast group of insanities is founded on a repression of herd instinct, Hart says that the 'tendency to dissociation' may be an inherent factor and capable of elimination by selective breeding; but adds: 'It is equally possible . . . that the fault is not in the tendency to dissociation, but in the nature of the conflict which has produced it. The only remedy would then lie in altering one or other of the antagonists so that incompatibilities no longer existed' (p. 171)).

References to other papers in the Medical Press and elsewhere will be found in *School Hygiene*, ed. M. D. Eder and R. Elmslie, London, 1910 ff. The full synthesis of biological considerations with the principles of ethics and society, though briefly treated in books of a more general scope, has still to be attempted. Three books by Dr. F. R. Tennant, although theologically open to criticism, are of high value for the disentanglement of the idea of sin from the associated idea of ethical imperfection: *The Origin and Propagation of Sin* (Hulsean Lectures, 1901-02), Cambridge, 1902, new ed. 1906, *The Sources of the Doctrines of the Fall and Original Sin*, do. 1903, and *The Concept of Sin*, do. 1912. *Heredity and Memory*, by James Ward, Cambridge, 1913, is also an important book.

P. N. WAGGETT.

HERESIES AND HERETICS.—See SECTS AND HERESIES.

HERESY (Christian).—I. DEFINITION AND USAGE.—The term 'heresy' is an English transliteration of the Gr. *aipeia*, which meant an act of choosing, choice or attachment, then a course of action or thought, and finally denoted a philosophical principle or principles or those who professed them, i.e. a school or sect.¹ In the LXX (Gn 49², Lv 22^{18, 21}, Neh 12⁴⁰, 1 Mac 8³⁰) it relates to choices good or bad. In Josephus² it means a party or sect, without disparagement. It has a similar force in Acts (5¹⁷ 15⁵ 26⁵), except, perhaps, 24^{5, 14}. Elsewhere in the NT it is used in a condemnatory sense, as party-ism (1 Co 11¹⁹, Gal 5²⁰, 2 P 2¹; see Tit 3¹⁰, and cf. 1 Co 1¹⁰ 11¹⁶ 12²⁵, Ro 16¹⁷). Among the Apostolic Fathers it occurs first in Ignatius.³ He reckons it alien to Christianity because it violates the unity of the Church. Justin⁴ calls the heretics 'godless,' 'impious,' 'blasphemous,' etc. Notwithstanding the milder view of Origen,⁵ Irenæus,⁶ and Tertullian,⁷ it refers to a doctrine or system that falsely claims the Christian name but perverts the traditional teaching. The late origin of heresy is held to be evidence of its spirit of self-will. As late as Hippolytus⁸ it was used even of doctrines of pre-Christian times that contradicted the Christian faith. But its connotation became narrowed by controversy, and its evil character was finally fixed in the struggle with Arianism. Its meaning for Catholicism⁹ is a doctrine that is maintained within the Church but is disruptive of its unity. It is more serious than schism, since, while the latter refers to ecclesiastical cleavage, the former refers to spiritual alienation.

The growth of the idea of heresy is parallel with the development of the view that the Church is the Divine institute of salvation and depository of

¹ E. Preuschen, *HWB zum NT*, Giessen, 1910, s.v.; Cremer *Bib.-Theol. Wörterbuch d. NT*, Gotha, 1872, s.v.

² *BJ* ii. viii. 2.

³ *Dial. c. Tryph.* 35, 80.

⁴ *adv. Hær.*, Proem. 1-7, i. 10. 1-3.

⁵ *Præsc. adv. Hær.* ii.-vi., de Bapt. 15.

⁶ *Refut. omn. Hær.* i.

⁷ Lactantius, *Div. Inst.* iv. 30; *Const. sanc. apost.* vi. 2, 4

Thomas Aquinas, *Summa*, ii. ii. qu. 11, art. 1; Harnack, *Dogmengesch.* i. 386 f.

saving truth.¹ In the long struggle to preserve the distinctive character of the Christian faith the emphasis fell on doctrine, and it became necessary to the Church's existence that there should be a duly accredited channel of the tradition. The claim of Apostolic succession in the episcopate and the creed were the outcome. When Constantine gave the Church Imperial standing, the bitterness of the contest was vastly increased. Heresy became criminal. In the reign of Theodosius II. (382) it was made a capital offence. The effect is seen to this day in the common dread of the epithet even among Protestants.

II. SKETCH OF THE HISTORY OF HERESY.—I. Its rise in Apostolic times.²—Almost from the very beginning of the Christian faith divergences of belief arose. These were more serious than the temporary partyism that sprang from attachment to favourite leaders (1 Co 1¹²). They represent real differences in the point of view from which the new faith was apprehended. Some of the ancient writers³ place Jewish sects and Greek schools among Christian heresies. This error points to the fact that the dangers of division arose mainly from influences emanating from these two quarters. Many of the early converts found difficulty in detaching themselves from their inherited Judaism,⁴ while Græco-Roman converts naturally clung to the ideas connected with those religious aspirations which had found fulfilment in the Christian message. Thus, while Judaism threatened to re-absorb Christianity and obliterate its distinctiveness by requiring conformity with its legal and ceremonial forms and by interpreting its richer religious spirit in the terms of an abstract monotheism, the Greek spirit threatened to engulf the faith in a speculative philosophy. From the outset Jesus Himself was the theme of central interest. The conservative, unprogressive Jewish believers would have made Him a mere man; the speculative Greek would have made Him no man in reality but a God. The former tendency produced the party later known as Ebionites, the latter the so-called Docetæ who held that Jesus' manhood was only seeming. Ebionism (*q.v.*) is the antecedent of the later non-speculative Adoptianism (*q.v.*). Docetism (*q.v.*) appears in varying forms in all mystical speculative Christology.

It is the second of these that chiefly alarms the NT writers.⁵ The danger was increased through the combination of Oriental forms of imagery with Greek Christian thought. The attractive profession of a secret knowledge of the unseen world tended to connect Christ (distinguished from Jesus) with a hierarchy of heavenly beings, and make Him a cosmic force, and thus to introduce a cultus with secret mystic rites and their associated moral results of asceticism or licence.⁶ Naturally, there was also the denial of the early Christian eschatology,⁷ especially the physical resurrection. The struggle with this movement called forth a considerable portion of the NT writings. There appears to have been no organization holding these views. Like the later Gnosticism, of which this was the beginning⁸ in Christianity, it represents merely a tendency. The Nicolaitans⁹ are the only party named in the NT. They are charged with anti-

¹ Cyprian, *de Unit. Eccles.* 8; August. *Ep.* 185, *ad Bonif.* iii. 1, 2.

² See E. Burton, *Heresies of the Apostolic Age*, Oxford, 1829; works on the Apostolic Age by J. B. Lightfoot (London, 1892), A. C. McGiffert (Edinburgh, 1897), P. Wernle (Eng. tr., London, 1903-04), C. v. Weizsäcker (Eng. tr., do. 1897), O. Pfleiderer (do. 1906-11), E. v. Dobschütz (do. 1909).

³ As Hippol. *Refut.* i.-v.

⁴ Cf. *Epp.* to Gal. and Hebrews. ⁵ 1 Jn 11-3 218a. 42-6.

⁶ Col 2⁸ 16-23; cf. 115-23 215, Eph 119-25 39. 10 414.

⁷ 1 Co 1512a, 2 Th 2¹⁷ 18.

⁸ Jewish elements may have been mixed with it (see J. Moffatt, *Introd. to Lit. of NT*, Edinburgh, 1911, p. 152).

⁹ Rev 2¹⁸.

Judaism and loose morals. A guess of later writers¹ traces them to the deacon Nicolas² at Antioch. It is evident that before the end of the 1st cent. the speculative movement that produced the great Nicene controversies had already begun.

2. Heresies of the Nicene Age.—i. ANTE-NICENE HERESY.³—(a) *Gnosticism*.—The greater part of the Christian literature of the 2nd and 3rd centuries arose out of the effort to preserve the early Christian traditions in the face of philosophic and fantastic attempts to combine them with Greek speculation and Oriental mythology. The long lists of heretics given by the Church writers represent in many instances only variants of a common type. The term 'Gnosticism' may be allowed to stand for the whole movement that threatened the unity of the Church. For Gnosticism is not the name of a separate body of people or system of doctrines, but rather a trend of thought and practice. Attempted classifications of the phenomena of Gnosticism are unsatisfactory. They are too variegated and complex. Syncretism in religion was a characteristic of the times. The advent of the Christian faith gave fresh inspiration to the hope of attaining to a final and perfect knowledge of all being. Christianity came as faith (*pistis*); it must be elevated into knowledge (*gnosis*). The prevailing Neo-Platonism of Alexandria, shot through with Oriental imagery, was the instrument for the accomplishment of this task. See, further, art. GNOSTICISM.

(b) *Origenism*.—By way of reaction a Christian Gnosticism appeared. Its centre was the catechetical school at Alexandria founded by Pantænus. Here Philo the Jew had taught his Christian successors how to marry Hebrew tradition to Platonic philosophy by means of allegorism; and Clement, by a series of speculations supported by the fiction of a secret Apostolic tradition, and Origen,⁴ in a systematic way, built up a body of greatly reduced and simplified Gnostic doctrines that mostly passed for Christian. It was able to do so by maintaining the appearance of preserving the Scriptures, the common traditions, and the Rule of Faith. We are here concerned only with those features of Origenic speculation on account of which he was later regarded as a heretic.⁵ First, in his attempt to identify the Logos with the Son of God without compromising the unity and supremacy of God or denying the reality of the sonship, he postulated the real generation, in eternity, of the Son from the essence or nature of the Father. While this set the Son within the Godhead, it subordinated Him to the Father. From the standpoint of a later orthodoxy the latter was heresy. Second, in accordance with his scheme of the origin of all things from the highest being and its return thither, he seemed⁶ to affirm the ultimate restoration of all, even of devils, to God. This too became heresy. Inasmuch, however, as Origen's speculations became the source of the later doctrines of the Trinity and the two natures of Christ, we can say that the Gnostic heresy reproduced in Origen prepared the way for orthodoxy. See, further, Origen in art. ALEXANDRIAN THEOLOGY.

¹ Irenæus, *adv. Hæc.* i. 26. 3; Tert. *adv. Hæc.* i., *Apol.* ii. 6. Hippol. *Refut.* vii. 26; cf. Clement Alex. *Strom.* iii. 4.

² Ac 6⁵.

³ See the works of Justin, Irenæus, Hippolytus, and Tertullian above referred to; also H. L. Mansel, *The Gnostic Heresies*, London, 1876; O. W. King, *The Gnostics and their Remains*, New York, 1887; F. O. Baur, *Die christliche Gnosis*, Tübingen, 1835; R. Liechtenhan, *Die Offenbarung im Gnosticismus*, Göttingen, 1901; W. Bousset, *Hauptprobleme der Gnosis*, do. 1907; C. Bigg, *The Christian Platonists of Alexandria*, Oxford, 1886; E. Hatch, *Influences of Greek Ideas and Usages* (HL, 1888), London, 1890.

⁴ See their works in PG viii., ix., xi.-xvii.

⁵ See summary account of the controversy over Origen in Bigg, *op. cit.* 277-283.

⁶ Note Bigg's expression of doubt, *op. cit.* 235.

(c) *Marcionism*.—A powerful reaction against the prevailing tendency of speculation was headed by a merchant named Marcion, who came from Pontus to Rome about A.D. 140 and propagated an anti-Jewish, apparently Pauline, ascetic form of Christianity, with such success that there sprang up hundreds of churches which maintained his views.¹ Holding that the Gospel was the revelation of the God of grace in Christ—the good God in contrast with the Jewish God of righteousness and vengeance—and carrying the Pauline antithesis of law and grace to the end, he denied that Jahweh could be identified with the God of love who suddenly revealed Himself when Jesus came to Capernaum. Hence the world created by the Jewish God was evil, and the true Christian life was the ascetical. Marriage was forbidden in his churches. In accordance with these views he framed a canon of Christian Scriptures that included, along with only ten genuinely Pauline Epistles, Luke's Gospel and Acts with the Jewish portions expurgated. Marcion's identification of Jesus with the good God gave an impulse to orthodoxy to place Him on an equality with God, and his canon of new scriptures gave an impulse to the delimitation of a true canon. Marcionism was inevitably repudiated because of its two Gods and its rejection of the OT,² but its moral vigour was great enough to perpetuate its churches in Italy, Egypt, Palestine, Arabia, Syria, and elsewhere, for a long time. See, further, art. MARCIONISM.

(d) *Monarchianism*.—Other reactions³ against speculation took the opposite direction of a return towards the simple early Christian view of Jesus and a rationalistic Judaism. As time passed, it was powerfully supported by the critico-historical school of exegesis which grew up at Antioch in opposition to the speculative, allegorizing school of Alexandria. Monarchianism and Montanism are the principal forms of this reaction. Monarchianism may be contrasted with what we may now call Catholicism by saying that in it the *intellectual and moral interest of guarding the monotheistic government of the universe* prevailed over that emotional-religious interest of guaranteeing the finality and perfection of salvation which became the motive of Catholic theology. Hence they fell apart in their views of Jesus Christ. Monarchianism (*q.v.*) emphasized the reality of the events of His human life (though at times tending to Docetism), yet sought to preserve the high place assigned to Him by faith, without yielding to the prevailing tendency to polytheism. Its Christology was either Adoptianist, that is: Jesus was a man elevated to Divine sonship for His obedience; or Pneumatic, *i.e.*, Jesus Christ was more than a mere man in that He was indwelt by the pre-existent Divine Spirit and thereby empowered to save. The former perpetuated Ebionism, while the latter tended toward the prevalent speculative trend. The so-called Alogi⁴ of Asia Minor, appearing about 170, are the principal of these later Adoptianists. They opposed Montanism, were interested in Jesus' human life, repudiated the Logos speculation, and, possibly for this reason, rejected the Johannine authorship of the Fourth Gospel which they ascribed to the Gnostic Cerinthus. Paul of Samosata represented a high type of Adoptianism at a later date. See, further, art. ADOPTIANISM.

The pneumatic Christology branched in two directions according as it excluded Christ from

participation in Deity or not—the modalistic and the dynamistic Christology. The death of Christ was a great difficulty for both. The Dynamists were forced to separate Him from God in His death, while the Modalists identified Him with God, and received from Tertullian¹ the nickname of Patripassianists. See, further, artt. MONARCHIANISM and SABELLIANISM.

(e) *Montanism*.—The Kataphrygian, or Montanist, heresy, which is the second principal reaction against the speculative tendency, got its name from Montanus, a Christian prophet of Phrygia. This man sought (*c.* A.D. 156) to combine the Phrygian tendency to frenzy or ecstasy with the inspirationism, simplicity, and non-worldly morality of the early Church, and, at the same time, to announce the fulfilment of the promise of the Paraclete (in himself, it was charged),² the imminence of Christ's return, and the near establishment of the Kingdom at Pepuza in Phrygia. All who received the Spirit were to be prophets; they were 'perfect,' able henceforth to live sinlessly, and would follow the ascetic life. Marriage was forbidden. Yet, recognizing the impracticability of his ideals for some, he allowed a lower grade of believers, and acknowledged two grades of sin—mortal and venial.

Montanism (*q.v.*) was doubtless highly moral and spiritual in aim. It sought to correct the prevailing laxity by denying a second repentance, and the prevalent formalism by substituting for ecclesiastical or episcopal authority the authority of immediate inspiration. The conversion of Tertullian, late in life, to Montanism is an evidence of its great moral power. The movement made great headway, and only after long controversy, lasting into the 5th cent., was it pronounced³—with hesitancy and misgiving—heresy. By its rejection the churchly trend was strengthened, the episcopal power confirmed, and the formation of the canon hastened; but, in order to win, Catholicism had to adopt its idea of two classes of Christians and two grades of sins.

There are two other forms of ancient heresy that stand somewhat apart from all the types mentioned above—Paulicianism and Manichæism.

(f) *Paulicianism*.—Paul of Samosata,⁴ bp. of Antioch and high dignitary at the court of Zenobia, Queen of Palmyra, combined Adoptianism and Origenism with an anti-metaphysical view of the relation of Christ to God. Christ, born of a virgin, and inspired by the impersonal Logos, bore a personal, moral relation to God. The perfect unity of His will with God's in His earthly life of obedience became indissoluble. At the Resurrection He was raised to eternal Divine dignity. Though Paul was condemned at a synod at Antioch in 268 or 269, his views, upheld for a time by Lucian the martyr (who recanted), never died out. Disciples were numerous in Persia and Armenia. Immigrants from Armenia carried his doctrines into Thrace and Bulgaria, where under the name of Paulicians (*q.v.*) they became a root of the great mediæval revolt against the Roman Church. In Spain during the 8th cent. their views produced a tremendous controversy, in which the famous Alcuin took part. There is reason to believe that sects holding their doctrines persisted to the Reformation. 'The Key of Truth,'⁵ discovered in recent times among the Armenians at Thonrak, attests their evangelical character mixed with asceticism.

¹ The strength of Marcionism is shown in Tertullian's elaborate refutation in a work of five books—*adv. Marcionem*. Note Harnack's high estimate of Marcion (*Dogmengesch.* i. 268 ff.).

² Apelles, his greatest follower, tended to Monarchianism (Euseb. *HE* v. 13. 2-7).

³ Harnack, *Dogmengesch.* i. 648-754.

⁴ Epiph. *Hær.* ii.; Iren. *adv. Hær.* iii. 11. 9 (7); Harnack, i. 660 ff. and footnotes.

¹ *Adv. Praz.* 10.

² Didymus Alex. *de Trin.* iii. 41; Epiph. *Hær.* xlix. 1.

³ Mansi, *Concil.* i. 723; C. J. v. Hefele, *Conciliengesch.*, Freiburg i. B., 1873-79, i. 84.

⁴ See Epiph. *Hær.* lxxv.; Euseb. *HE* vii. 80. 11, 19; Leontius, in *PG* lxxxvi. 1392, 1393.

⁵ See the text, translation, and historical account of the Paulicians, in *The Key of Truth*, ed. F. C. Conybeare, Oxford, 1898.

(g) *Manichæism*.—It is said that a certain Mesopotamian named Mani, a traveller in many lands, reached the Persian capital in the year 245 and forthwith began the propaganda of a new faith. His success was so great that he won the royal favour; but through the opposition of the Magi lost it in the reign of a later king, and was crucified in 279. His doctrines were too deeply rooted to perish, and spread rapidly. They won many followers in Italy and N. Africa (the great Augustine was for a time one of them), and ultimately developed, through the Cathari of France, Spain, and neighbouring lands, a powerful anti-Roman religious organization in alliance with a culture that promised for a time to anticipate the Renaissance and the Reformation.

At first sight, Manichæism appears as revived Gnosticism. It united to a Christian terminology a combination of Jewish, Babylonian, Zoroastrian, and Buddhist religious beliefs and cosmological speculations. It recognized two grades of adherents—*auditors*, and *elect* or *perfect*. It offered a fantastic cosmogony, a theory of cosmic redemption, and a dualistic morality. In the last particular it went further than Neo-Platonism, since it affirmed the reality and eternity of evil matter. The physical and ethical are at bottom one. The two kingdoms of Light and Darkness, ruled respectively by Satan and God, include all things and are in conflict. God creates Primeval Man (not the earthly human being) to resist Satan, but he is defeated. Though rescued by God and the angels, he has lost meanwhile some particles of light. By the mixture of these with the darkness the present evil world comes into being. The demons now create man (proper), seeking thereby to imprison and preserve a portion of the light. But God provided a means of redemption by creating a system of heavenly bodies—sun, moon, and stars—to attract the particles of light and become reservoirs of it till the redemption is complete. Jesus—not the historical—and the elect assist men. The process goes on even after death (purgatory). At the end of the world the unredeemed souls fall to the prince of darkness.

The moral earnestness underlying this imposing philosophy, its strict asceticism—marriage, lust, impure talk, animal food, and physical violence were equally forbidden—and a simple cultus were attractive to many noble souls. It was weakened by a doctrine of indulgences. The influence of Manichæism is probably found in the Euchites, Enthusiasts, Bogomils (*qq.v.*), Beghards, etc., of mediæval times.¹ See, further, art. MANICHÆISM.

ii. NICENE AND POST-NICENE HERESY.—(a) *Arianism*.²—The long battle between Monarchianism, the Antiochene historico-critical school of interpretation, and rationalism, on the one side, and Catholicism, with its realistic view of salvation, its allegorical interpretation, and its metaphysic of deity, on the other side, came to a head in the bitter conflict between the Arians and Athanasians at the Council of Nice (325). The prize to be won was not only the vindication of an interpretation of Christianity, but the Imperial support. Arius gave his name to the defeated party. Athanasius (*q.v.*) became the apologist of the Council's decision.

The immediate occasion of the conflict was the affirmation, by Bp. Alexander³ of Alexandria, that

¹ For an account of Manichæism, see the seven books of Augustine, *contra Manichæos*, translated into English with introductory essay in 'Nicene and Post-Nicene Fathers,' 2nd series, by A. H. Newman, and the extensive bibliography there given.

² See art. ARIANISM in vol. i. pp. 775-786. For an elaborate, though prejudiced, account of early Arianism, see John Henry Newman, *The Arians of the Fourth Century*, Oxford, 1871. The literature on the subject is very extensive.

³ See PG xviii. 563-568.

the pre-existent Son of God had a separate hypostasis (*ὑπόστασις*), and that the sonship was by the very nature of God, and not by His will. Arius, one of his presbyters, controverted this position, and urged that *ingenerateness* constituted the essence (*οὐσία*) of the Father alone, and *generatedness* the essence of the Son, since He was truly son. This is to say that He, like all things, came from the non-existent by the creative will of the Father, and in order to the creation of the world. There was (a time) when He was not. He was God—but by impartation; only-begotten God, the Logos. Christ had a human body, but the place of the human soul was taken by the Logos. The issue¹ was whether the Son was *homoousios* (*ὁμοούσιος*=of the same nature) with the Father. A compromise term (*ὁμοιούσιος*=of similar nature), offered by the mediating Eusebians, having been rejected, and the support of Constantine having been secured, the Council anathematized Arianism as heresy. The Council went so far as to posit in the Godhead three hypostases²—Father, Son, and Holy Spirit. Christ was thus definitely transferred from the side of man to the side of God.

The controversy was not hereby settled. Not only did victory alternate for a time as the two parties strove for the political mastery, not only did the Arian view reappear in the violent controversies that rent the Eastern Church for three centuries and left it a prey to Muhammadanism, but Arianism, carried to the nations of the Goths by Ulphilas, became the faith of many German tribes. Under the Gothic rule in Italy it became the dominant faith there, and its final political overthrow in Europe was accomplished only by the Papal alliance with the Franks and the conquest of the non-Catholics. Even so, it was not extinguished, but has had its defenders down to modern times in England.

The decision at Nice, so far from settling the Arian controversy, provoked fresh controversy,³ and raised up new bodies of heretics. The numerous deniers of the *homoousios*, under the leadership of such men as Ætius, Asterius, and Eunomius, bore the general name of Anomeans. But the most noted was Apollinaris,⁴ bp. of Laodicea.

(b) *Apollinarism*.—At first a defender of the Nicene doctrine, Apollinaris began to recoil from the common use by the Athanasians of the term *Theotokos* ('Mother of God') to describe Mary, and also from the danger of positing in Christ two persons, a human person and a Divine. Attracted by the suggestions of Gregory of Nazianzen,⁵ that the human and Divine were mingled, and of Gregory of Nyssa,⁶ that the human lost its distinctive qualities by absorption in the Divine, he sought to escape the dualism of person and will by affirming that in Christ the Logos took the place of the rational soul or spirit, and that His animal soul and body were alone human. This implicit denial of the metaphysical redemption was condemned at an Alexandrian synod⁷ in 362, and more formally at the first Council of Constantinople⁸ in 381. See, further, art. APOLLINARISM.

(c) *Nestorianism*.—The vindication of Christ's perfect manhood by the Antiochene theologians, such as Diodorus of Tarsus, Theodore of Mopsuestia, and the great Theodoret, aroused Nestorius, bp. of Constantinople (428), to protest

¹ *Ep. ad Euseb. Nic.*, in Eplph. *Hær.* lxx. 6, ad *Alex.*, 6. 7; Theodoret, *Hist.* i. 4-6; Socrates, *HB* i. 6; Athan. in *Ar* i. 5, de *Syn.* 15, 16; Hilar. de *Trin.* iv. 12, vi. 5.

² P. Schaff, *Creeeds of Christendom*, New York, 1890, II. 60.

³ See Harnack, *Dogmengesch.* II. 230-400, for details.

⁴ Athan. c. *Apoll.* i. 2, in *PG* xxvi. 1000.

⁵ *Orat.* xxxviii. 13, xxxvii. 2; *Ep. cl.* (*PG* xxxvii. 1801.).

⁶ c. *Eunom.* 6.

⁷ Mansi, III. 461.

⁸ Schaff, II. 67.

against the growing Mariolatry. He contended¹ that, since there could be no transfer of human attributes to the Divine Logos, the Divine and human substances co-existed and co-operated in Christ, but were not made one, nor were their attributes mutually shared. Mary was the mother of the man only. Cyril² of Alexandria, supported by the Bishop of Rome, affirmed the opposite view, and was supported by the Council of Ephesus (431), which formally anathematized his opponent. The Nestorian school at Edessa was broken up and the party scattered. It found an asylum in Persia, whence it spread into India, China, Tartary, and Arabia. It still continues in Kurdistan, and a branch was found on the Malabar coast. Its ritual is simpler than that of the Greek or Roman Churches, and its organization less sacerdotal. See, further, art. NESTORIANISM.

(d) *Monophysitism and Monothelitism.*—Cyril's opposition to Nestorianism was carried so far by the monk Eutyches as to say that the two natures became one at the Incarnation, that Mary was in this full sense the Mother of God, and that Christ's body was not consubstantial with man's. Another bitter party struggle arose. The attempt of the Council of Chalcedon³ to settle the dispute by adopting the formula of two natures in one person, prescribed by Pope Leo I., increased the strife. Political interests were involved. Rome and Constantinople were at loggerheads; armed encounters became common; the Byzantine Emperors became the tool of either party by turn; and in the 6th cent. the separation became permanent. Monophysite Churches were formed in Armenia, Syria, Egypt, and Abyssinia. Notwithstanding persecution and division, they have survived in the Coptic, Ethiopic, and Armenian Churches of the present.

Monothelitism (the doctrine of one will in Christ) was a corollary of Monophysitism. It became the name of a distinct party in the 7th cent., through the attempt of the Emperor Heraclius to secure the aid of his Monophysite subjects against Persia by a compromise statement: there were two natures in Christ, but only one energy.

Another bitter feud followed. Bishops of Rome were now on this side, now on that. A succession of Eastern Emperors and patriarchs upheld the new view, but it was at last formally condemned at the Sixth Ecumenical Council, held at Constantinople⁴ in 680. The dogma of two wills was announced. Monothelitism, however, long survived. See, further, artt. MONOPHYSITISM and MONOTHELITISM.

This survey of ancient heresy shows that it was no mere product of disintegrating arbitrariness, but an essential force in the development of Christianity and an indispensable influence in the formation of orthodoxy.

3. Mediæval heresy.⁵—Heresy in the Middle

¹ For materials, see *PG* xlviil. 757 ff. (*Summus in Incarn.*) and 841 ff. (*Ep. iii. ad Cæl.*); also *Mansi*, iv., v., vi., vii., ix.

² *Ep. xvii.* (*PG* lxxvii. 112).

³ *Mansi*, vii. 118-118; *Schaff*, ii. 62 f.

⁴ *Schaff*, ii. 72 f.

⁵ The most important original sources of information are the Epistles of Popes Innocent III. and Honorius III., and of Bernard of Clairvaux and Peter the Venerable; chronicles, partly contemporary; decrees of Councils and Synods; 'Rescrip. Heres. Lomb. ad Leonistas in Alamannia,' ed. Preger, *Abhand. Münch. Akad.*, dritte Classe, xiii. (1875) 234 ff.; writings against heretics, as by Rainerius Sacco against the Waldenses (middle of 13th cent.); Moneta against Cathari and Waldenses; Salvus Burce, an Italian, who wrote *Supra Stella* against the 'Poor Men'; David of Augsburg and the 'Passau Anonymous' against the Waldenses. The works of Wyclif and Hus are well known. There are also many Waldensian MSS, as *La Nobla Leyczon*; J. J. L. v. Dollinger, *Beiträge zur Sektengesch. des Mittelalters*, i., ii., Munich, 1840; C. U. Hahn, *Gesch. der Ketzer im Mittelalt.*, Stuttgart, 1845; W. Preger, *Gesch. der deutschen Mystik*, Leipzig, 1874; *Beiträge z. Gesch. d. Waldenser im Mittelalt.*, Munich, 1875; H. Reuter, *Gesch. d. relig. Aufkl. im Mittelalt.*, I., II., Berlin, 1875-77; H. C. Lea, *Hist. of the Inquisition of the Middle Ages*, 3 vols., New York, 1887; A. H. Newman, *Hist. of*

Agas differs from ancient heresy mainly in that its interest was ecclesiastical and practical rather than doctrinal, though doctrinal it was. That is to say, it was the protest of individualism against an established order, rather than a rival movement of thought. Consequently it took the direction of an effort to secure a higher moral life in the individual and the community, and culminated at length in the establishment of rival ecclesiastical organizations. We do not concern ourselves here, of course, with the individual modifications or denials of particular doctrines—for these have always occurred—but with spiritual movements, common to many people, that threatened the very foundations of the Catholic Church.

The growth of the Papal power in the West, the conversion of the Franks, and the conquest of Oriental Christendom by the Muhammadans had shifted the centre of gravity for Christianity to Western Europe. Mediæval heresy is European. The striking thing about it is its rapid spread. It suddenly came into notice in the 11th cent., and in a short time the whole country, from Bulgaria in the East to Spain in the West, and from England in the North to the centre of Italy, was penetrated by its influence. Heretics were especially numerous in S. France, Switzerland, and N. Italy; but they were found in good numbers in Paris, Orleans, and Rheims; in Arras and Cambray of the Netherlands; in the German cities of Goslar, Köln, Trier, Metz, and Strassburg; in Hungary; in the S.E. counties of England; and in Catalonia and Aragon. The fabric of the Papal Church threatened to collapse, and only by the most violent measures, in co-operation with the secular authorities, were the heretics finally overthrown—not finally, for the Reformation revived the movement in many respects and gave it permanence. It seems plain, though clear proof is wanting, that it must have been quietly spreading among the common people and portions of the priesthood for a long time before the hierarchy, preoccupied with the politics of the Church, awoke to the danger.

The sources of mediæval heresy are fairly traceable. The older heresies had not been obliterated; Arian, Paulician, and Manichæan doctrines had been carried into Europe. The early non-sacerdotal type of faith had lingered. The schools of Charlemagne and the schools of the monks had stimulated the European mind to an active interest in scientific knowledge, and universities were coming into existence. The great revival of religion that marked the growth of monastic orders of the Clugniac type permeated the life of the common people increasingly, and the growing certainty of the possession of a religious and moral life that was not dependent on priestly sacraments and was fostered by the reading of the Scriptures, now becoming accessible in the vernacular, set the individual in a position of relative independence. Moreover, the Crusades, which grew out of that very revival, ultimately revolutionized economic and social conditions in Europe, shook the feudal system, emancipated mind and body from serfdom, brought in the influence of Saracenic learning by way of Spain, the Adriatic, and the Danube, and at the same time put the Greek and Latin classics into the hands of students, and thereby broke for many the spell of the Church's authority.

Passing by individual heresies, such as the Predestinarianism of Gottschalk (9th cent.), Berengarius' opposition to Transubstantiationism (11th cent.), and the scepticism of Abelard (12th cent.), we may group those heresies that produced separate religious communities as follows: (i.) Speculative

Anti-pædobaptism, Philadelphia, 1897; P. van Limborch, *Historia Inquisitionis, cui subiungitur Liber Sententiarum Inquisitionis Tholosanæ*, Amsterdam, 1692.

heresies, or heresies based on a philosophical view of God and the world. These are akin to Gnosticism and Manichæism and, in their asceticism, to Catholicism itself. (ii.) Heresies of Mysticism and 'Enthusiasm.' These arise out of supreme regard for the ecstatic experience and prophetism, and tend to pantheism. (iii.) Anti-sacerdotal evangelical heresies, characterized, on the one side, by radical opposition to the hierarchy and the sacraments, and, on the other side, by a democratic Biblicism. (iv.) Churchly evangelical heresies, which sought to reform the Church from within without destroying its unity and continuity. These divisions are only relative in some cases, for in many instances heresies with a fundamental difference have much in common.

i. SPECULATIVE HERESIES.—The most important of these are the dualistic heresies of the Cathari and the Bogomils, and the pantheistic heresies of the Amalricians, Beghards and Beguines, and Brethren of the Free Spirit. The first named is the most important heresy of this class.

(a) *The Cathari* ('Pure').¹—These Puritans of the Middle Ages first attracted the attention of the Church authorities early in the 11th cent. by their activities in Aquitaine and Orleans. In the latter place ten of the canonical clergy were burned in 1012 for adherence to their views. But already the heresy was firmly rooted, and soon spread through S.E. France and adjacent regions. The city of Toulouse was their stronghold. So numerous did they become, and so prosperous was the fine form of civilization that grew up through their intelligence, industry, and noble living that the Popes found it impossible to uproot the heresy except by summoning the neighbouring princes to a military crusade against these domains, which left the whole country of the Albigeois a smoking ruin (1229).

The Cathari (also known as Albigensians, Poplicani or Publicani, Patarins, and Bougri or Bulgari) were divided into Albanenses (Albi in France), or absolute dualists, and Concorricci (Concorrezo in Italy), or relative dualists. The former were more numerous. They represented the influence of Manichæism mediated through the Paulicians of Thrace and Bulgaria and the Arabian and Jewish philosophy that spread into France through Spain and Italy. There was also a reaction against the Church's degraded state. Catharism was an attempt to naturalize in Europe Oriental dualistic philosophy and strict asceticism joined to a ritual and organization that offered a contrast to the Roman establishment and a substitute for it. Its high morality and its power to satisfy the spiritual longings to which the Catholic system itself ministered were what made it so dangerous to the Church's supremacy and demanded the sternest measures for its suppression. The Cathari traced the origin of matter and spirit to two opposed beings (the Concorricci regarded Satan as a subordinate being, permitted to create), rejected those Scriptures that presented a favourable view of matter, held a fantastic view of the origin of the human race, of the Fall, and the redemption, and a docetic view of Jesus. The Holy Spirit was threefold—*sanctus*, *paracletus*, and *principalis*. Those in whom the Spiritus Principalis dwelt were the 'perfect' and sinless. The lower grade of Christians were simply *credentes*. The strictest asceticism was required of the former—prohibition of marriage, animal food, use of physical force, etc. As to 'last things,' they held that at death there was no resurrection, but a transmigration.

¹ Cf. Ital. *Gazaro*, Germ. *Ketzer*. The principal contemporary sources are: Moneta, *adv. Cath. et Wald.*; Rainerius Sacco, *Summa* (ed. Martène and Durand, *Thesaur. nov. anect.* v., Paris, 1717); Limborch, *Lib. Sent.*; Documents in Döllinger, *Beiträge*, etc., li.; Salvus Burce, *Supra Stella*

It was the Catharist rival ecclesiastical and ceremonial system that especially drew the anathemas of the Church. To them the Roman system seemed to be of the devil. For the Catholic priesthood they substituted the 'perfect' in four grades—bishop, *filius major*, *filius minor*, and deacon. Ordination was by the bishop. In place of the seven sacraments were four others: the *consolamentum*, for adults only, consisting of a ceremonial laying on of hands through which the Spirit was given. Thereby the subject was 'hereticated.' This was for the 'perfect,' and its validity depended on the purity of the administrator. By an arrangement known as *convenencia* the *credentes* postponed the *consolamentum* till near death. On receiving it the *endura* had to be sustained—a smothering or stabbing that might produce death. In the ceremony named *melioramentum a credens*, kneeling, received the blessing of the 'perfect.' They observed the blessing of bread at the daily meal, but denied transubstantiation. They practised ordination, but refused an oath. Their lives were blameless, and they were indomitable in enduring persecution. They managed to exist until the 14th century. See, further, art. ALBIGENSES.

(b) *The Bogomils* ('Friends of God') were a sect among the Slavs of Thrace and adjoining lands, also of Paulician origin, with a cosmology and a ceremonial system like the Catharist, but less developed. They held a view of the Trinity similar to the Sabellian, repudiated image-worship, used a baptism as an initiatory ceremony, but spiritualized the Supper, rejected parts of the OT, and employed allegorical interpretation. The Emperor Alexius Comnenus (1081–1118) secured, by a treacherous profession of conversion, a knowledge of their practices and their haunts, and then massacred them. They survived for some time in the region of Philippopolis. See, further, art. BOGOMILS.

(c) *The Amalricians* were the followers of Amalric, a professor of the University of Paris, who was condemned for heresy in 1204. They held a speculative view of the world's history, dividing it into three stages: the incarnation of God in Abraham, the incarnation of God in Mary, and, finally, the age of the Spirit beginning with the incarnation of God in the Amalricians. External ordinances were then to be annulled. The resurrection, heaven, and hell were spiritualized. *The Beghards and Beguines* were pious brotherhoods of men and women (said to have been first instituted by a priest named Begué), who gave themselves to prayer and ministry to the needy. They never intended to separate from the Church, but represent the growing spirit of lay piety. They gravitated towards pantheism. They flourished in the 13th cent. in many parts of Europe, but especially in the Netherlands. *The Brethren of the Free Spirit* (q.v.) were similar, and became numerous a little later, lasting into the 16th century.

ii. HERESIES OF MYSTICISM AND ENTHUSIASM.—The conflict between the Papacy and the Empire from the 10th cent. onwards, the degradation of ecclesiastical religion and morals, the apparently hopeless brutality of the times, and the long and bloody wars of the Crusades, with the inevitable economic and social confusion that followed, produced a wide-spread feeling of hopelessness, which took the form of a longing for retirement from the world, on the one hand, and an expectation of the immediate end of the present order of things, on the other. The former led to the cultivation of mystic piety and a rapid increase of monastic orders, while the latter issued in the formation of sects which cherished millenarian expectations and cultivated the gift of prophecy.

Individualism, which is the root of heresy, is of

the essence of these tendencies. Either, if widespread, would threaten existing political and ecclesiastical organizations. The Church was able to find a place for Mysticism within the established order—and, indeed, the impossibility of a universal adoption of the mystic habit favoured the dependence of the masses on the Church—but the communion-forming power of Enthusiasm and its thorough radicalism rendered it uncontrollable and demanded its suppression.

The Mystics remained in the Church; and Bernard, the great mystic of Clairvaux, was one of the bitterest foes of the heretics. Nevertheless, the great German mystics—Eckart († 1327), John Tauler († 1361), his pupil, Henry Suso († 1366), John Ruysbroek († 1381), and Thomas à Kempis († 1471)—undoubtedly laid the foundation of much of that successful outbreak of heresy which we call Protestantism (cf. MYSTICISM [Christian]).

Among the 'Enthusiastic' bodies two are especially worthy of mention, the *Joachimites* and the *Spiritual Franciscans*. The first were the followers of Joachim of Floris (1145-1202), a Sicilian, who developed an anti-Papal apocalypticism which greatly stimulated the production of this type of literature, and disseminated chiliastic expectations widely among the common people. He viewed the history of the world as divided into three periods—the epoch of the Father reaching to Christ, the epoch of the Son reaching to 1260, and the epoch of the Spirit thence to follow. The overthrow of the Catholic Church and the Empire was soon to occur, and the new age to begin. These revolutionary ideas appealed powerfully to the restless spirit of the times, and remained unextinguished at the Reformation. They revived in the teaching of Thomas Münzer, Melchior Hoffmann, and Nicholas Storch; they were represented in a wing of the powerful Anabaptist movement, and helped to produce the Peasants' War and the Münster uproar.

The so-called Spiritual Franciscans appear in the middle of the 13th cent. as a protest against the Papal secularization of the Franciscan order of monks. The influence of Joachim is seen in the 'Everlasting Gospel' which was edited by Gherardo, a professor of the University of Paris, and consists of Joachim's prophecies, with annotations and additions. They are strongly anti-Papal. Gherardo was imprisoned, and the Spirituals were severely persecuted through the Inquisition. There is no doubt that they deeply influenced Wyclif, Hus, the Taborites, and the Anabaptists. See, further, artt. ENTHUSIASTS (Religious) and MYSTICISM.

iii. THE ANTI-SACERDOTAL EVANGELICALS.—Differing from both of the foregoing, though like them in their simple democratic character, was the anti-pædobaptist heresy which named Peter de Bruys and Henry of Lausanne among its chief leaders. Its beginnings are found as far back as the 4th cent.,¹ when Arius in Pontus, Jovinian in Milan, and Vigilantius in Southern Gaul vigorously opposed the growing hierarchical tendencies, asceticism, and paganized ritual of the Church. Despite persecution, the followers of the last two seem to have succeeded in maintaining themselves for centuries in the deep Alpine valleys. The reforming movement of Claude² of Turin perhaps helped them. In the stirring times of the 11th and 12th centuries, when the Clugniac revival was affecting so mightily the religious life of Southern France and Northern Italy, these Evangelicals became aggressive, and grew in numbers greatly.

¹ Epiph. *Hær.* lxxv.; Q. W. F. Walch, *Hist. d. Ketz.*, Leipzig, 1762-1786, iii. 321 f., 635 f.; Jerome, *adv. Jovin.*, and *adv. Vigil.* [PL xxiii. 221-368]; W. S. Gilly, *Life and Times of Vigilantius*, London, 1844; see 'Nic. and Post-Nic. Fathers,' 2nd series, vi., tr. and introd. by A. H. Newman.

² See Lit. on WALDENSA.

Peter¹ was formerly a priest. His active career lasted from 1104 to 1124. Henry¹ was a monk, coming later (1116-48). The former was burnt to death; the latter was imprisoned, but seems to have escaped. Their work consisted of an attempt to restore the democratic simplicity and pure morality of primitive Christianity by reiterating the teaching of the NT, especially of the Gospels. They laid small stress on the OT. Their great opponent, Peter the Venerable, charges them with opposing the baptism of infants, the erection of holy temples, veneration of crosses, transubstantiation, and offerings and prayers for the dead. On the positive side this means emphasis on personal faith, spirituality, a rational view of things, simplicity, immediacy of human relation with God, and the all-importance of the present life for final destiny.

Contemporary² with them was Tanchelm, who led (1115-46) a similar movement in the Rhenish provinces, and Eudo de Stella († 1147) of Brittany. Their work was more limited in extent. Extremely important was the reform instituted by Arnold³ of Brescia. He fought the secularization of the Church, and sought to simplify and purify the lives of the clergy and the monks, to separate them from secular concerns, and to make them dependent on popular contributions. After a career of great success he was handed over by the Emperor Barbarossa to Pope Alexander III. and hanged. The Arnoldists and the Humiliati, or 'Poor Men' of Lombardy,⁴ strong anti-sacerdotalists, were to some extent fruits of his work. We find them as late as the 14th century.

The Waldenses.—The Waldenses⁵ were the most influential of the mediæval heretical bodies, and have received the most attention from students of history. There is some uncertainty as to the origin of the name. Advocates of a very early, perhaps Apostolic, source of the movement derive it from the character of the country, the valley region (*Vaux, Vallée, Val*) of the Alps where they first appear; they are often connected with the reformatory work of Claude, bp. of Turin⁶ (9th cent.); but it is altogether probable that the name arose from the work of Peter Waldo. He was a wealthy Lyonese merchant, who came under the influence of the deep religious movement that affected France in the 12th cent., and, stimulated by the familiarity with the NT among dissenters, devoted his wealth to the procuring of translations of the Scriptures into the vernacular, and their circulation among the common people. It was thus at the first a layman's propaganda, but with no thought of separating from the Catholic Church. Ere long these advocates of Bible-reading found themselves opposed by the Church officials; and, when two Popes (Alexander III. [1179] and Lucius III. [1183]) in succession refused their petition for the right to teach and preach, and even excommunicated them, they were driven into opposition. Their zeal surmounted all obstacles, and their messengers were soon found in the whole of Central and Western Europe.

They adopted the ideal of poverty, at that time regarded as the chief mark of religiousness, and became known for a time as the 'Poor Men of Lyons.' Their spread into Italy brought them into contact with the more radical body of the 'Poor

¹ Newman, *Anti-pæd.*, ch. iii.; Petrus Venerabilis, *contr. Petrobrusianos* (PL clxxxix.); Bernard, *Ep.* 241 (PL clxxxii.); L. E. du Pin, *Eccles. Hist.*, London, 1693-1725, x. 86 f.

² J. O. L. Gieseler, *Eccles. Hist.*, Eng. tr., Edinburgh, 1846, ii. 532 f.; Lea, i. 64 ff.; Peter Abelard, *Introductio*, ii. 4 (PL clxxviii.).

³ Lea, i. 72 ff.

⁴ For their relations with the Poor Men of Lyons, see Newman, *Manual of Church Hist.*, Philadelphia, 1900-03, i. 571-574.

⁵ For a good bibliography, see Newman, *Manual*, i. 568 ff.

⁶ Hahn, *Gesch. d. Ketz.* ii. 48-59, and the authorities there cited.

Men of Lombardy,' with whom they were able to come to partial agreement (1217). In that country there were similar bodies known as Runcarians¹ (from John Ronco). The Waldensians of France held for a time to the Catholic view of the saving value of Baptism and the Supper, and believed in transubstantiation; but, as their cause prospered and greater opposition was met with, they drew nearer to the modern 'Evangelical' position. By the middle of the 13th cent. they had become directly opposed to sacerdotalism and ecclesiastical morality. Their pure lives attracted attention, and even became a mark of heresy. They repudiated the Church's miracles, festivals, prayers for the dead, intercession of 'saints,' and doctrine of Purgatory, and eschewed its public gatherings. They also refused oaths. Though, like the Cathari, they retained a distinction between the 'perfect' and 'disciples,' in nearly all respects they seem to have accepted at length the general views of the Petrobruscians and Henricians.

They developed a strong organization and propaganda, resembling the Franciscan, that had immense success. Their itinerant preachers found access to the numerous artisans' guilds in the cities and towns of Germany, and succeeded in imparting a deep religious feeling to the new democratic social and economic movement which overspread Central Europe. The Inquisition was on their track, but they showed great skill in evading its attacks, at times outwardly conforming. The Waldensian heresy could not be extirpated. It took a radical form in Austria, Bohemia, and Moravia, and had a large share in producing Hussitism and Anabaptism on the Continent, and Wyclifianism in England. The vast circulation that they gave to the Bible must have been one of the chief causes of the Reformation. As a distinct body they exist in considerable numbers in Italy at the present time. See, further, art. WALDENSES.

iv. CHURCHLY EVANGELICAL HERESIES.—Deeply influenced by the heresies just described are those which grew out of the recognition of the Church's corruptions and the imperative need of a moral and religious reform, but, through a realism in philosophy or an inability to admit a non-churchly Christianity, strove against separatism. The chief instances are the Wyclifian reform in England and the Hussite in Bohemia. Both of these had a political bearing, for they owed much of their vigour to the national spirit which had grown up in those countries in opposition to Papal claims or to alien authorities. Of these the Wyclifian reform is the earlier, and to some extent also the source of the Hussite, but the latter more deeply stirred the ecclesiastical world.

(a) *Wyclifianism*.²—The old English national feeling, subjected for a time to the Norman power, revived, and by a blending of the interests of the yeomanry and the nobility was able to assert itself powerfully against both King and Pope in the times of Magna Charta. Quarrels with the Pope over rights in Scotland, taxation of the clergy by royal authority, anger at the dominant influence of the French kings over the Popes at Avignon, the war with France, and the enactment of the statutes of *Provisors* and *Præmunire* to prevent the Popes from deriving a revenue from England—all these tended to sharpen the national antipathy to the Papacy. The reforming work of Robert

Grosseteste, bishop of Lincoln, who sought to purify the clergy and to encourage preaching by the mendicant monks, Langland's *Piers Plowman*, and Chaucer's *Canterbury Tales* show the manner in which the common people were becoming contemptuous of a dissolute clergy and in sympathy with a simpler form of religious life than was established. At this time (reign of Edward III.) John Wyclif (*q.v.*), professor at Oxford University, began a series of sharp attacks upon the Papal claims until he developed a view which regarded the Pope as the Antichrist foretold in the Apocalypse, advocated a kind of Presbyterial system of government for the Church, and repudiated the monastic orders. He sought to instruct the people by extensive writing in Latin and English, by translating the Bible into English (1380), and by sending out his 'poor priests' (cf. the Waldenses) two by two throughout the land, circulating his Bible and preaching. The sentiment of the country, the upward movement of the English peasantry at the time, and the access to the working men's guilds obtained by his preachers gave wide success to the propaganda. Doubtless at this time there was laid the foundation of English Protestantism, especially Puritanism. Wyclif was attacked by the ecclesiastical authorities, but up to the end of the reign of Edward the political authorities protected him. The accession of the weak Richard II. left him without support. He was driven from Oxford and retired to the parish of Lutterworth in Yorkshire, where he died in 1384.

While Wyclif's realism kept him in the Catholic Church, it also led him to a rigid predestinationism in theology which annulled the Church's prerogative in salvation. This led him in the direction of a doctrine of justification by faith, though it was never elaborated by him as excluding the necessity of good works. He held to baptismal regeneration, but did not exclude unbaptized infants from salvation. He rejected transubstantiation, and in the closing years of life apparently rejected purgatory.¹ The Council of Constance in 1428 pronounced him a heretic, and had his body exhumed and burned, and the ashes thrown into the Severn.

Wyclifianism blended with the work of the Lollards from the Continent and passed into English life as a permanent influence. It became an element in the great struggle by the peasants for social betterment. During the reign of the House of Lancaster, the Church was able to persuade the authorities partially to suppress it. The first English Act of Parliament (*de Comburendo Heretico*) sentencing heretics to death by burning was passed in 1401, and the death of a priest, William Sautre, for heresy was followed by the burning of many others. During the Wars of the Roses the religious movement was mostly overlooked, but it worked silently until it broke out again in the Reformation.

(b) *Hussitism*.³—The Bohemian people were Slavs by race, and were converted to the faith of the Greek Church. Hence, when they came under the Empire and the Roman Church, they retained some religious and political antipathy to the established condition of things. The doctrines of the Bogomils and of the Waldenses were hospitably received in many places. Through the influence of men like Conrad of Waldhausen, Militsch of Kremsier, Mathias of Jagow, and Thomas of

¹ Lea, i. 88.

² Works of Wyclif: ed. Lechler, Oxford, 1869; Poole, London, 1885-90; Arnold, Oxford, 1869-71; Vaughan, do. 1845; Buddensieg, Leipzig, 1883. On Wyclif: G. V. Lechler, *Johann v. Wiclif*, 2 vols., Leipzig, 1873 (tr. P. Lorimer, London, 1878); R. Vaughan, *Life and Opinions of John de Wycliffe*, 2 vols., London, 1828; G. M. Trevelyan, *England in the Age of Wycliffe*, do. 1899.

¹ Vaughan, ii. 292; Lechler, ii. 564.

² E. H. Gillett, *Life and Times of John Huss*, 2 vols., Boston, 1871; Johann Loserth, *Wiclif and Hus*, Eng. tr., London, 1884; F. H. H. V. Lützow, *Life and Times of Master John Hus*, do. 1909; Franciscus Palacky, *Docum. Mag. Joannis Hus*, Prague, 1869, *Urkundl. Beiträge z. Gesch. d. Hussitenkriege*, do. 1873-74.

Stitny, both the learned and the masses became roused to the demand for a national-religious reform. The University of Prague became the stronghold of opposition to the Papacy. Large numbers of English students were there. John Hus and Jerome of Prague had imbibed Wyclif's ideas. When, as a result of disputes, the German students abandoned Prague in 1409, the Wyclif-Bohemian influence became supreme.

John Hus (*q.v.*) became rector in 1403, and, with the aid of Jerome and the support of King Wenceslaus, attacked the Roman clergy. After the failure of other attempts to suppress the revolt, the Pope proclaimed a crusade against Bohemia. Hus was excommunicated in 1413 and cited to appear before the Council of Constance. Notwithstanding that he came under the safe-conduct of the Emperor Sigismund, he was imprisoned, and, after some months, was burned for heresy in July 1415. Shortly after Jerome suffered the same death.

Hus followed Wyclif in his doctrine of predestination and the view of Christ's sole headship of the Church, but he was less thorough, and held to transubstantiation. His nationalism was the chief cause of his execution. After his death the Bohemian and Moravian people were roused to fury against priestism. Under John Zizka and Nicholas of Hussinecz as leaders they assembled on Mount Tabor (whence the name Taborites), and manifested their democratic spirit by claiming the communion for the people in the Cup (whence the name 'Calixtines,' from *calix*) as well as in the bread. Military success, at first, was followed later by a division into two parties—the Calixtines, who sought to remain in the Roman Church while claiming the Cup for the laity; and the Taborites, who followed the Waldenses in their hostility to the Roman Church. The latter founded a theocracy and gravitated to Millenarianism, but after a long struggle they were conquered in 1453. Many of those who survived united with the Evangelicals of a peaceable, somewhat Pietist, type known as the Bohemian Brethren, *Unitas Fratrum*, and by other names. These attached themselves to the Reformation. They became blended with a similar body of Moravians, known to history as the Moravian Brethren (*q.v.*), and through them have persisted to the present day.

The story of mediæval heresy shows that the heretics were repressed but not destroyed. The Protestant Reformation sprang largely out of these movements of the spirit of dissent, and was their natural and inevitable fruit. The positions of the various Protestant bodies, including the Anabaptists, show the varying degrees in which the 'heretical' spirit found access to European spiritual life.

The story of Christian heresy properly closes with the Reformation. From the Catholic point of view, Protestantism is identical with heresy. And correctly so; for Protestantism stands for the prerogative of the individual. This is the root of all 'heresy.' But the absurdity of designating the whole of the most powerful portion of Christendom heretics in a derogatory sense is too evident to need proof. It is true that from the point of view of the Protestant confessional Churches, as well as of the Catholic Church, the Anabaptists (*q.v.*) were heretics, and were so treated. Yet they, like the mediæval dissenters, were simply radical Protestants. It is true, also, that from time to time individual thinkers who have disputed the Protestant creeds have been adjudged heretics by courts of their respective communions, but in this there is no thought that the so-called heretic has been excluded from salvation and the fellowship of the true invisible Church. The charge of heresy is rapidly becoming meaningless.

LITERATURE.—I. *ANCIENT*.—Justin, *Syntagma*, c. 147 (lost); Irenæus, *adv. Hær.* (PG vii.), c. 185; Hippolytus, *Syntagma* ('Refutation of All Heresies') (PG x.), c. 180, and *Philosophumena* (PG xvi.), later; Tertullian, *de Præscr. adv. Hær.*, and works against Praxeas, Marcion, etc. (PL ii.), early years of 3rd cent.; Epiphanius, *adv. Hær.*, largest ancient work on the subject (lost), latter part of 4th cent.; Philastrius, *de Hær.* (PL xii.), c. 387; Vincentius of Lerins (PL i.), about same time; Theodoret, *Compend. Hæret. Fabularum* (PG lxxxiii.), 452; Leontius of Byzantium (PG lxxxvi.), and Isidorus of Hispala (PL lxxxii.), both 6th century. Nearly all the early ecclesiastical writers dealt with the subject at times.

II. *MODERN*.—R. A. Lipsius, *Quellen der alt. Ketzergesch.*, Leipzig, 1876; *Corpus Hærescol.*, ed. F. Oehler, Berlin, 1856-61; A. Hilgenfeld, *Ketzergesch. des Urchristenthums*, Leipzig, 1884. Earlier works are: G. Arnold, *Unparteiische Kirchen- und Ketzehistorie*, Frankfurt, 1700; J. L. v. Mosheim, *Ketzergesch.*, Helmstädt, 1746-48; C. W. F. Walch, *Historia der Ketzereien*, Leipzig, 1762-85. References: J. D. Mansi, *Concilia*, Florence and Venice, 1759-98 (new ed. Paris, 1900 ff.); J. Hardouin, *Acta Concil.*, Paris, 1714-15. Histories of Doctrine by F. C. Baur, Leipzig, 1867; J. A. W. Neander, Eng. tr., London, 1882; G. Thomasius, Erlangen, 1874-76; F. Loofs, Halle, 1906; R. Seeberg, Leipzig, 1895-98; H. W. C. Rinn (*Dogmengesch. Lesebuch*), Tübingen, 1910, and esp. A. Harnack (Eng. tr. 1894-99); see also M. J. Routh, *Reliquiæ Sacræ*, Oxford, 1814-18.

GEORGE CROSS.

HERESY (Jewish).—The conception of heresy has always been vague in the Synagogue; for freedom of thought, though often denied by fanatics, has been a recurrent characteristic of Judaism. Conduct, moreover, is easier to observe and judge than opinion; and, though, under stress of pressing controversies, attempts were made to define the opinions which would exclude men from sharing the communal rights, it may be said that for long periods conformity to practice, both ritual and moral, would be held to cover a good deal of eccentricity in theory. In recent times there has been so great a modification and relaxation in conduct on ritual matters that the tendency is growing to judge of men's fidelity to Judaism by tests of faith. But, as there exists no central or even local authority to apply or enforce such tests, the question is decided by public opinion rather than by expert or technical judgment. Public opinion is always apt to move spasmodically; it soon becomes accustomed to theories which, when first enunciated, it abhors; and in the result the Synagogue may be said to be free, on the one hand, from rigidity, and, on the other, destitute of clarity as to the ideas on which a charge of heresy could be based.

Historically considered, the problem of heresy in Judaism may be said to have been for the most part dependent on contemporary exigencies. When certain fundamental dogmas or practices were being assailed, the Synagogue would feel called upon to re-assert them; and, in order to emphasize this re-assertion, it might declare that the doubters 'had no part in the world to come.' When in the 1st cent. the Sadducee disputed the doctrine of the resurrection, the Pharisee would declare the doctrine a fundamental. So in the 19th cent., when the German reformer denied the validity of the traditional law, the orthodox would demand allegiance to its every word as the mark of the Jew. In between, when mysticism threatened to become antinomian in the 18th cent., or when, in the 17th cent., the Messianic claims of a popular hero like Sabbatai Zebi well-nigh shook the Jewish world to its foundations and gave rise to all sorts of vagaries in act and thought; or when, in the 13th cent., as a result of the great work of Maimonides, the Hellenizing of Jewish thought under scholastic influences seemed likely to undermine a simple acceptance of the Scriptures; or when, earlier still, in the 7th cent., under Anan ben David, such movements as Karaism proposed a new *halakha* (or practical code of life) on the basis of a deliberate departure from the current (Gaonic) theories of exegesis—in such cases controversies more or less virulent broke out, and the litigants

would freely hurl at each other charges of heresy and threats of excommunication. The efficacy of the charge would be determined only after considerable discussion, and the practical good sense of the community would in the end prevail to soften asperities and so enlarge the place of the tent as to find room for all, if not with cordiality, at least without churlishness.

In the earlier period it is characteristic that the Synagogue never naturalized the word 'heresy.' It readily admitted, to denote 'heretic,' the Greek word *Epicurean* (ἑπικουρεῖα, e.g. Mishn. *Aboth*, ii. 14); but, though Josephus freely employs *αἵρεσις*, he uses it to mean 'sect' or 'party,' and applies it equally to the Pharisees, Sadducees, and Essenes. It may be, however, that it was Greek influence that determined the selection of the commonest Hebrew word for 'heresy,' *minūtāh*. The Heb. word *min* (מין) signifies in Biblical Hebrew 'kind' or 'species'; the LXX renders *min* by γένος in Gn 1¹¹. The latter word is applied by Josephus (*Ant.* XIII. x. 6) to the Sadducees (τὸ τῶν Σαδδουκαίων γένος). Further, in Christian-Palestinian Aramaic, *min* corresponds to *ἔθνος* (cf. Schürer, *ThLZ*, 8th March 1899, and Bacher, *REJ* xxxviii. [1899] 45). This equivalence may have led to the predominance of the word *min* for 'heretic' in general. Just as the word 'people' (עַם) came to mean 'non-Jew,' so *min* came to signify 'heretic.' If Bacher's view be accepted, the *min* was originally the Sadducee (regarded from the Pharisaic standpoint). There has been much controversy as to the connotation of the term in the Rabbinic records. The general trend of opinion is in favour of the conclusion that, whereas the term *min* sometimes refers in those records to sectarians in general, and to the Gnostics in particular, yet it often describes specifically the Judæo-Christians (for particulars as to the controversy, see M. Friedländer, who, in his *Der vorchristliche jüdische Gnosticismus* [Göttingen, 1898], identifies the *min* with the Gnostic; and Travers Herford, who, in his *Christianity in Talmud and Midrash* [London, 1903], maintains that under the term *min* the Jewish Christians are at all events included). One thing is quite certain: the *min* was one who was, or who professed to be, a Jew; the Synagogue's concern was to deal with its own adherents, not to assail those who belonged to other religious systems. The liturgical paragraph in the Eighteen Benedictions refers not to Gentile but to Jewish Christianity; and, when the latter ceased to be a menace to the unity of the Synagogue, the formula was modified to apply to other varieties of sectarians within the Synagogue. Probably this is true of all religions. Christian law does not seem to have treated the Jew as a heretic; the Inquisition, for instance, applied its tests of heresy rather to those who, after accepting Christianity, were suspected of relapse to Judaism. So, too, in England, the Jews in the mediæval period were not subject to the heresy laws, though a Christian convert to Judaism was so subject (cf. F. W. Maitland, *Roman Canon Law in the Church of Eng.*, London, 1898, p. 158; H. S. Q. Henriques, *The Jews and the Eng. Law*, Oxford, 1908, p. 66). No doubt a Jew who publicly assailed the dogmas of the Church was liable to the laws against blasphemy (such a charge is recorded in Bristol in the year 1589; see Abrahams, *Transactions of the Jewish Historical Society of England*, iv. [1903] 99). At all events, the early Synagogue made no attack on Gentile Christianity; it merely tried to eliminate from its midst the Judæo-Christians who, in the language of Jerome (*Ep.* 89 *ad August.*), claiming to be both Jews and Christians, were neither.

Besides the two terms *Epicurean* and *min*, the Rabbis made use of another word for 'heretic.' This was the word *kôphêr*, 'denier.' The full expression is 'denier of the root,' i.e. of the fundamental principles (קפרי קקרי, *Sifra*, 111b; *Baba bathra*, 16b, etc.). What the fundamental principles are is never defined; in one famous passage the definition of Judaism is negative, and any one who rejects idolatry is called a Jew (*Megillah*, 13a). The term *kôphêr* is vaguely applied. Sometimes the Rabbis ascribed sin to the lack of belief in the fundamentals. Thus Adam's sin was preceded by his denial of the root principle, the belief in God's omnipresence (*Sanh.* 38b). Cain, again, before he slew his brother, had reached the state of mind in which he asserted that 'there is no judgment, no judge, no reward, no punishment' (Targ. Jer. on Gn 4⁸; cf. Schechter, *Studies in Judaism*, 1st series, London, 1896, p. 189). There is, however, no definition in the older sources of these various terms for 'heresy.' The *locus classicus* is the Mishn. *Sanh.* x. 1 (to which, be it remarked, the Tosefta *Sanh.* xii. xiii. adds further details). In the quoted Mishna certain classes are pronounced beyond the pale of future bliss: 'These have no part in the world to come: he who asserts that there is no Resurrection of the dead, that the Law was not from heaven, and the Epicurean. R. Aqiba says: also he who reads in outside books, and he who applies incantations to wounds. Abba Saul said: also he who pronounces the Name as it is written.' Some texts make the first clause run: 'he who denies that the Scripture teaches the doctrine of Resurrection'; but the best authorities read as in our translation. The phrase 'outside books' has been variously interpreted to mean extra-canonical, Judæo-Christian, or, in general, heretical books. *Epicurean* is not defined, but in after centuries it became a term generally applied to a sceptic or unbeliever, especially where the scepticism or infidelity was associated with a frivolous attitude towards the problems of religion.

In the 12th cent., Maimonides attempted to summarize the Talmudic statement as to the terms *min*, *Epicurean*, and *kôphêr* more closely. There are five classes, he says (*Code*, 'Laws on Repentance,' iii. 7-8), included under *min*: (1) he who denies God, (2) he who asserts that the world is subject to more than one power, (3) he who ascribes corporeality to God, (4) he who denies that God was the first Creator, and (5) he who worships a star as a mediator between himself and God. The *Epicurean* includes three classes: (1) he who denies prophecy, (2) he who disputes the inspiration of Moses, and (3) he who denies that God regards the doings of men (cf. *Jos. Ant.* bk. x. at the end). The *kôphêrīm* also consist of three types: (1) he who denies the complete verbal inspiration of the Torah, (2) he who denies the tradition, and (3) he who asserts (this would point to both Christian and Muhammadan polemics) that the Law has been superseded by a new dispensation. In addition, Maimonides specifies others as not belonging to the three categories just defined. In all cases, Maimonides refers to Jews who join the various categories; for, as he plainly asserts (on the basis of the Tosefta, *loc. cit.*), 'the pious of the nations of the world have a share in the world to come.' It is only Jewish sectarians who are excluded by him. And against them Maimonides expresses himself elsewhere (in his Commentary on the Mishna on *Sanh.* x. 1) with uncompromising vigour. He formulated thirteen articles of faith as fundamentals (these are given in detail above, vol. iv. p. 246, where Hirschfeld points out that Maimonides had in his mind certain theories and heresies of his own

time). Maimonides then declared as a heretic whoever departed from any of these; such a one had 'gone out of the general body of Israel.'

But it may confidently be stated that no proceedings were ever instituted before a Jewish Court on the ground of refusal to accept the Maimonist articles. On the contrary, for a long time their author was himself charged with heresy (see H. Graetz, *History of the Jews*, Eng. tr., London, 1891-92, iii. ch. xvi.). More than that, from the very first there were great authorities who disputed the right of Maimonides to declare heretical the denier of even so fundamental a principle as the incorporeality of God. In his criticism of the Maimonist Code ('Laws of Repentance,' *loc. cit.*), Abraham ben David of Posquières, while himself far from denying this dogma, refused to admit that, if any one chose to interpret the Scriptural and Haggadic statements on the subject literally, he could be termed a heretic, even if he went so far as to ascribe a body to Deity. The fact that in 1656 Spinoza was excommunicated for, among other things, holding that God was 'extended' is liable to misunderstanding. The Amsterdam Synagogue was not then strong enough to be tolerant of scandal in its midst, having too recently acquired its right to exist (cf. ACOSTA, vol. i. p. 74). Even so, had Spinoza consented to conform outwardly, he would not only have been safe, but even pensioned. 'The ban against Spinoza,' as A. Wolf concludes (*Spinoza's Short Treatise*, London, 1911, Introduction, p. xlvii), was the due paid to Cæsar, rather than to the God of Israel.' Half a century later, when an attempt was made in London to attack Neto on the suspicion of his Spinozist leanings, nothing came of it but a good deal of heated discussion (see M. Gaster, *History of the Ancient Synagogue of the Spanish and Portuguese Jews*, London, 1901, p. 106). Moses Mendelssohn, in his *Jerusalem*, published in Berlin in 1783, most emphatically repudiated the suggestion that the Jews under emancipation should have conferred upon them the legal power to excommunicate heretics. Not unbelief or false doctrine, he held, was punishable under the ancient Jewish régime; but only contumacious rebellion against the civil law. Various sections of the Synagogue have, however, during the past century occasionally shown themselves inclined to excommunicate reformers; but they have come to regret such action, and no longer avail themselves of this, in modern times, most ineffectual expression of disapproval. So, too, the legal disabilities of the heretic prevalent in the Middle Ages under Jewish law have nowadays little validity. These disabilities are sometimes severely expressed in the Jewish Codes (see *JE* i. 666, vi. 353).

The feeling against heresy has always been weaker than the dislike of separatism. In fact, it was maintained in the Talmud that the rule held: once a Jew always a Jew (*T. B. Sanh.* 44); the Israelite on this view could not alienate himself from the community. As noted by Kohler (*JE* vi. 353), the law (*Dt* 14¹), 'Ye shall not cut yourselves,' is interpreted by the Rabbis (*Sifre, ad loc.*) to mean, 'Ye shall not make yourselves into sections, but shall all form one united band.' The same idea goes back to Hillel (*Mishn. Aboth*, ii. 5; cf. *He* 10²¹): 'Separate not thyself from the Congregation.' Here the appeal is for participation in the communal tribulations rather than in communal beliefs (cf. *Talmud, Ta'anith*, 30b). A similar phrase, however, 'one who separates from the ways of the congregation,' occurs in the *Tosefta* (*Sanh.* xiii. 5) in a context which is occupied with questions of faith. Undoubtedly the two ideas stand close together. But in the

main the Synagogue has throughout its history been desirous of retaining within its fold those united by common ideals, experiences, and hopes rather than of driving out those whose opinions diverged from the conventions generally accepted.

LITERATURE.—To the works indicated in the article, add those given in literature of art. CREED (Jewish), vol. iv. p. 246.

I. ABRAHAMS.

HERMESIANISM.—Hermes was the chief exponent of a movement for defending the Catholic faith by pure intellectualism, adopting the ideas of Kant, which passed over Germany during the first half of the 19th century. His system (Hermesianism) had a great vogue for a time, was condemned at Rome, and is now almost forgotten.

1. Life of Hermes.—Georg Hermes (= Hermannssohn) was born in 1776 at Dreyerwalde in Westphalia, of Catholic peasants. In 1788 he went to the Gymnasium of Rheine (under Franciscans), and soon became first in the school. In 1792 he entered the philosophical faculty at the University of Münster. Here he studied Kant and Fichte, and for a short time wavered in his faith. He recovered it, however, but retained a great admiration for Kant. The work of his life was to convince Kantists of the truth of Catholicism by their own weapons. In 1794 he joined the Theological Faculty, gaining a free bursary at the bishop's seminary. In 1798 he accepted a post as teacher in a Gymnasium at Münster. He was ordained priest in 1799. He now devoted himself to the study of philosophy, seeking a solid basis for the Catholic system on purely philosophical and rational lines. Besides Kant and Fichte, he was influenced at this time by Stattler.¹ In 1805, Hermes published his first work, *Untersuchungen über die innere Wahrheit des Christenthums*. In 1807 he accepted the chair of Dogmatic theology at Münster. Here he elaborated his principles, wrote a number of smaller works on the relation between philosophy and theology, gathered around him a body of devoted disciples, and became known throughout Germany as a leading Catholic philosopher. In 1820 he went to Bonn and became professor of theology there. From that time till the end of his life his reputation steadily increased. Nearly the whole University of Bonn accepted his ideas with enthusiasm. The only opposition came from Seber. In 1825, Seber was forced to yield to the general feeling and left the University. Hermes had by now founded a definite school; under him Bonn became the centre of a movement which was to justify Catholicism by a solid philosophical basis and to reconcile Protestants. In 1829 he published his chief work, *Einleitung in die christkatholische Theologie*, pt. i., which contains the philosophic introduction. This is the complete exposition of his ideas. Reusch describes it as his only original and characteristic work (*Allgemeine deutsche Biographie*, xii. [1880] 192-196). His disciples applied his principles to each branch of theology. O. A. von Droste-Hülshoff wrote a *Lehrbuch des Naturrechtes* (Bonn, 1823), on Hermesian lines; W. Esser, at Münster (*Moralphilosophie*, Münster, 1827), and P. J. Elvenich, at Breslau (*Moralphilosophie*, 2 vols., Bonn, 1830), applied his ideas to ethics. J. B. Baltzer (at Breslau) wrote a work, *Ueber die Entstehung der in neuerer Zeit im Protestantismus und im Katholicismus hervorgetretenen Gegensätze, mit bes. Rücksicht auf Hermes u. seine Gegner* (Bonn, 1833), in which he proclaims Hermes' system as the hope of reunion between Catholics and Protestants. Baltzer was the most independent of the Hermesians; later he and Elvenich became supporters of Günther. Towards the end of his life, Hermes was the most famous Catholic theologian in Germany. His school captured nearly all centres: Bonn, Köln, Trier, Münster, Breslau, Braunsberg were full of ardent Hermesians. There was some opposition. Hast at Münster, A. von Sieger at Munich, the *Aschaffenburger Kirchenzeitung*, H. Klee and O. H. Windischmann at Bonn itself already began combating the new philosophy. But during its author's lifetime the opposition did not exceed the limits of normal discussion. His bishop (F. von Spiegel, Archbishop of Köln) was always his friend and protector, sending pacifying accounts of his views to Rome. It was not till after Hermes' death that the storm burst. He died attacked by no censure, but rather applauded almost universally, on 26th May 1831. He is buried in the cemetery at Bonn. After his death, one of his chief disciples, J. H. Achterfeldt, edited a work which Hermes had prepared under the title *Christkatholische Dogmatik* (2 vols. and pt. i. of vol. iii., Bonn, 1834-35).

2. System.—The fundamental ideas of Hermes are: (1) an adaptation of Kant (and Fichte) to Catholic dogma, (2) a purely intellectual or rational basis for faith, (3) opposition against Lamennais' traditionalism (hence the Hermesians constantly accuse their opponents of sharing Lamennais' errors). He begins with the famous 'positive doubt.' We must have the courage to doubt

¹ Benedict Stattler, professor of theology at Ingolstadt (†1797), was a forerunner of Hermes in the idea of a purely intellectualist basis for theology. His *Demonstratio catholica* was condemned by the Congregation of the Index in 1780 (the decree was not published till 1796). Many of his ideas reappear in Hermes' system.

everything, even faith, till we can establish an intellectually convincing reason for it. Three questions now occur: (1) Is there any truth? (2) Is there a God, and of what nature is He? (3) Is a supernatural revelation possible, and under what conditions? Certitude of truth may be either necessary (*angethan*; this certitude he calls *Fürwahrhalten*) or freely accepted (*frei angenommen*; this is *Fürwahrnehmen*). Necessary certitude may be from sense-impressions (*Vorstellungen*)—unsafe; or from reasoning (*Verstandeswissen*)—also unsafe, because it leads to a process *in infinitum*; or from immediate necessity—this last is safe.

'We find, when we seem to know something necessarily, that our consciousness is not only that we know, but also that the known thing exists. This consciousness occurs without our voluntary co-operation; it is therefore a necessary conviction, not a freely accepted one' (*Einleitung*, 184 f.).

Freely accepted certitude arrives at the same end. The practical reason tells us that we cannot obey the highest moral obligation of which we are conscious (which is the preservation of our own human dignity—*die reine Darstellung und Erhaltung der Menschenwürde*) without using all means to that end which are at our disposal. Among these means is the use of the experience of others. So practical reason would command us to accept this experience, to admit the truth of history, even if theoretic reason still had doubts. Hence both sources of certitude (*Fürwahrhalten* and *Fürwahrnehmen*) bring us to the same result. From the acceptance of the truth of history, Hermes leads to that of the historical basis of Christianity. He denies that the existence of God can be sufficiently based on practical reason (this against Kant). He seeks to establish it by theoretic reason. It is necessarily, not freely, accepted truth. He proposes the cosmological argument for God very well; he rejects the ontological, physical, and moral arguments, also that from universal consent.

In explaining the errors of which Hermes was accused, we are met by the difficulty that his followers, while admitting that these are errors, deny that he held them. Hermesians declare that what was condemned at Rome was not Hermes' teaching, but a libellous caricature of it. He himself always protested that his system did not touch any point of the Catholic faith. This he accepted entirely, in the usual sense, as does every other Catholic. He is concerned only to establish a purely philosophical basis on which the faith may be accepted. However it may be with the points urged against him by his opponents, the errors which brought about his condemnation are these: Besides his 'positive doubt' as the starting-point of all apologetic (from which it would follow that a Christian should explicitly doubt the truth of his faith, of even the existence of God, till he has proved it intellectually), the general fault found with his system is that it is a shallow and narrow rationalizing of faith. Hermes conceives revelation as made only to the intellect; faith is mere intellectual conviction. Our other faculties have no part in our acceptance of Christianity. So, if Lamennais denied reason in favour of faith imposed from without, Hermes, falling into the other extreme, debases faith in favour of natural reason. All the particular errors of which he is accused come from this root—a tendency to lower the truths of revelation towards naturalism, to minimize mysteries, to meet the rationalist half-way. Even his concept of God is said to suffer from this tendency. God in Hermesianism is not the one absolute Being who fills all, in whom all being exists, source of all reality; but merely the highest individual among many who exist apart from Him, and have power and activity independently of Him. The end of creatures is not God, but their own perfec-

tion. Sanctifying grace is no real quality, but the permanent disposition on God's part to help us. Justification is an external imputation (as with Luther). Original sin is our inherited concupiscence. There was no supernatural state of primitive innocence. The death of Christ is an atonement only in the sense that God by it makes us understand how grievous sin is. Hell exists as a threat to frighten us; God is, however, compelled to fulfil this threat, in spite of His goodness, because of His truthfulness.

3. Condemnation of Hermesianism. — When Hermes died, no fewer than thirty chairs of theology were held by his disciples. On the other hand, the opposition to his ideas grew rapidly. Windischmann, F. X. Werner, and others began to denounce them and to demand their condemnation at Rome. Archbishop von Spiegel, Hermes' protector, died in 1835. The Inquisition collected reports from a number of German theologians (on both sides); at last, on 26th Sept. 1835, Gregory XVI. published a brief, *Dum acerbissimas*, condemning Hermes' system and putting his works on the Index (Denzinger, 1618-21). A further decree of 7th Jan. 1836 added the condemnation of the later work edited by Achterfeldt. Hereupon arose a great disturbance in Catholic Germany. The Hermesians agitated against the condemnation, declaring that their master was not guilty of the errors imputed to him. Two of them, Braun and Elvenich, went to Rome in 1837 and spent a year there, vainly trying to procure a repeal. Then Hermesianism, after having been the dominant influence in German Catholic theology, was banned. The Hermesians were called upon by the bishops to signify their adherence to the Papal decision. Gradually most of them did so. But, when Pius IX. became Pope (1846), those of the school who remained hoped for a reversal of the situation. They acclaimed his brief *Qui pluribus* (9th Nov. 1846, recommending philosophy and explaining its relation to theology) as practically an adherence to Hermes' idea. There was then a certain revival of the discussion. About the same time Günther began to spread his ideas.¹ They were to a great extent founded on the same line of thought as those of Hermes; so that several of the old Hermesians attached themselves to him. Pius IX., on 25th July 1847, published a decree renewing his predecessor's condemnation of Hermes' system. This is the end of Hermesianism. The political upheaval of 1848 destroyed the last remnant of general interest in it; then came a great revival of Catholic life in Germany along quite other lines, and the whole question was forgotten. Only here and there an old disciple of the once great man was faithful to his teaching, almost in secret, remaining (like the Jansenists in France after the Revolution) as a relic of a bygone age. Achterfeldt and Braun were recalcitrant for a long time. Either the powerlessness of their cause, which made it harmless, or a dim memory of Hermes' ancient fame made their bishop treat them very leniently. The worst that ever happened to them was suspension from public offices, with leave to say Low Mass; this was removed when they offered a declaration of general adherence to Papal decrees. Achterfeldt, the last Hermesian, died in 1877. The subject has now only a historical interest.

LITERATURE.—Besides works quoted above, see W. Esser, *Denkschrift auf Georg Hermes*, Köln, 1832; K. Werner, *Gesch. der kath. Theologie*, Munich, 1866, p. 415 ff. (an admirable statement of Hermes' system). For Hermes: P. J. Elvenich, *Acta Hermesiana*, Göttingen, 1836; J. Braun and Elvenich, *Acta Romana*, Hanover and Leipzig, 1838; A. Lutterbeck, *Apologie des sogen. Hermesianismus*, Münster, 1835; Blunde and Rosenbaum, *Blätter zur Orientierung in Sachen des Hermesianismus*, Trier, 1838; H. J. Stupp, *Die letzten Hermesianer*.

¹ See art. GÜNTHERIANISM.

Wiesbaden, 1844, also *Pius IX. u. die kath. Kirche in Deutschland*, Bollingen and Mülheim, 1848. Against Hermes: Myletor (= F. X. Werner), *Der Hermetismus vorzugweise von seiner dogmatischen Seite dargestellt*, Regensburg, 1846 (the most powerful work against him); J. M. Meckel, *Die hermet. Lehren*, Mainz, 1837; W. Zell, *Acta antihermesiana*, Regensburg, 1839; F. Lange, *Novae annotationes ad Acta hermetiana*, Mainz, 1839; C. G. Niedner, *Philosophia Hermesii Bonensis, novarum rerum in theologia ezordii, explicatio et existimatio*, Leipzig, 1838; A. Roscovány, *Romanus Pontifex*, iv., Neutra, 1867-78.

ADRIAN FORTESCUE.

HERMES TRISMEGISTUS.—The name of Hermes Trismegistus stands, like that of Homer, for a whole literature. But this literature is philosophical and religious, not poetical. It presents a curious phase of human thought emanating from Egypt, and might roughly be described as 'Plato according to the Egyptians.' Only roughly, indeed, for the matter is far more complex than this. Take Plato, the Stoics, Philo, Catholic Christianity, Gnosticism, Neo-Platonism, and Neo-Pythagoreanism, mix them well up together, throwing in a strong flavour of ancient Egypt, and the result of the brew will be something like Hermes Trismegistus as we have him.

1. The assumed author.—Plato in two passages (*Phileb.* 18 B; *Phædr.* 274 C) mentions an Egyptian god or divine man, named Theuth, to whom were attributed many inventions—arithmetic, algebra, geometry, astronomy, draughts, dicing, but especially the alphabet and writing—which Thamus, the then King of Thebes, is said to have condemned as being destructive to the memory, instead of an aid to it. Now, according to Cicero (*de Nat. Deor.* iii. 56), the fifth Mercury, who was the slayer of Argus, was obliged on that account to flee into Egypt, where he gave laws and letters to the Egyptians. 'Him the Egyptians called Theuth, and the first month of the year among them (September) is called by his name.' Here we find the equation Hermes=Theuth. Lactantius (*Div. Inst.* i. 6) quotes this passage of Cicero, and goes on to say that this same person founded Hermopolis, and was worshipped by the Saitæ, and, though a man, was so honoured for his learning that he received the name of *Trismegistus*,¹ adding in another place (*de Ira Dei*, 11) that Hermes Trismegistus was far older, not only than Plato, but also than Pythagoras and the famous Seven Sages. Lactantius thus accepts the antiquity of Hermes, which makes for his purpose, with the same naïveté as Tertullian accepts the antediluvian authorship of the Book of Enoch, which must, it would appear, have formed part of the library of Noah in the Ark.

Among early modern scholars there was the same readiness to accept Hermes at his own valuation. Verginius puts him before Moses; Patricius makes him an elder contemporary of that legislator; Flussas Candalla is inclined to put him back as far as the time of Abraham. Isaac Casaubon, Isaac Voss, and the great Fabricius stand out as exceptions to this general credulity. Fabricius begins by intimating his own opinion that the books which went under the name of Hermes were not earlier than Homer, not to speak of Moses; and ends by acquiescing in the judgment of 'certain most learned men,' who put them down as the work of a Jew or of some half-Platonic, half-Christian author about the beginning of the 2nd cent. A.D.

One of the first results of examining these works themselves is to make us deny the equation Hermes=Theuth. Hermes is represented as the father of Tat, who appears to be the same as Theuth or Thoth. In the *Asclepius* (ch. 37), Hermes is made

¹ On the bilingual Rosetta stone, 196 B.C., 'Ἐρμῆς ὁ μέγας καὶ μέγας occurs as a rendering of the Egyptian 'Thoth the great' or 'twice-great' (Mahaffy, *Emp. Ptol.*, London, 1895, p. 320).

to claim that he is the grandson of the god Hermes, who was worshipped at Hermopolis. Hence this person has been called 'the younger Hermes.' Similarly the Asclepius whom he is instructing is declared to be the grandson of the inventor of medicine. On the other hand, the Hermes of the 'Holy Book' (Stob. *Ecl.* i. 926) is himself one of the greatest of deities, and the instructor of Isis and Osiris. In the *Poemander* (ch. 10), Tat claims descent from Uranus and Cronus, of whom it is said that they have already attained to the beatific vision. Asclepius, who is called in the Holy Book ὁ Ἱμοῦθης, or simply Ἱμοῦθης (Stob. *Ecl.* i. 932, 1092), is the son of Hephestus,¹ not, as in Greek mythology, of Apollo, and is credited with the patronage of poetry as well as of medicine.

2. Works.—From the assumed author we now turn to his supposed works. We are told by Iamblichus, or whoever wrote the *de Mysteriis* (viii. 1), that Manetho (an Egyptian priest who lived in the time of Ptolemy I.) said that Hermes wrote 36,525 books. Such a number, as Fabricius remarks, has deservedly seemed incredible to many. Especially is this the case if another statement is true, namely, that this is the precise number of years assigned by Manetho to the thirty dynasties of Egypt. Let us therefore descend at once to a somewhat lower estimate. We are told by the same Iamblichus (fl. A.D. 300), this time on the authority of an author named Seleucus, that the number of books written by Hermes was 20,000—a statement which is confirmed, or echoed, by Julius Firmicus (A.D. 340). Lactantius, whose death is placed between A.D. 325 and 330, confines himself to saying that Hermes Trismegistus wrote many books.

From Clement of Alexandria (A.D. 200) we learn that books of Hermes were associated with the Egyptian religion. He describes (*Strom.* vi. 4, p. 757, Potter) a religious procession, headed by the minstrel bearing some symbol of music. Of him it is said that he must have learnt by rote two of the books of Hermes, one of them containing hymns to the gods, and the other an Ἐκλογισμὸς βασιλικῶν βιβλῶν. After the minstrel comes the ὠροσκόπος with a horologe in his hand, and a palm, as symbols of astronomy. He must have ever on his lips the four books of Hermes which treat of this subject, dealing severally with the orderly arrangement of the fixed stars, with the conjunctions and light of the sun and moon, and with their risings. Next in order comes the sacred scribe wearing feathers on his head, and carrying in his hand a book and a ruler (καρόνα), containing ink and the reed with which they write. It is his business to know what are called the hieroglyphic books, dealing with cosmography, geography, the order of the sun and moon, the five planets, the topography of Egypt, and many other things. Then follows the warder of the sacred vestments, with the cubit of justice and the libation-cup. He has to know all the educational and what are called the moschosphragistic (not *moschosphagistic*; cf. Herod. ii. 39: τὸ σεσημασμένον κτήνος) books; and there are ten that relate to the worship of their gods, embracing the religion of the Egyptians, as, for instance, concerning sacrifices, firstfruits, hymns, prayers, processions, festivals, and the like. After all these comes the prophet with the water-clock visible in his bosom, who is followed by the bearers of the processional loaves. He, as being the president of the temple, learns by heart the ten books that are called hieratic, comprising the laws and the gods and the whole education of the priests; for the prophet among the Egyptians is also master of the distribution of the revenues. The quite necessary books, then, of Hermes are

¹ In Egyptian, Imhotep, son of Ptah.

two and forty,¹ thirty-six of which, containing the whole philosophy of the Egyptians, are learnt off by the before-mentioned persons, and the remaining six by the shrine-bearers. These six are medical, and have to do with the bodily constitution, diseases, organs, medicines, ophthalmology, and gynaecology.

These books of Hermes, which were connected with the religion of the Egyptians, have been mentioned here in order to be excluded. Such books would naturally be purely Egyptian in both language and thought, whereas the books which have come down to us under the name of Hermes—those, at all events, which we are about to consider—are Greek in language and mainly indebted to Plato for their thought. Iamblichus, indeed, states that the works of Hermes were translated from the Egyptian by men acquainted with Greek philosophy, but the works now in question present every appearance of having been composed in Greek. Patricius, starting from the assumption of the hoary antiquity of Hermes, drew the conclusion that all the philosophical systems of the Greeks, the mystical mathematics of the Pythagoreans, the ethics and theology of Plato, the physics of Aristotle and the Stoics, were derived from the works of Hermes, whence he advocated the substitution of these works in the public schools and monasteries for the philosophy of Aristotle, which was far less Christian than they. This contention is logical enough on his premisses. For certainly, if the Hermetic writings are not derived from Greek philosophy, Greek philosophy must be derived from them.

The earliest author who shows acquaintance with our Hermes is Lactantius. He has frequent allusions to and quotations from Hermes Trismegistus, some of which we are able to verify by comparison with the extant works.² Plutarch (fl. A.D. 80) has a hearsay reference to the books of Hermes,³ but there is nothing to show that they are those known to us.

The most important of the works attributed to Hermes Trismegistus is the *Poemander* (ὁ Ποιμάνδρης). The name looks as if it meant 'Shepherd of men'—a derivation which is indicated by the writer (xiii. 19), and which has led to perhaps fanciful surmises of some connexion with the *Shepherd* (Ποιμήν) of Hermas. It has been thought, on the other hand, that the word is really Egyptian, though Fabricius points out that Ποιμάνδρης occurs as the proper name of a mythological person in Plut. *Mor.* 299 C, D, *Græca Quæst.* 37. In the work before us, ὁ Ποιμάνδρης is the name of a mysterious being, characterized as ὁ τῆς ἀθετηρίας νοῦς, who figures as the guide and instructor of Hermes. He stands for the higher mind of Hermes himself, in accordance with what Plato says in the *Timæus* (90 A), that a man's δαίμων is his own νοῦς. The *Poemander* gives his name to the whole work, but he is mentioned only in the first and in the thirteenth out of the fourteen chapters which constituted the work as published by Marsilius Ficinus. Outside the first chapter, Hermes is rather the instructor of others. We are given to understand that, on the basis supplied by the *Poemander*, Hermes is competent to arrive at all truth for himself (*Poem.* xiii. 15).

The *Poemander* was first given to the modern world in a Latin translation made by Ficinus from a Greek MS, which was brought from Macedonia to Florence by a monk named Leonhardus of Pistoia, and put into the hands of Cosmo de Medici. According to the statement of Fabricius, it was first published

at Venice in 1483,¹ when it appeared along with other small works translated by Ficinus. Its first title was *Mercurii Trismegisti Liber de Potestate et Sapientia Dei*. This Latin version was often reprinted at Venice, Paris, Leyden, and Basel; and it still appears at the bottom of the page in Parthey's edition, after having been touched up by successive editors—Flussas, Patricius, and Parthey himself. Vergicius is presumably alluding to the work of Ficinus when he says that a Latin translation, not very carefully done, was published at Venice by Aldus, from which an Italian translation was afterwards made, and printed at Florence. A French translation was made by Gabriel Prateolus (du Préau), Paris, 1557; another by Flussas, Bordeaux, 1579; and a recent one by Louis Ménard, Paris, 1866. The work was translated into Dutch, from the Latin of Patricius, by Nicolaus van Ravenstein, Amsterdam, 1643. It was translated into German by one Aletbophilus, Hamburg, 1706; afterwards, by Dieterich Tiedemann, Berlin and Stettin, 1781. In English we have had, firstly, *The Divine Pymander of Hermes Trismegistus*, translated into English by Everard, London, 1650, professedly from the Arabic—a work which has been reprinted in many quarters, and in particular in the *Journal of Speculative Philosophy*, July 1866; secondly, *The Theological and Philosophical Works of Hermes Trismegistus, Christian Neoplatonist*, by J. D. Chambers, Edinburgh, 1882; thirdly, the large work, in 8 volumes, entitled *Thrice-Greatest Hermes*, by G. R. S. Mead, London, 1906.

The first Greek ed. of the *Poemander* was that of Adrianus Turnebus, Paris, 1554. This contains a preface in Greek by Ἄγγελος ὁ Βεργίκιος; also a minor work of Hermes, called Ὅροι Ἀσκληπίου πρὸς Ἀμμωνᾶ βασιλῆα (*Æsculapii Definitiones ad Ammonem Regem*), and the Lat. tr. of Ficinus. The next edition was that of D. Franciscus Flussas Candalla, in both Greek and Latin, Bordeaux, 1574. The editor in his preface acknowledges obligations to Joseph Scaliger, who was then a young man.

The remains of Hermes, including fragments, formed part of a great work by Franciscus Patricius (Cardinal Francesco Patrizzi), entitled *Nova de universis philosophia*, which was published at Ferrara in 1591 and at Venice in 1593. Patricius changed the order of the pieces in the *Poemander*, with a view to improving the sequence of thought. The edition of Hannibal Rossellius appeared, according to Fabricius, at Cracow, in 1586, and was reprinted at Cologne in 1620.² In it Candalla's text of Hermes is accompanied with what Fabricius describes as a vast and foolish commentary. After this there was no edition of the *Poemander* until that of Gustavus Parthey, Berlin, 1854, which, as the editor remarks, was brought out at a time when the researches of Egyptologists were having the twofold effect of establishing, on the one hand, the vast antiquity of Egyptian history, and, on the other, degrading works for which that antiquity was claimed to the times of the Ptolemies or the Romans.

Next in importance to the *Poemander* is the *Asclepius*, which exists only in a Latin tr. attributed to Apuleius. It may be read in the Teubner edition of that author by Paul Thomas, Leipzig, 1908. This dialogue was designedly excluded by Flussas from his edition of Hermes, on the ground that the work of a divine philosopher had here been tampered with by an impious pagan. The *Asclepius* in its Latin form was known to St. Augustine, who, in his *de Civitate Dei* (viii. 23–26), has long quotations from it which are verbally exact. St. Augustine does not say that this translation is the work of Apuleius, though he has occasion to mention that writer in the immediate context, which may have suggested the idea. The *Asclepius* bears on the face of it unmistakable marks of being a translation from the Greek. A few fragments of the original have been preserved to us by Lactantius, which show that the *Asclepius* is identical, so far at least as these fragments go, with the treatise mentioned under the name of λόγος τέλειος.³

Besides the fragments of Hermes preserved by Lactantius, there are others given by Cyril in his writings against Julian (A.D. 433), and some in Suidas, including a remarkable passage on the Trinity—which is nowhere else to be found. But by far the most important contribution to our knowledge of Hermes is that made by Stobæus, whose own date is uncertain, but who quotes no

¹ Mead puts the *editio princeps* in 1471, Reitzenstein in 1463, Leonhard Schmitz in 1473 at Treviso.

² Mead says (i. 12): 'This was printed at Cracow by Lazarus, in 6 volumes in folio, from 1585 to 1590,' adding that the reprint was made in 1630.

³ Lact. *Div. Inst.* iv. 6: 'Hermes in eo libro qui λόγος τέλειος inscribitur his usus est verbis'—then follows a Greek passage which will be found in Latin in *Asclepius*, 8. Again, *ib.* vii. 18: 'quod Hermes tamen non dissimulavit: in eo enim libro, qui λόγος τέλειος inscribitur, post enumerationem malorum de quibus diximus, subiecit hæc' (cf. *Asclepius*, 26).

¹ We get this number by reckoning the hieroglyphic books as 10, to which the enumeration easily lends itself.

² The following are the passages in Lactantius bearing on Hermes Trismegistus: *Div. Inst.* i. 6, ii. 10, 14, 15, iv. 6, 7, 8, 9, 13, 27, vi. 25, vii. 4, 9, 13, 18; *de Ira Dei*, 11; *Div. Inst. Epit.* 11.

³ *De Is. et Osir.* 61, p. 375 f.: ἐν δὲ ταῖς Ἑρμοῦ λεγομέναις βιβλαῖς ἰστοροῦσι γράφθαι περὶ τῶν ἱερῶν ὀνομάτων.

author later than Hierocles (fl. A.D. 450). The titles of the extracts in Stobaeus are as follows:

Ἑρμοῦ, Ἑρμοῦ πρὸς τὸν υἱόν, Ἑρμοῦ ἐκ τοῦ πρὸς Τάτ, Ἑρμοῦ ἐκ τῶν πρὸς Τάτ, Ἑρμοῦ ἐκ τοῦ πρὸς Ἀσκληπιόν, Ἑρμοῦ ἐκ τῶν πρὸς Ἀσκληπιόν, Ἑρμοῦ ἐκ τῶν πρὸς Ἀμῶν, Ἑρμοῦ ἐκ τῶν πρὸς Ἀμμῶνα, Ἑρμοῦ ἐκ τῶν πρὸς Ἀμμῶνα πρὸς Τάτ, Ἑρμοῦ ἐκ τῆς Ἀφροδίτης, Ἑρμοῦ τρισημεγίστου ἐκ τῆς ἱερᾶς βιβλοῦ τῆς ἐπι-καλουμένης Κόρης κόσμου, Ἑρμοῦ Λόγος Ἰσιδος πρὸς Ὀρον.

Under some of the titles, especially the first and most indefinite, many extracts are given. The longest are those from 'The Holy Book which is entitled Κόρη¹ κόσμου,' and that called Λόγος Ἰσιδος πρὸς Ὀρον, which seems to be another name for the same work, part of which was found by Patricius in the monastery of Enclistra, in Cyprus.

The name of Hermes Trismegistus was one to conjure with, and many works on alchemy and all kinds of subjects were attributed to him later; but those which have now been mentioned are all that concern us. Before leaving the subject, however, we must inquire whether there is anything in these works themselves to indicate their date and authorship. No one would now dispute that they are later than Plato. Neither can it be denied that they are later than Stoicism, since, without holding the materialism of the Stoics, they show familiarity with the terminology of that school. Further, they display an acquaintance with the OT, and are, therefore, presumably later than the Septuagint. In the first chapter of the *Poemander* we encounter the phrase λόγος κυρίου; further on in the same chapter we come across a manifest but unacknowledged debt to Genesis (1²²⁻²⁸): ὁ δὲ θεὸς εὐθὺς εἶπεν ἀγῶ λόγῳ, αὐξάνεσθε ἐν αὐξήσει καὶ πληθύνεσθε ἐν πληθει, which is repeated in iii. 3. The third chapter has also the words: ἦν γὰρ σκότος ἀπειρον ἐν ἀβύσσῳ καὶ ὕδωρ καὶ πνεῦμα λεπτὸν νοερὸν. In the 'Holy Book' (Stob. *Ecl.* i. 936) we read: Εἶπεν ὁ θεὸς καὶ ἦν. In v. 6 of the *Poemander* there is a passage which might be thought suggestive of Ps 139¹²⁻¹⁶.

Let us pass on now to the NT. The statement in *Poemander*, i. 12, that 'God begat a man equal to himself' would be an extraordinary anticipation of Christianity, if it were penned before its appearance; and the words with which the same chapter ends, ὁ σὸς ἄνθρωπος συναγιάζειν σοι βούλεται, καθὼς παρέδωκες αὐτῷ τὴν πᾶσαν ἐξουσίαν, cannot but recall to us Mt 28¹⁸. In *Poemander*, ix. 3, we are reminded of Mt 13²⁵ in what is said of δαίμων (who, we are told, is separated from God): ὅστις ὑπεισελθὼν ἐσπείρει τῆς ἰδίας ἐνεργείας τὸ σπέρμα, καὶ ἐκήνησεν ὁ νοῦς τὸ σπαρὲν, μοιχείας, φθόνους, πατροτυπίας, ἱεροσυλλίας, ἀσεβείας, ἀγχνόνας, κατὰ κρημνῶν καταφορὰς καὶ ἄλλα πάντα ὅσα κακῶν δαιμόνων ἔργα. The last words, from ἀγχνόνας onwards, look like a reference to the herd of swine (Mk 5¹³), but are only a specification of different forms of suicide. The doctrine that there is none good but God in *Poem.* ii. 14 and vi. recalls to us Mk 10¹⁸, as the definition of religion in xii. 23—θρησκεία δὲ τοῦ θεοῦ μία ἐστὶ, μὴ εἶναι κακόν—does that in Ja 1²⁷, while the frequent insistence in *Poem.* i. on φῶς καὶ ζωὴ as being the nature of God naturally carries our thoughts to the Fourth Gospel. Many more such affinities with the NT might be added, but this line of argument is really superfluous. For, when in *Poem.* i. 10 we come across the word ὁμοούσιος—the great bone of contention between Arian and Trinitarian—which was first used, as far as we know, by Plotinus, the suspicion suggests itself that we are not in the first or second cent., but in the third or fourth. This impression is confirmed when we consider the subject-matter of the *Asclepius*. The lament over the decay of Egyptian religion and its prohibition as though by law,² unless we allow that this

¹ Probably κόρη here means 'the pupil of the eye'; cf.

'I am the eye with which the Universe Beholds itself and knows itself divine.'

² *Ascl.* 24: 'quasi de legibus a religione, pietate cultuque divino statuatur praescripta poena prohibitio.'

passage is really prophetic, must have been written at a time when the Galilæan had already conquered. The complaint that the most holy land, which was once the seat of shrines and temples, will be full of dead men's sepulchres is accepted by St. Augustine as directed against Christianity, and as being an allusion to the martyrs' memorials (*de Civ. Dei*, viii. 26 *ad fin.*). But, if Christianity is thus in the ascendant, the *Asclepius* can hardly have been written before the Edict of Milan in A.D. 313. Now the *Poemander* (ix. 1) refers to the τελειος λόγος, which appears to be the same as the *Asclepius*, and therefore the *Poemander* must have been written at least a little later. But Lactantius was familiar with the works of Hermes, and his death is put not later than A.D. 330. It seems, therefore, reasonable to conclude that these works were composed between A.D. 313 and 330.

That the author or authors were Egyptian does not require proof. That is evident from the respect shown to the Egyptian religion, and from the naive national vanity which, not content with making Egypt 'the temple of the whole universe' (*Ascl.* 24), confines true intelligence to its inhabitants (Stob. *Ecl.* i. 990). The acquaintance displayed with Greek philosophy is no argument against this. Philo was saturated with that philosophy, and yet remained a devout Jew. Despite the many points of resemblance in the Hermetic literature to Christianity, there is no sign of love for that religion. It is Hermes who is the preacher of repentance; it is Hermes who is the guide of human kind; it is Hermes who teaches the way of salvation. In fact, in the Hermetic writings, Egypt is bidding against Judæa for the honour of supplying the world with a religion, just as Samaria did in the Great Declaration of Simon of Gitta, who has been confused with Simon Magus.

3. Doctrines.—The doctrines of Hermes are so many and so various as to make us doubt whether they all emanate from the same mind, notwithstanding the family likeness which runs through the works. But we must not be too rigorous in our demand for consistency. Such a contradiction as that God makes all things and yet does not make evil (*Poem.* xiv. 7, 8) is so familiar to ourselves as not to call for comment in Hermes. But there are others which court attention. We are repeatedly told that the Cosmos is the Son of God (*Poem.* viii. 2, ix. 8, x. 14), and yet we read that it is πλήρωμα τῆς κακίας (*Poem.* vi. 4). This, it may be said, is a matter of comparison. But here at all events is a direct contradiction. In *Poem.* ii. 4 we have the words: ἀσώματος οὖν ὁ τόπος; in xi. 18, ὁ μὲν γὰρ τόπος καὶ σῶμα ἐστὶ καὶ ἀκίνητον. Again, the statement in x. 19, that it is not lawful for a human soul to pass into that of an irrational animal, is irreconcilable with that in x. 8, that, if a human soul continues to be evil, it retraces the way by which it had ascended from reptiles. Nor yet does the ascetic principle that one must hate one's body if one would love oneself (iv. 6) seem to consort very well with the denunciation of celibacy and the glorification of parentage (ii. 17).

The resemblance of the Hermetic teaching to Christianity is no more than skin-deep. There is, indeed, much talk about the Son of God. But, then, who is the Son of God? Sometimes he is Logos, as proceeding from Nous (*Poem.* i. 6). Anon he is Man (i. 12), not man as we know him, but an æonian Man (like that of the Valentinians), who takes after the Nous that begat him in being bi-sexual, though it is hard to understand how there can be sex in Nous. Yet again, the Son of God is the sensible universe (ix. 8), as in the *Timæus* of Plato (31 B, 92 B). The Sun is not actually called by Hermes the Son of God, but he is called 'a second God' (*Ascl.* 29; cf. Plat. *Rep.* 517 B). Instead

of comparing the Hermetic writings with Christianity, it would perhaps be more fitting to describe them as pagan Gnosticism, or Gnosticism minus Christianity.

If we were asked what are the views of Hermes as to the problem of evil, a variety of answers would have to be given. In one place (*Poem.* xii. 3) we have the Cynic answer that every disease of the soul arises from pleasure; in another (vii. 2) the body is denounced as the source of evil; and love of the body, we are told, is the cause of death (i. 18). Then, again, it appears that good and passion (*πάθος*) are mutually exclusive, like day and night (vi. 2), and that passion is inseparable from *γένεσις*, gathering on it, like rust on iron or dirt on the body (xiv. 7). All these answers perhaps come in the end to the same thing; but we seem to be entering on a different range of thought when we are told that evil thoughts are prompted by demons (ix. 3, 5), or, as they are called in *Ascl.* 25, 'nocentes angeli.' It is the voice of Persia, not of Greece, that speaks here. But, however evil comes about, one thing is taken for granted, that God did not make it (*Poem.* xiv. 7). Moreover, evil is confined to earth; it is blasphemy to say that it attaches to the whole cosmos (ix. 4). Further, the religious man (*θεοσεβής ἄνθρωπος*) turns evil into good, so that the things which are evils to others are good to him (ix. 4).

What are the views of Hermes about God? They are polytheistic, pantheistic, and monotheistic. The stars in heaven are manifest gods, and most manifest among them is the Sun, who is larger than land and sea (*Poem.* v. 3). But besides these there are *δαίμονες*, who are of an immortal nature, to which man can attain. By a bold doctrine room is left by Hermes even for the popular religion. Man, he says, has made gods in his own image, even as the Father and Lord made the heavenly gods in His (*Ascl.* 23). 'You mean statues, I suppose,' says his auditor Asclepius, who is rebuked for his want of faith.

'Statues,' Hermes goes on, 'endowed with life and sense and spirit, statues that foreknow the future, and that declare it by divination, prophecy, dreams, and in many other ways, statues that cause and cure sicknesses in men, and dispense sorrow or joy according to desert' (*Ascl.* 24).

The reason why statues possess these marvellous powers is because the souls of *δαίμονες* or angels have been invoked into them. In support of his doctrine, Hermes appeals to the benefits that Isis bestows when she is propitious and the harm she does when she is angry. The passion of anger, he remarks, is natural to such terrene and mundane gods, who have been made and composed by men out of the two natures of matter and spirit (*Ascl.* 37). This theory, that statues were the abode of *δαίμονες*, was eagerly accepted by the Christians, subject to the proviso that they were bad ones—*δαίμονες*, in fact, not *δαίμονες*.

Side by side with this polytheism runs a pantheistic strain. When we read, 'Thou art whatever I am, thou art whatever I do, thou art whatever I say' (*Poem.* v. 11), we might fancy that we have in our hands the book of some Indian philosopher. Again, we have the declaration, 'God is himself what he makes.' All things, we are told, are living beings (*ζῶα*), and He is the one life (*ἡ ζωή*) of all (xi. 14). In xii. 22 we have the explicit declaration—*καὶ τοῦτό ἐστιν ὁ θεός, τὸ πᾶν*. Under this pantheistic monism there breaks out a dualism, which is again resolved into a unity. Search the whole world through, says Hermes, in the height and depth thereof, and you will find but two things: (1) the maker (*ὁ ποιητής*); (2) the product (*τὸ γινόμενον*). And yet these two are in a manner one. Each is relative to the other. The maker can no more exist without the product than the product can exist without the maker. This doc-

trine has recently made its appearance in modern theology. Did Hermes owe it to ancient Egypt?

Many and various are the attempts in Hermes to define the essence of God; but there is no real inconsistency between them. Thus in one place we are told that 'the essence of God is *τὸ καλόν*.' But, then, *τὸ καλόν* is identified with *τὸ ἀγαθόν* (*Poem.* vi. 4), so that we can pass to the equation God = goodness—*τὸ ἀγαθόν αὐτὸς ἐστὶν ὁ θεός δει* (vi. 1). But, further, *τὸ ἀγαθόν* is identified with *τὸ ποιητικόν* (x. 3), which builds us a bridge to another definition: 'The essence of God is to engender and make all things' (v. 9), in agreement with which we are told in another place that 'His one glory is to make all things, and this is, as it were, the body of God, to wit, making' (*ἡ ποίησις* [xiv. 7]). But, again, we are told that to will and to do are one with God (*Ascl.* 8), which enables us to pass on to another definition: 'The essence of God is to will all things to be' (*Poem.* x. 2). This, then, is how Hermes at his highest would have us think of God, as an ever-operative good will, bringing all things into being. Goodness is the only positive attribute of God.

'God is not mind (*νοῦς*), but the cause of there being mind; he is not spirit, but the cause of there being spirit; he is not light, but the cause of there being light' (*Poem.* ii. 14).

Hermes even hesitates to predicate being of God, since He is something behind and beyond being (ii. 5, vi. 4, xii. 1; cf. *Plat. Rep.* 509 B).

LITERATURE.—The successive editions and translations of Hermes have been mentioned in the article. The following works may be added: J. A. Fabricius, *Bibliotheca Græca*, Hamburg, 1790-1809, lib. i. cc. 7-12, vol. i. pp. 46-85; L. F. O. Baumgarten-Crusius, *de Librorum Hermeticorum origine atque indole*, Jena, 1827; L. Ménard, *Étude sur l'origine des livres hermétiques*, being the introd. to his tr. of *Hermès Trismégiste*, Paris, 1866; R. Pletschmann, *Hermès Trismégistos, nach ägypt., griech., und orient. Überlieferungen*, Leipzig, 1875; R. Reitzenstein, *Potmantes*, Leipzig, 1904; G. R. S. Mead, *Thrice-Greatest Hermes*, 8 vols., London, 1906; W. Kroll, in *Pauly-Wissowa*, viii. (1913) 792-823.

ST. GEORGE STOCK.

HERRNHUTTERS.—See MORAVIANS.

HERODOTUS.—Among the great works of genius produced in Athens during the age of Pericles, the *History* of Herodotus holds a place beside the creations of Phidias and the dramas of Sophocles. Even in antiquity it earned for its author the title of 'the father of history' (*Cic. de Leg.* i. 1). Previous writers of history, the so-called logographers, approximated in their descriptive methods to the Epic. They recorded the founding of cities, the genealogies of eminent families, the customs and institutions of particular peoples, and the geographical curiosities of foreign countries, but they essayed no deeper inquiry into the inner relations of things and events. Herodotus was really the first to undertake the task of portraying a historical movement of far-reaching importance upon a uniform plan, into which at the same time he might work the results of his own investigations over a wide field.

1. Life.—Of the historian's life we know but little. Suidas gives the names of his parents as Lyxis and Dryo (or Rhoio). He was born, probably c. 484 B.C. (*Plin.* xii. 18; *Aul. Gell. Noct. Att.* xv. 23; *Diels, Rhein. Mus.* xxxi. [1876] 48), at Halicarnassus, a town in Caria which previously belonged to the Dorian Hexapolis (*Herod.* i. 144, ii. 178; cf. vii. 99); here, however, as the inscriptions show, the prevailing dialect was not Doric but Ionic. He came of a distinguished (*τῶν ἐπιφανῶν*) and noble family, as appears from his having a *γενεαλογία* (ii. 143; cf. *Ed. Meyer, Forschungen zur alten Gesch.*, Halle, 1892-99, i. 193, n. 1). He was a cousin or nephew of the epic poet Panyasis (*Suidas, s.v. Πανύσις*), with whom he resided for a long time in the island of Samos, and who probably exercised an influence upon his education and his mode of

thought. At the time of the Persian campaign under Xerxes, Halicarnassus, with the islands of Cos, Nisyros, and Calydna, formed a small tributary State, ruled by a queen named Artemisia, of whom Herodotus writes in terms of high admiration (vii. 99, viii. 68 f., 93, 101-103). Under Lygdamis, her son or grandson, however, the city became involved in turmoils, in the course of which Panyasis was murdered by the tyrant.

That the residence of Herodotus in Samos extended over several years appears from certain features in his work—his familiarity with the topography, the monuments (iii. 60, ii. 182), and the history (iii. 39 ff., 120 ff., 139 ff.) of what was in his day a powerful naval State. It is doubtful whether he had any share in the overthrow of Lygdamis, which took place prior to 454 B.C. Thereafter he proceeded to Athens, and, as a distinguished citizen of an important federal city, came into intimate relations with Pericles, at that time the guiding spirit in Athenian politics, and with Sophocles. It is true that we have no express record of these friendships, but the historian's own pages bear unmistakable evidence of them. His intimacy with Pericles is to be inferred from his conviction of the importance of Athens for the Hellenic world, and his appreciation of its constitution, as well as from the manner in which he defends the Alcmaeonidæ, the family of Pericles, and disparages their assailant, Themistocles, the greatest of Athenian statesmen. Pericles himself, indeed, is mentioned but once in the *History*, but the graceful reference is significant enough. Herodotus, by way of extolling the maternal line of Pericles, narrates the wooing of Agarista, the daughter of Cleisthenes, tyrant of Sicyon (vi. 126 ff.); he tells that her granddaughter and namesake was married to Xanthippus, the victor of Mycale, and that 'when she was with child she had a dream in which she fancied that she was delivered of a lion, and a few days afterwards she gave birth to Pericles' (vi. 131). The historian's friendship with Sophocles may be inferred from the fact that the latter incorporated in his dramas several narratives which he had learned from Herodotus (cf. ii. 35 with *Œd. Col.* 337 ff.; iii. 119 with *Antig.* 905 ff.; i. 32 with *Œd. Rex*, 1528 ff. and *Trach.* 1 ff.); and there is, moreover, a profound affinity between the views of the two writers. It should be noted, however, that the elegy on Herodotus, the opening words of which have come down to us (Plut. *An seni res publica gerenda sit*, ch. iii. p. 785 B),

Ἦδιον Ἡροδότῳ τούτῳ Σοφοκλῆς ἐτέων ὡν
πέντ' ἐπὶ πενήκοντ' < ἐξάκις ἐξάττει >.

was not composed by Sophocles.

It is probable that Herodotus, like many other prominent men of his time, took part in the founding of Thurii in 445 B.C.—a scheme set on foot by Pericles; he must, at least, have proceeded thither shortly afterwards. But he did not remain long in the new colony, as the ideals which the founders hoped to realize were shattered by dissensions among the settlers themselves. Certain scholars (e.g. Meyer, *Forschungen*, i. 196) are of opinion that Herodotus called himself a Thurian, and that Aristotle's version (*Rhet.* iii. 9) of the opening words of his book (*Ἡροδότου Θ[ο]υριίου ἡδ' ἱστορίας ἀπόδειξις*) is correct; but others dispute this view, and rightly so, especially as the words in question have been transposed—against the MS tradition—so as to form a hexameter (Stein, 'Introduction,' p. liv). Suidas also informs us that Herodotus was buried in the market-place of Thurii. The inscription commemorating him is given by Steph. Byz. (s.v. Θούριοι) as follows:

Ἡροδότῳ Δύξω κρύπτει κόνην ἦδε θανάοντα
ἴεδος ἀρχαίης ἱστορίας πρύτανιν,
Δωριέων βλαστόντα πάτρης ἀπο' τῶν γὰρ ἀτλήτων
μύμον ὑπεκροφυγῶν Θούριον ἔσχε πάτρην.

Suidas is also our authority for the report that he fled from Halicarnassus on account of the jealousy of his fellow-citizens; but this does not agree with the facts. According to another report, Herodotus travelled from Thurii to the Macedonian court, and died at Pella (Suid. s.v. Ἡρόδοτος and Ἑλληνικός). As a matter of fact, we cannot say when and where he died. All that we can definitely ascertain from his own pages is that he returned from Thurii to Athens, and that the latter city was his home till the outbreak of the Peloponnesian War (A. Kirchhoff, 'Ueber die Abfassungszeit des herodotischen Geschichtswerkes,' in *ABAW*, 1868, p. 16 ff.). His travels in Asia and Egypt, and the composition of his *History*, fall in the interval between his return from Thurii (c. 440) and his death (c. 425).

2. Travels. — The narrative of Herodotus is occupied to a considerable extent with what he had learned in the course of his travels, upon which he may have started when comparatively young. Just as he explored Samos, so he may, with that island, as also the city of his birth, as a centre, have become familiar with the adjacent districts, and, in course of time, with the Ægean Islands and the coast of Asia Minor. We know for certain that he visited the hallowed places on the mainland of Greece, as, e.g., Thermopylæ (vii. 198 ff.) and Plataea (ix. 25, 49 ff.). He sought information from the priests at Dodona (ii. 52), and in Delphi he heard about the fall of rock that saved the temple from being plundered by the Persians (viii. 39); here, too, he was shown the numerous and magnificent votive gifts belonging to the sanctuary (i. 20, 51 f., iii. 57), and gained a knowledge of both Greek and Lydian history as read by the Delphic priesthood. In Sparta he made investigations regarding the earlier history of Lacedæmonia, and with reference to the Spartan expedition against Samos he names as his informant the grandson of one who had taken part in it (iii. 55). In his further travels northwards he was initiated into the mysteries of the Cabiri in Samothrace (ii. 51), and inspected the mines of Thasos (vi. 47). He seems to have visited the Macedonian court, as he speaks repeatedly of the royal family, and supports its claim to be of Hellenic descent (v. 22). He then made his way towards the Black Sea through the Hellespont, the Propontis, and the Bosphorus, gaining some knowledge of the more important cities on the route (iv. 14). Proceeding by way of Istria (ii. 33), he reached Olbia, visiting the fertile plains in the immediate neighbourhood (iv. 52 f., 81), and gathering information regarding the formidable peoples of Scythia. The Sea of Azov (iv. 86), the Crimea (iv. 99), Colchis (ii. 104), and—on the south coast of the Euxine—the city of Themiscyra (iv. 86) are also known to him. He likewise made a journey to Sardis, probably from Ephesus (ii. 148), and describes from his own observation the monument of Alyattes in the former city (i. 93). His account of the royal road between Sardis and Susa, on the other hand, is not based upon personal knowledge (v. 52). Susa and Babylon were probably visited by way of Syria. He writes of Babylon in considerable detail (i. 178 ff.), and his having been in Susa is shown by the narrative (vi. 119) regarding Ardericca; but his description of the royal castle of Agbatana, the capital of Media, makes it evident that he had not been there (i. 98).

In his visit to Egypt, Herodotus travelled from Canopus to Elephantine, and then back again to Pelusium. It is a very singular fact that he should say nothing of the great temples of Thebes; he refers only incidentally to the temple of Amon there (ii. 42, 143). Whether he passed from Egypt to Syria cannot be determined, but at all events he describes the route from Kadytis (Gaza) by way

of Lake Serbonis as one who had traversed it (iii. 5). He must also have visited Cyrenaica, for he speaks of its capital from personal observation (ii. 181), and gives an apt description of the terrace-like configuration of the country (iv. 199). It was here probably that he obtained his information regarding the Libyans and the interior of Africa. But his accounts of the peoples inhabiting the region between Egypt and the Greater Syrtis are more to the point than what he says of those living further to the West. He may have gained a knowledge of Southern Italy and Sicily while in Thurii. He writes also of the Etruscans, the Ligurians, and the Venetians, but makes no mention of Rome or the Latins.

There has been much discussion as to the period of his life in which Herodotus undertook these journeys. But a slight consideration of the political circumstances affords us a definite clue. As a citizen of an insurgent Persian city, he could not well have travelled in Persian territory before the opposing parties came to terms. This was brought about by the so-called Cimonian peace (448-447 B.C.). At that time, however, the interest of Herodotus was fixed upon Thurii, and it was only after he had left the colony and returned to Athens that he was in a position to begin his extensive pilgrimages. Nor, again, could he have travelled in Egypt before the conclusion of peace. Athens, however, was still lending assistance to Amyrtæus in 449 B.C. But it is clear from Herodotus' account of Egypt that the days of commotions and conflicts were long past. For these reasons Meyer would assign the longer journeys to the years between 440 and 430 B.C. (*Forschungen*, I. 155 f.; in II. 222, more definitely, 438-432 B.C.).

3. His sources.—On these numerous and extensive journeys, Herodotus was constantly adding to his store of knowledge. From the most likely persons, as, e.g., the learned men (λόγιοι) of Persia and the priests of Egypt, he sought information regarding the history of their several countries. In many parts he found interpreters (διγλωσσοί) who acted as intermediaries between Greeks and non-Greeks. The numerous 'tales' which he incorporates in his work were derived from professional story-tellers (λογοποιοί), who were to be found plentifully in Greek-speaking lands; such are, e.g., the stories of the marriage of Agarista (vi. 126 ff.), of the fortunes of the Cypselid dynasty (iii. 48 ff., v. 92), of Cræsus, and of Atys and Adrastus (i. 34 ff.). To the principles on which he judged what he heard he refers in two passages as follows: ii. 123, ἐμοὶ δὲ κατὰ πάντα τὸν λόγον ὑπόκειται, ὅτι τὰ λεγόμενα ὑπ' ἐκάστων ἀκοῆ γράφω; vii. 152, ἐγὼ δὲ ὀφείλω λέγειν τὰ λεγόμενα, κείθεσθαί γε μὲν οὐ παντάπασιν ὀφείλω. But he also availed himself of documents, precisely as do the historians of the present day. He twice makes reference to Hecataeus of Miletus—the most eminent of the logographers—as his authority (ii. 143, vi. 137). In other passages he challenges his statements, especially as regards geography, though without naming him; or else he simply reproduces his narratives (Diels, 'Herodot u. Hekataios,' *Hermes*, xxii. [1887]; Meyer, *Forschungen*, I. 183 f.). Of his indebtedness to other logographers we have no clear proof; it would probably be confined to a few dates and memoranda, inasmuch as such sources, and notably the *γενεολογίαι*, contained little but legendary history. The story of Democedes (iii. 129 ff.) is probably based upon a written narrative. In the account of the Persian expedition under Xerxes, moreover, Meyer (*Forschungen*, II. 231 f.) recognizes a documentary original in the section extending from the massing of the army and its departure from Celænæ to its arrival in Therma, but admits that Herodotus has here made many additions from his own knowledge. With the list of peoples given in this section are closely connected the list of satrapies (iii. 90 ff.), and the account of the royal road from Sardis to Susa (v. 52 f.); and they are presumably all derived from the same source.

4. The purpose of his history.—That Herodotus delivered lectures on history may be inferred from

references in his own pages (i. 193, iii. 80, vi. 43), and also from Thuc. i. 21 f. Plutarch (*de Herodoti Malignitate*, xxvi.) says that, according to Diyllus, he received ten talents as a remuneration from the Athenian State, and later writers assert that this was given as a honorarium for a public recitation of his *History*. Meyer (*Forschungen*, I. 200 f., II. 229), however, is of opinion that this large sum was granted him in recognition of his eminent services on behalf of Athens. Certainly he composed his work with the one object of giving prominence to what Athens had accomplished for Greece; and he did this, moreover, at a time when that city's policy was exposed to the fiercest criticism. He wrote at the beginning of the decisive conflict between Athens and Sparta. Only a knowledge of the past could furnish the criterion for a true judgment of the present. But at the same time the writer's verdicts and descriptions are coloured by the conditions of his own day. Thus, the conduct of Thebes and Corinth at the time of the Persian wars is set in a very unfavourable light; that of Thessaly and Argus is palliated; Sparta is treated with a touch of irony; the Alcmaeonidae are, for Pericles' sake, exonerated from censure. It is in all respects the Athenian point of view that finds expression in his account of the wars, and yet it would be wrong to charge him with intentional misrepresentation. He regarded it as his duty to relate what was reported to him (vii. 152). His impression of the actors in the drama he seeks to exhibit in their speeches and colloquies. But these, again, afford him an opportunity of giving utterance to the ideas of his day, and of discussing the best type of government. In military matters he does not speak as an expert, but, without any real comprehension of things, simply reproduces popular tradition. Hence his incredible figures, the purely imaginary character of which was first demonstrated by H. Delbrück (*Die Perserkriege u. die Burgunderkriege*, Berlin, 1887).

It has been frequently asserted that Herodotus did not carry his work to its intended conclusion, but there is nothing to show that this was the case. His purpose was to write the history of the Persian wars, and these ended with the battle of Mycale and the capture of Sestus in 479 B.C.; the aggressive wars of the Greeks against the Persians began in 478 B.C., and are not to be reckoned among the Μηδικά. He certainly begins somewhat further back; he depicts the conflicts between Greeks and Barbarians; and within these bounds he finds it possible to incorporate the abundant results of his own inquiries and researches (iv. 30: προσθήκας γὰρ δὴ μοι ὁ λόγος ἐξ ἀρχῆς ἐδίδητο). It is unnecessary to suppose that he had published these results in previous books, and tradition does not lend the slightest support to the idea. The only separate work of which he speaks is the projected Ἀσσύριοι λόγοι (i. 184); but this was almost certainly never written.

5. His 'Weltanschauung.'—Herodotus knows nothing of historical criticism, nor does he think of tracing out the ultimate forces from which historical phenomena spring. He proposes simply to relate what he saw and heard, and to do so with a mind clear of preconceptions. But he regards as true only what he had learned from experience or witnessed with his own eyes. Thus he refuses to believe in the Hyperboreans (g.v.), as there is no credible evidence for their existence; if they did exist, there would also be Hypernotians (iv. 36). Similarly, he will not accept the report that the Phœnicians in their circumnavigation of Africa had the sun upon their right hand (iv. 42). He rejects the idea that there is a race of men with but one eye (iii. 116), though he speaks else-

where of the one-eyed Arimaspi without offering any objection (iv. 13, 27). He repudiates the hypothesis of an ocean flowing all round the world, saying that the name was invented by Homer or some other poet (ii. 23, iv. 8, 36), and he utters a similar verdict regarding the river Eridanus and the Cassiteride Islands (iii. 115).

He surveys the affairs of the world and the institutions of mankind with an impartial eye, though he adheres to many traditional errors and misconceptions. He does not take it ill that men should regard their own customs and practices as the best, and says that none but a madman would make sport of foreign usages (iii. 38). But experience had also taught him that the destinies of men are influenced by a supernatural power. The gods exist, and they intervene decisively in the affairs alike of individuals and of nations. It was the Divine wrath that pursued the sons of Sperthias and Bulis to the death, so that the crime of slaying heralds should be duly expiated (vii. 137). It was Demeter herself who, at the battle of Plataea, prevented the fleeing Persians from taking refuge in her sacred grove, thus punishing them for their having burned her sanctuary in Eleusis (ix. 65). 'For great crimes great penalties are inflicted by the gods' (ii. 120). But, even where there is no crime at all, the gods ordain evil for mortal men: *χρῆν γὰρ Καρδαύλῃ γενέσθαι κακῶς* (i. 8). The higher powers keep jealous watch lest man should too proudly exalt himself, and they bring him low even when he is free from guilt (vii. 10e). Xerxes was impelled by a vision of the night to make war upon the Greeks, even against his will, and was thus driven to destruction (vii. 12 ff.). Amasis fears the envy of the gods (iii. 40). And not in dreams only, but also by oracles, do the gods manifest their unalterable designs. As the oracle of Delphi declared (i. 13), Croesus atoned for the offence of his fifth ancestor (i. 91). It was decreed by the oracle that the whole of Attica should fall into the hands of the Persians (viii. 53). The gods are lords of all; even the innocent must undergo the severest afflictions, and thus no one should be called happy till he is dead, and death is better than life. This interpretation of life is precisely what we find in Sophocles; a profound and sincere piety animates both the historian and the poet (cf. H. Fohl, *Tragische Kunst bei Herodot*, Borna-Leipzig, 1913).

With philosophy as such Herodotus had no direct concern. He refers to the philosophers only in so far as their ideas fall within the circle of ordinary knowledge. Thus he mentions the Orphic-Pythagorean doctrine of metempsychosis merely because that belief is met with among other peoples, and he traces it to Egypt. He refers to the eclipse predicted by Thales, and to the gnomon and Anaximander's map of the world. He mentions and discusses the various theories regarding the inundation of the Nile. Further, in his pages we may recognize the influence of the criticisms directed against the popular religion by Xenophanes and Heraclitus. His conception of history likewise is rationalistic, though not always to the point; here he follows his forerunner Hecataeus. Faith and criticism commingle in him ('mélange de scepticisme et de foi' [Hauvette,

Herodote, historien des guerres médiques, Paris, 1894, p. 35]); and he prays that he may not on that account incur the displeasure of gods or heroes (ii. 45). In such rationalistic criticism we may distinctly trace the effects of the Sophistic philosophy of the time, and these effects may also be discerned elsewhere. It is altogether likely that Herodotus was personally acquainted with the more prominent Sophists; Protagoras, too, had gone to Thurii in 445 B.C.; and Herodotus wrote his book in Athens between 432 and 425 B.C.—at a time, that is to say, when the leading Sophists were resident there. Even the style shows signs of Sophistic influence. Herodotus has a liking for pointed antithesis, and in his hands dialogue has already become an art. This has been demonstrated in detail by W. Nestle (*Beilage zum Programm des evangelisch-theologischen Seminars in Schöntal*, 1908), who also shows that the Sophistic theories of the nature and origin of civilization, of language, and of religious and political institutions were matters of eager interest to Herodotus, and have left their mark upon the composition of his work. Nestle asserts further that Herodotus had assimilated certain specific ideas from Protagoras, Prodicus, and Hippias, and defends his view in *Philol.* lxx. (new ser. xxiv. [1911]) 242-273, where he repels objections and criticizes other theories.

The outstanding quality of Herodotus as a writer consists in his marvellous gift of narrative, and reveals itself in his delight in all the curious and interesting lore which he had accumulated and so deftly reproduces; hence his work has never lost the charm which it exercised from the very first.

6. His dialect.—Herodotus wrote his *History* in the Ionic dialect, the prevailing literary language of his time. The knowledge of this particular type of Greek soon died out, and many spurious forms were introduced into his text by the copyists. This 'Hyperionism' made its effects felt to a remarkable extent, and has been fostered by modern editors. The inscriptions and the poets furnish us with the authentic forms. The older literature relating to this question is given in R. Meister, *Die Mimiamben des Herodas*, Leipzig, 1893, p. 771 f.; cf. also H. W. Smyth, *The Sounds and Inflections of the Greek Dialects: Ionic*, Oxford, 1894; O. Hoffmann, *Die griech. Dialekte*, iii., 'Der ionische Dialekt,' Göttingen, 1898; A. Fritsch, in *Verhandlungen der deutschen Philologen u. Schulmänner in Bremen*, Leipzig, 1900, p. 158 ff.

LITERATURE.—In addition to the works cited in the course of the article, see Th. Gomperz, 'Herodotische Studien,' *SDAW*, 1883, *Griechische Denker*, i.³ (Leipzig, 1911) 208 ff.; Ed. Meyer, *Gesch. des Altertums*², Stuttgart, 1909, iii. 242 ff., iv. 126 ff.; Christ-Schmidt, *Gesch. der griech. Lit.*⁶, Munich, 1912; H. Kallenberg, 'Jahresber.' in *Zeitschr. für das Gymnasialwesen*, Berlin, 1877-1912; v. Floigl, *Cyrus und Herodot*, Leipzig, 1881; J. Nikel, *Herodot und die Keilschriftforschung*, Paderborn, 1896 (Eng. adaptation by H. Tolman and J. Stevenson *Herodotus and the Empires of the East*, New York, 1899). Modern critical edd.: H. Stein, 2 vols., Berlin, 1869-72, smaller ed., 1884; H. Kallenberg, 2 vols., Leipzig, 1885-86 (i.², 1906); A. Holder, 2 vols., do. 1886-88; C. Hude, Oxford, 1908; edd. with notes, H. Stein, Berlin, many issues of individual books; A. H. Sayce, books i.-iii., London, 1883; R. W. Macan, books iv.-vi., London, 1895, books vii.-ix., 1908; W. W. How and T. Kells, book ii., 2 vols., Oxford, 1912; A. Wiedemann, Leipzig, 1890, Eng. tr., G. Rawlinson³, 4 vols., London, 1875; F. Jacoby, 'Herodotos,' in *Pauly-Wissowa*, Supplement ii. [1913] 205-520. A. FRITSCH.

HEROES AND HERO-GODS.

General and primitive (A. C. HADDON), p. 633.

American (A. F. CHAMBERLAIN), p. 637.

Babylonian (T. G. PINCHES), p. 642.

Buddhist.—See SAINTS (Buddhist).

Celtic.—See CELTS.

Chinese (P. J. MACLAGAN), p. 646.

Egyptian (K. SETHE), p. 647.

Greek and Roman (A. C. PEARSON), p. 652.

Hebrew (G. MARGOLIOUTH), p. 656.

Indian (H. JACOBI and W. CROOKE), p. 658.

Iranian (L. H. GRAY), p. 661.

Japanese (M. REVON), p. 662.

Muslim.—See SAINTS (Muslim).

Slavic (J. MACHAL), p. 664.

Teutonic (M. E. SEATON), p. 667.

HEROES AND HERO-GODS (General and primitive).—In dealing with hero-cults, one must distinguish between a *manes*- or ancestor-cult arising out of beliefs in ghosts and spirits and the worship which in course of time may come to be offered to the personages of astral and other myths. It is with the latter that the present article is concerned, and not with mythology as such.

The term 'hero' is usually applied to one who stands out from among ordinary mortals by his superior quality or qualities, conspicuous bravery or sustained power of endurance being the distinguishing features. But there is a large class of persons in oral tradition and literature who stand out from their fellows by reason of their inventiveness, or moral or intellectual qualities, by the introduction of new cults, and, above all, by what they have done to improve the various conditions of human existence—these are usually spoken of as 'culture-heroes.' Amongst the renowned dead there are all gradations in oral tradition—from the men who are recognized as mere mortals to those of such transcendent powers that they may be classed as demi-gods or godlings; indeed, it is often impossible to say where the possession of true godship begins. Literary records, however, have been so thoroughly worked over in many cases that a more precise classification is here generally possible.

A hero is nearly always regarded as the spirit of a dead man. His origin may be unknown; his mortal birth may be recorded; or he may have had an equivocal begetting, being the son of a virgin, or of partly divine and partly human parentage; or, again, he may be the son of supernatural parents; but in all cases he is supposed to have lived as a mortal amongst mortals and died as they do.

The belief in the continuity of life may be taken as universal, death being merely an episode between two phases of continuous existence. Under normal conditions the individual possesses the same character after as before death; and, since most persons are friendly to their kinsmen and willing to help them, so spirits, though theoretically resident in a land of their own, are ready to assist those who have not passed through the intermediate state of death. The practice of appealing, especially when danger is imminent, to the spirits or ghosts of men is very widely spread among various peoples. This appeal may take the form of an invocation or of a prayer, or simple rites may be performed, generally at stated times; thus an incipient worship may be performed which could readily pass into a definite cult. At what stage this process is interrupted depends largely upon the social and religious institutions of the people in question; and the extent to which the recognition of heroes attains may vary from time to time, as is shown by the progressive vulgarization of hero-cults by the Ancient Greeks. The hero-cult of Ancient Greece resembled that of the chthonian divinities and of the dead, and was quite distinct from that of the later Olympians. A blending of the two is seen in the case of Herakles:

'So then my inquiries show clearly that Heracles is an ancient god, and those of the Hellenes seem to me to act most rightly who have two temples of Heracles set up, and who sacrifice to the one as an immortal god and with the title of Olympian, and make offerings of the dead to the other as a hero' (Herodotus, ii. 44 [Macaulay]). 'The Teutonic heroes are, in the main, historical personages, never gods; though, like the Greek heroes, they are sometimes endowed with semi-divine attributes or interpreted as symbolical representations of natural forces' (*EBr*¹¹ xiii. 275).

The question more immediately before us is to determine as far as possible some of the ways in which hero-cults may have arisen among savage communities, but the evidence is by no means so extensive as might have been surmised. Personages who may be described as heroes are plentiful, but their worship, or a cult in connexion with them, is rare.

A people in a purely totemic stage of culture, e.g. the Australian natives, can scarcely originate a *manes*-cult, still less a hero-cult; and, whatever may have been the extraneous cultural influences that have penetrated into Australia, there has not been a development of either of these cults. The case is, however, different for Torres Straits; and what occurs there is given in some detail, as it seems to bring out some suggestive points. Further information will be found in vols. v. and vi. of the *Reports of the Cambridge Exped. to Torres Straits*.

Among the characters in the folk-tales of the Torres Straits Islanders all grades of individuals are found, from men to demi-gods. About some who were spoken of as men, nothing, or very little, is narrated that is miraculous, they being simple warriors, or people who had adventures. There are others who could transform themselves into animals, or to whom something supernatural happened. Many were transformed into stars, stones, animals, or other objects. None of these individuals affect the social or religious life of the natives to any great extent; they merely serve to point a moral or to explain certain objects or events. These more especially were relegated to a remote past, and some of them were spoken of by the Western Islanders as *ad* or *adi*. This word, according to S. H. Ray (*Reports*, iii. [1907] 89), now signifies a legend or honorific title; but probably it had the same significance as the term *ad* of the Murray Islanders (of the eastern group), which implies anything old and traditional, with the idea of a sanctity that is associated with ancient wont—thus certain of their folk-tales are *ad*, and all sacred and magical stones or objects are *ad*.

This idea of sanctity is also connected in varying degree with the culture-heroes. These belong to different categories. Some introduced improved methods of horticulture or fishing, and it is in this group that the marvellous begins to be prominent. The superior fertility of Murray Island is accounted for by the introduction of garden plants from Badu and Moa by two heroes—which at the same time explains the impoverishment of those two western islands. Two other heroes of the Murray Islands built the local fish-weirs, and taught variations in speech to certain other islanders, and they were

said by some to have instituted the shrine that makes coco-nuts abundant (*u zogo*). A great culture-hero for vegetable food came from New Guinea, whither he returned after visiting the western and eastern islands of Torres Straits; he instructed some islanders in language, stocked several reefs with the much-prized cone shell, and notably introduced plants useful to man. He was a very amatory person, and valuable economic plants sprang up as the result of his amours—one of the many examples of the close association in the mind of savage peoples of the sexual act with agricultural fertility. In the islands he was generally called Sido, but there appears to have been some confusion between Sido and Soido. Sido, as Landtman informs us (*Festschrift til Ed. Westermarck*, p. 59), was a great and highly praised hero in his lifetime, though he became a mischievous character during his wanderings after death. His was the first death, which was also a murder, and all men must die and follow the route of his wanderings; eventually he seems to have become the chief of the after-world. Soido is essentially an agricultural hero.

Certain death-ceremonies were introduced from the neighbouring mainland of New Guinea into some of the islands by two culture-heroes, Naga and Waiat, the relative importance of whom differs according to the island from which the information was obtained. Naga knew how to make masks in the form of animals, and instructed men in singing and dancing and in everything relating to the *kwod*, or ceremonial ground; he is stated to have lived on Nagir. Waiat, who, according to one legend, lived on Mabuiag, stole a famous fish-mask from Naga. Waiat was represented by a rude and imperfect wooden image which was lodged in a square house on the neighbouring islet of Widal. Only old men had anything to do with the shrine, and whenever the house was rebuilt they held a special death- or spirit-dance, *zarar markai*, which was also danced by them after the usual death-dances. Waiat was described as the head or chief of the *tai*, the great funeral ceremony or death-dance, during which the people 'thought about what Waiat did.' We are told that Naga went to Uga, one of the eastern islands, where he taught the people how to perform the death-dance, and that Waiat went to the Murray Islands. According to the Murray Islanders, Waiat (as they call Waiat) introduced the *zera markai* and other death-dances. In Waier, the smallest of the three Murray Islands, Waiat was represented by a turtle-shell image of a man, which rested against the railings of a model of the platform of a canoe. No women were allowed to see these sacred objects, which were kept in a cave. There was an annual pilgrimage of all the people of Mer and Dauar, the other two islands, to the shrine; the men and novitiates were segregated on one side of the island, and the women and children on the other, this being the occasion for an elaborate initiation ceremony. The essential cult of Waiat on Waier, so far as our information goes, was of an erotic character.

Kwoiam, the warrior hero of Mabuiag, who fought natives of various islands, and even successfully and single-handed attacked a village in New Guinea, lived with his mother, her brothers and sisters, and his sister's son. This family-group constituted what may be termed the 'social unit' of a matrilineal community, the father being so unimportant that his name has not been handed down. Kwoiam is said to have had the shovel-nosed skate for his totem (*augud*), which, amongst other circumstances, points to the Kwoiam cult as being later than totemism. Kwoiam made two crescentic objects of turtle-shell, which blazed with light when he wore them at night, and which

he nourished with the savour of cooked fish. These objects were called *augud* (presumably because the natives did not know by what other sacred name to call them), and they became the insignia of the two phratries into which the totem clans of Mabuiag were formerly grouped. In this island Kwoiam was designated as *adi*, and occasionally he himself was spoken of as *augud*. In the Muralug group of islands he was regarded as the 'big *augud*,' and the '*augud* of every one in the island.' Connected with the cult of Kwoiam were two heaps of shells, called navels of the *augud*, which were constructed to show that the two *augud*-emblems originated there; and, when it was deemed necessary to fortify the latter, they were placed upon their respective navel-shrines. The cult of Kwoiam was associated with warfare, and when attacking an enemy the warriors formed in two columns, each of which was led by a headman who wore the Kwoiam emblem to which he was entitled. The moral value of the *augud* in war must have been very great, and the natives themselves recognized the fact; as one man said: 'Suppose we have not got an *augud*, how can we fight?' It is recorded that on one occasion the victorious Mabuiag men refused to continue fighting the Moa men on account of the temporary absence of the two *augud*-men. The Moa men also had magical emblems associated with Kwoiam, but these were less potent than those of Mabuiag, 'because Kwoiam belongs to Mabuiag and not to Moa.' The *augud* had to be treated with respect: in one foray a warrior in excess of zeal ran on in front of the column, but he stumbled and nearly broke his leg because he went in front of the relics, which should always go first, as Kwoiam was wont to do. Kwoiam's mother originally came from an island near Cape York. There are very consistent accounts that in his physical appearance and psychical characteristics he resembled Australians and not Papuans. He fought with an Australian javelin and spear-thrower, indeed, 'all he did was Mainland fashion'; he, his mother, and his nephew 'always kept to themselves, and were like Mainlanders.' It is said that the natives of Cape York Peninsula also talk of Kwoiam.

As Kwoiam was an inspiring feature in the life of the inhabitants of the western islands, so a group of brethren played a similar part for the natives of the central and eastern islands. The migrations and adventures of these heroes are enshrined in various legends which are current in several islands, though there is much obscurity and contradiction. The more probable version brings them from New Guinea, the other from Australia or some island to the south. According to the former version, the hero Bomai went to several islands, and during his journeyings he temporarily changed himself into various animals. On approaching Yam, he gave birth to his brothers Sigar (Sigai) and Kulka. Sigar remained on Yam, Kulka went to Aurid, and Bomai to the Murray Islands. Some versions mention a brother named Seo, who went to Masig.

According to one tale, Sigai and Maiau were the two brothers who went to Yam, and each became associated, in his animal form, with one of the two phratries. A shrine was erected to each, which consisted of a long low hut containing a turtle-shell model representing respectively a hammer-headed shark and a crocodile, and under each of these was a stone in which the spirit, the so-called *augud*, resided, and to them were attached human skulls and jaws. Outside the enclosure which screened the shrines from profane gaze were two heaps of shells which, as in the cult of Kwoiam, had a mystical connexion with the shrines, and were similarly termed 'navels of the *augud*.' The

shrines were so sacred that no uninitiated persons might visit them, nor did they know what they contained; they were aware of the existence of Sigai and Maiau, but they did not know that the former was a hammer-headed shark and the latter a crocodile; this mystery was too sacred to be imparted to the uninitiated. When the heroes were addressed, it was always by their human names, and not by their animal or totem names. Warriors would be enabled to go immune whither they liked if they sang certain songs at the shrines. They prayed as follows: 'O *Augud* Sigai and *Augud* Maiau, both of you close the eyes of these men so that they cannot see us.' There was also a navel-shrine of Sigai on Tutu (Yam and Tutu were inhabited at different seasons by the same people). Before going to fight, the men stood around it, or around those on Yam, and thrust their bows and arrows into it so that they might not miss their aim; and during the fight they called upon the names of the heroes.

Judging from the human face-mask decorated with human skulls from Aurid, which almost certainly represents Kulka, we may surmise that there was a cult of that hero there, which was probably a war-cult.

So far as the Murray Islands are concerned, it appears that Bomai, who was often spoken of as Malu, came first and was recognized as a *zogo*, i.e. something sacred; he was represented by a human face-mask, with a beard of human jaw-bones. Later, Malu arrived with a fleet of canoes from various western islands in search of Bomai. Malu also became a *zogo*, and was represented by a mask in the form of a hammer-headed shark. The foreigners exhibited certain dances in order to please their hosts, and then returned home. The Bomai-Malu cult predominated in the Murray Islands over all other cults, and the sacred men in connexion with it attained a considerable power, which they often used for their private ends. This cult had elaborate and prolonged initiation ceremonies, and appears to have been a secret society or religious fraternity which took upon itself disciplinary functions; indeed, it was very similar to some of the secret societies that are found in Melanesia.

The western and central islands are not particularly fertile, so the natives spend a good deal of their time in fishing, and there is considerable intercourse between the various islands, due to trade or warfare. Here the hero-cults developed into war-cults. The isolated Murray Islands are fertile, and the people are much given to horticulture; thus there was little inducement for the hero-cult to develop into a war-cult, and it concerned itself more with the social life of the people, and the three temporary sacred men were on the way to become priests.

Totemism was still in force in the western and central islands at the time of the arrival of the hero-cults, but it had probably already disappeared in the Murray Islands. Everywhere, but perhaps more particularly in the eastern islands, there were numerous small family or local rituals, most of which were concerned with improving the food supply. A religion then appeared which replaced in the west the indefinite communal association of a totem with its clan by a definite personal relation with a superhuman being, and it is no wonder that it spread, being carried from island to island. These cults also provided both the Western and the Eastern Islanders with a synthesis which had hitherto been lacking, as the men could now meet as members of a common brotherhood, and a feeling of intense pride in new cults was engendered.

An interesting parallel to these hero-cults of Torres Straits occurs in Fiji. The people of Viti-

Levu are divided into two groups, the Kai Veisina and the Kai Rukuruku, which trace their descent from Veisina and Rukuruku, who drifted across the big ocean and taught the people the cult associated with the large stone enclosures, *nanga*. Veisina arrived first, and where he landed the turmeric plant sprang up; where Rukuruku first placed his foot the candle-nut grew. Their followers paint themselves respectively with the yellow or black pigment obtained from these plants. When the two heroes landed, they said: 'Let us go to the Chief of Vitongo and ask him to divide his men between us that we may teach them the *nanga*, for which purpose we have come to Fiji' (Joske, *Internat. Arch. für Ethnogr.* ii. 258). The last clause points to a definite propaganda, and it is possible that a similar movement may have taken place in Torres Straits, since there is not the slightest trace in tradition or elsewhere of secular aggression.

The great mythological personages of southern Melanesia are Qat of the Banks Group, Tagaro of the New Hebrides, and certain of their brothers. Qat, who had a mother but no father, is usually regarded as a spirit (*vui*) that never was a man, though in some places he is said to have been a great man of old times. Codrington (*Melanesians*, p. 155) says:

'It is impossible to take Qat very seriously or to allow him divine rank. . . . When he is said to create, he is adding only to the furniture of the world in which he was born.'

It is related of him that he made men, pigs, trees, rocks, as the fancy took him, and also night. He was always ready to play tricks on his envious brothers, but not in malice. He disappeared by his canoe (in which were his wife, brothers, and all living creatures) being washed out to sea in a deluge. At the legendary home of Qat,

'there is still the stump of a tree which Qat cut down for his canoe; . . . men who are cutting a canoe make sacrifices at this stump, throwing down money there that their canoe may be swift and strong and never wrecked' (p. 141 f.). 'The *tataro* of the Banks' Islands, which may be called a prayer, is strictly an invocation of the dead. . . . The Banks' Islanders are clear that *tataro* is properly made only to the dead; yet the spirits, *vui*, Qat and Marawa [the spider, a friend of his] are addressed in the same way' (p. 146).

They were prayed to for success, riches, safety when at sea, and other blessings. In the New Hebrides Tagaro takes the place of Qat. In the Banks Islands and northern New Hebrides there is an institution called *Qat*, into which a rigorous secret initiation is necessary, the *Qat* itself being a very elaborate and difficult dance in which the performers wear lofty hats or masks. Codrington says that 'the name *Qat* refers to the hats and not to the *vui*' (p. 85), and he does not allude to any connexion between the dance and the spirit. It is obvious that there is yet a great deal to learn about Qat and Tagaro, and what has been stated above probably holds good for various mythical personages in Melanesia. Qat (Tagaro) apparently represents a human ghost in process of being sublimated into a pure spirit.

The case of the Polynesian cosmic hero, Maui, is a good example of the difficulty with which a hero can become an actual and worshipped deity. The Maui legends, in a complete or fragmentary form, are found all over Polynesia and in parts of Melanesia and Micronesia; they are undoubtedly of remote antiquity, and certainly can be traced to the pre-historic Polynesians; indeed, several hints of Hindu influence have been detected in them. Maui is generally spoken of as the youngest of four brothers bearing the same name. There is much diversity of opinion as to his ancestry, though it is generally stated that his parents were supernatural beings. Although he lived a thoroughly human life, he was possessed of supernatural powers in addition to an inventive mind and a very tricky

and mischievous disposition. He was 'the fisherman who pulls up islands,' and he improved fish-traps and rendered fish-hooks and fish-spears more efficacious by adding barbs. According to different Polynesian legends, Maui raised the sky, which till then had not been separated from the earth, and thus rendered the earth habitable for his fellow-men. He was also 'the ensnarer of the sun,' permitting him to pursue his course only on the condition that he went more slowly in order to increase the length of the day. Maui, by the aid of his cunning and magical powers, gave fire to mankind, and some legends make him the fire-teacher as well as the fire-finder, as he taught men how to make fire by the friction of two sticks. In seeking immortality for man Maui lost his life. There is a native saying: 'If Maui had not died, he could have restored to life all who had gone before him, and thus succeeded in destroying death.' 'Maui's death by his ancestress the Night fitly ends his solar career' (Tylor, *PC* i. 345).

Westervelt, from whom some of the foregoing information has been borrowed, remarks: 'It is a little curious that around the different homes of Maui, there is so little record of temples and priests and altars. He lived too far back for priestly customs. His story is the rude mythical survival of the days when of church and civil government there was none, and worship of the gods was practically unknown' (*Legends of Ma-ui*, p. 11). R. Taylor says: 'Though regarded [in New Zealand] as a god, he does not appear to have been generally prayed to as one; yet he was invoked for their *kumara* [sweet potato] crops and success in fishing' (*Te Ika a Maui*², p. 133).

If any hero deserved worship it was Maui, and yet even he does not appear to have achieved it. Tylor points out that

'Tangaroa and Maui are found blending in Polynesia even to full identification. It is neither easy nor safe to fix to definite origin the Protean shapes of South Sea mythology, but on the whole the native myths are apt to embody cosmic ideas, and as the idea of the Sun preponderates in Maui, so the idea of the Heaven in Taaroa' (*op. cit.* ii. 346).

The Polynesian Creator is called Kanaroa in Hawaii, Taaroa in Tahiti, Tangaroa in Mangaia and New Zealand, Tangaloa in Samoa and Tonga. In Tahiti some maintained that 'Taaroa was only a man who was deified after death' (Ellis, *Polyn. Researches*, i. 323), though by others he was spoken of as the progenitor of the other gods. Tangaroa was not a very important personage in Mangaia, for he had only one *marae*, or altar, and that was almost neglected, the only offering ever presented being the firstfruits of newly planted coco-nut palms (Gill, *Myths and Songs*, p. 19). He can be linked up with Tagaro of the New Hebrides and with Qat of the Banks Islands, whose brothers were Tangaro the Wise, Tangaro the Fool, etc. It would be tedious to detail the various heroic figures that appear in the legendary lore of Oceania, but the samples selected will suffice to indicate their general character, which finds parallels all the world over.

The majority of tales about heroes belong to those classed as myths, since their object is essentially ætiological. The residue are more correctly termed legends, being narratives of what is believed to have happened, though these hero-tales in many cases may be degraded myths. It has often been stated that mythology is the source neither of religion nor of morality, but of science, philosophy, poetry, and history. The tale or myth about a hero may serve to explain natural phenomena, may be in itself an interesting and amusing narrative, may inculcate social observances or illustrate the danger of neglecting them, may stimulate the listener to high endeavour, or may evoke the feeling of mystery and awe. All this may be accomplished without the hero being worshipped; e.g., no worship is accorded to the culture-heroes—often 'transformers' and even tricksters—of the North American Indians, more especially those of the north-west coast, which fact may well be due to the absence of any *manes-*

cult and to the existence of the belief in *manitu*. It is probably very rare for all the myths of a given people to be indigenous, but many have been borrowed along with other cultural elements at various times. With the myth comes the hero, and, whoever he was in his place of origin, he speedily becomes naturalized, and in his new home places where certain incidents took place are pointed out, and many rocks or other natural objects testify to the truth of the tale, nor does it matter though these should be reduplicated in various localities. The vitality of the myth depends less upon its explanatory significance than upon the personality of the hero, but the development of a cult of the hero would seem to depend upon the socio-religious condition of the recipients.

From an examination of the evidence from Torres Straits, it would seem that, though several men of olden time may fairly be termed culture-heroes, yet no practical notice is taken of them—another illustration of the remark that a prophet has no honour in his own country. Those who have attained such recognition are Kwoiam the Australian, Waiat, and Bomai and his companions, who came from New Guinea. For what causes may we assume that they were honoured? The answer here seems to be that it was the introduction of a new religious cult that reacted socially. The introduction of fearsome masks and new death-dances stimulated the imagination and the religious feelings of the recipients. The valorous deeds and evident supernatural power of the Australian berserker not unnaturally gave rise to a war-cult. The following testimony from a native indicates how patriotism may be engendered in a savage:

'The fame of Kwoiam caused the name of Mabuig to be feared for many a long day, and, although the island was rocky and comparatively infertile, Kwoiam covered it with honour and glory, thus showing how the deeds of a single man can glorify a place in itself of little worth' (*Reports*, v. 83).

The cult of the mysterious brethren is more difficult to explain. It is obvious that, whatever it was originally, it developed into a war-cult in the western and central islands, but the bellicose aspect died of inanition in the Murray Islands. It probably would not matter whether totemism were flourishing or waning when the new cultural influences came in from New Guinea; they introduced new religious ideas, and were not hampered by local totemic restrictions. Thus a wider social grouping became possible, the members of which were united by a common religious sentiment and cult. Additional strength would be given to the movement were it originally or ultimately connected with warfare. We are justified in concluding that here, and probably elsewhere, totemism did not develop into a hero-cult, but rather that this was grafted on to the existing totemism and eventually more or less supplanted it. It has not yet been determined whether these hero-cults originated in New Guinea, or, as is more probable, wandered from further afield, gathering mystery in their progress. What were the heroes in their home country? The problems of the Torres Straits heroes are simple compared with those of Melanesia and Polynesia. The hero, apart from the ancestor, has slight chance of being worshipped while he is still recognized as a human ghost. Time, distance, or forgetfulness may transform him into a spirit that never was a man, and a cult may begin; the same agencies may continue the process, aided perhaps by other cultural influences; and a worshipful godling or even god may have developed. *Omne ignotum pro magnifico*.

LITERATURE.—E. B. Tylor, *Primitive Culture*⁴, 2 vols., London, 1903; J. E. Harrison, *Religion of Ancient Greece*, do. 1905; *Prolegomena to the Study of Greek Religion*², Cambridge, 1908; *Reports of the Cambridge Anthropological Expedition to Torres Straits*, vols. v. (do. 1904), and vi. (1908); G. Landtman, 'Wanderings of the Dead in the Folk-lore of the Kwal-speaking

Papuans,' *Festschrift til Ed. Westermarck*, Helsingfors, 1912; A. B. Joske, 'The Nanga of Viti-Levu,' *Internat. Arch. für Ethnogr.* ii. (1889) 254; R. H. Codrington, *The Melanesians*, Oxford, 1891; W. D. Westervelt, *Legends of Ma-usi, a Demigod of Polynesia, and of his Mother Hina*, Honolulu, 1910; R. Taylor, *Te Ika a Maui*², London, 1870; W. Ellis, *Polynesian Researches*, 4 vols., do. 1831; W. W. Gill, *Myths and Songs from the South Pacific*, do. 1876.

A. C. HADDON.

HEROES AND HERO-GODS (American).—

1. **Extent and distribution.**—Primitive America is, in a sense, the land *par excellence* of heroes and hero-gods, and its most characteristic myths and legends are those which deal with the birth, growth from infancy up to manhood, exploits, and achievements of such more or less divine or wonderful personages. Nor is the rôle of hero-god confined to man or superman alone, for the whole animal world, in its most remarkable diversities of kinds and of species, finds representatives also in the numerous divinities and semi-divinities on record—in the mythologies, national legends, etc., of the American Indian tribes from Alaska to Tierra del Fuego, and over the broad expanse of the double continent from the Pacific to the Atlantic Ocean. D. G. Brinton, the first ethnologist to devote to this interesting topic a special monograph, says, in his *American Hero-Myths* (p. 27):

'The native tribes of this Continent had many myths, and among them there was one which was so prominent, and recurred with such strangely similar features in localities widely asunder, that it has for years attracted my attention, and I have been led to present it as it occurs among several nations far apart, both geographically and in point of culture. This myth is that of the national hero, their mythical civilizer and teacher of the tribe, who, at the same time, was often identified with the supreme deity and the creator of the world. It is the fundamental myth of a very large number of American tribes, and on its recognition and interpretation depends the correct understanding of most of their mythology and religious life.'

James Mooney expresses himself thus on the same subject (*14 RBEW*, pt. ii. p. 658):

'Probably every Indian tribe, north and south, had its early hero god, the great doer or teacher of all first things, from the Iuskeha and Manabozho of the ruder Iroquoian and Algonquian to the Quetzalcoatl, the Bochica, and the Viracocha of the more cultivated Aztecs, Muycas, and Quichuas of the milder southland.'

The range of the culture-hero and hero-god among the American Indians is very great:

'Among the roving tribes of the north this hero is hardly more than an expert magician, frequently degraded to the level of a common trickster, who, after ridding the world of giants and monsters, and teaching his people a few simple arts, retires to the upper world to rest and smoke until some urgent necessity again requires his presence below. Under softer southern skies the myth takes more poetic form, and the hero becomes a person of dignified presence, a father and teacher of his children, a very Christ, worthy of all love and reverence, who gathers together the wandering nomads and leads them to their destined country, where he instructs them in agriculture, housebuilding, and the art of government, regulates authority, and inculcates peaceful modes of life. . . . When at last his work is well accomplished, he bids farewell to his sorrowing subjects, whom he consoles with the sacred promise that he will one day return and resume his kingdom, steps into his magic boat by the seashore, and sails away out of their sight to the distant land of sunrise' (*ib.*).

Such a figure, *e.g.*, was the Mexican Quetzalcoatl, for whom the Indians mistook Cortez, the destroyer of their native culture, thinking that he was their hero returning. Elsewhere in primitive America the white man (but very briefly, since his acts soon betrayed him) has been thought a returning hero or divinity. With these ancient hero-gods of theirs some of the Indian peoples were prone to identify the Christ of the European religions.

The culture-hero idea is often more typically American than that of deity. After pointing out that 'gods are a conception that does not flourish among the American Indians,' in his sketch of 'Types of Indian Culture in California,' A. L. Kroeber says (p. 91 f.):

'The Indian substitute for the deity is the culture-hero. The god creates; by the introduction of character he can be differentiated, and the interaction of distinct deities makes god myths. The culture hero is a man; he is always alone. Where he occurs in several personages in one mythology, these are

only repetitions of one another. In North and South America he is the same. Now he is more heroic, dignified, even pathetic, a benefactor and teacher; now more inquisitive, enterprising, obscene, and ridiculous. It is a commonplace that his character varies between these qualities from episode to episode in the same mythology. But he is always a man in spirit, and he always stands alone in his world. He makes the world or remakes it from existing earth brought him by an assistant animal; he does not create it. He changes individual men, co-existent with him, to animals; he does not create the world's animals and plants. He does not create man, but finds and helps him. He is the one and the only possible character of American mythology; he is the Indian himself in his nakedness.'

Of course, there are exceptions to this general statement, but Kroeber remarks that 'even those specific cases that are exceptions usually rest on a wider basis that conforms with the conditions here described' (p. 92).

2. **Human heroes.**—The child as hero and hero-god among the American Indians has already been touched upon (see art. CHILDREN [American], vol. iii. p. 525). Much valuable information concerning human heroes in the mythology of the N. American Indians will be found in Lowie's monograph on 'The Test-Theme' (*JAF* xxi. [1908] 97-148), where the conclusion is reached that 'a majority of North American test-tales have human heroes and a human setting' (p. 132). He remarks further (p. 134):

'So far as the tales related of sun and moon are concerned, far-reaching similarities distinguishing them as a group from human folk-tales cannot be detected. Solar and lunar heroes are human beings named after, or somehow identified with, sun and moon.' Again (p. 132): 'The test-theme, in its fundamental ideas, the imposition of a difficult or dangerous task and a mutual or competitive trial of strength, is evidently derived from human experience.'

Among the test-themes noted by Lowie in N. American Indian tales are the following:

Flight to the sky, snapping-door, tests by cruel relatives, spine-seat, wedge test, capture of animals, fights with animals, striking trees, *vagina dentata*, sweat-house, fire ordeal, trials of strength, trip to the under world, pushing hero down a precipice, attempt to drown hero, falling trees, hero swallowed by clam, fish, etc., hero sent to get berries in winter and like errands, imitation of host, killing monsters, etc.

Lowie discusses briefly, under the head of hero-tales, these types:

Western 'transformer' myths, myths of the Californian Maidu, 'lodge-boy' and 'thrown-away' cycle (Plains Indians, etc.), Pueblo twin myths, rabbit-cycle (Ponka, Menomini), blood-clot cycle (Blackfoot, Pawnee, Dakota, Arapaho, Gros Ventre), star-boy (Crow, Pawnee, Dakota, Arapaho, Kiowa, Gros Ventre, Blackfoot).

Details concerning some of these heroes will be found in Grinnell's *Blackfoot Lodge Tales* (1903) and *Pawnee Hero Stories and Folk-Tales* (1889); G. A. Dorsey's *Pawnee Mythology* (1906), *Mythology of the Wichita* (1904), *Traditions of the Arikara* (1904); G. A. Dorsey and A. L. Kroeber's *Traditions of the Arapaho* (1903).

Among the Plains tribes the 'poor boy' seems to be a common and favourite hero in folk-tales. With the Arikara, as with the Skidi Pawnee, according to Dorsey (*Trad. of Arikara*, p. 6), 'the poor boy . . . is the culture-hero, while Coyote, the great transformer of the Northwest, takes a very inferior part.' The chief heroes of this sort among the Caddo are Star-Boy, Sun-Boy, and Burnt-Hands—the last the Burnt-Belly of the Skidi Pawnee. Similar heroes are the following, in one way or another: the Wintun (California) Boy-dug-out-of-the-ground, Micmac Spring-Boy, Gros Ventre Found-in-the-grass, Bellacoola and Chilcotin Salmon-Boy, Cherokee Boy-with-scrofula, Ponka and Menomini Rabbit, etc.

According to Boas (*JAF* xvii. [1904] 2), 'the most striking feature of Eskimo folk-lore is its thoroughly human character,' and 'with the exception of a number of trifling tales and of a small number of longer tales, the events which form the subject of their traditions occur in human society as it exists now.' Stories telling of the feats of animals are rare, and animal-stories proper may have been borrowed from the Indians by the Eskimos. This opinion as to the rarity of animal stories among the Eskimos is not, however, shared

by Radin (see art. ESKIMOS, vol. v. p. 393), who assigns a larger rôle to animal actors in Eskimo legends. Bogoras, who has made a comparative study of the folk-lore of north-eastern Asia and that of north-western America, informs us (*Amer. Anthropol.*, new ser., iv. [1902] 605) that 'the general character of the Chukchee and Eskimo tales is quite alike, and the chief topics on both sides of Bering Sea are about the same.' Hero-children and human heroes are common in both. The prevalence of human heroes in the folk-tales of the South American Indians (see art. CHILDREN [American]) will doubtless appear when we know more about this rather neglected field of primitive mythology, and the characters interpreted as personifications of sun and moon are revealed in their true nature, as has been the case with so many figures in the mythology of the northern continent.

3. Typical heroes and culture-heroes.—The Aztec Quetzalcoatl, the Mayan Itzamna, the Chibchan Bochica, and the Quechuan Viracocha have been discussed at considerable length by Brinton in his *American Hero-Myths, Myths of the New World*, etc., and by more recent authorities. They are fairly comparable with some of the great culture-heroes of the Old World. The deeds that they accomplished include the cleaning up of the monster-ridden world, the establishment of society and human civilization—all things, from making the earth fit for mankind to making mankind fit for the new earth. As in the Old World, so in the New, their memory is connected alike with the Paradise that once was and with that which is some time again to come. Besides such great figures as these there are scores of others less majestic and less attractive.

Concerning the culture-heroes of some of the tribes of the North-west Pacific Coast, F. Boas says (*Indianische Sagen*, p. 339):

'What gives the traveller (or wanderer)-tale its character, in this region, is the sharp distinction of the culture-delty from the "Eulenspiegel." Neither the Cikla of the Chinook, nor the Qals of the Coast Salish, the Kumsnool of the Comox, the two Travellers of the Nutka, nor the K'anig yilak' of the Newetsee play, in connection with their culture-mission, such tricks as do the Raven in northern British Columbia, the Glooscap of the Micmacs, the Manabozho of the Ojibwa, the Napi of the Blackfeet, the Coyote of the tribes of the southern Rocky Mountains, or the "Boatman" of the northern Athapascans.

Such tricks are not entirely lacking, but are transferred to different animals or other beings, such as the Bluejay among the Chinook, the Mink and the Raven among the Coast Salish, Comox, and Newetsee, as Kwotiath, the Mink, and the Raven among the Nutkas. The Shuswap have not made so sharp a distinction, and, through their influence, the separation is not so clear among the Fraser River tribes as among the other Coast peoples. The separation is clearest among the Coast Salish and the Bilqula. The Coast Salish of Puget Sound have likewise not carried out the distinction.'

Boas has also discussed the question of the hero and the transformer in his Introduction to Teit's 'Traditions of the Thompson River Indians of Brit. Col.' (*Mem. Amer. Folk-Lore Soc.* vi. [1898] 1-12).

The general character of the hero-myth of the Californian aborigines is briefly sketched by A. L. Kroeber in his art. on 'The Religion of the Indians of California.' The primary feature of the mythologies of the Indians of the north-western part of the State is 'a very deeply impressed conception of a previous, now vanished, race, who, by first living the life and performing the actions of mankind, were the producers of all human institutions and arts as well as of some of the phenomena of nature'; while second in importance are 'myths dealing with culture heroes more or less of the trickster type familiar from so many other parts of North America' (p. 343). In central California, where there 'is always a true creation of the world, of mankind, and of its institutions,' the creator seldom has 'tricky exploits or defeats' attributed to him—such things belong to an antithetic secondary creature, usually the Coyote. In the

northern half of the central area, however, 'the creator is generally anthropomorphic; if not, he is merged into one personage with the more or less tricky Coyote.' In southern California appears the long origin-myth of a thoroughly south-western and Pueblo character. The mythology of the southern part of California resembles that of the south-west rather than that of the rest of the State. As Kroeber notes (p. 344), the mythology of the north-western region of California 'shows affinities to the North Pacific Coast in its prevalence of the culture-hero and trickster over the creator.'

The Maidu of northern central California furnish us with Kodoyanpe (Earth-Namer, or Earth-Maker), a transformer-creator type; also Onkoito, 'a supernaturally born destroyer, conqueror, and avenger.' The northern Wintun conception of Olelbis 'shows a developed and a lofty conception of a creator,' while among the southern Wintun 'there is little antithesis between creator and Coyote in the creation myth.' In the mythology of the Shasta, Coyote is both creator and trickster, although the resemblance to the mythology of the north-western area is not very great. The Klamath (or Lutuami) K'mukamtch, or Old Man, 'is not the "good creator" of the Maidu Wintun, Yuki, and Wishosk; he is deceitful, with the character of the typical culture-hero trickster.' In many things, indeed, he suggests the Algonkian Manabozho.

The Ojibwa Naniboju or Nanabozhu, the Mississauga Nanibozhu or Wanibozhu, the Sautaux Ojibwa Nenaboj or Nanabush, the Ottawa Nenabozhu, the Menomini Manabozho or Manabush, the Nipissing Nenabojo, all correspond to the Cree Wisaketchak, and, more or less, to the Blackfoot Napi or Napiu, the Micmac Glooscap, etc. The stories of the deeds and exploits of this hero-god, who figures in the creation-myth and the deluge-legends of these Indians, who taught them many of the arts and inventions, and who sometimes deceived as well as helped them, have been correlated and discussed by Chamberlain (*JAF* iv. [1891] 193-213). The most detailed account of some of the deeds of this Algonkian culture-hero is given in W. J. Hoffmann's article and monograph on the Menomini Indians (*14 RBEW*, pt. 1. pp. 3-328). The culture-hero of the Sacs and Foxes (also Algonkian) is Wisa'kä. A contest with the manitous appears in the story of Wisa'kä recorded by Jones (*Fox Texts*, pp. 336-379), which includes the flood-legend:

'The theme of the following story is the struggle of the culture-hero to subdue the manitous and make the world ready for the people who are to come after. It is the most sacred myth of the Foxes; and with the Sauks it is the myth on which rests the *midtwiwin*, a religious society which preserves the most sacred forms of religious worship. It is in two parts: first, the struggle of the culture-hero with the manitous, in which the death of his brother, the flood, and the defeat of the manitous are the leading events; second, the pacification of the culture-hero by the manitous, and the restoration of peace, preliminary to setting the world in order for a home of the people' (p. 336).

This subjugation of the manitous is also one of the labours of Manabozho or Nanabozhu among the Ojibwas, etc. The culture-hero myth of the Sacs and Foxes has been recorded by Jones (*JAF* xiv. [1901] 225-239). After preparing the earth for mankind and driving off the manitous, who had sought to destroy him, Wisa'kä proceeded as follows (p. 237):

'Wisa'kaha then created the people, making the first men and the first women out of clay, that was as red as the reddest blood [hence the Indian name of the Foxes, *Meskwa' Kiiği*, 'Red-Earths']. And he made them after the race of his mother. He taught them how to hunt, and he taught them how to grow food in the fields; he taught them all kinds of sports, and he taught them how to live peacefully with one another; he taught them how to sing and dance and pray, and he taught them all manner of other good things.'

Then he left the people, going away to live in

the north, but promising to return one day to take them to their new home in the west, where they were to dwell for ever with their kindred who had gone before them. Wisa'kä is represented as being ever youthful. The culture-myth relates in detail 'the divinity's benevolent acts toward men, his teaching the people the way to live, and his preparation for them of a home after death in the spirit world.'

In his *Fox Texts* (1907) Jones published (pp. 228-379) a number of stories of the culture-hero Wisa'kä, concerning whom he observes (p. 228):

'The stories to follow are typical of that mass of narrative in which the culture-hero moves, now as a buffoon doing tricks to others and having them done to him, and now as a benefactor and as an altruistic character. Sometimes he is peevish and whimpering, like a spoiled child, and stoops to acts most degrading for the accomplishment of an end; and again he rises to the dignity of a wise, all-powerful deity. He is almost always represented as dwelling with his grandmother, whom the Foxes symbolize as the Earth.'

In one instance only is Wisa'kä referred to as having wife or children. In some of his difficulties his grandmother comes to his aid. He comes to grief often in trying to imitate his host (e.g. skunk or duck); he accepts challenges, and thereby becomes a victim of his own foolishness.

Of Glooscap, the culture-hero of the Micmac and closely related Algonkian Indians of Maine, New Brunswick, and Nova Scotia, Charles G. Leland says, in *The Algonquin Legends of New England* (p. 2), that, while he is an appalling giant in his contests with huge monsters and other creatures,

'in the family circle he is the most benevolent of gentle heroes, and has his oft-repeated little standard jokes. Yet he never, like the Manabozho-Hiwatha of the Chippewas, becomes silly, cruel, or fantastic. He has his roaring revel with a brother giant, even as Thor went fishing in fierce fun with the frost god, but he is never low or feeble.'

He informs us further (p. 13) that 'Glooscap is always a gentleman.'

Edward Sapir ('Wishram Texts,' *Publ. Amer. Ethnol. Soc.* ii. [1909] p. xi) says of one of his Indian informants, who is 'theoretically a Methodist,' but in mind-content 'to all intents and purposes an unadulterated Indian,' that

'he implicitly believes in the truth of all the myths he narrated, no matter how puerile or ribald they might seem. Coyote he considers as worthy of the highest respect, despite the ridiculous and lascivious sides of his character; and with him he is strongly inclined to identify the Christ of the whites, for both he and Coyote lived many generations ago, and appeared in this world in order to better the lot of mankind.'

Other culture-heroes are recorded from the various American Indian tribes, besides the 'transformers' of the North Pacific coast region treated of by Boas, in his *Indianische Sagen* (1895), and in the mythological data of the Jesup Expedition, published by the American Museum of Natural History (New York), and besides the cycle of animal and bird heroes and semi-heroes of the Pacific slope, such as Raven, Blue-Jay, Coyote, and Mink. The following may be mentioned:

Klamath K'mukamitch; the 'Old Man' of many western tribes of North America; the Hidatsa Itamapisa; the Mandan Numuckmuckenah; the Arapaho Nihançan; the Cherokee Wasi; the Cheyenne Vihuk; the Tarascan Curicaberis; the Central American Kukulcan and Votan; the Moxo Arama; the Guarayo Abaangui; the Tupian Carubsug and Maire Monan; the Pareasi Uasale; the Guaycuru Karakara; the Bakairi Kamushini; the Carayan Kaboi; the Arawakan Kamu; the Guarani Tamoi; the Izi of the tribes on the Uaupes; the Guaranan Aboye.

Some brief details concerning many of the South American heroes and culture-heroes will be found in Ehrenreich's *Die Mythen und Legenden der südamerikanischen Urvölker* (Berlin, 1905).

4. Culture-hero, clown, deceiver.—In an article on 'The Hero-God of the Algonkins as a Cheat and a Liar,' published first in the *American Antiquarian* in 1885 and then again in his *Essays of an Americanist* (1890, pp. 130-134), D. G. Brinton called attention to the curious fact of the attribution to certain culture-heroes of the Algonkian

Indians of the characteristics of trickery, deceit, lying, and clownishness of various sorts. This was illustrated from the name of the culture-hero of the Micmacs, Glooscap (*Glus-gahbe*, 'juggler with words,' 'word-breaker,' 'deceiver'); and a similar meaning was said to attach to the Cree *Wisaketchak*, the analogue of Glooscap with this western Algonkian tribe. Speaking of Michabo, to whom innumerable tricks are attributed, Brinton says (*Essays of an Americanist*, p. 133):

'Michabo does not conquer his enemies by brute force, nor by superior strength, but by craft and ruses, by transforming himself into unexpected shapes, by cunning and strategy. He thus comes to be represented as the arch-deceiver; but in a good sense, as his enemies on whom he practises these wiles are also those of the human race, and he exercises his powers with a benevolent intention.'

'Thus it comes to pass that this highest divinity of these nations, their chief god and culture-hero, bears in familiar narrative the surprising titles—"the liar," "the cheat," and "the deceiver."'

In *The Myths of the New World*, however, Brinton gives another view of the matter, as follows (p. 194):

'In many of the tales which the whites have preserved of Michabo he seems half a wizard, half a simpleton. He is full of pranks and wiles, but often at a loss for a meal of victuals; ever itching to try his magic arts on great beasts and often meeting ludicrous failures therein; envious of the powers of others, and constantly striving to outdo them in what they do best; in short, little more than a malicious buffoon, delighting in practical jokes, and abusing his superhuman powers for selfish and ignoble ends.'

'But this is a low, modern, and corrupt version of the character of Michabo, bearing no more resemblance to his real and ancient one than the language and acts of our Saviour and the Apostles in the coarse Mystery Plays of the Middle Ages do to those recorded by the Evangelists.'

That some of the Indians under Christian influence may have turned to ridicule their old gods is quite possible. J. A. Cuoq (*Lex. Algonq.*, Montreal, 1886, s.v. 'Wisakedjak,' p. 443), e.g., says:

'The word *Wisakedjak* is now employed only derisively by Christian peoples. With them, *Wisakedjak*, like *Nenabojo*, is about synonymous with monkey (*singe*) in a figurative sense. Thus, it is said of anybody who imitates what he sees done, "He is a *Wisakedjak*."'

J. D. Prince, in his introduction to *Kulóskap, the Master*, says concerning *Kulóskap* (Glooscap), the culture-hero of the Micmacs, Passamaquoddies, and Penobscots (p. 33):

'*Kulóskap* (Klóskábe) is a god-man of truly Indian type who undoubtedly represents the principle of good, and particularly good nature, as opposed to his twin brother Malsum the Wolf, who may be called the Ahrimán of the Wabanaki, although this is almost too dignified a term.'

He remarks further (p. 34):

'The tendency of *Kulóskap*, in spite of his name, was essentially benevolent. Oddly enough, *Kulóskap* means "the liar," from a stem *kúsk*, "lie" + *ap*, "a man, person, one who stands." . . . This appellation, uncomplimentary as it sounds to our ears, was not really meant in this sense by the Indians. *Kulóskap* is called "the deceiver" not because he deceives or injures man, but because he is clever enough to lead his enemies astray, the highest possible virtue to the early American mind.'

This explanation is much the same as one put forward by Brinton; but, even if it did explain (it hardly does so satisfactorily) the name of the culture-hero, in his capacity of 'deceiver,' it fails to account for the clownish actions, ridiculous escapades, and mean and despicable things attributed to him. Nor does it take fully into account the rather numerous occasions on which he is completely outwitted, e.g., in the contest with the baby, with certain animals, and even with trees.

Clark Wissler, in his 'Mythol. of the Blackfoot Indians' (pp. 6-12), discusses the character of the culture-hero of these Indians and his relations to the other figures of their mythology. Of Old Man, or Napiw* (the Napi of various other writers), we are informed (p. 9):

'That the Blackfoot formerly had a well-defined creation-myth, in which the Old Man took the initiative in producing and transforming the world, is indicated by several writers. Those noted above give more or less in detail a running account of the peopling of the earth and the instruction of mankind in the art of living. While these incidents do not occur in detail

In the Old Man myths recorded in this paper, they are occasionally implied. Such origins are at present often assigned to the Old Man without the formality of a myth.

It will be noted that the greater part of the tales collected by us recite the absurd, humorous, obscene, and brutal incidents in the Old Man's career. No ritualistic or ceremonial practices appear to be based upon any of these narratives, though it may have been otherwise in the past. On the other hand, connected with them are the suggestions of origins for many aspects of material culture, such as the buffalo-drive, the making of weapons, methods of dressing skins, etc. A considerable number of places and topographical features were associated with his adventures; as Old Man's River, Tongue Flag River, Old Man's Gambling-Place, Old Man's Sliding-Place, Rolling-Stone Creek, etc. In fact there seems a tendency to give all of his adventures a definite location in Alberta.

Wissler says further (p. 9):

'For several decades at least, the Blackfoot have considered the Old Man as an evil character, in most respects trivial, who long ago passed on to other countries. Whenever the writer asked if the Old Man was ever prayed to, the absurdity of the question provoked merriment. The usual reply was, that no one had enough confidence in him to make such an appeal. In daily conversation his name is often used as a synonym for immorality. However, it must not be implied that he is regarded as an evil spirit. His name is especially associated with things obscene, and pertaining to sexual immorality. I have heard the Piegan say that So-and-so "must be trying to be like the Old Man; he cannot be trusted with women."

It is quite probable that here, as with other Indian tribes, the culture-hero has suffered from the same disposition seen among civilized peoples of the present day to attribute actions of a certain character to their heroes and great historical figures. Wissler, therefore, seems quite justified in his statement (p. 10):

'We have occasionally noted a tendency to assign modern obscene anecdotes to this character, and it may well be that many of the tales long attributed to him have been accumulated by the laws of association. The unfortunate human tendency to appreciate keenly the humour in such anecdotes seems sufficient to account for their survival and accumulation long after belief in and respect for the Old Man as a creator, teacher, and transformer has passed the verge of extinction.'

Taking everything into consideration, Wissler inclines to the opinion that certain Old Man myths 'are survivals from a much larger group constituting the ancient basic beliefs of the Blackfoot,' and that 'there has been a disintegration of the creative and cultural origin myths concerning Old Man.' To-day the Blackfoot make Napiw^a (the Old Man) and Natos (the Sun) different characters, the former secondary. According to Wissler, the Blackfoot and the Crow 'culture-heroes' are closer together than the Blackfoot and those of the Arapaho and Gros Ventre. Those of the Blackfoot, Crow, and Arapaho seem all, however, to be 'entirely human,' with no traces of any animal qualities. W. McClintock, in his *The Old North Trail*, gives much space to Old Man and the myths about him (pp. 337-348). He says concerning his character (p. 337 f.):

'The character of Old Man, as revealed, even in the more serious of these myths, is a strange composite of opposing attributes, of power and weakness, of wisdom and passion, of benevolence and malevolence. He associated intimately with the birds and animals. He conversed with them and understood their thoughts and language, and they understood him. Although believed to be the creator of all things, and as having omnipotent power, he was often helpless and in trouble and compelled to seek the aid of his animal friends. He was, in fact, like an animal in his instincts and desires, which, strange to say, were exercised in conjunction with his supernatural power.'

The power of Old Man was 'uncontrolled by reason, and wanton in its exercise,' and 'he was a deceiver and a trickster and his name was a synonym among the Blackfeet, at least in later years, for mischievous and immoral adventure' (p. 338). Of some of the Old Man myths, McClintock remarks (p. 337) that they 'are samples of Indian humour, told as we tell fairy tales and using Old Man for their central figure.'

Many of the myths relating to Old Man among the southern Piegans of Montana have been published by C. C. Uhlenbeck in his *Original Blackfoot Texts* (1911) and *A New Series of Blackfoot Texts* (1912). Uhlenbeck styles Napiw^a (or Napi) 'a trickster-hero.'

Robert H. Lowie, who was among the Chipewyan Indians (of Athapascan stock) about Lake Atha-

basca in 1908, reports ('Chipewyan Tales,' 1912, p. 173) that 'the Wisaketcak myths were becoming part and parcel of Chipewyan folk-lore.' He remarks further:

'While the Cree name of the hero was the only one used by my informants (Chipewyan Indians, or Indians of partly Chipewyan and partly Cree extraction) and was said to have no Chipewyan equivalent, there were indications that Wisaketcak was being brought into close relation with other Chipewyan characters of older standing. Thus, Francis Fortin regarded Wisaketcak as one of three brothers, the others being Crow-Head and Spread-Wings. While the other two always remained with the Chipewyan, Wisaketcak lived alternately among the Cree and the Chipewyan. However this may be, the Wisaketcak cycle of the Cree was certainly very well known among the Chipewyan and part Chipewyan at the time of my visit.'

The Wisaketcak myths obtained from the Chipewyan Indians are given on pp. 195-200, and are of the 'Wisaketcak was travelling' type. This passing over of an Algonkian cycle of myths into the mythological *fond* of the Athapascan Chipewyan is a most important fact in comparative folklore; it suggests the possibility of similar occurrences elsewhere in primitive America.

The correspondents of the Algonkian Nanabozhu and similar characters in the mythology of the Siouan stock have been discussed by J. O. Dorsey (*JAF* v. [1892] 293-304). These are Mactcige (the Rabbit), Ictinike, his great enemy, and Haxige (nearer to Ictinike than to the Rabbit). Other minor figures of like import are 'The Orphan,' 'Wears-a-plume-in-his-hair,' and 'Badger's Son.' In character and in exploits Ictinike and Haxige both resemble Nanabozhu very much, many of the incidents in the legends about them being identical.

Of the Iroquoian Tawiskaron, J. N. B. Hewitt (*HAI* ii. [1910] 709) says:

'In concept Tawiskaron is so closely identical with the mythic personage called Chakekenapok in Algonquian mythology, a younger brother of Nanabozho, that they may be treated together.'

And of Ioskeha, or Teharonhiawagon, the brother of Tawiskaron, and the great Iroquoian culture-hero, corresponding to the Algonkian Manabozho or Nanabozho, he says (*op. cit.* p. 719) that, in everything but minor details, he is identical with the conception of Nanabozho. According to Hewitt (*op. cit.* p. 19),

'Nanabozho is apparently the impersonation of life, the active quickening power of life—of life manifested and embodied in the myriad forms of sentient and physical nature. He is therefore reputed to possess not only the power to live, but also the correlative power of renewing his own life and of quickening and therefore of creating life in others. He impersonates life in an unlimited series of diverse personalities which represent various phases and conditions of life, and the histories of the life and acts of these separate individualities form an entire cycle of traditions and myths which, when compared one with another, are sometimes apparently contradictory and incongruous, relating, as these stories do, to the unrelated objects and subjects in nature. The conception named Nanabozho exercises the diverse functions of many persons, and he likewise suffers their pains and needs. He is this life struggling with the many forms of want, misfortune, and death that come to the bodies and beings of nature.'

Teharonhiawagon has by some been erroneously identified with Hiawatha, who seems to have been a real human being, a famous Iroquois lawgiver of the 16th cent. (see *HAI* i. [1907] 546); and Longfellow's so-called 'American epic,' which bears the title *Hiawatha*, is really concerned with the story of the Ojibwa hero-god Manabozho, whom the poet confused with the Iroquoian Hiawatha, believing both to be the same mythical being, following in this the mistaken ideas of Schoolcraft and others of his informants.

5. Twin-heroes and culture-heroes.—The appearance of heroes and hero-gods as twins, older and younger brothers, or a group of brothers (varying from three to seven) is common in primitive America—and the twins are often said to be born of a virgin-mother. Some of the most important culture-heroes appear at first as one of twins, etc., but soon the minor brother or brothers vanish from the story, lose their lives, or in some way become

of little or no account henceforth. Sometimes the twins or two brothers represent a conflict, one standing for good, peace, and the like, the other for evil, war, etc.; sometimes also this fraternal strife begins in the womb of the mother before birth (as with the Iroquoian Good Mind and Bad Mind), and the eagerness of the stronger and more impetuous to be born kills her. A characteristic Algonkian culture-hero, Wisa'kä, of the Sacs and Foxes, is represented to have been the eldest son of Gishä Mun'etōa, the greatest of all manitous, who lived in the days when the earth was peopled with manitous. Jones (*JAFI* xiv. [1901] 225) says:

'Now the elder of the two sons [the great manitou had four] was Wisa'kä, and the younger Kujá'pa'taha. They were different from all children before them, for, even when very young and small, they were mightier manitous than those who were older than they. And, the older they grew, the stronger they walked in their might as manitous. The manitous beheld the growing might of the two boys, and became jealous.'

But it is the elder brother who becomes the culture-hero and friend of mankind. The predominance of the elder brother characterizes many other Indian myths.

The twin hero-gods of the Zuñi are Ahaiyuta and Mátsailéma, spoken of as older and younger brothers, and 'accounted immortal twin youths of small size.' Their deeds are detailed by Cushing in his 'Zuñi Creation Myths' (*IS RB&W*, 1896) and *Zuñi Folk-Tales* (1901). They are also styled 'the twin gods of war,' and are looked upon as the 'right-hand' and 'left-hand' beings of the sun. A. L. Kroeber found 'the myth of the miraculous twins and war leaders' among the Uinta Utes of the Shoshonean stock in north-eastern Utah (*JAFI* xiv. [1901] 252). A characteristic South American twin myth is the Bakairi story of Keri and Kame; the former, wiser and more powerful than the latter, is, according to K. von den Steinen (*Die Bakairi-Sprache*, Leipzig, 1892), the chief hero in the legends of these Indians. The names now borne by these heroes are those of the sun and moon, and, curiously enough, it is the weaker, and not the stronger one, who has the name of the sun.

Among North American twins, brother-pairs, etc., may be mentioned the following:

Noakana and Masmasalanig among the Wikeno of British Columbia; the Two Brothers of the Déné (Athapascan); the Thunder Twins of the Californian Tachi Yokuts, and Miwok (much elaborated by the Yuki); the Klamath or Lutuamian Marten and Weasel; the Pemanto and Onkoito of the Californian Maidu; the Algonkian Manabozho and Chokanipok (also Micmac Glooscap and Malsum); the Iroquoian Ioskeha and Tawiskaron; the Navaho Tobadizini and Nayenezgani; the Zuñi Ahaiyuta and Mátsailéma.

From Mexico and Central America may be cited:

Quetzalcoatl and his three brothers, among the Aztecs; the Hun-Hun-Ahpu and Vukub Hun-Ahpu and Hun-Ahpu and Xbalanque of the Mayas; the Two Brothers (Twins) of the Guaymí of Costa Rica.

From South America the following:

Amallvaca and Vochi among the Tamanacos of Venezuela; Tamendonare and Arikute among the Brazilian Tupis; Karu and Rairu among the Mundurucus; Tiri and Karu among the Yuracare; the two sons of Abuangui among the Guarayos; Pachacamac and Vichama among the Yunkas; Apocatequii and Figueroa among the Guamachuco; Keri and Kame among the Cariban Bakairi.

The legends concerning these heroes embody a great variety of incidents—co-operation, opposition, adventure, strife.

6. Re-incarnations of the hero-gods.—In the literature relating to the conflict of the Indian peoples of America with the white man, the 'Messiah movements,' the 'Ghost-Dance religion,' etc., we meet with references to beliefs in the return of the ancient divinities and culture-heroes, for the purpose of driving out the white intruders and restoring the land to the red man, in all its pristine beauty and fertility. This is sometimes a feature of the 'new religions' of the American Indians, recently discussed by Chamberlain (*Journ. Relig. Psychol.* vi. [1913] 1-49). Among the Ojibwa,

VOL. VI.—41

e.g., the 'prophet' Tenskwatawa (a Shawnee settler of a 'new religion,' in 1805-1812) came to be looked upon as an incarnation of Manabozho. The revolt of the Mexican Zapotecs in 1550 was led by an Indian priest, who declared himself to be an incarnation of Quetzalcoatl.

After the departure of the culture-hero, some Indians, according to the legends of not a few tribes, succeeded in making their way to his far-off abode. Leland (*Algonq. Leg.*, 1885) records (pp. 94-103) two Micmac tales of the men who went to Glooscap for gifts, and Jones (*Fox Texts*, pp. 332-337) gives the Fox Tale of how 'The Red-Earths went to where Wisa'kä was.' Upon this story he remarks (p. 332):

'This narrative is but another version of a familiar story known to other Algonkin tribes. It is the account of the visit of four men to the culture-hero at his distant home, and of how each obtained what he asked for. The visit is supposed to have taken place long after the culture-hero had departed from this world. It is not stated in the text, but the place of the home is at the frozen north.'

In the Micmac story the departed Glooscap is represented as dwelling in a land of magic and of beauty.

7. Interpretation of heroes and hero-gods.—Both in his *The Myths of the New World* and his *Essays of an Americanist*, and in other writings as well, Brinton sought to interpret the culture-heroes of the American aborigines as personifications of light, dawn, etc., calling to his aid, not infrequently, Max Müller's 'disease of language' theory. The Algonkian *Michabo*, the 'Great Rabbit,' was a light-god, because of the relationship of *wábos* (i.e. 'white one'), the term for 'rabbit,' and *wában* (also from the root *wáb*, 'white'), the word for 'dawn'; and *Manabozho* was disposed of in a similar manner. The Iroquoian *Ioskeha*, Aztec *Quetzalcoatl*, Mayan *Itzamna*, Chibchan *Bochica*, Peruvian *Viracocha*, and many other figures, he made out to be essentially the same. The often-occurring contest of two brothers or of the twins, as, e.g., the Iroquoian *Ioskeha* and *Tawiskara*, the Algonkian *Manabozho* and *Chokanipok*, he explained as the contest of light and darkness. The culture-hero is, as was sung of Itzamna, 'son of the mother of the morning,' or 'born in the east.' To cite Brinton's own words (*Amer. Hero-Myths*, p. 29):

'The most important of all things to life is Light. This the primitive savage felt, and, personifying it, he made Light his chief god. The beginning of the day served, by analogy, for the beginning of the world. Light comes before the sun, brings it forth, creates it, as it were. Here, the Light-God is not the Sun-God, but his Antecedent and Creator.'

This is somewhat different from the solar and lunar theories of hero-myths revived in recent years, in particular by Frobenius and others, and shared also by Ehrenreich, in his monograph on general mythology (p. 233), where he identifies 'culture-heroes' with the sun, the moon, and Venus; in his special treatment of South American myths (*Myth. und Leg. der südamer. Urvölk.*, p. 24), he says of 'the so-called culture-heroes' that 'they all bear more or less the character of sun or moon beings.'

As noted above, the unsatisfactory character of the naturalistic theory for the explanation of American hero-tales and hero-myths has been pointed out by Lowie, who emphasizes their interpretation on grounds of human experience. Not more successful than the solarists and the lunarists are the Freudian school of psycho-analysts, with their *outré* dependence upon sex and sex *motifs*. One outgrowth of Freudianism in this field is Otto Rank's *Der Mythos von der Geburt des Helden* (Leipzig, 1909). Wundt's conception of the hero as 'a projection of human wishes and hopes' may perhaps hold without either the solar-lunar basis of Frobenius-Ehrenreich or the more pathological substrata of the Freudian school. Here, as else-

where, the explanation from normal humanity is always the best.

LITERATURE.—F. Boas, *Ind. Sagen von der nord-pacif. Küste Amerikas*, Berlin, 1895, also 'Folk-Lore of the Eskimo,' *JAFI*, xvii. [1904] 1-13; D. G. Brinton, *Amer. Hero-Myths*, Philad. 1882, *The Myths of the New World*, do. 1896, and 'The Hero-God of the Algonkins as a Cheat and a Liar,' in his *Essays of an Americanist*, do. 1890, pp. 180-134; A. F. Chamberlain, 'Nanibozhu amongst the Otchipwé, Mississagas, and other Algonkian Tribes,' *JAFI* iv. [1891] 193-218, and '"New Religions" among the N. Amer. Indians,' *Journ. of Relig. Psychol.* vi. [1913] 1-49; F. Cushing, *Zuni Folk-Tales*, New York, 1901; G. A. Dorsey, *Trad. of the Arikara*, Washington, 1904, *Mythol. of the Wichita*, do. 1904, *Trad. of the Caddo*, do. 1905, *The Pawnee Mythol.*, pt. 1, do. 1906, *Trad. of the Skidi Pawnee*, Boston, 1904; G. A. Dorsey and A. L. Kroeber, *Trad. of the Arapaho*, Chicago, 1903; J. O. Dorsey, 'Nanibozhu in Slouan Mythology,' *JAFI* v. [1892] 293-304; P. Ehrenreich, *Die allgem. Mythol. und ihre ethnol. Grundlagen*, Leipzig, 1910, *Die Mythen und Legenden der südamer. Urvölker*, Berlin, 1905, and 'Götter und Heilbringer,' *ZE* xxxviii. [1906] 536-610; G. B. Grinnell, *Blackfoot Lodge-Tales*, New York, 1903, *Pawnee Hero Stories and Folk Tales*, do. 1889; J. C. Hamilton, 'The Algonquin Manabozho and Hiawatha,' *JAFI* xvi. [1903] 229-233; J. N. B. Hewitt, 'Hiawatha,' in *HAI* I. [1907] 546, 'Nanabozho,' *ib.* ii. [1910] 19-23, 'Tawiskaron,' *ib.* 707-711, 'Teharohiawagon,' *ib.* 718-723; W. Jones, 'Episodes in the Culture-Hero-Myth of the Sauks and Foxes,' *JAFI* xiv. [1901] 225-239, and *Fox Texts*, Leyden, 1907; A. L. Kroeber, 'The Religion of the Indians of California,' *Univ. Calif. Publ. Amer. Arch. and Ethnol.* iv. [1907] 319-356, 'Indian Myths of South Central California,' *ib.* 167-250, and 'Types of Indian Culture in California,' *ib.* ii. [1904] 81-103; C. G. Leland, *The Algonquin Legends of New England*, Boston, 1885; C. G. Leland and J. D. Prince, *Kulóskap the Master and other Algonkin Poems*, New York, 1902; J. Loewenthal, 'Der Heilbringer in der irokesischen und algonkinischen Religion,' in *ZE* xlv. [1913] 65-82; R. H. Lowie, 'The Test-Theme in North American Mythology,' *JAFI* xxi. [1908] 97-148, and 'Chipewyan Tales,' *Anthrop. Papers Amer. Mus. Nat. Hist.* x. [New York, 1912] 171-200; W. McClintock, *The Old North Trail*, London, 1910; J. Mooney, 'The Ghost Dance Religion,' *14 RBEW* [1896], pt. ii., pp. 653-1136; C. C. Uhlenbeck, *Original Blackfoot Texts*, Amsterdam, 1911, and *A New Series of Blackfoot Texts*, do. 1912; C. Wissler and D. C. Duvall, 'Mythol. of the Blackfoot Indians,' *Anthrop. Papers Amer. Mus. Nat. Hist.* ii. [1903] 1-164; W. Wundt, *Völkerpsychologie*, ii. 'Mythus und Religion,' 3 vols., Leipzig, 1905-08.

ALEXANDER F. CHAMBERLAIN.

HEROES AND HERO-GODS (Babylonian).

—The amount of material furnished by the native inscriptions, Berosus, and the Greek writers who deal with Bab. mythology indicates that the literature treating of this subject was exceedingly extensive. Moreover, not only are the narratives which have been handed down attractive and entertaining; they also reveal to us the opinions of the more cultured Babylonians concerning the origin of created things, the relationship of the gods to men, and the limit of the power of both, to say nothing of the fancies and the inventive power of their minds; and the stories of their hero-kings are probably, in certain cases, not without a historical value.

I. BABYLONIAN HEROES MENTIONED BY BEROSUS.—1. Alorus and five of his successors.—After Oannes came forth from the sea (the Persian Gulf) to teach the people, there ruled Alorus, 'the shepherd of the people,' for 10 *sari* (36,000 years). Afterwards came Alaparus (see below, III. 1, 'Adapa') for 3 *sari* (10,800 years). He seems to have been regarded, like the next, Amelon or Amillarus, who reigned for 13 *sari* (46,800 years), as a native of Pantibibla, probably Sippar, in the province of Agadé. The fourth mythical king was Ammenon (in Sumerian probably *En-men-nunna*; see below, III. 3), who reigned for 12 *sari* (43,200 years). In his time came the Musarus Oannes (? *U-anna*, 'luminary of heaven,' possibly the sun), or Annedotus, half man and half fish, from the Persian Gulf. The fifth ruler was Megalarus (Metalarus), also of Pantibibla, who reigned for 18 *sari* (64,800 years). The sixth reign was that of Daos or Daonos, the shepherd of Pantibibla, who ruled 10 *sari* (36,000 years; see below, IV. 3, 'Tammuz'). In his time four composite beings, Evedocus (Sumerian *En-we-dugga*), Enugamos

(? Sumer. *En-we-gan*), Enebulus, and Anementus, arose from the Persian Gulf.

2. Euedoreschus.—With the seventh name we have a clearer historical personage, Euedoreschus (*En-we-dur-an-ki*, possibly 'the lord of the word binding heaven and earth'), also of Pantibibla. Berosus relates that in his time another Annedotus, called Odakon (cf. Sumer. *Utuki*, a name of the sun-god), or Apodaphos, arose from the sea. The British Museum tablet K. 2486 calls *En-we-dur-an-ki* 'king of Sippar, . . . beloved of Anu, Bel, and Éa, . . . whom Samaš and Addu (Hadad) had placed on a golden throne.' He was a diviner, versed in all sacred things, and the perfection of his person served as a model for all who aspired to the priesthood after him.

3. Amempsinus, Opertes, and Xisuthrus.—The eighth ruler was Amempsinus of Larancha, who ruled for 10 *sari* (36,000 years), but of this personage nothing more is known. The ninth, however, was of much greater note, being none other than Otiartes (a scribe's error for *Opertes*, the *U(m)bara-Tutu* of the Flood-legend). The Gr. text describes him as being of Larancha, but the Flood-story in the Legend of Gilgamesh seems to make him a native of Surippak, now Fara, on the Euphrates. He ruled for 8 *sari* (28,800 years), and was succeeded by his son, Sisithrus or Xisuthrus (*Hasis-athra*, Bab. *Atra-hasis* transposed), 'the exceedingly wise.' This is simply a title which was given to Bab. heroes, and the patriarch's name seems to have been *Ut-napišti*^m (*Uta-naišti*^m in the Gilgamesh-legend discovered by Meissner). Xisuthrus ruled 18 *sari* (64,800 years). He probably passed for the greatest of all the mythical kings of Babylonia.

The most complete account of the Flood and the end of the great Bab. hero who figured in it is probably that given by Berosus, as quoted by Alex. Polyhistor (see *ERE* iv. 553^a). The fullest account of his life, however, was probably that known as the legend of 'Éa and Atar-hasis' (a variant form of *Atra-hasis*). Unfortunately the mutilation of the text renders the sequence and bearing of the events which it records exceedingly doubtful. A series of years up to 7 are mentioned in which distressing things occurred among the people (cf. Gn 6⁵⁻¹¹⁻¹³), parents and offspring being unnatural towards and suspicious of each other. There was scarcity of water and corn, and children were not brought forth. Owing to this, Atar-hasis appealed to the god Éa, on the second occasion setting up his abode at his door. Éa, however, took no notice, and the cries of the tormented people rose on high, troubling the god Enlil; so various sicknesses were sent among them, silencing their complaints. This apparently gave Atar-hasis opportunity for a fresh appeal, and the god this time answered, but the text is too mutilated for the sense to be gathered.

In the considerable gap which occurs at this point, it is not improbable that the intention of the gods to send a flood upon the earth is announced. If so, the Pierpont Morgan fragment (Scheil, *RT* xx. [1897]) probably gives the text. Though exceedingly mutilated, there appears to be a conversation between Éa and the patriarch, whom the former seems to advise to ask (the other deities), 'Why wilt thou kill the people?' Whether the Hilprecht fragment (see *ExpT* xxi. [1909-10] 364 ff.) belongs to this legend or not is doubtful, but seems not improbable. The announcement of the intention of the deity to bring a flood is given in detail, with directions as to the construction of the ark. Another doubtful fragment—that found by G. Smith and known as *D(aily) T(elegraph)* 42 (T. G. Pinches, *OT in the Light*, London, 1903, p. 117)—also covers this section of the story, and contains part of *Atra-hasis*' reply concerning the building of the ship.

From this point onwards the text is wanting until the last column of the large British Museum tablet (K. 3399+3934), which refers to 14 pieces of clay, out of which seven beautiful males and females were created by the goddess of generation, Mami (*belit ili*, 'the lady of the gods,' also called Aruru, the creatress). These lumps of clay would correspond with the stones which the hero of the Flood and his wife threw behind them in the legend of Deucalion's flood (*ERE* iv. 554). Concerning the death of Atra-hasis nothing is known.

Such were the hero-kings of Babylonia until after the great Deluge; and, notwithstanding the fact that the Babylonians believed in their historicity, there is no doubt that they are wholly mythical—though historical personages of later date may have been transferred into that remote past which the Babylonians pictured to themselves so clearly. It is doubtful whether the first kings after the Flood can be looked upon as more historical, but it is to be noted that the successor of Xisuthrus or Atra-hasis—Evekhous, Evekhoos, Euexius, or Eutykhius, who reigned for 4 *neri* (2400 years)—is identified by Syncellus with Nembrod (Nimrod), and the latter, if really Merodach (IV. 2, below), was the first great Bab. hero-god, the beginning of whose kingdom was Babel, etc. (Gn 10¹⁰). He is said to have been succeeded by his son Khomasbelus, who reigned 4 *neri* and 6 *sossi* (2700 years).

II. *THE BABYLONIAN HERO-KINGS MENTIONED IN THE NATIVE INSCRIPTIONS.*—1. Gilgameš.—Gilgameš was, in all probability, the first important hero after Merodach, and may be the Khomasbelus who succeeded Merodach. The full form of his name seems to have been Gibil-gameš, and his capital was Erech (*Uruk supuri*, 'Erech of the enclosures'). The legend concerning him covered 12 tablets, and was, therefore, of considerable length. Unfortunately, there are many lacunæ. Gilgameš is described as having been 'two-thirds god and one-third man'; and, as no being seems to have existed with whom he could associate on equal terms, Aruru (see *ERE* ii. 643^b, v. 723^a), who had created him, formed a man in his likeness—the sage Enki-du (*Ea-bani*), who dwelt in the wilds among the beasts of the earth. Enticed to Erech, Rêmut-Bêlti, the mother of Gilgameš, tells her son that Enki-du is to be his companion, and he accepts him at once.

Gilgameš and Enki-du go together on an expedition against Humbaba, the Elamite, whose head they cut off. Later, the renown which Gilgameš had acquired attracted the attention of Ištar, the goddess of Erech, who wished to espouse him. Notwithstanding her divinity, he had a very low opinion of her morality, and rejected her advances with reproaches. Angered, Ištar complained to her parents Anu and Anatu, and a divine bull was sent down to overawe the hero and avenge the goddess. Undismayed, Gilgameš and Enki-du killed the animal, over whose remains Ištar and her maidens lamented. Probably owing to Ištar's hostility, Gilgameš was smitten with an incurable malady, and he also had the misfortune to lose his friend Enki-du. In despair, Gilgameš roamed about the world seeking to have his friend restored to him, and to find relief for himself. Many were the people whom he met, and the wonders which he saw, and he arrived at last, accompanied by Sur-Šanabi the boatman, at the place to which Ut-napištim (Xisuthrus or Atra-hasis [see above]), the Bab. Noah, had been translated, there to dwell for ever after the Flood.

After an account of the calamity (*ERE* iv. 550^b, 551^a) and Ut-napištim's explanation that he had attained immortality as a reward for his faithfulness, certain ceremonies are performed which

restore the hero to health. Later, when on his way back, he finds and loses a plant which would have given him the life and youth which he sought. Bewailing his loss, he reaches Erech, and takes measures for the restoration of its walls. The exceedingly imperfect 12th tablet details the raising of his old companion, Enki-du, who describes to him the state of the good and the wicked after death. The last days and death of Gilgameš are not referred to. (For other details, see *ERE* ii. 315 f.)

As handed down, the legend of Gilgameš appears as the life-history of a great and energetic ruler. H. C. Rawlinson, however, thought that the 11th tablet of the series, with the story of the Flood, corresponded with the 11th zodiacal sign, Aquarius; and the creation of Enki-du in the likeness of the hero might be held emblematic of the constellation of the Twins. In its present condition, however, the story does not lend itself to satisfactory analysis, at least from the astral point of view.

Whether the infant Gilgameš, son of Sevekhoroš, thrown from a tower, and caught by an eagle (*Ælian, de Nat. Animal. xii. 21*), refers to Gilgameš or Gibil-gameš is at present uncertain.

2. Azag-Bau.—Though a woman, this ruler seems to have been looked upon as worthy of hero-fame. According to the chronological list published by Scheil (*CAIBL*, Oct. 1911; *ExpT* xxiii. [1911-12] 306, 308), she had been a wine-seller, and is said to have founded the city of Kiš, of which she became queen, perhaps on account of her vineyards and presses being there. The length of her reign is given as 100 years. As in the case of Sargon of Agadé afterwards, events of her reign are quoted in the omen-tablets.

3. Sargon of Agadé.—This ruler, whose name in Bab. is Šarru-kin, was the great royal hero after Gilgameš. His autobiographical legend states that his mother was a priestess or devotee (of some deity), and that he knew not his father (who had possibly visited his mother without making himself known to her). After the child had been brought forth in a secret place at Azupirānu on the Euphrates, his mother placed him in a little basket-ark made water-tight with bitumen, and set him afloat on the river. Carried by the stream to Akki the libation-priest, he became his adopted son. How he attained royal rank is not known, but he had a long and renowned reign. The omens from his reign state that he crossed the Eastern sea, and conquered all the lands of the West. Besieged, during a revolt, in his capital Agadé, notwithstanding his advancing years he made a sortie, and defeated his foes. After this he subjugated Subartu, and made the boundaries of Agadé equal with those of Babylonia. He probably died in consequence of the anxieties due to a famine.

4. Narām-Sin.—This was a ruler hardly less renowned than his father, Sargon. He conquered all the regions around the Stato of Agadé—Apirak, Subartu, Media, Elam, Tilmun (Bahrein and the W. coast of the Persian Gulf), Magan, and Meluhha, capturing, in all, 17 kings, with 90,000 troops. Unfortunately, less than a sixth of the inscription dealing with his reign is preserved.

5. The historical and deified hero-kings.—Though the exploits of Azag-Bau, Šarru-kin, and Narām-Sin may be largely legendary, those of the deified kings Dungi, Bûr-Sin, Gimil-Sin, Libit-Ištar, Eri-Aku (or Ārad-Sin), Rim-Sin, Išme-Dagan of Isin, and the apparently non-deified Nebuchadrezzar I. are well within the range of history. Colophon-dates and contemporary inscriptions show that they carried on campaigns, performed ceremonies, and worked for the welfare of their people by digging irrigation-channels,

administering justice, and building temples. The records of heroic deeds on their part are, it is true, wanting, but a fragment, whose colophon contains the name of Dungi, gives an account of his pious works, implying that such were preferable to deeds of prowess on the battle-field. Libit-Ištar, too, although 'his weapon prevailed greatly,' enjoyed as much renown because he set up some monument 'for the admiration of multitudes of people,' and his sacrifices and prayers seem to have been acceptable to Enlil, the old patron-deity of Nippur.

In the case of Nebuchadrezzar I. (c. 1120 B.C.), the historian compares him with a lion and with the god Hadad, and his great men with lions' cubs. Finding his country wanting in prosperity, he prayed to Merodach for Babylon and his temple E-sagila; and success against Palestine (Amurru) and Elam was promised him—success which, as we know from the historical inscriptions, was realized. The glory of his namesake of later date, surnamed the Great, is known to all. Had the Bab. nation continued its career as an independent State, there is little doubt that the two Nebuchadrezzars would have figured with equal renown among its great and royal heroes.

III. OTHER LEGENDS OF HEROES FROM THE NATIVE RECORDS.—I. Adapa.—This hero is described as having possessed all the wisdom of Anu, the god of the heavens, as well as that of Ea, in whose city, Eridu, he dwelt. He bore the title of *nuhatimmu*, which seems to indicate one who had the preparation and distribution of sacred food. He was also a fisherman of that city, which in his time lay on the shores of the Persian Gulf.

While he was sailing out one day, the south wind came and sank his vessel, and Adapa found himself in 'the house(s) of the fish.' He threatened to break the wings of the wind, and this was forthwith accomplished. For a week the south wind did not blow, to the annoyance of the god Anu, who summoned the wind and Adapa before him. Ascending to the heaven of Anu, Adapa saw there at the god's door Tammuz and Giš-zida, two deities who had disappeared from the earth. Adapa explained to Anu why he had broken the south wind's wings, and these two deities, speaking for him, appeased the wrath of Anu, who, however, was displeased with Ea for having thus caused to be revealed 'the heart of heaven and earth' to a man. The food of life was now offered to Adapa, but he refused to eat of it, explaining that he was acting in accordance with the instructions of Ea. He had apparently declined to eat it, however, under the impression that it was the food of death. Seemingly as a compensation for the loss, rule over the people of the earth was conferred upon him; and it may be supposed that, like Atrahasis, he attained immortality in the end at the hands of his own god, Ea. It has been suggested that Adapa is the *Alaparos* of Berosus, written for *Adaparos*; but the *r* would, in that case, seem to be intrusive.

2. Etana and the Eagle.—This legend is also exceedingly imperfect. At a time when there was no king upon the earth, and apparently not even the insignia of royalty, Ištar, seeking a ruler, had come upon Etana, whose wife expected a child, destined by the gods to govern the earth. The birth, however, was retarded, and Etana sought a remedy for this delay—the divine 'herb of bearing,' which it was thought that the eagle would be of use in obtaining. This bird, unfortunately, conceived a desire to eat the young of the black serpent, and, having descended to carry out this intention, had his wings broken by the enraged reptile. The eagle having been in the end healed, Etana, clinging to its body, attempted to

reach the throne of Ištar, who is elsewhere called 'the mother of those who bring forth.' That giddy height, however, they seem not to have attained, as Etana refused to be carried so far, and they descended to earth again. How the legend ends is uncertain, but the attempt may have been successfully repeated, or the coveted herb may have been acquired in another way.

3. Other legends.—Numerous other legends existed, but in many cases the titles (first lines) are all that remain. Among these are '[The legend of En-men?-nunna' (probably Ammenon [see above, I. 1], the fourth pre-historic hero-king), by Enlil-ban-kudurri son of Hu-meme; and 'the legend of Si-du,' by Si-du the ancient (apparently an autobiography). 'The legend of Lidlul, the sage,' of which fragments are extant, is rather a philosophical work, treating of the miseries and the disappointments of life, than the story of a hero.

IV. BABYLONIAN HERO-GODS.—I. Enlil and Ninlil.—The story of these deities is contained in a bilingual composition of unusual beauty. Enlil and Ninlil are described as the youthful hero and handmaid of Dur-an and Nippur (identified with the Calneh of Gn 10¹⁰), and dwelt there, as well as in Dur-gišimmar, 'the date-palm fortress,' with its holy river, its food-store, well of sweet water, and holy brook. Therein Ninlil had the comfort of her mother Kiel-azaga, and the protecting goddesses of the holy streams made the water flow. After a gap, the text seems to speak of the ceremonial entrance of Enlil and Ninlil into Nippur, when unclean or undesirable things were to be sent forth therefrom. On their approach, Enlil calls to the gate-keeper announcing the lady Ninlil's coming, and admonishing him not to reveal her (Ninlil's) abode. Repeating his call, Enlil says:

'Man of the great gate, man of the lock—
Man of the bolt, man of the holy lock—
Thy lady Ninlil cometh,
The handmaid so bright, so shining.
Let none woo her, let none kiss her—
Ninlil so bright, so shining.'¹

From a kind of catch-line, it would seem that Enlil entered the city to pronounce certain decisions, but the second tablet, which would give the sequel, is wanting. For details of this deity, see *ERE* ii. 310^b; also 6 and 7 below.

2. Merodach.—Though not the oldest of the deities of the Bab. pantheon, Merodach is the most important from the present standpoint, on account of his probable human origin. The full form of his name was *Amaruduk*, 'the steer of day,' i.e. the sun in his growing strength. It is noteworthy that one of his Semitic names is *Nār-ūi*, 'light of the god (? of day),' and the character by which this is represented was read as *Asari*, compared with the Egyptian Osiris. (In cuneiform, as in Egyptian, it is composed of the signs for 'city' and for 'eye.') He was also one of the gods designated by the character for 'king,' in Sumer. probably *Lugal*, and in Sem. Bab. *Sarru* and the above-named *Nār-ūi*.

Concerning Merodach's earthly kingship we know nothing, but the royal title may refer either to that or to his heavenly authority. In consequence of the hostility of Tiamat (cf. *ERE* iv. 129), the gods decided to destroy her and her brood, but none of them had the courage to attack so terrible an adversary. Merodach, therefore, offered himself; and, aided by the powers which the gods bestowed upon him, he succeeded in overthrowing her, imprisoning her followers, and dividing her body (*ib.* 129^b). Installed as king of the gods in consequence of this great service, Merodach reconstructed the universe, and created mankind and all living things (see also *ERE* ii. 314^a, iv. 232).

¹ Cf. *Hymns* (Babylonian).

Other legends concerning Merodach are lost, but one of them, beginning, 'When Merodach was in Sumer and Akkad,' may have referred to his earthly existence. Another was 'The record of Merodach, the glorious lord, who was placed over the heavens,' by Gimil-Gula. For Merodach in his divine character, see *ERE* ii. 311 f.

3. The legend of Tammuz.—The descent of Ištar into Hades, to bring back *Dumu-zi(da)* or Tammuz, the 'husband of her youth,' proves that the Babylonians had the legend in a similar form to that in which it was known in Syria. There is no inscription, however, dealing with the cause of his premature death, so that we are in doubt whether it was regarded by the Babylonians as having been due to 'the boar's tusk of winter' or to some other cause. His release by Ištar from the domain of Ereš-ki-gal, or Ereš-š-gal, is one of the most noted productions of Bab. literature (see *ERE* ii. 313, 315^b).

4. The myth of Ura.—In this we have the legend of a seemingly purely divine hero, without any suspicion of human origin such as attached to Merodach and Tammuz. Ura (or Ira) seems to have been so called as 'the perfect one' (*[gitma]Yu* [*Cuneif. Texts*, xii. 13, 44^b]); but, as the ideograph with which the name is written is that for 'servant,' perfection of service (to the gods, or to the universe) may be intended. In the inscriptions, Ura appears as one of the forms of Nergal, the god of war, famine, plague, and destructive things in general.

In the legend, Anu, the god of heaven, gives Ura seven evil spirits to support him when prompted to 'kill the dark-heads' (mankind), and smite down the beast of the field. In a dialogue between Ura and I-šum (a destroyer like himself), the destruction wrought in Bab. cities is referred to—that at Babylon, which caused Merodach to utter 'an unloosable curse'; and at Erech, whose goddess, Ištar, was moved to wrath. Ura justifies himself, and shows his impartiality by stating that he has not spared Dēr, his own city. Secure in his own justice, Ura speaks of further punishments which he intends to inflict, and I-šum promises to follow in his footsteps, whereat Ura is pleased, and finds his words 'as finest oil.' It is thought that they were not going to spare even the king of the gods, Merodach, himself. In any case, civil war was to ravage the seacoast, Mesopotamia, Elam, the Kassites, the Sutites, the Qutites, and the Lulubites; land would not spare land, or house house, or brother brother, but they would kill each other, until the Akkadian came and overthrew them all. I-šum turned, however, first against Saršar (the Amorites), destroying the mountain of the land and its vegetation. Ura was also engaged in this work; and, when he rested, all the gods bowed down to him. He then explained to them that he had destroyed mankind on account of former sin, and he seems to ask why he should make a difference between the just and the unjust more than the others. He would favour those who glorified him and sang his praises.

5. Nergal and Ereš-ki-gal.—These deities were the king and queen of the under world, the former being the hero-god Ura under his more familiar name. The legend relates that the gods made a feast; but, as Ereš-ki-gal was not allowed to ascend to them, they requested her to send a messenger to receive her portion. This she did, and all the gods except Nergal stood up when the messenger entered. This enraged Ereš-ki-gal, who sent and demanded that the deity who had thus failed in politeness should be delivered up to her. Nergal tried to escape his doom by hiding behind the other gods, but was discovered, and sent down to Hades with fourteen companions.

Leaving these last to guard the fourteen gates of Hades, he entered, seized Ereš-ki-gal, and dragged her from her throne to cut off her head. Begging for mercy, she offered to become his spouse, and was accepted. Kissing her, and wiping away her tears, Nergal granted whatever she had asked of him 'for months past.'

6. Enlil, Tišpak, and the Labbu.—Here we have a legend which seems to supply something similar to the stories of combats with dragons in the Middle Ages. The people of the land (? Babylonia) sighed and complained on account of a giant-serpent (*muš-[gala]*) which plagued them, and which Enlil had designed in the heavens. Its length was 60 leagues, and it had members in proportion. Who, it was asked, would kill this creature, and save and rule over the wide land? Apparently the god Tišpak (Ninip as god of lustration) volunteered, and was ordered to go. The imperfection of the record leaves us in doubt whether it was he or another deity who accomplished the dragon's overthrow; but this was done by holding up before the creature 'the seal of life,' and its blood flowed (from a wound) for 3 years, 3 months, 1 day and 10 (?) [hours?]. Hrozný regards the Labbu as typifying the mists at sea—which seems probable (cf. *ERE* ii. 315^a).

7. Zû the storm-bird, and the Tablets of Fate.—Though told at some length, this legend needs but few words. A deity seems to have sent Zû, so that he saw 'with his eyes' the Tablets of Fate, and, coveting Enlil's power, decided to take possession of them, mount his throne, and rule the *Iqigi* (gods of the heavens). Taking advantage of the moment when Enlil was performing his daily ablutions preparatory to mounting his throne, Zû seized them, and flew to the security of his mountain. Enlil being thus rendered powerless, Anu, the god of the heavens, addressed himself to the gods and goddesses, asking them to get them back. All, however—Anu's son Addu (Hadad), his daughter Ištar, Bara, Ištar's child, and others—seem to make excuses, and are ordered not to go. After this Nin-igi-azaga (Ēa as god of deep wisdom) speaks to Anu, and it seems possible that he volunteered, but after this the text is wanting.

The narrative is possibly continued in what seems to be another version, known as 'The outwitting of Zû.' In this (a bilingual document) Lugal-banda (? Nergal as the fighting-cock) goes forth to the distant mountain of Sabu 'to do to the bird Zû what was right.' He would allow Zû's wife and son to sit down to their meal, and, with the aid of the wise woman Siris (wine), prepare an intoxicating drink. The text here is wanting, but in all probability the ruse was successful. Who it was who rose from Zû's nest, and made an unknown place in the mountain his refuge, is uncertain.

The possible meanings of the legends.—Notwithstanding the simplicity of these legends of heroes and hero-gods, there is apparently in each of them some hidden teaching, concerning either the early kings of Babylonia, or the gods whom they worshipped, or the dealings of those gods with men—kings, heroes, or the people in general; and in some cases it is clear that attempts were made to reconcile the seeming hardships, meted out to the innocent and the guilty alike, with the existence of the beneficent deities whom the Babylonians worshipped. There seems also to have been the desire to reconcile the different beliefs which prevailed from time to time in Babylonia—the discarding of Enlil in favour of the milder rule of Ēa, and that, again, for the divine direction of 'the merciful Merodach.' In these cases, the older deities (their names are practically records of the supremacy, at the time of their greatest influence, of the cities of which they were the chief patrons)

seem to have been classed, by the majority of the population, with those who, like Nergal the plague-god, or Addu (Hadad) the storm-god, brought misfortune upon men. Thus it comes that Enlil, 'lord of the air,' leads the gods who wish to destroy mankind by means of a flood, and forms the *Labbu*, or, according to Hrozný, mist-dragon. In like manner, the really malevolent deities, like Ura (Nergal), or the demon of the south wind, destroy mankind by means of the powers of Nature, and Eres-ki-gal (Persephone) exacts the presence of Tammuz in the under world, producing winter and its sterility.

LITERATURE.—To the works mentioned under BABYLONIANS AND ASSYRIANS (vol. ii. p. 319) may be added T. G. Pinches, *The Religion of Babylonia and Assyria*, London, 1906, and the articles 'Gilgamesh and the Hero of the Flood,' *PSBA*, 1903, pp. 113 ff., 195 ff., 'The Bab. Gods of War and their Legends,' *ib.*, 1906, pp. 203 ff., 270 ff., 'The Legend of Merodach,' *ib.*, 1908, pp. 63 ff., 77 ff., 'Istar,' *ib.*, 1909, pp. 20 ff., 57 ff., 'Enlil and Ninlil,' *ib.*, 1911, p. 77 ff.

T. G. PINCHES.

HEROES AND HERO-GODS (Chinese).—

As might be expected in the case of a people with so long an existence, the Chinese nation has produced many persons who, on account of their pre-eminence in some admirable quality, may rightly be called its heroes, and whose names are preserved in its national tradition and history. Moreover, local tradition and the system of local records have preserved the fame of many others who, though not attaining to the rank of national heroes, have a restricted celebrity. As tradition and history thus supply heroes, so the religious conceptions of the Chinese easily allow their transformation into gods.

The famous names in ancient Chinese history, back to its semi-mythical period, have been revered by the whole nation under its successive dynasties, and through all its political vicissitudes. Such names are to-day still appealed to, and must be to some extent a living force both in public and in private life. To Hwang Ti, whose reign is dated 2697 B.C., is attributed much of the beginning of Chinese polity, and for this reason it was proposed to date the Republic from his era. Yao (2356 B.C.) and Shun (2255 B.C.), virtuous monarchs of antiquity, are professed by the President of the Republic as his ideals; and in the sphere of private life a popular tract exhorts one to behave as if he beheld Yao in the pottage and Shun on the wall. These examples of heroic personages are taken from the most ancient times, and the long course of Chinese history supplies the names of many others which, being sufficiently well known to be appealed to hortatively, may be called heroic. The fame of some of these has been preserved by the salt of some pithy saying, as in the case of Yang Chên (A.D. 124), famous for his integrity, who refused a secret bribe, saying, 'Heaven knows it, Earth knows it, you know it, I know it; how can you say that none will know it?' Others have a vogue in proverbial allusion, such as Chang Ch'ang (53 B.C.), who, on the eve of unmerited disgrace and dismissal, being jeered at by an enemy as 'Prefect for but five days,' summarily vindicated his rapidly expiring authority on the person of the offender, so that the jeering phrase survives as a classical allusion to unslacking fulfilment of office. Others, again, find a place in one of those numerical categories under which the Chinese are fond of grouping men and things worthy of note, e.g. 'the Three Good Men of the Yin dynasty' (1130 B.C.), or 'the Four Sages' (Shun, Yu, Chow Kung, and Confucius). In addition to those thus commemorated in national history and literature, there are the more numerous worthies peculiar to each locality.

Many of these worthies, whether of a general or of a merely local fame, remain exemplars only.

But in accordance with what is called, perhaps not quite accurately, the animistic strain in the religious conceptions of the Chinese, it may be said that they all either are or might become objects of worship, and take rank therefore as gods. Of those who have already attained divine honour, some have been raised to it by popular opinion; in the case of others, their divine rank has been conferred or recognized by Imperial decree. Thus, the reputed inventors of some of the fundamental arts of Chinese civilization—Ts'ang Hieh, inventor of writing, the empress Si Ling She, of silk-worm rearing, K'i, of husbandry—are deified. The being everywhere worshipped as Genius of the Soil figures in history as one of the ministers of Hwang Ti. The fourth of the ministers of the same emperor has been 'metamorphosed into one of the controlling spirits of the universe, and regarded as the god of fire' (W. F. Meyers, *Chinese Reader's Manual*, no. 87). A skilled mechanic has become the god of carpenters. The case of Kuan-u well illustrates the way in which a hero becomes a god. A warrior of the era of the Three Kingdoms, famous for fidelity to his chief and for martial prowess, he was finally captured and beheaded by his enemies (A.D. 219). His name was handed down as that of a martial hero. Canonized under the Sung dynasty (12th cent. A.D.), he continued to receive additional honours, until in 1594 (Ming dynasty) he was raised to the rank of *Ti*, or god, and has ever since been worshipped as the God of War, being regarded with special favour by the late Manchu dynasty. Similarly, the Guardians of the Doors, depicted so frequently on the two-leaved doors of Chinese buildings, are historical characters of the 7th cent. A.D. They are said to have guarded the apartment of their emperor; and his commemoration of their fidelity by having their portraits painted on his doors was the first step which led to their enjoyment of divine honours. As an example of a heroine raised to divine rank, we may take Ma-tsu. A girl of Fokien, sitting with her mother spinning, went into a trance, in which she saw the boat capsized in which were her father and her two brothers. In the anguish of her affection she seized with each hand one of the drowning persons, and held up the third with her teeth. Unfortunately, her mother roused her, and she opened her mouth to reply. The facts correspond to what was done in trance: the two persons grasped by the girl's hands were saved; the third was lost, owing to the untimely opening of her mouth. Such is the story which lies at the basis of the worship of this girl as Ma-tsu, patron goddess of sailors.

In addition to those nationally, or at least very widely, recognized as divine, there are, as has been said, many others in whose case a local celebrity has culminated in a local worship. Thus, to give one example: in a village not far from Chao Chow Foo there is a temple and image in honour of a herd-boy, much sought after in times of drought, the idol being carried in procession and worshipped alike by mandarins and people. Of this herd-boy it is believed that in his lifetime he was able, by the waving of his bamboo sun-hat, to draw rain from heaven. His cult is quite local.

Regarding such hero-worship generally, it may be noted that it is somewhat capricious in the selection of its objects. If all heroes are possible objects of worship, still only some attain that dignity. None of the heroes of the Three Kingdom era enjoys such divine honours as Kuan-u. Moreover, the worship of any particular person may be early or late in its rise, and it is subject to ebb and flow in its popularity. Near Swatow there has arisen within recent years an extensive cult in honour of a monk, who, partly by supernatural means, gave to the district a much-needed bridge.

This cult, which has already somewhat declined in popularity, is recent, though the monk who is its object lived so long ago as the Sung dynasty. On the other hand, a worthy may begin to be worshipped even during his lifetime (cf. J. J. M. de Groot, *The Religion of the Chinese*, New York, 1910, p. 64). Of such worship it may be noted also that it is largely non-ethical. Its objects were distinguished, no doubt, by some excellent quality; but in being raised to divine rank they are potentialized rather than moralized, although as supernatural beings (*shên*) they may, *ex officio* as it were, be supposed to enforce the sanctions of the current ethical code. Thus the warrior Kuan-u becomes the God of War, and the rain-producing herd-boy is appealed to as Rain-producer. But in popular tracts Kuan Ti appears also, not specifically as the God of War, but as promulgating the ethical precepts inculcated in these tracts, and his power of sending weal or woe is brought forward as their sanction.

LITERATURE.—W. F. Mayers, *Chinese Reader's Manual*, Shanghai and London, 1874; H. A. Giles, *Chinese Biographical Dictionary*, London, 1898; T. Richard, *Calendar of the Gods*, Shanghai, 1906.
P. J. MACLAGAN.

HEROES AND HERO-GODS (Egyptian).—From Herodotus ii. 50 (*νομίζουσι δ' ὡν Αἰγύπτιοι οὐδ' ἠρωσι οὐδέν*) it might be inferred that the worship of heroes was unknown among the Egyptians. Yet he tells us elsewhere that they worshipped Herakles (ii. 42) and Perseus (ii. 91)—names which, it is true, can here apply only to Khonsu and Min respectively, *i.e.* to gods in the proper sense of the term. In the Hellenistic period, however, there was in Egypt a city which was actually designated 'the City of Heroes' (*Ἡρώων πόλις*). The Egyptian monuments likewise show that the religion of the country had really a place for the worship of personages who, as being deified men, must be designated heroes or hero-gods. Hence, if we are not to regard Herodotus as in conflict with himself and with facts, his words as quoted above must be taken to mean only that there was among the Egyptians no such cult of heroes as corresponded exactly with that found in Greece. In point of fact, the Egyptian deities who may be styled hero-gods do not, like the Greek heroes, occupy a position intermediate between gods and men. They are not demi-gods, but have become gods in the proper sense, and, in spite of the earthly residua that still adhere to them, were worshipped along with, and in the same manner as, real gods.

Before these heroes became gods, however, they too passed through a stage of semi-divine worship, which, as in the case of the Greek heroes, was associated with their tombs, and which may have developed from the ordinary cult of the dead to something in the nature of ancestor-worship. According to Egyptian beliefs, the 'spirits' of the departed stand midway between the gods and the king and queen (Hood Papyrus, published by G. Maspero, in *Études égyptiennes*, ii., Paris, 1893). Manetho, in one particular instance where he refers to the practice of ancestor-worship, calls them *vékves ἡμίθεοι* (see below, I. 2). The Egyptians themselves, referring to the same practice, sometimes speak of those ancestral spirits as gods, just as they often apply the term 'god' to the semi-divine king. The line of demarcation between a real god and a deified human spirit is thus far from rigid.

As regards the heroes of the Greeks and other peoples, the question often arises whether the hero-gods worshipped by the people were originally men who had been promoted to divine honours by reason of their achievements, or were at first real deities to whom a human form and human experi-

ences came to be ascribed; or, finally, whether they are literary creations which, born of poetic fancy, found a footing in popular belief. But no such question can arise in the case of the Egyptian hero-gods, except perhaps in a single instance (II. 1 (1)). For, on the one hand, the Egyptian gods, invested with human activities and regarded as kings who ruled upon earth in the far distant past (as, *e.g.*, the sun-god Rē, *i.e.* 'sun,' the earth-god Gēb, *i.e.* 'earth,' the hawk-shaped Horus, and his adversary, the animal-shaped Seth—both originally local gods), are in other respects so lacking in human traits that their divine nature cannot be doubted for a moment. Then, on the other hand, the Egyptian deities who may be called heroes or hero-gods are without exception deified men, a number of whom lived in the full light of history, and of whose earthly existence we in some cases possess authentic indications.

It is to be noted that the deification of human beings in ancient Egypt was of two kinds, viz. (1) general deification, which all who occupied a certain position in life, or suffered a particular fate, shared in an equal degree—*de jure*, as it were, and independently of any action on their own part, much in the same way as the fallen warriors of the Teutons were all admitted to Valholl; and (2) individual deification, which was attained only by individuals of special eminence. The latter class comprises those who, as akin in character to the heroes of Greek mythology, are the genuine hero-gods, who were always treated by the Egyptians as if they had been real gods; the former is composed of the semi-divine beings from whom proceeded the hero-gods.

I. GENERAL DEIFICATION.—1. It is a well-known fact that the Egyptians, from the earliest traceable period of their history, believed their kings to be embodied forms of certain gods—incarnations like the bull Apis, the ram of Mendes, and the other sacred animals. The reigning king was regarded as 'Horus' (the national god of Lower Egypt in pre-historic times, and, later, of the whole kingdom), or as 'Horus and Seth' (the union of the ancient national deities of Lower and Upper Egypt respectively), or, again, as 'the two mistresses,' *i.e.* Eileithyia and Buto (the tutelary goddesses of the two divisions of the country in the final period of the pre-historic age). The deceased king, on the other hand, ranked as Osiris (by Heliopolitan doctrine the father of Horus), and under that conception ruled over the dead, just as, under the name of Horus, he had previously ruled, and as his son and successor now ruled, over the living. From the IVth dynasty onwards the king was accounted 'the son of the sun-god Rē,' who in the form of the previous king, his human father, was supposed to have begotten him of the queen (Maspero, 'Comment Alexandre devint dieu en Égypte,' in *Annuaire de l'école pratique des hautes études* [Paris, 1897]). In a later age, again, each god was regarded within his own province as the king's father. Accordingly the reigning king was styled 'the good god' (*ntr-nfr*), or, at an earlier day, 'the great god' (*ntr'*); from the XIXth dynasty the latter designation was applied to the deceased king. When the king's real father was not himself a king, he was called 'the father of the god' (*jtj-ntr*, an expression authenticated from the XIIIth dynasty), and the worship at the king's tomb—the pyramid—was, even in the Old Kingdom (first half of the 3rd millennium B.C.), performed in a 'house of a god' (*ht-ntr*), *i.e.* a temple specially dedicated to him, and by 'servants of a god' (*hm-ntr*) and 'pure ones' (*wē'eb*), *i.e.* priests, appointed for the purpose, precisely like the worship of the real gods; while the worship accorded to all other human beings, even

queens, after death was performed simply by 'servants of a genius' (*hm-k3*), i.e. priests of the dead, and in 'a house of a genius' (*ht-k3*), i.e. chapels of the dead.

It is nevertheless probable that the ancient kings of Egypt were not honoured with divine worship in their lifetime; at least we have no evidence of such worship. When the reigning monarch appointed one of his courtiers as a *hm-ntr*, i.e. 'servant of a god,' at his pyramid (J. H. Breasted, *Ancient Records of Egypt*, Chicago, 1906-07, i. § 307), this did not imply that the person so honoured was to act in that capacity during the king's life; on the contrary, the office, with its duties, honours, and emoluments, was conferred upon him—and probably also upon his descendants—in anticipation of the king's death, i.e. for the time when the latter should be worshipped as a departed spirit. The first of the Egyptian kings to have divine honours paid to them while still alive and in conjunction with their ancestors were the Hellenistic kings of the Ptolemaic period.

2. In Heliopolis, which in the pre-historic age was for a time the capital of the whole country, a species of ancestor-worship seems to have been accorded to the *manes* of the contemporary (pre-historic) kings. They were worshipped there as 'souls of Heliopolis.' Similarly, 'souls of Hierakonpolis' and 'souls of Buto' were worshipped in these cities, the respective capitals of the two States into which Egypt was eventually divided prior to the foundation of the historical centralized State under Menes ('the union of the two lands'). As these predecessors of Menes had, in particular, worshipped the god Horus, the latter two companies of spirits were known also as the 'servants of Horus.' Moreover, they are variously designated, according to the connexion, as 'kings,' 'spirits,' or 'gods.' In Manetho they are called *νεκρες* or *ημιθεοι*. They are depicted as gods with a human body and an animal's head, exactly like the local fetish deities of the Egyptians; the souls of Hierakonpolis have the head of a jackal, those of Buto that of a hawk, and, accordingly, they are even spoken of as 'jackals' and 'hawks' respectively. From certain allusions in the texts it might seem as if, in earlier times (till 2000 B.C.), herds of jackals and flocks of hawks were kept in the two cities just named, and were regarded as incarnations of those royal souls.

See, further, K. Sethe, *Untersuchungen zur Gesch. und Altertumskunde*, iii. [Leipzig, 1901] 3 ff.; the same author in Borchardt, *Grabdenkmal des Sa'hurê*, Leipzig, 1913, ii. 102 f.

The 'souls of Heliopolis,' wherever they are mentioned, seem to be treated exactly like gods, and are associated with Atum, the local deity of that city. The dynastic kings dedicate temples and other monuments to them, and speak of themselves as beloved by them. It is possible that the name *Ἡρώων πόλις* (*Ἡρωόπολις*, *Ἡρώ*), by which the Greeks render Pithom, *Πατοῦμος*, i.e. 'house of Atum,' the name of the city dedicated to Atum, bears a reference to these 'souls.' In such translations we usually find that, when they do not give the name of the god in question, as in the case of *Διὸς πόλις*, then they have the name of his sacred animal in the plural, as, e.g., *Κυνῶν πόλις* for 'House of Anubis,' and *Κροκοδείλων πόλις* for 'House of Suchos.' In the Greek rendering of Pithom given above, therefore, the *Ἡρώες* seem to take the place of the sacred animals.

3. After the fall of the Old Kingdom (c. 2400 B.C.) the identification of the dead with Osiris, which had been customary in the case of kings, was gradually extended to others—first of all to members of the royal family, then to the feudal nobility (who at that time also arrogated to themselves other privileges of royalty), and finally to

all human beings without distinction of rank. The logical result of this should have been that in the realm of the dead there existed rulers only, and no subjects. But in point of fact the attribute Osiris seems very soon to have lost its original force. The deceased N, who is called 'Osiris N,' was in no sense identical with the *god* Osiris, who continues as before to be king in the realm of the dead, and therefore rules over the 'Osiris N' also. The dead who are so designated worship Osiris, justify themselves before his judgment-seat, etc.

4. A special apotheosis seems in later times to have been accorded to those who were drowned in the Nile, probably because, according to the legend, Osiris had suffered a like fate. Those who died in this way were regarded as having been peculiarly distinguished by the gods, and were styled 'glorified' (*häsje*)—a term which at an earlier period appears to have been applied more generally to all the blessed dead (cf. *beati*). According to Herod. ii. 90, the bodies of the drowned were entombed with peculiar pomp (cf. Griffith, in *Zeitschr. für ägypt. Sprache*, xlv. [1909-10] 132).

5. That a cult of the deified high priests of Heliopolis and Memphis existed at Pathyris in Ptolemaic times is evidenced by a number of papyri (Griffith, *Catalogue of the Demotic Papyri in the J. Rylands Library*, Manchester, 1909, iii. 132, n. 9).

II. INDIVIDUAL DEIFICATION. — I. Deified kings and queens.—(1) The earliest instance of this may have been Osiris. This deity, so highly honoured in later times, was in some remote age, as it would seem, a hero in whose person the idea of the unity of the Egyptian people came to be embodied: hence the myth of the dismemberment of his body and the distribution of the parts among the Egyptian nomes. He was regarded as having been a good and noble monarch, who was treacherously murdered, somewhat like the Siegfried of Teutonic mythology, and then restored to life by means of magic, though he did not resume his earthly existence, but lives on in the under world as king of the dead. He is always portrayed in a purely human fashion, with certain symbols of royalty which pertain to him alone among the gods—the Upper Egyptian diadem adorned with

two ostrich feathers , as also the scourge

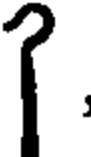
, and the crook , the primitive emblems

of sovereignty. It is possible, however, that these symbols may have been transferred to him from an ancient local deity with whom he was subsequently identified (see below). In the earlier religious literature of the 'Pyramid Texts' Osiris very seldom plays an active part like the other gods. The theme of interest is, nearly everywhere in these texts, found in his experiences, his death, and his resurrection. What had happened to him would happen also to the deceased king, who is, in fact, generally identified with him.

The suffering Osiris, thus conceived of as purely human, was in his origin as little a god of vegetation or of the dead as was Christ, with whom he has many points of resemblance. He, too, founded a confessional religion of a personal and ethical stamp, which forms a most decided contrast to the numerous Egyptian local cults based on fetishism, as well as to the Nature-religions indigenous to Egypt from primitive times (worship of the sun, the sky, the Nile), and which in the course of centuries gradually extended its range, to some extent with a conscious rejection of other forms of religion (the mysteries, communal life).

The earliest triumphs of his cult must certainly go back to a very remote past. Even while Heliopolis was the capital of a united Egypt,¹ and when the Heliopolitan theology instituted the 'great divine ennead of Heliopolis,' he not only found a place in that group as one of the representatives of the past—beside the great cosmic deities (sun, air, sky, earth) and the national god of the southern kingdom of Upper Egypt, which had been overthrown by the kings of Lower Egypt, and was now subject to it—but he actually became the centre of the whole artificial system. He was made the son of the divine pair, Heaven and Earth.² Horus again, who, as the national deity of the dominant kingdom of Lower Egypt, represented the present, and therefore remained outside the ennead, became the son of Osiris. Seth, the god of the Upper Egyptian kingdom, and now the last member of the ennead, was branded as the slayer of Osiris, and the arch-villain who had been guilty of dismembering the kingdom. These two local deities, Horus and Seth, were originally of a purely fetishistic character, and had at first no more to do with the hero Osiris than had the cosmic deities who had come to be recognized as his parents. Thus the Heliopolitan theology was even then completely under the influence of the Osirian faith.

Osiris seems to have become the god of the dead (Khentamentiu, 'the chief of the Westerners') and the god of Abydos only in the historic era, and probably in consequence of the deceased king's identification with him and of the fact that the tombs of the earliest historical kings (Ist and IInd dynasties) were situated at Abydos, the necropolis of This, their capital. It thus came about that the grave of Osiris was sought in Abydos, and was found among the ancient royal tombs there. The function of the god of the dead and the designation 'chief of the Westerners' were thereby transferred from the dog-shaped local god Anubis to Osiris (E. Meyer, in *Zeitschr. für ägypt. Sprache*, xli. [1904] 97). Between 2500 and 2100 B.C., in consequence of this development, Abydos became a pre-eminent centre of pilgrimage for all Egyptians.

If originally Osiris had no connexion with Abydos, he would seem to have had as little with his other sanctuary, situated in the Delta, and subsequently named Busiris ('House of Osiris') after him. Here, too, he either superseded or absorbed an older local god, the 'ndt) depicted as an idol in

the form . It was presumably from this deity,

who in the earlier religious literature is called 'the chief of the Eastern nomes' (of the Delta), and may perhaps have been the god of a small kingdom comprising these nomes, that Osiris acquired the symbols of sovereignty by which his images were distinguished in later times.

In Memphis, likewise, Osiris seems to have been identified with the fetish worshipped there, .

'the magnificent Ded-pillar,' as also with Ptah and Soker, only after the Old Kingdom was at an end. The violent death which, according to the legend, he met with in the waters of the Nile brought him into close relations with the sacred river itself. Like the Memphite Ptah, Osiris now came to be identified with it, and the idea of his resurrection fitted in with the annual inundation. His life and death were interpreted as referring to the

¹ About 1000 years before the dawn of the historical era, at the time when the Egyptian calendar was introduced (4242 B.C.).

² Heaven and Earth were formerly believed to be the parents of the sun-god Rē, but Rē is now at the head of the ennead and their grandfather.

growth and decay of Nature. He thus eventually became the god of vegetation, from whose corpse the corn was supposed to spring.

(2) King Sesostris III. (1887-1850 B.C.), who completed the subjugation of Northern Nubia begun by his predecessors, and protected this new province of the Egyptian kingdom by the erection of fortresses, had already become a national deity in that district in the time of the New Kingdom, and, along with the ancient Nubian deity *Dd-wn*, was worshipped under his sacred name of *Kha'-kew-rē*, which denotes his relation to the sun-god Rē (the *Rē*-name). Thutmosis III. (1501-1447 B.C.), who, in similar fashion, completed the reconquest of Nubia begun by his own predecessors, erected in that country temples, and instituted sacrifices and festivals, for the deified Sesostris. The latter was thus treated altogether like a god, but he is portrayed and designated as an Egyptian king, exactly as in his lifetime.

See Lepsius, *Denkmäler*, Berlin, 1849-60, lii. 48 ff.; Breasted, *op. cit.* ii. § 167 ff., and *History of Egypt*, New York, 1905, pp. 186, 269, 317.

(3) King Amenemmes III. (1849-1801 B.C.), the builder of the so-called Labyrinth near Hawara, at the entrance to the Fayyūm, became subsequently a tutelary deity of that oasis, for the economic development of which he (the Mœris of Herodotus?) must have done good service. Under his Rē-name of *La-ma'-rē* (*Λαμαρῖς*), in its abbreviated form *Ma'-rē* (*Μαρῖς*, *Μαρρῖς*, *Μαρρῖς*), or, with the addition of 'Pharaoh,' the later Egyptian term for king, as *Πραμαρρῖς*, *Πρεμαρρῖς*, he is frequently mentioned in monuments of the Græco-Roman period from the Fayyūm, and especially from the vicinity of his pyramid and his mausoleum (the Labyrinth). He is there depicted in the stereotyped attitude of the gods, except that his head is that of an Egyptian king and bears the royal head-band.

See further, Rubensohn, in *Zeitschr. für ägypt. Sprache*, xlii. [1906] 111 ff.; Spiegelberg, *ib.* xliii. [1906] 84 ff.

(4) Menes (c. 3300 B.C.), the deified founder of the Egyptian centralized State of historical times, is believed by Wilcken to be identical with the similarly named deity *Πραμῆνις* or *Φραμῆνις*, who is frequently mentioned in Greek papyri from the village of Tebtunis in the Fayyūm (Mitteis-Wilcken, *Grundzüge u. Chrestomathie der Papyruskunde*, Leipzig, 1912, i. 1. p. 106).

(5) King Amenophis I. (c. 1551-1535 B.C.), son of that King Amosis who expelled the Hyksos and founded the New Kingdom, was regarded, from c. 1300 B.C., as a guardian deity of the Theban necropolis. In that capacity he is often portrayed in tombs and coffins of this period—mostly in the form of a reigning king, but with the scourge and crook, as borne by Osiris. In his honour was observed the festival of *Pa-amen-hotp* ('the [festival] of Amenophis'), from which the month of *Phamenōth* derived its name.

(6) Amenophis III. (c. 1415-1380 B.C.), whose reign seems to mark the zenith of Egypt's position as a world-power, instituted in his own honour a divine cult in the temple of Soleb, in Nubia, built by himself, his name here being 'Neb-ma'-rē, the lord of Nubia,' or 'N. the great god.' In the sculptures which adorn the walls of this sanctuary, the god is depicted as being worshipped by the king himself, and is called by him 'his living image upon earth.' In the inscriptions, the king dedicates the temple to the god, and speaks of himself as being beloved by the latter. In short, Amenophis treats his deified self in every way as an independent divinity. The god is represented as a king wearing the royal head-band, but as having around his ears the twisted ram's horns peculiar to Amun in Nubia and in the Oasis of Ammon (Siwa), and upon his head a small crest

(modius) bearing the moon's crescent and disk, as worn by the ancient lunar deities, Thoth of Shmun and Khonsu of Thebes. He thus comes before us as a fusion of Amun and Khonsu.

Cf. Lepsius, iii. 86-87; Breasted, *Ancient Records*, ii. § 893 ff.

In the Græco-Roman period, the king who thus deified himself in Nubia was identified with Memnon, the legendary king of Ethiopia who came to the help of the Trojans. His colossal statues in Western Thebes, which bore the name 'Neb-ma-rē', lord of lords' (Lepsius, iii. 142, 144; Burton, *Excerpta Hieroglyphica*, Cairo, 1825-30, p. 30), are the famous colossi of Memnon, one of which, after being overthrown by an earthquake in 27 B.C., used to give forth a resonant note at sunrise, until it was restored in the reign of Septimius Severus (Letronne, 'La Statue vocale de Memnon,' in *MAIBL* x. [1833] 249). Its association with the Memnon of Greek mythology can be traced back to the Ptolemaic period, and is, therefore, of earlier date than its property of emitting sounds. In Greek documents of the middle of the 2nd cent. B.C. the name τὰ Μεμνόνεια is used of the locality called in Egyptian *Djēme*, the modern Medinet Habu, in which was situated not only the sepulchral temple of Amenophis III. with the two colossi in front of it, but also a great palace belonging to him.

It is evident, from various *quiproquos*, that the identification of Amenophis III. with the Greek Memnon is based upon his Rē'-name, Neb-ma-rē', which in that age was apparently abbreviated to Marē (Sethe, *Untersuchungen*, i. 61, n. 1; ii. 6, n. 2). In the Babylonian letters from el-Amarna, dating from the king's own lifetime, his name is rendered by Nimmuria or Mimmuria, and its contemporary pronunciation may, therefore, have been something like Nemmārē' or Memmārē'. It is thus not inconceivable that the Greek mythical figure of the Ethiopian or Egyptian Memnon, whose name is not unlike the form just given, was in reality the final residuum of Egypt's three centuries' supremacy in the Eastern Mediterranean, which, as has been indicated, culminated in the reign of Amenophis III. Moreover, it is precisely the names of this king and his consort that are met with repeatedly on objects of Egyptian origin found at Mycenæ and in Rhodes.

Among the Semitic peoples, again—unless all the evidence is at fault—the memory of this monarch would seem to have survived in the traditions regarding Nimrod, the mighty hunter of Cush (*i.e.* Nubia); and, as a matter of fact, Amenophis III. in his memorial scarabs, which, like commemorative coins, were designed to keep in remembrance the important events of his reign, has recorded not only the expansion of his kingdom from Kari in Nubia to Naharen on the Euphrates, but also his prowess as a hunter of lions and wild oxen (Breasted, *op. cit.* ii. § 860 ff.).

(7) A deified king of unknown name is found in the 'Pharaoh of Smt' (*i.e.* the Island of Bige), worshipped in the Græco-Roman temples of the Island of Philæ. In the temple sculptures he is represented as an Egyptian king with the so-called war-helmet on his head. In a Greek inscription from the Island of Sehêl he is called Περεινήμις, 'the god of Bige,' and is identified with Hermes (Sethe, in *Zeitschr. für ägypt. Sprache*, xlvii. [1910] 166).

(8) King Ptolemy Philadelphus gave orders that Arsinoë, his sister and wife, 'the goddess who loves her brother' (Φιλάδελφος), who died in 270 B.C., should be worshipped along with the local deities in all the temples of the country as θεὰ σύμμαχος, and that a tax of one-sixth of all garden-produce should be devoted to her cult. In the Fayyûm she became a nome goddess, and this fertile region was thereafter called the Arsinoite

nome. A temple of Arsinoë at Memphis is mentioned in the inscriptions of the Memphite high-priests in the Ptolemaic period. In the sculptures of the Egyptian monuments the deified queen appears as a purely human figure, but in the inscriptions she is styled 'daughter of Amun,' and 'Divine mother of the living Apis, the king of all the other divine animals.'

Cf. W. Otto, *Priester u. Tempel im hellenistischen Ägypten*, i. (Leipzig, 1905) 348; Mitteis-Wilcken, *Grundzüge d. Papyruskunde*, i. 2. p. 284; Sethe, *Urkunden d. ägypt. Altertums*, ii. (Leipzig, 1904) 106 ff.

2. Deified individuals not of royal rank.—(1) I-m-hōtep (Ἰμούθης), chief architect to Tosorthros of the IIIrd Dynasty (*c.* 2900 B.C.), the king who built the step pyramid of Saqqara, the oldest edifice of hewn stone in Egypt, is said to have discovered the art of building with that material, but was renowned in later times also as a physician, an astrologer, and the author of wise writings. In the period of the New Kingdom, *i.e.* after 1580 B.C. (one instance found in Thebes under Amenophis III.), it was the custom with writers, in beginning their work, to make a libation from their water-bowl in honour of I-m-hōtep as their patron (Schäfer, in *Zeitschr. für ägypt. Sprache*, xxxvi. [1898] 147; Gardiner, *ib.* xl. [1902] 146). By this time, therefore, he seems to have become a kind of demi-god, and to have lost his human character.

Afterwards, in the Persian period (from 525 B.C.), he became a god in the full sense, who was specially concerned with healing, and was subsequently identified by the Greeks with Asklepios. His cult was attached to his tomb, which, according to Egyptian usage, was situated beside the Pyramid of his patron; and here stood the Asklepieion often referred to in Greek papyri from Saqqara. To this new hero-god, as being originally a Memphite deity, was assigned a divine father in Ptah (Hephæstus), in place of his actual father, Ka-nofer, who is known to us from a genealogy dating from the beginning of the Persian period. His mother, Khredu-onekh, and his wife, Ronpetnofret, were also raised to divine rank, and are often found in association with him. Their names and titles clearly reveal their human origin.

In the numerous statuettes of this god which have come down to us, and which were, no doubt, dedicated to his temple mainly by persons restored to, or in search of, health, he is figured as altogether human, as a learned man sitting on a chair and reading a book (A. Erman, *Ägyptische Religion*, Berlin, 1905, p. 174). We certainly have figures on the temple walls which, while still giving him a human form, show him in the attire and with the bearing of the gods, but these figures date only from the Græco-Roman period. In that age we frequently meet with his cult also in Upper Egypt, as, *e.g.*, in Thebes and Edfu, as well as in Philæ, where Ptolemy Epiphanes erected a small temple in his honour.

Even after his apotheosis I-m-hōtep frequently receives, in addition to the epithet 'Son of Ptah' expressive of his divine origin, his erstwhile human titles, 'reciting priest,' 'expert in affairs,' etc., but only in cases where the reference is to his achievements as a man in the remote past. It is worthy of note that here he is also designated as 'Ibis,' *i.e.* as the sacred bird of the god Thoth, who was believed to have the form of that bird—a designation which re-appears in connexion with the deified individuals discussed below (nos. 2 and 3). It would thus seem that the sages of the past who were subsequently exalted to divine honours were thought of as incarnations of the god Thoth, somewhat in the same way as was indicated in I. 2, above.

Cf. Sethe, 'Imhotep der Asklepios der Ägypter' (*Untersuchungen*, ii. [1902] 98 ff.).

(2) A counterpart to this deified sage of old is met with in Theban temples on the left bank of the Nile dating from the Græco-Roman period, and also in funerary papyri of the same era. This is the famous Amen-hōtp ('*Ἀμηνώθης*, *Ἀμηνώθης*), the son of Hapu, and a native of Athribis, who had won renown by a long and honourable career as a minister of the Amenophis III. mentioned above (II. I (6)). We possess several original monuments of him, as, e.g., a portrait-statue which represents him as an old man of eighty years, and the inscriptions on which contain moral apophthegms (*Catal. général du Musée du Caire*, no. 42127; Legrain, *Statues de rois et de particuliers*, Cairo, 1906, i. 78, pl. 76), while a second bears an autobiographical inscription (Breasted, *op. cit.* ii. § 913 ff.). A third statue, four metres in height, from the temple of Karnak, and now in the museum of Cairo, likewise contains an ostensibly autobiographical record, which, however, presupposes his deification, and speaks of him in exactly the same terms as do the temple inscriptions of Energetes II. This monument, to judge from its style and orthography, cannot be earlier than the Græco-Roman period, and it bears, above its Egyptian inscription, a Greek dedication to the name of the Emperor Augustus (*RTAP* xix. [1897] 13).

This Amen-hōtp is also frequently mentioned in the monuments of his royal master. Manetho, who wrote his history of Egypt in the reign of Ptolemy Philadelphus, refers to him, under the name of *Ἀμηνώθης Πατριος* (Egyp. *Amen-hōtp Pa-hape*, i.e. 'the son of Apis'), as a wise counsellor of a king called Amenophis. It is clear, from what Manetho says of him, that Amen-hōtp had not yet been deified. Hence it is no merely accidental circumstance that our earliest evidences of his being regarded as a god all date from the reign of one particular king, viz. Ptolemy Energetes II. In all probability it was in that reign that he first became a god. With this accords the fact that, in contrast to I-m-hōtep, he is still portrayed, in the temple sculptures already referred to, in a purely human fashion: he still wears the garb of his time, and his bearing is only in part that usually assigned to the gods. Moreover, though, like I-m-hōtep, he too is styled 'Ibis,' and has received, in addition to his human mother—named 't—a divine mother in the form of the goddess of writing and reckoning (*Sst*) (Lepsius, *Text*, iii. 168), and while the name of his father, Hapu, was interpreted as indicating the sacred bull Apis, yet Amen-hōtp still retains his human titles.

As we meet with the cult of Amen-hōtp only in temples of Western Thebes, it would in all probability be associated with his tomb, which, according to the custom of his time, would be situated in the Theban necropolis and nowhere else. The sepulchral chapel attached to his tomb is referred to in a protective ordinance which survives in a later inscription, executed probably some four hundred years after the death of Amen-hōtp (Möller, in *SBAW*, 1910, p. 932 ff.), and witnesses to the long survival of his cult as a departed spirit. Amen-hōtp resembles I-m-hōtep also in being a healing god. 'I expel all disease from thy body'—so he speaks to the king, offering sacrifice to him (Lepsius, iv. 32c; cf. *JHS* xix. [1899] 13 ff.; *Catal. général du Musée du Caire*, no. 9304; J. G. Milne, *Greek Inscriptions*, Oxford, 1905, p. 37). He too is said to have composed wise maxims, and, in fact, a number of the sayings attributed to the Seven Wise Men of Greece were ascribed to him (Wilcken, in *Aegyptiaca*, *Festschr. für Ebers*, Leipzig, 1897, p. 142 ff.). Cf. Sethe, in *Aegyptiaca*, 107 ff.

(3) Ptolemy Energetes II., in whose reign, as

has been said, the deification of the sage Amen-hōtp, the son of Hapu, seems to have taken place, erected at Medinet Habu, in Western Thebes, a small temple in honour of Thoth, the god of wisdom, who appears to have been worshipped there under the designation of 'Thoth, Teos the Ibis' (*Τεοφιβίς*), and 'Thoth *stm.*' We have here a deified high priest of Memphis (*stm.*)¹ named Teos, who was thus identified with the god of wisdom, and hence also designated as 'the Ibis.' This would seem to be the same person who is referred to by Clement of Alexandria (*Strom.* i. 21 [p. 399]) as the 'Theban Hermes,' and as an instance of the deification of human beings.

Now there was, as we know, a Memphite high priest named Teos in the Ptolemaic period; according to the inscription on his tombstone (now in Vienna), he lived from 267 to 224 B.C. But, as the office of high priest in Memphis was hereditary, it is possible that he had predecessors and successors of the same name as himself. Cf. Sethe, 'Imhotep,' p. 9 (*Untersuchungen*, ii. 100 f.).

(4) In 238 B.C., by an ordinance of the Egyptian priests, the prematurely deceased daughter of Ptolemy Energetes I. was deified (*ἐκθέωσις*) under the title of *Βερενίκη ἀνάσσει παρθένων*, and it was also enjoined that 'statues of this goddess' should be set up in all the temples of the country (Decree of Canopus).

(5) Another deified man of the later era (after 900 B.C.) must—if we are to judge from the name—be recognized in the god Petesuchos or Petesuchis (i.e. Egyp. *Pete-subek*, 'he whom the god Suchos gave'). In Pliny (*HN* xxxvi. 84) he is erroneously identified with the king who built the Labyrinth. This hero-god was depicted as a crocodile, like Suchos, the old local deity of the Fayyūm, from whom he took his name. Here perhaps we have a parallel to the designation of the deified sages as 'Ibis,' the sacred bird of Thoth (see 1-3 above).

Cf. Wilcken, in *Zeitschr. für ägypt. Sprache*, xxii. [1884] 1367, and Mittelis-Wilcken, *Grundzüge d. Papyriakunde*, I. 1, p. 106.

(6) In the temple of Dendur in Lower Nubia, built in the reign of Augustus, there were worshipped, among others, two brothers named Pete-ese and Pa-hor, the deified sons of a certain Kwpr; their names seem to point to the later period. In addition to the usual designations of the dead, 'Osiris' and 'justified,' they bear the epithet 'glorified' (*hāsje*), or 'glorified in the necropolis,' and for this reason Griffith conjectures that they had died by drowning. Pete-ese sometimes receives the title 'the snake of destiny' (*sai = ἀγαθοδαίμων*) who [is] in *Ht't* (the name of the locality), placed after his own name, and, therefore, a divine epithet, while Pa-hor bears the enigmatic designation *Phri*, 'the chief' (*Φρι-*) before his own name, and, accordingly, as a human title. The two brothers are portrayed in human form, but in their bearing and garb altogether as gods.

Cf. Griffith, *Zeitschr. für ägypt. Sprache*, xlv. (1909-10) 184; A. M. Blackman, *The Temple of Dendur (Les Temples immergés de la Nubie)*, Cairo, 1911, iii.

(7) Finally, the two hero-gods just mentioned, who may possibly have owed their apotheosis to a death by drowning, would find a parallel in Antinoos, the celebrated favourite of the Emperor Hadrian. While accompanying the Emperor on his Egyptian journey, he is said to have thrown himself into the Nile in order that he might by his own death save his patron from imminent peril. On the spot where this took place Hadrian founded a Roman city, which he called Antinopolis, and in which he in all likelihood instituted a cult in honour of the youth, as a city-hero, or,

¹ The spelling of this word shows that it is not the equivalent of 'to hear,' as in the proper name *Θεοσώτης* ('Thoth, hear!'), which Spiegelberg (*Zeitschr. für ägypt. Sprache*, xlv. [1908-09] 90) would compare with it.

according to the Egyptian mode of speech, as a 'city-god' (i.e. a local deity), and this is rendered all the more probable by the fact that the Emperor caused divine honours to be paid to Antinoos elsewhere. See P. von Rohden, in Pauly-Wissowa, i. 2439.

LITERATURE.—This has been sufficiently indicated in the course of the article. K. SETHE.

HEROES AND HERO-GODS (Greek and Roman).—The belief in heroes plays a very important part in the development of Greek religion, and to an extent which literature, taken by itself, insufficiently demonstrates. The conception of a hero arose from the prevalence of ancestor-worship, when the spirit of the dead man was canonized by his descendants. Remembering the identification of demons with the ghosts of the departed (see **DEMONS AND SPIRITS** [Greek]), we shall not be surprised to find that demons and heroes are sometimes treated as indistinguishable (e.g. Plat. *Apol.* 27 D). But, when a distinction was drawn between them, demons, though inferior to gods, were, in their turn, regarded as superior to heroes (Plut. *de Def. Or.* 10, p. 415 B). This classification, which is the product of later reflexion, may be traced ultimately to the verses of Hesiod, who makes the demons the representatives of the Golden Age of man (*Op.* 122), but regards the Age of the Heroes as immediately prior to his own (*ib.* 159 ff.). These are they, he adds, who fought before the gates of Thebes, and crossed the sea to bring back fair-haired Helen from Troy; and after death they dwell free from care in the Islands of the Blessed beside the stream of Ocean. The heroes were definitely understood by Hesiod to have been men of renown, who lived in the age celebrated by epic poetry, and whose exploits had been immortalized as the achievements of a semi-divine race (*Hom. Il.* xii. 23; *Hom. Hym.* xxxii. 18 f.; *Simonid.* fr. 36). Though there is thus one point of view from which demons are preferred to heroes, it is equally true that the demonic being is a more primitive conception; and that the hero, with his clearly-marked personality and more intimate relations with his worshippers, is the product of a more advanced stage in religious thought. Further, demon is the wider term: every hero might be described as a demon, but not all demons were heroes. Although the derivation of the word *ήρωας* is unknown, there is reason for thinking that it was originally an adjective bearing some such meaning as 'strong' or 'noble' (*Hesych. s.v.*), so that it may have been an honorific title intended to distinguish the souls of those among the departed whose protection and favour it was desired to secure.

The old view that hero-worship arose from a weakening of the belief in gods can no longer be maintained in the light of recent research (Rohde, *Psyche*, 148₂). The ritual facts, as will presently be shown, are decisive against it, and the transition of thought which it assumes is by no means characteristic of the tendency of an early society. Even if it were conceded that old divinities might be re-fashioned as men, and so at a later stage come to be worshipped as heroes, that would be insufficient to prove that a hero is ever derived immediately from a god. The heroes in their original form, as ghosts of ancestors, were neither demi-gods, if that term is used to describe living warriors, nor demons, who have never been incarnate in human shape. It is more difficult to account for the fact that hero-worship, which can be shown to have flourished in the 7th cent. B.C. or even earlier, exercised—so far as we can see—hardly any influence on the practice of Homeric society. Somehow or other, old beliefs in the

power of the dead, which were temporarily obscured during the flourishing period of epic poetry, sprang anew into life and dominated popular thought in the succeeding centuries and throughout the classical era. Or it may be that, as the political system which supported the courts of the feudal chieftains fell away and decayed, the voice of the commoner, whose primitive superstition had remained unchanged, became articulate in later literature.

There are many facts which attest the connexion of heroes with the under world, and especially with the ghosts of ancestors. The central hearth of the house, under which the hero was buried (cf. Plut. *Phoc.* 37), and near to which a precinct was reserved for him, was an object of especial veneration in family-worship (cf. art. **HEARTH** [Greek]). Or an image of the hero might be set up close to the house-door (Callim. *Epigr.* 26), in order to protect the inmates against the approach of their enemies. At every family meal the second libation was poured out in honour of the heroes (Plut. *Qu. Rom.* 25, p. 270 A), and to them belonged all the broken fare which fell from the table (*Arist. fr.* 180 R.). In regard to the latter custom, Athenæus (427 E) states that dead kinsmen are actually the recipients, and it is not to be doubted that the pouring of the wine on the ground was for the benefit of the family ghosts.

Heroes were kept in remembrance by their graves, as may be seen from the case of the shrine erected in honour of Protesilaus on the shore of the Thracian Chersonese, which, though despoiled by the order of Xerxes (*Herod.* ix. 116), was still an object of veneration in the time of Philostratus (*Her.* iii. 1 f.). The grave itself was a mound of earth (*χωμα*) situated within a sacred enclosure (*τέμενος*, or, more strictly, *σηκός* [Poll. i. 6]). Over the mound a small chapel (*ήρωον*) was raised, the precinct was planted with trees, and its limits were marked by a stone wall (*θριγκός* [Paus. i. 42. 8]). The most distinctive feature of the locality was the cavity (*βόθρος*) communicating with the interior of the grave, into which the blood of the victim was poured or other offerings were cast. Thus, the tomb of the hero actually served as an altar (*βωμός*) for his worshippers, and might be so described (*Eur. Hel.* 547, with the present writer's note). Strictly, however, since no elevation was essential, a circular hollow in the ground (*έσχάρα* [Reisch, in Pauly-Wissowa, vi. 615]) was the appropriate receptacle for offerings to heroes. The sacrificial terms applied to hero-worship belong also to chthonic worship in general (for *έναγίσειν*, as distinguished from *θύειν*, see *Herod.* ii. 44), and the ritual was the same: the victims—generally black bulls or rams—were slaughtered so that the blood from their throats fell into the hollow of the altar, to be drunk by the ghost (*αμακουρία*); their heads were pressed downwards so that they looked towards the earth (*έντομα*, as explained by schol. *Hom. Il.* i. 459); none of the flesh was eaten, but the whole of it was consumed by fire; or—since the employment of an animal victim was by no means universal—when firstfruits of all kinds (*Thuc.* iii. 58) as well as cakes and cheese were offered to them, none of the gifts must be touched subsequently by the human worshippers. There is the same significance in the fact that offerings to heroes were often made by night or towards evening (*Pind. Isth.* iii. 83; *Ap. Rhod.* i. 587); in the custom of beating the ground (*Æsch. Pers.* 685), or of kneeling before the tomb (*Soph. El.* 453); and in the annual recurrence of the ceremony to commemorate the hero's death. The institution of funeral games over the grave of a dead hero was a common custom (e.g. *Paus.* viii. 4. 5), and it is generally supposed that such was the

origin of the four great pan-Hellenic festivals, which were afterwards brought into connexion with the cult of an Olympian god.

See Rohde⁴, 152; Eitrem, in Pauly-Wissowa, viii. 1126. An attempt has recently been made by F. M. Cornford, in J. E. Harrison's *Themis*, 212 ff., to explain the games as originally and essentially a New Year's festival. This view accords with the general argument of the authoress that the hero is a later conception derived from that of the year-daimon (*op. cit.* 375).

A remarkable feature in the worship of a hero is that he was supposed to appear in the form of a snake. So Cychreus was figured at Salamis, and Erichthonius at Athens (Paus. i. 36. 1, i. 24. 7). Vergil describes the arrival of an enormous snake when Æneas was celebrating the anniversary of his father's death by the performance of solemn rites at his tomb (*Æn.* v. 84 ff.). The superstitious man in Theophrastus (*Char.* 16), if he saw a snake in the house, at once erected a small chapel on the spot. The snake is also frequently depicted in the class of reliefs known as the Dead-Feast type, in which the hero is represented as partaking of a meal (Rouse, *Gr. Votive Offerings*, Cambridge, 1902, p. 20 ff.; Eitrem, 1142 f.). Plutarch, in his *Life of Cleomenes* (39), says that, after Cleomenes had been put to death by Ptolemy and his body impaled, a snake was seen wound round his head; and certain learned men explained the occurrence by propounding the theory that snakes are produced within a human corpse by the thickening of the juices of the marrow. The explanation, which is also given in a speech of Pythagoras recorded in *Ov. Met.* xv. 389, is perhaps due to the rationalizing tendency of popular opinion at a time when the superstition had ceased to be credible. Although the association of the snake with death and the grave appears to be free from doubt, it has, nevertheless, recently been maintained that the snake-attribute of a hero points to his origin as a fertility-daimon, and symbolizes the resurrection of life in the new year (J. E. Harrison, *Themis*, 271, 310).

The worship of ancestors in general culminates in the worship of a hero as the representative of the family. He is no longer one of a class in which all the members are equally entitled to veneration. There has arisen a belief that, in accordance with the measure of their achievements on earth, distinguished men are to be held in esteem after death, and that in virtue of their mysterious influence they can exercise a wide range of power over their former haunts. Thus, one who has become famous as a ruler or a warrior is selected by his immediate descendants to occupy a supreme position as eponymous founder of the clan (*ἀρχηγέτης*). In this sense Cecrops may be said to give his name to the Cecropidæ, Butes to the Eteobutadæ, Æacus to the Æacidæ, and so forth. It may be true that some of these name-givers never had any individual existence, but that their names were projected, so to speak, in order to express the unity of a clan-group (J. E. Harrison, *op. cit.* 267). But, however the actual particular facts may have come to pass historically—and it is unlikely that the development was uniform in every group—the conception of the hero in the classical age figured him as the remote forefather to whom the members of the clan proudly referred their birth. The wide-spread belief that gods and men were of the same race led to the further conclusion that the most glorious of mankind must have been of divine origin; the eponymous heroes of the clans were the sons of the gods. There is thus a difference not only of degree but of kind between the class of heroes and their mortal descendants; the progress of the religious sense has evolved a new grade of supernatural beings capable of recruitment from the ranks either of gods or of men (Eitrem, 1129).

The relationship of heroes to the gods must now be examined in detail. It frequently happens that

the chapel or grave of a hero is in the temple of one of the great gods. Saron lay in the temple of the Saronic Artemis (Paus. ii. 30. 7), Iphigenia in that of the same goddess at Brauron (Eur. *Iph. Taur.* 1462). Telmessus was buried under the altar of Apollo at Telmessus (Clem. Alex. *Protr.* ii. 45), Eurystheus in the temple of Athene Pallenis (Eur. *Heracl.* 1025), and Cleobis and Biton in the Heræum at Argos (Herod. i. 31). The list might be very largely increased; but, in order to appreciate its significance, we must rule out any suggestion that the shrines of these local worthies were superimposed on the existing sanctuaries of the Olympian gods. We should rather infer that hero-worship was a survival from an older system of religion, which preceded the establishment of the greater cults.

There are other indications which point to a conflict between the representatives of an older and a later system. Apollo drove out Hyacinthus at Tarentum (Polyb. viii. 30. 2); Artemis came to terms with Callisto in Arcadia (Paus. viii. 35. 8); and Aphrodite was identified with Ariadne at Naxos (Plut. *Thes.* 20). Sometimes the superseded hero assumed the functions of founder of the new cult, or of minister and attendant to the new god. Thus we read that Aristæus built an altar to Zeus Ikmaios in Ceos (Ap. Rhod. ii. 522); and hence the numerous stories of a god welcomed by a mortal, who was held in honourable remembrance on that account, as when Dionysus was welcomed by Icarus and Pegasus. Sometimes the god took over the honours instituted for a hero, as when Zeus succeeded to the funeral games established at Nemea as a memorial to Archemorus (Arg. to Pind. *Nem.*), or when the Rhodian celebration dedicated to Tlepolemus was transferred to Helios (schol. Pind. *Ol.* vii. 146). Sometimes, again, the Olympian has entirely effaced the reputation of the hero, whose name has been forgotten: Pausanias (i. 1. 4) mentions that there were altars at Phalerum dedicated to certain unknown gods and heroes, and also that an altar which was inscribed to an anonymous hero was known by antiquarians to belong to Androgeos. Whenever the hero has been subordinated to the god, but the recollection of his former eminence has not entirely passed away, a preliminary offering made to the hero precedes the celebration of the chief sacrifice. In this way Pelops was honoured at Olympia (schol. Pind. *Ol.* i. 149), and Scephrus at the festival of Apollo Agyieus at Tegea (Paus. viii. 53. 3); and on Mount Helicon the worshippers made offerings every year to the hero Linus before the sacrifice to the Muses (*ib.* ix. 29. 6).

If we find certain mythical personages appearing now as gods and now as heroes, the variation may be attributed either to the promotion of a hero to the status of a god or to the reduction of a god to that of a hero. The latter process, as we have already seen, cannot be used to explain the origin of hero-worship in general; but it is currently assumed as an element in the possession of heroic attributes by certain of the greater gods (Usener, *Götternamen*, Bonn, 1896, pp. 254 f., 273; Rohde⁴, 148₂; Eitrem, 1129). When Dionysus is addressed as a hero in the old ritual chant of Elis (*Poet. Lyr. Gr.* iii. 656)—the earliest example of the cult title—an explanation is drawn from his recent association in legend with Semele, the daughter of Cadmus. The growth of legendary stories about the gods, or the introduction of their names into the genealogical tables of princely families, accounts for the ambiguous position of the Dioscuri and Helen, of Asclepius and Heracles, of Theseus and Amphiaraus. Another view has recently been advocated: that the conception of an Olympian god is always later than that of the

hero from which it was developed (J. E. Harrison, *Proleg.* 326 ff., *Themis*, 365 ff.), that the individual history of the hero is due to a re-fashioning of elements derived from still more primitive cults, and that the Dioscuri and Theseus are ultimately the impersonations of fertility-daimons (*Themis*, 304, 317). The difference in treatment is exaggerated by the ambiguity of the terms employed, when one investigator uses 'god' (*θεός*) in a wider sense as including 'demon,' and another in a narrower and more refined. Thus, it is unreasonable to doubt that Helen was worshipped as a 'goddess' in the Peloponnese before the details of her heroic story were commemorated by Homer; but, on the other hand, so far from having attained to Olympian dignity, she may have been nothing more than a tree-spirit (*Dendritis* in Rhodes [Paus. iii. 19. 9]) or a local demon. The advancement of a hero to divine rank is less disputable: the Phocæan colonists at Pityoessa paid divine honours to Lampsace, who had previously been worshipped as a heroine (*Plut. Mul. Virt.* p. 255 E); the hero Tlepolemus received burnt sacrifice as a god at Rhodes (*Pind. Ol.* vii. 77); and Hippolytus was raised to heaven as a divine charioteer (*Paus.* ii. 32. 1).

When the significance of the hero as a being intermediate between gods and men was generally recognized, it became natural to apply the name—as a synonym of 'demon'—to various supernatural potencies of secondary rank. Hence it was transferred to the gods of limited jurisdiction (*Sondergötter*), whose importance for the history of religion has been demonstrated by Usener (p. 75 f.). To this class belonged the hero Acratopotes (drinker of unmixed wine) at Munychia, and the heroes Matton (baker) and Ceraon (wine-mixer) at Sparta (*Athen.* 39 C), whose function was that of superintending the slaves engaged upon the preparation and service of the meals. Similar to these were the Telchin Mylas, the demon Eunostos (miller), and the bogey Alphito (white-meal). Another group comprised the spirits which watched over vegetation. Phytius, the Ætolian, son of Orestheus and father of Ceneus (*Hecat. fr.* 341), and Phytalus, who entertained Demeter in his house near the Cephissus (*Paus.* i. 37. 2), became individualized in spite of the obvious significance of their names; but Calamites (reed-spirit), Cyamites (bean-spirit), and Hadreus (spirit of ripening) were on another footing. Another department belonged to the spirits which protected against particular evils, such as the wind-stiller (*Εὐδάνεμος*) at Athens, or the fly-hunter (*Μυλαγρος*) at Aliphera in Arcadia; and another to the guardian spirits, the sentries (*Τειχοφύλαξ*), and night-watchers (*Lucian, Peregr.* 27). Phylacus was the significant name of one of the two heroic warriors of more than human stature who protected the Delphians against the Persian invaders (*Herod.* viii. 39). In the temple of Asclepius at Epidaurus was found an inscription on the entablature of a limestone column in honour of the hero Key-bearer (*Κλεικοφόρος*), who, according to Usener (p. 265), had undertaken the responsibility for the safe-keeping of the temple. The Hesychidæ, who ministered to the worship of the Semnæ on the Areopagus, claimed descent from the hero Hesychus, and on every occasion when an offering was made to the goddesses a ram was sacrificed to him (*schol. Soph. Œd. Col.* 489). He was the impersonation of religious silence, and corresponded to the Doric hero Euphemus, who, however, is known solely from the Argonautic saga as the steersman of the *Argo*. In all the cases which have been enumerated, the heroes, except where they acquired a legendary personality, became shadowy abstractions which failed to maintain their privileges on

the advent of the fully-developed forces of the greater gods. The usual result was that they lost their identity, and survived only as epithets attached to the name of the Olympians. Hence we find Zeus Myleus and Demeter Himalis, Zeus Phytius and Poseidon Phytalius, Zeus Apomuios and Apollo Parnopios, and Zeus Euphamius, Heracles Hoplophylax, and Apollo Prophylax.

It will have been observed that the hero was believed to exercise protective power within a prescribed sphere. The grave, as we have already seen, was the cult-centre, and the influence of the hero may be said to have radiated outwards from it. Just as the hero, so long as he was regarded merely as a family guardian, was buried beneath the hearth or close to the doorstep, so, when his influence had spread to a wider circle, his tomb was placed where it might best serve the interests of the township. Thus Adrastus lay in the central agora at Sicyon (*Herod.* v. 67); Melanippus in the Prytaneum, the hearth of the State, at the same place (*Pind. Nem.* xi.); and Ætolus hard by the city-gate at Elis (*Paus.* v. 4. 4). As the blessing anticipated from the hero was dependent on the security of his grave, it was a matter of supreme importance that the remains of national heroes who had died abroad should be brought under the control of the State. Hence Cimon restored the bones of Theseus from Scyros to Athens (*Plut. Thes.* 35); Orestes was brought from Tegea to Sparta (*Herod.* i. 67), and Rhesus from Troy to Amphipolis (*Polyæn.* vi. 53); and the lost shoulder-blade of Pelops was recovered for Elis (*Paus.* v. 13. 4). Or, if a foreigner whose assistance might be needed had died in the country, it became the duty of the government jealously to protect his grave, as in the classic instances of Œdipus (*Soph. Œd. Col.* 409 ff.) and Eurystheus (*Eur. Heracl.* 1025 ff.). In the case of Tiresias, who died at Haliartia, the Thebans were obliged to be content with a cenotaph (*Paus.* ix. 18. 4). There were good reasons, therefore, for keeping the hero's place of burial concealed from strangers, lest they should molest it for their own purposes (*Soph. Œd. Col.* 1522 f.). This consideration may serve to explain why the position of the graves of Neleus and Sisyphus at Corinth was always unknown (*Paus.* ii. 2. 2). The result of such secrecy was that in certain cases the name itself was forgotten, and the locality passed under the protection of the grave of an unknown hero (*Rohde*⁴, 161 ff.). This scrupulous concern for the remains of the mighty dead was one of the features which the Christian Church inherited from paganism; and it is sufficient in this connexion to refer to the custody of sacred relics, and the burial of monarchs and bishops within the cathedral sanctuaries (*Eitrem*, 1122).

The saving qualities of the heroes might be manifested in various ways. Some of these have already been indicated, and particularly the exercise of their power by those who furthered the increase of crops. Hippolytus and Protesilaus heard the vows of lovers, and assisted or consoled them as occasion might require (*Philostr. Her.* iii. 3. 14; *Eur. Hipp.* 1423 ff.). But that was a form of activity altogether exceptional. The benefits normally to be derived from heroes may be put into three classes: (a) Help in time of danger, and especially in battle. Thus Theseus and Echelos assisted the Athenians against the Persians at the battle of Marathon (*Plut. Thes.* 35; *Paus.* i. 32. 5). Spectres of armed men were seen holding out their arms to protect the Athenian ships at Salamis: these were the Æacids, whose assistance had been invoked before the battle (*Plut. Them.* 15). On the same occasion the hero Cychreus was alleged to have appeared in the form of a serpent (*Paus.* i.

36. 1).—(b) Health in time of sickness was especially invoked from Machaon and Podalirius, the sons of Asclepius, and others of his descendants such as Polemocrates, who healed in Thyreatis (Paus. ii. 38. 6). The ritual of incubation, according to which the suppliant slept in the temple on the skin of the victim which he had sacrificed (Lycophr. 1050), is full of interest, but must not detain us here. At Athens there was a sanctuary of the hero physician (Dem. xix. 249), which reminds us of the baker and miller heroes previously mentioned. But the power of healing was not confined to those who claimed it as their particular province: Heracles was a healer in Bœotia (Paus. ix. 24. 3) and elsewhere, and Helen is said to have changed an ugly child into a beautiful woman (Herod. vi. 61).—(c) The function of divination was regularly exercised. All over Greece were oracular shrines, where the tutelary hero forecast the future, and imparted his advice to the inquirer by means of a dream. The most famous was perhaps that of Trophonius at Lebadea in Bœotia, the procedure at which is described in detail by Pausanias (ix. 39). From many others we may select as representative the sanctuaries of Alcmaeon near to Thebes on the road leading to Delphi (Pind. *Pyth.* viii. 58), of Ino-Pasiphae at Thalamæ in Laconia (Paus. iii. 26. 1, Frazer), and of the seer Anios—the father of the three Cœnotropi—at Delos (Rohde⁴, 176_s).

The power of the heroes to help corresponded with the measure of their revenge if slighted. They might bring defeat, as they did to the Persians in punishment of their impiety (Herod. viii. 109), or drought and barrenness, as when Actæon in anger ravaged the land of Orchomenos (Paus. ix. 38. 5), or when Theagenes punished the Thasians for flinging his statue into the sea, because it had fallen on one of his enemies and killed him (*ib.* vi. 11. 6 ff.). The hero Anagyros executed a terrible revenge upon an old man who had cut down a tree in his sacred grove. He inflamed the man's mistress with a passion for his son, and when, like Potiphar's wife, she accused him who had slighted her, the father blinded his son and bricked him up in a vault. Finally, the old man hanged himself, and the woman threw herself into a well (Suid. *s.v.* 'Αναγυράσιος). No wonder that men dreaded to come into the presence of such baleful spirits, that they passed by their sanctuaries in fearful silence (Alciph. iii. 58), and averted their eyes lest they should encounter their apparitions (schol. Aristoph. *Av.* 1493). To the vulgar the heroes seemed more disposed to injure than to help; but it is a hyperbole when they are described as responsible for all the sufferings of mankind (Babr. 63).

The belief in heroes and their worship can be shown to have been firmly established in Greece from the 7th cent. B.C. onwards, so long as the framework of the ancient Greek civilization continued to persist. The ordinance of Draco commanding the Athenians to worship gods or heroes in accordance with inherited tradition (Porphyr. *de Abst.* iv. 22) proves that in his days hero-worship was no innovation; and its permanence is shown by the regular combination of the names of heroes with the gods in the oaths taken upon solemn occasions (Dinarch. i. 64). The reforms of Cleisthenes recognized the importance of the heroic ancestor, whose presidency was extended from the sphere of the clan to the artificial units of tribe and deme. The hero, as local demon, had sometimes merged his identity in the name of the settlement, as may be seen from the examples of Tænarus, Marathon, and Corinthus. In other conditions he was regarded as the leader and founder of the newly-established State, as was Danaus at Argos, Battus

at Cyrene, and Tlepolemus at Rhodes. It was a natural consequence in historical times that the personage to whom a new society owed its origin or its prosperity should be advanced to the rank of these mythical chieftains. Thus we find the cult of Miltiades established in the Thracian Chersonese; and in the same neighbourhood at Amphipolis, where a festival had been founded in honour of Hagnon as *οικιστής*, the citizens afterwards transferred their veneration to Brasidas by consecrating his tomb and investing him with the annual honours of games and sacrifices (Thuc. v. 11). Other military and political services were recognized in the same way: the cult of Leonidas survived at Sparta until the age of the Antonines (Paus. iii. 14. 1), and Harmodius and Aristogiton received heroic honours at Athens (Pollux, viii. 91).

But political merit did not stand alone in earning this posthumous honour. Cleomedes of Astypalæa and Ebotas of Dyme were canonized as Olympian victors (Paus. vi. 9. 3, vi. 3. 4); Bias of Priene for his wisdom (Diog. Lært. i. 88); and Philippus of Croton for his beauty (Herod. v. 47). Here may be added the honours freely accorded to literary celebrities, among whom may be mentioned Homer, Hesiod, Archilochus, Pindar, and Æschylus. The case of Sophocles was peculiar: he had welcomed Asclepius in his home, and honoured him with regular and formal worship, and consequently he was himself worshipped as a hero after death, under the title of Dexion, 'the Entertainer' (*Etym. Mag.* 256). The philosophical schools were organized as religious societies (*θλασσοί*), and it became the rule to honour the founder as a hero (Wilamowitz, *Antigonos von Karystos*, Berlin, 1881, p. 263 ff.). There is less of historical certainty in the heroization of Drimacus, the leader of runaway slaves in Chios (Athen. 266 D), and of Pixodarus, the Ephesian shepherd, who directed the officials charged with the building of a temple to a quarry of beautiful marble (Vitruv. x. 7).

Throughout historical times the influence of the Delphic oracle in recommending the establishment of a heroic cult (*e.g.*, Herod. i. 167) was very conspicuous; for the Delphian Apollo was regarded by every Greek as the greatest of seers in all that appertained to the worship of gods and heroes. The priests, we may well believe, shared the current superstitions of their age, even if they pursued a policy of self-interest by spreading cults which owed the charter of their establishment to Delphi (Rohde⁴, 180).

The belief was ultimately degraded by the heroization of living men. The earliest recorded example is perhaps the Syracusan Dion (Diodor. xvi. 20). The servility of the age of the Diadochi was reflected in the extravagance of the rewards showered upon Demetrius by the Sicyonians (*ib.* xx. 103). Posthumous honours, not merely heroic, but divine, were granted to the representatives of the dynasties of Ptolemy and Seleucus; and the second Ptolemy took a further step forward by permitting himself to be raised to the rank of a god during his life.

An entirely different cause—the increase of affectionate regard for the dead—contributed to the secularization of hero-worship. It became the practice for religious corporations so to honour one who had held high rank in the society, or even for private individuals to endow a religious foundation in honour of themselves or members of their own family. The best-known example of the latter is the will of Epicteta of Thasos, who left directions for the heroization of herself, her husband, and her two dead sons (Hiller v. Gärtringen, in Pauly-Wissowa, vi. 124). Copious evidence of private consecration will be found in the heroic reliefs, which 'from prehistoric days to the last period of

Greek art maintain their connexion with the dead' (Rouse, 36). (For the details, see Deneken, in Roscher, i. 2556 ff.; Rouse, 19 ff.; Eitrem, 1142; J. E. Harrison, *Themis*, 313.) In Bœotia and Thessaly the word 'hero' was used from an early date as a customary epithet of the dead (*ἥρωες χρηστέ, χαίρε* [Roscher, i. 2549 ff.]), and as such was applied even to children and to slaves. In this connexion may be mentioned the declared intention of Cicero to build a shrine in honour of his daughter (Cic. *Att.* xii. 18). The last phase of hero-worship returns to the point from which it started, the family-worship of the souls of the dead.

Hero-worship was entirely alien to the native religion of Rome (Mommsen, *Rom. Hist.* i. 174, Eng. tr. [ed. 1877]); but the fully-developed notion of the hero as a warrior of Homeric epos and as a superhuman or semi-divine being passed over to the Romans as part of the mental equipment which they borrowed in consequence of their contact with Greek civilization. As the Romans had no heroic past of their own, they refurbished their ancient traditions by introducing Greek heroes into Italy, or by assimilating the forms of their native kings to the foreign pattern. The legends of the exposure of Romulus and Remus, of the translation of Romulus, and of his apotheosis, are demonstrably of Greek origin. The story of the assistance given to the Romans by the Dioscuri at the battle of Lake Regillus is exactly typical of the epiphanies of Greek heroes; and it has been shown that the details were transferred directly from a Greek account of the battle at the river Sagras between the Locrians and the people of Croton (G. Wissowa, *Religion u. Kultus der Römer*, Munich, 1902, p. 216). Later poets, of course, spoke of heroes entirely after the Greek manner, as when Horace put Numa and Cato on the same level as Hercules and the Tyndaridæ (*Odes*, i. 12), or when Vergil prophesied that the glorious child to be born in Pollio's consulship would join the throng of gods and heroes on equal terms (*Ecl.* iv. 16).

Cf. also artt. CÆSARISM, GREEK RELIGION, ROMAN RELIGION.

LITERATURE.—F. Deneken, art. 'Heros,' in Roscher, i. 2441 ff.; S. Eitrem, in Pauly-Wissowa, viii. 1111 ff.; E. Rohde, *Psyche*, Tübingen, 1907, i. 146 ff., ii. 348 ff.; P. Stengel, *Die griech. Kultusaltertümer*, Munich, 1908, p. 124 ff.; J. E. Harrison, *Prolegomena*, Cambridge, 1903, pp. 323-363, *Themis*, do. 1912, pp. 260-363. A. C. PEARSON.

HEROES AND HERO-GODS (Hebrew).—I. Hebrew heroes.—The record of heroes among the ancient Hebrews, viewed apart from the mythological idea attaching to the second part of the title at the head of this article, must be allowed to have been a particularly great one. The Book of Judges alone, with its long series of heroic struggles under the successive (and partly contemporary) leadership of men of extraordinary daring and valour, is sufficient to attest the presence of a very high degree of the heroic quality among the Israelitish settlers;¹ and the exploits of Saul, Jonathan, and David fitly round off the tale of deadly conflicts which ended in complete victory over the hostile forces on all sides.

In the history that follows these events the more distinctly spiritual type of heroism overshadows—in our view, at any rate, though it may not have appeared so at the time itself—more or less completely the military form of it, the 'hero as prophet' acquiring, and for several centuries retaining, a very high degree of significance both for his own time and for the distant ages to come. The spiritual hero wielded for the most

¹ Even Winckler, whose mythical theories may be said to reach to the farthest possible limit (see under § 2 (b)), cannot help admitting an historical basis for the history of the Judges (see *KAT*, 213-219). Concerning Samson, see note on p. 658.

part his powerful influence independently of the priesthood, or even in antagonism to it; though at times, and very powerfully so in the case of Jeremiah and Ezekiel, prophetic inspiration rested on members of the priestly order. In Ezra, again, we have a hero-priest endowed with special gifts for teaching and the re-organization of the religious life of the nation; and in the latter period of independent Hebrew polity the military successes of the Hasmonæan priest-warriors appeared to revive the heroic glories of the reign of David before the astonished eyes of the Græco-Syrian world around.

The common source of energy of all these different types of heroism lay for the ancient Israelite in the mighty strength of Jahweh. The steady possession or occasional onrush of the Divine spirit was as much required for great military and administrative achievements as for the utterance and action of the psalmist and the prophet (see, e.g., Jg 14^a, 19, 15¹⁴ [Samson's case], 3¹⁰ [relating to the judge Othniel, son of Kenaz], 1 S 11⁶ [Saul's first warlike undertaking], 2 S 23² [sacred minstrelsy], Is 11² [the ideal king]); and in special emergencies even the functions of the priest, ceremonial though they were, were invigorated by a special Divine afflatus proceeding from Jahweh, as can be seen from Hag 1⁴, where the high priest Joshua is, equally with the prince Zerubbabel, Divinely stirred up to the performance of his office, and where, indeed, the people generally are said to be similarly affected by the spirit of Jahweh.¹ Heroism in ancient Israel was, therefore, conceived as a direct effluence from Deity acting on the individual human spirit, and it may be readily conceded that Carlyle's great postulate of the 'primal reality of things' as the basis of heroism almost pales into a philosophical abstraction by the side of the intense, personal, and all-compelling manifestation of Divine force which went to the making of a hero among the Hebrews.

2. Traces of mythology.—So far, then, we have historical fact, with which—as may be admitted—a certain amount of mythical and legendary matter has in some cases been combined. Legend and myth, or speculation as to such, in the full sense of the word, first meet us when we set about to answer the question whether, or in what specified instances belonging to the period preceding the conquest of Canaan, the hero was in the mind of the primitive Hebrew identical with one form or another of Deity.

It is first of all to be noted that this part of the subject is very closely connected with the problem of ancestor-worship (see 'Hebrew' art. in vol. i. p. 444 ff.), or may in fact, in one view of it, namely that of the euhemeristic interpretation of myths,² be regarded as a branch of ancestor-worship in its wider sense, the special feature of the 'hero as divinity' consisting in this, that, whilst an ancestor or a ruler may in the course of time attract to himself the worship of men, mainly on account of relationship or exalted official position, the hero can become a god only by virtue of his inherent personal greatness. The case would, on the other hand, look entirely different if an original deity is supposed to have become transformed into a human hero, but it so happens that, in the first mythical record (designated as *a*) which we have to consider,

¹ Even for special degrees of mastery in arts and craftsmanship the indwelling and informing spirit of Jahweh was required; see Ex 28³ 31³.

² No opinion is here, however, intended to be pronounced on the question whether in any given case an originally human hero became a divinity (in accordance with euhemeristic principles), or whether an original deity later on acquired the character of a human hero. In many cases a solution of this problem is, in the present state of our knowledge, probably impossible. Our Biblical mythologists (Winckler, Ed. Meyer, and others), as will be seen later, assume the second alternative.

the two aspects of the case appear, in a manner, combined.

(a) The myth in question is contained in Gn 6¹⁻⁴. It is there related that the sons of God (or, rather, 'sons of the gods') took human wives, and that the offspring of these unions were the Nephilim (RVm 'giants'), the same having been 'the mighty men which were of old, the men of renown.' The literal meaning of this passage was for a long time naturally distasteful to both Jewish and Christian interpreters. The former (in the Targums, etc.) therefore explained the term 'sons of God' (*bēnē 'ēlōhīm*) to mean sons of judges, i.e. the noble and élite of the land, whilst to the latter the narrative referred to intermarriage between the godly men of the line of Seth and the sinful women of the line of Cain. Modern students are, however, undoubtedly right in regarding the passage as a genuine 'torso' of ancient mythology. As Driver puts it (*Westminster Com., in loco*):

'The expression "sons of God" (or "of the gods") denotes elsewhere (Job 1⁶ 21 387 . . .) semi-divine, supra-mundane beings, such as, when regarded, as is more usually the case, as agents executing a Divine commission, are called *mal'ākhim* or *ἄγγελοι* (i.e. "messengers"). And this, which is also the oldest interpretation of Gn 6² (LXX [A] Enoch 6^{2a} . . .), is the only sense in which the expression can be legitimately understood here.'

The Nephilim, who are in Nu 13³³ identified with the sons of Anak, therefore represented a race of giants¹ who were believed by the Israelites—in common, no doubt, with others—to have been the offspring of gods and human women, thus blending in their persons the character of deity with that of the human hero. As they were not racially connected with the Israelites, the belief in the existence of these hero-gods cannot, of course, serve as a *point d'appui* for interpreting the nature of genuine Hebrew heroes on a similar principle; but the belief must all the same be regarded as a genuine part of the mythological ideas prevalent in Israelitish circles (on Hebrew ideas concerning giants among other nations, see also Dt 2¹⁰⁻¹² 3^{11, 13}).

(b) A mythological theme of a different kind confronts us in the cycle of ideas which several modern writers connect with the Biblical account of the patriarchs and other personages of early Hebrew history.

There are at present in the field three main modes of interpreting the histories of Abraham, Isaac, Jacob, and Joseph (to lay special emphasis on these great Biblical figures, without, however, intending to confine ourselves to them absolutely). (1) They were real persons, and their histories are, in outline at any rate, true. If so, they head the list of the genuine Hebrew heroes of the purely human type, such as lie before us in the history of the conquest of Canaan and later times.² (2) They are historico-genealogical—that is to say, they originally represented, not individuals, but tribes or clans. (3) They are mainly, if not absolutely, to be regarded as mythological figures whose

¹ As the clause stands ('the sons of Anak are some of the Nephilim'), an identification, or rather a genealogical connexion, is clearly intended; but the clause reads like a gloss (see Gray, *ICC, in loco*), and may represent a later genealogical interpretation. The word *ענקים* apparently means 'long-necked' people, in allusion to their gigantic height; cf. Dt 3¹¹, where the bedstead of Og, king of Bashan, is described, though that king is stated to have belonged to the *ענקים*, for these are—like the *ענקים*—in all probability connected either racially or in the manner of descent with the *ענקים*. The etymology of the terms *ענקים* and *ענקים* is, however, very doubtful (see, e.g., F. Schwally, *Das Leben nach dem Tode*, Giessen, 1892, p. 64 f.). On the whole subject, see, e.g., art. 'Giant,' in *HDB* ii. 166 f. The term *ענקים*, which also occurs in Gn 6¹⁻⁴, indicates mainly physical strength coupled with warlike prowess.

² This view of the original nature of the patriarchs would not be affected by the distinct trace of later apotheosis referred to in *ERE* i. 445, though it must be admitted that the passage of Deutero-Isaiah there referred to (63¹⁶) might possibly relate to an original divinity-myth attaching to Abraham and Jacob.

legends were later on set out in the form of human histories.

Of the mythological interpretation, with which alone we are concerned in this part of the article,¹ two main streams of theory, respectively identified with the names of Hugo Winckler and Eduard Meyer, are to be distinguished.

Winckler (see *Gesch. Israels*, ii. [Leipzig, 1900] 23 and *passim*, *KAT*³, Berlin, 1903, p. 222 and *passim*, *Altorient. Forschungen*, pt. iii. [Leipzig, 1902], pp. 385-470), whose theory is dominated throughout by data drawn from Babylonian mythology, declares Abraham, Isaac, and Jacob to represent forms of the moon-god as conceived by the Semitic mind in successive stages of its astral religious contemplation, whilst he interprets Joseph, as also Lot and Esau, as forms of the sun-god. Sarah is identified with the Babylonian Ishtar, and the wives of the other patriarchs are, of course, supposed to be in one way or another the divine counterparts of their husbands. Nor does Winckler's cycle of astral deities terminate with the patriarchs and their associates. Moses is to him the sun in spring-time, and even the lives of Saul, Jonathan, and David are held to embody mythical elements of the same class, though in their case no pronouncement against their historical reality is hazarded.²

Meyer's mythological theory is in form as different as possible from that of Winckler. Rather than seek identifications for the figures of the patriarchs among the Assyro-Babylonian cults, he attempts to establish a connexion between the Biblical account of the hero-ancestors of the Hebrews and sacred localities in Canaan. To him (see *Die Israeliten*, Halle, 1906, p. 249 ff.) Abraham was originally the *numen* of Hebron, or, rather, he was one of the four divinities who had their habitation in that locality, which accordingly also bore the name *קָרְיַת אַרְבַּע*, or 'the city of four' (i.e., as Meyer suggests on p. 264, Ahiman, Sheshai, and Talmai [who are called the offspring of Anak in Nu 13²²], besides Abraham). Naturally associated with him was a deity residing in the near neighbourhood, who was called Sarah, or 'princess.' Isaac, again, is a *numen* connected with Beersheba, whilst the figure of Rebecca has to remain undefined. Jacob, according to E, was as a deity mainly associated with Bethel, whilst in J a locality in Gilead is assigned to him. His wives remain for the most part indefinite. With regard to Joseph, the possibility that a tribal eponym lies before us rather than the legend of a hero-god is left open, special stress being, however, laid on his connexion with Schem.³

It will thus be seen that, however much Winckler,

¹ It should be noted that the historico-genealogical interpretation of the data is the most in vogue among critics at the present time. Driver, however, who combines clear critical insight with a strong conservative tendency, holds that 'the view which may be said best to satisfy the circumstances of the case' is that 'Abraham, Isaac, and Jacob are historical persons, and that the accounts which we have of them are in outline historically true' (*HDB* ii. 534).

² It should here be noted that Winckler has not only had an interesting immediate predecessor in E. Stucken (*Astralmythen*, Leipzig, 1896-97), but that Ignaz Goldziher, basing very largely on Aryan parallels, and also employing the Jewish *Haggadah*, produced a rather similar cosmic theory in his *Mythology among the Hebrews* (R. Martineau's tr., London, 1877). Abraham, according to Goldziher's view as then formulated, represents the heaven at night; Sarah is the princess of heaven, i.e. the moon; Isaac ('Laughter') was originally the sun; Jacob ('Follower') is the sky at night, and his family are the moon and the stars, etc.

³ Meyer had originally (in *Gesch. des Alterthums*, Stuttgart, 1884, etc.) strongly advocated a mythological interpretation of the patriarchal history (which was also the view shared by Nöldeke). But the occurrence of the Palestinian place-names generally read Ya'kub-el and Yoseph-el in the List of Thutmosis iii. inclined him in 1886 to the adoption of Stade's view that Jacob and Joseph were originally names of tribes or clans. His reversion to his original mythological theory was largely due to the labours of Bernhard Luther, who collaborated with him in the preparation of *Die Israeliten* (see p. 249 f.).

Meyer, and their respective associates and predecessors may differ as to the special form of the mythological scheme to be adopted, they are in full agreement on the main point: the declaration that the patriarchs were originally divinities, and that the elaboration of their histories as human heroes is a late interpretation of the myths, the order of development being the exact reverse of that which is associated with the name of Euhemerus. The question as to the amount of probability with which the theories are to be credited may be regarded as an open one. A fine destructive criticism of Winckler's view was furnished by K. Budde (see *Das Alte Testament u. die Ausgrabungen*², Giessen, 1903). Cheyne expressed the following opinion (*EBi* ii. 2312): 'That there are somewhat pale mythological elements in some of the biblical narratives may be admitted; but to many minds Winckler's proof of his hypothesis will seem almost too laboured to be convincing.' The following argument (or, perhaps more fairly put, *point d'appui*) used by Winckler in *Altorient. Forschungen*, pt. iii. p. 406, will (though possibly one of the extreme instances) show how deeply steeped the mind must, as a preliminary, be in the astral mythological cycle of ideas in order to admit even a slight degree of probability in favour of his method in interpreting the Biblical text. It is said in Gn 13² that Abraham was very rich אֲרָבָה בְּצֹאן ('in cattle'). Winckler argues that in this Hebrew word we have the root אֲרָבָה = אֲרָבָה, but אֲרָבָה is nothing but an appellation of the *deus summus*, i.e. the moon. The use of אֲרָבָה therefore shows that Abraham was originally a moon-god.

Meyer's theory is, of course, quite as much as that of Winckler at variance with the usual critical interpretations of the data. Thus Cheyne, who himself adopts the genealogical scheme of interpretation, pointedly speaks of it as Meyer's 'present view' (see *Review of Theology and Philology*, ii. [1907] 414 ff.); and Gunkel (in *Die deutsche Literaturzeitung*, 1907, pp. 1925-31), though not specially referring to this part of Meyer's thesis, throws doubt on the correctness of much in his method of interpretation in general. All that can be said at present is that it would be both uncritical and unfair definitely to negative the Palestinian *numen* theory of the patriarchs in its entirety simply because it may appear startling at first sight. Specially to be noted is that for the phrase אֲרָבָה בְּצֹאן ('the Fear of his father Isaac') in Gn 31⁴³ (see also v. 42) Meyer adopts (p. 254) the very doubtful explanation which identifies Isaac himself with אֲרָבָה (i.e. 'Dread'=divinity). The forms Ya'qub-el and Yoseph-el found in the list of Palestinian place-names belonging to the reign of Thutmosis III. he would take to mean 'Ya'qub, the god' and 'Yoseph, the god' (p. 252), instead of 'El supplanteth' and 'El addeth.'

(c) Under (a) and (b) we considered respectively a myth concerning non-Israelites believed in by the Israelites, and certain mythological speculations regarding traditional Israelitish heroes. We now come to a group of heroes belonging partly to pre-Israelitish times and partly to purely Israelitish tradition. These are, to confine ourselves to leading figures of the highest order, Enoch the son of Jared, Noah, Moses, and Elijah.¹ It was shown in *ERE* i. 441 f. (see also p. 438) that there are, in the case of these spiritual heroes, clear indications of a kind of apotheosis; and it will be sufficient to add in this place that Winckler and Meyer only partially attempt to carry us here beyond the idea of deified or semi-deified ancestral heroes. Winckler, as has been seen (§ 2 (b)), believes Moses to represent

¹ Samson, whose history, as is well known, is held to embody myths of a form of the sun-god, should, however, also be mentioned in this connexion.

the sun in spring; and Meyer (p. 217) regards Enoch as 'Gott (oder Personifikation) des 365-tägigen Sonnenjahres' (see Gn 5²³; Enoch lived 365 years).¹

LITERATURE.—Besides the works named under the art. ANCESTOR-WORSHIP (Hebrew) in vol. i., and the publications referred to in the body of the present article, the reader may specially consult: F. Lenormant, *Les Origines de l'histoire d'après la Bible*, etc., 3 vols., Paris, 1880-84 (Eng. tr. of vol. i., London, 1883); K. Budde, *Die bibl. Urgeschichte*, Giessen, 1883; H. Gunkel, *The Legends of Genesis* (tr. W. H. Carruth, Chicago, 1901), particularly pp. 119-122; F. Schwally, 'Ueber einige palästin. Völkernamen,' *ZATW* xviii. (1898); Ed. Meyer, 'Der Stamm Jacob u. die isr. Stämme,' *ib.* vi. (1886) 1-16 (expressing, for the time being, agreement with Stade's genealogical theory advocated in i. 112 ff.); artt. 'Nephilim,' and on the different patriarchs in *HDB* and *EBi*.

G. MARGOLIOUTH.

HEROES AND HERO-GODS (Indian).—In Sanskrit there is no word corresponding to the Greek *ἥρωες*, denoting a famous warrior or hero promoted to divine rank and worshipped as the patron of a town, district, gild, etc. But similar ideas, though not well defined and of a much wider application, have always been prevalent in India; they have given rise to the belief in, and the worship of, a great variety of superhuman beings, of whom some are regarded as local patrons, saints, and godlings, while others have attained to the rank of supreme gods.

There is a class of Brāhmanical heroes to be mentioned hereafter, who are duly recognized in the religion of the Brāhmins; but most other Indian heroes seem to have belonged to popular religion, to the undercurrent of the various forms of higher religion acknowledged and sanctioned by the Brāhmins. We therefore find only occasional notices of, or vague allusions to, them by Sanskrit writers. As a rule, those heroes only who had become the subject of a more general or quasi-universal homage are mentioned by the Brāhmins and admitted into their pantheon. In order, therefore, to form an idea of the extent and nature of hero-worship in India, it will be well to advert first to the state of things in modern India. W. Crooke devotes the second chapter of his *Introd. to the Popular Religion and Folklore of Northern India* (London, 1896) to 'The Heroic and Village Godlings,' whom we may regard as the equivalents of the ancient heroes. Such are Hanuman of the *Rāmāyana*, Bhīma and Bhīṣma of the *Mahābhārata*, and, besides, a great number of local or village godlings of whom Crooke believes 'that most, if not all, belong to the races whom it is convenient to call non-Aryan or aboriginal, or at least outside Brāhmanism, though some of them may have been from time to time promoted into the orthodox pantheon.' In the fourth and fifth chapters ('The Worship of the Sainted Dead' and 'The Worship of the Malevolent Dead,' i. 175 ff., 230 ff.) he describes the class of semi-divine beings who in life had been men—warriors, chiefs, even robbers, or holy men—and after death had become the object of worship. Sir Alfred Lyall,² in his suggestive account of the 'Religion of an Indian Province' (Berar), bears testimony to the deification of famous men after their death. The process can be observed best, though not exclusively, with regard to saints and hermits.

'Of the numerous local gods known to have been living men, by far the greater portion derive from the ordinary canonisation of holy personages' (i. 26 f.). 'The number of shrines thus raised in Berar alone to these anchorites and persons deceased in the odour of sanctity is large, and it is constantly increasing' (i. 28). The process of deification he describes as follows. 'But, in India, whatever be the original reason for venerating

¹ Winckler's strikingly drawn parallel between Enoch, the seventh primeval patriarch in Genesis, and Enmeduranki, the seventh primeval patriarch of the Babylonian record (see *KAT*³ p. 540 f.), need not necessarily move in the sphere of ancestral heroes rather than that of original gods, though he also refers to the number 365 in Gn 5²³.

² *Asiatic Studies* 2, 2 vols., London, 1907

a deceased man, his upward course toward deification is the same. At first we have the grave of one whose name, birth-place, and parentage are well known in the district; if he died at home, his family often set up a shrine, instal themselves in possession, and realise a handsome income out of the offerings; they become hereditary keepers of the sanctuary, if the shrine prospers and its virtues stand test. Or, if the man wandered abroad, settled near some village or sacred spot, became renowned for his austerity or his afflictions, and there died, the neighbours think it great luck to have the tomb of a holy man within their borders, and the landholders administer the shrine by manorial right. In the course of a very few years, as the recollection of the man's personality becomes misty, his origin grows mysterious, his career takes a legendary hue, his birth and death were both supernatural; in the next generation the names of the elder gods get introduced into the story, and so the marvellous tradition works itself into a myth, until nothing but a personal incarnation can account for such a series of prodigies' (l. 291).¹

These references to popular beliefs and religious practices in modern India will enable us to detect the traces of hero-worship in ancient India. That it always existed cannot be doubted. For the most important factor in producing it—the cult of the *manes*—has always formed a part of the Indo-Aryan religion; even after the primitive ideas about the life after death, on which ancestor-worship is based, had been replaced by the tenet of the migration of the soul, which is incompatible with it, the offering of *śrāddha* sacrifices, which are performed in honour of the *manes*, continued to be one of the most sacred duties of the twice-born.² The close connexion between *manes* and heroes is best illustrated by the fact that the words *dis manibus*, occurring on so many Roman tombs, are rendered in Greek inscriptions of the same time *δαίμοσι ἡρώσι* or *θεοῖσι ἡρώσιον*. Not every ancestor, however, who is habitually worshipped by his descendants may be regarded as a hero in this technical sense of the word, but only such as were believed to have, in their life, achieved great or wonderful deeds. It matters little how this belief

¹ Not only holy men are venerated as gods after their decease, but also criminals, as will be seen from the following note by W. Crooke:

'Deification of robbers and bandits.—A peculiar form of deification in India is that of bandits, who are specially regarded as heroes by the criminal tribes. The Maghaiyā Doms of Bihār and the adjoining region worship Gaṇḍak and make pilgrimages to his tomb. According to their traditions, he was hanged for theft a long time ago, and when dying promised to help the Maghaiyās in time of trouble. He is worshipped by the whole tribe, and is invoked on all important occasions; but he is pre-eminently the god of theft, and a successful raid is always celebrated by a sacrifice and feast in his honour (Crooke, *TC*, 1896, ii. 326). Of the same class is Sālhes, who is worshipped by the Dusādhs (*q.v.*), a caste in Bihār and the neighbouring districts, whose profession is stealing and acting as village watchmen, preferably the former. Sālhes, they say, was the first watchman and a noted bandit, in whose honour a popular epic is chanted in Bihār (Grierson, *JASB*, pt. i. [1882] p. 3ff.). The Dusādhs of Bihār also worship Gaurāiā or Gorāiyā, another bandit chief of this tribe, whose shrine is at Sherpur, near Patna, to which members of all castes resort. The higher castes make offerings of meal, the lower sacrifice pigs and pour oblations of spirits on the ground. The cultus of this deity is, however, in a state of transition, because this low-caste robber is now identified with the potter of Bhimsen, who is quite a respectable minor god, already occupying a niche in the Hindu pantheon. Doubtless before long both Sālhes and Gaurāiā will be accepted as manifestations of one or other of the Hindu gods (Risley, *TC*, Calcutta, 1891, i. 256; Buchanan, in Martin, *Eastern India*, London, 1838, l. 192). The Banjāra (*q.v.*) tribe of carriers and sutlers, again, have a similar deity, the freebooter Miṭṭhu Bhūkhīya. In every camp there is a hut set apart and devoted to him. No one may eat, drink, or sleep in this hut, which is distinguished by a white flag. When a criminal expedition is arranged, the members of the gang meet at night in this hut, and an image of the tribal Sati is produced. A wick soaked in butter is placed in a saucer and lighted, and an appeal is made to it for a favourable omen, the worshippers mentioning the direction and object of the proposed expedition. If the wick should drop, it is regarded as a favourable omen. The worshippers immediately rise, make obeisance to the flag, and start then and there on the business which has been arranged. After the plunder has been secured, a share is set aside for the deity. Cooked food, spirits, and incense are taken to his hut, the liquor is poured at the foot of the flagstaff, the incense is burnt on the altar, and the food left in the hut. The tribal priest makes an obeisance, and all assembled thank Miṭṭhu Bhūkhīya for accepting the offering (Cumberland, *NINQ* iv. [1894] 173 ff.).'

² J. Jolly, *Recht und Sitte*, Straassburg, 1896, p. 163 f.

was brought about: by tradition, by superstition, or by fiction; whether the renown of the hero lived in the traditions of chroniclers and genealogists, in the talk of the people, in tales and legends, in the song of the bard, or in epic poetry. If the fame of a great person, historical or imaginary, is once firmly established, he is likely to become invested with a semi-divine character and to command the homage of the many. This quasi-religious veneration felt for great men of the past, though not part of the religion of the Brāhmins as taught in their books, was none the less generally acknowledged. The Sanskrit name for it is *bhakti*, a word which denotes all degrees of veneration from respectful love to the devotion of the worshipper. The feeling of *bhakti* is deeply rooted in the Indian mind, so much so that it has left traces in the structure of the language. Pānini (iv. 3, 95) teaches how words are formed to denote that a person or thing to whose name certain affixes are applied is the object of *bhakti*, love, or veneration, as the case may be. Thus from *sūtra* 98 we learn that the worshippers of Vāsudeva (*i.e.* Kṛṣṇa) and Arjuna were called Vāsudevaka and Arjunaka, and *sūtra* 99 teaches the formation of the names of those who venerate a man with a *gotra*-name or a Kṣatriya. We thus see that already at the time of Pānini, in the 4th cent. B.C. or earlier, hero-worship was a wide-spread custom. We have no detailed knowledge of the form which this worship assumed; all that can be reasonably asserted is that the places sacred to the memory of heroes were included in the great number of *tīrthas*, *i.e.* places of pilgrimage. To visit such places (*tīrthayātrā*) and to worship at them was considered very meritorious.¹ The Tīrthayātrā-parvan of the *Mahābhārata* (iii. 80-90) enumerates a great many *tīrthas*, especially in Gangetic India; the epic, of course, would mention only *tīrthas* of great fame. Some of them are dedicated to renowned ṛṣis, but the names of many suggest that they belonged originally to less famous saints or local celebrities, and only later on had divine myths or legends of ṛṣis attached to them. By the natural tendency to increase the sanctity of a *tīrtha* it came about that in the exceedingly numerous *Māhātmyas*, or descriptions of holy places, which are being fabricated up to our days and usually pretend to be parts of *Purānas*, many insipid myths of gods and incarnations are told, but few records are preserved of the humbler hero who may originally have been worshipped in that place.

We shall divide what may be called Indian heroes into two classes: ancestral heroes, and epic heroes. This division, however, is not strictly correct; for the characteristics of one class are frequently present also in members of the other; *e.g.*, many ancestral heroes have become the subject of epic poetry, and are, therefore, also epic heroes in a wider sense.

1. Ancestral heroes may be called the founders of families (*gentes*), of clans, and of dynasties. Now the Indian *gentes*, especially those of the Brāhmins, are called *gotra* (*q.v.*). Max Müller² says:

'All Brāhmanic families who keep the sacred fires are supposed to descend from the Seven Ṛṣis. These are: Bṛghu, Aṅgiras, Viśvāmītra, Vasīṣṭha, Kāśyapa, Atri, Agastī. The real ancestors, however, are eight in number: Jamadagni, Gautama and Bharadvāja, Viśvāmītra, Vasīṣṭha, Kāśyapa, Atri, Agastya. The eight Gotras, which descend from these Ṛṣis, are again subdivided into forty-nine Gotras, and these forty-nine Gotras branch off into a still larger number of Gotras. . . . A Brāhman who keeps the sacrificial fire is obliged by law to know to which of the forty-nine Gotras his own family belongs, and in consecrating his own fire he must invoke the ancestors who founded the Gotra to which he belongs.'

These ṛṣis, then, are the ἡρώες ἐπώνυμοι of the Brāhmanical *gentes*, and as such they receive a

¹ *Mahābhārata*, iii. 62.

² *Hist. of Ancient Sanskrit Literature*, London, 1859, p. 379 f.

kind of worship in prescribed forms. It may be added that some of them, especially those whom Max Müller calls the real ancestors, are the subject of legends related in the epics and *Purānas*, while about many tradition is silent except in so far as they are regarded as the authors of the hymns of the Rigveda. Not only the Brāhmins but also the Kṣatriyas¹ and Vaiśyas seem to have had, in ancient times, *gotras* of their own, some of which at least were identical in name with those of the Brāhmins. But we know practically nothing about them; they seem in the early centuries of our era to have fallen into disuse, probably because the Kṣatriyas were split into a great many clans, and the Vaiśyas into an ever-increasing number of castes, and these divisions acquired a greater importance than the old-fashioned *gotras*.²

We pass now to such ancestral heroes as are regarded as the founders of clans and dynasties. The dynasties of ancient India belong either to the Solar race (Sūrya-vaṁśa) or the Lunar race (Soma-vaṁśa). Both races go back to Manu, the son of the Sun (Vivasvat), but with this difference, that the solar race contains the descendants of Manu's sons, the lunar race those of his daughter Ilā and Budha, the son of Soma, the Moon. In this way it is explained that the Sun (Vivasvat) and the Moon (Soma) are the progenitors of the solar and lunar races respectively, while to either belongs Manu, the father and eponymous hero of mankind. The nine sons of Manu, Ikṣvāku, etc.³ are said to have founded as many branches of the solar race, and must, therefore, be regarded as their ancestral heroes. But these genealogical traditions seem to have been fixed at a time when they were already on the point of dying out; for there is some confusion even about the number and the names of these ancestors. It deserves, however, to be mentioned that one of them, Nābhānediṣṭha (who is also reckoned as two, Nābhāga and Nediṣṭha, or is called Nediṣṭha the son of Nābhāga), became a Vaiśya, and another, Pṛṣadhra, became a Śūdra, and a third one, Karūsa, founded a warrior tribe called after him. In the lunar line the first king was Purūravas, whose amours with the nymph Urvaśī have been celebrated in the Vedas, the epic, and Kālidāsa's famous play. His third successor, Yayāti, had five sons, Yadu, Turvaśu, Druhyu, Anu, and Puru, the ancestors of as many clans or dynasties, of which the Yādavas and Pauravas were the most conspicuous. In the line of Puru was born Bharata, the ancestral hero of the race of the Bhāratas, from whom India got its Purānic name Bhārata Varṣa. In his line rose Kuru, the ancestor of the Kauravas, the cousins and foes of the Pāṇdavas, whose internecine war is the subject of the *Mahābhārata*. The line of the Yādavas contains also such branches as the Vṛṣṇis, Andhakas, Sattvatas, Madhus, Krathas, and Kaiśikas, named after their founders.⁴ These instances, which might easily be multiplied, may suffice to show that the ancient history of India, of which the epics and the *Purānas* have preserved only fabulous and distorted records, abounds with ancestral heroes. Some of them may have been historical persons, but many have probably been invented and set up by bards and genealogists in order to account for the origin of a clan or a line of rulers whom they served. Such a process of hero-making is, of course, not confined to ancient times; it was going on also in

¹ J. F. Fleet, 'Dynasties of the Kanarese Districts,' p. 277 f. notes (*BG*, General chapters, 1895).

² It may, however, be mentioned that the Jain writer Harihadra (9th cent. A.D.) speaks of the *gotra* of the Śrāvakas, most of whom certainly did not belong to the caste of the Brāhmins (*Dharmabindu* [*Bibl. Ind.*] i. 15, and the remarks of the commentator Munichandra on that passage).

³ *Viṣṇu Purāna*, tr. Wilson, London, 1864-70, iii. 231 f., and 13.

⁴ J. Dowson, *Class. Dict. of Hindu Myth.* etc.⁴, London, 1903, ii. 49 f.

mediæval India, as will be seen from the following instances. The Rāṣṭrakūṭas descended from a prince of that name, the son of Raṭṭa, who belonged to the Sātyaki branch of the Yādavas.¹ The Chālukyas derived their origin from a hero sprung from the *chuluka*, or water-vessel, of Brahmā. 'From him descended the Chālukyas, a race of heroes, among whom Hārīta is reckoned as first progenitor, and Mānavya arose who humbled the kings of the earth.'² Paramāra, the eponymous hero of the Paramāra race of Kṣatriyas, issued from the sacrificial fire of Vasiṣṭha on Mount Arbuda.³ According to modern tradition, the races or mediæval regnal houses of the Chālukyas, Chāhamānas, Pratihāras, and Paramāras are the four *agnikulās* which originated from the *agnikunḍa* on Mount Abu. Prominent rulers have arisen in these races who have in their turn been acknowledged as heroes by their clans and become the subjects of the homage of their descendants.

Another class of ancestral heroes which was very numerous and important in Greece, the founders of cities and patrons of districts, is not absent in India; but it is of little importance. Most famous towns, according to popular opinion, are of a fabulous antiquity; witness the legends of the Buddhists and the Jains. These relate events which are believed to have occurred many millions (even oceans) of years ago, and yet lay the scene in countries and towns that flourished in historical times. Yet some legends about the founding of towns are met with in the epics and *Purānas*. According to *Rāmāyana*, i. 32, the four brothers Kuśāmba, Kuśanābha, Asūrtarajas, and Vasu founded the towns Kauśāmbī, Mahodaya (Kānyakubja), Dharmāranya, and Girivraja; Viśāla, son of Ikṣvāku, founded Viśālā (i. 47); Satrugna, Madhupurī, or Madhurā (Mathurā) (vii. 70); Bharata's sons Takṣa and Puṣkala, Takṣilā and Puṣkalāvati; Lakṣmaṇa's sons Aṅgada and Chandraketu, Aṅgadiya and Chandrakāntā (vii. 102); Ṛṣabha became the second founder of Ayodhyā, after it had been deserted on the death of Rāma (vii. 111), etc. These epic notices about founders of towns, whether they be records of popular traditions or inventions of the poet, prove at least that this kind of hero was known in India, and we may assume that as local heroes they got their share of *bhakti* in one form or another.

2. We now come to the epic heroes, i.e. those personages described in the epics whom popular admiration and veneration have promoted to a superhuman or semi-divine rank. Epic poetry seems to remove from the everyday sphere all persons and things that make part of the narrative, and to invest them with an exalted character. Every beginner in Sanskrit remembers how, in the opening of the story of Nala, Indra inquires after the warriors and kings who used to visit him as his dear guests, but at that time stayed away on account of Nala's *svayamvara*. Thus, the principal persons of the epics have a tendency to become heroes in the technical sense of the word, and, once having entered upon their upward career, they may end with being regarded as gods. The most instructive instance is the hero of the oldest epic, the *Rāmāyana*. In the original parts of that work (viz. books ii.-vi.) Rāma is still a human hero, the best of men, the supreme model of morality and loyalty; notwithstanding his association with superhuman beings, the monkeys, and his fight with, and victory over, the demons (Rākṣasas), he remains essentially a man. But in the first and last books, which are decidedly later in origin and of a different

¹ R. G. Bhandarkar, 'Early History of the Dekkan,' in *BG*, vol. i. pt. ii. (1895) p. 63.

² *Vikramānkadevacharita*, ed. Bühler, Bombay, 1875, introduction, p. 26 (Bombay Skr. Ser.).

³ *Navasahasāṅkacharita*, xi. 64 ff. (*ib.*).

(*Purāna*-like) character, the authors regard him already as a god—an incarnation of Viṣṇu.¹ As such he has been adored ever afterwards down to the present day. The case is somewhat different with regard to Kṛṣṇa in the *Mahābhārata* and the *Purānas*. The authors of these works frequently declare him to be a supreme god, an incarnation of Viṣṇu; yet in most of his adventures, from his killing of his uncle Kaṁsa down to his death by the arrow of the hunter-Jara (Old Age), we seem to recognize the miraculous records of a tribal chief who had come to be worshipped as a true hero by the members of his clan. But he seems early to have been combined or identified with a cowherd-god, Govinda, 'the cow-finder,'² and this coalescence with a deity probably brought about the deification of Kṛṣṇa as an incarnation of Viṣṇu. He became one of the most popular gods of the Hindu pantheon.

Rāma and Kṛṣṇa are the epic heroes who have reached the highest possible rank; others have become minor deities, e.g. Hanuman, and some true epic heroes of human standing, e.g. Bhīṣma. But at the time when such heroes were celebrated in epic songs they had already, as it were, accomplished a part of their career. Some may always have been regarded as men who were the centres of an ever-increasing epic cycle; others, however, may once have been popular gods who were losing their rank somehow, and therefore were represented by the poets only as superior men; e.g., Arjuna seems to retain some marks of an originally divine nature; he is intimately connected with Indra, his father, in whose heaven he lives for five years, and he vanquishes the Asuras (Nivātakavachas, Paulomas, Kālakāñjas); Pāṇini, iv. 3, 98, mentions his worshippers along with those of Vāsudeva (Kṛṣṇa). Karna, the son of the Sun-god, is born with the mail-coat and the earrings of that god, of which he is cheated by Indra. Bhīma, who is now worshipped as a hero in the whole of India, betrays, in the great epic, many traits of a demonic (Rākṣasa) nature: his association with Rākṣasas, his ravenous appetite (Vṛkodara), and his ferocity (he tears off the arm and drinks the blood from the breast of Duṣśāsana). The heroine of the *Rāmāyana*, Sītā, is described in the old parts of that work only as the loving spouse of Rāma; but, as her name, which denotes 'furrow' and 'agriculture,'³ her origin from, and her return to, the interior of the earth, indicate, she was originally a chthonic deity. The present writer is also inclined to believe that Hanuman was a godling before Vālmiki sang of his friendship with Rāma, whereby he came to be recognized as a popular deity throughout India. We thus see that epic heroes may be men, historical or fictitious, on promotion; or, on the other hand, they may be gods and divine beings on the decline.

Now, as regards the epic heroes who actually were worshipped, besides Rāma, Lakṣmaṇa, Sītā, and Hanuman, Kṛṣṇa, Baladeva, etc., who are generally acknowledged gods of the Hindu pantheon, we must chiefly rely on the testimony of

¹ In an inserted passage of the sixth book, vi. 170, Rāma is still ignorant of his divine character, and Brahmā is introduced to explain the identity of Rāma with Nārāyaṇa. It may be mentioned that the Jains, both Svetāmbaras and Digambaras, possess a very old version of the story of the *Rāmāyana* fabricated with a strong sectarian bias. In this Jain *Rāmāyana* (*Padmācharita* and *Padmapurāṇa*), Rāma is frequently called Nārāyaṇa; but his most common name is Padmanābha (abbreviated into Padma), a synonym of Viṣṇu.

² According to Kātyāyana (Pāṇini, iii. 1, 188, *vārttika* 2), Weber's explanation of *govinda* as the Prakrit for *gopendra* is scarcely admissible, for the supposed change of *p* to *v* belongs to a more advanced state of the Prakrit language than may be assumed for the Prakrit at the time of Kātyāyana.

³ Sītā has this meaning in the title of an official in the king's service—*sītādhyakṣa*, 'superintendent of agriculture' (*Kaṭṭhīya Arthadāstra*, ii. 24).

modern popular religion and folklore. They seem to form a class of superhuman beings who are known as the *chirajīvins*, i.e. the long-living or immortal ones. A *versus memorialis* in Sanskrit¹ enumerates seven *chirajīvins*: Aśvatthāman, Bali, Vyāsa, Hanuman, Vibhīṣana, Kṛpa, and Paraśurāma; a quotation in the *Śabda Kalpa Druma*² adds an eighth—Mārkaṇḍeya. The belief in *chirajīvins* can, however, be traced back to comparatively early times. In the 108th *sarga* of the Uttarakāṇḍa of the *Rāmāyana*, Rāma commands that Hanuman and Vibhīṣana should live as long as the *Rāmāyana* shall exist; verse 33 adds Jāmbavat, Mainda, and Dvidida, and says that they will live 'till the Kali comes.' The commentator says that Hanuman and Vibhīṣana will live till the destruction of the world, but Jāmbavat, Mainda, and Dvidida³ will die during the incarnation of Kṛṣṇa. It is, therefore, probable that the class of heroes continuing to live and removed to a higher sphere was originally more numerous than the verse alluded to above would make us believe.

Besides these never-dying heroes there probably were a great many others who were believed to have died, yet still received some kind of homage, though in most cases we have no accurate information about them. On the evidence of modern folklore, we may safely reckon among them Bhīṣma and the five Pāṇḍavas, especially Bhīma, who seems to have been a favourite of the people in many parts of India.

3. In modern India there is a third class of heroes—the departed saints and ascetics. There can be no doubt that there were such in ancient India also; but, being of local importance only, they did not find their way into general literature, and were ousted, as it were, by the great *ṛṣis*. Those, however, who might be included in this class have been treated of above among the ancestral heroes.

LITERATURE.—The necessary references have been given in the article itself. It may be mentioned that the subject has not been treated before. HERMANN JACOBI.

HEROES AND HERO-GODS (Iranian).—In the conventional sense of the word, the Iranians possessed many heroes of whom more or less legendary tales were told; and several passages of the Avesta—notably *Yasna* ix., and *Yasts* v., xiii., xix.—record traditions of a number of them, such as Vivahvant, Yima, Athwya, Thrīta, Urvāxšaya, Keresāspa, Haošyanha, Thraētaona, Usan, Haosravah, Tusa, Pāurva, Jāmāspa, Ašavazdah, Vistarū, Yōišta, Vištāspa, Zairi-vairi, Urupi, Kavāta, Aipivanhu, Usadhan, Aršan, Pisinah, Byaršan, and Syāvāršan; and these heroic figures, with others, recur throughout Pahlavi literature and in the *Šāh-nāmah* of Firdausi.

Of heroes in the technical sense, however, Zoroastrianism knows nothing, though in that religion marked traces of ancestor-worship exist (see artt. ANCESTOR-WORSHIP AND CULT OF THE DEAD [Iranian]; FRAVASHI). In all Zoroastrian literature the nearest approach to anything in the least suggestive of a hero-cult is *Yast* xiii. 17.

'They, the *fravashis* of the righteous, give most help in battle fierce; the *fravashis* of the righteous are most mighty, Spitama [Zarathuštra], those of the first teachers of the faith, or those of men unborn, of the Saōyants, the preparers [of the world for the final restoration]; but the *fravashis* of other living righteous men are more mighty, Spitama Zarathuštra, than [those] of the dead.'

Old Persian literature is silent on the subject of heroes, but in Greek references to the Persians we find what seem at first blush to be allusions to these apotheosized men of renown. On arriving at Pergamum, on the river Scamander, Xerxes

¹ Quoted in *Indian Antiquary*, 1912, Supplement, p. 54, note.

² Böhrling-Roth, *Skr. Wörterb.*, St. Petersburg, 1855-76, s.v. 'Chirajivin.'

³ Mainda and Dvidida are also two demons killed by Kṛṣṇa and Baladeva.

'sacrificed a thousand kine¹ to Ilian Athene, and the magi poured libations to the heroes' (χρᾶς δὲ οἱ μάγοι τοῖσι ἥρωσι ἐχέαντο [Herod. vii. 43]). Furthermore, Xenophon makes Cyrus the Great offer prayer 'to the gods and heroes who occupy the Persian land' (θεοῖς καὶ ἥρωσι τοῖς Περσίδα γῆν κατέχουσιν [Cyrus. II. i. 1; cf., however, the simple θεοῖς τοῖς Μηδῶν γῆν κατέχουσιν immediately following]), 'to the heroes who inhabit and protect the land of Media' (ἥρωας γῆς Μηδίας οἰκῆτορας καὶ κηδεμόνας [ib. III. iii. 21]), to 'the gods and heroes of Assyria' (ib. § 22), and 'to the heroes who hold Syria' (ἥρωσι τοῖς Συρίαν ἔχουσι [ib. VIII. iii. 24]). Yet, side by side with Xenophon's reference to 'the gods and heroes who occupy the Persian land,' Herodotus (vii. 53) makes Xerxes pray simply 'to the gods who guard the Persian land' (τοῖσι θεοῖσι τοῖς Περσίδα γῆν λεύεσσι). A. Rapp had, therefore, good reason to declare (ZDMG xix. [1865] 66 f.) that the Greeks, in their references to the Persians, used ἥρωες and θεοὶ synonymously; and in this connexion it is noteworthy that Strabo (p. 733) says that 'the deeds of the gods and of the noblest men' (ἔργα θεῶν τε καὶ ἀνδρῶν τῶν ἀρίστων) were imparted in the course of instruction, the omission of all allusion to heroes being at least curious if their cult was of any importance.

There is, however, a possible identification of these 'heroes' of Persia and of other countries, for the Greek accounts seem to be in general more accurate than is often supposed. It would appear that the 'heroes' in question are none other than the *fravashis*, who not merely guarded the house, village, district, etc., but were also 'for the protection of the Aryan lands' (*thrāthraī airyanām dahyunām* [Yast xiii. 43]), and, indeed, 'of all lands' (*vīspanām dahyunām* [ib. § 21; cf. Yasma xxiii. 1]). It is possible that there may have been a hero-cult in ancient Iran at a very early period; but, if there was, it had been merged in the worship of the *fravashis* before the date of our oldest records concerning the Iranian race; and all traces of it, if it ever existed, have long since vanished.

LOUIS H. GRAY.

HEROES AND HERO-GODS (Japanese).—

The essential basis of Shintō was a primitive Naturism, from which Animism was gradually developed. Just as the ancient Japanese used to worship the forces of Nature, so they bowed before human powers. Out of the admiration which they felt for certain visible and living men grew the more abstract worship of the same men after their death. The deification of heroes began, then, in the adoration of famous living men—a form of worship which constitutes a sort of transition between Naturism and Animism, and which is the tangible germ of all after-development.

In order to understand this basis aright, we have only to remember that, in the conception of the Japanese, as, indeed, of many other peoples, a god is not, as he is to our modern ideas, a being immeasurably above and beyond humanity, but simply, as the word *kami* indicates, a 'superior' being. Between a powerful man and a god there is a difference only of degree, and a great man may easily become a minor god. We find a confirmation of this, in historical times, in the divine honours paid to the Emperor—an evident survival of a wider deification.

Originally all men of note who were above the ordinary level seem to have been worshipped. The first objects of this adoration were the ancient chiefs or independent kings, of whom we are continually reminded, even after the triumph of

¹ The sacrifice of a thousand kine (together with a hundred stallions and ten thousand sheep) has a genuinely Iranian ring; cf., for example, Yast v. 21, 25, etc., ix. 3, 8, etc.

Imperialism, by the 8th-cent. annals (see *Kojiki*, 167 ff., 173, 185, 189, etc.). The Emperor himself is often required, and consents, to worship local gods, who are the souls of ancient chiefs (ib. 179, 215, etc.); and the honour thus paid to the shades of departed chiefs, like that given to Imperial ancestors, leads us to think that these chiefs must have been worshipped in their lifetime, just as the Emperor himself was. Besides, mythology is full of descriptions of wars between 'gods,' who were, without doubt, human chiefs (ib. 167, 178, 260 f., 264, etc.). The worship of the Emperor was only the synthesis of the cults of these local chiefs, just as the Imperial power finally united in its own person all the separate local powers which had formerly existed.

The next in order are the sorcerers, who were originally, before the division of social work, often identified with the chiefs themselves; thus, on the day of his accession to the throne, we find Jimmu, the first legendary Emperor, instructing one of his followers in the magic formulæ (*Nihongi*, i. 133). These sorcerers, when they accomplished anything which seemed particularly wonderful to their neighbours, were naturally the object of an admiration which finally merged into worship, continuing at first during their lifetime, and, later, even after their death. Just as the adoration of powerful chiefs was an instinctive homage paid by weakness to superior force, so the worship of a 'medicine-man,' famous for his miraculous gifts, is the natural homage paid by ignorance to superior intelligence. The Japanese gods are magicians (see *Kojiki*, 83 ff., 149 ff., etc.), and it may readily be conceived how, on the other hand, magicians may easily turn into gods. Thus, even to-day, by a titular survival of these ancient beliefs, the high-priest of Kizuki, in Idzumo, is called *iki-gami* ('living god').

In the same connexion we must mention also the inventors of arts, the importers of useful articles, and all the great benefactors whose intelligence or skill arouses gratitude and demands respect. In Shintō mythology, we find first of all the worship of the group of illustrious gods, who, under the direction of Omohi-kane, the god of cunning, invented the principal arts, beginning with the art of the blacksmith, whom the primitive people were most willing to consider as a veritable magician (*Kojiki*, 63-65). Then come the gods Oho-kuni-nushi, a powerful chief, and Sukuna-biko-na, a dwarf-wizard, who not only completed the material construction of the country, begun by the Creator-Pair, but also taught men magic and medicine (see *Nihongi*, i. 59); then the great god Susa-no-wo, who had already gained fame, in a well-known myth, by delivering a young princess from the monster-serpent of Koshi, which was about to devour her, and who also, with the help of his son Itakeru, the 'deserving god' (*isaoshi no kami*), created, by tearing and dispersing the hairs of his body, the cedars and camphor-trees for the construction of ships, the thuyas for the building of palaces, the podocarps for the manufacture of coffins, while at the same time he sowed and caused to grow all kinds of fruit for the nourishment of human beings (*Nihongi*, i. 58). Along with these gods appears another beneficent being, Mi-wi-no-Kami, who sank wells in several parts of the country (*Kojiki*, 88).

All these gods, who were at the same time magicians and inventors, were without doubt originally real personages, whose fame was only increased by legend. So, Sukuna-biko-na, the mysterious dwarf who is depicted as arriving on the crest of the waves in a tiny boat made out of a berry in the form of a long gourd, and dressed in the skin of a bird, and who, after having done

wonderful deeds, disappears by climbing up a stalk of millet, from which he is carried away to another world, no doubt finds his prototype in the miraculous visit of some strange sorcerer (see *Kojiki*, 103; *Nihongi*, i. 59 f.). Strangers, indeed, were often considered as beings of superior nature; the god who imported plants, Itakeru, seems to have belonged to Korea (see *Nihongi*, i. 58), and here and there we find traces of the worship of other Korean 'divinities' (*Nihongi*, i. 11, 169, 225, 378).

Finally it may be said in a general way that, just as the natives, crushed by the conquerors, are deified under the general name of 'evil gods,' 'demons,' or 'savage gods' (*Kojiki*, 167, 178, etc.; *Nihongi*, i. 198, 202 f., etc.), so the conquering race as a whole also invests itself with divinity, and, claiming descent from Heaven (*Kojiki*, 72, 112-135, etc.; *Nihongi*, i. 110 f., 128), proclaims itself as the only true race of gods.

All these elements—the power of the political chiefs, the magic of the sorcerers, the skill of the inventors, the quarrels between tribes—intermingle and end in one central cult which is at once the result and the proof of its manifold origin. The Emperor, having become both the undisputed master and the high-priest of the nation (*matsurigoto*, 'government,' comes from *matsuri*, 'cult'), and being considered as the direct descendant of the most illustrious gods—from the goddess of the Sun downwards—ends by being the supreme personification of all the glories of the State. He is regarded as the only 'incarnate god' (*ara-hitogami*, or *ara-mi-kami* [*Nihongi*, ii. 198, 217, etc.]); he believes himself to be so, and assumes this title in his own edicts (*ib.* ii. 210, 226 f., 359). Sometimes, even in his own lifetime, he has the funeral-mound erected, the immense *misasagi*, where he will continue to be worshipped after his death (*ib.* i. 298 ff.; cf. ii. 178). So much is the Emperor considered all-powerful, that, in the ancient annals, the most famous heroes are always classed, like personages of secondary importance, under the name of the Emperor whose reign they have served to make famous. For example, in the *Kojiki*, the whole legend of Yamato-dake is entitled 'Emperor Keikō,' in spite of the small part played by him, and the entire story of the Empress Jingō, the legendary conqueror of Korea, is called 'Emperor Chuai,' although the exploits of the heroine begin exactly on the death of her husband (*Kojiki*, 248-278, 283-298).

Here we have a proof of the existence of a movement in the evolution of Japanese hero-worship which tends to diminish little by little the importance of individual famous men so as to increase the glory of the Emperor, in whose person all the traditions are united. But at the same time there still exists, and that in a profoundly living form, the worship of true heroes—ancestors who have wrought mighty deeds, and great benefactors, the conquerors of the islands and the civilizers of the country, the monster-killers and inventors, all those eminent men whose memory has been handed down by popular favour, and whose fame occupies an increasingly large place in the heart of new generations.

As a typical example of these deified heroes, we may quote Yamato-dake, 'the Brave of Japan,' the most famous figure of legendary times. This hero, who, according to traditional chronology, lived about A.D. 100, was the third son of the Emperor Keikō. The first of his exploits, while showing his loyal respect for his father and sovereign, is sufficient to indicate the violent character of the mighty deeds which were to make his career famous. He began by assassinating one of his elder brothers, who had omitted to appear at the 'morning-and-evening-great-august-repasts.' The

Emperor, angry at such negligence, had charged Yamato-dake, then a youth of sixteen, to recall his elder brother to a sense of his duties, and five days later, as there had been no appearance of the brother, he asked his youngest son if he had fulfilled his orders. Yamato-dake replied that he had not failed to do so, calmly adding an explanation of how he went about it: 'I grasped hold of him, and crushed him, and, pulling off his branches [*i.e.* limbs], wrapped them in matting and flung them away.' It may be imagined that the Emperor showed himself somewhat 'alarmed at the valour and ferocity of his august child's disposition.' He therefore sent him off at once to the West, to fight against two warriors of the country of Kumaso, who were rebelling against the authority of the Emperor. The manner in which the young prince acquitted himself on this mission will be a sufficient example of the general character of these heroes of primitive Japan, with whom cunning occupies as large a place as courage.

'On reaching the house of the Kumaso braves, His Augustness Wo-usu [the name given to Yamato-dake as a child] saw that near the house there was a three-fold belt of warriors, who had made a cave to dwell in. Hereupon they, noisily discussing a rejoicing for the august cave [a house-warming], were getting food ready. So he sauntered about the neighbourhood, waiting for the day of the rejoicing. Then, when the day of the rejoicing came, having combed down after the manner of girls his august hair which was bound up, and having put on his aunt's [Yamato-hime, the high-priestess of Ise] august upper garment and august skirt, he looked quite like a young girl, and, standing amidst the women [concubines], went inside the cave. Then the elder brother and the younger brother, the two Kumaso braves, delighted at the sight of the maiden, set her between them, and rejoiced exuberantly. So, when the feast was at its height, His Augustness Wo-usu, drawing the sabre from his bosom, and catching the elder bravo of Kumaso by the collar of his garment, thrust the sabre through his chest, whereupon, alarmed at the sight, the younger bravo ran out. But pursuing after and reaching him at the bottom of the steps of the cave, and catching him by the back, Prince Wo-usu thrust the sabre through his buttock. Then the Kumaso bravo spoke, saying: "Do not move the sword; I have something to say." Then His Augustness Wo-usu respited him for a moment, holding him down as he lay prostrate. Hereupon the bravo said: "Who is Thine Augustness?" Then he said: "I am the august child of Oho-tarashi-hiko-oshiro-wake [the governing Lord, the prince perfect and great, primitive name of the Emperor Keikō], the Heavenly Sovereign who, dwelling in the palace of Hishiro at Makimuku, rules the Land of the Eight Great Islands; and my name is King Yamato-wo-guna [the young man of Yamato, another name for the prince]. Hearing that you two fellows, the Kumaso braves, were unsubmissive and disrespectful, the Heavenly Sovereign sent me with the command to take and slay you." Then the Kumaso bravo said: "That must be true. There are no persons in the West so brave and strong as we two. Yet in the Land of Great Yamato there is a man braver than we two. Therefore will I offer thee an august name. From this time forward it is right that thou be praised as the August Child [*i.e.* Prince] Yamato-dake [*i.e.* 'Yamato-Brave,' the Bravest in Yamato]." As soon as he had finished saying this, the Prince ripped him up like a ripe melon, and slew him. So thenceforward he was praised by being called by the august name of His Augustness Yamato-dake.'

After this exploit, which reminds us of Zeus, in disguise, entering the dwelling of Lycaon, and then killing him and his sons in the midst of a feast, Yamato-dake triumphed, again by cunning, over another enemy, an Idzumo warrior. Yamato-dake, who was armed with a trusty sabre, got his enemy to fight against him with a wooden sabre, which he had cunningly substituted for the weapon of his adversary. That done, he returned to the capital, but very soon his father sent him off to do battle in the East. He set out, and to protect him against the dangers which awaited him, his aunt, the high-priestess, gave him a weapon famous in Japanese mythology, the 'Herb-Quelling-Sabre,' with an 'august bag,' the use of which will be seen later on.

'So then, when he reached the Land of Sagamu, the Ruler of the land lied, saying: "In the middle of this moor is a great lagoon, and the Deity that dwells in the middle of the lagoon is a very violent Deity." Hereupon Yamato-dake entered the moor to see the Deity. Then the Ruler of the land set fire to the moor. So, knowing that he had been deceived, he opened the mouth of the bag which his aunt, Her Augustness Yamato-

hime, had bestowed upon him, and saw that inside of it there was a fire-striker. Hereupon he first mowed away the herbage with his august sword, took the fire-striker, and struck out fire, and, kindling a counter-fire, burnt the herbage and drove back the other fire, and returned forth, and killed and destroyed all the rulers of that land, and forthwith set fire to and burnt them.'

This legend, so often depicted by Japanese artists, is followed by another no less famous story:

'When he thence penetrated on, and crossed the sea of Hashiri-mizu [Running-water], the Deity of that crossing raised the waves, tossing the ship so that it could not proceed across. Then Yamato-dake's Empress [i.e. his consort], whose name was Her Augustness Princess Ototachibana ["Younger-orange"], said: "I will enter the sea instead of the August Child. The August Child must complete the service on which he has been sent, and take back a report to the Heavenly Sovereign." When she was about to enter the sea, she spread eight thicknesses of sedge rugs, eight thicknesses of skin rugs, and eight thicknesses of silk rugs on the top of the waves, and sat down on the top of them. Thereupon the violent waves at once went down, and the august ship was able to proceed. Then the Empress sang, saying: "Ah! thou whom I enquired of, standing in the midst of the flames of the fire burning on the little moor of Sagamu, where the true peak pierces [probably Mount Fuji]." So seven days afterwards the Empress's august comb drifted on to the sea-beach, which comb was forthwith taken and placed in an august mausoleum which was made.'

The heroic devotion of his wife drew from the bereaved prince an exclamation of sorrow which for many centuries echoed through the whole of Japanese poetry—where the name of Azuma, the traditional meaning of which is given below, still stands for Eastern Japan:

'When, having thence penetrated on and subdued all the savage Yemishi [the ancestors of the Ainu, now confined to the island of Yezo, but formerly occupying a large part of the empire], and likewise pacified all the savage Deities of the mountains and rivers, he was returning up to the capital, he, on reaching the foot of the Ashigara Pass [leading to Mount Fuji], was eating his august provisions, when the Deity of the pass, transformed into a white deer, came and stood before him. Then forthwith, on his waiting and striking the deer with a scrap of wild chive [used, in Japanese magic, against evil spirits], the deer was hit in the eye and struck dead. So, mounting to the top of the pass, he sighed three times and spoke, saying: "Azuma ha ya! [oh! my wife!]." So that land is called by the name of Azuma.'

Yamato-dake, however, soon married another princess, with whom he left the sacred Sabre. Then he set out to make an unarmed attack upon 'a boar as big as a bull' who was the god of Mount Ibuki (a mountain famous on account of this legend, a large part of which disappeared in the earthquake of 1909). But this god led him astray into the mountain and caused heavy hail to fall on him, which paralyzed his limbs and finally caused his death. After a long and wearisome march, interrupted by songs in praise of Yamato, in which he envied the young people who still danced in that land with their crowns of oak-leaves, and welcomed the clouds coming from his native land and mourned for the divine Sabre which might have saved his life, he finally died on the return journey, without having seen the capital again. His wives and children came to look for his body; but it was transformed into a large white *chidori* (plover), which flew away towards the sea. All his relations 'with sobbing song' followed the bird to the spot where it alighted, and there erected a tomb. 'Nevertheless, the bird soared up thence to heaven again, and flew away' (*Kojiki*, 254-275).

It is of importance to note that, in this curious ending to the legend of Yamato-dake, it is not only his soul, as we might imagine at first sight, but also his body, that is transformed into a bird and disappears. According to the corresponding version of the *Nihongi*, the Emperor had his son buried in one of these rock-tombs, surmounted by a vast tumulus, where great men were interred; but Yamato-dake, in the form of a white bird, flew away towards Yamato. 'The ministers accordingly opened the coffin, and, looking in, saw that only the empty clothing remained, and that

there was no corpse' (*Nihongi*, i. 210 f.). With this narrative we may compare another, found in the *Nihongi* (i. 297), where a guardian of the Shiratori-no-misasagi, the 'Tomb of the White Bird,' erected to the memory of Yamato-dake, is transformed into a white deer under the eyes of the terrified Emperor—a story which is easily enough explained by the frequent presence of deer and plovers round these ancient tombs. The origin of such a legend, as far as Yamato-dake is concerned, may easily be imagined: some one is mourning over a tomb; suddenly, a bird flies off, and the idea naturally arises that it is the dead man that is escaping. At the same time it may be conceived how such an illusion must have favoured the deification of the hero.

We have laid special emphasis on this legend of Yamato-dake, because he is the most famous of all Japanese heroes. Naturally, after those primitive heroes, of which he is the typical example, other more civilized personages were deified in their turn. For example, Sugahara no Michizane, a famous statesman and man of letters of the 9th cent., was afterwards deified under the name of Tenjin Sama, and is still worshipped, especially in a temple at Kyōto, as the god of wisdom and calligraphy. But it is probable that, if the Chinese cult of Confucius had not here furnished a model, the Japanese would never have thought of attributing to this minister of historical times the magic powers of action on Nature which were one of the causes of his deification. It is then safer, if we wish to confine ourselves to Shintō pure and simple, not to attach too much importance to those apotheoses which follow the introduction of Chinese culture.

Nevertheless, we must note that the normal deification of heroes, particularly of warrior-heroes, continues through the whole course of Japanese history, and that, until recent times, quite a number of personages were the object of a well-defined worship. While the obscure mass of the vulgar dead were regarded as descending to the darkness of the under world, certain heroes were considered as ever haunting the land of the living, and some of them were even raised to the stars. In 1877, when the famous Saigō Takamori, the chief of the Satsuma insurgents, committed suicide after a crushing defeat, popular imagination raised him to a place in the planet Mars.

LITERATURE.—*Kojiki*, tr. B. H. Chamberlain, 2nd ed., Tokyo, 1906; *Nihongi*, tr. W. G. Aston, London, 1896.

MICHEL REVON.

HEROES (Slavic).—The Slavs as well as other nations have preserved the memory of the heroic period of their past and of their prominent national heroes, but the heroic legends were developed in epic songs only by some Slavic tribes. Heroic epic thrived mainly among the Russians, Southern Slavs, and Little Russians.

1. Russians.—Russian heroic songs are called *byliny* (derived from the word *byl* = 'the past event'). They began to appear in the 10th-12th centuries, and have been preserved—of course, in a form considerably altered—by oral tradition down to the present day. They were originally composed by professional bards who lived at the courts of princes and wealthy noblemen (*bojari*) and sang the brave exploits of every hero of the prince's suite. From these bards they were received by wandering minstrels (*skomorochni* = *jongleurs*), who considerably modified the contents of the original songs, enlarged them with new *motifs*, and partly composed new songs of a similar character. Through the medium of wandering minstrels these songs penetrated into the very heart of the nation, and popular singers (*skaziteli*) took possession of

them. In the northern regions of Russia, especially in the government of Olonetz, Archangelsk, and in Siberia, Russian national epic has preserved its full vigour and freshness down to the present time. Some of the popular singers are acquainted with about 20 songs, containing in all some 3000 lines. The extant songs are considered as remains of a rich epic repertory which was diffused, many years ago, in the districts of Kieff and Novgorod.

The first collection of Russian epic songs was made by Richard James, an Oxford graduate, who came to Moscow in 1619 with the English embassy and had six epic songs written out for him. The manuscript of them is kept in Oxford, and was reprinted several times in the 19th century. The first collection of Russian heroic songs was published in 1804; it contains those collected by Kiril Danilov in Siberia in the 18th century. Other large collections were published by Pavel Ribnikov (1861-67, 4 vols.); Petr Kirejevskij (1860-74, 8 vols.); Alexander Gilferding (1873); Tichonravov and V. Miller (1894); A. Markov (1901); and A. Grigorjev (1904-10, 3 vols.).

Russian heroic epic has frequently been the subject of careful study. Among its first investigators there appeared scholars (e.g. Buslajev, Orest Miller) who explained the contents of the songs mythologically according to Grimm's theory. Thinking that their original scheme was mythical, they saw in every hero a representative of pagan, especially solar, gods. Other scholars were influenced by Benfey's theory of the Indian origin of European oral tradition; they derived the Russian heroic songs from Oriental legends and songs, and explained them accordingly. Minute analysis led other scholars to assume that in the heroic songs various subjects, both national and international, were developed; and the aim of their study was to discover separate strata in these songs and to distinguish them as to their origin, place, and time.

The chief representative of this comparative method was Alexander Veselovskij, an excellent authority in the world's literatures; he is the author of the significant saying: 'The national epos of every historical nation is inevitably international.' Comparative studies did much to explain the composition and style of Russian oral epic, but they did not lead to any positive results as to its origin. In recent times, however, this one-sided accumulation of comparative materials, international parallels, and motives has been given up, and the main stress has been laid upon the historical evolution of the songs and upon an investigation of the elements of national culture and history which are deposited in them. This is certainly the only correct standpoint. On this principle the songs have been studied by Vsevolod Miller, Ivan Zdanov, S. Sambinago, A. Loboda, etc., who have already reached more reliable results.

On the ground of its contents, Russian heroic epic may be divided into two principal groups: (a) the cycle of Kieff, (b) the cycle of Novgorod.

(a) *The cycle of Kieff*.—In this are celebrated the heroes who lived at the court of the epic prince Vladimir, who, like king Arthur, was the centre of a heroic suite. The chief figure among these heroes was *Ilja Murometz*, by birth a peasant's son. He remained thirty years at home, being unable to move hand or foot; wandering pilgrims succeeded in curing him and bestowed prodigious powers on him. Ilja joined the court of the prince Vladimir in Kieff; on the way he defeated a great Tatar army and captured the robber Solovej, who had his seat upon seven oaks grown together. In the service of Vladimir, Ilja performed feats of bravery in his fights with the Tatars, and gained the renown of an invincible hero. The historical Ilja Murometz probably lived in the 12th cent. and became famous by his heroic deeds; he is mentioned also in Germanic sagas (in the 13th cent.).

Popular singers adorned him with all the qualities of an ideal hero of Russia, and connected with him various mythological and fabulous legends.

Another prominent hero of Vladimir's suite was *Dobrynja Nikitič*. He rendered himself illustrious mainly by killing a terrible seven-headed dragon which devastated the Russian country. The well-known legendary *motif* of a dragon-killer was transferred to Dobrynja, who lived in the 10th cent., and is called the uncle of the prince Vladimir.

Aleša Popovič is mentioned as a comrade of Dobrynja. The songs particularly celebrate his victories over the enormous giant Tugarin, in whose name is preserved the memory of the Khan of Polovci, Tugorkan, who devastated the Russian country in the 11th cent., and was killed in a combat. The historical Aleša Popovič was not born till about the beginning of the 13th cent., but the popular singers praised him as the real victor over Tugorkan.

In the service of the prince Vladimir, *Dunaj Ivanovič*, *Suchman*, *Saur Vanidovič*, etc., are mentioned as famous heroes. Foreign heroes also would come to Kieff to pay their compliments to the prince Vladimir and to make acquaintance with his brave suite. To their number belong: *Curila Plenkovič*, boasting of luxury and riches, *Djuk Stefanovič*, *Solovej Budimirovič*, and others.

(b) *The cycle of Novgorod* differs from that of Kieff in that the persons celebrated in these songs are not knights, but sons of rich merchants. The great Novgorod, an important commercial centre of the Hanseatic league in the 12th cent., was famed for the luxury and wealth which it had attained owing to its wide-spread commerce. The city had a republican constitution, and the foremost municipal posts were occupied by the nobility and the rich merchants. Quarrels occasionally arose between the two, which form topics of some of the songs. There are also descriptions of other scenes from public life, e.g. family disputes, love adventures, robberies of brides. The principal heroes are: *Vasilij Buslajevič*; *Sadko*, a rich merchant; *Stavr Godinovič*; *Ivan*, a merchant's son.

A separate group is formed by the songs which deal with fabulous and legendary subjects. For example, the song about *Ivan Godinovič* is an expansion of the fabulous theme of an unfaithful wife; the songs on *Potyč Ivanovič* and *Kasjan Michajlovič* have a similar subject. The song about *Vanka*, a widow's son, is based upon the story of a princess who will marry only the man who manages to hide from her, etc.

The Russian heroic songs are penetrated with those deep religious and moral ideas which characterize the Russian people; but in some cases the symbols used are still unexplained. The renowned figure of the Russian epic is *Svjatogor*, a huge giant, whose head touched the clouds, and who had such extraordinary strength that he could set the whole world in motion. When crossing the steppe, he saw lying in front of him a little bag, filled with earth, and was about to lift it up; but the bag was so heavy that Svjatogor broke through the ground and perished. As is explained in another variant of this song, what was hidden in the bag was the terrestrial gravity. By this poetic symbol the sway of the earth over mortal man is beautifully illustrated. The songs about *Volch Svatoslavovič* and *Mikula Seljaninovič* have also symbolical meanings. Volch, the hero of the Vladimir group, well instructed in all knowledge and wisdom, noticed the ploughman, Mikula Seljaninovič, at work in a field, and conceived the notion of tearing his plough from the earth; he tried to do so, but failed. Then Mikula with one hand seized the plough, lifted it up easily, and threw it aside. The simple ploughman, the representative

of agriculture, triumphs over the knowledge and wisdom of the representative of military and princely power.

The typical figure of Russian epic is *Ilja Murometz*, in whom the people have incorporated their ideal of a national hero, democrat, and altruist. Born in a peasant family, Ilja remained all his life a man of simple customs, upright character, and noble mind. Although first among the heroes as regards power and fortitude, he did not become proud of the glory he had gained, and never boasted of his deeds. He considered it his first duty to protect the oppressed, and to fight for his creed, people, and country against the enemies who ravaged Russia. At the same time, he was pious, and fully trusted in the help of God. Deep moral meanings attach to the songs about the three expeditions he undertook before his death. Towards the end of his life, Ilja happened to encounter a stone where three roads divided. On the stone was written: 'Who goes the first road will be killed; who takes the second will marry; who enters the third will become rich.' Ilja chose the first road, and, having come to some high mountains, he met with robbers, who tried to kill him. Ilja took an arrow and shot it at an oak-tree with such force that it split to pieces. The robbers, terribly afraid, fell from their horses. Then Ilja returned again to the stone and set out along the second road. He came to a magnificent palace, where a beautiful queen lived. Ilja did not allow her beauty to seduce him, and put her in chains. He set free the knights whom the cunning queen kept imprisoned in her palace, and distributed amongst them all the wealth that he had found in the palace. He returned once more to the stone and took the third road, where he found huge treasures of gold, silver, and pearls. Out of this treasure he ordered churches and monasteries to be built, and did not take anything for himself. During the building, Ilja was carried over by the invisible power of an angel into the monastery of Pečersk, near Kieff, where he breathed out his soul. It is surely impossible to imagine a more beautiful apotheosis than that with which the Russians have celebrated their well-beloved popular hero.

2. Southern Slavs.—Popular epic flourished richly among the Southern Slavs (Serbs, Croats, and Bulgarians). When, at the beginning of the 19th cent., the first collections of their songs appeared, they aroused genuine admiration in learned Europe, owing to their variety as well as their cultivated poetic form. They differ from the Russian epic, especially in their contents, which are more simple: each song usually contains only one epic *motif*, whereas the Russian poems are, as a rule, compositions made up of different subjects, and represent a higher and more artistic degree of epic evolution. The greatest merit in the collection of the popular songs of the Southern Slavs is due to Vuk Stefanović Karadžić; his example was followed later by many other collectors.

There is no certainty as to the age of the epic of the Southern Slavs. Some scholars place the beginning of these epic productions as far back as the 12th and 13th centuries; others fix on the 16th century. It is probable that the epic creative faculty of the Southern Slavs did not begin to develop until after the great historical revolutions in the second half of the 14th century. Its highest development is to be placed, therefore, in the 15th century.

As among the Russians, so among the Southern Slavs, heroic songs were composed at first by professional bards, who were educated in special vocal schools. Afterwards they were taken up by popular singers, the *guslari*, so called after the musical

instrument *gusle* (a sort of violin) on which they accompanied their songs.

Historical events are the chief topics of the South Slavic epic; very few nations have preserved the image of their past events in their national poetry so vividly as the Serbs and Bulgarians. First of all, the songs celebrate certain monarchs of the *Nemanić family* (1168–1371), who are praised for their pious disposition, which they often evinced by founding churches and monasteries. Far richer is the cycle of songs whose central theme is the ill-fated battle on the field of *Kosovo* (1389), with which the Turkish supremacy began. The songs of this cycle describe partly single events in connexion with that battle, partly the principal heroes who took part in the fight (Miloš Obilić, the Czar Lazar, Vuk Branković, the brothers Jugović, etc.). It is curious that the defeat of Kosovo is related as a disaster predestined by God to the Serbian people.

The most beloved hero of the South Slavic epic is *Prince Marko* († 1394). Nearly a hundred songs about him are current, describing his life and heroic deeds, from his birth to his death. They contain very few historical reminiscences; popular singers have connected various Biblical, legendary, and fabulous *motifs* with him, and transformed him into a semi-mythical being. He was educated by mythical beings, *vile* (fairies), who bestowed superhuman power on him. Marko makes use of this power for the benefit of his fellow-men, succours the oppressed on every occasion, and administers stern justice. He hates violence and loves liberty; he sets prisoners free, and willingly helps the unhappy. He is at the same time pious, and undertakes the hardest battles for the Christian faith. When dying, he bequeaths one part of his gold to him who will bury him, the second for the embellishment of churches, and the third to the blind bards that they may sing his glory.

Another cycle represents the historical events after the battle of Kosovo, and describes battles between the Serbs and the Turks down to the complete enslavement of Serbia in 1521. The chief heroes of this cycle are the Serbian monarchs of the family of *Brankovići*, and the *Kings of Hungary* who fought against the Turks. Under the cruel Turkish yoke, these songs took the place of history and poetry among the Southern Slavs. They celebrated not only subjects from the glorious past, but also contemporary events, especially the petty battles of the Slavs in revolt against the Turks. The most recent ones celebrate the wars of liberation of modern times.

Besides these historical subjects, which, of course, the popular singers changed and adorned in various ways according to their imagination, there were included in the living stream of South Slavic epic many *motifs*, partly apocryphal (creation of the world), partly legendary (about incest, immolation of one's own child), and partly fabulous (about the dead brother, immurement of people in buildings, the serpent-bridegroom, the unfaithful mother, etc.). Owing to this great variety of poetic *motifs*, the epic of the Southern Slavs takes its place high above all similar epic products of other nations.

The most notable names in the interpretation of the South Slavic songs are Stojan Novaković, F. Miklošić, V. Jagić, T. Maretić, M. Chalanski, and Asmus Soerensen.

3. Little Russians.—The heroic songs of the Little Russians (Ukrajinci) are called *dumy*. They took their rise among the famous Cossacks, and their authors were professional minstrels, educated in vocal schools, the number of which was very considerable in Ukraine. The name of the present singers of the *dumy* is *kobzari*, from the musical instrument *kobza*, similar to the guitar.

Professional singers used to follow the Cossacks on their expeditions, and give expression to their feelings in melancholy songs. They sing either the battles of the Cossacks with the Tatars and the Turks, or those of the famous Chmelnicki, *ataman* of the Cossacks (in the 17th cent.), against the Poles who oppressed the free Cossacks. Besides the historical events, touching scenes from domestic and family life are described in the *dumy*. The songs of the Little Russians are penetrated with a fervent love of native land and liberty, and a sincere piety. Their melancholy character, as well as their tone and composition, reminds us somewhat of the Psalms of the OT.

The best interpreters of these songs are Kostomarov, Antonovič, Dragomanov, Ziteckij, Franko, and Grinčenko.

4. The Bohemians and the Poles have many heroic legends; but these did not become subjects of epic poetry. They were noted, however, by old chroniclers. The Bohemian legends deal with the ancestor *Čech*, who came with his suite from the trans-Carpathian regions and settled in Bohemia. Among the pagan Bohemian princes, *Krok* is mentioned as eminent for wisdom, etc. His youngest daughter, *Libuše*, a famous prophetess, chose for her husband *Premysl Oráč* (ploughman), founded *Praha* (Prague), and with her husband gave wise laws to the country. The Poles have similar legends. Their pagan prince *Krak* had a daughter *Vanda*, who reigned after his death, and offered her life for her country's liberty. According to popular legends, the founder of the national dynasty of Poland was the farmer *Piast*; as a reward for the hospitality he showed to two pilgrims, his family was elevated to the throne, instead of the cruel ruler *Popel*, who was devoured by mice.

LITERATURE.—O. Müller, *Elias of Murom and the Heroes of Kieff* (Russ.), St. Petersburg, 1870; A. Rambaud, *La Russie épique*, Paris, 1876; W. Wollner, *Untersuchungen über die Volksepik der Grossrussen*, Leipzig, 1879; A. N. Veselovskij, *South-Russian Lays* (Russ.), St. Petersburg, 1881; A. M. Loboda, *The Russian Heroic Epos* (Russ.), Kieff, 1898; V. Müller, *Sketches of Russian Popular Literature* (Russ.), 2 vols., Moscow, 1897-1910; T. Maretič, *Our National Epos* (Croat.), Agram, 1909; P. Ziteckij, *Thoughts upon the Popular Ballads of Little Russia* (Russ.), Kieff, 1898; J. Máchal, *The Slavonic Heroic Epos* (Bohem.), Prague, 1894; I. F. Haggood, *The Epic Songs of Russia*, New York, 1886; L. Wiener, *Anthology of Russian Literature*, New York, 1902; E. L. Mijatovich, *Kosovo*, London, 1881; W. R. S. Ralston, *The Songs of the Russian People*, do. 1872, and *Russian Folk-tales*, do. 1873.

J. MÁCHAL.

HEROES AND HERO-GODS (Teutonic).—

The most explicit reference to the practice of hero-worship among Teutonic peoples occurs in the following passage from Jordanes (*de Getarum Origine*, 13):

'proceres suos, quasi qui fortuna vincebant, non puros homines, sed semi-deos, id est Anses, vocavere.'

This, it will be seen, is a parallel to Hesiod, *Works and Days*, 156-173. Trustworthy evidence is, however, necessarily scanty, as the Germanic races adopted Christianity soon after the Heroic Age, or towards its close. The existing records of the heroes date, for the most part, from even later times, and are therefore almost entirely coloured by Christian beliefs and practices. An example of worship paid in the form of libation to a hero of the Heroic Age occurs in *Ynglinga Saga* (41):

'So she (i.e. Hildigunna) took a silver bowl, and filled it, and went before King Hjorvarðr and spoke; "Hail to you all, Ylfings! This in memory of Hrólf Kraki."

Further reference to a similar custom is found in the *Saga of Hákon the Good* (*Heimskringla*, iv. 16):

'Men drank also a cup to their dead kinsmen who had been buried in howes, and that was called the cup of memory.'

An extreme case of the representation of a hero as a supernatural being is that of Dietrich von Bern; in this instance the hero becomes, not a god, but a demon—a point of view due to ecclesiastical hostility towards the Arian king, and the slayer of the Pope. Hence he occurs in legend as the Wild Huntsman, and the connexion of his

name with places such as the Castle of Saint Angelo and the Amphitheatre of Verona shows him under the aspect of a local, though hardly tutelary, hero (cf. *Deutsche Predigten*, ed. K. Roth, Leipzig, 1839, p. 76; Grimm, *Deutsche Mythologie*, Berlin, 1875-78, vol. iii. ch. xxxvi.). A classical parallel may possibly be found in the story of Minos. In Attic tradition—naturally unfavourable—this king is generally represented as 'a tyrant . . . and violent, and an exactor of tribute' (Strabo, x. 4. 8 [p. 476]); while his sea-power, his connexion with the Minotaur, and his position as one of the judges in Hades after his death, combine to endow him with a semi-supernatural character.

In later times, up to the 10th and 11th centuries, we hear among the Scandinavian peoples of beings, apparently human, receiving divine honours. In *Landnámabók* (pt. i. ch. xiv.), mention is made of one Grimr, who 'because of his popularity was worshipped when dead, and called Kamban.' By this name he is twice referred to elsewhere in the same work. Similarly in *Flateyjarbók* (*Olafs Saga hins helga*, ch. vi.) an account is given of Olaf, brother of Halfdán the Black, who after death is worshipped under the name of Geirstaðarálfr, and receives sacrifices offered to ensure a plentiful harvest. This mention of sacrifice in connexion with the barrow of a dead hero is reminiscent of the cult of the dead to which Burchard of Worms bears witness (*Decreta*, bk. xix. ch. v., 'de Superstitione'): 'the offerings that in certain places are made at the tombs of the dead.' An illustration of the virtue supposed to emanate from the dead body of a hero is found in the story of Halfdán the Black (*Heimskringla*, ii. 9), where we are told that his body was claimed by four districts, each 'thinking that they who got it might expect to have plenteous seasons thereby.' To avoid discord, the body was then divided into four parts, and the resting-place of the head is specially mentioned.

An extreme case, amounting to more than hero-worship, is found in the deification of King Eric of Sweden, narrated by Rimbart in his *Life of Anskar* (ch. 26). Bishop Anskar found his missionary efforts among the Swedes, in the middle of the 9th cent., temporarily checked by a man who claimed to have received a message from the gods. They deplored the decay of their sacrifices, and offered an inducement to renewal of worship:

'If you desire to have more gods, and we are not sufficient, then do we now, with unanimous decision, admit your former King Eric into our community, so that he henceforth is one of the gods.' The people, therefore, 'built a temple to King Eric, who had died long before, and began to offer to him vows and sacrifices as to a god.'

Reference is made to this by Adam of Bremen in his *Gesta* (iv. 26): the Swedes

'also worship gods made from men, to whom they ascribe immortality because of their mighty deeds, as it is recorded that they did with King Eric in the *Life of Saint Anskar*.'

Deification was probably by no means uncommon, but the circumstances in this case are somewhat unusual.

Reference is frequently found to some supernatural beings who may at one time have been regarded as human, or who have taken certain elements of heroic worship. The euhemeristic account of Frey in *Ynglinga Saga* (4. 13, and *passim*), and of his priest-kingship over the Swedes, if at all reliable, would point to a fusion of human and divine attributes—the priest-king combined with the deity of fertility. Members of the Swedish royal house claimed descent from Frey, and were called Yngvi, from the god's full name Yngvifreyr (*Ynglinga Saga*, 20); similarly Skjöldr appears as the eponymous ancestor of the Danish kings, the Skjöldungar or Scyldingas. The name Yngvi can be traced in Tacitus (*Germ.* 2), who, basing his account on ancient native poems, states that the

racés of the Germani trace their descent from the god Tuisto and his son Mannus; from the latter spring 'three sons, from whose names those who are nearest to the Ocean are called Ingaevones [probably for Inguæones], the central tribes Herminones, and the rest Istaevones.' These names occur again in Pliny (*HN* iv. 28) as group-names of the Germani; while in the Frankish genealogy the descent of thirteen nations is traced to three brothers, Ermenus, Inguo, and Istio. From the reference to Ing in the Anglo-Saxon Runic poem, it seems that he must have had a distinct personality, however mythical, and this is borne out by the conception of Frey in the *Ynglinga Saga*. An extension of the idea of Frey's power of controlling the weather is to be traced in the identification of the object of reverence with the offering, and in the idea of the efficacy of a king as a sacrificial victim. Thus in *Ynglinga Saga* (18 and 47) King Dómaldi and King Ólafr are offered up by their subjects to stay the famine and to ensure plenty.

Turning now to women, we may possibly trace a human element in Thorgerðr Hólgabrúðr and Yrpa, her sister. In *Njála Saga* (88), where Hrappr commits sacrilege in their temple, and in *Jómsvíkinga Saga* (44), where Earl Hákon, their votary, sacrifices his son to them in order to gain victory, they are obviously goddesses; but in *Skáldskaparmál* (45), as in Saxo (bk. iii.), Thorgerðr appears in connexion with a character Helgi, who is apparently the eponymous hero of Halogaland. The importance, among Germanic races, of women as prophetesses is attested by Strabo in his description of the part played by 'holy prophetesses' in the sacrifice of captives, and in divination from their blood (vii. 2. 3). Tacitus (*Germ.* 8) says:

'They attribute to them some holy and prophetic power . . . ; many others are venerated, not out of servility, or as if they were deifying mortals.' As examples, he refers to Aurinia [probably for Albruna] and to Veleda, and a further account of the latter is found in his *Historiæ* (iv. 61, 65): 'Veleda, a maiden of the tribe of the Bructeri, who possessed extensive dominion; for by ancient usage the Germans attributed to many of their women prophetic powers, and, as the superstition grew in strength, even actual divinity. . . . She dwelt in a tower, and one of her relations conveyed, like the messenger of a divinity, the questions and answers,' i.e. in her intercourse with the Roman ambassadors.

It is perhaps possible to regard the Germanic reverence for women, and the large part played by them in divination and sacrifice, as a parallel with the importance attached to the cult of the *Matres*. Though this is considered to have been originally a Celtic cult (cf. Roscher, s.v. 'Matres'), it was apparently common to Germany and Gaul. One aspect especially of the *Matres*, whereby they are saluted as 'Matres campestris,' or guardians of the military camp (cf. M. Siebourg, *de Sulevis Campesribus Fatis*, Bonn, 1886), may be compared with the account by Tacitus. It must, however, be borne in mind that the function of the *Matres* is essentially protective, not warlike. If it were possible to connect Bede's interesting reference (*de Temporum Ratione*, 15) to the sacrifices on *Módraniht*, *id est matrum noctem*, on the one hand, with the *Matres*-cult, and, on the other hand, with the *disablot* of the Scandinavians (cf. *Ynglinga Saga*, 33), a link would be formed between the different phases of Germanic goddess-cult. Similarly, too, if the *disir* may be identified in part with the Valkyries, the human element recurs again, for certain of the Valkyries, e.g. Brynhildr, undoubtedly have some human characteristics.

With regard to the ethical aspect of non-deified heroes in the Teutonic epics, the extant accounts either date from Christian times or are so largely overlaid with Christian thought as to render it difficult to form a definite idea of any rules of conduct governing their lives. As far as we can

gather from the records, the chief virtues throughout the Heroic Ages seem to have been courage and generosity; the combination of the two would appear to have been the ideal, but proof of either sufficed to win fame, and thus to attain the real object of a hero's existence, as Beowulf confesses:

'Let him who can, win for himself glory before he dies; that is the best thing that can come to a knight in after times, when he is no more' (1387 ff.).

The individual impatience of all restraint resulted in faults of excess, and crimes of passion and savagery. Revenge was not only allowed, but was a duty, and was taken not only for shedding of blood, but also for lesser wrongs; thus Egil revenges himself on Armód for scanty hospitality, by insulting him and blinding him in one eye (*Egils Saga Skallagrímssonar*, 75). One virtue, however, does appear clearly—personal loyalty and honourable devotion, as that of a retainer to his lord. It may be objected that this was won and retained chiefly by gifts, but proof of its power is given even by foreign historians; thus, when Folchere (Phulcaris) dies, overpowered by the Franks, 'upon his body his followers fell to a man' (Agathias, i. 15). Treachery, infidelity, and cunning were hated, but were probably largely practised, especially in the interests of self. The tendency of the age was individualistic, and its annals have many dark records; but it may be urged in extenuation that the aspect of heroic life and deeds which would naturally appear in history and song is one-sided, and omits far more than it records.

LITERATURE.—No definite literature on the subject exists. Compare the references quoted in the course of the article, and such general works as E. Mogk, in Paul, *Grundriss der germ. Philologie*², iii. (Strassburg, 1900); E. H. Meyer, *Germanische Mythologie*, Berlin, 1891; Chantepie de la Saussaye, *Religion of the Teutons*, Boston, 1902.

M. E. SEATON.

HESIOD.—For the Greeks of the 5th cent. B.C. Homer and Hesiod stood side by side as the two great poet masters: Homer the singer of war and adventure, Hesiod the inspired teacher of practical wisdom. Thus Aristophanes (*Frogs*, 1030-36) puts into the mouth of Æschylus these words:

'Consider from the beginning how useful the noble poets have been. Orpheus taught us mystic rites and to refrain from murder; Mousaios taught us healing of diseases and oracles; Hesiod taught us the tilling of the earth, the seasons of crops, ploughing; and the divine Homer, whence got he honour and glory save from this, that he taught men good things—even marshalling of troops, deeds of valour, arming of men?'

The contrast between the Homeric and the Hesiodic epic is concisely put in the words which, as Hesiod tells us, the Muses addressed to him when they gave him his call to poetry (*Theog.* 26 ff.): 'Shepherds of the fields, evil things of shame, bellies only! We know to speak full many things that wear the guise of truth, and know also when we will to utter truth.' To tell 'true things' is the characteristic of didactic poetry.

The *locus classicus* as to the poems attributed to Hesiod in antiquity is Pausanias, *Description of Greece*, ix. 31. 4 f.:

'The Bœotians who dwell round Helicon record it as the traditional opinion that Hesiod wrote no other poem than the *Works*: and from that they take away the Preface [i.e. 1-10], saying that the poem begins with the lines on the Strifes [i.e. 11 f.]. And they showed me a leaden tablet where the fountain (Hippocrene) is, for the most part, destroyed by time, and on it is inscribed the *Works*. But there is another and different opinion to the effect that Hesiod composed a large number of epics, those on women, and the so-called *Great Eoiai*, and the *Theogony*, and a poem on the seer Melampus, and how Theseus descended into Hades along with Peirithoos, the *Advice to Cheiron for the instruction of Achilles*, and all that is embraced by the *Works and Days*. These same people say also that Hesiod received instruction in prophecy from the Acarnanians. And there exist prophetic verses which I myself have read, and *Explanations of Portents*.'

Fragments of most of these poems have come down to us, and we possess in an approximately complete form the *Works and Days*, and the *Theo-*

gony, as well as the so-called *Shield of Herakles*, which may be a fragment from the *Eoiai*.

It is impossible here to enter into minute questions of date and authenticity. The ancients seem to have regarded Hesiod as contemporary with Homer, and as author at least of the *Works* and of the *Theogony*. Thus Herodotus (ii. 53) says:

'Whence each of the gods came or whether they all existed forever, and what form particular gods have, they [the Greeks] did not know until (so to say) the other day. For I consider that Hesiod and Homer lived four hundred years before my time, and no more. And it was they who created the theogony of the Greeks, and who gave their names to the gods, and assigned to them their honours and arts, and marked their forms. And the poets who are said to have lived before Hesiod and Homer were, in my opinion, later.'

Without dogmatizing about particular lines, if we assume that the bulk of the *Works and Days* and of the *Theogony* belongs to about 800 B.C., we shall probably be sufficiently near the mark. It may be noted that in the *Works* (564 ff.), Hesiod says: 'When Zeus hath completed sixty days after the turning of the sun, then the star Arcturus, leaving the sacred stream of Ocean, first riseth in his radiance at eventide' i.e. the evening or acronychal rising of Arcturus takes place sixty days after the winter solstice, which for lat. 38° gives a date 900 B.C. But, as there was a tendency to give conventional dates for the rising of stars, we cannot perhaps build too much on this.

In considering the theology of Hesiod, it is well to remember that we must not expect to find either the lucidity or the consistency which we should require in a modern theologian. We shall expect to find elements of quite different date and of quite different stages of spiritual advancement existing side by side, with no attempt at reconciliation. As some great river carries to the sea the gathered testimony of its long wandering from the trickling spring in the lonely glen which gave it birth—in his high mountain cradle in Pamere—so the poet, using the materials of his nameless and unknown predecessors, refining here, adding something there, creates at last the literary masterpiece which henceforth bears his name and his name only, though many a long-silent tongue, and many a long since darkened brain, had contributed to the common end. We shall find in Hesiod only a few traces of the conscious reflexion, tending towards the reconciliation and purification of the ancient myths, which is so marked in Pindar and Æschylus. Hence the reproach of Xenophanes of Colophon (c. 550 B.C.): 'Homer and Hesiod ascribed to the gods all things that among men are a shame and a reproach—to steal, and to commit adultery, and to deceive one another.' But men cleave piously to an ancient tradition long after they have intellectually and morally renounced it, and we shall form a truer conception of the ethical advancement of the early poet, if we judge him not by his lowest but by his highest.

The purpose of the *Theogony* is to give a systematic account of the genealogy of the gods; cf. *Theog.* 104 ff.:

'Hail! daughters of Zeus, and grant delectable song. Sing ye the holy race of the deathless gods which are for ever: even them that were born of Earth, and starry Heaven, and dusky Night, and those whom the briny Sea brought forth. And declare ye how in the beginning Gods and Earth came into being, and Rivers and the infinite Sea with raging flood, and the shining Stars, and the wide Heaven above, and the Gods which sprang from them, givers of good things; and how they divided their wealth, and how they apportioned their honours; yea, and how at the first they possessed them of manyfolded Olympos. These things, even from the beginning, declare ye unto me, O Muses, who dwell in the halls of Olympos, and tell me which of them was first created.'

But it includes also some cases of the union of gods with mortal mothers (940 ff.), and (965 to end) a somewhat more detailed account of the union of goddess mothers with mortal sires.

In broad outline the order of creation in the *Theogony* is as follows. First came Chaos, i.e.

void space; then Earth and Eros (Love). From Chaos sprang Erebus and Night, and from Night in union with Erebus sprang Æther and Day. Earth first bore Ouranos (Heaven), and the Mountains and the Sea (Pontos). These she bore without wedlock. Then in union with Ouranos she bore the Titans, of whom the youngest was Kronos, 'of all her sons most terrible, who hated his valiant sire.' Now, as each of his sons was born, Ouranos hated them, and 'he would hide them every one in a covert of Earth, and allow them not to rise up into light.' Then Earth fashioned a sickle of adamant, with which her son Kronos cut off the privy parts of Ouranos and cast them into the sea. Kronos in union with his sister Rhea became father of Zeus, Hera, Demeter, Hestia, Hades, Poseidon. Now 'these did mighty Kronos swallow, even as each came forth from the holy womb to his mother's knees, that none other of the glorious sons of Ouranos should hold the kingly honour among the immortals. For he learned from Earth and starry Ouranos that it was fated him to be overcome by his own son, for all his strength, by the devising of mighty Zeus.' Now, when Rhea was about to bring forth Zeus, she asked counsel of Earth and Ouranos; and they carried her to Lyktos in Crete, where 'Zeus was born and brought up. But she wrapped a great stone in swaddling clothes and gave it to Kronos, who swallowed it for his son, and so was induced to vomit forth first the stone and afterward his children whom he had swallowed.' So Zeus came to be king of the immortals.

It is sometimes said that the myth of Ouranos is unknown to Homer. It is true that the myth does not occur in his writings; but there seems no reason to doubt the line in *Il.* v. 898 where we have *ἐντέρεος Οὐρανίωνων*—'lower than the sons of Ouranos,' i.e. lower than Kronos and the other Titans. It may be noted that while, according to Homer, the fate of Kronos is to be imprisoned with the other Titans in Tartaros (*Il.* xiv. 274, xv. 225; cf. *Æsch. Prom.* 222), in Hesiod he is king in the Islands of the Blest (*Works*, 169; cf. Pindar, *Ol.* ii. 77 ff.).

Zeus in Hesiod, as in Homer, is supreme among the gods, omnipotent and omniscient. But, just as Homer apparently did not feel it to be inconsistent with omniscience that he should be deceived by Hera (*Il.* xiv.), so Hesiod (*Works*, 48 ff.) represents him as deceived by Prometheus. There is, indeed, a hint of reflexion in *Theog.* 534 ff., where, in recounting the same tale, he says that Zeus was not really deceived, but only pretended to be: 'Zeus, who knoweth counsels imperishable, knew and failed not to remark the guile.'

Since gods and men alike are children of Earth, they are said to be sprung from one stock (*Works*, 108: 'from one stock spring gods and mortal men'; cf. Pind. *Nem.* vi. 1 ff.: 'One is the race of men, one the race of gods, and from one mother do we both have breath. But we are sundered by altogether diverse powers, so that man is naught, while the brazen heaven abides an unshaken habitation for ever'). But mankind is the direct creation of the gods.

The Hesiodic conception of the history of man is, like the Hebrew, that of a fall from a primitive state of sinlessness and happiness into a state of sin and misery. Hesiod's most detailed account is the story of the Five Races of men (*Works*, 109–201).

(1) First the gods created a Golden race of men. This was while Kronos was still king in heaven. The men of the Golden race knew neither toil nor sorrow. The earth of its own accord gave them abundant livelihood. Moreover, they never grew old, but died as if overcome by sleep. But this race passed away—we are not told how or why—and now they are,

'by the devising of mighty Zeus, spirits (*daimones*) of good upon the earth, guardians of mortal men; who watch over dooms and the sinful works of men, faring everywhere over the earth, cloked in mist, givers of wealth. Even this kingly privilege is theirs.'

(2) Next the gods created 'a far inferior race, a race of Silver, nowise like to the Golden race in body or in mind.' These had a long childhood, but a short life after they grew up.

'For a hundred years the child grew up by his good mother's side, playing in utter childishness in his home. But when he grew to manhood and came to the full measure of age, for but a brief space they lived and in sorrow, by reason of their foolishness. For they could not refrain from sinning the one against the other, neither would they worship the deathless gods, nor do sacrifice on the holy altars of the Blessed Ones, as is the manner of men wheresoever they dwell.'

So Zeus 'hid them,' being wroth because they did not give honour to the blessed gods. They now dwell beneath the earth and 'are called the blessed dead: of lower rank [*i.e.* than the Spirits of the Golden race], yet they too have their honour.'

(3) Next Zeus created a third race—a race of Bronze, sprung from the Ash-tree nymphs, or Meliai. The men of the third race were fierce and warlike, strong of arm and of heart. They did not eat bread (*i.e.*, apparently, they lived on flesh). 'Of bronze was their armour, of bronze their dwellings, with bronze they wrought. Black iron was not yet.' This race perished by their own hands and 'went down to the dark house of chill Hades, nameless.'

(4) Next Zeus created a fourth race, 'a juster race and a better, a godlike race of hero men who are called demi-gods (*ἀνδρῶν ἡρώων θεῖον γένος, οὐ καλέονται ἡμίθεοι*), the earlier race upon the bounteous earth' (*i.e.* the race which immediately preceded the present). This race is the men of the Heroic Age, who perished at Thebes and at Troy. These are now in the Islands of the Blest:

'Zeus the Father, the Son of Kronos, gave them a life and an abode apart from men, and established them at the ends of the earth and far from the deathless gods: among them Kronos is king. And they, with soul untouched of sorrow, dwell in the Islands of the Blest beside deep-eddying Okeanos: happy heroes, for whom the bounteous earth beareth honeysweet fruit fresh thrice a year.'

(5) Then followed the fifth race (*i.e.* the present race), which 'is verily a race of Iron,' and Hesiod expresses the wish that he had 'either died before or been born afterwards.' It is destined to become progressively more wicked:

'Father shall not be like to his children, nor the children like to the father; nor guest to host, nor friend to friend, nor brother to brother shall be dear as aforetime; and they shall give no honour to their swiftly ageing parents, and shall chide them with words of bitter speech, sinful men, knowing not the fear of the gods. These will not return to their aged parents the price of their nurture; but might shall be right, and one shall sack the other's city. Neither shall there be any respect of the oath-abiding or of the just or of the good; rather they shall honour the doer of evil and the man of insolence. Right shall lie in might of hand, and Reverence shall be no more; the bad shall wrong the better man, speaking crooked words and abetting them with an oath. Envy, brawling, rejoicing in evil, of hateful countenance, shall follow all men to their sorrow. Then shall Reverence and Awe veil their fair bodies in white robes and depart from the wide-wayed earth unto Olympos to join the company of the Immortals, forsaking men; but for men that die shall remain but miserable woes; and against evil there shall be no avail.'

The end of this race—'for whom also good shall be mingled with evil'—is foretold in the curious words: 'This race also of mortal men shall Zeus destroy when they shall be hoary-templed at their birth.' The expression becomes quite intelligible if we remember what was said of the Golden and Silver races. The men of the Golden Age knew no old age. They remained 'unchanged in hand and foot' until they 'died as if overcome by sleep.' The men of the Silver race, again, had a childhood of a hundred years. The idea is that childhood becomes progressively shorter until finally men are grey-haired at birth; this shall be the sign of the end. It is interesting to compare the myth in Plato's *Politicus* (268 E-274 E; see J. Adam, *Plato's Rep.*, London, 1902, Appendix to bk. viii. vol. ii. 295 ff.). Ridgeway's notion (*Early Age of Greece*, Cambridge, 1901, i. 628), that it is 'some sort of

oracular utterance referring to fair-haired invaders of some Teutonic stock,' is entirely fanciful.¹

In this account of the fall of man no reason is given for the fall. But in *Works*, 90 ff., and *Theogony*, 535 ff., we have another account of the history of human degeneration which, taking no account of the Five Races, ascribes the coming of evil into the world to the creation of woman. In the *Theogony* (*l.c.*) we read how, when the gods and mortal men were contending at Mekone (Sikyon), Prometheus

'cut up a mighty ox and set it before them, deceiving the mind of Zeus. For he set for them the flesh and the inmeats with rich fat upon a hide, and covered them with an ox paunch; but for Zeus he set the white bones, arraying them craftily, and covering them with glistening fat. Then the Father of Gods and men spake unto him: "Son of Iapetos, most notable of all princes, how unfairly, O fond! hast thou divided the portions!" So spake Zeus, who knoweth counsels imperishable, and mocked him. Then spake to him in turn Prometheus of crooked counsels, smiling quietly, but forgetting not his crafty guile: "Zeus, most glorious, mightiest of the everlasting gods, of these portions choose whichever thy soul within thy breast biddeth thee." So spake he with crafty intent. But Zeus, who knoweth counsels imperishable, knew and failed not to remark the guile; and in his heart he boded evil things for mortal men, which were destined to be fulfilled. With both his hands he lifted up the white fat. And he was angered in his heart, and wrath came about his soul when he beheld the white bones of the ox given him in crafty guile. And thenceforth do the tribes of men on earth burn white bones to the immortals upon fragrant altars. Then, heavily moved, Zeus the Cloud-Gatherer spake unto him: "Son of Iapetos, who knowest counsels beyond all others, O fond! thou hast not yet forgotten thy crafty guile." So in anger spake Zeus, who knoweth counsels imperishable. And thenceforward, remembering evermore that guile, he gave not the might of blazing fire to wretched mortals who dwell upon the earth. But the good son of Iapetos deceived him and stole the far-seen gleam of unwearied fire in a hollow fennel-stalk, and stung to the depths the heart of Zeus who thundereth on high, and angered his heart when he beheld among men the far-shining gleam of fire. And straightway he devised evil for men.'

Hesiod goes on to tell how, to punish men, Zeus made Hephaistos fashion woman of earth, and (590 ff.) we have a tirade upon the sins of woman; but the *Theogony* gives no hint of any definite fall brought about by the creation of woman. In the *Works* he is somewhat more explicit. He first tells how

'Zeus in his anger hid the bread of life, for that Prometheus of crooked counsels had deceived him. Wherefore Zeus devised sorrow for men, and hid fire. But the good son of Iapetos stole it again for men from Zeus the Counsellor in a hollow fennel-stalk, what time the Hurler of the Thunder knew not.' To punish men, we are told, Zeus caused Hephaistos to fashion the first woman (47 ff.). Then Hesiod proceeds to say (90 ff.): 'For of old the tribes of men lived on the earth apart from evil and grievous toil and sore diseases that bring the fates of death to men. For in the day of evil men speedily wax old. But the woman took off the great lid of the Jar with her hands and made a scattering thereof and devised baleful sorrows for men. Only Hope abode within in her unbreakable chamber under the lips of the Jar and flew not forth. For ere she could, the woman put on the lid of the Jar, as Zeus the Lord of the Aegis, the Gatherer of the Clouds, devised. But ten thousand other evils wander among men. For the earth is full of evil, and the sea is full. By night and by day come diseases of their own motion, bringing evil unto mortal men, silently, since Zeus the Counsellor hath taken away their voice. So surely may none escape the will of Zeus.'

Hesiod continues (80 ff.): 'and he named this woman Pandora, for that all the dwellers in Olympos had bestowed on her a gift.' It seems that the truth is rather that Pandora is only another name for Ge, 'Earth,' as the giver of all things. Hesiod's account seems to imply that the contents of the jar were evils; later accounts vary between evils and goods. There is in any case some difficulty about the inclusion of Hope (*Ἔλπις*). A comparison with Æschylus (*Prom.* 248 ff.)—*Prom.* 'I made men cease to foresee their doom.' *Cho.* 'What cure didst thou find for this disease?' *Prom.* 'I planted in men blind hopes (*τυφλάς ἐλπίδας*)'—suggests that *ἐλπίς* may mean 'anticipation of the future,' so that *ἐλπίς* might itself be reckoned an evil. But the matter cannot be dis-

¹ It should be noted that the epithets 'golden,' 'silver,' 'bronze' have no other meaning than merely to indicate progressive degeneration. They do not mean either 'made of gold, etc.' or 'working with gold, etc.'

cussed here (see HOPE [Greek and Roman]). (For the Pandora myth, see J. E. Harrison, *JHS* xx. [1900] 99 ff.)

The cardinal virtues in Hesiod are Industry and Justice.

'Work is no reproach, idleness is a reproach' (*Works*, 811). 'Work, Perseus, that hunger may abhor thee, and that Demeter may love thee and fill thy barn with livelihood' (290 ff.). 'The gods are angry with the man who lives in idleness, like the drones which devour the labour of the bees' (303 ff.; cf. 308 ff.). 'Whatever your fortune be, to work is best' (314).

The praise of Justice runs through the whole of the *Works and Days*, e.g.:

'The other way is better, the way of Justice. Justice in the end is better than violence, and the fool learns it by suffering.' Horkos attends to punish crooked judgments (216 ff.). 'The Immortals are nigh among men and remark them that with crooked judgment oppress one another, taking no heed of the anger of the gods. Yea, thrice ten thousand Immortals are there on the bounteous earth who keep watch over mortal men; who watch over judgments and froward works; clad in mist, faring everywhere over the earth. Also, there is the maiden Justice, the daughter of Zeus, glorious and worshipful among the gods who hold Olympos. And whenever one injureth her with crooked reviling, straightway she sitteth by Zeus the Father, the son of Kronos, and telleth of the unrighteous mind of men, till the people pay for the folly of their rulers, who with ill thoughts wrest aside judgment, declaring falsely' (249 ff.).

Injustice is punished in this world by all manner of evil—barren wife, poverty, disaster by land and by sea (242 ff.). On the other hand, those who do justice prosper:

'Peace is in their land, the nurse of children, and Zeus doth never decree war for them. Neither doth famine nor doom consort with men who deal straight judgments, but they do their work in gladness. For them earth beareth much livelihood, and on the hills the oak's top beareth for them acorns, the oak's midst bees; their fleecy sheep are heavy with wool; their wives bear children like unto their parents; they flourish with good things continually, neither go they on ships, but bounteous earth beareth fruit for them' (228 ff.).

Hesiod is confident that justice is better in the end:

'Now may neither I nor son of mine be just among men. For it is an ill thing to be just, if the unjust shall have the greater justice. Howbeit, this I deem not that Zeus, the Hurler of the Thunder, will bring to pass' (270 ff.).

Justice, indeed, is the great distinguishing mark between man and the lower animals:

'This law hath the Son of Kronos appointed, that fishes and wild beasts and the fowls of the air should devour one another, since there is no justice among them. But to men he hath given justice, which is far the best' (276 ff.).

The sins of the fathers are visited on the children, but the children of the just are better in the after days (284 ff.; cf. *Æsch. Ag.* 758 ff.).

Specific prohibitions enjoined by Hesiod are: Thou shalt not commit adultery (328). Thou shalt not wrong the suppliant or the stranger (327). Thou shalt not wrong the orphan (330). Thou shalt not revile thy aged parent (331); Zeus is wroth with one who does so, and for his unrighteousness lays upon him in the end a heavy recompense. Thou shalt not steal (355). Thou shalt not bear false witness (709).

Among specifically religious precepts the duty of worshipping the gods is insisted on:¹

'According to thy power do sacrifice to the deathless gods in holy wise and purely, and burn splendid thigh pieces; at other times propitiate them with libations and incense, both when thou goest to bed and when the sacred light comes, that they may have a propitious heart and mind toward thee; that thou mayest buy another's estate, not another thine' (836 ff.).

In particular, ceremonial purity is emphasized: libations are not to be made to the gods with unwashed hands (724 ff.; cf. *Hom. Il.* vi. 266 ff.). Certain necessary functions are to be performed discreetly even by night; 'for the nights too be-

¹ J. E. Harrison, *Themis*, 95 ff., writes of Hesiod that 'when it came to real definition of his duties, these duties are, not to glorify Athens or to offer burnt sacrifice to Zeus, they are not prayer or praise or sacrifice in any form, but simply the observance of sanctities, attentions, positive and negative.' For this there seems no ground. Miss Harrison's treatment of Hesiod's birds is equally ill-founded. She assumes that for Hesiod the bird is a prophet of the weather, and on her theory the bird is a 'maker of the weather.' Hesiod nowhere speaks of the bird as a prophet. He simply says that when a particular bird arrives—crane, cuckoo, swallow—certain things are to be done.

long to the blessed gods' (727 ff.). The nails of the hand should not be cut at a festival of the gods (742 ff.). Sexual uncleanness is recognized (733 ff.).

There is not space here to speak of the various precepts of traditional lore of a practical kind to be found in Hesiod; of the things which it is unlucky to do; of the days which are lucky or unlucky, either altogether or partly and for specific works (765-828).

The most striking thing about the Hesiodic teaching is that here, as in the Hebrew 'Wisdom,' there is no question of a life after death. It is in this life that the just man finds his reward. It is in this life that the unjust meets his punishment. Good and bad alike, without distinction, go down to Hades—as far beneath the earth as the heaven is above the earth—and there is no distinction of fortune for the dead.

Death 'hath a heart of iron, and brazen and pitiless is the soul within his breast. Whomsoever among men he once hath seized, he keepeth; and he is hated even of the deathless gods. There in front stand the echoing halls of the god of the under world, of strong Hades and dread Persephone. And a dread dog keepeth watch before them; pitiless is he and hath an evil guile. On them who enter he fawneth with his tail and with both his ears; but to come forth again he alloweth none, but keepeth watch and devoureth whomsoever he catcheth coming forth from the gates of strong Hades and dread Persephone' (*Theog.* 764 ff.; cf. CERBERUS).

There is a hint of the doctrine of atonement in *Theog.* 783 ff., where we are told that, if any of the gods swears falsely,

'he lieth breathless till a year be fulfilled. And he never draweth nigh to eat of ambrosia and nectar, but breathless and speechless he lieth on a strewn bed, and an evil stupor covereth him. But when he hath fulfilled his disease for a great year, another and another more grievous ordeal awaiteth him, and for nine years he is separated from the everlasting gods, and never cometh to their counsels or their feasts for nine whole years; but in the tenth year he entereth again the assemblies of the immortals who hold the halls of Olympos.'

But such atonement is made by the gods. There is no hint of any such thing for mortal men.

LITERATURE.—*Hesiod*, ed. D. J. van Lennep, Amsterdam, 1847 ff.; J. E. Harrison, *Themis*, Cambridge, 1912; J. Adam, *The Religious Teachers of Greece*, Edinburgh, 1909; A. W. Mair, *Hesiod* (Translation and Appendices), Oxford, 1908; E. K. Rand, *Amer. Journ. of Philol.* xxxii. (1911), 131-166; A. Rzach, in *Pauly-Wissowa*, viii. (1913) 1167-1240.

A. W. MAIR.

HIERODOULOI (Græco-Roman).—In classical antiquity this term designated certain temple ministrants who were below the rank of priests, and usually, if not invariably, of servile status; but how far it was, or ought to be, applied to all temple slaves, and even to certain free persons who gave voluntary service, is very doubtful. E. Curtius (*Anec. Delph.*, Berlin, 1843, p. 16 ff.) led the way in giving it a very wide application, inclusive even of slaves manumitted by dedication or sale to a god, and he has been generally followed (cf., e.g., Daremberg-Saglio, *s.v.*). But the rarity of the occurrence of the term itself in Greek authors and inscriptions; the distinction sometimes implied in our authorities between *hierodouloi* and certain other ministrants, e.g. temple-sweepers (*νεωκόποι*); and the peculiar nature of the cults in connexion with which the term does actually occur—these considerations suggest that *hierodouloi* were an extraordinary class, not found in all temples or cults, and not to be confounded with the mass of sacred slaves.

The term itself has not been found in any author or inscription of earlier date than the Augustan period. Strabo uses it of ministrants in the temples of Ma at the two Comanas (535, 559), of Zeus at Venasa in Morimene (537), and of Men Pharnaces at Cabeira-Sebaste. These shrines are all Cappadocian. He uses it also in connexion with two temples of Aphrodite—one at Eryx in Sicily (272), and the other at Corinth (378). It is not used by Lucian in connexion with the cult of the Syrian goddess at Hierapolis; and its only other occur-

rences in literature seem to be where Philo employs it of Jewish ministrants (ii. p. 420)—probably a loose use of translation—and where Plutarch (*Amator.* 21) speaks rhetorically of the power of love over great men, who καθάπερ ιερόδουλοι διατελοῦσι.

As for inscriptions, we have a cippus from an unknown Cyclad isle, recording the death of a *hierodoulos*, a dedication to Hermes by one Asklepiades *ιερόδουλος* at Pselchis in Nubia, and another at Rome (in the time of Marcus Aurelius) to Zeus Helios by one who describes himself as *ιερόδουλος πάσης ιεροδουλείας*. At Ostia a *νεωκόρος* of Serapis dedicates to the *ιεροδουλεία*; and at Smyrna, in a text concerning the erection of public buildings, we hear of a Stoa πρὸς τὴν οἰκῆσιν τῶν ιεροδούλων καὶ τὸν θεὸν θεραπευόντων (CIG 2327, 5082; CIG, *Ital. and Sic.* 1024, 914; CIG 6000; Dittenberger, *Syll.*², Leipzig, 1898, p. 583).

At each of the two Comanas, according to Strabo, there were about 6000 *hierodouloi*; at the southern they formed the major part of the population; at the northern they were at the disposition of the high priest for every kind of service, but might not be sold. In both cases they were of both sexes. At Venasa there were 3000, and they formed a *κατοικία*. At Cabeira they were numerous, and tilled the sacred soil. At Eryx and Corinth only females are mentioned; and these were prostitutes, dedicated, we are told, by both men and women, to the service of the goddess. At the first shrine they had been numerous, but in Strabo's time the practice of dedicating them had largely declined; at the second there were above 1000, famous among seafaring men for their beauty and greed. It was to these women, doubtless, that Pindar devoted the *scholion* of which we have a beautiful fragment (87); but he did not call them *ιερόδουλοι*.

At Eryx and Corinth, then, we see that the *ιερόδουλοι* were nothing but female prostitutes, who gave all, or a share of, their gains to the temple. At Comana Pont., Strabo (p. 559) evidently means us to understand that a part of the *ιερόδουλοι* were included in the *πλήθος γυναικῶν ἐργαζομένων ἀπὸ τοῦ σώματος*, who made the place a 'little Corinth.' But at Comana Capp., Venasa, and Cabeira we are not explicitly informed that the *ιερόδουλοι* did anything but cultivate the temple lands. At the first shrine they were distinguished from a class of bearers of sacred images or emblems, *θεοφόρητοι*, who took part in the *θεοφορία*, mentioned also at Comana Pont., and are credibly supposed by Ramsay (*Cities and Bishoprics of Phrygia*, i. [Oxford, 1895-97] 136) to have been voluntary servants of free condition. There is, therefore, no doubt that the term *hierodouloi*, in all the instances so far discussed, means serfs, whose bodies were absolutely at the god's service and the priests' discretion, to be used either for purposes of labour or prostitution. They were inalienable, but probably could not acquire freedom; on the whole, they represent a class of slave whose condition was worse than was customary or generally approved in Hellas, whatever its sacrosanct character. Was the term, however, more generally used in popular or official parlance? Philo (*l.c.*) couples *νεωκόροι καὶ ιερόδουλοι*, but it would not be safe to say that he intends any precise distinction. Nor can we say whether the *νεωκόρος* of the Ostian inscription was included in the *ιεροδουλεία* to which he dedicates. The Smyrna inscription, however, seems clearly to distinguish *ιερόδουλοι* from mere *θεράποντες*; and the *ιερόδουλος* of the Roman text equally clearly seems to be proud of his condition and to magnify his office—*ιερόδουλος πάσης ιεροδουλείας*. If other temple ministrants are to be included popularly under the term, it should only be temple slaves, such as, e.g., the *οἰκέται* of Zeus at Olympia (Strabo, p. 532), the *δοῦλοι*

of Asclepius Archagetas on Parnassus (Pausan. p. 879), and such captives as the Phœnissæ of Euripides, or the *νεωκόροι* and *ζάκοροι* mentioned by Herodotus.

The term cannot have included free men and women who offered their services to the god for life or for a time, such as the Armenian ladies who prostituted themselves in Acilisene, or the *θεράπναι* of Apollo (*Hom. Hym. Apoll. Del.* 157). Even such a case as that of Ion in Euripides' drama seems to be excluded; for, though a foundling, he can say *ιερόν τὸ σῶμα τῷ θεῷ δίδωμι ἔχειν*, i.e., his service was voluntary like that of all whom he calls *φοίβου θέραιες* (Eur. *Ion*, 1284, 109). More clearly akin, probably, to the Eastern *hierodouloi* were certain cultivators of sacred lands in Sicily and Italy, the Venerei of Eryx and the Martiales of Larinum (Cic. *Verr.* ii. 3. 20, § 50, ii. 5. 54, § 141, *pro Cluentio*, xv. § 43).

It is true that such a class as the *ιερόδουλοι* was not likely to secure frequent mention in ancient authors or inscriptions; but it is impossible not to attach weight to the fact that only in a very few localities do we actually hear of *ιερόδουλοι*, and even in these not till a period at which Asiatic cults had become known and introduced to Greece. We prefer, therefore, to regard them as a peculiar class of servile ministrants not identical with the usual temple slaves of Greece or Italy. Their condition and their name seem alike usually to have been eschewed on Greek soil; and we must infer that the nature of their servility, both as cultivators and as prostitutes, was such as was less congenial to the West than to the East.¹

If we are right, then there is no further question of the manumission of slaves by sale, real or fictitious, to a god being a preliminary to the state of *ιεροδουλεία*, although it may very well have led to their becoming in many cases ordinary temple servitors, or even *ιεροί*.² That a slave could be dedicated to actual service in a temple is proved by a curious inscription of Lebadea,³ wherein a son, acting under his father's will, manumits a slave by dedicating him to Zeus Basileus and Trophonius, stating that his duty will be *λειτωργίμην ἐν τῆς θεοῦ τῶν θιῶν*, but only after he shall have rendered ten years' more service to the family which freed him. Such a condition, however, was undoubtedly not the rule. In the vast majority of cases the slave had no further obligations after being thus manumitted—e.g. at Delphi, where the god's payment really came out of the slave's own pocket. Probably local usage varied. Some temples had need of a large number of slave attendants, cultivators or prostitutes, and were prepared to support them; others had not the same needs, or were poorer. In any case, as it happens, we are unable to say that this custom of sacred manumission and the institution of *ιεροδουλεία*, expressly so called, co-existed at any one shrine.

LITERATURE.—This is given in the article.

D. G. HOGARTH.

HIERODOULOI (Semitic and Egyptian).—The term, which signifies simply 'sacred servants,' is employed by scholars to designate religious officials whose functions included sexual rites. Such officials can be traced in connexion with several shrines, and probably existed at others, concerning which no testimony has survived. These officials were of both sexes, though, as is natural, evidence for the existence of female *hierodouloi* is much more abundant than for male.

¹ Cf. Ramsay, *Cit. and Bish.* i. 147: 'It is probable that the *hieroi* represent the *hierodouloi*, as the institution was modified by the development of western civilization in Asia Minor.'

² So Hicks, in *Anc. Gr. Inscr. Brit. Mus.*, London, 1874-80, iii. 2, p. 86. Ramsay expresses doubts (*l.c.*). See art. *HIEROI*.

³ *Recueil inscr. jur. grecques*, Paris, 1892-1904, 2nd ser., p. 238.

1. Babylonian.—Evidence for the existence of female *hierodouloi* at Erech, in Babylonia, in connexion with the worship of the goddess Ishtar, is found in the Gilgamesh epic. The first tablet of the epic contains the story of Eabani, a wild man, who terrified a hunter whom Gilgamesh sent against him. The hunter was directed to take with him a *harimtu*, 'a woman who was *herem*,' or consecrated to a deity; this woman, when they approached Eabani, opened wide her garments, exposing her charms, yielded herself to his embraces, and for six days and seven nights gratified his desire, until he was won from his wild life.¹ In the light of the evidence from other shrines, to be presented below, there can be little doubt that this woman who was *herem* was a sacred prostitute belonging to the temple of Ishtar at Erech.²

From the code of Hammurabi, which was set up in Esagili, the temple of Marduk at Babylon, it appears that similar functionaries existed elsewhere, and were given a legal status by the code. The code was meant for Hammurabi's whole realm, and accordingly implies that such women might be connected with any temple of the land. Direct proof of the wide-spread nature of the institution is found in § 182, where 'women of Marduk,' the god of the city of Babylon, are granted greater rights in the inheritance of the property of an intestate father than other women of this class, as well as in the business documents, which mention the consecrated women of various gods.

Several terms are applied by the code to such women. They are called *NIN-AN*, 'woman of a god'; *SAL-zikrum*, 'vowed woman,' or possibly 'man-woman,' if *zikrum* be taken from a different root; *SAL-NU-GIG*, which is defined in the bilingual texts as *qadistu*, 'holy one'; and *SAL-NU-BAR*, which is defined as *zërmasitu*, 'seed-purifying' or 'seed-forgetful' ones. It is probable that these terms referred to different grades of this peculiar priesthood. The term most frequently used in the code is *SAL-zikru*. This class would seem to have been the most numerous. These women were hedged about with certain restrictions, but also had in some respects larger privileges than women in common life. There were special houses for them, in which they ordinarily lived, though they were not compelled to live there. If one did not reside in one of these special houses, she was forbidden, on pain of death, to open a wine-shop (§ 110). They were protected from slander by the same law which guarded the good name of married women (§ 127). A father could leave to such a woman an inheritance by will. In that case her brothers were to work her portion of the estate and pay her the income. Should she become dissatisfied with their management, she might take the property from their hands, and lease it to whomsoever she pleased. Her father's will might give her the power of leaving her property by testament after her death; if it did not, her share, when she died, reverted to her brothers. If she was accorded no portion by her father's will, she was to inherit equally with her brothers, if she was a *SAL-zikru*; if a *qadistu* or a *zërmasitu*, she received one-third of a brother's share (§§ 178, 179, 180, 181, 182). That the two classes last mentioned were temple prostitutes is sufficiently indicated by their names, especially when the use of *qūdhēsh* and *q'dhēshāh* in Hebrew (cf. e.g. Dt 23¹⁸) is compared. That the *SAL-zikru* were women of the same character appears from the fact that they might have children, and that these children stood in such a peculiarly orphaned condition that they were apparently frequently adopted into regularly constituted families (§§ 187, 192, 193). The 'women

¹ See *KB* vi. 127.

² Cf. Barton, *Sem. Or.*, 256 ff.

of Marduk,' for whom the code legislates especially, were apparently of the classes *qadistu* and *zërmasitu*, for, like these, they received, when no provision was made for them in a father's will, only one-third of a son's portion. Their advantage over other women of their class was that they could always dispose of their property at death as they chose (§ 182). Probably it was one of these 'women of Marduk,' who, Herodotus (i. 181) tells us, passed the night on the couch in the sanctuary at the summit of the *ziggurat* of the temple. Apparently she was supposed to act as the wife of the god. These votaries of Marduk appear in the contract literature.³ One of them, Lamazatum, married, and it was agreed that her children should be her heirs.⁴ Votaries of Shamash appear with especial frequency in contracts;⁵ votaries of Enmashtu (*NIN-IB*),⁶ sisters of Suziana,⁷ votaries of Zamama,⁸ *qadistu* of Adad,⁹ also are found. The relations of these women to the world, both when married and when unmarried, are to some extent revealed in the contracts. Thus a votary and her husband adopted a son and agreed that, if they had other children, this one should always be regarded as the elder brother.¹⁰ A *zërmasitu*'s marriage is recorded.¹¹ A man and his wife adopted the son of a votary of Shamash;¹² a votary of Shamash gave her daughter in marriage and received five shekels of silver;¹³ a votary of Shamash gave her daughter in marriage to her brother, stipulating that as long as the brother lived he should support his sister;¹⁴ another votary of Shamash gave her property to her grand-daughter, stipulating that the grand-daughter should support her as long as she lived.¹⁵ A woman consecrated her two daughters to Shamash, stipulating that they should support her as long as she lived.¹⁶ A *qadistu* and her sister divided an inheritance.¹⁷ One votary adopted a child;¹⁸ another brought suit for a share in an estate; another, who was the daughter of a king, was prominent in transactions in grain;¹⁹ while no fewer than three consecrated women appear in a lawsuit in which one sued another and the third appeared as a witness.²⁰ Votaries entered, accordingly, into the active affairs of life, much as other people did.

Lyon,²¹ like Johns,²² endeavours to support the improbable view that these consecrated women were chaste. His arguments are three in number: (1) one who slandered them was punishable in the same way as one who tarnished the name of a married woman; (2) one of them adopted a child; therefore, when it is said that one of these women had a child, probably it was adopted; (3) when one of these women married, the possibility that she might present her husband with a child is not expressed by the word *aladu*, but by *usarri* or *ustabši*. Lyon thinks that this was because votaries generally did not marry till they were advanced in years, so that it could be presumed that they would be barren.

With reference to these arguments the following points should

¹ Cf. *Cuneiform Texts . . . in the British Museum*, London, 1896-1912 (cited below as *CT*), viii. 48, Bu. 91-5-9, 2484; viii. 6, Bu. 88-5-12, 42; and Thureau-Dangin, *Lettres et contrats de l'époque de la première dynastie babylonienne*, Paris, 1912, pp. 147, 157.

² See, e.g., *CT* vi. 42, Bu. 91-5-9, 2470, viii. 2, Bu. 88-5-12, 10, etc.

³ Hilprecht, *Babylonian Expedition of the University of Penn.* (cited below as *BE*), Philadelphia, 1893-1910, vi. 26, 31, 45.

⁴ *BE* vi. 28.

⁵ Thureau-Dangin, *op. cit.* 157.

⁶ *Ib.* 146.

⁷ B. Meissner, *Beitr. zur altbab. Privatrecht*, Leipzig, 1893, no. 94.

⁸ *CT* viii. 50, Bu. 88-5-12, 33.

⁹ *BE* vi. 17.

¹⁰ *CT* iv. 39, Bu. 88-5-12, 617.

¹¹ Thureau-Dangin, 90.

¹² *CT* viii. 5, Bu. 88-5-12, 39.

¹³ *Ib.* viii. 39, Bu. 91-5-9, 2183.

¹⁴ *Ib.* vi. 42, Bu. 91-5-9, 2470.

¹⁵ Thureau-Dangin, 146.

¹⁶ Meissner, 24.

¹⁷ Meissner, *op. cit.* 24; *CT* viii. 33, Bu. 91-5-9, 487; Thureau-Dangin, *op. cit.* 162.

¹⁸ Thureau-Dangin, *op. cit.* 157.

¹⁹ *Studies in the History of Religion presented to Crawford Howell Toy*, p. 351 ff.

²⁰ *AJSL* xix. [1902] 96-107.

be noted. (1) The law against tarnishing the good name of a votary no more implies of necessity that she was a perpetual virgin than it implies that a married woman must be. We learn from Herodotus (i. 199) that certain rules had to be observed by women who became temporary *hierodouloi* (see below), and it is altogether probable that intercourse with one of these consecrated women was regarded as innocent only if practised under certain conditions. If such were the case, it is easy to see why the law should protect such a woman from the reputation of being a common prostitute, just as it protected married women. When the nature of the *harimtu* of Erech, the nature of the *qadheshah* in Israel, and the testimony of Herodotus are taken into account, together with the fact that unmarried votaries had children, one is compelled to interpret the law in the way suggested. (2) The idea that all the children of votaries were either adopted or born in wedlock is mere assumption. It has no support in the texts. (3) Lyon's explanation of the use of the words *usarti* and *ustabi* may possibly be right; but, even if it is, it does not follow that the consecrated women were virgins until married.

It is sometimes asserted (as by Johns¹) that these women were virgins who, when they married, still maintained their virginity. Johns supports his view by a reference to a text of the time of Hammurabi published in *CT* ii. 33, which, as he interprets it, states that a certain woman purified her daughter and then married her to another man, at the same time vowing her to perpetual virginity. In reality there is no reference to perpetual virginity in the text; it simply repeats the statement that the daughter was pure.² What this process of purification was we can only conjecture. It is clearly to be connected with the purification of a maiden before her adoption, to which another text refers,³ which has been thought to be connected with circumcision (see *СІАСІУСІОІОН* [Semitic], in vol. iii. p. 679^a). It clearly has no bearing on the marriage of female *hierodouloi*.

Two passages in the code refer to a class of men, called by the Sumerian name *NER-SE-GA*, whose children are classed with those of the *SAL-zikru*. An old syllabary defines *NER-SE-GA* as *manzaz-pani*, 'foremost place,' equivalent, as the name of an official, to 'dignitary' or 'magnate.' A legal document of the Hammurabi period⁴ describes certain men as *NER-SE-GA* of the temple of Marduk. It is clear, therefore, that they were religious officials; and, since the code accords their children the same treatment accorded to children of female *hierodouloi*, it is probable that they were sodomites, though full proof of this is lacking.

Closely connected in principle with the service of these permanent *hierodouloi* was the temporary pre-nuptial service in this capacity required of every Babylonian woman. According to Herodotus (i. 199), once in her life every Babylonian woman had to sit in the temple of the goddess of fertility until some stranger came and threw into her lap a piece of silver, uttering the formula: 'I beseech Mylitta (i.e. the goddess who helps women in travail) to favour thee.' Thereupon the woman lay with the stranger outside the temple precincts. The money thus given was sacred. Having discharged her obligations to the goddess, the woman returned home to a normal life. No disgrace, but rather honour, attached to her for this act. Strabo (XVI. i. 20 [p. 745 f.]), as well as the apocryphal Epistle of Jeremiah (v.⁴⁸), bears witness to this custom.

2. Syrian.—Among the Syrians of the upper Euphrates the Semitic mother-goddess was worshipped at Hierapolis-Bambyce under the name Attar, and this worship was closely akin to her cult elsewhere.⁵ Probably it is her worship to which the Syrian Father, Ephrem, alludes, when he says that, on the feast of their idol, women prostituted themselves, and virgins forthwith vowed their virginity to prostitution.⁶ These remarks would seem to point to the existence of both permanent and temporary *hierodouloi* at Bambyce.

At Hierapolis in Lebanon, the modern Baalbek,

¹ *Babylonian and Assyrian Laws, Contracts, and Letters*, Edinburgh, 1904, p. 187.

² Cf. Kohler and Ungnad, *Hammurabi's Gesetz*, Leipzig, 1904-10, iii. no. 26.

³ Published by Ranke, *BE* vi. 1 28 ff.

⁴ Meissner, p. 100, l. 32.

⁵ See Lucian, *de Syria Dea*, xv.; cf. also art. ASHTART.

⁶ Ephrem, *Opera*, 459 C.

custom required every maiden to prostitute herself to a stranger in the temple of Ashtart,¹ as the women of Babylonia were required to do for their goddess. Whether the regular sacred harlots were maintained there we do not know, but Eusebius says that even matrons as well as maids prostituted themselves in the service of the goddess. Perhaps this is not to be taken literally, but may refer to a regular order in which such women grew old. Constantine abolished the practice, destroyed the temple, and built a church in its stead.

3. Phœnician and Punic.—In Phœnicia these rites were, no doubt, practised in the worship of the same goddess, wherever her temples existed; for the Hebrews, who regarded Sidon as the chief city of Phœnicia, speak of the goddess as 'the abomination of the Sidonians' (2 K 23¹⁹). Definite evidence comes to us, however, through Lucian,² of the existence of this worship in a modified form in connexion with the worship of Adonis, or Tammuz, at Byblos (Geba). At his festival, we are told, all women who were not willing to sacrifice their hair were compelled to prostitute themselves for a day. Only strangers might solicit their charms, and the money received in payment of their shame was dedicated to the goddess. Lucian bears witness to the existence here of the institution of temporary harlotry as a sacred service, but shows that the custom had been modified, so that a modest woman might purchase immunity from this service by sacrificing her hair.

At Paphos in Cyprus, according to the testimony of Herodotus,³ Clement of Alexandria,⁴ Justin,⁵ and Athenæus,⁶ there was a similar practice. Each woman, whether princess or low-born, offered herself in prostitution before marriage. Justin, through a misunderstanding, says that they did it to obtain money for a dowry; but the reason for the custom is clearly religious, like that at Babylon. Whether there were at Paphos women permanently devoted to this type of sacred service, we do not know, but it is probable that at some time there had been. The pre-nuptial sacrifice of virtue, however, may have long outlived the permanent institution of *qadheshoth*.

At the other end of Cyprus, in connexion with a Semitic temple at Kiton, we have evidence of the existence of a class of male prostitutes. A fragmentary inscription (*CIS* i. 86) records the provisions granted for the festival at the beginning of a given month to various classes of temple officials. Although the ends of the lines, where the rewards were enumerated, are broken away, the beginnings, where the officials are mentioned, are preserved. Thus we learn that sustenance was apportioned to builders who repaired the temple of Ashtart, to doorkeepers, men set for the sacred service of this day, slaves, slaughterers, barbers who worked for the sacred service, engravers, the chief scribe, and resident aliens. The last-mentioned class consisted of foreigners, who, in accordance with ancient custom, had taken refuge in a strange land under the protection of the sanctuary.⁷ It is clear from its context that the 'dogs' (דִּבְלָיִם) must refer to a class of people, and equally clear that the word is to be interpreted by Dt 23^{18, 19}, where 'dog' (דָּבָר) is equated with *qadhesh*, or 'male prostitute.' If the Semitic settlement here supported male *hierodouloi*, the female were, without doubt, not lacking, though as yet evidence of their presence has not been recovered. At Eryx in Sicily the presence of a Semitic colony and a temple of Ashtart is attested by Phœnician in-

¹ Euseb. *Vit. Const.* iii. 58; Sozomen, *HE* v. 10. 7; Socrates, *HE* i. xviii. 7-9.

² *Op. cit.* vi.

³ i. 199.

⁴ *Protrept.* ii.

⁵ xviii. 5. 4.

⁶ xii. 11.

⁷ Cf. *Rel. Sem.* 2 76 ff., and Ps 54 15¹ 61⁴.

scriptions.¹ Strabo (VI. ii. 5 [p. 272]) testifies that formerly the temple of Aphrodite (Ashtart) was 'full of women *hierodouloi*.' In view of the nature of this class elsewhere, the functions of these *hierodouloi* need not be elucidated.

Among the Semites of North Africa the Semitic mother-goddess was worshipped under the two names of Ashtart and Tanith. Hundreds of votive inscriptions attest the popularity of her cult. The change of sentiment which came over the world with reference to the relation of the sexes in the early centuries of the Christian era led the worshippers of these goddesses to call them 'celestial virgins'; at least, that was the case with Tanith. St. Augustine² testifies that once in his youth he attended her festival, and that 'such foulness of obscene speeches and actions as the players would be ashamed when rehearsing to act at home before their own mothers, they acted publicly in the presence of the mother of the gods, in the sight and hearing of a very great company of both sexes.' He goes on to say that 'chastity was shamelessly outraged.' This language is vague and oratorical, but, in view of evidence from other parts of the Semitic world, it is probable that the devotees of the goddess at the time of her festivals became temporary *hierodouloi*, even though evidence for the existence of permanent *hierodouloi* in North Africa is wanting.

4. Arabian.—Among the pre-Muhammadan Arabs the worship of the mother-goddess was practised; in some places she was called Al-Lât, in others Al-Uzzâ. Few traces of the worship have survived from the non-literary pre-Muhammadan time, but Patristic references to the worship of Arabian goddesses imply that from the Christian standpoint it was, like that at Bambyce and Carthage, sexually impure,³ and the great Muhammadan festival at Mecca, which was taken over from heathenism, is still marked by sexual irregularities.⁴ We are safe, accordingly, in assuming that in Arabia the worship of the mother-goddess was accompanied by the temporary practice of sacred prostitution. Owing to the unsettled character of nomadic life, it is hardly probable that permanent officials dedicated to this service were maintained.

5. Hebrew.—As *hierodouloi* in some form are traceable in so many parts of the heathen Semitic world, it is probable that it was a primitive Semitic institution, which survived in practically all the Semitic nations. It becomes, then, an interesting question whether these officials had a place in early Hebrew religion. There is some evidence to show that they had. We are told (1 K 14²⁴) that the 'sodomite' (*qâdhêsh*) was in the land, and that in this respect Hebrew ritual did not differ from that of other nations. Again (1 K 15¹²), we read that King Asa drove the sodomites (*qâdhêshim*) out of the land. This reform must, however, have been but temporary, for Hosea (4¹⁴) declares that the women and brides of Israel not only commit harlotry (*i.e.* become temporary *hierodouloi*), but that the guides of the nations themselves, her rulers and priests, offer their sacrifices with sacred prostitutes (*qâdhêshôth*). The author of Deuteronomy, in the next century, bears witness to the existence of both male and female *hierodouloi* in his land, for he prohibits them for the future (Dt 23¹⁷). As legislators in modern times do not find it necessary to prohibit the sale of intoxicating drinks where such drinks are unknown, this law on the pages of Deuteronomy is evidence of the presence in Judah of the

¹ CIS I. 135-140.

² *de Civ. Dei*, II. 4.

³ Ephrem, *Opera*, 457 E, 458 I, 459 C; Epiph. *Panarion*, II.; Jerome, *Vita Hilarionis*, xxv.; and Isaac of Antioch, ed. Bickell, Giessen, 1873-77, p. 244, l. 449 ff.

⁴ Cf. Snouck Hurgronje, *Mekka*, Hague, 1888-89, II. 59-61.

institution legislated against. Further testimony to the same effect is found in 2 K 23⁷, where it appears that, in carrying out the reform, which he based on Deuteronomy, King Josiah found it necessary to destroy the houses of the sodomites (*qâdhêshim*) in the very temple of Jahweh. It is clear from the context here that *qâdhêshim*, though a masculine plural, refers to sacred prostitutes of both sexes, for the last clause of the verse describes these houses as 'where the women wove hangings for Asherah.' It seems, accordingly, that down to the time of Josiah *hierodouloi* of both sexes had been attached to the temple of Jahweh, and that the prophetic teaching had not sufficiently awakened the public conscience to dislodge them.

Two explanations of the presence of these ministers in Israel have been offered. The Hebrew prophets believed that they were no part of the ritual of Jahweh, but that they were an importation from other Semitic religions. Some modern scholars believe that the religion of Jahweh had its roots in the soil of primitive Semitic ritual, and that *hierodouloi* were one of the features which Jahweh's religion, like other Semitic religions, inherited from the parent stock. Whatever the origin of the institution, it is certain that, aided by the Deuteronomic law, the prophets imposed their view upon Judah, and finally uprooted this debasing type of religious service, banishing it from their land. How debasing it had become, and what frank appeals it made to those sensual passions which men have more need to control than to inflame, the excavations at Gezer make it possible for us to realize as never before. Such art as they possessed was employed to extend the appeal by which these sacred courtesans in the service of deity enticed men to indulgence.¹ That the prophets succeeded in removing from Judah's religion an institution consecrated by religious sanction and hoary with age, which appealed so powerfully to the animal element in man, is eloquent testimony to the fact that they were working with God and for Him.

6. Egyptian.—Among the Egyptians the institution of *hierodouloi* can be most clearly traced at Thebes. Strabo (XVII. i. 46 [p. 816]) declares that here 'a very beautiful virgin of most distinguished lineage was consecrated to Zeus (Amon), and that she played the concubine and had intercourse with whomsoever she desired until the natural purification of her body was accomplished (*i.e.* until the expiration of a month); then, after her purification, she was given to a husband.' This points to the existence of an institution kindred to that which we have traced among the Semites. That this practice was not confined to one woman, but was one manifestation of a more general institution, is indicated by an inscription of Ramses III., in which he tells of the disposition of the booty taken in his Syrian war. In speaking of the captives he says: 'I have carried them away: the males to fill thy storehouse; their women, to be subjects of thy temple.'² Breasted is undoubtedly right in thinking that these women became *hierodouloi*.³ This is confirmed by scenes pictured on the wall of the temple erected by Ramses III. at Medinet Habu, which one must see in order to appreciate. They are usually spoken of as '*harm* scenes,'⁴ but their occurrence in a temple would seem to indicate that it was no ordinary *harm*. On the great festival days the priestesses of Hathor and other deities danced before the god (or goddess) just as the women of the *harm* were accustomed

¹ Cf. R. A. S. Macalister, *The Excavation of Gezer*, London, 1912, vol. III. plates cxxx, cxxxi.

² Cf. J. H. Breasted, *Ancient Records of Egypt*, Chicago, 1906, IV. 128.

³ *Ib.* v. 152^a.

⁴ So Baedeker's *Egypt*, ed. 1902, p. 298.

to do for the entertainment of their earthly lord,¹ and it can hardly be that the dances were chaste.

At Thebes the wife of the high priest bore the title 'chief concubine,' while a queen or princess was called 'wife of the god.'² This recalls the statement of Herodotus (i. 182), that a bed on which a wife of the god slept for his enjoyment was placed in the inner sanctuary at Thebes for Amon, as in the sanctuary at the top of the *ziggurat* of the temple of Bel at Babylon. That it might be claimed that this relationship on the part of the wife of the god to him was no mere fiction is shown by the account which the famous queen, Hatshepsut, of the XVIIIth dynasty, gives of her parentage. She claims that the god Amon came and actually had intercourse with her mother.³ When it was thought that a god could thus treat women—and women, too, who had earthly husbands—it is probable that, under religious regulation, provision was made for similar conduct on the part of his worshippers. Osorkon II., of the XXIInd dynasty, declares that he had assumed 'the protection of the sacred women of the house of Amon and the protection of all the women of the city, who have been maid-servants since the time of the fathers.'⁴ The sacred women of the house of Amon are classed by him with the maid-servants throughout the city as having no natural protectors. They were probably of the class under consideration. The existence of *hierodouloi* in connexion with other Egyptian deities is not so clear. The god Min, of Coptos, is pictured with phallus erect, and it would seem probable that some such institution attached to his cult. Ramses III. says that he made decrees for the administration of the 'pure' settlement of women of the god Ptah of Memphis.⁵ 'Pure' is here used in a ceremonial sense; they were women consecrated to the god, whose functions were probably similar to the functions of the women of Amon. Perhaps it was a garbled report of the functions of such consecrated women, among whom were princesses, that reached Herodotus, and led him to say (ii. 126) that Khufu (Cheops), in order to obtain money for his pyramid, prostituted his own daughter. If there is any truth behind the story, it is probable that the princess was a priestess of Ptah and acted as a *hierodoulos*. That the Egypt of the Old Kingdom was not unacquainted with the circle of ideas which we have traced at Thebes is shown by the fact that one of the Pyramid Texts describes the king as 'the man who takes women from their husbands whither he wills and when his heart desires.'⁶ In the Old Kingdom the king was a god, and his actions were divine. Probably other gods, through such practices as we have traced, were thought to do the same.

The goddesses Hathor and Bastet were mother-goddesses, and were pictured nude, as were the Semitic goddesses of the same type.⁷ Hathor was praised in a chorus of dancing women.⁸ That women became temporary *hierodouloi* at the festival of Bastet at Bubastis is implied by Herodotus (ii. 60), who says that men and women went in large numbers together in boats to this feast at Bubastis, playing and singing the whole way. At towns they would disembark, sing, dance, and taunt the women of the town, some of the visitors pulling up their clothes. In the light of the goddesses' character, the nature of the services of these women is not difficult to divine.

A similar service seems to have attached to the worship of the god of Mendes, whom Herodotus

¹ Erman, *Ägypt. Rel.*², p. 61 ff.

² *Ib.* 87.

³ *Ib.* iv. § 751.

⁴ Breasted, *Development of Religion and Thought in Ancient Egypt*, New York, 1912, p. 177.

⁵ Erman, 200, 239.

⁶ Breasted, ii. §§ 196, 197.

⁷ *Ib.* i. § 321.

⁸ *Ib.* 61 ff.

identifies with the Greek god Dionysus. He tells us (ii. 48) that at his festival women carried about in procession images of the god with the member nodding, and that the member was about as large as the image. The women were singing the praises of the god. It seems clear that these women were playing the part of temporary *hierodouloi*, though they may have been in part permanently dedicated to that vocation. The institution seems to have been as wide-spread in Egypt as among the Semites, though its details cannot be so clearly traced.

The ideas which called into existence this institution, so revolting to modern feeling, can now be only conjectured. It seems most likely that it originated in a polyandrous society, and in that circle of ideas, traceable in many parts of the world, in which originated the custom of giving a bride the first night to a king or priest in order to secure the blessing of fertility. Priesthood and kingship in their later senses were unknown among the primitive Semitic and Hamitic tribes, and hence, probably, it was thought to secure the divine blessing by leaving the first and consecrating act to divine chance.

The temporary *hierodouloi* were a survival of this custom. The more permanent and professional *hierodouloi* were a later development, and grew out of the conception that intercourse with a supernatural being produced fertility and a remarkable offspring (cf. Gn 30² 6²⁻⁴). The consecrated *hierodouloi* were the representatives of deity, to give concrete expression to this idea. Fertility was thought to come to women through intercourse with these sacred males, and virile power to men through commerce with the consecrated women.

LITERATURE.—A. Jeremias, *Izdubar-Nimrod*, Leipzig, 1891, p. 59 f.; P. Jensen, *KIB* vi. (Berlin, 1900) 127 ff.; W. R. Smith, *Rel. Sem.*², London, 1894, p. 455 ff.; W. Nowack, *Heb. Archäol.*, Freiburg i. B., 1894, ii. 132, 307; I. Benzinger, *Heb. Archäol.*², Tübingen, 1907, pp. 121, 359-361; G. A. Barton, *Semitic Origins*, New York, 1902, chs. ii., iii., vi.; S. R. Driver, *Com. on Deuteronomy (ICC)*, Edinburgh, 1896, p. 264 ff.; W. R. Harper, *Com. on Amos and Hosea*, do. 1906, p. 261 ff.; S. A. Cook, *The Laws of Moses and the Code of Hammurabi*, London, 1903, p. 149 ff.; H. Zimmern, *KAT*³, Berlin, 1902, p. 423; A. Jeremias, *AT im Lichte des alten Orients*², Leipzig, 1906, p. 380 ff.; A. Erman, *Ägypt. Rel.*², Berlin, 1909, p. 239 ff.; L. R. Farnell, *Greece and Babylon*, Edinburgh, 1911, pp. 270-282; J. G. Frazer, *Adonis, Attis, Osiris*, London, 1906, pp. 20-28; T. K. Cheyne, art. 'Harlot,' in *EBI*, ii. 1964 ff.; W. P. Paterson, art. 'Harlot,' in *HDB* ii. 304; W. M. Ramsay, art. 'Rel. of Greece,' *ib.* v. 130^a; E. Kautzsch, art. 'Rel. of Israel,' *ib.* 662^b, 690; D. G. Lyon, 'The Consecrated Women of the Hammurabi Code,' in *Studies in the History of Religion presented to Crawford Howell Toy*, New York, 1912, pp. 341-360.

GEORGE A. BARTON.

HIEROI (*lepol*, *lepal*).—This word, as noun substantive, is found only in inscriptions, and, with very few exceptions, only in inscriptions of Western Asia Minor. Although much light has been thrown on *lepol* by recent explorations in Anatolia, much remains obscure concerning them (cf. Ramsay, *Cit. and Bish. of Phrygia*, i., Oxford, 1895, pp. 135, 147). On the mainland of Greece only two inscriptions have been found which mention *lepol*—the great Mystery Rule of Andania in Messenia, which is headed *Ἐπι τῶν καὶ Ἱερῶν* (Dittenberger, *Syll.*², Leipzig, 1898, no. 653), and another Messenian text discovered at Calamata (*CIG* 1487). In the first text certainly, and the second probably, the word is simply equivalent to *μύστης*, and means 'initiated.' Whether that is its sense also in inscriptions of Tenos and Delos (*CIG* 2339b, 2953b) is unknown. The word is not otherwise used in Greece of initiated persons; its Messenian use may safely be put down as local and singular.

In Asia Minor the name certainly does not mean the initiated, but temple ministrants. It seems clear that all *lepol* did not come to be so in the same way, nor had they the same tenure and conditions of service. (1) At certain shrines free

persons either dedicated themselves or were dedicated by parents and guardians to the service of a deity; but sometimes only for a period. So, for example, at Tralles, one L. Aurelia Æmilia, of good native family, boasts in an inscription (cf. Ramsay, p. 95) that, sprung from a family which had always done divine service by practising ceremonial prostitution, she likewise has so served by order of the god. At the shrine of Anaitis in Acilisene, 'the highest nobles consecrate their daughters while virgins; and among these it is the rule to live as prostitutes before the goddess for a long time before being given in marriage' (Strabo, p. 532). (2) The larger body of evidence seems to refer to involuntary *lepoi*, either of servile origin and status or at least of a status below civic freedom. At Erythræ, for example, we find that they were not included in the Demos, but had so well recognized a political position that they cooperated with the civic body to erect an honorary inscription. At Ephesus the evidence of the Mithridatic decree, concerning the payment of debts and future constitution of the city, is clear. The *lepoi* (doubtless of the Artemisium) are enumerated as a class to be enfranchised after the *παροικοί* or resident aliens, but before the *ἀπελεύθεροι* or freedmen (Wadd. 136a). At Magnesia ad Mæandrum (if *lepoi* be really noun substantive and not adjective in this inscription), *lepoi* of Apollo appear as gardeners (O. Kern, *Die Inschriften von Magnesia am Mæander*, Berlin, 1900, p. 115^a); and a Smyrna text shows a *lepoi* holding a servile relation to an individual citizen (Wadd. 1522a). The Delian text, quoted above, seems also to imply that a *lepoi* could be a private slave.

These instances, and especially the relative place of the *lepoi* in the Ephesian constitution, make it more than probable that in most cases the temple ministrants either had been slaves, or at best held a sort of freedman status from the first. Hicks, commenting on the Ephesian inscriptions (*Anc. Gr. Inscr. Brit. Mus.*, London, 1874-90, iii. 2, p. 86), confidently suggested that *lepoi* were the outcome of manumission by dedication or sale to a divinity—a revival of E. Curtius' view about *hierodouloi* (q.v.). But Ramsay (*op. cit.* i. 148), while inclined to admit this as possibly one among several origins of *lepoi*, objected that, if those so freed always became *lepoi*, we ought to meet more often and more widely with the class. It may be added to his objection that we have, as it happens, no records of this sort of manumission at Ephesus, and there is no reason to think it was a universal practice. On the evidence available, it is preferable to suppose that most *lepoi* had never been themselves slaves, but, if not of the voluntary class, were drawn from foundlings and orphans, either adopted by a priesthood of its own motion or consigned to it by outsiders (cf. the common modern practice of conventual institutions adopting foundlings and orphans, who act as servants). This origin is strongly supported by the inscriptions of the shrine of Apollo Lermenus (or Lairbenus), discovered in 1887 by Ramsay and Hogarth on the Upper Mæander, which throw more light on the condition of *lepoi* than any others.¹ In the ruins of the temple itself were found parts of several records of the dedication of *θερπταί* and *τεθραμμένοι*, words the usual sense of which is 'foundling' (cf. Ramsay, i. 147, who cites Pliny, *ad Traj.* lxxv). One of these gives explicit information to the effect that a child, now dedicated (*καταγράφειν*) by its proper parents, had been exposed in obedience to a dream, and found and reared (*ἐθρεψεν*) by a stranger. In no case is there mention of a *δούλος*. From

¹ See Hogarth, in *JHS* viii. (1887), and Ramsay, *op. cit.* i. ch. 4. In the latter publication the inscriptions are considerably added to and revised.

the same shrine and its neighbourhood came also a large number of inscriptions concerning *lepoi* and *lepoi*, which are of a class known as *exemplaria*. In these the ministrant, having failed in some duty or obligation of service, and been visited with divine vengeance (sickness?), acknowledges his or her fault, and sets up a warning to all other *lepoi*. Here it is reasonable to relate one class of inscription to the other, and to infer that the local *lepoi* were the outcome of a common practice of dedicating foundlings or orphans. If, moreover, it be borne in mind that the children of these dedicated persons, in all likelihood, retained their parents' status and functions, and that there were also certain voluntary and temporary recruits, we get a class quite numerous enough to account for all the *lepoi* for whose existence we have evidence in Western Asia Minor; a class, moreover, of sufficiently respectable origin to explain the political position which the *lepoi* held at Erythræ and Ephesus. In literature the case of Ion, the Delphic foundling, may be compared.

The duties of *hieroi*, of whatever origin, seem to have been in part those of *hierodouloi* elsewhere, but, in greater part, of more honour. In fact, it is very probable that, as Ramsay says (*l.c.*), they 'represent the *hierodouloi*, as the institution was modified by the development of western civilization in Asia Minor.' By an inscription of Chalcedon (Dittenberger, *Syll.*² no. 595), we see that they took part in the sacrifices and ritual, holding, no doubt, as Ramsay suggests, the same position as the *θεοφύλακται* of Comana, and probably also as the *ἄλλο πλῆθος ἀνθρώπων ἱρῶν*, the musicians, *castrati*, frenzied women, and prostitutes, whom Lucian saw performing *δργια* in the precinct of the Temple of Atargatis (Atheh) at Hierapolis of Syria.¹ If, like the *hierodouloi*, the *hieroi* in some cases practised ceremonial prostitution, and always did menial offices about the shrine, we have no reason to suppose that they were to the same extent serfs of the soil, although those of Apollo Lermenus inhabited a sacred settlement, *χωριον* or *κῶμη* (both words occur in the texts), and must have constituted a *κατοικία* not dissimilar to that of the *hierodouloi* of Venasa (Strabo, p. 537). It appears from the Lermenus inscriptions that they had obligations of personal service in the *hieron* at stated seasons, and were bound then, and probably for a certain period previously, to maintain ceremonial purity in garments and person, and abstain not only from lewd sexual actions, but from marital intercourse. The inner meaning of the latter obligation has been interpreted with great probability by Ramsay (p. 136) to imply, not that all sexual acts entailed impurity (for they might even be obligatory in the divine service), but that those usually held to be sanctioned by wedlock were especially repugnant to the cult of the Nature-goddess of West Asia, the Great Mother, which was a negation of true marriage altogether, and typified the matriarchal principle. In a well-known inscription of Laurium in Attica, recording the formation of an *eranos*, or religious club, by a Lycian slave, the conditions of ceremonial purity according to the usage of West Asia Minor are enumerated; and, with modifications, these may be predicated of all *lepoi*. They included, besides sexual abstention, the avoidance of a corpse and of certain foods, including pork and garlic, and freedom from skin complaints or contact therewith (see Foucart, *Assoc. rel. chez les Grecs*, Paris, 1873, p. 119 ff.). We find, in fact, in an obscure Lermenus text, that eating some part of the flesh of a goat called down the divine wrath on a *lepoi*; but in this case probably because the

¹ *de Dea Syr.* xlili.-l. Lucian distinguishes them from the priests (*ἱερείς*), of whom he saw above 300 at once, performing the higher offices of actual sacrifice, libation, and service of the altar.

animal was sacred. *Hieroi* and *hierai*, when not actually serving the shrine, seem to have lived as other people; and, as we have seen, the voluntary ministrants of the class could in some places (as, e.g., Acilisene) return altogether, after a time, to ordinary secular life; but, while engaged in the *hieron*, they evidently had to ignore their private condition. Those born free must for the time adopt a lower political status, wives must act as unmarried (*παρθέναι*), and married men must forget their marital duties. They must live, in fact, the divine life.

It is much to be hoped that further discoveries of inscriptions may throw clearer light on this peculiar institution of ancient religion. It seems to have contained certain elements of later monastic institutions, and may well have had a good deal to do with those which were developed at an early period in Christian Asia.

The use of *ιερός* as an adjective for persons dedicated to sacred service is, of course, common. It is found in literature as early as Herodotus (ii. 54, two *ἱερὰ γυναῖκες* at Dodona); but such dedication must have been much older. The best known literary instance is Ion. The word is also, doubtless, used sometimes for *hierodouloi*, as by Strabo in speaking of the prostitutes of Comana Pontica—*ὡν αἱ πλείους εἰσὶν ἱερὰ*.

LITERATURE.—This is given in the article.

D. G. HOGARTH.

HIGH PLACE.—I. Name.—The Heb. is *הַרְבָּע*, *bāmāh*, pl. *הַרְבָּעִים*, *bāmōth*, signifying 'high ground' or 'crest'; cf. the Assy. *bamātu*, pl. *bamāti*, 'height(s)'. The equivalent in the LXX is *στῆλαι* (in the Prophets also *βωμοί*; in the Historical Books, *ὄψη*, *ὄψηλά*); Vulg. *excelsa*; Pesh. 'alawāthā, 'high places,' sometimes *pérakkē*, 'idol shrines.' The Heb. terms *הַרְבָּע* and *הַרְבָּעִים*, which likewise signify 'height,' are not true synonyms of *הַרְבָּע*. The pl. *bāmōth* is used four times in the OT either as a proper name or compounded with some other proper name (Nu 21^{19, 20, 28} RVm, Jos 13¹⁷). It is also found as an element in a place-name on the Moabite Stone (line 27), and is likewise the name of a Moabite sanctuary for Chemosh (line 3). The origin of the name is unknown. In Hebrew it may have been—probably was—borrowed from the Canaanites. Ezekiel's derivation (20²⁹) of *bāmāh* as from *bā*, 'go,' and *māh*, 'what,' is, of course, a mere pun, by means of which the prophet expresses his contempt for high-place practices.

2. Location.—In the OT *bāmōth* are generally associated with elevations. People approaching them are said to 'go up' to (1 S 9^{12, 19}, Is 15²), and departing to 'come down' from, them (1 S 9²⁵ 10⁵). In Ezk 20^{28, 29} the singular *bāmāh* is synonymous with *gibh'āh rāmāh*, 'high hill.' They were usually located near cities (1 S 9²⁵ 10⁵), and were sometimes said to be in cities (1 K 13²², 2 K 17^{9, 29} 23⁹), or 'at the entrance of the gate' of the city (23⁹), or 'at the head of every way' (Ezk 16^{22, 21}); but also in valleys (Jer 7³¹ 19^{5, 8} 32³⁵, Ezk 6³). They were often on the hill above the town, as at Ramah (1 S 9¹²⁻¹⁴). Probably every city and village had one (2 K 17^{9, 11} 23⁸, Ezk 6⁵). They were evidently artificially constructed, for they are spoken of as having been 'destroyed,' 'broken down,' and 'burnt' (2 K 21⁸ 23^{8, 15}; cf. Ezk 6³, Lv 26³⁰, Nu 33⁵²). They were ordinarily 'built' (1 K 11⁷ 14²³). It is possible that they resembled the *ziggurats* of the ancient Babylonians. On the other hand, there is little doubt that they closely resembled, and in many cases were identical with, the ancient shrines of the Canaanites (Dt 12², Nu 33⁵²). This was in keeping with early religious custom. In primitive cults the crests of conspicuous mountains were regarded as the distinct territory of Deity. Zeus of the Greeks had many such mountain-abodes.

The gods of Persia, India, Java, and other lands were thought to dwell on lofty peaks. There were high places in Moab (Is 15² 16¹²), on which altars were erected (Nu 22⁴¹ 23^{1, 14, 28-30}, Jer 48³⁵). From Jer 3² it may be inferred that *sh'phāyīm*, 'bare heights,' were chosen because from them the view of heaven was unobstructed. In Ps 68¹⁶ Zion is regarded as 'the mountain which God hath desired for his abode'; while in 1 K 20^{23, 28} Israel's victory is ascribed by the Syrians to Jahweh who is 'a god of the hills.' All this is in keeping with the representations in the three great poems of the OT, which make Sinai Jahweh's primitive abode (Dt 33², Jg 5^{4, 5}, Hab 3³), whither Elijah fled when threatened by Jezebel (1 K 19¹⁻⁸).

3. Significance.—*Bāmōth* in the prose of the OT are commonly places of sacrifice. They are pre-eminently religious centres (1 S 9¹²⁻¹⁴, 1 K 3²⁻⁴, Is 16¹², Lv 26^{30, 31}); in Am 7⁹ 'high place' is synonymous with *mikdāsh*, 'sanctuary.' In poetry, however, *bāmōth* are occasionally spoken of as 'mountain fastnesses' (Ezk 36², according to the received text), and are symbolical of dominion (Dt 32¹³ 33²⁹, 2 S 22³⁴, Is 14¹⁴ 58¹⁴, Am 4¹³, Mic 1³, Hab 3¹⁹, Ps 18³³, Job 9⁸); but the term is used in the plural only, in this sense.

4. Sacred furniture.—Ancient high places possessed various sacred accessories, of which the principal one was: (1) *the altar, or place of sacrifice* (1 K 3⁴, Hos 10⁸). It might consist of either hewn or unhewn stone, even of a mere mound of earth. In the OT it is distinguished from the high place itself (2 K 23¹⁶, Is 36⁷, 2 Ch 14⁸). Before it the sacrifices were presented.—(2) Near the altar stood *the maṣṣēbāh, or sacred pillar of stone* (Hos 10¹⁻²). It might consist either of a rough unhewn boulder or of a chiselled pillar, which the worshipper regarded as the abode of Deity. In very ancient times these pillars were left unhewn because they were regarded as sacrosanct, the belief being that, if they were cut or carved by human hands, the *numen* would be driven out of the stone. Later, artificial obelisks took their place. To the ancient Canaanites the *maṣṣēbāh* was the symbol of the Divine presence, and was worshipped as the representation of Deity (Ex 23²⁴, Dt 7⁸ 12²). By the patriarchs such pillars were regarded as symbols of the true worship of Jahweh (Gn 28¹⁸⁻²² 31⁴⁵⁻⁵¹; cf. Ex 24⁴, Is 19¹⁹); but later they were proscribed as illegitimate because of their heathen and idolatrous associations (Dt 16²², Mic 5¹³). Among the Arabs they were smeared with blood in order that the offering might be brought into closer contact with Deity. Jacob poured 'oil' upon his *maṣṣēbāh* at Bethel (Gn 28¹⁸). In general the worship of stone pillars was a species of idolatry, their presence being the distinguishing mark of the sanctuary.—(3) Another important part of the furniture of a high place was the *'āshērāh, or sacred pole*. It consisted of an artificial pole of wood, or stump of tree, planted in the earth (Dt 16²¹), and was regarded as a symbol of the goddess Astarte, according to some, though this is not demonstrable. The *'āshērāh* was artificially constructed of wood (Jg 6²⁸, 1 K 14^{15, 23} 16²³, 2 K 17^{10, 16}, Is 17⁸), in image-like form (1 K 15¹³), and could be 'plucked up' (Mic 5¹⁴), 'cut down' (Ex 34¹³), 'broken to pieces' (2 Ch 34⁴), and 'burnt' (Dt 12³). It stood in close proximity to the *maṣṣēbāh* and to the altar (Jg 6²⁸), and might be set up even beneath living trees (2 K 17¹⁰). What its origin was it is impossible to say, but it was evidently akin to tree-worship, the tree probably being revered as an abode of Deity (Dt 11³⁰), and as the symbol of fertility. A famous *'āshērāh* stood in Samaria in the days of King Jehoahaz (2 K 13⁶), probably the one made by Ahab (1 K 16³³). Manasseh also made an *'āshērāh*, which he set up in the Temple in Jerusalem (2 K

21⁷), but it was destroyed by Josiah (23^{6,7}).—(4) Not infrequently, also, connected with *bāmōth* there were *rooms, chambers, or sacred halls*, called 'houses of high places' (1 K 12³¹ 13³², 2 K 23¹⁹). These were used probably as dwellings for the priests, and as the houses where the sacrificial meals were eaten (1 S 9²²); quite possibly also as the places of the most immoral worship—religious prostitution (Am 2⁸; cf. the 'vaulted chambers' mentioned by Ezekiel 16^{24, 21, 23}). These chambers also sheltered the images of the gods worshipped (2 K 17²⁹; cf. Jg 17⁶). Tents, however, were used for the same purpose (2 K 23⁷, Ezk 16¹⁶; cf. Hos 9⁶); for example, David pitched a tent to shelter the ark (2 S 6¹⁷ 7⁶; cf. 1 K 2²⁰, Ex 33⁷⁻¹¹; cf. also the proper name *Oholibamah*, signifying 'tent of the high place,' Gn 36²). The Carthaginians are said to have used tents as portable sanctuaries (Diod. Sic. xx. 65).—(5) There were *attendants* also at the high places, sometimes called *kōhānīm*, which is the ordinary word in Heb. for 'priests' (1 K 12³² 13^{2, 23}); sometimes called *kēmārīm*, 'idolrous priests' (2 K 23⁵). Besides these, there were *q'dhēshīm*, 'male prostitutes,' and *k'dhēshōth*, 'sacred harlots,' in connexion with high places (2 K 23⁷, 1 K 14²⁴ 15¹², Dt 23^{17, 18}, Hos 4¹⁴).

5. The cultus.—In general the worship practised at the *bāmōth* was not only ceremonial but sensual. It was borrowed largely from the Canaanites. Joy and feasting characterized their ritual (1 S 9^{12, 13}). The rites performed probably typified the annual renewal of Nature. Tithes were brought thither (Am 4⁴; cf. Gn 28²⁰⁻²²). Doubtless many of Canaan's high places became dedicated to Jahweh. Solomon, for example, sacrificed and burnt incense in the *bāmāh* of Gibeon, offering a thousand burnt-offerings upon the altar there (1 K 3^{2, 4}), and to please his foreign wives he built other high places to Chemosh and Molech, burning incense and sacrificing to their gods (1 K 11^{7, 8}). The Canaanites and Israelites may, indeed, have joined in the worship of Baal at some of these *bāmōth*. Whether they did or not, by the introduction of foreign cults the worship of the sanctuaries became corrupt. It is no exaggeration to say that the grossest and most sensual forms of religion described in the OT are associated with 'high place' worship. Hosea paints a vivid picture of their practices, though he mentions *bāmōth* by name only once in all his prophecies (10⁸). To him the high places of Aven were 'the sin of Israel.' Accordingly, he warns Israel against such sacrifices and libations (9⁴); points a finger of scorn at their rewards of adultery—bread, water, wool, flax, oil, drink, grain, new wine, silver and gold, which in turn they bestow upon Baal (2^{8, 9} 7¹⁴); denounces them for burning incense to other gods, themselves clothed in gala dress and decked with earrings and jewels (2¹²); threatens destruction upon the rewards of licentiousness received from their lovers (2¹²); and pronounces the ruin of all those who give themselves over to divination and harlotry in the name of religion (4^{12, 14}). Isaiah likewise gives a most striking description of heathen rites practised at the *bāmōth* (57²⁻⁸), explaining how the people inflame themselves among the oaks, slay their children in the valleys among the smooth stones (regarded as the abode of the *numina*, or gods), pour out drink-offerings as sacrifices on high mountains, and set up memorials of shame (perhaps alluding to phallic worship; cf. Ezk 16¹⁷). The same prophet describes Moab as literally wearying himself praying upon his high places (Is 16¹³; cf. 1 K 18²⁶).

6. History of high places in OT.—(1) *In the Pentateuch and Joshua.*—*Bāmōth* are not mentioned in either Genesis or Exodus; or, indeed, as places of worship, in the entire Book of Deuteronomy; cf. however, the figurative allusions in Dt 32¹⁸ 33²⁹,

in which to 'ride' or 'tread' upon the enemies' high places signifies to march over them in triumph. In Lv 26³⁰ and Nu 21²⁸ 22⁴¹ 33³², however, they are spoken of as places of worship. Two of these passages (Lv 26³⁰, Nu 33³²) warn Israel against the contaminating and despiritualizing influences of the heathen practices associated with such sanctuaries. They are the only passages in the Hexateuch which use the term with a religious significance. In Nu 21^{19, 20} and Jos 13¹⁷ the word is used as a proper name. The plural form is employed in all these instances.

(2) *From Joshua to Solomon.*—There is no mention by name of high places in the Book of Judges, and only a few cases (all in a single context) in the Books of Samuel refer to *bāmōth* as sanctuaries. The allusions in 2 S 1^{19, 20} 22³⁴ are poetical and figurative. In the classical passage in 1 S 9^{12, 13, 14, 15, 25} 10^{1, 13}, Samuel the seer is represented as going up to a *bāmāh* to worship, where the people await him, expecting him to bless the sacrifice (1 S 9¹²⁻¹⁴). While there, he is visited by Saul, who, with his servant, is searching for his father's lost asses. Saul and his attendant are invited to join in the sacrificial meal, which they eat together in the *ḥḥḥ*, or sacrificial dining-room (1 S 9^{18, 22}). Later in the account, mention is made of a band of prophets who are expected to come down from the high place, having presumably been there engaging in religious service (1 S 10⁵). The story gives no hint that there is anything illegitimate in sacrificing at such a sanctuary. In David's day, Gibeon was the great high place (1 Ch 16³⁹ 21²⁹). Under Solomon, also, the people continued to sacrifice at the high places, 'because there was no house built for the name of Jahweh until those days' (1 K 3²). Even the king himself 'went to Gibeon to sacrifice there, for that was the great high place' (1 K 3^{2, 4}, 2 Ch 1^{2, 13}). All this was in strict keeping with the traditional laws of Moses; namely, Ex 20²⁴, which allowed sacrifices to be made 'in every place' where Jahweh should record His name. Dt 12^{10, 11} insists upon the unity of sanctuary *only when God has given Israel rest from all their enemies round about*; when Israel should conquer Canaan and dwell in safety, *then* they should bring their sacrifices to the place which Jahweh should choose. This *may* be interpreted to mean that the law of the one sanctuary was not expected to come into practical operation until Solomon's time. Yet the fact is that Solomon did not observe this Deuteronomic law, for he built high places for his foreign wives; but he is explicitly rebuked for not having observed it (1 K 11⁷⁻¹³).¹

(3) *In North Israel.*—The revolt of the Ten Tribes under Jeroboam, and the gradual declension of religion in the Northern Kingdom, can be explained only in the light of the religious syncretism which had grown up in the nation before the death of Solomon. On entering Canaan, Israel had taken possession of the high places of the Canaanites. The common illiterate people did not grasp clearly the difference between the pagan worship of the Canaanites and the worship of Jahweh. As time went on, the upper classes also became indifferent, and dedicated Canaanite sanctuaries to Jahweh. The construction of the Temple did not, of course, change at once the people's devotion to local sanctuaries. Jeroboam built 'houses of high places, and made priests from among all the people,' and placed in Bethel the priests of the high places (1 K 12^{31, 32} 13^{2, 32, 33}), and the result inevitably was that Israel departed

¹ It is held by the majority of OT scholars that this rebuke is relevant only from the standpoint of the redactor of the Books of Kings, who reviews the history by the standard of the Deuteronomic code, which is believed by these scholars to have been first introduced in the time of Josiah (621 B.C.).

farther and farther from the worship of Jahweh, imperfect as that already was. Elijah, as a patriot, could protest only against the worship of Israel's sanctuaries rather than against the sanctuaries themselves (1 K 19¹⁰⁻¹⁴). On the other hand, the prophets of the 8th cent. attempted more than merely to reform the cultus of these sanctuaries. Hosea predicts that the high places of Aven, the sin of Israel, shall be destroyed (10⁸). Amos also declares that 'the high places of Isaac shall be desolate, and the sanctuaries of Israel shall be laid waste' (7⁹). The only other allusion in Amos to high places is figurative—that of Jahweh as treading upon the high places of the earth (4¹³). When the redactor of 2 Kings sums up the reasons for the downfall of North Israel, he ascribes it to their having built high places in all their cities and there burnt incense, as did the nations whom Jahweh carried away before them (17⁹⁻¹¹).

(4) *In Judah.*—Under Rehoboam the people built high places in Judah, and the king appointed priests for them (1 K 14²³, 2 Ch 11¹⁵). Asa is said to have taken them away out of Judah (2 Ch 14³⁻⁵), but not out of Israel (2 Ch 15¹⁷, 1 K 15¹⁴). Jehoshaphat likewise removed the high places from Judah (2 Ch 17⁶), but not from Israel (1 K 22⁴³, 2 Ch 20³⁰). On the other hand, Jehoram, who married the idolatrous daughter of Ahab, actually made high places in the mountains of Judah (2 Ch 21¹¹), which none of his successors—Jehoash (2 K 12⁹), Amaziah (14⁴), Uzziah (15⁴), and Jotham (15³⁵)—removed. Ahaz actively 'sacrificed and burnt incense' on them (16⁴, 2 Ch 28⁴⁻²⁶). Hezekiah, on the other hand, removed them, instituting a genuine religious reformation (2 K 18⁴, 2 Ch 31¹), the historicity of which is most reasonably attested (2 K 18²², 2 Ch 32¹²). But Manasseh rebuilt them (2 K 21³, 2 Ch 33^{3-17, 19}). Josiah, however, undertook and carried out a most drastic reformation, putting down the idolatrous priests and destroying the high places of all his predecessors, including Solomon's (2 K 23^{5, 8, 12-15, 19, 20}, 2 Ch 34³). During all this period of schism the prophets of Judah say little or nothing against the high places as such. Isaiah, for example, shows no pronounced hostility to high places themselves (14¹⁴ 15² 16¹² 36⁷ 58¹⁴). Micah, likewise, is all but silent concerning them, his allusions being figurative rather than literal (1^{2, 5} 3¹²; cf. Jer 26¹⁶). Jeremiah is more explicit and pronounced. He emphatically rebukes his people for having 'built the high places (the LXX has 'high place') of Topheth, which is in the valley of the son of Hinnom, to burn their sons and their daughters in the fire' (7³¹ 19⁵ 32³⁵), because they are centres of sin throughout all their borders (17⁸), and he threatens in Jahweh's name to cut off in Moab him who sacrifices in a high place (48³⁰; cf. Is 15² 16¹²). Ezekiel in similar strains protests against Judah's high places, and threatens in Jahweh's name to destroy them (6^{3, 6}). He points a finger of reproach at those who labour to make them attractive (16¹⁶), and warns those who congratulate themselves on possessing 'the ancient high places' (36²). Habakkuk's single allusion to high places is a figurative one (3¹⁰).

The only other references to *bāmōth* in the OT, with one exception, are Job 9⁸ and Ps 18²⁸, both of which are figurative; the exception is Ps 78⁵⁸, which is a literal commentary on Israel's repeated deflection from the true worship of Jahweh.

(5) *After the Exile.*—After the downfall of Jerusalem we hear little of high places. The captivity accomplished what neither Hezekiah nor Josiah could do. The people had learned at great cost the folly of idolatry, and her sons and grandsons, who returned after 536 B.C., had no disposition to revive the old local cults whose continuity had

been so long interrupted. In the 5th cent. B.C., however, there were altars to Jahweh in Elephantine, and, in the 3rd cent. B.C., at various places in the Delta of Egypt.

7. *Recent discoveries.*—During the past fifteen years several ancient *bāmōth* have been discovered, chief among which is: (1) the *Great High Place at Petra*, the capital of Edom, which was discovered by the present writer on 3rd May 1900. S. I. Curtiss was shown it in July of the same year. For location, size, completeness, and importance this high place still holds first rank among all the ancient sanctuaries as yet found to exist. A recent writer speaks of it as 'undoubtedly' existing already in the days of Moses (F. E. Hoskins, *From the Nile to Nebo*, Philadelphia, 1912, p. 336). It is situated on the very top of one of the most conspicuous peaks which surround the unique capital of Edom. Rock-cut stairways lead up to it from different directions. Two *maṣṣēbāhs*, or pillars, 100 ft. apart, situated on the brow of the promontory, mark the approach from the S.E. The oval rock-dome on which the *bāmāh* proper stands is some 300 ft. long (N. and S.) by 100 ft. broad (E. and W.). The view from the summit is unobstructed. Among the principal features of the sanctuary is the large, deep rock-cut court, 47 ft. long (N. and S.) by 20 ft. broad (E. and W.), where the worshippers probably stood. Near the centre of this court there is a raised platform 4½ in. high, measuring 5 ft. 1 in. (E. and W.) by 2 ft. 8 in. (N. and S.), on which the victims for sacrifice may have been slain. To the west of the court, some 15 ft. distant, with four steps leading up to it, is an altar, 9 ft. long (N. and S.) by 6 ft. broad (E. and W.), and 3 ft. high, with a rock-cut passage 32 in. broad, running about it on the N., W., and S. sides. In the surface of the altar there is a rectangular depression hewn out, intended perhaps for fire. Three of the corners of the altar seem to have been prepared by cuttings to receive 'horns.' Close by the altar and of about the same height, but extending nearer to the court, is an irregular oval rock platform, some 12 ft. 9 in. square, with circular depressions on the top surface (the one circle being inside the other), the diameter of the outer circle being 3 ft. 9 in., and that of the inner 17 inches. These were probably used as the place for pouring out libations (Ex 29¹²). A drain from the centre of the inmost circle would carry the blood, or water, as the case might be, towards the stairway by which the platform was approached (2 S 23¹⁶). In the sides of this platform there are two water cavities, which were probably used for purposes of ablution. About 32 ft. S. of the court is a pool or cistern excavated in the rock, and at one time cemented, whose dimensions, though somewhat irregular, are approximately 10 ft. long (N. and S.) by 8 ft. broad (E. and W.) and 4 ft. deep, with a drain to carry off the overflow. Two trees, of stunted growth naturally, and yet in one case measuring 2 ft. 10 in. in girth, are to-day growing in the near vicinity. From any part of the sanctuary the traditional Mt. Hor is visible. While this *bāmāh* is old, it cannot be demonstrated that it is the most ancient high place discovered, or even the oldest of those (in all 20 or more) now known to exist at Petra; all are devoid of inscription and ornamentation. At the same time, there is no doubt that this Great High Place was at one time the central sanctuary of the Edomites, and it may, indeed, mark the very spot where religious rites were celebrated by the sons of Esau three thousand years ago.¹

(2) *The High Place at Gezer.*—This *bāmāh* was

¹ A plan of the Great High Place at Petra is reproduced in Driver's *Schweich Lectures* (London, 1909), p. 61 (see also pl. facing p. 62); and in *HDB* iv. 306.

discovered by R. A. S. Macalister in 1902, and is described by him in the *PEFSt* of Jan. 1903 (pp. 23-36). It is situated in an open square just about the middle of the city, on the east declivity of the western hill, and was, doubtless, the centre of the city's religious life. It is the largest *bāmāh* as yet found in Palestine proper. Several of the essential features of an ordinary high place, however, are wanting. For example, there is no court for the worshippers; no certain place for the *'ashērāh*, or pole; and it is doubtful whether there is an altar, though Macalister thinks it possible that the bank of hard earth some distance to the south of the pillars, which was about 11 ft. in length and excessively difficult to cut, may have been the altar of the *bāmāh*. A similar altar of baked earth, ornamented with figures of animals in relief, was found by the Austrians at Taanach. The majestic series of eight huge unhewn monoliths, standing in a row on bases of smaller stones, due N. and S., and ranging in height from 10 ft. 6 in. to 5 ft. 5 in., define this place as a genuine *bāmāh* of the ancient Canaanites of Gezer. In breadth the largest of these obelisks measures 4 ft. 7 in., in thickness 2 ft. 6 inches. There were originally ten, but only the stumps remain of the two at the north end. The laver is identified with a square block of stone, 6 ft. 1 in. long by 5 ft. broad and 2 ft. 6 in. thick, standing beside the row of pillars, and having a rectangular hollow cut in the top of it, intended probably for ablutions. A remarkable feature of this high place remains still to be described. On the east of the northernmost of the monoliths there is an entrance leading down into two large caves, which are connected with each other by a narrow, crooked passage. They were once the residences of the 'cave-dwellers' in Gezer, and were originally independent but are now connected. The smaller of the two was found to have large blocks placed against its door on the inside. When the passage was clear, however, hearing was possible between the two, but seeing was not; accordingly it has been conjectured that the inner cavern was used as a secret chamber from which oracles were given forth, a priest or a boy being sent into the inner chamber before the inquirer was admitted to the outer. The human voice issuing from the mouth of the narrow tunnel would be regarded as the voice of a spirit or of a god. In Solomon's temple provision was made for an oracle (1 K 6¹⁶; cf. 1 S 28⁷⁻²³, 1s 8¹⁷). Underneath the *bāmāh* in a stratum of earth were found also some twenty earthen jars containing the skeletons of infants, all newly born, probably not more than a week old. Beside these jars, or, as in some cases, inside them, other smaller vessels were discovered, in which, perhaps, food was deposited for the infant in the other world. These bones are supposed to have been those of first-born children who had been sacrificed to some deity, either to appease his wrath or to obtain his help (cf. 2 K 3²⁷, Mic 6⁷). Finally, a bell-shaped pit resembling an ordinary cistern, situated a little to the east of the sacred cave, and apparently a little outside the sacred precincts of the sanctuary, used probably as the depository of the refuse from the sacrifices, completes the equipment of the Gezer high place.¹ In 1905 another *bāmāh* was found at Gezer, having four standing *maššēbāhs* and the base of a fifth (cf. *PEFSt*, 1907, p. 267 f.).

(3) *Other high places.*—Still other altars and pillars have been discovered from time to time in Palestine, but it would be perhaps incorrect to speak of them all as *bāmōth*. For example, Sellin of Vienna, in 1904, unearthed at Taanach, on the southern edge of the plain of Esdraelon in Galilee, a double row of five *maššēbāhs*; Schumacher of

¹ See figures reproduced in Driver (*l.c.*), p. 63.

Haifa more recently found two others at Megiddo; and, more recently still, Kittel of Leipzig discovered cup-shaped depressions or hollows in the rock surfaces at Mizpah, near Jerusalem. A complete list would also include the ancient rock-altar discovered at Zorah (Samson's birthplace, Jg 13²⁻²³) by Baurath Schick in 1887; and other 'finds' of similar character discovered at Tell el-Mutesellim, Gibeon, Tell es-Sāfi, and Tell Sanda-hannah by Guthe, Vincent, and others. The latest discovery reported is that unearthed during June and July 1912 by Duncan Mackenzie, field-director of the Palestine Exploration Fund, at 'Ain Shems, the ancient Bethshemesh (cf. *PEFSt*, Oct. 1912, pp. 171-178). While cutting a trench, from north to south, across the central area of the city, Mackenzie found, towards the middle of the trench, five pillars lying on their sides as though they had been knocked down, the one on the east side being broken in two as if it had been purposely smashed. These stones are regarded by him as the sacred pillars, or *bātyls*, of a high place. Their tops are rounded, but their bottoms are flat for better standing. Three of the five bear marks of tools. Two are flat like the headstone of a tomb, and are composed of a rough-surfaced, stratified kind of limestone which seems foreign to the environments of Bethshemesh. Mackenzie conjectures that they were set up in veneration of the dead, the spirit of the departed being imagined by the ancients to take possession of his pillar on the performance of certain ceremonial and magic rites for that purpose. At a point west of the high place a circle of stones was found, which leads by a shaft through the rock down into a great subterranean chamber, or burial cave, resembling those found at Gezer and Taanach. The cave extended away beneath the pillars of the high place, and contained all the paraphernalia of the cult of the dead, there in position as they had been left thousands of years ago.¹

Cf. ARCHITECTURE (Phœnician), vol. i. p. 765, and CANAANITES, vol. iii. p. 185.

LITERATURE.—W. von Baudissin, art. 'Höhendienst der Hebräer,' in *PRE³* viii. 177-195; A. von Gall, *Altier. Kultstätten*, Giessen, 1898; A. Van Hoonacker, *Le Lieu du culte dans la législation rituelle des Hébreux*, Ghent, 1894; W. C. Allen, art. 'High Place,' in *HDB*; G. F. Moore, art. 'High Place,' in *EBi*; E. G. Hirsch, art. 'High Place,' in *JE*; H. B. Greene, 'Hebrew Rock Altars,' *BW* ix. [1897] 329-340; I. Benzinger, *Heb. Archäol.*, Tübingen, 1907, pp. 314-334; R. A. S. Macalister, *Bible Side-Lights from the Mound of Gezer*, London, 1906, also *A History of Civilization in Palestine*, Cambridge, 1912, and in *PEFSt*, Jan. 1903, pp. 23-26; R. Kittel, *Studien zur heb. Archäol. u. Religionsgesch.*, Leipzig, 1908; S. R. Driver, *Modern Research as Illustrating the Bible* (Schweich Lectures), London, 1909; G. W. Gilmore, art. 'High Places,' in *The New Schaff-Herzog*, v. 276; S. I. Curtiss, *Primitive Semitic Religion To-day*, London, 1902; C. R. Conder, *Tent Work in Palestine*, London, 1880, pp. 304-310; E. B. Tylor, *PC⁴*, do. 1903; G. Dalman, *Petra und seine Felsheiligtümer*, Leipzig, 1908; C. Piepenbring, art. 'Hist. des lieux de culte . . . en Israël,' in *RHR* xxiv. [1891] 1-60, 133-186; W. R. Smith, *Rel. Sem.*, London, 1894; R. Smend, *Lehrbuch der alttest. Religionsgesch.*, Freiburg i. B., 1893; G. L. Robinson, art. 'The Newly Discovered High Place at Petra in Edom,' in *BW*, Jan. 1901, pp. 6-16, 'The High Places of Petra,' *ib.* Jan. 1908, pp. 8-21; D. Mackenzie, art. 'The Excavations at 'Ain Shems, June-July, 1912,' in *PEFSt*, Oct. 1912, pp. 171-178; A. R. S. Kennedy, art. 'Sanctuary,' in *HDB*, and 'High Place, Sanctuary,' in *SDB*; W. Nowack, *Lehrbuch der heb. Archäol.*, Freiburg i. B., 1894, vol. ii.; H. Ewald, *Alterthümer des Volkes Israel*, Göttingen, 1866; C. F. Keil, *Handbuch der bibl. Archäol.*, Frankfurt, 1875; B. Stade, *GVI*, Berlin, 1887, vol. i.; M. Vernes, art. 'Les plus anciens Sanctuaires des Israélites,' in *RHR* v. [1882] 22-48; H. Graetz, art. 'The Central Sanctuary of Deuteronomy,' in *JQR* iii. [1891] 219-230; S. A. Fries, *Den Israelitiska Kultens Centralisation*, Upsala, 1896.

GEORGE L. ROBINSON.

HIGH PRIEST.—See PRIEST.

HILLEL.—Hillel was a most distinguished teacher, and head of the Sanhedrin in Jerusalem during part of Herod's reign. Known as 'the Babylonian' (*Pesāhīm*, 66a; *Sukkāh*, 20a) be-

¹ See figures reproduced in Driver (*l.c.*), facing p. 65 and following pages.

cause he was a native of Babylon, he is also designated as 'Hillel the elder,' either to distinguish him from later teachers of the name or to indicate his official rank (*Bēšāh*, 16a). The dates of his birth and death cannot be fixed accurately. From the fact that he was one of the pupils of Shemaiah and Abtalion (see C. Taylor, *Sayings of the Jewish Fathers*², Cambridge, 1897, p. 18), and that tradition is emphatic in describing him as in his prime when he first arrived in Jerusalem, the inference is warranted that he was born about a century and a half before the destruction of the second Temple. No credence attaches to the statements (*Siphre Berākāh*, 36) that he was forty years of age when he left Babylon, that he spent forty more as a student under the 'pair' (see Taylor, p. 14, note 9), or that he was named and elected president of the Sanhedrin at the age of eighty, and filled that office for forty years more. All this is clearly due to an endeavour to make Hillel's career a parallel with that of Moses, just as he is hailed elsewhere (*Sukkāh*, 20a) as a second Ezra, who, like the first, comes from Babylon to rescue God's Law from complete oblivion. Talmudic report names him among the men who held the Presidency about 100 years before the national catastrophe (*Shabbath*, 15a). There is, therefore, good ground for dating his death at about 10 B.C.

Of his family little is known. Tradition traces its pedigree, through the female line, back to king David (Jerus. *Ta'anith* iv. 2). His father's name is not given, but a brother of his, Shebna, is mentioned as engaged in mercantile pursuits (*Soṭā*, 21a), and from him Hillel is supposed to have received substantial pecuniary assistance, though the passage just referred to admits also of the contrary interpretation.

Hillel from his earliest youth is represented as a student. Babylon then offered only scant opportunity for acquiring sound education in the things pertaining to the Law. 'What may one look for in a Babylonian?' was the constant scornful query which came from the tongue of the Palestinians, who held the would-be scholars from Babylon in slight esteem—a fact which Hillel was to discover the very first time he took a decided part in settling a controverted point of ritual practice (Jerus. *Pes.* vi. 1). The limited facilities which his homeland afforded for attaining full mastery of the intricacies of the Law induced him, in the prime of his manhood, to emigrate to Jerusalem (see *Siphra Tazriā*, § 10, where the perplexities are enumerated on which he felt light would be shed in the Jerusalem academy). Without means of subsistence, he braved the hardships of the poor student's life in order to satiate his mind with abundance of knowledge. Arrived in Jerusalem, he supported his family and himself by precarious manual labour. (Later Rabbinical authorities report his occupation to have been that of a hewer of wood [*Keseph Mishneh* to Maimonides, *Hilkhoth Talmud Torah* i. 9].) Out of his meagre earnings he was able to save enough to pay the small fee which the doorkeeper exacted from the students attending the lectures. But—so runs the story—one Sabbath eve he found himself without money. Yet this did not deter him. He climbed up at the window, listening intently to the word of God as explained by Shemaiah and Abtalion. It was in the month of Tebeth, midwinter, and the night was cold and snow fell thickly. Unmindful of physical discomfort, absorbed in following the expositions of the teachers, he neither felt numbness creeping on, nor was he aware of the increasing mass of snow that enveloped him. In the morning, Abtalion, trying to discover why the room continued dark long after the expected hour of light, spied Hillel under a mantle of snow three cubits

thick, his life well-nigh extinct. Though it was the Sabbath, they brought him in and proceeded to revive him, saying that for one so worthy the Sabbath might be desecrated. This experience of his came to be cited against the plea of poverty as an excuse for neglecting study (*Yoma*, 35b).

If Hillel's personal circumstances were not of the easiest, the political conditions of the times were by no means propitious to the peaceful pursuit of his studies. Herod persecuted the teachers of the Law unsparingly. Internal dissensions between the contending politico-religious factions (Pharisees and Sadducees) added an element of uncertainty to the situation. This may have been the reason why Hillel returned to his native land. It is not known when he left Jerusalem, or how long he stayed in Babylon. The fact that when he emerged into publicity—according to some, in consequence of a call sent him to Babylon—the 'sons of Batheira' were at the head of the school, and the practice of the 'pair' who preceded them apparently was forgotten, would seem to indicate that his absence had been of long duration. The identity of these 'sons of Batheira' is in doubt. The name is most likely that of a Sadducean school, partisans of Herod. This would explain their ignorance of the practice of their predecessors, and their disinclination to base decisions of ritual matters on reasoning by analogy and *a fortiori*, and the other methods of exegesis employed by Hillel. This is shown by the incident related in the Talmud to account for the withdrawal of the sons of Batheira from, and the elevation of Hillel to, the Presidency (Jerus. *Pes.* vi. 1, Bab. *Pes.* 66a).

The fourteenth day of Nisan, the eve of Passover, chanced to coincide with the Sabbath. Grave doubts arose whether the Paschal lamb could be slaughtered at such a time. But one who remembered that Hillel had been one of Shemaiah's and Abtalion's students suggested that the matter should be submitted to him, notwithstanding the jeering comment of others that he was a Babylonian (see above). Hillel came and decided the question in the affirmative, contending that the Passover sacrifice set aside the Sabbath-injunction (בפסח רמה שבת). He based his opinion on these considerations: Passover was, like the daily offering (*tāmid*, יָרֵקָה), a community and not a private offering; and, as the *tāmid* set aside the Sabbath, so did the Passover lamb. Moreover, when speaking of the *tāmid*, Scripture employs the term *b'mo'edah*, 'in its season'—a term used also in connexion with the Passover-sacrifice. Hence the latter is in the same category as the former. Again, neglect of the *tāmid* entails lighter punishment than non-observance of the Passover, which is visited with *kdareth*, 'excision.' The presumption in favour of the Passover is, therefore, all the stronger than it reasonably could be in the case of the others. These arguments failed to convince his opponents until Hillel remembered that he had heard them from his teachers, whereupon he was appointed *Nasi*, 'head.'

The historical accuracy of this story may safely be doubted. The narrative proves, however, that 'the Babylonian' for some time must have led a growing opposition to the Benê-Batheira, bringing to bear on the text of Scripture a method of interpretation not in favour with them, and clinching his arguments by appealing to the authority and precedents of his masters. Finally, Hillel succeeded in dislodging the Batheirites. His main support may have been Herod, who at this period of his reign was anxious for peace, and, therefore, not disinclined to the election of a 'man of peace,' such as Hillel was (see below), to the presidency.

Certain it is that Hillel is associated with the formulation of exegetical rules (מִדּוֹת, *middoṭh*, 'measures'). He is credited with having developed seven of them—by later teachers enlarged to thirteen. Though probably not the inventor of the method, which orthodox Jewish tradition regards as of Mosaic origin (*Sanh.* 99a), Hillel may be held to have been among the first to divide these rules into distinct categories (Hillel's catalogue is given in *Siphra* at the end of the *Baraita d'R. Yishmael*, and again in ch. 37 of the *Abhoth of R. Nathan*, and in the *Tosefta Sanh.* 7).

Not many ritual-legalistic decisions are remembered as Hillel's. On a few points he is reported to have differed from his Vice-President Shammai, who inclined to more rigid constructions of the Law. Both of them founded schools, not always agreeing in theory or practice. But these controversies are of too technical a character to be noticed here. Hillel is also mentioned as a compiler of *Mishnayoth* (*Yebhāmōth*, 37a).

Of greater interest as throwing light on the attitude of Hillel to the letter of the Law are the *Tekanoth*, the modifying arrangements, of which he was the author. War, failure of crops, and the policy of spoliation pursued by Herod, which led to excessive burdens of taxation, had reduced the people to distressing poverty. The dispossessed were forced to resort to loans, while those in better circumstances were little inclined to make the advances in view of the provision of the Pentateuch, according to which the advent of the Sabbatical year 'outlawed' all indebtedness. To meet the situation, Hillel devised the *prosbol* (πρός βουλή), which enabled the creditor, by making the court his agent, to whom before the Sabbatical year he had assigned his claim, to collect his due from his debtors even after the Sabbatical year (*Shebhi'ith* x. 3; *Gittin* iv. 3). Similar relief was obtained by another of his 'arrangements,' which provided that in case of the absence of the (temporary) purchaser of a house in a walled city the original proprietor could repay the purchase price into the hands of the court or deposit it in the 'hall of the hewn stones' (*lishkhath hāgāzith*) and re-enter into the possession of the house. He was prompted to devise this procedure in order to circumvent the strategy of the purchaser, who often went into hiding the last day of the year—the period of grace for the redemption of such property, according to the Pentateuch—and, not being repaid, refused to release the house (*Arakhin* ix. 4). The legitimacy of the issue of certain marriages contracted in Alexandria being doubted, Hillel, construing the marriage contract according to its intent, declined to stigmatize the children as bastards (*Baba meši'a*, 104a).

Hillel's great distinction, however, was won as a teacher of ethics, both by precept and by example. A man of peace-loving disposition, of tender, humane sympathies, of genuine piety, of true humility, he stands forth a shining exemplar of the virtues which his religion consecrated. Beloved by his contemporaries, he has lived in the memory of posterity as the teacher in whom came to flower the sweetest and the strongest gifts that faith in Israel's God had power to stimulate.

Of his 'sayings'—reported partly in Aramaic, his native idiom, partly in Hebrew, and some of them in both Hebrew and Aramaic versions—some are contained in the collection of Jewish ethical maxims left by the Tannaim, the masters of the Mishna (Taylor, *op. cit.*). The high estimate he placed on peace is revealed by this saying:

'Be of the disciples of Aaron, loving peace and pursuing it; loving all mankind (or all created beings) and bringing them nigh to the Torah' (*Abhoth* i. 13).

Humility, wholly free from pretence, is the keynote of this observation:

'A name made great is a name destroyed; he who increases not, decreases; and he who will not learn (perhaps teach) deserves slaughter; and he who serves himself with the tiara (is arrogant) perishes' (*ib.* 14).

The clearest insight into the relation between egoism and altruism, positing the duty of self-reliance and self-development as the means of rendering service unto others—a conception which is characteristically Jewish and soundly and sanely limits both self-effacement and self-aggrandizement—is exhibited in the words:

'If I am not for myself, who is for me? And if I am only for myself, what am I? If not now, when then?' (*ib.* 15).

Egoism and self-sufficiency found no favour in his eyes.

'Separate not thyself from the community, and trust not in thyself before the day of thy death; judge not thy fellow until thou comest into his place; do not delay teaching; say not, "When I have leisure, I shall study"; perchance thou mayest not have leisure' (*ib.* ii. 5; see Taylor, *op. cit.* p. 30, note 11).

Ignorance and vulgarity preclude piety.

'No boor is a sinner; nor is the unrefined pious; the shamefaced is not apt to learn, nor the passionate (prone to anger) fit to teach. Nor is every one that has much traffic wise. In a place where there are no men, endeavour to be a man' (*ib.* 6).

The thought that, as we do unto others, so will we be done by he put into this language, suggested by the sight of a skull floating on the water:

'Because thou drownedst, they drowned thee; and they that drowned thee shall in turn be drowned' (*ib.* 7).

That ease and luxury are, in the ultimate analysis, burdens is the dominant emphasis of this saying of his:

'More flesh, more worms; more maid servants, more lewdness; more men servants, more theft,' etc. (*ib.* 8). 'But he who hath gotten unto himself the words of the Torah hath gotten unto himself life in the world to come' (*ib.*).

For most of the preceding sentences, he could easily have selected as supporting authority one or the other Biblical passage. In recording other sayings of his, this has been done (see W. Bacher, *Die Agada der Tannaiten*, i., s.v. 'Hillel'), and, as the apostrophe to the skull in *Abhoth* ii. 7 suggests, he was by no means averse to employing the *mashal*, parable, or simile. Pointing to the statues of the kings in the theatres and the circuses, he deduces from the duty to keep them clean by washing and scouring them, which is incumbent on the keeper, that laid on man to keep his body clean by bathing, for the human body is made in the image of God (*Midrash Lev. Rabba* xxxiv.; *Yalkut* to Pr 11¹⁷). The soul he likens to a guest whose entertainment (i.e. study) was expected of man (*ib.*).

The proselyte anecdotes of which Hillel is the hero are characteristic tributes to his humanity, his forbearance, his patience—traits which stand out all the more prominently because they are in contrast with the contrary dispositions of his colleague Shammai. How Hillel remains unperturbed under the greatest provocation is told in the story of the man who made a wager that he would succeed in angering Hillel, and failed ignominiously (*Shab.* 31a; Taylor, p. 23, note 33). The 'Golden Rule,' virtually the saying, 'Thou shalt love thy neighbour as thyself' (Lv 19¹⁸), he names the fundamental principle of the Jewish religion, and designates everything else as an unfolding thereof. Thus, in conversation with a proselyte who promised to accept Judaism provided it could be taught him during the time he could stand on one foot (i.e. *stante pede*, briefly and without unnecessary delay), Hillel replied: 'What is hateful unto thee do not do unto thy fellow. This is the great foundation; the rest is commentary. Go now and learn.' This negative formulation of the 'Golden Rule' is not less comprehensive than its NT counterpart (see *JE*, art. 'Golden Rule,' vi. 21; and art. under that title in the present work).

The esteem in which Hillel was held led posterity to attribute to him the knowledge of God's true name and that of the speech of plants and birds and of many peoples (A. Jellinek, *Beth Ha-Midrash*, Leipzig, 1853-78, ii. 117; *Mass. Sopherim* xvi. 9). But the tribute paid him at his bier in the lament, 'Woe! Departed is the pious man. Woe! gone is the humble man, the disciple of Ezra' (*Sanh.* 11a; *Soṭa*, 48b), showed how his worth was recognized by those who had heard him 'praise God every day' (*Bēṣāh*, 16a), who had been inspired by his faith in God, so intense that he was confident 'outcry at adversity did not proceed from his house' (*Berakhoth*, 60a; *Jerus. Berakhoth*, 14b).

who had been taught by him true charity, which endeavoured to restore to the dependent all the comforts and honour of his better days (*Ketubhoth*, 67b), and who had by him been brought 'to scatter (learning generously) when there are men to gather in' (*Berakhoth*, 63a).

LITERATURE.—W. Bacher, *Die Agada der Tannaiten*, i., Strassburg, 1884; I. H. Weiss, *Dor Dor we-Dorshaw*, Vienna, 1878; H. Graetz, *History of the Jews*, Eng. tr., Philadelphia, 1888; A. Geiger, *Vorlesungen über die Geschichte des Judenthums*, i., Berlin reprint, 1909; *JE*, art. 'Hillel,' vi. 397

EMIL G. HIRSCH.

HIMYARITES.—See AFRICA, SABÆANS.

HINAYĀNA.—*Hina* means 'abandoned,' 'low,' 'mean,' 'miserable'; *yāna* means 'carriage,' 'means of progression,' 'vehicle'; the compound word *Hinayāna*, as used of religious opinions, means a wretched, bad method, or system, for progress on the way towards salvation. It was a term of abuse occasionally used by some of the later Buddhist authors, who wrote in Sanskrit, to stigmatize or depreciate those older teachings which they desired to supersede. The use of the term in India, however, is exceedingly rare—not that the theologians of the later deistic Buddhist schools were not sure they were right; but the word was not polite, and the needs of controversy could be met without it. It might be now left in fit obscurity, had it not been adopted by one or two well-known Chinese and European writers, to whose sympathies it appealed, and who have made it a cornerstone of their views on the history of Buddhism. This makes it desirable to summarize the little that is known on the subject of the so-called Hinayāna schools.

1. Origin and date of the term.—In the present stage of our knowledge of the history of Buddhism we suffer from a serious gap in the chain of available authorities. From the rise of Buddhism down to the time of Aśoka (q.v.), we have documents of varying age and importance, which enable us to draw a fairly accurate picture of the original Buddhism as understood by the early Buddhists, and also of the changes in doctrine down to the close of that period. The majority of these documents are in Pāli, but there are a number of side-lights as to detail from other sources, both early and late.

The following period of about three centuries, from Aśoka to Kaniska, is an almost complete blank. Even the date of Kaniska is uncertain. The able and sober discussion of the question by H. Oldenberg in the *JPTS* for 1912, the latest utterance on the point, suggests the end of the 1st cent. A.D. or the commencement of the 2nd as the most probable approximate time of Kaniska's accession. We have notices from Chinese sources as to national migrations in Central Asia, which resulted in successive movements of nomad tribes into the districts adjacent to the extreme N.W. of India. These notices are not always very clear, and at times appear conflicting; but they are sufficient to show that such movements in Central Asia were continually taking place during the centuries immediately preceding the Christian era, and culminated in the conquest, not indeed of India, but of Kashmir and the Panjāb, and of the districts round Mathurā and Gujarāt, by hordes of uncivilized nomads, mostly Huns or Śakas by race. These aliens adopted the religion, language, and civilization of the Indian peoples, mostly Buddhist, whom they conquered. Kaniska, the most famous and powerful of their princes, became a Buddhist; and lavishly supported the Buddhist scholars in Kashmir, who belonged to the *Sabbatthivāda*, the Realist school.

The result of these events was a momentous change affecting all the subsequent history of India.

Politically the centre of power was moved, for centuries, from the east to the west of the continent. Linguistically the Kosala dialect, of which Pāli is the literary form, had to yield its place, as the *lingua franca* of political, religious, and literary circles, to the dialect of Kashmir, of which Sanskrit is the literary form.¹ In religion a complete transformation was gradually but surely brought about. The brave barbarians became Buddhist so far as they were able. But they were so soaked in animistic superstitions that their ability was equal to the task only after they had brought down the religion to the level of their own understanding. There had been a slackening already. It is apparent in the later parts of the *Nikāyas* themselves, and is shown quite clearly by the questions considered in the *Kathā Vatthu* as being discussed in the schools at the date when that work was composed (c. 250 B.C.). From the time of Kaniska the whole power and influence of the Imperial State were thrown on the side of the animistic tendencies, and it was within the boundaries of the empire of the Kushan Tatars that the more important of the innovations were introduced into Buddhist doctrine.

A precisely similar series of events took place in Europe. A wave of invasion, similar to that which broke on the N.W. frontiers of India, and due, indeed, to similar national movements in Central Asia, broke in its turn over Europe. The Goths and Vandals adopted the faith of the Roman Empire. But, in adopting it, they contributed largely to the changes—some would call them deteriorations—that had already set in. When the conflict of nations subsided, the religion of the Roman Empire had become Roman Catholicism; politically the Continent was broken up among a large number of petty principalities, and such philosophy as survived was perforce of one and the same authorized pattern.

At the corresponding period in India, we find Buddhists who had borrowed from the pagans, and pagans who had adopted and improved upon the conflicting speculations of the many Buddhist schools. Philosophy was very much alive; and quite a number of conflicting systems were able, in the absence of even any attempt at authoritative suppression, to appeal to the suffrages of inquirers. It was at this stage that the word *Hinayāna* came into use. The oldest datable mention of the word is in the *Record of Buddhist Kingdoms* by Fa-Hian, written shortly after his return to China in A.D. 414. He states, in his account of Shen-Shen (N.W. of Tibet):

'The King professed our Law (Dharma), and there might be in the country more than three thousand monks who were all students of the Hinayāna.'²

In about half a dozen other passages he has similar statements. Legge, in his note on this passage, says that there were three vehicles—the larger, smaller, and middle (*mahā*, *hīna*, and *madhyama*), suggesting, therefore, that Fa-Hian had these three in his mind. It is, however, by no means quite certain what the word, at that date, exactly meant, or what Fa-Hian had in view, whether he had learnt the phrase in China, or picked it up during his travels in India. It is not probable that Legge's suggestion is right. That group of three vehicles has not been found elsewhere. The *Saddharma Puṇḍarīka*, which is later, gives a different group of three: *brāhmana*, *pacceka-buddha*, and *mahā*—in which *Hinayāna* does not occur. This group seems to have been widely known, as it is found also in the 3rd cent. in Ceylon, only applied to the word (*vachana*) instead of to the vehicle (*yāna*).³

¹ Rhys Davids, *Buddhist India*, London, 1905, ch. ix., and R. O. Franke, *Pāli und Sanskrit*, Strassburg, 1902, p. 87 ff.

² J. Legge, *Travels of Fa Hien*, Oxford, 1866, p. 15.

³ R. Morris, *Buddhavamsa* (*PTS*, 1882), p. xi.

The word occurs in the *Lalita Vistara*,¹ in a long list of qualities or states of mind, each of which is said to conduce to some other quality. In this list it is said :

'Thought, that opening (or beginning) of religious light, conduces to scorn for a mean method' (*hinayāna*).

Unfortunately, the date of the existing text of this work (which has been certainly recast once, and perhaps oftener) is late and uncertain.² Such a list as this lies peculiarly open, in a re-casting of the work, to sectarian interpolation; and the passage throws little light on the meaning of the word, as it is short and ambiguous. It might equally well be rendered 'scorn for the Hinayāna.'

Nearly two centuries and a half later we know that another Chinese pilgrim, I-Tsing, explained the word *Hinayāna* as meaning one who did not believe in the various deities and heavens created by the later schools. Fa-Hian may have thought the same, or he may have had, not a negative, but a positive test: that a Hinayānist, for instance, was one who still believed in the Aryan eightfold Path; or he may simply have considered that a Hinayānist was a man who belonged to one or other of the eighteen primitive schools. The last seems the most probable explanation. It was the easiest way to draw the line. We know from Fa-Hian's 36th chapter (Legge, p. 98) that he was familiar with the list of these schools current among so many of the Buddhists. But, whatever be the exact meaning attached to the word *Hinayāna* by Fa-Hian, it is probable, from his use of the Chinese equivalent of it, that the word, and with it the division of Buddhists into Hina-yānists and Mahā-yānists, was already current in India in the 4th cent. A.D.

2. The Hinayāna schools.—We have quite a number of copies of the list just referred to. The Sinhalese give it in half a dozen different books, from the 4th cent. A.D. downwards. They all agree in the names, having taken them from the still older, but now lost, Sinhalese *Atthakathā*. St. Julien³ reproduces five distinct lists from the Chinese. Schiefner, Wassilief, and Rockhill give us other lists from the Tibetan.⁴ These eight differ from one another, and from the Pāli list, in a few of the names; omitting one or two, and adding others. Each of them also pretends to be able to say of each school that it arose out of some other, and gives the name of the latter. In the details of these statements they also differ; and it is most unlikely that their language can ever have been exact except in a very limited sense. They can, at most, when they agree, afford us some guide to the relative age of the various schools within the period of a century and a half—from the time of the Council of Vesālī to that of the Council of Patna (about 400–250 B.C.)—within which they are all said to have arisen.

All the lists agree, however, in one point of great historical importance. Each of them gives one particular school, 'the School of the Presbyters' or 'the School of Distinction' (*Thera-vādins*, *Vibhajja-vādins*), as the original from which each of the seventeen others was ultimately descended.⁵

We have information as to some of the doctrines of several of these schools in the *Kathā Vatthu* (3rd cent. B.C.) and its commentary (5th cent. A.D.).

¹ R. Mitra's ed., Calcutta, 1877, p. 83.

² See M. Winternitz, *Gesch. der ind. Litteratur*, II. (Leipzig, 1913) 199.

³ *J.A.*, 1859, p. 327 ff.

⁴ See W. Geiger, *Mahāvamsa* (tr. PTS, 1912, p. 277). He has made a comparative table of all the lists.

⁵ R. Pischel (*Leben und Lehre des Buddha*, Leipzig, 1910, p. 6) expresses this by saying: 'The Pāli canon is only the canon of one sect.' This is inaccurate in several ways. It implies that there were sects (like European sects); that each had a separate canon; and that each canon stood on a level in respect of age. Not one of these implications is supported by the evidence.

This has been specified, and discussed, together with other information, in two articles by the present writer.¹ The conclusions reached are:

(1) The data are not sufficient to enable us to give a complete description of the doctrines, or even of the innovations, current in any one particular school.

(2) The principal innovations discussed in the *Kathā Vatthu* relate, not to ethics or philosophy, but to Buddhism.

(3) Both the commentator and Fa-Hian, writing in the 5th cent. A.D., are agreed in granting only to three or four of these schools any considerable importance.

(4) Yuan Chwāng, writing at the end of the 7th cent. A.D., attaches importance to the same schools only. It is very doubtful whether any of the others had had, at any time, either large numbers or much influence.

(5) The figures given us by Yuan Chwāng—he stayed many years in India, travelled extensively, and usually recorded, where he stopped, the approximate number of members of the Order, and the school they adhered to—reveal the astounding fact that even as late as the end of our 7th cent., that is, the 13th cent. of Buddhism, no fewer than two-thirds of the 200,000 *bhikkhus* in India and its confines still adhered to one or other of the primitive schools. The allurements of the myriads of resplendent deities created by the Mahāyānist theologians, and that of the new ethics based on belief in those deities, had equally failed to attract them.

(6) These schools have been, and are still, often called 'sects.' This is a mistake. They had no separate hierarchies, presbyteries, or other forms of church government; no separate dress, churches, or services. They were more like the Low, Broad, and High Churchmen among the Episcopal clergy. And, as in the Anglican Church, each individual combined the various tendencies in varying degrees. This may explain how the same people are classed under the names of different schools. Thus, the *bhikkhus* in Ceylon called themselves *Thera-vādins*; Fa-Hian, who stayed two years in the island, apparently thinks (Legge p. 111) that they were Mahāsāsakas; Yuan Chwāng (Watters, *On Yuan Chwang's Travels*, London, 1904–05, ii. 234) calls them Mahāyānist Sthaviras.

(7) From what has been stated above as to the many lists of the 18 schools it seems clear that the number 18 is purely conventional—a round number. Were we to make a new list, including all the names found either in the old lists or in inscriptions (such, for example, as those mentioned in *JRAS*, 1891, p. 410; 1892, p. 597), we should have 28 or 30. That none of the names appears in the earliest inscriptions would seem to show that not much weight was attached to them in the earliest times. When the schools are mentioned, the name of each is given separately. A Hinayāna school as designating a body of men is never referred to. So with the Mahāyāna. There are a score or more of schools that must be included under that name. Some of them to-day in Japan have become sects with separate revenues, government, dress, doctrines, and services. To compare Hinayāna with Mahāyāna it is necessary, if one would serve any useful historical purpose, to compare the whole of the one with the whole of the other. The position will best be understood in the West if it be pointed out that the Mahāyāna schools bear a relation to the Hinayāna schools similar to the relation borne by the various Roman and Greek Catholic schools to the early Christian ones. This similarity is due to similar causes (one of which was mentioned above). But there are also remarkable and interesting differences. The most noteworthy of these is that the early forms of thought subsisted

¹ *JRAS*, 1891, 1892.

in India through so many centuries, while in Europe they were allowed to persist, if they persisted at all, only underground. When toleration was the rule in India, the Inquisition was busy in Europe.

Those schools, apart from the original school of the Theravādins, which would seem, from our late and scanty evidence, to have been of some importance, are the following:—

(i.) *Sammitiya*.—Yuan Chwāng estimates their numbers in the 7th cent. as about 43,000 *bhikkhus*, of whom about half were in Sind, and the rest scattered through the Ganges valley or in Avanti. They are referred to nineteen times in the commentary on the *Kathā Vatthu*.

(ii.) The *Sabbatthivādins* (Realists).—In the 7th cent. they were in the territories beyond the extreme N.W. frontier of India, and Yuan Chwāng reckons their number there at about 12,000. Fa-Hian does not mention them, and Buddhaghōṣa (*q.v.*) refers to them only three times. But Takakusu, in his important article in the *JPTS* for 1905, has shown how very great was the influence of this school of thought at the court of Kanīśka, and afterwards; and has given a summary of the contents of seven of their works. Probably Aśvaghōṣa (*q.v.*), the celebrated court-poet and dramatist in Kanīśka's time, was a Realist. The *Lalita Vistara* is believed to be founded on the text of an older biography of the Buddha current in this school; and about half of the legends in the collection called *Divyāvadāna* are also thought to have been taken over from a work on Canon Law used by the Realists.¹

(iii.) *Andhaka* (Andhras).—Buddhaghōṣa, in his commentary on the *Kathā Vatthu*, attaches more importance to these, the inhabitants of the S.E., than to all the other schools put together. But they are mentioned nowhere else, and we do not know even the titles of any of their books.

(iv.) *Mahā-sāṅghika*.—They are mentioned by Buddhaghōṣa sixteen times, and a branch of them, the Lokottara-vādins, was found still existing in the 7th cent. by Yuan Chwāng in Bamiyan. They are particularly interesting as being the original authors of the collection of legends called the *Mahāvastu*, where we find the germ of the docetic theories, dealt with under DOCETISM (Buddhist).

A good deal of the literature of these, and of the other schools of early Buddhism, is still extant in Chinese translations. It is not likely that, in the fine collection of translations of Buddhist Sanskrit works into Tibetan, made from the 9th cent. onwards, there will be anything left of the works of these older schools. In the Buddhist Sanskrit MSS in our libraries there are, however, many books, whose titles we know, that will undoubtedly throw much light on the interesting and important historical problem of the gradual growth and change of early Buddhist thought and doctrine. The publication of these works is the greatest desideratum in the present state of our knowledge. The beginning we know well. The Pāli Text Society has now (1913) published 73 volumes of the works, early and late, of the original school, the Theravādins. We know a good deal about the end—the final shapes taken by the various schools of later Buddhism still existing in China, Tibet, and Japan. For the intervening periods very little, apart from story-books and collections of edifying tales, has as yet been made available for European scholars. It will be sufficiently evident from the above why it is that no attempt has yet been made in Europe to elucidate the history of these schools, or to trace the development of their doctrine.

LITERATURE.—The authorities have been given in the article.
T. W. RHYS DAVIDS.

¹ Winternitz, *op. cit.* pp. 198, 222.

HINDUISM.—I. Definition.—‘Hinduism’ is the title applied to that form of religion which prevails among the vast majority of the present population of the Indian Empire. Brāhmanism (*q.v.*), which is the term generally used to designate the higher and more philosophical form of modern Hinduism, is more properly restricted to that development of the faith which, under Brāhman influence, succeeded to Vedism, or the animistic worship of the greater powers of Nature.

The name ‘Hindu’ carries us back to the period of the invasion of the Peninsula by the Aryan tribes from the N. or N.W. The word *Sindhu* was applied by them to the great river of the west, the modern Indus; and, though in Vedic literature *sindhu* was used as an appellative noun for ‘river’ in general, throughout Indian history it remained the name of its powerful guardian river, the Indus. A common term for the ancient Aryan settlements in the Panjāb was ‘the Seven Rivers’ (*sapta sindhavaḥ*). The name ‘Hindu’ appears in the form *Hi^{ndu}* in the inscription on the monument of Darius Hystaspes near Persepolis (c. 486 B.C.); *Hōd(d)ū* in the later Heb. literature (Est 1¹⁸); and in its modern form (c. 440 B.C.) in Herodotus (iii. 98). The question of the so-called ‘Aryan invasion’ of N. India has been re-opened, from the Dravidian standpoint, by P. T. Srinivas Iyengar (*Journal Royal Society of Arts*, ix. [1912] 841 ff.), who opposes Risley's theory of a complete occupation of the Panjāb by Aryan tribes accompanied by their women, and a subsequent interruption of communication with Central Asia, which ensured the purity of the race in that province. He asserts that the ‘only certain difference between the Arya and the Dasyu . . . is one of cult,’ that is, of fire-rites. ‘The language and the cult of the Aryas were borrowed from without, and profoundly altered on Indian soil. If this cultural drift had been accompanied by any appreciable racial drift, if the cult and language had been brought into India by any considerable body of foreigners, who formed a race by themselves, and lived apart from the native races, neither the cult nor the language would have undergone such serious alterations as they have, but would have remained relatively pure. Hence we may conclude, with a fair degree of certainty, that in the second millennium B.C. a foreign tongue and a foreign cult drifted into India, and were adopted by certain tribes, later called Aryas, among whom the cult and the speech developed in new ways, and distinguished the tribes that possessed them from the other tribes of this country.’

a. **Statistics.**—According to the Census of 1901, the total population of the Indian Empire was 294,361,056, of whom 207,147,028 (70·3 per cent) declared themselves to be Hindus. Of these the vast majority (207,050,557) professed to follow the Brāhmanical or orthodox form of the faith, the small minority belonging to the modern theistic sects, such as the Brāhma and Arya Samājes. If to the body of declared Hindus be added Sikhs (2,195,339) and Jains (1,334,148), both of whom claim to be Hindus, the total adherents of Hinduism amount to 210,678,513. If the estimates of H. Zeller be accepted, Hinduism thus stands numerically third among the religions of the world, being exceeded only by Christians (534,940,000) and followers of Confucius (300,000,000).

The distribution of Hindus throughout the Empire varies greatly. The most Hindu province is Orissa, in Bengal, where 94·7 per cent of the total population follow this faith. In succession to this follow Mysore (92·0 per cent); Madras (89·1); Bombay, excluding Sind and Gujarāt (88·9); Hyderabad or the Dominions of the Nizām (86·6); the United Provinces of Agra and Oudh (85·4); the Central Provinces (82·7); Central India (80·9); Baroda (79·2); Bombay, the whole Presidency (78·5); Travancore (68·9); Bengal, the whole Presidency (63·3). The least Hindu portions of the Empire are the N.W. Frontier Province with the Panjāb (35·6), Sind (23·4), and Burma (4·3); in the first two Hinduism having given way to Islām, in the third to Buddhism. In Eastern Bengal the percentage of Hindus has been reduced by the notable extension of Muhammadanism, and in Travancore of Christianity.

Hinduism is thus strongest in the more isolated portions of the Peninsula—Orissa, Mysore, Madras, and the Deccan or central plateau—where the influence of foreign religions has been weakest; in regions like the Panjāb, the Frontier Province, and Sind, Islām has been dominant; in Eastern Bengal in later times it has grown at the expense of Hinduism. The accuracy of these statistics is, however, seriously impaired by the difficulty of dealing with the beliefs of the non-Aryan or so-called ‘Dravidian’ population. The well-organized forest tribes, who in 1901 numbered 8,584,149 (2·9 per cent of the total population), were generally classed as Animists. But besides these there are vast masses of people drawn from the lower strata of the population throughout the Empire whose connexion with orthodox Hinduism is hardly more than nominal.

Besides the Hindus settled within the Empire, some adherents of the faith are found beyond its

limits. Early traditions in W. India tell of fleets from the coasts of Sind and Gujarāt conveying emigrants to Cambodia and Java, and Ptolemy's map of the Indo-Chinese coast contains Skr. names, indicating the existence of Hindu settlements as early as the 1st cent. A.D. In Cambodia the remains at Angkor, Nakhon Wat, Borobūdūr, and other places are of Indian origin in their details. In Java, as in Sumatra, the early ascendancy of the Hindus is supported by tradition, and there was certainly a period of Buddhism, and then a period of aggressive Saivism, followed by an age of apparent compromise between the rival faiths. Hinduism finally gave way to Islām, and has been extinct for more than four centuries (see *ERE* ii. 239; *EBr*¹¹ xv. 288 f., 292, xxvi. 74). But in Bali, or Little Java, it still holds its ground in a corrupted form, sanctioning the custom of widow-burning (*satī*) and the traditional fourfold Hindu caste system. It is now largely blended with the baser forms of Buddhism and the animistic cultus of evil spirits (*kāla*). For Hindu emigration to the Far East, see V. A. Smith, *Hist. of Fine Art in India and Ceylon*, Oxford, 1911, p. 259 ff. In the early centuries of the Christian era, Hindu literature, art, and religion penetrated extensively into Khotan and all Chinese Turkistān up to the frontier of China Proper. The discussion of the influence of Hindu belief on the religions of the West is beyond the scope of this article; but Flinders Petrie has discovered portraits at Memphis of an Aryan woman from the Panjāb and a seated Hindu figure.

¹These are the first remains of Indians known on the Mediterranean. Hitherto there have been no material evidences for that connection, which is stated to have existed, both by embassies from Egypt and Syria to India, and by the great Buddhist mission sent by Asoka as far west as Greece and Cyrene. We seem now to have touched the Indian colony in Memphis, and we may hope for more light on that connection which seems to have been so momentous for Western thought' (W. M. Flinders Petrie, *Man*, viii. [1903] 129; cf. V. A. Smith, *Asoka*², Oxford, 1909, p. 43).

Within recent times Hindu emigrants to S. and E. Africa and various ports and trading centres in other parts of the world have, in spite of the Brāhmanical prohibition of ocean travel, carried with them their religion and some of their social institutions.

3. Materials for the study of Hinduism.—The subject of Hinduism, in many of its varied phases, is considered in several articles in this work—those describing the great provinces of the Empire; those tracing the development of the faith as illustrated by Aryan Religion, Vedic Religion, Brāhmanism, etc.; those dealing with the greater gods, religious sects, and sacred places. The purpose of this article is to discuss, in a general way, the progressive evolution of Hinduism, and to group the facts, as far as is possible, in their historical setting. It must be remembered, however, that the materials for such a survey are in many directions incomplete and fragmentary. In the first place, the Hindu religious records are of much later date than those of Babylonia or Egypt. In Babylonia inscriptions from Nippur earlier than the third millennium before our era are available (*HDB* v. 532; for various other estimates, see *EBr*¹¹ iii. 108 ff.); the oldest Egyptian dynasty of which remains have been discovered goes back, according to Flinders Petrie, to 4777 B.C., or, in a later estimate, to 5510 (*EBr*¹¹ ix. 69). The accounts of the origin of Hinduism start with the Vedic age, which is believed to date from about 1500 B.C. Secondly, while the hymns of the Veda embody the naive speculations of the early Indo-Aryans on the character and functions of their gods, the writings of the later Brāhmana period were compiled by the priestly class to support its claims to the leadership of the Aryan community. A comparison of these writings with those of the Buddhists and

Jains, so far as they have been examined, leads to the conclusion that this Brāhmana literature does not accurately represent the early development of Hinduism (Rhys Davids, *Buddhist India*, 1903, p. 149 ff.). The historical side, again, of this literature is vague and incomplete. These ancient religious teachers had little of the historical sense, and were not concerned to compile a systematic account of political events or of the phases of social progress. The inference which they desired to suggest was that Brāhmanical Hinduism dates from the most ancient period; that Brāhmins have always been the political, religious, and social guides of the community; that the orderly progress of religious development was never interrupted by any violent cataclysm. The literature prepared by them contains no adequate account of the rise, progress, and decay of Buddhism and Jainism; and in a great measure it ignores the successive invasions of N. India by Greeks, Parthians, Scythians, and Huns, of which the two last races profoundly influenced the religious and social life of the Hindus. To this must be added that lack of historical insight and national patriotism which the Hindus share with other oriental races. The priestly record of the early Hindu period cannot, to any large extent, be supplemented from independent sources. The true historical period does not begin before the 7th cent. B.C., and

²'up to about that time the inhabitants of India, even the most intellectual races, seem to have been generally ignorant of the art of writing, and to have been obliged to trust to highly trained memory for the transmission of knowledge' (V. A. Smith, *Early Hist.*², Oxford, 1908, p. 24 f.).

No extant inscription can be assigned to a date earlier than that of Asoka (*q.v.*), the middle of the 3rd cent. B.C., while numismatic evidence begins to be of value only from the time of the invasion of Alexander (*ib.* 13 ff.). The architectural remains of the earlier period which have survived are Buddhist or Jain, not Brāhmanical; and the art and style are, for the most part, independent of religion. We possess no historical records and no sacred literature of the non-Aryan races of S. India, until they came into contact with the Hindus of the North. That of the Tamils is said to date only from about 100 B.C. (V. Kankasabhai, *The Tamils: Eighteen Hundred Years Ago*, 1904, p. 2 f.).

4. Vedic Animism.—The Vedic religion will be discussed in a separate article. Here it is only necessary to point out that the methods employed by the school of mythologists represented in Great Britain by F. Max Müller, who evolve a complex divine personality from a single physical concept, such as the wind or dawn, are now generally discredited in the study of Indian as in that of Hellenic myths (Farnell, *CGS*, Oxford, 1896–1909, v. 9 n.). The identification of the titles of the Vedic gods in languages akin to the Skr. has been widely contested and found to be in a great measure unfruitful; and attention at present is more generally concentrated on the comparison of cults rather than of divine titles.

The priests and higher classes of the Indo-Aryan community, whose beliefs are represented in the Vedic hymns, had raised to the rank of gods the greater spirits which control the chief energies of Nature; but the lesser spirits, which were dreaded and propitiated by the mass of the people, were to a large extent ignored in the religious literature. The latter and lower form of Animism, though it has been denied that it formed 'anything like a complete background to Vedic mythology,' can be traced in the Veda (F. Max Müller, *Contrib. to the Science of Mythology*, 1897, i. 211).

³Everything that impressed the soul with awe or was regarded as capable of exercising a good or evil influence on man, might in the Vedic age still become a direct object not only of adoration but of prayer. Heaven, earth, mountains, rivers, plants might be supplicated as divine powers; the horse, the cow, the bird

of omen, and other animals might be invoked; even objects fashioned by the hand of man, weapons, the war-car, the drum, the plough, as well as ritual implements, such as the pressing-stone and the sacrificial post, might be adored' (A. A. Macdonell, *Vedic Mythology*, pp. 2, 86 f., 147 ff.).

Again, many myths (though an attempt has been made by Max Müller [*op. cit.* ii. 429, 532, 573] to derive them from physical concepts) are of the type common to all primitive races. The tales of Indra overcome with drink, and committing adultery with Asura women; of the incest of Prajapati; of the creation of all things out of the severed limbs of a magnified non-natural man, Puruṣa, are all common to savage folk-lore, and 'in the religions of even the lowest races, such myths . . . are in contradiction with the ethical elements of the faith' (A. Lang, *Myth, Ritual, and Religion*, London, 1899, i. 9 f.). The practice of magical rites also forms a link between the Aryan and the purely savage culture. It is true that magic, in its crudest form, does not appear in the original Veda; but the belief in the power of formulæ (*mantra*: see CHARMES AND AMULETS [Indian]); the practice of sympathetic or mimetic magic, such as the use of figures which are wounded to destroy an enemy; magical practices connected with marriage, initiation, the anointing of the king; the use of homœopathic magic for the cure of baldness or jaundice, are all similar to those current among savages at the present day (H. Oldenberg, *Die Religion des Veda*, Berlin, 1894, pp. 508, 59, 477, 420 f., 507; M. Bloomfield, *Atharvaveda* [SBE xlii. [1897] 7 f., 263 f.]). Ideas of this kind are most largely found in the Atharvaveda, which was compiled from very ancient materials after the Aryans had penetrated some distance down the valley of the Ganges (Bloomfield, *op. cit.* Introd. xl, xlv). The fact that such beliefs were common to Aryans and non-Aryans naturally facilitated that contamination of the earlier and purer theology which developed first into Brāhmanism, and at a later date into Hinduism.

5. Foreign influence in Aryan culture and belief.

—The view is now gaining ground that the Indo-Aryans were not unaffected by foreign influences.

(a) Some authorities recognize a stratum of Babylonian culture. If about 1400 B.C. the hegemony of Babylon had been established in W. Asia, it is not unreasonable to suppose that its influence may have extended to India. The great trade routes through Persia and Turkistān must have been controlled by the rulers of the Euphrates-Tigris valley; ruins of terraced fields and irrigation channels in Baluchistān prove that in ancient times it must have been a most fertile land, through which communication between the Euphrates-Tigris and Indus valleys could have been maintained. As early at least as the 7th or 8th cent. B.C. sea commerce was carried on between the non-Aryans of S. and W. India and Babylon; and by this route the pre-Semitic alphabet, which is the basis of the Indian scripts, reached India (J. Kennedy, *JRAS*, 1898, p. 241 ff.; Smith, *Early Hist.*², 25 n.; Sayce, *Origin and Growth of Religion* [HL, 1887], London, 1891, p. 137 f.). Various lines of coincidence between the Babylonian and early Hindu culture have been traced: the resemblance of Babylonian charms against disease, evil spirits, and other invocations to those of the Atharvaveda (M. Jastrow, *Rel. of Bab. and Assyr.*, Boston, 1898, p. 253 ff.); the belief in sorcery, witchcraft, omens, lucky and unlucky days (*ib.* 266, 328 ff., 380; Sayce, 150, 327); the custom at Taxila of selling maidens who failed to secure husbands, which was in force at Babylon (Herod. i. 196); the habit of burying in terra-cotta coffins, found in S. India, which closely resemble those of Babylonia (*IA* v. 255; Jastrow, 597 f.). It has also been suggested that India owes to Babylonia

the introduction of brick masonry (*IGI* ii. 103), the adoption of the seven-days week, and of the system of the twenty-four or twenty-seven lunar mansions (*nakṣatra*) (A. Weber, *Hist. of Indian Lit.*, 1878, p. 246 ff.). On the other hand, Max Müller (*India, What can it teach us?*, 1883, p. 125 ff.) strenuously denies that the Vedas show traces of Babylonian influence, and M. Haug (*Aitareya Brāhmaṇa*, 1863, i. 46) suggests that the early astronomical observations of the Hindus must have been made in N. India. In any case, the lunar mansions were a late introduction in Babylonia, and, if the Hindus borrowed them, it was probably later than the 7th cent. B.C. (J. Kennedy, 261, 269; cf., further, F. K. Ginzel, *Handb. der mathemat. und techn. Chronologie*, Leipzig, 1906 ff., i. 74–77). A recent discussion of the influence of Babylon on the religion of Greece shows that 'so far as our knowledge goes at present, there is no reason for believing that nascent Hellenism, wherever else arose the streams that nourished its spiritual life, was fertilised by the deep springs of Babylonian religion or theosophy' (L. R. Farnell, *Greece and Babylon*, Edinburgh, 1911, p. 307). Further investigation may show that these conclusions apply to the relations of Babylonia with India. On the whole, the influence of Babylonian on Hindu culture seems to have been comparatively late, and the results of the intercourse of the two races have been so thoroughly assimilated that they are no longer visible on Indian soil.

In the case of religion and myth, the primitive elements having become worn down or absorbed, it is difficult to trace the connexion between the two cultures. If the goddess Nānā Devī worshipped at Hinglāj (*q.v.*) be identical with the Babylonian Nana of Erech, we may suppose that the cults of the Mother-goddesses of east and west may here have been combined; her name, in the form Nano, appears on the coins of the Kuṣān king Huviṣka, who ascended the throne about A.D. 150 (*JRAS*, 1908, p. 60; Smith, *Early Hist.*², 252 f.; cf. J. G. Frazer, *GB*², pt. i. *The Magic Art and the Evolution of Kings*, London, 1911, i. 37 n.; T. Holdich, *The Gates of India*, do. 1910, p. 162 f.). An echo of the Babel legend has been traced in the Brāhmaṇas, where the demons pile up a great fire-altar by which they hope to scale the sky; when they have climbed some distance, Indra pulls out a brick; they fall to earth, and all but two, who fly away and become the dogs of Yama, are turned into spiders (Bloomfield, *SBE* xlii. 500). The conception of the upper or heavenly sky appears in the Veda as well as in the Avesta and in the cosmogony of Babylonia. It has been urged that the coincidences between the Babylonian and the Hindu Flood-legend can hardly be accidental (*Atharvaveda*, xix. 39. 8; *Śatapatha Brāhmaṇa*, i. 8, l. 6; Jastrow, 518). But the Hindu Flood-story is comparatively late, and it has been suggested that its independence of the legends in the Avesta and the Bundahīs shows that it was not derived from Irān, but possibly, by Dravidian intermediaries, from Babylon, after the opening of communication by sea (J. Kennedy, *JRAS*, 1898, p. 260 f.; also see T. K. Cheyne, in *EB*¹¹ vii. 976 ff.; *EB* i. 1065 f.; F. H. Woods, *ERE* iv. 555 f.). It must also be remembered that such myths prevail in many parts of the world (E. B. Tylor, *Researches into the Early Hist. of Mankind*, London, 1865, p. 317 ff.); and that India has its own legends of the same kind, such as those prevalent among the Lepchas, Kor-kus, Mundas, Karens, and Andamanese, which are almost certainly independent of Aryan tradition. The question of Babylonian influence on India has been discussed by R. von Ihering (*Vorgesch. der Indo-Europäer*, Leipzig, 1894, Eng. tr. *The Evolution of the Aryan*, by A. Drucker, London, 1897),

whose conclusions must be accepted with caution. For the wide-spread influence of Babylonian culture, see L. W. King, *A Hist. of Sumer and Akkad*, London, 1910, Pref. p. vi f.

(b) Among the western kinsfolk of the Indo-Aryans their connexion with the Iranians, as is shown by their common knowledge of geography and its nomenclature, was particularly intimate. The affinity of the Avesta to the Rigveda in the domains of mythology and cult is remarkable; and the resemblance would certainly be greater if we possessed Avestan literature as old as the Vedic, the reforms of Zarathuštra having caused a very considerable displacement of mythological conceptions (Macdonell, *Vedic Myth.*, 7; Max Müller, *Selected Essays*, 1881, ii. 132 ff.; J. Muir, *Orig. Skr. Texts*, ii. [1860] 477 ff.). Risley (*Census Report India*, 1901, i. 548) suggests that the Brāhmanical theory of castes 'may be nothing more than a modified version of the division of society into four classes—priests, warriors, cultivators, and artisans—which appears in the sacerdotal literature of ancient Persia.' Haug (*Ait. Brāh.* i. 60) remarks that the Agnišoma rite, from its complete similarity to Iranian ceremonial, must be extremely ancient. It is certain that the great Medo-Persian Empire must have profoundly influenced N. and W. India; they certainly held the Indus valley and considerable parts of the S. Panjāb and Rājputāna (Strabo, xv. 10; *JASB*, 1892, p. 198; Malik Muhammad Dīn, *The Bahāwalpur State*, Lahore, 1908, p. 22 f.). At a later date, under the Greek successors of Alexander the Great, Iranian sun-worshippers entered India, and were adopted into the Brāhman ranks under the title of Sakadvīpiya, or 'those of the Scythian island.' To this intercourse with Irān may be attributed the extension of sun- and fire-worship in N. India; though, of course, it is possible that cults of this kind may have sprung up in India independently of foreign teaching. The traditions of W. India indicate a connexion of the rulers of Valabhi in Kāthiāwār with the Sasanian dynasty, and a similar story is told of one of the great Rājput houses (*Āin-i-Akbarī*, tr. Blochmann and Jarrett, Calcutta, 1873-94, iii. 338). The extent of the indebtedness of Indian art and architecture to that of Irān is disputed, and the origin of certain symbols, such as that of Garuḍa, the winged vehicle of Viṣṇu, is uncertain (Perrot-Chipiez, *Hist. of Art in Persia*, Eng. tr., London, 1892, pp. 5, 339 n.; A. Grünwedel, *Buddhist Art in India*, Eng. tr., do. 1901, pp. 16, 21, 48, 50, 56 f.; Fergusson-Burgess, *Cave Temples of India*, do. 1880, pp. 21, 34 f., 243, 307, 522 f.). The dominant influence of Persia on Indian art in the time of Aśoka is clearly established (V. A. Smith, *Hist. of Fine Art in India and Ceylon*, pp. 60, 377 f.). For the early relations between India and Persia, see the summary in *BG* ix. (1901) pt. ii. 183 ff.

(c) The Greek campaigns of Alexander the Great produced little effect upon the history, politics, or religion of India (Smith, *Early Hist.*², 110). A pillar inscription recently discovered at Besnagar, near Bhilsa in the Gwālīor State, records that it was set up in honour of Vāsudeva or Viṣṇu by Heliódorus, son of Dion, a devotee of Bhagavata, who came from Taxila in the reign of Antalkidas of the Græco-Bactrian dynasty (c. 150 B.C.). It is uncertain whether Heliódorus accepted Vāsudeva as an Indian god or identified him with Herakles or some other Greek deity; in other words, whether he was a Hinduized foreigner or had remained a Greek and was merely anxious to profess conformity with an Indian cult. In any case, it throws new and interesting light on the relations between Greeks and Hindus (Smith, *Early Hist.*², 65 f.).

6. The religious isolation of India.—But, even

if it be admitted that in certain regions and in certain departments of religion or art the influence of foreign races on India may be detected (see Smith, *Early Hist.*², 377), the fact remains that the beliefs and cultus of the Hindus are, in the main, of indigenous origin, and that they developed on national lines of evolution. The Peninsula on east and west is bounded by an ocean, which in the early period was not open to the navies of the world. To the north and west India was cut off from the neighbouring Asiatic kingdoms by a gigantic mountain barrier, a great river, wide tracts of desert, and a borderland held by savage tribes. This isolation of the country promoted that confidence in, and respect for, their national religion and customs which are inherent in the Hindu mind. 'The Hindus,' said al-Bīrūnī, 'believe that there is no country but theirs, no nation like theirs, no kings like theirs, no religion like theirs, no science like theirs' (*India*, tr. Sachau, London, 1888, i. 22). In short, the leading characteristics of Hinduism are the result of its environment. Its pessimism results from a depressing climate, where the population is successively exposed to malaria, tropical heat, and torrential rain. Hence, naturally, as was the case in Babylonia, the evil spirits which bring famine, disease, and other calamities are objects of propitiation, while those of a benignant nature are often neglected. The molecular character of Hinduism is due to the varieties of race and culture in the population, the localization of its deities resulting from the worship of the guardian spirits of the isolated communities which formed their settlements in its jungles.

'The Indians are the only division of the Indo-European family which has created a great national religion—Brahmanism—and a great world-religion—Buddhism; while all the rest, far from displaying originality in this sphere, have long since adopted a foreign faith. . . . In spite of successive waves of invasion and conquest by Persians, Greeks, Scythians, Muhammadans, the national development of the life and literature of the Indo-Aryan race remained practically unchecked and unmodified from without down to the era of British occupation. No other branch of the Indo-European stock has experienced an isolated evolution like this. No other country except China can trace back its language and literature, its religious beliefs and rites, its domestic and social customs, through an uninterupted development of more than three thousand years' (A. A. Macdonell, *Hist. of Skr. Literature*, London, 1900, p. 71.).

7. Pre-animistic and animistic beliefs.—The religion of the Vedic period was a form of that higher Animism found among other savage and semi-savage races. It has been recently suggested that this type of Animism is not the most primitive form of belief; in other words, that Animism, as we find it in ancient and modern India, does not account for what some recent authorities are disposed to regard as distinct phases in the religious consciousness—the belief in the spirit world and the recognition of a God. It is urged that Animism, in the sense in which it is recognized by E. B. Tylor and his school,

'explains only the dead material of religion, viz., that material which concerns the human, the natural, the world of the dead, of animated nature, ancestor-worship, and so on; that is, all that lies on this side of the gulf. What lies on the other side, the truly supernatural, cannot originate in Animism, and Animism does not explain it. The idea of God is derived from Nature worship, at the back of which lies Mana; and this is not contradicted by the recognition of possible links between souls and gods, or between magic and prayer.' The facts 'seem to point uniformly to decaying phases of monotheistic belief—belief in a power to which, or to whom, evil of any kind is displeasing—as existing among widely separated savage races whose religion is now admittedly animistic' (*Athenæum*, 5th June 1909).

This *mana* among the Melanesians is defined by R. H. Codrington (*The Melanesians*, Oxford, 1891, p. 118) as the supernatural power or influence which operates to effect everything which is beyond the ordinary power of men, outside the common processes of Nature; and it is equivalent to the Algonquin *manitou*, the *oki* or *orenda* of the Iroquois (see E. S. Hartland, *British Associa-*

tion Report, Dublin, 1908, London, 1909, p. 5; E. Clodd, 'Pre-Animistic Stages in Religion,' *Fortnightly Rev.*, June 1909, p. 1130 ff.). The monotheism of the peasant is discussed in § 39 below.

Beliefs of this kind have been traced by Riskey in India.

'If one must state the case in positive terms, I should say that the idea which lies at the root of their [the jungle peoples'] religion is that of power, or rather of many powers. What the Animist worships and seeks by all means to influence and conciliate is the shifting and shadowy company of unknown powers or influences making for evil rather than for good, which resides in the primeval forest, in the crumbling hills, in the rushing river, in the spreading tree, which gives its spring to the tiger, its venom to the snake, which generates jungle fever, and walks abroad in the terrible guise of cholera, small-pox, or murrain. Closer than this he does not seek to define the object to which he offers his victim, or whose symbol he daubs with vermilion at the appointed season. Some sort of power is there, and that is enough for him. Whether it is associated with a spirit or an ancestral ghost, whether it proceeds from the mysterious thing itself, whether it is one power or many, he does not stop to enquire. . . . When the era of anthropomorphism sets in and personal gods come into fashion, the active and passive powers of the earlier system are clothed in appropriate attributes. The former become departmental spirits or gods, with shrines and temples of their own and incessant offerings from apprehensive votaries. The latter receive sparing and infrequent worship, but are recognised, *en revanche*, as beings of a higher type, fathers and well-wishers of mankind, patrons of primitive ethics, makers of things who have done their work and earned their repose. The Santal Marang Buru represents the one; the Bongas or godlings of disease are examples of the other' (*Census Report India*, 1901, i. 352 f.; cf. R. R. Marett, *The Threshold of Religion*, London, 1909, p. 13 ff.).

There is nothing antecedently improbable in the theory that the belief in one Supreme God may have prevailed in India from a very early period, even before the rise of Vedic polytheism, because it is not confined to races in a high stage of culture, and is not infrequently found among primitive peoples (A. Lang, *The Making of Religion*, London, 1898, ch. ix. ff.). If pre-animistic beliefs assumed the form to which Riskey has called attention, it would go some way to account for the 'higher gods of the lower races,' which have been recognized in various parts of the world. This conception has been traced in some of the later Vedic hymns, where the idea is expressed that the various deities are but different manifestations of a single Divine Being (Macdonell, *Vedic Myth.*, 16 f.). It is unnecessary to apply Max Müller's term 'Henotheism' to this form of belief, because it amounts to little more than the poetic exaggeration with which a singer magnifies the deity whom for the moment he is addressing. The germs of monotheism which have been traced in the cult of Varuna seem to have been exaggerated; but it appears to be clear that at the close of the Vedic period, and more particularly in that of the Brāhmanas, Prajāpati has come to be realized as the chief and father of the gods, existent from the beginning, a conception which in the Upaniṣads gives place to Brahma, the universal soul or the Absolute (E. W. Hopkins, *Rel. of India*, 1896, pp. 67, 172; Macdonell, *Vedic Myth.*, 118 ff.). The later development of monotheism has been illustrated by G. A. Grierson, in art. BHAKTI-MĀRGA, vol. ii. p. 539; 'The Monotheistic Religion of Ancient India,' *Proc. Oxford Congress of Religions*, 1908, ii. 44 ff.; L. J. Sedgwick, 'Bhakti,' in *JRASBo*, xxiii. (1911).

8. Contributions from Vedism to modern Hinduism.—As is often the case with the great gods of savage races, the deities of the Vedic period have become otiose, take little part in the control of earthly affairs, receive scanty worship, and, if recognized at all, occupy a much lower position than that assigned to them in the early literature.

(a) *Varuna*.—At present Varuna, the old god of the firmament, is only vaguely conceived as one of the minor gods of the weather. At high-caste weddings in the Deccan he is installed in a brass bowl filled with water; the father of the bride draws four lines with sandal paste on the outside

of the jar, and with extended hands prays to Varuna to bless the wedded pair (*BG* xviii. [1885] pt. i. p. 200). On the western sea-coast he is believed to reside in the sea, wells, and streams, and he is propitiated by sailors and others whose business is in the great waters (*ib.* ix. [1901] pt. i. p. 349). In N. India he is supposed to preside over the weather and the rivers, and when a boat is launched the boatman flings an offering into the stream in his name.

(b) *Indra*.—The worship of Indra still survives, but in an attenuated form (see art. BRĀHMANISM, vol. ii. p. 804). Even in the Epic period he had suffered some loss of dignity, and he is now generally conceived as lord of a paradise of delights to which he conveys the souls of warriors slain in battle. In Buddhist mythology, under the name of *Sakka*, the Pāli form of the Vedic *Śakra*, 'the mighty one,' he retains some measure of respect. In the older Buddhist Sūtras he is almost the only deity of a well-defined type; at a later period he is conceived as reigning in a heaven of his own, whence he occasionally descends to interfere in earthly affairs (H. Kern, *Manual of Indian Buddhism*, 1896, pp. 16, 33, 45; A. Grünwedel, *Buddh. Art in India*, Eng. tr., 1901, pp. 7, 38). Hence among the Buddhists of Nepāl the thunderbolt (*vajra*) of this god has become the favourite religious symbol. 'Buddhists regard this thunderbolt of Indra as the sacred symbol of their divine Master's victory over the king of the Hindu heavens, and they venerate it accordingly'; all classes of Newārs, Buddhist as well as Hindu, perform the annual festival (*Indra-jātra*) with processions, performances by masked dancers, and illuminations; figures of Indra with outstretched arms appear in all parts of the city of Kāthmāndu (*q.v.*), and are invoked in memory of the sainted dead; in some places the old Vedic rite of uplifting the standard (*dhvajotthāna*, *indrādhvaja*) is still performed in his honour (H. A. Oldfield, *Sketches from Nepāl*, London, 1880, ii. 119, 312 ff.; cf. art. ASSAM, vol. ii. p. 137). Among the Hindus of the plains, his heaven (*Svarga*), said to be situated on the peak of the sacred mountain, Meru, is most closely associated with him. There he watches the dances of the nymphs who form his court—a view of his character which naturally commends itself to erotic Hinduism. His culture extends even to the forest tribes, like the Bhils (*q.v.*). In Bengal the non-Aryan Koch venerate a local god under the title of *Hudum Deo*, who is identified with Indra, and rides on his elephant, Airāvata; and in Dinājpur he has suffered still further degradation, seeming 'to be androgynous, and is represented by two figures, male and female, made of clay or cowdung. When drought is feared, the women make offerings of curds, parched rice, and molasses, and dance round the images at night, performing many obscene rites and abusing Indra in the foulest language, in the hope of compelling him to send the much-needed rain' (*Census Report Bengal*, 1901, i. 190 f.). In other places in the same province, after worship is done to him, his image is flung into the river as a mimetic rain-charm, or with the object of purifying the deity, and fitting him to answer the prayers of his worshippers during the coming year (W. Ward, *The Hindoos*, 1817, ii. 32).

(c) *Agni*.—As Indra was the special god of the warriors, so Agni was closely connected with the Brāhmanas; and this devotion, with the intensified belief in the efficacy of the sacrifice, was fully developed in the Brāhmana period. This deity seems to have developed from the cult of the sacrificial fire; but his personification, like that of the Greek Hestia, was never sufficiently anthropomorphic to disguise his ritualistic origin (Farnell, *CGS* v. 358). Some Brāhmanas, known as

Agnihotra, still, in accordance with the sacred law (Manu, iii. 67, xi. 66), maintain the sacred fire, which is produced by means of friction with the fire-stick (*arani*). The sacred fire is also kept up at certain temples, such as those in Nepāl (Oldfield, ii. 242; D. Wright, *Hist. of Nepāl*, Cambridge, 1877, p. 35; Monier-Williams, *Brāhmanism and Hindūism*⁴, 1891, p. 363 ff.). At Juālamukhī (*q.v.*), in the Panjāb, the goddess Devī manifests herself in the jets of combustible gas which rise out of the earth near her shrine. Fire is also venerated as the agency by which the savour of the sacrifice reaches the gods; in the form of the *homa* it is an important part of the ordinary domestic ritual (see art. BRĀHMANISM, vol. ii. p. 803 f.).

(d) *Sun-worship*.—At the present day worship is performed in honour of Sūraj Nārāyan, the Sūrya of the Vedic period, also known under the titles of *Āditya* and *Savitṛ* (see *ERE* ii. 804 f.). All pious Hindus revere the rising sun, and he is invoked when the pilgrim bathes in sacred rivers, and at other domestic rites. But, like the Greek Helios, he is now regarded as a minor god rather than a great divinity, the most probable explanation of his loss of dignity being that his functions have been in a great measure transferred to Viṣṇu. As Farnell (*CGS* v. 420) remarks: "Earth," "hearth," "sun" were names of palpable objects, regarded indeed with some sense of mystery that is the emotional background of religion, but liable to be transformed by the healthy materialistic perception, and in any case too limited in respect of local position, movement, or function to satisfy the true Hellenic idea of godhead.' The sun being a visible god whose beneficence is obvious to all, the Hindu conceives that he has little need of images, and, though some temples, like those at Konārak in Orissa, Gayā in Bengal, and Ayodhya in the United Provinces, are dedicated to him, they are far less numerous than those of the sectarian gods; and his worship as a tribal deity is confined to tribes like the Kāthī of W. India, who are probably a branch of the Gurjaras, and comparatively late emigrants from Central Asia (J. Kennedy, *JRAS*, 1907, p. 987). The Saura sect, which was specially devoted to this form of worship, seems to have practically disappeared (H. H. Wilson, *Works*, London, 1861, i. 19). The cult of this deity which prevails among the non-Aryan tribes is probably not based on imitation of the practices of the Aryans.

(e) *Forgotten Vedic deities*.—This list of four gods—Varuṇa, Indra, Agni, and Sūrya—practically exhausts those cults of the Vedic gods which survive in modern times. Of Mitra, the sun-god, Uṣas, the dawn, the twin Aśvins, Vāyu-vāta, and the Maruts, Pūṣan, deity of roads and cattle, hardly even the names survive. Their places have been taken by a host of minor deities of tribe or village, or their cults have been appropriated by the sectarian gods. The cults of stars and sacred animals, mountains, rivers, and the like, which appear in the Veda have now assumed forms presenting only a faint analogy to the primitive tradition. One cult, well established in Vedic times, that of the Pitṛi, or sainted dead, continues perhaps more than any other to impress the imagination of the modern Hindu (see ANCESTOR-WORSHIP [Indian], vol. i. p. 450 ff.).

9. *Transition from Vedism to Brāhmanism*.—The leading note of the Vedic hymns is cheerfulness; the great gods are the benevolent patrons of their worshippers; they lead the Indo-Aryan in his struggles with the Dasyu, or dark indigenous races; the evils which assail men are the work of demons, against whom the kindly gods wage successful warfare. In the period which

follows, that of the Brāhmanas (c. 800–500 B.C.), the prevailing feeling is very different. Its pessimism is perhaps due to climatic environment, and to the general acceptance of the doctrine of metempsychosis. The atmosphere of this age is that of religiosity rather than religion—the quibbles and elaborate ceremonialism of professional priests, contrasted with the peaceful poetry and naive speculations of the Vedic singers on things Divine and human. It may be compared with the transition from the prophetic literature of the Hebrews into legalism, and its crystallization in the later Pharisaism. This change of feeling may be attributed partly to climatic, partly to political, conditions. The Indo-Aryans had by this time advanced some distance down the Ganges valley, where the climate is damper and more depressing than that of the Panjāb. They had apparently broken up into a number of petty States which waged warfare one against the other. They had also come into contact with the non-Aryans, by some called Dravidians, but more probably members of the Mon-Khmer family, who, according to recent investigations, do not seem to have entered the Panjāb in any considerable numbers. Against these Mon-Khmer or Dravidian tribes, known as Dasyu, 'destroyers of the good,' they waged constant war. The clash of these rival cultures formed the source from which modern Hinduism ultimately sprang.

It is a popular error, which vitiates all conclusions regarding the early history of the Hindus, to suppose that these indigenous tribes were all savage barbarians. Many of them were probably forest-dwelling tribes, like the Goṇḍas or Mūṇḍas, or nomadic hordes, like the modern Bediyās or Sānsiyas. Collectively they were known to the Indo-Aryans as 'those who do not maintain the sacred fire' (*anagnitṛa*), or 'flesh-eaters' (*kravyād*). Some of them seem to have attained a fairly high level of culture, even possessing, as the jealous Vedic singers admit, forts and cattle, and practising a rude form of husbandry (Muir, *Orig. Skr. Texts*, ii. 395 f., 399). Their religion, like that of their modern successors, was a form of Animism, and they had reached the belief in the existence of the soul after death. 'They adorn,' says an early text, 'the bodies of their dead with gifts, with raiment, with ornaments, imagining that thereby they shall attain the world to come' (Muir, ii. 369). In short, it seems probable that in material culture, as well as in religious belief, they were not far below the standard of the mass of the Indo-Aryans. The importance of this consideration lies in the fact that this uniformity of culture facilitated the union of these two rival stocks, and led to that amalgamation of the cultus of the conqueror and the conquered from which modern Hinduism was evolved.

10. *Contributions to modern Hinduism from the Brāhmaṇa period*.—The chief contributions from this period to Hinduism were: (a) a great system of religious philosophy known as the Vedānta; (b) the supremacy of the Brāhman; (c) the dogma of the efficacy of sacrifice; and (d) the doctrine of metempsychosis.

(a) *Vedāntic pantheism*, 'which is breathed by every Hindu from his earliest youth, and pervades in various forms the prayer even of the idolater, the speculations of the philosopher, and the proverbs of the beggar' (Max Müller, *India, What can it teach us?*, 249), and which has been traced in a hymn of the Rigveda (x. 90), is fully developed in the philosophical literature known as the Upaniṣads. It forms the subject of a special article (see VEDĀNTA, and *ERE* i. 47 f., 137 ff.). Its chief interest at the present time lies

in the fact that its revival is one of the most important movements in the Neo-Hinduism of our day (see § 35).

(b) *The supremacy of the Brāhman.*—The priest, who, in his most primitive form, is an exorcist or medicine-man, appears in Vedic times; but the priestly order does not seem at that period to have been organized into a profession, nor did its members claim to hold office by hereditary right, though transmission of magical powers from one generation to another may have been recognized. The household worship of the early Aryans, conducted by the head of the family, gave way to the intricacies of ritual, and thus led to the creation of the office of *purohita* (*præpositus*, 'he that is set before'), or family priest, whose claim to office mainly rested on his skill in magic (Bloomfield, *SBE* xlii., Introd. lxvii ff.). Haug, however, is inclined to date this office back to the period when Iranian and Hindu formed a single community (i. 67); and it seems clear that the hereditary magical power of the priestly class was recognized even before Vedic times (see *ERE* ii. 43^b). The supremacy of the Brāhmins was doubtless closely connected with the denial by the Indo-Aryans to the Dasyu of the right of *connubium*, which was one of the causes which contributed to the establishment of the caste system (Rhys Davids, *HL*, 1881, p. 22 f.). But it is not till the Brāhmaṇa period that Brāhman claims are fully developed. 'The gods,' says the *Aitareya Brāhmaṇa* (Haug, ii. 528 f.), 'do not eat the food offered by a king who has no house priest.' There are, we are told, two kinds of gods, the Devas and the Brāhmanas, the latter being 'deities among men.' At a later time Manu (xi. 85) lays down that 'by his origin alone a Brāhmaṇa is a deity even for the gods, and his teaching is authoritative for men, because the Veda is the foundation for that'; and, again (ix. 317), 'a Brāhmaṇa, be he ignorant or learned, is a great divinity, just as the fire, whether carried forth or not carried forth, is a great divinity.'

The Brāhman of the present day lays claim to the rights accorded to him in the early sacred books; and some of them, like the Nāgars of Gujarāt and the Nambūtiris of Malabar, surround themselves with rigid tabus of various kinds in order to ensure personal purity (A. K. Forbes, *Rās Mālā*, London, 1878, p. 554; J. A. Dubois, *Hindu Manners*², 1906, p. 178 ff.; F. Fawcett, *Bull. Madr. Mus.* iii. 33 ff.; *Census Report Cochin*, 1901, p. 136 ff.; L. K. Anantha Krishna Iyer, *Cochin Tribes and Castes*, ii. [1912] 169 ff.). Owing to its isolation and to the special environment of Orissa, the local Brāhmins, with their metropolis at Jāipur, possess more power and property than in almost any part of India (W. Hunter, *Orissa*, London, 1872, i. 265 ff.; *Ethnograph. Survey Central Prov.*, pt. v. [Allahabad, 1911] p. 28). But in the case of some of the southern Brāhmins this affectation of extreme personal purity is not deemed incompatible with the strange marriage law under which some of them, like the Nambūtiris, live in a recognized system of concubinage with women of the Nāyar caste.

The position of the Brāhman in S. India in relation to popular belief is specially interesting, as the respect paid to him depends partly on race, partly on history, and partly on environment. Thus, in the great delta of Tanjore in the S.E. part of the province,

'Brāhman influence is predominant in social and religious matters. In almost all non-Brāhman castes the services of a Brāhman *purohit* [family priest] are indispensable at weddings, funeral and other domestic ceremonies; and the rites observed on these occasions are tinged with Brahmanical observances to a degree which is unapproached elsewhere. Brahmanical Hinduism is here a living reality, and not the neglected cult, shouldered out by the worship of aboriginal godlings, demons

and devils, which it so often is in other districts. Almost every village has its temple dedicated to one of the orthodox gods, holy places are legion, and every important town possesses a *matham* [monastery, lodging-place for ascetics] where ascetics may find shelter, and in which are held discussions by the erudite on disputed questions of doctrine or ritual. Brāhmins versed in the sacred law are numerous in Tanjore; Vedic sacrifices are performed on the banks of its streams; Vedic chanting is performed in a manner rarely equalled; philosophical treatises are published in Sanskrit verse; and religious associations exist, the privilege of initiation into which is eagerly sought for, and the rules of which are followed earnestly, even to the extent of relinquishing the world' (F. R. Hemingway, *Gazetteer of Tanjore*, Madras, 1906, i. 67 f.). The explanation of this predominance of Brāhmanism probably lies in the influence of the great Chola kings, to whose religious fervour are due the fine temples numerous in the district (Smith, *Early Hist.*², 414 ff.).

In the adjoining District of Madura, however, the situation is different. Though Madura itself is a well-known centre of Brāhmanism, the religious sentiment of the people is Dravidian. The important temple-worship at the chief city creates the impression that the people must be devoted to the worship of the orthodox gods; but a closer examination shows that large areas are devoid of any important shrine dedicated to the members of the Brāhmanical pantheon, and the village people are given over to the worship of the lesser Dravidian godlings. The cult of Śiva is predominant. One reason why Brāhmins have been unable to impose their rites to any great extent upon the people is that large sections of the community do not regard it as necessary that their marriage or funeral rites should be attended by any professional priest (W. Francis, *Gazetteer of Madura*, Madras, 1906, i. 84).

Passing to the northern Districts of the Presidency, in Bellary on the N. slope of the Deccan plateau,

'the real worship of the people is paid to the shrines of Hanumān [the monkey god] and those of the village goddesses. The former abound, and there is a saying that there is no village without a cock or a Hanumān temple. The village goddesses are many. Besides the usual Māriamma and Durgamma [of whom the former presides over small-pox, while the latter is malignant], the water goddess Gangamma (see GANGES), and the numerous unnamed Uramma, or village mothers, there are several local Ammas [mothers] held in great repute . . . Brāhmā is worshipped in the form of four-faced images, sometimes without any tangible image, a fort well and one of the pillars in a temple being declared to be habitations of him' (W. Francis, *Gazetteer of Bellary*, Madras, 1904, p. 63 ff.).

In the Godāvāri District on the east coast, partially composed of a deltaic region, with tracts of hill country occupied by wild tribes,

'in addition to the orthodox gods, three other classes of deities are worshipped—village goddesses, essentially local in character; caste deities; family deities, namely the *virudu*, or soul of some dead bachelor of the family (*PR*² i. 230, 261), and the *perantam*, or spirit of some woman outlived by her husband, who have been accorded apotheosis because they appeared in a dream to some member of the family, and announced that they have been made immortal. The Telugu Brāhmins, though in Vedic learning and observance of caste customs not inferior to those in the southern districts, are less scrupulous in minor matters. They will, for instance, smoke and eat opium. They also perhaps have less influence in religious and social matters; the lower castes do not salute them so readily as in Tanjore, nor is there the same desire for their services in social and domestic ceremonies. They do not hold themselves aloof from non-Brāhman castes as in the south' (F. R. Hemingway, *Gazetteer of the Godāvāri District*, Madras, 1907, i. 47, 52 f.).

Of the Brāhmins of the Deccan, Shridhar V. Ketkar (*An Essay on Hinduism, its Formation and Future*, 1911, pp. 87 note, 80–83) writes:

'Marātha Brāhmins . . . regard themselves as the élite of mankind, not only because they are Brāhmins, but also because they believe themselves superior to all other Brāhmins in India. To them Gujrath Brāhmins [the Brāhmins of Gujarāt] are only a caste of water-carriers, and Telang Brāhmins [Tilanga or Carnatic Brāhmins] are a caste of cooks. They look upon Śārasvata Brāhmaṇas and the Brāhmaṇas of Northern India as degenerate because the latter are "fish-eaters." They again believe that all other Brāhmaṇas, like those of Northern India, are unable to pronounce Sanskrit speech correctly.' On account of their pretensions to political and scholarly wisdom the Marātha Brāhmins 'are far from popular, irrespective of the respect which they may inspire' (p. 87 f.). 'The Brāhmaṇas are still a power, but their power is extremely limited. All the power they have is that of advisers. They can tell what

is proper and what is improper. They can tell which actions and conduct have scriptural sanction, and which have not, but they cannot compel any other caste to do anything. They again have a power of conferring Vedic or Puranic sacraments, as they are the priests of the nation, but the possibilities of this power, and the good uses to which this power can be applied, are not yet fully realized by them' (p. 80). . . . 'The Peishwas are gone, and so is the power of the Shāstris and Pundits in Poona.' They 'still like to play their excommunication formalities. They often excommunicate persons, either those who have returned from England, or married a widow, or drank tea with Englishmen; but nobody pays attention to their excommunication excepting their own circle, which to-day has become very small and unimportant' (p. 83). —

The Brāhmins of N. India, doubtless as the result of a long period of foreign domination, are much less pretentious and exacting. The laxity of practice among those of Kāśmīr and Rājputāna is notorious; and, though the Kanaujiyas exercise extreme care in the matter of food, on the whole the priestly class, particularly in regions occupied by manlier races like the Jāt or Rājput, have lost much of the influence which they once possessed (J. Wilson, *Indian Caste*, Bombay, 1877, ii. 139, 145, 151; Ibbetson, *Punjab Ethnography*, 1883, p. 120). Many of them, like the Gayawāl of Gayā, the Prayāgwāl of Allahābād, the Chaubē of Mathurā, all of whom are pilgrim guides at these sacred places, bear an indifferent reputation. Among the ordinary village Brāhmins the theory of vicarious sacrifice has been so far extended that many of them exist only for the purpose of being fed at funeral and other feasts, and perform no priestly duties. The Brāhmin exorcist and astrologer still maintains much of his influence even among those classes which pretend to have assimilated the learning of the West, and particularly among women, who are specially devoted to the traditional domestic rites.

(c) *The efficacy of sacrifice.*—With the supremacy of the Brāhmin was combined the dogma of the efficacy of sacrifice. 'By sacrifices,' says the *Taittirīya Brāhmana*, 'the gods obtained heaven' (Monier-Williams, *Brāhminism and Hindūism*⁴, 23). According to other Vedas, should sacrifice cease for an instant to be offered, the gods would cease to send the rain, to bring back at the appointed time the dawn and sun, to ripen the harvest, because they would no longer incline to do so, and also, as is sometimes surmised, because they could no longer do so (Barth, *Rel. of India*, 1882, p. 36). There is not much evidence to support the belief that the Indo-Aryan sacrifices depended on the assimilation of the divine life through the eating of the totem animal—a view advocated in the Semitic sphere by W. R. Smith (*Rel. Sem.*² 385 ff.) and further extended by F. B. Jevons (*Introd. to History of Rel.*, London, 1896, p. 103 ff.). There is little trace of totemism in Vedic literature, and we find little proof that the Vedic Indians believed that the sacrifice meant the slaying of the god, or of the conception of the Semitic sacramental meal (Macdonell, *Vedic Myth.*, 153; A. B. Keith, *JRAS*, 1907, pp. 931, 939). It is also improbable that sacrifice in all its complicated details could have been developed from one only of a group of kindred ideas included in the general system of primitive worship. In India it would appear that

'the first aim of sacrifice was to present a simple thank-offering. The second aim was to nourish the gods with the essence of the offered food, and to strengthen them for their duty of maintaining the universe. The next idea was that of making these oblations the means of wresting boons from the invigorated and gratified deities, and so accomplishing some specific earthly object, such, for example, as the birth of a son. A still more ambitious object was that of employing sacrifice as an instrument for the attainment of superhuman powers and even exaltation to heaven' (Monier-Williams, 22).

It gradually became a mystic rite, which of itself gave supernatural power to the worshipper apart from the aid of the god; or it was simply mimetic, the offerer imitating the action which he

desired the god to perform; or it was intended to propitiate spirits or tutelary gods. It gradually became surrounded with that air of mystery which Hindu thought associates with things in themselves trivial, that 'making a parade of symbols which at bottom signify nothing, and of playing with enigmas which are not worth the trouble of trying to unriddle' (Barth, 29).

The great Vedic sacrifices, at which thousands of victims were immolated by hosts of priests—the rite lasting, it is said, in some cases three generations—have quite fallen into disuse; and the number of Brāhmins fully skilled in the elaborate ritual is now small. Human sacrifices, rare in Vedic times, and possibly adopted from the non-Aryan races, increased at a later period; and, though the *meriah* sacrifice of the Kandhs (*q.v.*) has long been suppressed, isolated examples of such practices are still occasionally reported (H. H. Wilson, *Works*, ii. 268 f.; W. Crooke, *Things Indian*, London, 1906, p. 262 ff.; Rājendralāla Mitra, *Indo-Aryans*, London and Calcutta, 1881, i. 111 f.). At the present day sacrifices are of two kinds—bloody and bloodless offerings. The former are usually made to the Mother-goddess in one of her many forms, especially in Bengal and Madras, and among the lower classes of the people rather than among the higher. Their object is to avert the anger of the goddess, to propitiate malignant spirits, or to remove disease or other calamity, or they are made in fulfilment of a vow. Sometimes a compromise is made, the animal being merely laid before the shrine, or its ear is pierced and its blood presented, after which it is released. Bloodless offerings consist of the fire-sacrifice (*homa*), in which butter is cast into the flame so that the sweet savour may reach the gods, or presentations are made of grain, fruit, flowers, or leaves of some sacred tree or plant, which are laid before, or laid upon, the image, and are sometimes accompanied by a water oblation. Śiva, except very rarely in the case of his Himālayan manifestation Paśupati, which was probably adopted from some non-Aryan cult, receives none but bloodless offerings; and this is, of course, the rule in the worship of Viṣṇu, the humanitarian Buddhist tradition being clearly traceable in his cultus. The intention of the modern worshipper is to propitiate the god; 'man needs things which the god possesses, such as rain, light, warmth, and health, while the god is hungry and seeks offerings from man; there is giving and receiving on both sides' (Barth, 35 f.).

(d) *Metempsychosis, palingenesis.*—The most important dogma which was admitted into the official creed during the Brāhmana period was that of the transmigration of the soul. It is not found in the Veda, which inculcates a belief in immortality, and that of a personal nature; but in the *Satapatha Brāhmana* (x. 4. 3) we are told that those who do not perform rites with due knowledge are born again after their decease, and repeatedly become the food of death. As E. S. Hartland points out (*Primitive Paternity*, London, 1909, i. 192 ff.), it was in origin not philosophical dogma, but rather a development of the savage belief in transformation. In many different parts of the world it seems to have been independently discovered (Tylor, *PC*, 1871, ii. 1 ff.); and by some authorities its adoption by the early Hindus is attributed to the non-Aryan tribes (Rhys Davids, *HL*, 82; Macdonell, *Hist. Skr. Lit.*, 387; A. E. Gough, *The Phil. of the Upanishads*, London, 1882, p. 24; G. Oppert, *Orig. Inhabitants*, Madras, 1893, p. 553). It appears, for instance, among the Kāchārīs and Rabhas of Assam (*Census Report*, 1912, i. 78). For the development of the doctrine in S. India under the influence of the monism of Saṅkarāchārya, see *Census Report Madras*, 1912, i.

49 f. When it was taken over by Buddhism, Gautama did not teach the doctrine of the transmigration of souls, for which there is no place in his system, but the transmigration of character; and he held that 'after the death of any being, whether human or not, there survived nothing at all but that being's *karma*, the result, that is, of its mental and bodily actions . . . not a single instance has been found in the older parts of the Pāli Pitakas of man being reborn as an animal' (Rhys Davids, *HL*, 92; cf. Waddell, *Buddhism of Tibet*, London, 1895, p. 100 ff.). It is particularly prominent in the Buddhist *jātakas*, or birth-stories, in which the Master describes events which occurred in a previous birth. Closely connected with this doctrine is that of *ahimsā*, the respect for animal life, which was accepted by Buddhism, more fully developed by Jainism, and is now observed by the Vaiṣṇava sectarians, who owe the inspiration largely to Buddhism. In opposition to Barth (p. 97), Hopkins (*Rel. of India*, 199 f.) denies that 'aversion to beast-sacrifice is due to the doctrine of *karma*, and re-birth in animal form. The *karma* notion begins to appear in the Brahmanas, but not in the *samsāra* shape of transmigration. It was surely not because the Hindu was afraid of eating his deceased grandmother that he first abstained from meat. For, long after the doctrine of *karma* and *samsāra* is established, animal sacrifices are not only permitted but enjoined; and the epic characters shoot deer and even eat cows.'

At the present day the dogma is widely accepted. In N. India most Hindus believe that wrong-doing is displeasing to Parameśvara, the great god, and that the wrong-doer must suffer for his acts, possibly in the present existence, but certainly in his future life or lives. It is, however, doubtful whether the future penalty is in any way connected with that to which the sinner is liable in the present life, because the operation of the law of *karma* is regarded as so certain that the specific condemnation by Parameśvara in each case is seldom required (*Census Report United Provinces*, 1901, i. 76). The same writer remarks that a fundamental difficulty in the way of the spread of Christianity results from a belief in transmigration, which is in direct conflict with the belief in a Divine atonement. H. A. Rose, again (*Census Report Panjāb*, 1901, i. 161 ff.), quotes, as a development of the transmigration theory, the belief that certain classes and castes possess powers of causing evil or curing disease which are believed to be supernatural and to pass from one generation to another. These powers are independent of worldly status, and a person who possesses them retains them even when he pursues a menial occupation, provided it be not so disgraceful as to involve ostracism by his brethren. This, however, is the recognition of the influence of heredity rather than of direct transmigration. Several birth customs in the Panjāb—burial of infants near the house door; offering of milk after the death of a child; the belief that, if jackals or dogs disinter the corpse and drag it towards the house or village, the child will return to its mother; the preservation of the clothing of dead infants—illustrate the same belief (*Census Report Panjāb*, 1912, i. 299). On the subject of metempsychosis, see A. Bertholet, *The Transmigration of Souls*, London, 1909.

11. The anti-Brāhmanical reaction.—While, during the period represented by the Brāhmana literature, the priestly body was engaged in elaborating the cultus, and the philosophers were engrossed in the study of the nature and destiny of the soul, the mass of the people was little affected by ritual or speculation, and the time was ripe for

change. Hence arose both Buddhism and Jainism, almost contemporaneous movements, due to the reaction against the claims of the Brāhmins to a monopoly of admission to the ascetic orders (see Hoernle, *JASB*, 1898, p. 39 ff.).

'When Buddhism arose, the accepted and general belief was that the souls of men had previously existed within the bodies of other men, or gods, or animals, or had animated material objects; and that when they left the bodies they now inhabited, they would enter upon a new life, of a like temporary nature, under one or other of these various individual forms—the particular form being determined by the goodness or evil of the acts done in the previous existence. Life, therefore, was held to be a never-ending chain, a never-ending struggle. For however high the conditions to which a soul had attained, it was liable, by an act of wickedness, or even of carelessness, to fall again into one or other of the miserable states. There was a hopelessness about this creed in direct contrast to the child-like fullness of hope, the strong desire for life, that is so clearly revealed in the Vedas' (Rhys Davids, *HL*, 17). It was the distinguishing characteristic of Buddhism that it swept away the whole of the animistic soul theory, 'which had hitherto dominated the minds of the superstitious and the thoughtful alike. For the first time in the history of the world it proclaimed a salvation which each man could gain for himself, in this world, during this life, without the least reference to God, or to gods, either great or small' (ib. 29).

The main distinction between Jainism and Buddhism lay in the fact that the former specialized and intensified the earlier ascetic discipline, and prescribed reverence for life, not only human, but immanent in animals, plants, fire, earth, water, and wind; while Buddhism advocated asceticism in a milder form, and found salvation for its members in knowledge and right living.

It has often been suggested that this movement was part of a wide-spread religious and social revival.

'The sixth century B.C. is one of those epochs in the history of our race which mark a widespread access of spiritual vitality. In the case of Hellas it is still a moot question how far some fresh impact from Egypt or from further east had to do with this. But a sort of pantheistic awakening, at once intellectual and religious, beginning from many centres, of which the names of Pythagoras, Heraclitus, Parmenides, and the mythical Orpheus may serve to remind us, had set going a wave of mingled speculation and aspiration, which at one time threatened to destroy mythology, at another to transmute it into novel forms. Wants hitherto unmet were met in various ways. Individuals were not satisfied with the traditional and conventional worships of the family or of the state. There was a deepening sense, we know not how infused, of guilt requiring atonement, of pollution crying for purgation, a feeling which had its roots in very early times, but was now becoming universal' (L. Campbell, *Religion in Greek Literature*, London, 1898, p. 127 f.; cf. also Casartelli, in *Spiegel Mem. Vol.*, Bombay, 1908, pp. 180-182).

According to the most probable theory, this was the age of Zoroaster (660-583 B.C.; West, *SBE* xlvii. [1897], Introd. xxvii, xxxviii). The Hebrew prophetic literature, starting in the 8th cent., continued during this period (*HDB* iv. 112). In the Tigris-Euphrates valley, Nineveh fell in 607-6 B.C.; Babylon was captured by Cyrus in 539 B.C.; the life of Buddha may approximately be fixed between 567 and 487 B.C. (see *ERE* ii. 881). As in the case of the Heroic Age in Europe, racial disturbances, tribal unrest and movement, promoted individualistic tendencies in this new grouping of peoples. It is at present, however, impossible to trace any real connexion between these almost contemporaneous historical and literary events, or to find any evidence of the communication of the ideas underlying Buddhism from the east to the west, except that they were all the results of a long series of previous movements; 'and these previous movements were, in fact, so similar that they ran on nearly parallel lines resting on the common basis of animistic conceptions. And similar causes acting in these parallel lines took about, though by no means exactly, the same time to produce corresponding results' (Rhys Davids, *HL*, 123).

12. The relations of Buddhism to the rival religions.—Buddhism and Jainism, as we have seen, were the results of parallel and almost contemporaneous movements, organized outside the Holy Land of the Brāhmins, by Kṣatriyas, in

opposition to Brāhman claims. But, in spite of this initial antagonism, during the early period the three rival faiths seem to have existed side by side in comparative harmony. The lay members of the Buddhist and Jain orders, while they looked for spiritual guidance to their own teachers, retained the services of their Brāhman priests for the performance of domestic rites. Buddhism has so completely disappeared from the Indian northern plains that it is impossible from modern facts to illustrate the conditions which prevailed at the period of its origin and vigour.

Even to the present day the heterodox Buddhists of Nepāl combine the worship of Śiva with that of Buddha, and employ Brāhmans in sacred and domestic rites (Oldfield, ii. 147). The same fusion between Buddhism and Brāhmanism, especially in the cult of Śiva, prevails in Ceylon, and was recognized under the late Burmese dynasty at Mandalay (R. S. Hardy, *Eastern Monachism*, London, 1850, p. 201 ff.; Shway Yoe [J. G. Scott], *The Burman*, 1882, i. 173; H. Yule, *Mission to Ava*, 1855, London, 1858, p. 50 f.). In continental India the same conditions prevail in the case of Jainism. Jains, as a rule, at present freely worship the Hindu gods that are connected with the legends of their saints. In Bombay, Mārṅarī Jains worship Viṣṇu and Kṛṣṇa as Bālaji, and observe Hindu fasts and holidays; some even worship the Śaktis, or Mother-goddesses (Fergusson-Burgess, *Cave Temples*, 1880, p. 487; *BG* v. [1880] 52, ix. [1901] pt. i. p. 111, xxi. [1884] 105, xxi. [1884] 125; Wilson, *Works*, 1861, i. 321). In Baroda the Vaiṣṇava and Jain sections of the Vāṇia or merchant caste freely intermarry; and, when a Vaiṣṇava girl is married in a Jain family, she attends Jain rites while she is at her husband's house, and worships the old Brāhmanical gods when she visits her parents—a condition of things which prevails among similar castes in other parts of the country (*Census Report Baroda*, 1901, i. 492 f.; *BG* ix. [1901] pt. i. p. 100; Ibbetson, *Punjab Ethnography*, 180). In S. India, while a Śaiva will neither eat food nor intermarry with a Vaiṣṇava, the ancient hostility between Jains and Hindus has nearly disappeared; but in the Central Provinces, though they may dine together, they do not intermarry (R. V. Russell, *Gazetteer of Nāgpur*, 1908, i. 67, 71). The line, in fact, which divides Jains from Hindus can with difficulty be traced; and there are other sects, admittedly Hindu, which present greater divergence from orthodox Brāhmanism.

The evidence of the Chinese pilgrims and that derived from other sources proves that the same tolerance of the rival faiths prevailed during the greater part of the period when Buddhism was in the ascendant, and even when it began to show symptoms of decay. The actual decay of Buddhism, which was due to internal weakness and the competition of the revived Brāhmanism, seems to have set in about A.D. 700; and, while it still held its ground in remote parts of the land, its final disappearance was due to the Muhammadan occupation of N. India. Buddhism in its early form was probably too simple, and was thus ill adapted to supply the religious needs of a race which has always found a sensuous type of worship more attractive. It demanded from its followers a standard of morals which was in advance of their stage of culture. It involved the discontinuance of sacrifice, and of the myriad ritualistic devices by which the Hindu has ever tried to win the favour, or avert the hostility, of his gods. It abolished the personality of Brahma, into whom most orthodox Hindus hope eventually to be absorbed, and it substituted the vague conception of Nirvāna, which meant to Buddha the extinction of lust, anger, and ignorance; to the Jains and some Buddhists eternal blissful repose; to other Buddhists extinction and annihilation (Hopkins, 321; Rhys Davids, *HL*, 283).

The State in India has always been tolerant of every form of religion (see A. Lyall, *Fortnightly Review*, Nov. 1908, p. 717 ff.); and this rule was followed by the great Buddhist Emperor Aśoka (q.v.). Though it may be true that the gradual downfall of Buddhism in the Indian plains was due to causes other than persecution, it is also certain that fanatical rulers from time to time indulged in savage outbursts of cruelty, and that both Buddhists and Jains were victims of outrage.

That such outbursts of wrath should have occurred is not wonderful, if we consider the extreme oppressiveness of the

Jain and Buddhist prohibitions when ruthlessly enforced, as they were by some Rājās, and probably by Aśoka. The wonder rather is that persecutions were so rare, and that as a rule the various sects managed to live together in harmony, and in the enjoyment of fairly impartial official favour' (Smith, *Early Hist.*², 191; for a somewhat different view, see Rhys Davids, *Buddhist India*, 319).

13. The continuity of Brāhmanism and the rise of Hinduism.—Thus Brāhmanism, even during the ascendancy of Buddhism, never suffered complete extinction, though it undoubtedly lost much of its dignity and importance when Buddhism in N. India and Jainism in the S. and W. enjoyed the patronage of ruling powers and were elevated to the rank of State religions. The extension of Indo-Aryan colonization, the continuous absorption of the non-Aryan tribes, and, finally, the establishment of the great Maurya Empire under Aśoka (272–232 B.C.), which ruled the greater part of the Peninsula, led to a modification of the earlier forms of Hindu belief. The Hindu has always been accustomed to localize his gods, and probably from the earliest times the tutelary village-gods received more veneration from the masses of the population than the deities of a higher class whose cultus was the monopoly of the priestly body. This was the case with the Roman colonists under the Empire.

'The conditions of health and disease are so obscure, the influences of will and imagination on our bodily states are so marked, that, in all ages, the boundaries between the natural and the unknowable are blurred and may be easily crossed. . . . On hundreds of provincial inscriptions we can read the catholic superstition of the Roman legionary. The mystery of desert or forest, the dangers of march and bivouack, stimulated his devotion. If he does not know the names of the strange deities, he will invoke them collectively side by side with the gods whom he has been taught to venerate' (S. Dill, *Roman Society from Nero to Marcus Aurelius*, London, 1904, pp. 459, 480; and see artt. DRAVIDIANS).

It was from this combination of Aryan and non-Aryan cults and beliefs that the Neo-Brāhmanism took its rise.

14. The Scriptures of the Neo-Brāhmanism.—The literature of the new form of Brāhmanism is all the work of, or inspired by, the Brāhman hierarchy. The theory which it suggests is that there was no violent break between the older and the newer faith. Hence it is difficult to trace the stages of the evolution by which the theology was reconstructed.

(a) *The Purānas*.—This difficulty has been increased by a long-standing error regarding the date of that body of literature known as the Purānas. To the Hindu mind their name—'Archæologia,' 'the ancient writings'—suggests immemorial antiquity. It has been the habit of critics to date the best known of them, *Viṣṇu Purāna*, about A.D. 1045 (H. H. Wilson, *Viṣṇu Purāna*, London, 1840, *Introd.* lxxii). It has, however, recently been proved that this and other important works of the same series must be dated about A.D. 500, while the *Vāyu Purāna* is referred to the 4th cent., and all the principal works, which in their present form are recensions of a much older body of literature, were re-edited in the Gupta period (A.D. 320–480), when the study of Sanskrit was revived (Smith, *Early Hist.*², 19 f.; Macdonell, *Skr. Lit.*, 299). From this conclusion the important result follows that the growth of the Neo-Brāhmanism was contemporaneous with the decay of Buddhism in N. India, and its development naturally progressed side by side with that of the later Buddhism and Jainism.

(b) *The Law literature*.—The second body of literature connected with this religious revival is that of the Law-books. These, like the Purānas, are the result of various recensions. The two most important, the *Vaiṣṇava Dharmasāstra* and the *Mānava Dharmasāstra*, probably assumed their present form about A.D. 200; and the latter is closely connected with the *Mahābhārata*, contain-

ing many verses quoted from that Epic (Bühler, *Manu* [SBE xxv. (1886)], Introd. xxi; Macdonell, *Skr. Lit.*, 428). But, according to Bühler, the Law-book did not borrow from the Epic; both authors used the same materials; and those materials were not systematic treatises on law and philosophy, but the floating proverbial wisdom of the philosophical and legal schools, which already existed in metrical form. Manu's treatise, which has become for modern Hindus the text-book in matters connected with religion and social observances, represents the period before the recognition of the sectarian gods in the schools where it originated. It nowhere teaches the performance of rites other than Vedic; it nowhere inculcates the worship of any of the deities of the Paurānic school; nor is there any hint that it was intended to form a digest of the sacred Law. It rather bears unmistakable marks of being a school book, intended for the instruction of all Āryas (Bühler, *SBE* xxv., Introd. lv). It contains no allusion to the post-Vedic Trimūrti, the triad consisting of Brahmā, Viṣṇu, and Śiva, the last two gods being only once mentioned by name (xii. 121); and it ignores the cultus of the Śakti (female powers), and the efficacy of fervent faith in Kṛṣṇa (see art. BHAKTI-MĀRGA, vol. ii. p. 539 ff.). The great god is Prajāpati, lord of created beings; the Brāhman and his teacher are objects of reverence, and hell is the fate of those who insult or injure them (ix. 319, iv. 165). A Brāhman who serves his teacher until death enters forthwith the eternal mansions of Brahma. Image-worship is casually observed, but temple priests are spoken of with a measure of contempt (iii. 152, 180). The doctrine of transmigration is clearly stated, and, as a consequence of this, the various hells described, though places of terrible torture, resolve themselves merely into places of temporary purgation, while the heavens become only steps on the road to union with Brahma. The dignified isolation or calculated reticence of the school is shown by the absence of reference to Buddhism; and two verses which speak of the Mlechchha, or barbarian (ii. 23, x. 45), are devoid of any particularity which would identify them with the Greeks or any other foreign races. For the ethical tone, see *IA* iv. [1875] 121 ff.

(c) *The Epics; the Mahābhārata*.—It is in the Epic literature, represented by the *Mahābhārata* and the *Rāmāyaṇa*, that the literary evolution of the Neo-Brāhmanism is most fully illustrated. This period may be fixed roughly from 500 to 50 B.C. But behind this probably lies a long period, when, as in the case of Homer, the ballads out of which the Epics were compiled existed in an oral form. Episodes are embedded in the existing texts which may be regarded as fragments of older narratives, the antiquity of which is proved by the fact that their subject-matter often refers to the resistance offered by the warrior class to the growing claims of the Brāhman hierarchy.

The *Mahābhārata*, after undergoing various recensions, is believed to have grown round a legendary nucleus during some eight centuries (400 B.C.—A.D. 400) (see Hopkins, *The Great Epic of India*, London, 1901, p. 398). The war between the Pāndavas and Kauravas, which forms the main subject of the poem, has been supposed to represent the contest between two successive bodies of Indo-Aryan immigrants, the former a Himālayan tribe practising polyandry, whose deity was Kṛṣṇa Vāsudeva, the traditional founder of the anti-Brāhmanical monotheistic Bhāgavata religion; the second much later comers and supporters of official Brāhmanism (G. A. Grierson, *Census Report India*, 1901, i. 287 ff., *JRAS*, 1908, p. 604 ff.; A. Weber, *IA* xxx. [1901] 281 ff.). The Kṣatriya party won the day, but had in the end to yield to the

supporters of Brāhmanism. In this Epic the transition from the older to the newer Hinduism is marked in various ways. The facts have been carefully collected and analyzed by E. W. Hopkins (*Rel. of India*, 351 ff.). There is, first, an abnormal growth of *yoga*, or mental concentration.

'In the Brāhmanas it is the sacrifice that is god-compelling; but in the epic, although sacrifice has its place, yet when miraculous power is exerted, it is due chiefly to Yoga concentration, or to the equally general use of formulæ; not formulæ as part of a sacrifice, but as in themselves potent; and mysterious *mantras*, used by priest and warrior alike, serve every end of magic.'

Caste distinctions are now fully recognized, and the most heinous crime is to commit an offence against caste order. On the other hand, the greatest merit is to present gifts to priests, whose insolence, greed, and rapacity are constantly dwelt upon. This, however, applies chiefly to court Brāhmanas and to ascetics, who are above all law, while the village Brāhmanas and hermits are free from the reproach attaching to their hypocritical, debauched brethren. Apart from the sectarian gods, the chief objects of worship are priests, the *manes*, and, for form's sake, the Vedic gods. These, with the addition of Kubera, god of riches, are now degraded to the rank of 'world guardians' (*lokapāla*), and are definitely subordinated to the newer divinities. Among the latter is now included Dharma Vaivasvata, the god of justice, son of the Sun-god. Another new and interesting figure is Kāma, god of love, who, in the form of the personification of sexual desire, is as old as the Atharvaveda (ix. 2, iii. 25) and is still the subject of a Mystery Play in S. India (E. Thurston, *Castes and Tribes of S. India*, iv. 399 ff.). In the Purānas he is provided with a consort, Ratī or Revā, goddess of desire; and it has been suggested that his eminence is due to association with the Greek Eros, through the agency of Greek slave-girls, who about this time were imported into W. India (J. W. McCrindle, *Periplus*, Calcutta, 1879, p. 123; *IA* ii. [1873] 145). The old Nature-worship is represented by the cult of mountains, rivers, and sacred trees, many ancient rites and beliefs being concealed under the 'all-embracing cloak of pantheism,' which appears in the Epic. It has been alleged that phallus-worship is often mentioned in the *Mahābhārata*, as if it had always been common everywhere throughout N. India; but this assertion has been disputed (Rhys Davids, *Buddhist India*, 165 f.; B. C. Mazumdar, *JRAS*, 1907, p. 337 ff.). The local theriolatry is illustrated by the cult of Hanumān or Hanumat, the monkey hero of the *Rāmāyaṇa*, who in later times has become the chief village guardian deity. Serpent-worship appears in the cult of Nāgas.

From the religious point of view the most interesting portion of the Epic is the *Bhagavad-gītā*, in which the Supreme Being incarnate as Kṛṣṇa expounds to Arjuna the result of the eclectic movement combining the Sāṅkhya, Yoga, and Vedānta doctrines (see *ERE* ii. 535 ff.). It is now certain that portions of this poem, in which the doctrine of *bhakti*, or fervent faith, is taught, are pre-Christian, and therefore the doctrine itself is of indigenous Indian origin (*ib.* ii. 547^b).

'Nothing in Hindu literature is more characteristic, in its sublimity as in its puerilities, in its logic as in its want of it. It has shared the fate of most Hindu works in being interpolated injudiciously, so that many of the puzzling anomalies, which astound no less the reader than the hero to whom it was revealed, are probably later additions. It is a medley of beliefs as to the relation of spirit and matter, and other secondary matters; it is uncertain in its tone in regard to the comparative efficacy of action and inaction, and in regard to the practical man's means of salvation; but it is at one with itself in its fundamental thesis, that all things are each a part of One Lord, that men and gods are but manifestations of the One Divine Spirit, which, or rather whom, the Vishnuite re-writer identifies with Krishna, as Vishnu's present form' (Hopkins, *Rel. of India*, 390).

It has become the Gospel of the Vaiṣṇava sectarians, and is the inspiration of the new school led

by Vivekānanda (see § 35). For a criticism of its theology from the Christian standpoint, see Slater, *Higher Hinduism*, 1902, p. 126 ff.

(d) *The Rāmāyana*.—While the *Mahābhārata* thus collected and popularized the legends and traditions which had their centre in the Holy Land of the Hindus, the Eastern Panjāb, the same service was done by the second Epic, the *Rāmāyana*, for the eastern stories which originated in the kingdoms of Magadha and Kosala, the present W. Bengal. Like the *Mahābhārata*, in its present differing forms, it is the result of a long series of recensions, and considerable additions have been made to the original nucleus, which 'appears to have been completed at a time when the epic kernel of the *Mahābhārata* had not as yet assumed definite shape'; and this earlier portion seems to be pre-Buddhistic (Macdonell, *Hist. of Skr. Lit.*, 306 f.; Rhys Davids, *Buddhist India*, 183 f.). The first portion, that treating of the banishment of the hero Rāma, is in form a historical saga, widely differing from the second part, which records the extension of Brāhmanism into S. India; but the story is based on N. Indian myths, and in the heroine, Sītā, who is represented as having emerged from the earth when her father was ploughing, we recognize the favourite myth of the Earth-spirit mated to a consort, from whose union, by a sort of mimetic magic, the fertility of men, cattle, and crops is assured.

From a religious point of view the *Rāmāyana* is much less interesting than the *Mahābhārata*, because it has been remodelled by a single hand, that of Vālmiki, the traditional author, who has manipulated his materials to produce at once an artistic poem and a religious treatise, in the interest of the Rāma-worshipping section of the Vaiṣnavas.

15. The historical development of Neo-Brāhmanism.—The scanty information which we possess of the history of this period has been collected and arranged from materials derived from the writings of Greek travellers and Buddhist pilgrims, with the aid of inscriptions and coins, by V. A. Smith (*Early Hist.*²).

The Maurya dynasty, founded by Chandragupta Maurya (321 B.C.), attained its supremacy under Aśoka-vardhana (see *ERE* ii. 124 ff.), who made Buddhism the State religion. It was destroyed in 184 B.C. by Puṣyamitra Śuṅga, who, in order to assert his claim to be paramount sovereign, performed the antique rite of the horse-sacrifice (*aśvamedha* [q.v.]), thus marking the beginning of the Brāhmanical reaction against Buddhism, which was fully developed under Samudragupta and his successors five centuries later. At the same time, there is no evidence that Buddhists or Jains suffered persecution. Under the next dynasty, the Kāpva, we find the king supporting the ideal system of Manu, and acting under the advice of Brāhman ministers. This was followed by the Andhra dynasty, among the kings of which Hala is famous as a patron of Prākṛit literature.

In the obscure period which followed, N. India was overrun by hosts of invaders from the north under the names of Śaka or Scythians, and Pahlavas or Parthians. The dates are much disputed; but it appears that about A.D. 60 the Yuehchi or Kusān dominion was consolidated in the N.W. by Kadphises I., and that his successor, Kadphises II., annexed N. India and destroyed the Indo-Parthian power in the Panjāb. This Kusān empire lasted till A.D. 226. The important point to be noted here is that these foreign chieftains rapidly succumbed to the influence of their new environment. Kaniska and Huviṣka seem, at least formally, to have become Hindus; Vāsudeva (c. A.D. 185-226) bears an Indian name, and adopted Śalva symbols on his coins (J. Kennedy, *JRAS*, 1907, p. 967).

From this point we have hardly any information until the rise of the Gupta empire under Chandragupta I. (A.D. 326-375), whose successor, Samudragupta, showed his sympathy with orthodox Brāhmanism by performing the horse-sacrifice. The claim to perform this rite, symbolic of supreme power, was asserted by various Hindu princes in S. India in the early centuries of our era (Rice, *Mysore and Coorg from the Inscriptions*, 1909, p. 209 f.). 'Whatever may have been the causes, the fact is abundantly established that the restoration of the Brahmanical religion to popular favour, and the associated revival of the Sanskrit language, first became noticeable in the second century, were fostered by the western satraps during the third, and made a success by the Gupta emperors in the fourth century. These princes, though apparently perfectly tolerant of both Buddhism and Jainism, . . . were themselves, beyond question, orthodox Hindus, guided by Brahman advisers, and skilled in Sanskrit, the language of the pundits. An early stage in the reaction against Buddhist condemnation of sacrifice had been

marked by Puṣyamitra's celebration of the horse-sacrifice towards the close of the second century. In the fourth, Samudragupta revived the same ancient rite with added splendour; and in the fifth, his grandson repeated the solemnity. Without going further into detail, we may sum up the matter in the remark that coins, inscriptions, and monuments agree in furnishing abundant evidence of the recrudescence during the Gupta period of Brahmanical Hinduism at the expense of Buddhism, and of the favour shown by the ruling powers to 'classical' Sanskrit at the expense of the more popular literary dialects' (Smith, *Early Hist.*², 287).

The Gupta empire fell before the attack of another body of invaders, the Huns, about A.D. 500.

These successive inroads produced important results on the ethnology of N. India. The progress and final absorption of these foreigners in the Hindu population have recently been fully investigated for W. India (*BG* ix. [1901] pt. i. p. 438 ff.). The Hūpa, or Hun, invaders were admitted by the Brāhman among the Kṣatriya or warrior class—a fact disguised under the legend of the fire-initiation at Mount Abū (*ERE* i. 51 f.). Similar legends describe the successive introduction of foreigners into the Brāhman hierarchy (V. A. Smith, 'The Gurjaras of Rājputāna and Kanauj,' *JRAS*, Jan.-June 1909; D. R. Bhandarkar, 'The Guhilots,' *JASB*, 1909, p. 167 ff.).

The influence of these foreigners on Hindu beliefs must have been considerable; but the official Brāhman literature gives little or no indication of the process of the reconstruction of the faith during the period of foreign rule. When we come to the establishment of the national power under Harṣa (A.D. 606-645), the evidence is more complete. He was a Hindu, but in his later life favoured Buddhism. He worshipped at times Śiva or the Sun, or followed the Buddhist rule, and he impartially erected temples to all three. Most of his subjects worshipped the sectarian gods, and selected as their patron deity whichever god they preferred (see Cowell-Thomas, *The Harṣa-carita of Bāna*, London, 1897, Introd. xii ff.; M. L. Ettinghausen, *Harṣa Vardhana*, Louvain, 1906, ch. ii.). Thus the modern sectarian worship was gradually established in N. India; and the same revival occurred in the Deccan under the Chalukya king, Pulakeśin I. (A.D. 550-608), who, in the decadence of Buddhism, is said to have performed many Hindu sacrifices, including the *aśvamedha*, or horse-rite (*BG* i. [1896] pt. ii. p. 191). The activity of the new faith is shown in the erection of numerous cave temples in the period A.D. 500-800 (Fergusson-Burgess, *Cave Temples*, 1880, p. 403).

16. The extension of Brāhmanism in S. India.—The extension of Hindu influence into the South was obstructed by the great forest tract known as Dandakāranya, the present Marāṭha country, and by the ranges of the Sātpura and Mahādeo hills which cross the Peninsula, dividing the North from the plateau of the Deccan. Hence, at the outset, Brāhman missionaries seem to have made their way along either the eastern or the western coastline, or by the sea route. The question has been discussed in the article on the Bombay Presidency (*ERE* ii. 788), and the facts there collected need not be repeated. The Aryans before the 7th cent. B.C. seem to have had little knowledge of the Deccan; and R. G. Bhandarkar dates their acquirement of information regarding the southern region about 350 B.C. (*BG* i. pt. ii. p. 141). The question has also been discussed by Rhys Davids (*Buddhist India*, 23 ff.), by Caldwell (*Dravidian Grammar*², London, 1875, p. 114 ff.), and by H. A. Stuart, quoted by Thurston, *Castes and Tribes of Southern India*, i. 373 ff. Burnell (*JA* i. [1872] 310) believes that about A.D. 700 Brāhmanical influence was inconsiderable in the South, and that the Skr. place-names which are found appear only in the fertile deltas and at the seaports, where they were probably introduced by Buddhist missionaries. The latest discussion of the subject (A. Govindacharyar Svāmin (*JA* xli. [1912] 227 ff.) rejects Burnell's view, and places the 'Arianization of the South' after the 6th and before the 3rd cent. B.C., which is too early. The modern school of S. Indian scholars naturally adopts the higher

series of dates. Whatever may be the exact date of the introduction of Brāhmanical beliefs and practices into S. India, it was certainly, when contrasted with N. India, comparatively late; and this fact accounts for the characteristic form of S. Indian Brāhmanism, which has developed on lines of evolution quite different from those of the North (V. Kankasabhai, *The Tamils: Eighteen Hundred Years Ago*, 1904, p. 227 ff.; L. K. Anantha Krishna Iyer, *Cochin Tribes and Castes*, ii. [1912] 171 f.; Rice, *Mysore and Coorg from the Inscriptions*, 204 ff.).

17. The establishment of Hinduism in its modern form.—We have now reached the stage at which the Brāhmanical reaction against Buddhism and Jainism was completed, and Hinduism, as we find it in existence at the present time, was firmly established. The Brāhmins now controlled the law and social institutions of the people. The theory of caste was fully adopted, and they were placed at the head of society; the movement led by the Kṣatriyas in opposition to them had collapsed.

All philosophy, except their own pantheistic theosophy, had been driven out of the field. But Vedic rites and Vedic divinities, the Vedic language and Vedic theology, had all gone under in the struggle. The gods of the people received now the homage of the people. Bloody sacrifices were still occasionally offered, but to new divinities; and brahmins no longer presided over the ritual. Their literature had had to be recast to suit the new worship, to gain the favour and support of those who did not reverence and worship the Vedic gods. And all sense of history had been lost in the necessity of garbling the story of the past so as to make it tally with their own pretensions. . . . A small and decreasing minority continued to keep alive the flickering lamp of Vedic learning; and to them the Indian peoples will one day look back with especial gratitude and esteem' (Rhys Davids, *Buddhist India*, 157 f., who possibly somewhat overstates the case).

18. The development of Hinduism.—The Neo-Brāhmanism, henceforward to be called 'Hinduism,' was developed in two ways: first, by the creation, mainly illustrated by the Epic and Paurānic literature, of a gallery of deified personages, the legends regarding whom were largely drawn from the current folk-lore or popular tradition, and, by a reconstruction of the traditions, were in a measure connected with the system which they had superseded; secondly, by the adoption of deities, religious myths, and cults derived from the races beyond the Brāhmanical pale.

We have examples of the first class in the deified heroes of the *Mahābhārata*, the five Pāṇḍava brethren, whose cults still prevail in various parts of the country; at many sites in the Himalaya; at Benares; in the Konkans and the Deccan; in S. India (Atkinson, *Himalayan Gazetteer*, ii. [1884] 281 f.; M. A. Sherring, *The Sacred City of the Hindus*, London, 1868, pp. 67, 177, 217; *BG* i. pt. i. [1896] p. 278, xxii. 389, xiii. 404; Fergusson-Burgess, p. 113; Thurston, *Ethnogr. Notes*, Madras, 1906, pp. 146 ff., 249, 301). The second process by which the pantheon has been formed was by the adoption and absorption of the local deities, this localization being a feature which Indian polytheism shares with the Semites and the Egyptians (W. R. Smith, *Rel. Sem.*², 38 ff.; Sayce, *HL*, 89, 121; A. Erman, *Life in Ancient Egypt*, Eng. tr., London, 1894, p. 259 f.; A. Wiedemann, *Rel. of the Anc. Egyptians*, do. 1897, p. 8 f.). Naturally, the process of absorption, in India as in Greece, assumed many and varied forms.

'We recognize now that the personages of the Greek and other polytheisms were not pure crystallized products of a single and identical people, but were modified variously by their environment, borrowing traits and epithets from other local powers whom they may have dispossessed or with whom they may have shared their rule. . . . The divine name, especially in ancient religions, was a powerful talisman, a magnet attracting to itself a definite set of cult-ideas and legends' (Farnell, *CGS* v. 86 f.).

The worship of vague spirits of the forest by the most primitive tribes, as the stage of settled agriculture displaces nomadism, develops into the

cult of spirits which promote the fertility of the soil, cattle, and men. In Manipur, for instance, no fewer than 'four definite orders of spiritual beings have crystallized out from the amorphous mass of animistic Deities' (Hodson, *The Meitheiis*, 1908, p. 96). By degrees, one of these local deities, usually known in N. India as *Devī*, in S. India as the *Grāmadevatā* and *Aiyanār*, the central figure of the Dravidian pantheon, pushes itself into notoriety, and is finally adopted by Brāhmanism. This may occur because the shrine is on the borders of the territory occupied by more than one allied tribe or village, and thus acquires a reputation more than local; or because at this particular place there has been a manifestation of special spiritual power, shown by the 'possession' of the medicine-man or his followers, or by some notable case of healing. Such a shrine is, in process of time, appropriated by some low-caste Brāhman priest, and the local deity comes gradually to be identified with some manifestation or incarnation of one of the greater gods. Hence arose the *Devī* or *Kālī* of Calcutta, of the Vindhyan hills, of *Devī-pātan* in Oudh, and the *Bhavānī* of *Tuljāpur* in the *Nizām's* Dominions, who possess powers of magic, wonder-working, and healing superior to those of the village-goddesses from whose ranks they have been promoted. The same is the case with the shrines dedicated to men who gained a reputation for good works or wickedness in this life (Lyll, *Asiatic Studies*², i. 1 ff.). Of course, it is not always possible to trace the exact course of the evolution. This difficulty is increased in India by the absence of expressive cult-titles, which in Greece have so largely facilitated the analysis of the elements of the pantheon (*CGS* i. 35 ff.).

19. Modern Hinduism defined.—In tracing the evolution of religion in India, no problem is more difficult than that of framing a definition of Hinduism as we observe it at the present day. Many of the tests which have been proposed from time to time are obviously inadequate. Thus it has been said that a Hindu is one who cremates the adult dead. But certain classes of Hindu ascetics, like the *Bishnois* of the Panjāb and the *Lingāyats* of the Deccan, always bury their dead; and among the lower classes of Hindus both forms of disposal of the corpse are in use. Again, it is said that a Hindu is one who receives religious service at the hands of Brāhmins. But in the Panjāb nearly all Sikh villagers reverence and employ Brāhmins as their Hindu neighbours do, and the same is the case with the Jains; while many Hindus who have been converted to Islām appoint the Brāhman to conduct their marriages according to the Hindu rule, adding the Muhammadan ritual as a legal precaution (Ibbetson, *Punjab Ethnography*, 112 f.).

The difficulty of framing a definition of Hinduism arises from the fact that under the general title 'Hindu' are included classes whose belief, ritual, and mode of life are strangely diverse—the learned Brāhman, who is a follower of the *Vedānta* philosophy; the modern theist or agnostic, trained in the learning of the West; the semi-barbarous hillman, who eats almost any kind of food without scruple, knows little of Brāhmanical mythology, belief, or ritual, and in time of need bows before the stone which he supposes to be occupied by the god of his tribe or village; lastly, there is the vagrant, or the member of a caste like the *Chuhrā* or *Bhangī* of N. India or the *Pariah* of the South, who is abhorred by all pure Hindus. The difficulty, in short, lies in separating the Animist from those classes of Hindus whose beliefs have a more or less animistic basis. Hence a recent writer proposes to include among Hindus

'all natives of India who do not belong to the Musalmān, Jain, Buddhist, Christian, Pārsi, Jew, or any other known religion of

the world, and whose form of worship extends from monotheism to fetishism, and whose theology is wholly written in the Sanskrit language' (*Census Report Baroda, 1901, i. 120 f.*).

This definition is unsatisfactory, inasmuch as it ignores the fact that Hinduism is not a religion in the sense of the word as used by European scholars. Thus a Hindu writes: 'Hinduism is that which a Hindu does'; in other words, it is a question of ritualistic and social observance (Guru Proşad Sen, *Introd. to the Study of Hinduism, 1893, p. 9*). The current terms, 'Hinduism' and 'Brāhmanism,' are of European origin, the only Hindu general term for 'religion' being *dharma*, defined as 'established order, usage, institution, custom, prescription; rule, duty; virtue, moral merit, good works; right, justice, law' (Macdonell, *Skr. Eng. Dict., London, 1893, s.v.*). According to Manu (*Laws, ii. 6 [SBE xxv. 30]*), 'the whole Veda is the (first) source of the sacred law, next the tradition and the virtuous conduct of those who know the (Veda further), also the customs of holy men, and (finally) self-satisfaction.' *Dharma* is distinct from 'the path' (*mārga*), inasmuch as 'the path' came into existence at a definite period, while *dharma* is eternal. 'The path' and 'the doctrine' (*mata*), combined together, are often expressed by one word, *sampradāya*, literally 'that which is given,' which Monier-Williams (*Brāhmanism and Hinduism*, 61) defines as 'a particular body of traditional doctrines handed down through a succession of teachers,' also designated 'daršana or mata—that is, particular views or opinions on religion or philosophy.'

'The great difference between the Hindu conception of the "dharma" and the European conception of "religion" is this. To a European, Christianity or Christian religion are self-defined terms, and the acceptance of those ideas and practices that are indicated by the word would make a man Christian. In the case of Hindu "dharma," the relation is different. Hindus are a definite body, and Hindu "dharma" is that indefinite thing which the Hindus consider their own "dharma." . . . The word *Hindu* is itself a foreign one. The Hindus never used it in any Sanskrit writing, that is, those which were written before the Mohamedan invasion. In fact there was no need of calling themselves by any particular name (all the rest of the world being 'foreigners' (*mlechchha*, Greek *βάρβαρος*)). . . Hindus define a Hindu as a man who has not fallen from Hinduism, that is, taken up the membership of any community like Christian or Mohamedan, which is not considered as a Hindu community. The distinction between the Hindus and the Animists is thus based only on ignorance. . . The distinction drawn between a Hindu and non-Hindu is merely a provisional one. It may change at any time. Hinduism may, in future, include Christians, Mohamedans, and Buddhists. Hinduism is an ever-changing society, which may expand and take in races and peoples irrespective of their religious beliefs. What societies it will absorb depends almost entirely on the circumstances' (Shridhar V. Ketkar, 18, 22, 33).

For practical purposes the definition proposed by Lyall may be accepted, that Hinduism is

'the collection of rites, worships, beliefs, traditions, and mythologies that are sanctioned by the sacred books and ordinances of the Brahmins and are propagated by Brahmanic teaching. And a Hindu is one who generally follows the rules of conduct and ceremonial thus laid down for him, particularly regarding food and marriage, and the adoration of the gods' (*Rel. Systems of the World, London, 1889, p. 114*). Or—to use the words of a Hindu writer—the modern Hindu 'should be born of parents not belonging to some recognised religion other than Hinduism, marry within the same limits, believe in God, respect the cow and cremate the dead' (*Census Report Panjāb, 1912, l. 109*). For criticisms of other proposed tests of Hinduism, see *Census Report, 1912, United Provinces, i. 121, Madras, i. 50 f., Travancore, i. 193 f.*

20. Hinduism as a missionary religion.—Though concealed by various fictions and conventions, the theory which underlies the system is that all residents of India are born Hindus. This is illustrated by the controversy which arose upon the question whether Hinduism is, or is not, a missionary religion. In the Lecture on Missions delivered in Westminster Abbey in 1877 (*Selected Essays, 1881, ii. 49*), F. Max Müller argued that three religions—Judaism, Brāhmanism, and Zoroastrianism—are 'opposed to all missionary enterprise'; while 'three have a missionary character from their very beginning—Buddhism, Mahom-

edanism, and Christianity.' Comparing Brāhmanism with Judaism, he argued that

'a very similar feeling prevented the Brāhmins from ever attempting to proselytise those who did not by birth belong to the spiritual aristocracy of the country. Their work was rather to keep the light to themselves, to repel intruders; and they went so far as to punish those who happened to be near enough to hear the sound of their prayers, or to witness their sacrifices.'

This was written from the point of view of a student of the Hindu sacred books, not of a practical observer of the people; and, as he afterwards explained, by missionary religions he meant 'those in which the spreading of the truth and the conversion of unbelievers are raised to the rank of a sacred duty by the founder or his immediate successors' (*ib. i. 94*). This view is so far correct that Hinduism was not the creation of any single founder, and that no authority has ever controlled its organization or systematically promoted the conversion of the heathen. In his reply to these remarks, A. Lyall (*i. 134 ff.*) contended that

'so far from it being a non-missionary religion, in the sense of a religion that admits no proselytes, one might safely aver that more persons in India become every year Brahmanists than all the converts to all the other religions in India put together. . . . If by Brahmanism we understand that religion of the Hindus which refers for its orthodoxy to Brahmanic scriptures and tradition, which adores the Brahmanic gods and their incarnations, venerates the cow, observes certain rules of intermarriage and the sharing of food, and which regards the Brahman's presence as necessary to all essential rites, then this religion can hardly be called non-missionary in the sense of stagnation and exclusive immobility. . . . If the word proselyte may be used in the sense of one who has come, and who has been readily admitted, not necessarily being one that has been invited or persuaded to come, then Brahmanism might lay claim to be by far the most successful proselytising religion of modern times in India' (*ib. i. 135 f.*).

The question thus resolved itself into a controversy between two writers who discussed the question from two different points of view—one a student of the sacred books, who treated Hinduism as an organized religion founded on an ancient literature, and who regarded proselytism as a conscious, well-defined procedure carried on under conditions analogous to those which characterize Christian missionary work; the other an acute observer of the almost unconscious, unorganized methods by which the non-Aryan tribes are induced to enter the fold of Hinduism. The controversy is now somewhat obsolete, and in the opinion of all competent observers has been finally settled in favour of the views advocated by Lyall. For a recent discussion of Hinduism as a missionary religion, see Shridhar V. Ketkar, *op. cit.* 66 ff.

21. The conversion of the non-Aryans to Hinduism.—The process by which the non-Aryan tribes are converted to Hinduism has been described by Lyall in an essay familiar to all students of comparative religion (*i. 157 ff.*). Such conversion is naturally most common on the outskirts of the territory long occupied by the Hindus. Thus in Assam the Koch Rājās, who are without doubt of non-Aryan descent, have been recognized by the Brāhmins as sprung from Siva, the god having taken the form of one of their ancestors and visited the queen, who was herself none other than an incarnation of his divine spouse, Pārvatī.

'The Kachāri kings of Hiramba were similarly converted, and after their ancestry had been satisfactorily traced back to Bhim (one of the Pāṇḍava princes of the *Mahābhārata*) the two chiefs were placed about A.D. 1790 in the body of a large copper image of a cow, and thence produced as reclaimed Hindus. . . . For the Ahoms, Indra was selected as the progenitor of the kings, but no special origin seems to have been assigned to the common people, so that an Ahom on conversion takes as low a place in the Hindu caste system, in his own estimation, as he does in that of orthodox Hindus' (*Census Report Assam, 1892, i. 83; cf. art. ASSAM, vol. ii. p. 137 f.*).

The process is often gradual. When the Kachāri first puts himself under the guidance of a *gosāin*, or teacher of the Vaiṣṇava sect, he is a Hindu in little more than name, eating pigs and fowls, and continuing to drink strong liquor. After a time he somewhat modifies these abominable practices,

and then, after several generations, when the family has given up or concealed its taste for forbidden food and drink, and has become, in appearance at least, ceremonially pure, its members are finally promoted to the rank of orthodox Hindus.

'This, however, is a matter of many years, as spirits and pig's flesh are dear to the aboriginal palate, and many a man who would fain be admitted as a pure Hindu remains outside the pale, because it is not in him to forswear the nourishing diet of his ancestors' (*ib.* i. 84).

Some Assamese, when they profess a desire for conversion, are compelled to fast for a day or two (fasting being a form of purification from malignant spirit influence [A. E. Crawley, *The Mystic Rose*, London, 1902, p. 153 ff.]), after which they undergo a rite of atonement (*prāyaschitta*) at the hands of their teacher, who claims a suitable fee. But for at least three generations they are somewhat despised, and take no part in social affairs; after this they rank as Hindus (*Census Report Assam*, 1901, i. 225). The condition of things in the Central Provinces, where tribes like the Gonds (*q.v.*) are rapidly embracing Hinduism, is very similar (*Census Report*, 1901, i. 95).

22. Hindu sectarianism.—The process of the formation of new sects provides another method by which outsiders are admitted into Hinduism. The worship of the sectarian deities grew up during the period represented by the Epics and the Purānas; but the material for tracing their evolution is very scanty.

(a) *Brahmā*.—Of the members of the Hindu triad, Brahmā has now become an otiose, decadent divinity, mainly because he was always a god of the philosophers rather than of the common people. The process of his degradation is clearly marked in the *Mahābhārata*. It is commonly said that he has only a single shrine, that at Puṣkara in Rājputāna. But he has also a temple at Khed Brahmā in the State of Māhikāntha in Gujarāt (*BG* v. [1880] 437 f.); in S. India his cult is more persistent, shrines being dedicated to him at Chebrolu in the Kistna District, at Kālahastī in S. Arcot, at Mitrānandapuram close to Trivandrum, and possibly in a few other places (Oppert, 288 f.; V. N. Aiyā, *State Manual Travancore*, 1906, ii. 49; *Census Report Travancore*, 1901, i. 97). In the domestic ritual he is worshipped under the form of Vidhātṛī, personified fate; but even here he is placed second to Saṣṭī, the goddess presiding over the sixth day after birth (*BG* ix. [1901] pt. i. p. 33 f.; see BRĀHMANISM, vol. ii. p. 810 f.).

(b) *Śiva*.—The philosophical side of the cult of Śiva represents him as 'the earliest and universal impression of Nature upon men—the impression of endless and pitiless change' (Lyaill, ii. 306). But he has also assimilated much of the demonolatry and Animism of the non-Aryan races, as in his manifestation as Bhūteśvara, 'lord of goblins,' in which form his cultus was well adapted to serve the needs of the devil-worshipping Dravidians of S. India. He is the descendant of the Vedic Rudra, who has a beneficent as well as a malevolent character (Muir, iv. 339; Macdonell, *Vedic Myth.*, 77), the latter being veiled under his euphemistic title, Śiva, 'the auspicious one.' There seems no good reason to assign the origin of Śiva, the special Brāhman god, to the non-Aryan races, though his cultus may have been contaminated by their influence (Muir, iv. 349). It must be noted, however, that his temples are very commonly served, not by Brāhmins, but by members of the ascetic orders connected with his cult. His association is rather with the Himālaya (H. A. Rose, *Census Report, Punjab*, 1901, i. 127 f.). This is also shown by his cult-titles, Girīśa and the like, 'mountain-god,' and those of his consort Umā as Pārvatī, 'mountain-goddess,' and Haimavatī, 'she of the Himālaya,' and some Greek writers

identified him with Dionysus (J. W. McCrindle, *Ancient India as described in Classical Literature*, 1901, p. 64 n.). It has been suggested that the introduction of the cultus was due to the movement of Hun tribes from the north (*BG* ix. [1901] pt. i. p. 476). He is at once a god of Nature, the impersonation of re-integration and destruction; the typical ascetic; the contemplative philosopher and sage; the wild and jovial mountaineer, surrounded by troops of dancers. Hence his personality attracts two different classes of worshippers—the Brāhman philosopher, who sees in him the All-god from whom the Universe is evolved; and the peasant, who associates him with the mysteries of the reproduction of life.

The worship of the liṅga.—In modern Hinduism the symbol of Śiva is the *liṅga*, or phallus. Phallic worship appears in the Veda in the *śiṣnadevāh*, 'those who have the phallus as their deity'; but this seems to be regarded as a non-Aryan cult, and Indra is besought not to allow them to approach the sacrifice (Macdonell, *Vedic Myth.*, 155). In Buddhism and in the Atharvaveda we meet phallic genii (*kumbhānda*, *kumbhamuṣka*; Weber, *IA* xxx. [1901] 282), and in the *Mahābhārata* it is mentioned as if it had been common in N. India; but it is not included in the superstitious forms of worship described in the Buddhist Nikāyas (Rhys Davids, *Buddhist India*, p. 165 f.). The origin of the cult in India is obscure. Fergusson was disposed to connect the symbol with the Buddhist *dāgaba*, one of which has been found adapted to Śaiva worship in a cave at Wāi (*Hist. of Indian Arch.*, London, 1899, p. 304 f.; Fergusson-Burgess, 213; F. A. Maisey, *Sanchi*, London, 1892, p. 16 n.). Oppert suggests that it was derived from the Greeks—a view which seems improbable (*Orig. Inhab.*, 381; Muir, iv. 161, 421). Stephenson (*JRAS* viii. [1842] 330) and F. Kittel (*Ueber den Ursprung des Liṅga-kultus in Indien*, Mangalore, 1876) connected phallic worship with the non-Aryan tribes. In opposition to this view, we have the important fact that of the twelve great *liṅga* shrines, only three, those at Omkāra on the Narbadā, Triyambaka at Nāsik, and Bhīma-śaṅkara in the Deccan, can be reasonably classed as outside the distinctively Aryan area, and early traditions associate the establishment of *liṅgas* in N. India with Aryan saints and worthies (Muir, ii. 202, iv. 189 ff., 405 ff.). It may also be said that phallic worship is not general among the forest tribes at the present day. Thus, though the Todas are apparently immigrants from Malabar, there is no evidence of phallic worship among them (W. H. R. Rivers, *The Todas*, London, 1906, p. 447). On the whole, the facts seem to indicate that, though the cult may have prevailed among some of the indigenous tribes, it was not confined to them, and that in the form in which it now appears its extension was largely due to the Aryans.

The prevalence of this ancient symbol of fertility and life in the cults of India 'shows that in the more naive religion of the older age there was not yet that divorce between the physical and moral world which the spiritual law of modern religion has made' (*CGS* v. 11 f.). It is 'by no means an early or a universal cult. It can only become prominent in a population having a settled abode and cultivating the soil; its orgiastic developments are sporadic' (Hartland, *Primitive Paternity*, i. 122). It seems to be an aberrant form of the cult of stones and pillars which was widely distributed in Greece, and among the Semites (Frazer, *Pausan.*, London, 1898, ii. 539, iv. 110, 154, 318 ff., v. 314 ff.; *CGS* iv. 149, 307; *HDB* iii. 879 ff., v. 110 ff.; art. BAAL, vol. ii. p. 287 f.). Some of the great Indian *liṅgas* have no sexual connotation (cf. *ERE* v. 829 f.). Thus, that at the

shrine of Yājñisvara at Benares is 'simply an enormous block of stone, round and black, six feet in height, and twelve in circumference' (Sherring, *Sacred City*, p. 117). That of Bhojpur in Bhopāl is 7½ feet high and 17 feet 8 inches in circumference, raised on a massive platform (*IGI* viii. [1908] 121). The kindred pillar-cult is, as A. J. Evans has shown, widely distributed (*JHS* xxi. [1901] 99 f.). One of the pillars of Aśoka at Benares (*ERE* ii. 466) has now become the famous *lāt*, or pillar, of Śiva. The symbol, in itself, is not necessarily indecent (Rājendralāla Mitra, *Indo-Aryans*, i. 146 f.; *IGI* xviii. 202). Among the Śaivas it is not connected with eroticism, a tendency distinctly absent from the cult of Śiva. This, however, refers only to the devotees of the higher class; and, when it is worshipped in connexion with the female symbol (*yoni*), or among the Līngāyat (*q.v.*) sect in the Deccan, it undoubtedly has a sexual suggestion (cf. Elliot, *Hist. of India*, iii. 91; Hartland, *Primitive Paternity*, i. 123). Its connexion with Śiva may probably be traced to his manifestation as a god of reproduction, as, for instance, when he appears as Mṛtyuñjaya, 'destroyer of death.' Even in the Veda, he, as Paśupati, 'lord of beasts,' a title of Rudra, is regarded as the agent promoting fertility in cattle (Macdonell, *Vedic Myth.*, 75). In parts of the Deccan, as a mode of mimetic magic, the marriage of Śiva and Pārvatī is periodically celebrated (*BG* xxiii. [1884] 676; V. A. Smith, *Hist. of Fine Art in India and Ceylon*, p. 215; cf. *CGS* v. 217; Frazer, *GB*² ii. 204 ff.), and in parts of the Central Provinces he seems to be connected with tree-worship (*ERE* iii. 312). The same conception doubtless underlies his manifestation as Ardha-nārīśvara, half male and half female, symbolizing the union of Puruṣa and Prakṛiti, the central idea of Nature-worship (see *ERE* ii. 38^b). We may also compare the phallic processions which occasionally accompany the Holi celebrations in India, as in the cult of Nathurām at Gwālīor (Crooke, *PR*² ii. 319 f.), the φαλλοφορία of the Dionysus worship in Greece, 'which arises from the same idea as that which prompts the corporeal union of the husbandman and his wife in the cornfield at the time of the sowing or after reaping' (*CGS* v. 197, 205; Frazer, *GB*² ii. 205 ff., *GB*³, pt. i. vol. ii. p. 97 ff.). The story of Viṣṇu cutting up and scattering the fragments of the *liṅga* throughout the world reminds us of the mutilation of Osiris, and the Kandh custom of distributing the ashes of the human representative of the spirit of vegetation as a fertilizing charm (Frazer, *Adonis, Attis, Osiris*², London, 1907, p. 331; *CGS* iii. 19 f.). As in the case of other gods of fertility, the bull is the appropriate emblem of Śiva (Frazer, *Adonis*, pp. 96, 130, *GB*² ii. 312, 277 ff.; *CGS* iii. 11, v. 97; Jastrow, 632; Wiedemann, 178 f., 187 f.). The conception, also, of the phallus as a protective (*ἀπορροπαιον*) may, as in the case of the Greek *Hermis*, have contributed to its popularization (*CGS* v. 32). On the worship of the *liṅga* in India, see Muir, iv. 343 ff.

23. The popularization of the cult of Śiva.—The popularization of the cult of Śiva involved a process of syncretism, the adoption of various local deities as his manifestations. The most respectable of these is Gaṇapati, or Gaṇeśa, lord of the troop of demons attending the god. His worship starts from the Paurāṇic period; and, except in one legend contained in the northern recension of the *Mahābhārata*, he does not appear in the Epic literature (*JRAS*, 1898, p. 380 ff.). His symbols of the elephant and the rat connect him with some local theriolatry; but he is now independent, and, though he is a member of the Śaiva group of deities, he has become almost non-sectarian, and all sects agree in doing him honour as the god of

luck (*IA* xxx. 255 f.; cf. BRĀHMANISM, vol. ii. p. 807 f.). Another deity of the same class is Skanda, or Kārttikeya, who was the family-god of some W. Indian dynasties, and now, under the name of Subhramanya, is most popular in S. India, where his association with the Mother-goddesses shows that he is connected with non-Aryan cults (*BG* i. pt. ii. pp. 180, 287; Oppert, 303, 370). In a much lower class is Khaṇḍobā, or Khaṇḍerāv, 'sword father,' probably a deified non-Aryan prince, now the chief guardian-deity of the Deccan, where his cult shows obvious signs of contamination with those of the forest tribes (*BG* xviii. pt. i. pp. 290, 413 f.). Similar instances are to be found in the identification of Śiva-Viṣṇu as Harihara with the non-Aryan Aiyānār, or Vetāla, the demon-leader and ghost-scarer of the Tamil, Kanarese, and Deccan peoples (*ib.* xxiii. [1884] 556, xviii. [1885] pt. iii. pp. 347, 388).

24. The yoga and asceticism.—The system of *yoga*, by which, through strange postures, suppression of the breath, self-restraint, and meditation, the soul seeks union with the Supreme World Spirit, was an outgrowth of the Sāṅkhya philosophy, and, though dogmatically no part of the Vedānta, reached its fullest development under Patañjali about the 2nd cent. B.C. In the time of Buddha it was recognized, as it continues to be in the later forms of Buddhism, and the condition of ecstatic abstraction was held in high esteem (H. Kern, *Manual of Indian Buddhism*, 11; Macdonell, *Hist. Skr. Lit.*, 396 ff.; L. A. Waddell, *Buddhism of Tibet*, 126, 141). It assumes special prominence in the *Mahābhārata* epic, where concentration, with the use of magical formulæ, supersedes the power of the sacrifice (see artt. YOGA, ASCETICISM [Hindu], vol. ii. p. 87 ff.; AUSTERITIES, vol. ii. p. 225 ff.; BRĀHMANISM, vol. ii. p. 802 f.).

The development of asceticism in its coarser forms is one of the main contributions of Śaivism to modern Hinduism. It represents, in a measure, a revolt against the tyranny of caste. It has its literary origin in the Brāhmanical rule which divides life into a series of stages (see *ERE* ii. 802); and the life of the ideal ascetic served as a model for the rules regulating the conduct of the ordained monks of the Buddhist and Jain orders (Manu, vi. 41; Kern, 73 ff.; Bühler, *Indian Sect of the Jainas*, 1903, p. 13 f.). Perhaps the closest imitation of the observance of the stringent rules of ancient asceticism is to be found in the remarkable colony of Tibetan hermits at Shigatze (Waddell, *Lhasa and its Mysteries*, London, 1905, p. 234 ff., *Buddhism of Tibet*, 223 f.). At the present day, among some of the Śaiva orders instances are found of genuine asceticism carried on according to the ancient rule in caves and forests; but such enthusiasts are not numerous. Occasionally at bathing fairs and places of pilgrimage may be observed the Ūrdhvaśū, who extends one or both of his arms above his head until they become fixed in that position; the Akāśamukhin, who keeps his neck bent back gazing on the sky; the Bhūmimukhin, who hangs by his feet with his head nearly touching the ground; the Nakhin, who allows his nails to grow to an excessive length; those who recline on a couch studded with nails; and others of the same kind who present an obvious parallel to the early Christian hermits, the social and religious results of such excessive devotion being in both cases equally disastrous (J. C. Oman, *Mystics, Ascetics, and Saints of India*, London, 1903 [useful so far as the personal experience of the writer goes]; artt. CELIBACY [Indian]; BRĀHMANISM, vol. ii. p. 801 f.).

25. Development of the cult of Śiva.—We know little of the early development of the cult of Śiva.

The Sibæ of the Panjâb, according to Megasthenes, who visited India about 20 years after the death of Alexander the Great, branded their cattle with the trident symbol of the god, or rather perhaps with the mark of the club of Hercules, who was identified with him (McCrintle, *Anc. India as described by Megasthenes*, 1877, p. 111; *JRAS*, 1907, p. 967). Bardesanes, who seems to have lived in the beginning of the 3rd cent. A.D., and whose account is preserved by a late compiler, Johannes Stobaios (c. A.D. 500), apparently describes the worship of the god in the hermaphrodite form of Ardhanārīśa (McCrintle, *Anc. India as described in Classical Lit.*, 172 f.). His image, attended by that of his bull Nandi, with the noose, trident, and other symbols, appears on the coins of the Kuṣān kings Kadphises II. (c. A.D. 90-100) and Vāsudeva (A.D. 185-226). In the 3rd cent. his cult seems to have been established throughout India (*JRAS*, 1907, p. 972). In S. India, Śaivism was the oldest form of Brāhmanism, and its rise is connected with a teacher named Lakulīśa, as far back as the first century of our era (Rice, *Mysore and Coorg*, 205; cf. D. R. Bhandarkar, *JRASBo* xxii. [1910] 151 ff.). At a later period his worship was adopted by Śaśānka, king of Bengal, who persecuted the Buddhists, and by the emperor Harṣa, both of whom reigned early in the 7th cent. A.D. (Smith, *Early Hist.*², 285 f., 318 f.).

The popularization of the cult was the work of a series of missionary preachers, who, like the founders of the revived Vaiṣṇavism, came from S. India, where Hinduism, comparatively safe from the inroads of the foreigner, was allowed to follow the natural course of its evolution undisturbed. This is shown by the greater abundance of the inscriptions surviving in that region, where the Muhammadan powers, remote from the centres of fanaticism in the N., were less hostile to Hinduism, and did less damage to the temples and the records in stone (*JA* xxx. 17).

The first of these teachers was Kumārila Bhaṭṭa, a learned Brāhman of Bihār, who in the 8th cent. A.D. restored the ancient Vedic rites, and encouraged the persecution of Buddhists and Jains—a tradition which has magnified into the extermination of Buddhism from the Himālayas to Cape Comorin. A follower of the Mīmāṃsā school, he ascribed the universe to a Divine act of creation, and assumed an all-powerful Deity as the cause of the existence, continuation, and destruction of the world. He adopted, as a philosophical argument in opposition to Buddhism, the Vedānta principle of the non-duality (*advaita*) of the God-head. His mantle fell upon his more famous disciple, Śaṅkarāchārya (c. A.D. 737-769), who moulded the Uttara-mīmāṃsā philosophy in its final form (*Srī Śaṅkarāchārya: His Life and Times, his Philosophy*², by C. N. Krishnaswami Aiyer and Pandit Sitanath Tattvabhushan, Madras, n.d.; *Census Report Travancore*, 1901, p. 101 f.; L. K. Anantha Krishna Iyer, *Cochin Tribes and Castes*, ii. [1912] 256 ff.).

'He seems to have risen as an inspired genius to throw a quick, bright light, like to the momentary after-glow of an Indian sunset before darkness descends over the land, on the fading glories of Aryanism before they sink into the dimness of the great days of Hinduism. . . . According to the teachings of Sankara, the entire system of Vedāntic thought finds its natural culmination in an uncompromising declaration that the sole object of the sacred literature of India was to reveal the delusive appearance of what appeals to the senses as reality and the doctrine of non-duality. . . . The question of metaphysics is solved, not as Kant resolved it, by referring all objective reality to perceptions of the intellect where he sought a solution, but in endeavouring to pierce, in the manner of Plato, and Parmenides, beyond the reality itself. This objective form was held by Sankara to be but the mode in which the delusion of life was mirrored forth' (R. W. Frazer, *Literary Hist. of India*, 1898, p. 826 f.).

To him is due the foundation of the Smārta sect among the Brāhmanas of the Deccan, who take their

name from their adherence to authoritative tradition (*smṛiti*), as opposed to the Vedic Scriptures (*śruti*). They worship the Triad, Brahmā, Viṣṇu, and Śiva, under the symbol of the mystic syllable Om; and while admitting these three deities they exalt Śiva to the highest place. They hold the pantheistic Vedānta doctrine of non-dualism (*advaita*), asserting God and matter to be identical, and everything only an atom of the Divine, they themselves being part of the Supreme Being (Rice, *Gazetteer of Mysore*, 1897, i. 236, 471 ff.).

But these Brāhman movements were too philosophical to be comprehended by the common folk; and the real popularization of Śaivism in S. India was left to the Brāhman Basava, as he is called in the Liṅgāyat Purānas, the date of whose death is fixed by tradition in A.D. 785. But it has recently been discovered that the real founder of this sect was the Brāhman Ekāntadarāmayya, who revived Śaivism in its popular form in the latter half of the 12th cent. A.D. (*JA* xxx. 2; *BG* i. pt. ii. p. 225 ff.; Rice, *Gaz. Mysore*, i. 476, *Mysore and Coorg*, 206). The Liṅgāyats (*q.v.*) may be described as Hindus who deny Brāhman ascendancy, and claim to receive from their own priests (*jaṅgama*) the 'eightfold protection' (*aṣṭavarṇa*), or, as others term the rite, 'the eightfold sacrament' (*aṣṭavarṇa*). With the denial of Brāhman ascendancy they have discarded other orthodox rites, such as the cremation of the dead (for which they substitute inhumation) and the observance of caste, pilgrimages, and penance. As is so often the case with such movements in India, there appears now to be a tendency among them to revert to orthodox Brāhmanism (Rice, *Gaz. Mysore*, i. 476 f.; *Census Report Bombay*, 1901, i. 180 ff., 197; *Census Report Mysore*, 1901, i. 530 ff.; *BG* xxiii. 219 ff.).

26. Vaiṣṇavism.—In one sense the cult of Viṣṇu may be regarded as in direct antithesis to that of Śiva. Like the latter, it has its philosophical side. Viṣṇu 'impersonates the higher evolution; the upward tendency of the human spirit. He represents several great and far-reaching religious ideas. In the increasing flux and change of all things he is their Preserver; and although he is one of the highest gods, he has constantly revisited the earth either in animal or in human shape' (Lyall, *Asiatic Studies*², ii. 306). In the Veda he occupies a subordinate position, his only anthropomorphic traits being the strides which, as a solar god, he takes across the heavens (Macdonell, *Vedic Myth.*, 37). He is closely related to Indra, but his connexion with Kṛṣṇa is still obscure (Weber, *JA* xxx. 284 f.; see BRĀHMANISM, vol. ii. p. 811 f.). The historical evolution of this deity has, however, exercised little effect on the view of his personality held by his modern worshippers. His cult is less gloomy, less tinged with asceticism, more kindly, more human, than that of Śiva; and it has found its expression 'in more striking literary works, which, translated into, or rather reproduced in, the principal languages, Aryan as well as Dravidian, have furnished an inexhaustible quarry for popular poetry' (Barth, 216 f.). Its eclecticism is clearly marked. Its theory of incarnations or descents (*avatāra*) at once links it to Vedic mysticism and at the same time permits it to absorb the deities, with their cultus, or the non-Aryan racial elements out of which Hinduism was developed. The doctrine of incarnations is peculiar neither to Hinduism nor to Vaiṣṇavism. But in the latter the conception of a god becoming incarnate through compassion for suffering meets the needs of worshippers craving for a personal God who sympathizes with the sorrows of humanity (see BHAKTI-MĀRGA, vol. ii. p. 542 f.; *JRAS*, 1908, p. 245 ff.). There is no reason to refer this animal cultus to totemism, which appears among the Indo-Aryans, if at all.

only in aberrant form (J. G. Frazer, *Totemism and Exogamy*, London, 1910, iv. 13). More probably the animal cultus sprang from the Aryan or non-Aryan theriolatry, the sacred animals being 'regarded in relation to a more generalized conception of the Divine power, which lies behind them and finds expression through them' (*HDB* v. 114). As Sayce points out in the case of Babylonia (*HL*, 112), the local god was originally theriomorphic, and when he assumed an anthropomorphic shape there was no room for the primitive animal forms save as the vehicle (*vāhana*) or attendant of the god. To the modern believer it is sufficient to be told that the god assumed these successive forms to save mankind from ever recurring attacks of the forces of evil.

It is in his later developments that the influence of the non-Aryan races is most apparent. On this question Molony (*Census Report Madras*, 1912, i. 51) remarks:

'Whatever be their present-day union or interminglement, it is difficult to imagine any original connection of the Aryan Brāhmins, and their subtle philosophies, with the gross demonolatry of the Dravidian peoples who surrounded them. Philosophic Hinduism or Brāhmanism, it has already been suggested, is rather the attempt to find an answer, without the aid of a final revelation, to an enigma probably insoluble, than a religion in the sense understood in modern days. Holding certain philosophical opinions, which they neither expected nor particularly desired their Dravidian neighbours to share, it is unlikely that the early Aryan theists made any serious efforts to obtain adherents to their way of thinking. But, satisfied with the acknowledgment of their undoubted intellectual superiority, they built gradually many a connecting bridge between their own somewhat unpractical speculations and the extremely material demonologies of the Dravidians.'

There is some force in this statement; but, when the Brāhmins, at some period subsequent to their arrival in S. India, seriously undertook the task of absorbing the local idolatries, the result of the compromise was that at the present day, except among special groups like the Nāmbūtiris, Brāhmanism survives merely as a veneer over the indigenous beliefs. This process of absorption assumed varied forms. Thus in the Deccan and S. India, Viṭhobā, or Viṭthal, of Pandharpur (*q.v.*), who is generally believed to have been a deified Brāhman, is accepted as an incarnation of Viṣṇu. It has been suggested that his name is derived from Viṣṭu, a form of Viṣṇu, modified under Dravidian influence (*JRAS*, 1907, p. 1053). So Bālajī, usually identified with the infant Kṛṣṇa, is now the great god Vyaṅkaṭeśa of Tripetty, or Tirupatti (*q.v.*), and is claimed to be a local deified saint. The same process appears in the Himālaya, where Vāsudeva or Bāsdeo and Puruṣottama, 'best of men,' are believed to be mountain-deities absorbed into the Viṣṇu cultus (Atkinson, *Himalayan Gazetteer*, ii. 752; Muir, iv. 297). In Travancore, under the title of Padmanābha, 'he from whose navel springs the lotus,' he is at Trivandrum connected with a serpent-cult. In A.D. 1752 the Mahārājā dedicated his royal person and kingdom to this his tutelary god, and at his succession his first official title is that of Śrī Padmanātha, 'slave of the god' (S. Mateer, *Land of Charity*, London, 1871, p. 160 ff.; *State Manual Travancore*, i. 362).

These local manifestations, however, are of small importance compared with Rāma and Kṛṣṇa. Their cults present so many intricate problems that the consideration of them must be left to special articles. The influence of Christianity on their development is discussed in art. BHAKTI-MĀRGA, vol. ii. p. 549 ff.; also see BRĀHMANISM, vol. ii. p. 811 f.; J. Kennedy, *JRAS*, 1907, p. 951 ff.

27. The popularization of Vaiṣṇavism.—As was the case with Śaivism, the popularization of the Vaiṣṇava cultus was the work of several missionary teachers, and in this case also the inspiration came from S. India. The first of these teachers was Rāmānujāchārya, also called Emburumānār, who,

according to the common tradition, was born at Śrī Permatūr about A.D. 1127, and, after a life which is said to have extended to 120 years, was buried in the temple of Śrīraṅganātha at Trichinopoly, where a shrine has been dedicated to him.

'The chief religious tenet of the sect of Rāmānujas or Śrī Vaiṣṇavas is the assertion that Viṣṇu is Brahmā, that he was before all worlds, and was the cause and creator of all. Although they maintain that Viṣṇu and the universe are one, yet, in opposition to the Vedānta doctrines, they deny that the deity is void of form or quality, and regard him as endowed with all good qualities and with a two-fold form—the supreme spirit, Paramātma or cause, and the gross one, the effect, the universe or matter. The doctrine is hence called *viśiṣṭadvaita*, or doctrine of unity with attributes. Besides his primary and secondary form as the creator and creation, the deity has assumed at different times particular forms and appearances (*avatāra*) for the benefit of his creatures' (Rice, *Gaz. Mysore*, i. 475; cf. Monier-Williams, *Brāhmanism and Hindūism* 4, 119 f.).

His teaching is followed by the Śrī Vaiṣṇava sect in N. India, who hold that Viṣṇu, the one Supreme God, though invisible as cause, is, as effect, visible in a secondary form in material creation. They are the most respectable of the reformed Vaiṣṇava communities, and show their adherence to the more primitive tradition in their refusal to worship Rādhā, the consort of Kṛṣṇa. They are divided into two sections—the Southerners (*Tengalai*) and the Northerners (*Vadagalai*),

'who differ on two points of doctrine, which, however, are considered of much less importance than what seems to outsiders a very trivial matter, viz., a slight variation in the mode of making the sectarian mark on the forehead. The followers of the Tengalai section extend the middle line down to the nose itself, while the Vadagalai terminate it exactly at the bridge' (F. S. Growse, *Mathura* 3, Allahabad, 1883, p. 193 f.; *State Manual Travancore*, ii. 292 f.; Monier-Williams, 125 f.; Thurston, *Castes and Tribes*, i. 348 f.).

The second Vaiṣṇava teacher was Mādhva or Ānandatīrtha, a S. Indian Brāhman, who was born at Udipi in S. Kanara about A.D. 1200. The result of his teaching was to effect a certain compromise between the cults of Viṣṇu and Śiva, maintaining, however, the supremacy of the former (Rice, *Gaz. Mysore*, i. 236, 477). He taught the existence of Viṣṇu, or Hari, and the doctrine of duality (*dvaita*) in opposition to the monism or non-duality (*advaita*) of Śaṅkarāchārya. He held that 'there are two separate eternal principles (instead of three, as asserted by Rāmānuja), and that these two are related as independent and dependent, as master and servant, as king and subject. The one is the independent principle, God (identified with Viṣṇu), the other is the dependent principle consisting of the human spirit, or rather spirits' (Monier-Williams, 130 f.; see C. N. Krishnaswami Aiyer, *Sri Madhva and Madhvaism*, n.d.).

The third and most important agent in the spread of Vaiṣṇavism in N. India was Rāmānanda, of whom little is known, even his date being uncertain. He seems to have lived between the end of the 14th and the first half of the 15th cent., and the distinctive note of his teaching was the exaltation, as a form of Viṣṇu, of Rāma and his consort, Sītā (M. A. Macauliffe, *The Sikh Religion*, Oxford, 1909, vi. 100 ff.). His followers are closely connected with the school of Rāmānuja, except that they are not so exclusive in regard to privacy at meals (*Census Report Baroda*, 1911, i. 77; *BG* xv. [1883] 176; *PR* 2 i. 293). The name Rāmānandī is now usually given to a branch of the Bairāgis (*q.v.*). In fact, until the missionary career of Rāmānanda, this order had little importance, and it has been suggested that his teaching represented a revolt of the more liberal northern school against the older and stricter leaders. He advocated the principle that all personal distinctions of rank or caste merged in the holy character (Rice, *Gaz. Mysore*, i. 477 f.). He seems to have admitted members of the lower castes to his sect—a privilege which most teachers reserved to the Brāhman and Kṣatriya. Thus the movement was essentially popular, and the books published by this school were written in Hindī, not in Sanskrit—a

reform which led to important results throughout N. India, and especially in the Punjab (*Census Report, Punjab*, 1891, i. 122 f.; *Census Report, Baroda*, 1911, i. 77; *BG xv.* [1883] 175).

28. The Muhammadan conquest.—The course of the evolution of Hindu beliefs was rudely interrupted by the Muhammadan conquest of N. India.

The history of the new power which appears upon the scene falls roughly into three periods: first, a time of incursions ending in final conquest (A.D. 637-1206); that of the kingdoms founded as a result of the first conquest (1206-1526); and, lastly, the Mughal Empire, which finally passed away when British ascendancy was established. During the earliest period the Muhammadan annals abound in descriptions of ruthless massacres of Hindus, of destruction of their temples and other religious institutions. In A.D. 1024, Mahmūd of Ghazni penetrated Kāthiāwār and destroyed the famous Somnāth (*q.v.*) temple. Quṭb-ud-dīn (1206-10) captured Benares, destroyed nearly a thousand temples, and raised mosques on their foundations (Elliot-Dowson, *Hist. of India*, 1867-77, ii. 223). Alā-ud-dīn (1296-1316) sacked the temple city of Bhilsa, and sent the idols to one of the gates of Delhi to be trodden under the feet of true believers (*ib. ii.* 148). Even Firūz (1351-88), more merciful than many of his predecessors, prides himself on destroying temples and torturing unbelievers (*iii.* 380). The invasion of Timūr in A.D. 1398 was accompanied by massacre and rapine at Hardwār and other places (*iii.* 394 f., 501 ff.). It was not till the reign of the great Akbar (*q.v.*) (1556-1605) that the faith of his Hindu subjects was deemed worthy of protection. This change of policy was due mainly to his laxity on questions of Musalmān orthodoxy, to his religious eclecticism, when he dallied with Hindu Paṇḍits, Parsi priests, and Jesuit missionaries, dreaming of a new religion which was to reconcile the many creeds of his Empire, and to his statesmanlike desire to conciliate the powerful Rājput tribes (Blochmann-Jarrett, *Āin-i-Akbarī*, Calcutta, 1873-94, i. 162 ff.). His son and grandson were too indifferent to religious questions, and too dependent upon the support of their Rājput kinmen, to engage in a crusade against Hinduism. This was not renewed until the accession of the Puritan iconoclast, Aurangzib (*q.v.*) (1659-1707), who ordered the destruction of Hindu temples, such as that of Keśava Deva at Mathurā (*q.v.*), that of Adī Deva at Brindāban (*q.v.*), and the Adī Viśveśvara shrine at Benares (*q.v.*), on the ruins of which rose the stately mosque which now overlooks a myriad Hindu temples (Growse, 34 f., 37, 265; Sherring, *Sacred City*, 316 ff.). In early Muhammadan times it is not too much to say that every great mosque was erected from the materials of ruined shrines of the older faith of Hindu or Jain, such as that adjoining the Quṭb Minār at Delhi, those at Kanauj, Ajmer, Jaunpur, and many other places (Fergusson, *Hist. of Ind. Arch.* 502, 510, 521, 540; *JASB* xlv. 190 f.). Some of the kings of the Aḥmadābād dynasty also spread the faith in Gujārāt by persecution (*BG ix.* pt. ii. p. 4 f.). But the Muhammadan dynasties of S. India were more tolerant, and their rulers lived on good terms with the Marāṭhas of the Deccan.

But it is possible to exaggerate the destructive effect upon Hinduism of the Muhammadan invasions. Persecution and the competition of the new creed stimulated religious activity among the Hindus, and during the Muhammadan period various spiritual teachers arose, new sects were formed, and theological controversies divided the intellectual classes—a revival to which the early Muhammadan rulers seem to have been generally indifferent (Lyll, *Fortnightly Review*, Nov. 1908, p. 729). The numerous conversions to Islām were not so much the fruit of active persecution as the result of a desire to gain the favour of the Court, or of missionary teaching (T. W. Arnold, *The Preaching of Islam*, London, 1896, p. 208 ff.). It is also significant that at the present day the proportion of Muhammadans is comparatively small in the neighbourhood of the chief centres of Mughal power—Delhi, Agra, and the cities in the Bengal Delta. The explanation is that, in the neighbourhood of the great Muhammadan cities of N. India, Islām was confronted by the powerful Rājput tribes, devoted to their ancestral faith, and offering strong resistance to proselytism, in which they were supported by their marriage alliances with the Mughal princes. In E. Bengal the animistic tribes had imbibed little of the tenets of Hinduism, and were ripe for conversion by the missionary agents of Islām. Hinduism would have collapsed during the reign of Aurangzib had it not been protected by Rājputs and Marāṭhas. Outside Rājputāna and the Deccan its strength lay in its amorphous character. Buddhism collapsed when its monasteries were

burnt and its monks slain. But Hinduism possessed no single administrative body, no centre of religious life, the destruction of which might have involved a general collapse. It survived because it depended upon its caste and tribal organization; because it represented the basis of social life, with its perpetual round of ceremonial observances; because it possessed a great and indestructible religious literature.

29. The influence of Islām on Hinduism and of Hinduism on Islām.—The contact of these two great religions profoundly affected the evolution of both. The pure monotheism of Islām, which became the State religion of N. India, could not fail to exercise influence on Hinduism. At this time, also, Christian and Jewish teaching began to affect Hinduism. It is significant that the Śaiva and Vaiṣṇava missionaries came from the S. and W. of the Peninsula, where Arab, Jewish, and Christian communities first settled; and Islām in S. India has adopted many Hindu practices—worship of local deities, the black art and divination, rites of birth and marriage (*Census Report Madras*, 1912, i. 54). Some are inclined to believe that the theory of fervent faith in the Godhead was derived from Christianity (see BHAKTI-MĀRGA, vol. ii. p. 539 ff.; and on the effect of the dogmas of the Nestorians, see *JRAS*, 1907, p. 477 ff.). On the other hand, by the adoption of beliefs and practices derived from the indigenous Animism, Islām became fitted to enter upon the task, which it still pursues, of establishing itself as the national religion. To foreign influence of various kinds Hinduism was indebted for the effort to suppress the cults of the mythological and sectarian deities, and for the recognition of a single Divine Power, the Almighty Ruler of the universe. It must also be remembered that Persia contributed to Indian Muhammadanism that form of mysticism or super-sensuous knowledge, that influence which diverts emotional souls from the insight which they hope to attain through the veil of illusion into the deeper mysteries which lie behind it. The origin of this belief, known as Śūfiism, is obscure. Some have regarded it as a revolt of the Aryan spirit against a Semitic religion imposed by force of arms upon a conquered people; to others its wide diffusion in India at an early period of its development suggests that it was home-born; others, again, connect it with Buddhist preaching (E. G. Browne, in *Rel. Systems of the World*, 315 ff.; *JRAS*, 1904, p. 125 ff.; and for the influence of Buddhism, *EBr*ⁱⁱ, xxvi. 31 f.). At any rate, if it was not ultimately derived from the principles of the Vedānta preached in W. Asia by Brāhman or Buddhist teachers, it was so closely allied to the Indian pantheism that it was readily assimilated on Indian soil. Whether, as E. G. Browne observes (p. 317), 'its practical part, its quietism, its renunciation of worldly objects, its passionate longing for closer commune with God, preceded, and, indeed, led to its theoretical part, its pantheism, its idealism, its scorn of outward forms, its universal tolerance,' or not, the doctrine was well adapted to the needs of the prophets of the reformed Vaiṣṇavism. Their teaching, as well as that of Kabīr and Nānak, seems to have been largely indebted to it.

30. The spread of Vaiṣṇavism.—The results of these religious and political movements led to the popularization of Vaiṣṇava doctrine, which has continued to the present time, when it has become the working force in Hinduism. Its predominant note is the growth of a democratic feeling tending towards universal comprehension. Many sects were founded by men of the lower castes, Kabīr the weaver, Senā the barber, Rāmdās the tanner. While the movement was in many ways healthful and inspiring, it resulted in the toleration of the

abuses which contaminated Vaiṣṇavism in its later stages. It also encouraged a more personal tone in the teaching of the reformers. The Śaiva sects, which are differentiated more by distinctions of practice than of theology, as a rule, take impersonal titles. The Vaiṣṇava sects, on the contrary, are often named from their founders, and, as a necessary consequence, there is a constant tendency to exalt the founder to a position of divine or semi-divine authority, in which the worship of the Deity becomes of secondary importance.

Kabir (c. A.D. 1488-1512), one of the twelve disciples of Rāmānanda, has become one of the most prominent figures in the popular Hinduism of N. India. His career illustrates the eclecticism of Hinduism. His leaning towards Islām was no bar to his becoming a Hindu *bhakta*, and his writings display a wonderful combination of beliefs drawn from Christianity, Sūfiism, and Vedāntism (*JRAS*, 1908, p. 245 ff.). The result of his attempt to fuse Hinduism with Islām is that in Bombay some of his followers describe themselves as Hindus, some as Muhammadans (*Census Report*, 1901, i. 61; cf. *Census Report Panjāb*, 1912, i. 121 f.). As in other reform movements of the same kind, his later followers have not maintained the ideal of their founder. They now occupy a position between idolatry and monotheism, and some of them have almost completely succumbed to Brāhman influence. Among the peasantry of the present day Kabir retains his authority as a hymnist more than as a religious reformer. His racy religious and moral apophthegms are constantly on the lips of the middle-class Hindu. They inculcate a pure and tender morality which has strongly affected popular feeling. To his writings the Ādi-granth, the Scripture of the Sikhs, is largely indebted. (See KABIR; G. A. Grierson, *Modern Vernacular Literature of Hindustan*, Calcutta, 1889, p. 7 f.; G. H. Westcott, *Kabir and the Kabir-Panth*, London, 1908; Macauliffe, *The Sikh Religion*, vi. 122 ff.)

31. Vaiṣṇavism in Bengal.—Another side of the Neo-Vaiṣṇavism is shown in the teaching of Mirā Bāi, a prophetess who was born about A.D. 1504, and preached the doctrine of fervent faith in Kṛṣṇa in its most ecstatic form (Grierson, 12; Macauliffe, vi. 342 ff.; H. H. Wilson, i. 136 ff.). This form of mysticism found a congenial soil in the Bengal Delta, among an emotional race little affected by Aryan influence, and steeped in Animism.

The leader of this movement was Chaitanya, born two years after Luther (A.D. 1484-1527). He taught the sufficiency of faith in the divine Kṛṣṇa and his consort Rādhā; and the only form of worship prescribed was the repetition of the name of the Deity without any concomitant feeling of genuine devotion. This creed naturally found acceptance among the sensuous people of Bengal, who still retained some leaning towards Buddhism, were depressed by the results of long-continued social disorder, and had no alternative but to accept either Śāktism or Animism. The stress laid by Chaitanya on ecstatic devotion towards Kṛṣṇa and Rādhā had encouraged sensuality, and the Bairāgi Vaiṣṇavas of Bengal have acquired such an evil reputation that Vaiṣṇavi, the title of the female members of the order, has become synonymous with courtesan (Wise, *Notes on the Races, Castes, and Trades of E. Bengal*, 1883, pp. 154, 162). For Chaitanya and the Vaiṣṇavas of Bengal, see *Calcutta Review*, xv. [1851] 169 ff.; E. A. Gait, *Census Report Bengal*, 1901, i. 182 ff.

32. The adoration of the guru.—The slavish adoration of the spiritual teacher (*guru, gosāin*), though no part of the original teaching of Chaitanya, who held that the Deity was all in all, and the teacher only the spiritual father of his flock, is the essence of this type of modern Vaiṣṇavism;

and the worship done to him differs in no way from that addressed to the Godhead (see *ERE* ii. 546). Respect for the *guru* is not a modern idea, because it was inculcated by Manu (ii. 130, iv. 251 f., xi. 1, ix. 235 ff.). Such reverence, however, when paid by the pupil, ceased on the completion of the term of religious training.

'From the twelfth century, on the contrary, the founder rises to the rank of Buddha or Jina; he becomes what the Prophet or the Imams are for the Moslem, a revealer, a supernatura' saviour. He is confounded with the god of whom he is an incarnation. Like him, he is entitled to *bhakti* [devotion]; and if the sect admits of a traditional hierarchy, his successors share more or less in the same privilege. Rāmānuja, Rāmānanda, Anandātirtha, Bāsava, and many others who established subordinate divisions, or who have been distinguished saints or poets, were from an early date regarded as Avatāras [incarnations] of the deity' (Barth, 229).

The same pretensions are now displayed by some of the Bengali *gurus*, and, in particular, by those of the Vallabhāchārya sect, whose headquarters are at Gokul (*q.v.*). Similar claims made by the Śaiva *gurus* in Madras are fully described by Dubois (p. 123 ff.). In more recent times their authority has much decreased.

The great heresiarch, Vallabhāchārya, a Brāhman from S. India, was born in A.D. 1478; gained his first triumphs as a disputant at Vijayanagar; visited all the holy places in N. India; and at Brindāban (*q.v.*) saw Kṛṣṇa in a vision, who directed him to establish a new cult of Bālakṛṣṇa, or Bālgopāl, the god in the form of a boy cowherd, which is the form of worship still most popular among the members of the sect. This cult seems to have been later in date than that of Kṛṣṇa as a hero, from which it appears to have developed (J. Kennedy, *JRAS*, 1907, p. 975 ff.). In his later years Vallabhāchārya renounced the ascetic life, married, became the father of sons, and died at Benares A.D. 1531. His followers are the Epicureans of the East, and frankly avow their belief that the ideal life consists in social enjoyment (*puṣṭi-mārga*, 'the primrose path of dalliance'), rather than in solitude and self-mortification. The doctrine of the sect which has specially aroused popular resentment is the deification of the *guru*, with the corollary that his devotees, in body, soul, and substance (*tan, man, dhan*), are at his disposal, this rule being enforced specially in the case of the female votaries. The sect is found in the largest numbers at Gokul and in the commercial cities of W. India. At Bombay the immoralities of their leader, the Mahārājā, were exposed during a famous trial in 1861 ([Karsandās Mūlji], *Hist. of the Sect of the Maharajas in W. India*, London, 1865; *BG* ix. pt. i. p. 555 ff.; *Census Report Baroda*, 1912, i. 77 f.). The same criticism applies to another sect of wandering beggars in W. India, known as Mānbhāv (Skr. *mānubhāva*, 'respected'); and this evil reputation is enhanced by the contempt in which they are held by the Brāhman who serve the orthodox gods (*BG* xiii. pt. i. p. 199, xvii. 181 ff.; art. CELIBACY [Indian]).

33. The Śāktas.—This licentious type of Hinduism appears still more clearly in the form of Śāktism, the worship of the active female principle (*prakṛiti*) as manifested in one or other of the forms of the consort of Śiva—Kālī, Devī, Pārvatī, and many others. The general character of this, the most debased side of Hinduism, is fairly well known; but comparatively little study has been devoted to it by European scholars, and the secrecy under which its rites are celebrated ensures that its mysteries are revealed to none but the initiated. It is believed that the Tāntrik ritual and beliefs are older than the age of the Buddha (*JRAS*, 1904, p. 557); but in its present form it seems to have been popularized among the sensuous population of Assam and E. Bengal about the 5th cent. A.D.

On the one hand, it has been supplied with a philosophical justification, being a popularized version of the Sāṅkhya principle of the union of the soul of the universe (*puruṣa*) with the primordial essence (*prakṛiti*). It regards the self-existent Being as not only single, solitary, and impersonal, but also quiescent and inactive. Once it becomes conscious and personal it is duplex, and acts through the associated female principle which, again, is conceived to be possessed of a higher degree of activity and personality. Combined with this is a literal and misconceived interpretation of various passages in the Veda, in which the will and power to create the universe are represented as originating from the Creator, as co-existent with Him, and as part of Himself. On this theory, the belief is more closely connected with Saivism than with any other religious system, originates in philosophical Brāhmanism, and traces back its history through Brāhmanism to the earliest Vedic conceptions (Monier-Williams, 180 f.; H. H. Wilson, i. 241 f.; Waddell, *Buddhism of Tibet*, p. 129 f.).

On the other hand, Śāktism has a second and less reputable side, and this is more present to the majority of its adherents than any philosophical speculations and reminiscences of Vedic doctrines. The impersonation of the female energy in the form of Mother Earth appears among the non-Aryan tribes in the cult of the village-goddesses (*grāmadevatā*), some of whom are purely local or tribal, while others, like Kālī or Māriyamma, though they still retain some local characteristics, have become national deities. Even in the Veda, Pṛthivī appears as a kindly guardian-deity (Macdonell, *Vedic Myth.*, 88); but with her, by a process of syncretism, has been associated the non-Aryan Mother-cult, which has been described in the art. DRAVIDIANS.

The progress of this syncretism is indicated in various ways. In the Bādāmī cave-temple, for instance, Pṛthivī is identified with Bhūmi-devī, or Bhū-devī, the Earth-Mother of the non-Aryans, goddess of patience and endurance, who in Manu and in the formal ritual of Brāhmanism receives special adoration (Fergusson-Burgess, 409; Manu, iii. 85 f., ix. 311; Colebrooke, *Essays*, 1858, p. 85). In one of the S. Indian temples, again, Devī appears in the form of a female image in stone, of which the head alone is visible, while the body is still concealed in the earth (Oppert, *Orig. Inhab.* 468). This conception also appears in Buddhist art, where she rises under the feet of the horse of the Master (Grünwedel, *Buddhist Art in India*, 98 ff.); and in the Greek representations of the goddess Ge (Farnell, iii. 25, 27, 55, 216, 223 f., 256, v. 245 f.; J. E. Harrison, *Proleg. to the Study of Gr. Rel.*, Cambridge, 1903, p. 276 ff.). In its benevolent manifestation the cult of the Earth-goddess is shown in that of the Rājput Gaurī, 'the brilliant one,' whose annual marriage to Śvara or Śiva is intended, by a sort of mimetic magic, to stimulate the growth of the young corn (Tod, *Annals of Rajasthan*, Calcutta reprint, 1884, i. 602 ff.; Frazer, *Adonis, Attis, Osiris*², 199 f.). In other cognate manifestations she is known as Sākambhārī, 'herb-nourisher,' or Aśāpūrṇā, 'she who fulfils desire' (BG i. pt. i. p. 158, xxiii. 679 f.; Atkinson, *Himalayan Gaz.* ii. 328; Tod, i. 67).

But, besides these benevolent manifestations, she exhibits more of the non-Aryan feeling when she displays her chthonic and malignant nature. Cults of this class are specially common in S. India. Such is that of Ellamma, 'mother of all,' whose ritual includes animal-sacrifice, and the brutal rite of hook-swinging, intended as a mimetic charm to promote vegetation, the plant springing as the victim rises in the air; Māriyamma, 'plague

mother,' at whose shrine an officiant known as Potrāz, 'ox king,' tears open the throat of a living ram and offers a mouthful of the bleeding flesh to the goddess, as in the frenzy of the cannibal or murderous orgy which was a feature of the Dionysiac ritual (CGS v. 156, 166); or Piḍārī, the Tamil form of the Skr. Viṣahari, 'poison-remover,' a passionate, irascible goddess, with a red-hot face and body, and on her head a burning flame; when drought or murrain prevails, she is propitiated with fire-treading and the sacrifice of a bull; lambs are slain in the route of her procession, and the blood, mixed with wine, is flung into the air to propitiate the powers of evil (*Bull. Madr. Mus.* iii. 265; Oppert, 471 ff., 491 ff.). The cults of these goddesses have recently been carefully investigated by H. Whitehead, bishop of Madras (*Bull. Madr. Mus.* v. 107 ff.; cf. Gopal Panikkar, *Malabar and its Folk*², Madras, 1904, p. 128 ff.; Dubois, 286 f.).

From deities of this class the transition to the orthodox cults of Kālī and Devī, shorn though they may have been of some of their brutality and licence, is easy. A modern orthodox Hindu, however, traces goddess-worship to the Veda, and denies its connexion with Earth cults (*Census Report Panjāb*, 1912, i. 114 ff.).

Devī still retains much of her chthonic character, as when she manifests herself as Vindhyavāsini, the presiding goddess of the Vindhyan hills, or the Saptāśrī Devī of Sāgargad in the Kolāba district of Bombay, who have their homes in caves, and represent the original aniconic cult of the vague, disembodied spirits which haunt mountain-gorges; or when, as in the Panjāb, she is manifested in a young girl, who performs mimetic magic to foster the growth of crops; or when, as in Nepāl, in the form of Kumārī, 'the maid,' she is accompanied by boys representing Gaṇeśa and Mahākāl (Śiva) in his malignant form (*Census Report Panjāb*, 1901, i. 126; Oldfield, ii. 315). Kālī has been adopted into the Mahāyāna Buddhism of Tibet (Waddell, *Lhasa and its Mysteries*, 370). Durgā (*q.v.*) seems to be a non-Aryan goddess imported into Hinduism, and identified with the Vindhyavāsini Kālī (see *ERE* v. 117 ff.). She does not appear, at least by name, in the early Vedic or Brāhmana literature, though there are several prototypes from which she may have been developed, and it is believed that her identification with Kālī took place about the 7th cent. of our era (*JRAS*, 1906, p. 355 ff.). By others she has been connected with Nirṛti, the Vedic goddess of evil—which would account for the malignity of her character (see BRĀHMANISM, vol. ii. p. 813). When she appears seated on a lion, she represents a well-known Oriental type, indicating that these deities

'were originally indistinguishable from the beasts, and that the complete separation of the bestial from the human or divine shape was a consequence of that growth of knowledge and of power which led man in time to respect himself more and the brutes less' (Frazer, *Adonis*², 107).

Śāktism is thus a direct offshoot of the Mother-cults, and it has developed on lines similar to those of Ishtar, Ashtart or Ashtoreth, the Paphian Aphrodite, the Phrygian Cybele, and 'Diana' of the Ephesians.

Closely connected with these is the cult of the divine Mothers (*mātrī*), of whom there are various enumerations, the catalogues including seven, eight, or sixteen (Monier-Williams, *Skr. Dict.*, Oxford, 1872, *s.v.* 'Mātrī'). Each of them is usually associated with one of the greater gods as his female energy. The eight Mothers are represented on the shrine of Gaṇeśa at Kirtipur in Nepāl (Oldfield, i. 130). In Gujarāt, some of them represent the malignant ghosts of Chāraṇ women who perished in some tragic way, the chief of

them being Khoriyār, the embodied curse of the spirit (A. K. Forbes, *Rās Mālā*², 242 f.; *BG* viii. [1884] 643). In Madras also many of the Mothers are of human origin; Gaṅgammā was a Brāhman woman, and Puṅamma one of three sisters who constructed a famous tank (Cox-Stuart, *Manual of N. Arcot*, Madras, 1895, i. 186). Such worship readily develops into that of a single female deity, like Ambā Bhavānī of Gujarāt, who is propitiated by animal-sacrifice and offerings of spirituous liquor, her image being a block of stone rudely hewn into the semblance of a human face (*BG* v. 432 f., ix. pt. i. Introd. xxxv f.; for Mother-worship, see Monier-Williams, *Brāhmanism and Hindūism*⁴, 222 ff.). The cult may be compared with that of *ai theai parēpes* at Enguim in Sicily, which Cicero calls 'augustissimum et religiosissimum fanum' (in *Verr.* iv. 44, v. 72), and the *Deæ Matres* of the Romans. It is, however, in Assam and Bengal that the cultus appears in its most popular form (see *ERE* ii. 134^a, 491 f.). Here the old savage beliefs, temporarily submerged, but not extirpated, by Buddhism, assume a new development. The cultus is believed to have originated at Kāmṛūp in Assam, and may be older even than the preaching of Buddha (*Census Report Assam*, 1891, i. 80, 1901, i. 39 f.; *JRAS*, 1904, p. 557). The goddess revels in blood sacrifice, and satisfies the desires of her votaries for a diet of meat by permitting the use of the flesh of the animals sacrificed (Wilkins, *Modern Hinduism*, 1887, p. 168). In one Assamese form, Kāmākṣā, 'goddess of desire,' 'the most abominable rites are practised, and licentious scenes exhibited which it is scarcely possible to suppose the human mind could be capable of devising'; and up to quite recent times these were accompanied by human sacrifice (*Census Report Assam*, 1891, i. 80; cf. *ERE* ii. 134 f.). Human sacrifice, though it appears in the legend of Hiranyakaśipu, is not a characteristic of the Vedic religion, and was probably derived from some non-Aryan cult. In former times human victims were immolated at shrines of Kālī in Assam; when the temple of Kāmākṣā was rebuilt in A.D. 1565, Nārāyaṇ consecrated it with numerous human sacrifices, the heads of the victims being offered to the goddess on copper plates; similar sacrifices were frequently offered at the copper temple at Sadiyā, and at Beltolah in Kāmṛūp; it was owing to the seizure of four British subjects for this atrocious purpose that the Rājā of Jaintiā was deposed in 1835 (*Census Report*, 1891, i. 80). In Bengal, again, the worship of Durgā is accompanied by wearisome puerilities and gross idolatry (Pratapachandra Ghosha, *Durgā Pūjā, with Notes and Illustrations*, Calcutta, 1871). The cult of Kālī-Devī is also associated with the horrors of Thagi (E. Thornton, *Illustrations of the History and Practices of the Thugs*, London, 1837; W. H. Sleeman, *Ramaseena: Vocabulary of the Peculiar Language used by the Thugs*, Calcutta, 1836; *Report on the Depredations connected with the Thug Gangs*, Calcutta, 1840).

34. Later developments of Hinduism.—The modern development of Hinduism aims at the reconstruction of the faith in order to adapt it to new conditions. On the one hand, it proposes to reconcile it with the social uprising of the more depressed classes resulting from the impartial reign of British law; on the other, to meet the requirements of the educated classes who have to some extent assimilated the results of Western thought and culture, and among whom the general use of English, like that of Greek under the Roman Empire, or of Latin in the Middle Ages, tends to form a bond of union, and results in the growth of a feeling of common nationality among

the diverse races of the Peninsula. The first movement is illustrated by the growth of sects founded on social revolt; the second by those which seek to reconcile the faith with European philosophy, mysticism, or agnosticism, the method employed being usually to reject the more objectionable dogmas and practices of Hinduism, and to substitute for them the ancient Vedic rites and beliefs.

(a) *Sects founded on social revolt.*—Before the British occupation this type may be illustrated by the rise of Sikhism. The ground was prepared for it by the Musalmān dominion in the Panjāb, which encouraged the growth of unitarian beliefs, and by the eclectic preaching of Kabīr and his followers. It was originally an attempt at religious reform, and, in process of time, arousing the patriotism of the people, ended in becoming a political organization. Founded by Guru Nānak (A.D. 1469–1539), it was further developed by his successors, notably by Guru Govind Singh (A.D. 1675–1708). The creed in its strictest form enjoins the belief in a single God, condemns the worship of other deities, idolatry, pilgrimages to the great shrines of Hinduism, faith in omens, charms, and witchcraft; and does not recognize ceremonial impurity at birth or death. As a social system it aimed at abolishing caste distinctions, and, as a necessary consequence, Brāhmanical supremacy and ordinances, in all family rites. But this ideal system is accepted by few, and there is a growing tendency, now strongly resisted by its leaders, to conform more closely to official Hinduism (see Macauliffe, *The Sikh Religion*). Recent investigations show the difficulty of differentiating Sikhism from Hinduism (*Census Report Panjāb*, 1912, i. 154 ff.). In more recent times a similar movement has been started among the depressed castes, who resent the contempt in which they are held by the punctilious high-caste organizations, particularly in S. India. Thus the Pariahs of Madras have founded an organization of their own, and now assert claims to privileges from which in former times they were rigidly excluded. This movement has caused considerable alarm among some of the leaders of Hindu society, who recognize that, unless the position of these outcasts is seriously considered, there is a risk that they may, in despair, adopt Christianity, as many of them have already done (for recent efforts to relieve the so-called 'untouchables,' see *Census Report Baroda*, 1912, i. 262; *Madras*, 1912, i. 161 f.). In the same way the Satnāmīs (*q.v.*) of the Central Provinces have revolted against Brāhman domination, and are now divided into rival groups, one of which refuses intermarriage with the other, and has adopted a ritual which admits some of the fouler practices of the Vaiṣṇava and Śākta sects (*Census Report Central Provinces*, 1901, i. 89).

(b) *Sects aiming at the reconstruction of Hinduism.*—This movement owes much of its inspiration to the translations of the Hindu sacred books into English, which now, in this form, appeal to a wider educated public. The results of the Brāhma Samāj (see *ERE* ii. 813 ff.) have not been encouraging.

'Many who are really Brahmos, other than those of the Sādhāran Brahmo Samāj sect, prefer to describe themselves as Hindus'; and 'so far as outward appearances go, the present-day tendency amongst the educated classes of Bengal, to whom alone the [Brahmo] sect . . . is likely to appeal, is towards agnosticism or indifferentism in matters of religion, and Brahmoism has no special attractions for them when orthodox Hinduism allows them all the latitude they need' (*Census Report India*, 1901, i. 398; *Bengal*, i. 159).

Its most important innovation has been the establishment of public congregational worship, hitherto unknown in India (see *ERE* ii. 813 ff.). The Arya Samāj, which repudiates idolatry and in a large measure ignores the sectarian deities, studies Christianity chiefly in the works of its

opponents, adopts towards it the attitude of hostility rather than eclecticism, and depends mainly for its influence on the sympathy of the advanced political parties in N. India (see *ERE* ii. 57 ff.).

35. The new Vedāntism.—Some attention, particularly in America, has been directed to the new development of the old Vedāntism taught by Śrī Rāmakṛṣṇa Paramahansa, and expounded by his disciple Swāmi Vivekānanda.

He thus delivers the message of his master: 'Do not care for doctrines, do not care for dogmas, or sects, or churches, or temples; they count for little compared with the essence of existence in each man which is spirituality, and the more that this is developed in a man, the more powerful he is for good' (*Speeches and Writings of Swāmi Vivekānanda*, Madras, n.d. [c. 1909], p. 31). He denies the existence of polytheism in India. 'In every temple, if one stands by and listens, one will find the worshippers apply all the attributes of God—including omnipresence—to the images. This is not Polytheism' (*ib.* 46). The earnest worshipper before an idol 'recognizes in it a necessary stage of his life. "The child is father of the man." Would it be right for the old man to say that childhood is a sin or youth a sin? Nor is image-worship compulsory in Hinduism' (*ib.* 48). His ideal religion is what 'we call in India Yoga, union between God and man, union between the lower self and the higher self. To the worker it is union between men and the whole of humanity; to the mystic, between the lower and the higher self; to the lover, union between him and the God of love; and to the philosopher it is union in all existence' (*ib.* 95). The Hindu mythology is consistent with the principle of evolution, because it 'has a theory of cycles, that all progression is in the form of waves' (*ib.* 215). The claims of the Vedānta to universal acceptance rest on the fact that it is associated with no single founder, that 'it is the one scripture the teaching of which is in entire harmony with the results which have been attained by the modern scientific investigations of external nature. . . . Most of our modern reform movements have been inconsiderate imitations of western means and methods of work, and that surely will not do for India' (*ib.* 462 ff.). 'The most hideous ceremonies, the most horrible, the most obscene books that human hands ever wrote or the human brain ever conceived, the most bestial forms that ever passed under the name of religion, have all been the creations of degraded Buddhism' (*ib.* 504). 'My idea is the conquest of the whole world by the Hindu race' (*ib.* 553; on Rāmakṛṣṇa, see, in general, Max Müller, *Rāmakṛṣṇa, his Life and Sayings*, London, 1899).

36. Theosophical Hinduism.—Another movement, having as its object the reconciliation of Hinduism with more advanced forms of thought, may be called Theosophical Hinduism, which has its centre at the Central Hindu College, Benares, under the guidance of Mrs. A. Besant.

The 'Catechism for Boys and Girls in Hindu Religion and Morals' (Benares, 1907) begins by expounding the 'Basic Principles of Hinduism,' under the name of 'Eternal Religion' (*Sanātana Dharma*). It claims to be the oldest of the world religions, eternal because the truths taught by it are eternal. It depends upon the four Vedas, and other Scriptures written by the ṛṣis, or Saints, such as the *Laws of Manu*, the great *Purānas*, the *Mahābhārata* and *Rāmāyaṇa* Epics. There is one Boundless Eternal Being, Brahman or Parabrahman, who is known only when revealed as Īvara, 'the Lord, the loving Father of all the worlds, and of the creatures which live in them.' He helps us to know Him 'by taking different forms, each of which shows us a little portion of Him.' These forms are the three great Devas—Brahmā, Viṣṇu, and Śiva, or Mahādeva. Brahmā creates, Viṣṇu sustains, Śiva dissolves the worlds again 'when they are worn out and useless.' He also manifests Himself in the form of Devas and Devis—Vāyu, god of wind, Agni, of fire, Varuṇa, of water, Kubera, guardian of the earth. Besides these are Sarasvatī and Gaṇeśa, 'who will help us to learn, if we ask them. He lives in us, in our hearts, in our inner self'; He shines out on us when we are loving and pure, and is clouded when we are cruel or unclean. 'He lives in all animals, and even in plants and stones. He is everywhere, helping everyone and everything, and we cannot do harm to any without hurting Him.' He appears in incarnations (*avatāra*), specially in the ten manifestations of Viṣṇu. Man is composed of spirit (*jīva*), a portion of Īvara, of whom our bodies are the coats. The *jīva* cannot die; at death he leaves the body behind 'like a worn-out cloth,' and 'goes into the next world, dressed in his other bodies. Then he puts off another of these and goes on to Svarga, and is very happy there, till his Svarga body is also worn out.' In the next world a very good man is happy, 'but does not stay long; but a bad man is very unhappy, and suffers a great deal. People who tell lies, who get drunk, who are cruel to women, children, and animals, have to stay there a long time.' When the Svarga body is worn out, 'the *jīva*, helped by the Devas, begins to make some new bodies for himself, as a man might get new clothes. Then he comes back to the earth and is born in his new baby-body.' The conditions of his new birth are controlled by his desires, thoughts, and actions in his previous lives. Desires condition it 'because we must have the things we have wished for, and must be born

where we can get them'; thoughts, 'because we become that which we think about. . . . So our character, that governs our conduct, is made by our thoughts'; actions, 'because we are paid back that which we have done.' The law of *karma* determines all this. The second great law is that of *yajña*, or sacrifice. 'The bodies in which the *jīvas* live can only be kept going by feeding them with other bodies. The bodies of the *jīvas* living in minerals go to feed vegetables. The bodies of the *jīvas* living in vegetables go to feed animals and men. As the *jīvas* living in animals and men sacrifice the bodies of others to keep themselves alive, they in turn must sacrifice their bodies to those about them. Thus the young should sacrifice their bodies to the old, by serving and helping them; fathers and mothers sacrifice their bodies to their children by taking care of them. . . . Every one should give the sacrifice of prayer to God, who gives him all things, and should try to do kindness to the people round him.' A man knows what bodies he should use 'by avoiding the infliction of pain. Grasses and roots, and leaves, and fruits, and vegetables generally do not suffer pain when they are picked and eaten. To avoid giving pain is the highest sacrifice, says the great Bhishma. We should try always not to give pain.'

The account of the 'General Hindu Religious Customs and Rites' begins by defining the *mantra*, or mystical formula, as 'a succession of sounds in a definite order, arranged so as to bring us help and protection from Īvara, or from some Deva or Devi.' The order of the words is important, because 'if notes are played in a particular order, we have a tune; if the order is changed, the tune is spoiled.' If a *mantra* be translated into another language, it loses its use, as 'an Indian tune, played on an Indian musical instrument, cannot be played on an European musical instrument, because the latter has not all the notes that the Indian one has.' Sacraments (*samskāra*) are 'ceremonies performed at particular times during the life, to make the bodies more useful to the *jīva*.' The chief of these are the giving of the sacred thread (*upanāyana*) and marriage (*vivāha*). The funeral mind-rite (*śrāddha*) helps the *jīva* 'to pass quickly through the world into which he goes at death, and to reach the happy world of Svarga much sooner than he would do if he were left to himself.' Purity (*śauca*) is essential because dirt is poisonous; 'bad smells are the warnings of the Devas of disease.' Worship is 'love of Īvara; being devoted to Him, thinking about Him, praying and singing praises to Him, and trying to serve Him in all the forms He takes, by kindness to everyone and everything.'

37. Hindu eclecticism.—This summary account of Hindu sectarianism may tend to exaggerate its extent. It would be a mistake to suppose that the faith is divided into so many water-tight compartments between which intercommunication is impossible. The position of the advanced Hindus on the question of sectarianism has been defined as follows:

'The attitude of an educated Hindu towards the question of doctrine and worship is this: What God is is not entirely knowable, as it is an infinite conception. Of this infinite conception only a fraction in the form of an idea of either power, miracle or material, comes to the knowledge of man, by an occasional and wonderful manifestation. It is vain for a man to be proud of any particular manifestation and to exclude the rest from cognizance. All worship, therefore, should be tolerated. Any deity may continue to be worshipped provided the worshippers' conception becomes widened. It is neither proper nor necessary to replace one deity by another, because it is not a matter of importance whether the absolute and infinite conception is called Shiva, Viṣṇu, Durgā, or Buddha. Whether a man worships the Sun, Jupiter, or Saturn, or any historical great hero, or a saint, or a river like the Ganges, or any other object that inspires awe or creates fear, is a matter of no importance. All these gods or manifestations are but starting-points. To disturb the faith of a man in a finite God is foolish as long as his mind is not fit to accept the higher' (Shridhar V. Ketkar, 161).

While the Śāktas are more distinctively separated from Saivas and Vaiṣṇavas, these two are, in the view taken by most Hindus, complementary rather than antagonistic. Both appeal to the *Purānas* as their Scripture; members of one sect may venerate the deities of another. Thus in some places Harihara (Viṣṇu-Śiva) is worshipped (Rice, *Mysore and Coorg from the Inscriptions*, 205). In Malabar we find 'none of the strict differentiations between worshippers of Viṣṇu and Śiva, or, indeed, between any of the forms of the deity, whether venerated as gods or goddesses, which are to be seen elsewhere in S. India beyond Malabar and Travancore. . . . The people generally do not, as a rule, give much regard to such differentiation. The Nambūtiris do, but by no means to such an extent as one sees, for example, among the Śrī Vaiṣṇava Brāhmins of Holy Conjeevaram, who are divided into two sects, each hating the other with the most acrid bitterness' (*Bull. Madr. Mus.* iii. 79; cf. *Census*

Report Cochin, 1912, p. 22; Thurston, *Castes and Tribes*, v. 369). In those regions, again, into which Hinduism and the rules of caste have recently been introduced, the distinction of sect is often a matter of diet, the vegetarian being a Vaiṣṇava, the meat-eater a Śākta. But in Assam, where the Vaiṣṇava teachers follow the strict law of Chaitanya, new converts, accustomed to a diet of pork, refuse to abandon it (*Census Report*, 1901, i. 39). In Bengal many worshippers of the goddess Durgā, who demands animal sacrifices, are in private worshippers of Viṣṇu (Wilkins, *Modern Hinduism*, 43); in W. India many Vaiṣṇavas worship the Mother-goddesses (*BG* v. 51 f.); and in Madras change of sect is common (Dubois, *Hindu Manners and Customs*², 119). For a discussion of the relation of Vaiṣṇava and Śaiva beliefs, and of the suggestion that all Hindus of the Province can be classed under one or other of these sects, see *Census Report Panjāb*, 1912, i. 125 ff. The same eclecticism prevails in the worship of images. The sacred place is the home of many gods, who are all impartially worshipped by pilgrims. Again, in many places we find a syncretic combination of cults, the lesser gods being regarded as the 'doorkeepers' (*dvārapāla*) of, or subordinate to, the chief deity. Many of the greater gods have absorbed non-Aryan beliefs and ritual—a process which is often marked by special legends.

It was a non-Aryan Sāvāra who discovered the image of Jagannāth, and it was not till a Brāhman married a daughter of the finder that the cult was established. It was a Pulayā, an out-caste, who found the child, an incarnation of Viṣṇu, now worshipped as Padmanātha in Travancore (Hunter, *Orissa*, London, 1872, i. 89 ff.; Oppert, 76 f.). The same fusion of cults appears at many shrines, the place having been adopted by rival sects in succession. The sculpture of the great gates at Tanjore is all Vaiṣṇava, while everything inside the courtyard is Śaiva; and 'one of the great difficulties of an antiquary before the 8th century is to ascertain to what divinity any temple or cave is dedicated' (Fergusson, *Hist. of Indian Arch.* 744, 441). In the same way, Benares, a Śaiva stronghold, is a museum of cults associated with other gods (Sherring, *Sacred City*, 63, 102, 130, 172). The shrine of Śiva, as Mahākāla, at Kathmāndu (*q.v.*) is visited by all sects and by all ranks of the people, from the Hindu Gorkhā king and queen down to the humblest Buddhist Newār; Bānhras, or Buddhist priests, officiate at Hindu celebrations, and Hindus regard the Buddhist deities as eminent saints (Oldfield, ii. 285 f.). The association of the cultus of Śiva and his consort with that of Viṣṇu at the temple of Jagannāth, a chief seat of Viṣṇu worship, is specially noteworthy (Hunter, *Orissa*, 128). In Ceylon, Buddhists continue to worship many of the Hindu gods (Hardy, *Eastern Monachism*, 201; cf. Waddell, *Buddhism of Tibet*, 325). In W. and S. India many Christian shrines command respect from Hindus, and in a less degree from Muhammadans (*BG* xiii. pt. i. p. 209; N. Manucci, *Storia do Mogor*, London, 1907, iii. 343; *IGI* x. 167). In the N. W. Frontier Province the predominance of Islām has seriously influenced the local Hinduism (*Census Report*, 1912, i. 93). Hindus and Muhammadans worship at the shrine of the Virgin Mary at Cochin, and the bust of a well-known missionary at Madras was recently associated with the image of Sarasvatī at a Hindu religious rite (Thurston, *Ethnogr. Notes*, 361; *Bombay Ethnogr. Survey*, 1909, 'Kharva,' no. 114, p. 5). On the other hand, many groups of Christian converts retain Hindu beliefs and observances (*Census Report Cochin*, 1901, i. 59 f.). In N. India the high-caste Brāhman keeps in his private house-chapel an ammonite

śālagrāma representing Viṣṇu, and a pair of phallic emblems of Śiva and his consort; when he goes on pilgrimage to sacred places he pays homage both to the Śaiva and to the Vaiṣṇava shrines (Jogendra Nath Bhattacharya, *Hindu Castes and Sects*, Calcutta, 1896, p. 364). In Bombay every Brāhman householder worships a group of five deities—Śiva in the *liṅga*; Viṣṇu in an ammonite or in a picture; a metal image of the Śakti, or Mother-goddess; Gaṇapati, or Gaṇeśa, god of luck and wisdom; Sūrya, the Sun, or Hanumān, the sacred monkey (*BG* ix. pt. i. Introd. p. xxxv). In the temples of the Mādhavachāri sect in the Baroda State are found images of Śiva, Durgā, and Gaṇeśa side by side with those of Viṣṇu and his consort, the explanation given by members of the sect being that the founder, originally a worshipper of Śiva, afterwards adopted the cult of Viṣṇu (*Census Report Baroda*, 1901, i. 137 f.). In this State any hostility towards adherents of rival sects is not felt by the population at large, but by the leaders and inner circle of devotees (*ib.*, 1912, i. 74).

The continuity of religious life is exemplified by the successive occupation of the sacred sites by various forms of religion. Benares and Mathurā were centres respectively of Buddhism and Jainism, the former being at present devoted chiefly to the cult of Śiva, the latter to Viṣṇu in the form of Kṛṣṇa. At Sakhi Sarwar (*q.v.*), near the Sulaimān range, Hindus perform their rites of prayer and ablution, Sikhs venerate a shrine of Nānak, Muhammadans the tomb of a Muhammadan saint (*IGI* xxi. 390). Nāsik and Wāi, both at the present day important centres of Hinduism, have lines of Buddhist caves (Fergusson-Burgess, 263 ff., 211). In Kāśmīr, in spite of the nominal conversion of the population to Islām, their shrines stand on the sites of the holy places of the Hindus, and receive a veneration not accorded to the modern mosques and their Mullas (*IGI* xv. 102). But, though Hinduism is eminently eclectic and tolerant, disputes between rival sectarians, ending in bloodshed, are not uncommon. Serious riots between rival bands of ascetics have occurred at Hardwār (*q.v.*). Rival Vaiṣṇava sects have come in contact in the Madras Presidency, and Vaiṣṇavas have resisted the Śaiva Liṅgāyats (*q.v.*) (*IGI* x. 257, 378; Dubois, 119 f.). Conflicts between Vaiṣṇavas and Jains frequently occurred in S. India in the 14th cent. (Rice, *Mysore and Coorg*, 177). In N. India, processions of the Jain 'naked gods' have led to serious riots between them and orthodox Hindus.

38. Idolatry.—The feature of modern Hinduism which attracts the attention and provokes the contempt of foreign observers is the universality of idol-worship. The earlier forms of Hinduism were aniconic. The older Buddhism paid reverence to relics and symbols. It was the later Mahāyānā development which introduced images of the Master. In its modern form the Hindu idol has little of the artistic beauty which we find in Greek anthropomorphism, which,

'although falling far short of the grandeur and purity of the Infinite, yet furnishes its noblest image, because it has glorified by artistic genius the human body, which has been chosen as the earthly home of the rational soul' (Dill, *Roman Society from Nero to Marcus Aurelius*, 1906, p. 422).

The Hindu theory of the idol is in sharp contrast with that of the Greek. To the former human form is merely the ephemeral clothing of the soul, in which, unhappily, it is forced to linger for a time. Though in the sculptures of the age of Aśoka an interest in portraiture, at least in that which represents national characteristics, begins to appear, the child-like naturalism, somewhat refined in the delineation of woman, tends to become rococo in style. As idol-worship advanced, from the 7th or 8th cent., energy exhibited itself in gigantic images, or was expressed in a multiplica-

tion of the limbs or symbols of the deity. It is a mistake to suppose that idolatry was introduced into India by the example of the Greeks, and that it was rarely practised until the beginning of the Christian era. Images of the gods were certainly common in the Maurya period (321-184 B.C.), and doubtless at a much earlier time; but of these ancient images none has survived (V. A. Smith, *Hist. of Fine Art in India and Ceylon*, p. 79 n.). In the modern idol the rigid conservatism of the race limits artistic invention as the forms become stereotyped; and the growth of æstheticism has exercised little influence on the development of the Hindu image. (For the development of the Buddha images, see Shway Yoe, *The Burman*, i. 237.)

'The image may be regarded in two aspects: as a symbol merely bringing close to the sense the spiritual idea of divinity, and serving to stimulate the prayerful thought of the worshipper; or it may be venerated as the indwelling abode of the divinity, in which he habitually resides, or into which, by spells and blood-offerings, he may be compelled to enter' (Farnell, *Evolution of Religion*, London, 1905, p. 42 f.).

The first is the view of orthodox Brāhmanism, which corresponds with the apology for anthropomorphism given by Platonists like Dion or Maximus of Tyre.

'The justification lies in the vast gulf which separates the remote, ineffable, and inconceivable purity of God from the febleness and grossness of man. Few are they who can gaze in unaided thought on the Divine splendour unveiled. Images, rites, and sacred myth have been invented by the wisdom of the past, to aid the memory and the imagination of weak ordinary souls. The symbols have varied with the endless variety of races. Animals or trees, . . . or the miracles of Pheidias in gold and ivory, are simply the sign or picture by which the soul is pointed to the Infinite Essence which has never been seen by mortal eye or imaged in human phantasy' (Dill, 394 f.). 'Idolatry is in fact nothing more than a representation of the abstract by the concrete, of remote by proximate, and of the principal by the agent.' No man on earth 'can conceive of infinities like time, space, or God with the same vividness as that of a finite object' (Shridhar V. Ketkar, 48; and cf. the apology for idolatry by an orthodox Hindu [*Census Report Travancore*, 1902, i. 201 ff.]).

In the same way, the Buddhist defends the use of images as 'a means to the pious of localising their feelings and concentrating their thoughts on the supreme model' (Shway Yoe, i. 221, 227). This view, however, is not that of the masses of Hindus. They regard the image as being, for the time, occupied by the deity. When the image of Durgā is installed at the Durgā-pūjā festival, the priest makes this invocation:

'O goddess, come and dwell in this image, and bless him that dedicates it.' Then, naming the person on whose behalf the rite is being performed, he touches the eyes, lips, forehead, cheek, and other parts, saying: 'May the soul of Durga long live in this image!' (S. O. Bose, *The Hindoos as they are*, Calcutta, 1881, p. 102).

In Nepāl, while the idol of Grāmadevi Jayabāgheśvarī is being re-painted, the spirit of the deity is extracted and kept in a jar until the work is finished, when it is restored to its abode (Wright, *Hist. of Nepāl*, 127). The same idea, in a grosser form, appears in the degraded northern Buddhism, when internal organs made of dough or clay are inserted in the larger images; in those most highly valued, precious stones, filings of the nobler metals, consecrated rice, scrolls containing the Buddhist creed, texts, and sacred relics are placed (Waddell, *Buddhism of Tibet*, 329).

The luxuriance of modern idol-worship is best observed at the more important holy places.

In 1868, Sherring estimated that there were 1454 temples in Benares; and this enumeration did not include the minor shrines and wall-niches, each containing one or more images, which are found everywhere in the streets. 'These inferior shrines were, on one occasion, by a curious contrivance immensely increased; and yet the increase could hardly have been generally perceived. Rājā Mān Sīāh of Jeypore, wishing to present a hundred thousand temples to the city, made the stipulation that they were all to be commenced and finished in a single day. The plan hit upon was to cut out in blocks of stone a great many tiny carvings, each one representing a temple. The separate blocks, on the work being completed, exhibited from top to bottom, and on all sides, a mass of minute temples. These blocks are still to be seen

in various parts of Benares. . . . In regard to the number of idols of every description actually worshipped by the people, it certainly exceeds the number of people themselves, though multiplied twice over; it cannot be less than half a million, and may be many more' (*Sacred City*, 42 f.). Cf. IMAGES AND IDOLS (Indian).

39. The beliefs of the peasant classes.—The primitive animistic or pre-animistic beliefs (see § 7) have been to some extent obscured or modified by the predominant Brāhmanism among the menial races of the plains, and in a less degree among the forest tribes. The Hindu villager, like the Jew at the period of the growth of Christianity (W. R. Cassels, *Supernatural Religion*, London, 1902, p. 57 ff.), lives in an atmosphere peopled by spirits, generally malignant, capable of being repelled or conciliated by sacrifice, spells, incantations, amulets, and other magical or semi-magical means.

'A belief in every kind of demoniacal influence has always been from the earliest times an essential ingredient in Hindū religious thought. . . . Certainly no one who has ever been brought into close contact with the Hindūs in their own country can doubt the fact that the worship of at least ninety per cent. of the people of India in the present day is a worship of fear' (Monier-Williams, *Brāhmanism and Hindūism*, 230).

The Hindu villager has no conception of the reign of law in the natural world. The occurrence of miracles is a matter of daily observance. He appeals to the minor rather than to the greater gods, because the latter have, in his belief, in a large measure lost touch with humanity, and no longer interest themselves in the petty details of his ordinary life ('Magna di curant, parva neglegunt' [Cic. *de Nat. Deor.* ii. 66, 167]). In all matters of practice, custom is conceived as a moral rule, which decides what is right and what is wrong. 'The custom handed down in regular succession since time immemorial . . . is called the conduct of virtuous men' (Manu, ii. 18; cf. Westermarck, *MI* ii. 161 ff.). The rites connected with the cult of this vaguely conceived spirit agency are generally performed in the house or at some spirit-haunt, not at a regular shrine or temple. They are usually done by the head of the household, or, when the services of a regular officiant are needed, he is not a Brāhman of the higher class, but a hedge priest drawn from the inferior Brāhman ranks or from one of the menial or forest tribes, the members of which, being assumed to be autochthones, are supposed to be better acquainted with the local spirits and more skilled in repelling or conciliating them than the newer comers. Sometimes the conduct of the rites is entrusted to women, whose greater susceptibility to spirit influence is believed to qualify them for such duties. While the men often worship, with more or less regularity, the official god or gods of their choice, the propitiation of village deities or spirits is often left to women, who are much more conservative than the other sex in matters connected with religion.

It has been suggested that, as in the case of the Greek goddesses, the cult of the female powers or Sāktis has its origin in the matriarchate—a view advocated by J. E. Harrison (*Prol.* 280 ff.), and vigorously opposed by Farnell (*HJ* ii. [1904] 825 f.). It is possible that mother-right once widely prevailed in India, as is indicated by the common rule of inheritance through females, the position of the maternal uncle at marriages, and the priestly functions assigned to the sister's son. But there seems no good reason for connecting the prevalence of Sāktism with mother-right. In N. India the daily worship of the peasant is confined to bowing to, or pouring out a little water in the name of, the sun on rising, as the Greek prayed to Helios (*CGS* iv. 139); to making reverence to the deity or deities embodied in the village-shrine as he passes it on his way to work; to naming Śiva or

one of the incarnations of Viṣṇu when he feels piously inclined. For the rest, his religious wants are sufficiently provided for by an occasional visit to a sacred river or place of pilgrimage, where he bathes, visits the chief temples, and feeds a Brāhman or two; to the propitiation of his deceased ancestors; to attendance at village or local festivals, where the religious service is only an adjunct to trade or amusement. There is little or no domestic worship save the rites at birth, marriage, and death, the first two being discharged by his family chaplain (*purohit*), the third by some degraded Brāhman who acts as funeral priest. Occasionally a pious man hires a Brāhman and invites his friends to attend a recitation (*kathā*) of one of the sectarian Scriptures. Such rites involve considerable expense, which the thrifty peasant avoids as far as he can consistently with the desire to conciliate his gods and escape the contempt of his neighbours. Among the trading classes it is the custom at the close of life to devote considerable sums to the erection of a temple in their native village or at some sacred place. The peasant may thus seem to be lax in the discharge of his religious duties. But this is not actually the case, because all his ordinary social rites are performed from a motive which to him is religious, that is to say, in obedience to the laws of the caste to which he belongs. It may be said that there are few races among whom religion, as they conceive it, forms a larger part of their daily life. In the eastern Panjāb he

has practically no belief in the transmigration of souls, but he has a vague idea that there is a future life, in which those who are good in this world will be happy in a heaven, while those who are bad will be wretched in a hell. His devotional offerings to demons, saints, and godlings are meant rather to avert temporal evils, or secure temporal blessings, than to improve his prospects in the life to come. . . . He believes vaguely that it is good for him to meditate on the deity, and to show that he is not forgetting him he mutters *Rām / Rām / Rām /* or repeats the name of some other Hindu god when he gets up in the morning, and if he is piously inclined, at other times also, in season and out of season. Notwithstanding all the numerous saints and deities whom he endeavours to propitiate, he has a vague belief that above all there is one Supreme God, whom he calls Nārāyaṇ or Parameśvar, who knows all things, and by whom all things are made, and who will reward the good and punish the bad in this life and in the life to come' (Wilson, *Settlement Report of the Sirsa District, Lahore, 1882, p. 133*).

In Gujarāt, as the peasant wakes, he mutters the name of his patron deity, Mahādeva or Śiva, Thākurji or Viṣṇu, Ambābhavānī the Mother-goddess; and if he knows a little Sanskrit he repeats the verse: 'I call to mind in the morning the Lord of deities, the Destroyer of the fear of death!' If he is a layman under a special vow, he chants the praises of his personal deity in a verse from some vernacular poet, or meditates upon his attributes and perfections. If he is a Brāhman or man of high caste, he always bathes, invokes the sun, and pours water in his name, and, thrusting his right hand into an ornamented bag, known as the 'cow's mouth' (*gaumukhi*), he runs over his rosary, repeating the ancient Gāyatri, or prayer to the sun. His house oratory contains images of Bālmukund or the infant Kṛṣṇa, the *sālogrāma* ammonite representing Viṣṇu, figures of Śiva, Gaṇeśa, Durgā-Devī, Sūrya the sun-god, Hanumān the monkey-god, and others, thus showing the extreme eclecticism of his beliefs. These he washes, dresses, crowns, and adorns with flowers and other offerings, and, if truly pious, he performs the sixteen rites of worship, including all modes of service to the deities, and ending with the circumambulation of the images and a hymn of praise (Forbes, *Rās Māla*, pp. 552 f., 596 ff.).

In Berār the peasant is both a polytheist and a monotheist, believing in one God, to whom the others are subordinate. His special deities are the village Māruti or the monkey-god who is the village guardian, and his family tutelary deities. His

chief religious duty is to make pilgrimages, but these are not compulsory. All life he more or less regards as sacred. He is tolerant, regarding every religion as true and good for him who is born to it.

'He believes that a very strict account has been kept of his good and bad actions; and that he is as sure of getting his reward as his punishment, very often in this world, but generally after death. His belief in a region beyond the grave is very firm. There he will meet with his deserts, and, after enjoying the bliss of heaven or enduring the tortures of purgatory, he will be sent back to this world in the incarnation of a man or a beast, according as he has made good or bad use of his time in this life' (*Census Report Berar, 1901, l. 64 f.*).

For similar beliefs in Madras, see J. E. Padfield, *The Hindu at Home*, 1896, chs. iii. and iv.; for Bengal, *Census Report, 1901, i. 186 ff.*; for the Panjāb, Ibbetson, *Punjab Ethnography*, ch. iv. pt. ii.

40. The ethics of Hinduism.—The influence of Hinduism on life and character is a subject too wide to receive detailed treatment here, and it has been elsewhere discussed (*ERE* v. 496 ff.). The supernatural beings of savage belief frequently display the utmost indifference to questions of worldly morality; and in the early stages of the evolution of public justice, the community interferes only on supernatural grounds with actions which are regarded as endangering its own existence (Westermarck, *MI* i. 663, 709 f.; L. T. Hobhouse, *Morals in Evolution*, London, 1906, i. 119). In other words, sin is regarded as a social or ritual offence, not as the defilement of the individual soul. From the earliest period, it is true, the evil of sin is fully recognized, and its removal is stated to be the work of the gods; but the first mention of the public confession of sin appears in Buddhist literature (Hopkins, 42, 60, 65, 329). It was fully developed under the Bhāgavata monotheism (see *ERE*, vol. ii. p. 544^b; and cf. EXPIATION AND ATONEMENT [Hindu], vol. v. p. 659). It is also true that the official Hinduism of the sacred books 'cannot be charged with indifference to moral ideals. Its sacred literature teems with reflections on the vanity of human life, the glory of renunciation, the necessity of good works, the duty of sympathy with all living things, the beauty of forbearance, the hatefulness of revenge, and the power of man to determine his own fate by right conduct. It appeals both to the intellect and to the emotions, and it derives a certain measure of support from the penalties imposed by the caste system' (Risley, *The People of India*, 235).

Such is the official view of the Brāhmanical teachers, who share with the lay members of the community a craving for moral formulas and programmes, and an incapacity for applying them in practical life. Much of this teaching is thus merely idealistic, and is beyond the comprehension and above the moral standard of their disciples. Much, again, of this official morality is open to criticism. Thus, though a regard for truth is taught in Hindu literature from the earliest period, Manu admits that false evidence given with a pious motive does not involve the loss of heaven (F. Max Müller, *India, What can it teach us?* 64 ff.; Manu, viii. 105 f., 112). At the same time, the lawgiver reprehends perjury in certain cases (Manu, viii. 97-101, xi. 57). On the other hand, the assertion of Dubois (p. 171) that neophytes, as a part of their training, are instructed in the art of lying, has no foundation, at the present time at least. A recent native writer remarks that the chief ethical defect in the Hindu Scriptures is that penance is regarded as an atonement for sin.

'Every Hindu believes that he will be able to wash off his sins by performing a penance or by giving *dān* [gifts] to Brāhmins, who have proclaimed that pardon or even merit will be attained through their agency. . . . It leads to the monstrous belief that evil deeds, of whatever enormity, can be atoned for and expiated by money' (*Census Report Baroda, 1901, i. 135*).

The belief, again, that morals depend not on religion, but on the relations of family, caste, or tribe, tends to produce dangerous results.

'Murder is an offence against caste involving severe penalties. But there are no caste penalties for forgery, perjury, cheating, or theft, and this is perhaps the reason why Hindus frequently find it difficult to realize that there is anything morally wrong in this category of offences' (*Census Report Central Provinces*, 1901, i. 81).

The theory, again, that Brāhmins are above all social and moral law saps the foundations of morality. Probably the most effective rule of morals for the average Hindu is the Indian Penal Code, which, for the first time in the history of the race, has carefully defined all criminal offences, and has assigned a fitting punishment for each. There is no doubt much indecency in the outward observances of Hinduism—in temple carvings, the original purpose of which was probably to repel evil spirits, but which have now ceased to subserve this purpose in the eyes of most worshippers; in some religious processions; in the institution of the Devadāsī dancing-girls, attached, like the *hierodouloi* (*q.v.*) of some Greek shrines, to a few of the greater temples. But much of this indecency of word and act is common to all Eastern races, and is not necessarily pornographic among people who have never learned, like those of the West, to treat normal and abnormal sexual questions and relations with reticence. It is this condition of things, sufficiently apparent to any competent observer of native life and manners—not to speak of the secret obscenities which disfigure much of the Śākta and Vaiṣṇava cultus—which has called forth the unmeasured criticism of missionary writers. But it is certain that, if the majority, or even any considerable portion, of the Hindu population were infected with the pollutions against which writers like Ward and Dubois have justly protested, society ere now would have collapsed through its own corruption, just as the Roman world, had it been as debased as it is painted by Juvenal and Martial, must have speedily perished through sheer rottenness. The truth probably is that such vices have always infected only a minority of the people. At the same time the real influence of Hinduism on public morals is small. An experienced missionary writes:

'As far as I can gather from observation and conversation with the people [of Bengal], by their acts of worship there is no attempt after real purity of heart, the conquering of an evil nature, and a desire to please God in return for His goodness. Men sin at the shrines as they do in their houses, and on their return as before their visit. Nor is it thought anything remarkable that this should be so, excepting perhaps in the case of those who have gone to some sacred place in the hope of ending their days there. In cases of this kind I have heard of a higher, purer life being attempted, and of the expectation of this by those who know them. But certainly there is neither the attempt nor expectation of this in the minds of the large majority of the people who go on a pilgrimage. It is not that they may be made pure, but that, by an act of penance, they may give an equivalent to the gods for their sins' (Wilkins, *Modern Hinduism*, 313).

But it must not be forgotten that, behind the immoral beliefs which disfigure some aspects of Hinduism, there is much good sense, benevolence, self-control, self-abnegation, active charity, and kindness which are characteristic of Hindu home life, and are particularly noticeable in those parts of the country where the institution of the joint family prevails.

Hinduism, then, in its practical aspect, exercises little influence over morals. As Farnell, discussing the Dionysiac cultus, remarks, 'As the highest flight of religion rises above mere morality, so a religion may be most powerful in its appeal, and yet remain directly non-moral' (*CGS* v. 238; cf. F. B. Jevons, *An Introduction to the Study of Comparative Religion*, New York, 1908, p. 215 ff.). In default of a well-defined religious sanction for morals, Hinduism has made the ordinary sinner responsible to the caste council for breaches of the moral or social law as interpreted by the elders of the caste. The only agency which really provides moral teaching is the *guru*, or religious preceptor.

He whispers into the ear of the neophyte the secret formula which is to be his guide during life, and he thus admits him to caste privileges and responsibilities. In after life the influence of such teachers is often valuable. In Bengal the *guru* ranks higher than in the Panjāb or the United Provinces, where he seldom makes official progresses to visit his disciples and inquire into questions of morals and caste discipline (Buchanan, *Eastern India*, London, 1838, ii. 751; Wilkins, 26 ff.). In S. India he is an important personage, vested with wide powers of control and discipline over the members of the sect of which he is the leader (Buchanan, *Journey through Mysore*, London, 1807, i. 144 ff.; Nelson, *Manual of Madura*, Madras, 1868, pt. iii. p. 160 ff.; Dubois, 123 ff.).

41. The lack of organization in Hinduism.—Hinduism thus provides a characteristic example of the primitive, unorganized polytheisms—an example probably unique among the races of the modern world. This is partly due to the peculiarities of the Eastern temperament, the devotion to mystical speculation, and the incapacity for political organization, which are obvious throughout the history of the Hindu people. It extends over an enormous area, inhabited by many races, all differing in origin, language, and character. The absence of a great and permanent Hindu empire, except under Aśoka and Harṣa, with a single capital city as a centre of religious and political life, prevented the consolidation of the local cults into a State religion, like that of Babylonia or Egypt. This condition of things has been often compared (as by Lyall, i. 159) with Gibbon's account of the state of religion in the Roman Empire (*Decline and Fall*, ed. Smith, i. 165 ff.):

'The various modes of worship which prevailed in the Roman world were all considered by the people as equally true; by the philosopher as equally false; and by the magistrate as equally useful.' Like the Brāhman Vedāntist, 'the devout polytheist, though fondly attached to his national rites, admitted with implicit faith the different religions of the earth. Fear, gratitude, and curiosity, a dream or an omen . . . perpetually disposed him to multiply the articles of his belief, and to enlarge the list of his protectors.' The modern semi-educated Hindu resembles 'the ingenious youth . . . alike instructed in every school to reject and to despise the religion of the multitude.' There is, again, a philosophic class who, 'viewing with a smile of pity and indulgence the various errors of the vulgar, diligently practised the ceremonies of their fathers, devoutly frequented the temples of the gods.' Lastly, the Anglo-Indian magistrates 'know and value the advantages of religion, as it is connected with civil government.'

Hence Hinduism has never prepared a body of canonical Scriptures or a Common Prayer Book; it has never held a General Council or Convocation; never defined the relations of the laity and clergy; never regulated the canonization of saints or their worship; never established a single centre of religious life, like Rome or Canterbury; never prescribed a course of training for its priests. This is not due to the fact that war, or civic tumult, or foreign domination prevented the growth of institutions of this kind; but simply to the fact that all such action is essentially opposed to its spirit and traditions. Added to this is the prevailing tendency towards pessimism.

Lyall (ii. 38), writing under the guise of an orthodox Vedāntist, says: 'The innermost religious idea of the Hindus has for ages been the supreme unimportance, if not the nothingness, of this particular stage of existence, and they have lapsed into a deep indifference for humanity at large, a feeling that is probably as much the product of their environment as are their dark skins and physical delicacy. The lords of life may be pleasure and pain; but though we have deified them under various symbols, we have always sought to escape from the servitude of their dominion, believing that the soul's true liberty lay beyond their realm.'

The links which bind together this chaotic mass of rituals and dogmas are, first, the general acceptance of the Veda, representing under this term the ancient writings and traditions of the people, as the final rule of belief and conduct; secondly, the recognition of the sanctity of the Brāhman Levite

caste as the custodians of this knowledge and the only competent performers of sacrifice and other ritual observances, though the respect paid to them varies in different parts of the country (§ 10 (b)); thirdly, the veneration for sacred places; fourthly, the adoption of Sanskrit as the one sacred language, which plays a part like Latin in Europe during the Middle Ages; fifthly, the general veneration for the cow (see W. Crooke, 'The Veneration of the Cow in India,' *FL* xxiii. [1912] 275 ff.).

42. The future of Hinduism.—The progress of Hinduism, as compared with that of the other religions of India, does not readily lend itself to statistical analysis. In recent enumerations of the people, the figures have been obscured by exceptional outbreaks of famine, plague, and other epidemic diseases; and, as has already been observed, it is practically impossible to discriminate the Animists from the general body of Hindus.

During the twenty years preceding the Census of 1901, the recorded proportion of Hindus to the total population fell from 74.32 to 70.37 per cent in the Empire as a whole; from 72.08 to 68.6 in the British provinces; from 82.99 to 77.56 in the Native States. On the other hand, in the whole Empire the percentage of Muhammadans has in the same period risen from 19.74 to 21.22 per cent; that of Christians from .73 to .99 per cent.

The result is thus slightly unfavourable to Hinduism. But it is probable that the Hindu, owing to his vegetarian diet, more than the followers of other religions, is exposed to the exceptional disasters to which reference has been made. At the same time, there has been a notable increase of vigour in Hinduism, owing to its connexion with an active political agitation.

'In late years the strength of the Hinduising movement has been greatly augmented by the improvement of communications. People travel more, pilgrimages can be more easily made, and the influence of the orthodox section of society is thus more widely diffused. Railways, in particular, which are sometimes represented as a solvent of caste prejudices, have in fact enormously extended the area within which these prejudices reign supreme' (Risley, *The People of India*, 178 f.).

The future development of Hinduism must remain purely a matter of speculation, and the materials on which a reasonable forecast can be based are scanty and uncertain. Hinduism meets the needs of two classes of the people: one, the small intelligent class which is accessible to foreign influences, and at the present day is easily affected by that wave of unrest which has troubled the usually calm surface of the Eastern world; the other, the mass of the population, chiefly rural, uneducated, immersed in the constant struggle for existence conditioned by their environment, strongly conservative in their views, and caring little for the new theological and political controversies, which are mainly confined to the residents in the towns and great cities. For the former, Hinduism admits the new ideas and principles which are the result of Western culture, and enforces no rigid standard of orthodoxy. For the latter it provides the traditional form of belief, largely animistic in spirit, and well adapted to the intellectual capacity of an ignorant, superstitious body of worshippers. It was at one time the fashion to assume that the fresh Western learning, and increasing home and foreign travel, would inevitably sap the power of caste, and with it the religion to which it is so closely linked. But this view loses sight of the extreme immobility of the masses of the people, who are as little disposed to leave their crowded hamlets in search of novel modes of livelihood as to abandon their ancestral beliefs and ritual, and seek the protection of deities other than the gods of their native village. On the other hand, the conditions of the country prevent any uniformity of belief; and, until a general *lingua franca* is established, it is impossible that the diverse elements in the people can be welded into a single whole.

Hinduism is obviously confronted with serious difficulties, due to the spread of new beliefs and theological speculation. The most obvious parallel is the position in the Roman Empire during the early centuries of our era, when the official paganism was assailed by Christianity, Neo-Platonism, and sundry foreign cults. It was not till the close of the 4th cent. that paganism finally succumbed. In India the movement has already extended over a much longer period, and the process has been much more protracted. It is now some twelve centuries since the attack of Islām began, and Hinduism shows no obvious signs of weakness. It possesses wonderful powers of adaptation to novel conditions. It has held its ground for long ages against anarchy and persecution; it has proved victorious against the assault of Buddhism. If it yields, it yields very slowly before Muhammadanism and Christianity. Even if in the present conflict it has to surrender much, it is possible that it may emerge from the struggle purified and reinvigorated. The question has been thus treated by A. C. Lyall:

'Taking things as they are now, and looking upon the actual state and movement of religions in India, an eye-witness would still be justified in affirming that this religion, although powerfully affected by social and political changes so strong and sudden that they would try the constitution of any national creed, is nevertheless not yet dead, nor dying, nor even dangerously ill; and, moreover, that so far from it being a non-missionary religion, it converts more than all the other Indian faiths. . . . 'Although polytheism still prevails and multiplies throughout the land, and although the Brahmanic system, deep-rooted and wide-spreading, shows no signs of vital decay, one may nevertheless venture to anticipate that the end of simple paganism is not far distant. . . . Though it would be most presumptuous to attempt any kind of prediction as to the nature or bent of India's religious future, yet we may look forward to a wide and rapid transformation in two or three generations, if England's rule only be as durable as it has every appearance of being. It seems possible that the old gods of Hinduism will die in these new elements of intellectual light and air as surely as a net full of fish lifted up out of the water; that the alteration in the religious needs of such an intellectual people as the Hindus, which will have been caused by a change in their circumstances, will make it impossible for them to find in their new world a place for their ancient deities. Their primitive forms will fade and disappear silently, as witchcraft vanished from Europe, and as all early modes of thought and symbolism become gradually changed. In the movement itself there is nothing new, but in India it promises to go on with speed and intensity unprecedented' (Lyall, *Asiatic Studies* 2, i. 134, 37, 319).

Regarding this forecast, it may be urged that too little stress has been laid upon the numerical weakness of the educated or semi-educated classes, and upon the immobility and ignorance of the rural population; and that the possibility of the rise of some great religious teacher, a new Buddha or Śāṅkara, has not been sufficiently considered.

Another writer, N. Macnicol (*HJ* vi. [1907] 63 ff.), has discussed the same question from the standpoint of Christianity. He points out that

'the two features of Hinduism that have been emphasised as peculiarly characteristic of it, its lack of articulation as a system of belief, and its adaptability to new circumstances, have been possible to it because of another peculiarity which is a main source of its strength and yet is likely to prove a fatal weakness. The danger of anarchy is avoided by reason of the fact that Hinduism is, at the same time, a fully organised and articulated social system. However frequently and completely the spiritual cabinet may change, the permanent department of caste carries on the government and maintains continuity. In this lies its strength to resist assaults upon the reasonableness or the truth of its doctrinal tenets. However it may be stricken and overcome as a system of truth, so long as it retains its authority as a social system it is unconquered and presently its vigour revives. But in this also lies a fundamental weakness, for time will at the last wear out even the most tenacious social system that rests on privilege and prejudice; and if, by that time, the spiritual content of Hinduism has not found a fitter tenement, the one may perish with the other' (p. 65). . . . 'This religion is striving, with a success that is certain to be increasing and enduring, to slough its superstition and to recover and conserve the spiritual contents of its ancient heritage' (p. 66). But he urges that 'no thoughtful observer, whether Indian or European, will deny that the main factor in producing the movement of thought and the recombination of beliefs in the country is Christianity' (p. 67). He refers specially to the new Vedāntism,

'which has overshadowed the old Theistic churches, like the Brahma and Arya Samaj.'

There are three main factors in securing Hinduism in the crisis which is now imminent. The first is the general acceptance of the system of caste, with the social rights which it confers, and the social duties which it enforces. This system, indefensible though in theory it may be, shows at present no signs of decadence. On the contrary, we find that those groups which possess claims to social respect are most tenacious in asserting and maintaining them; that those in the second rank, that is, below the 'twice-born' classes, are endeavouring to claim equality with them; and that even the depressed and despised races, like the Pariah of the South and the sweeper of the North, are anxiously seeking an escape from their present position, and are quite prepared to join the caste-system whenever its doors are opened to them. The second force is the universal recognition of the power of *dharma*—a term which connotes much, but may be roughly explained as personified social law. The third is the influence of women: 'without their support, both Brāhmanism and Hindūism would rapidly collapse' (Monier-Williams, 388).

As regards the influence of foreign creeds, Islām wins adherents by its clear-cut monotheism, and its democratic constitution, which, to a large extent, frees the convert drawn out of the lower ranks of society from the bondage of caste. Its religious ideals—action as opposed to hypnotic contemplation—its practical spirit which allots a single life to man and bids him make the best of it, its repudiation of the doctrines of *karma* and transmigration, commend it to the vigorous and progressive sections of the community. It is, again, highly eclectic, offering shelter to the fanatical Wahhābī, who is a puritan in spirit, while it also receives the low caste convert, whose animistic preferences are met by that worship of saints, their tombs, and relics, which is an abomination to the Wahhābī. It is thus rapidly increasing, not so much as the result of a regularized religious propaganda, for which its lack of organization renders it incompetent, as by a process of natural growth, due to the liberality of its marriage rules and the absence of restrictions in the matter of diet.

Christianity, in the same way, offers a new hope to the Animist, haunted by a host of greedy, malignant demons. Its future progress depends upon the regulation of its missionary methods—a question which cannot be considered here. In the near future it will probably be obliged to modify its dogmas to suit the new environment, many competent observers, for instance, admitting that the Indian Christianity of the future will necessarily take a Vedāntic colouring. The discussion of missionary methods involves many tangled problems; as, for example, whether it is possible or advisable to revert to the type of propaganda employed with such striking, but only temporary, success by St. Francis Xavier, and, with less sensational but perhaps more enduring results, by Dubois, who deliberately accepted the rôle of the *yogi* and followed the ascetic rule of life; whether educational and philanthropic work is more or less effective than a policy of active proselytism; whether it is possible for the missionary to combine with his other activities the study of Hindu philosophy and dialectics and the investigation of the animistic cults of the forest and menial tribes, among whom the prospects of success are most favourable; whether in the future the morals and modes of thought of professing Christians will assist or impede the spread of Christianity.

On questions such as these and others raised in the course of this article it is presumptuous to

speculate, because the religious situation is at present in a condition of instability, and is liable at any time to be modified in unexpected directions. We need a more sympathetic attitude towards the measures of reform which are now in progress, and a wider knowledge of the working and development of the system of caste, of asceticism and monasticism, of the ritual of temple worship and domestic rites, of abnormal cults, such as those of the Śāktas and Vaiṣnavas, of the beliefs and practices of the forest, menial, and nomadic tribes. In all these departments the information at present available is fragmentary, incomplete, and often misleading. Such inquiries will throw much light on the darker places of Hinduism, and may stimulate the work of the reformers. Above all, we must endeavour to rid ourselves of the prejudices natural to Western inquirers in attempting a detailed examination of this ancient and highly developed polytheism. In India we possess a greater and more important storehouse of information for the study of comparative religion than is perhaps available in any other region of the world. But its secrets will remain hidden except to those who possess the only key to its treasures—the feeling of sympathy which will encourage their guardians to disclose the mysteries to foreign inquirers. To quote the words of Dill in relation to the decaying paganism of Rome:

'The gulf which separates us from the world of heathen imagination is so wide, and old associations in matters of religion are so powerful, that we may easily do injustice to the devout sentiment of paganism. Grotesque or barbarous religious symbols, even those tainted in their origin with the impurity attaching to nature-worship, often sloughed off their baser elements, and with the development of a more sensitive morality, and a higher conception of the divine, may have been the vehicles of a real religious emotion. What the worshipper will find in a worship depends greatly on what he brings' (*Roman Society in the Last Century of the Western Empire*, London, 1898, p. 84).

LITERATURE.—Under the various articles dealing with the many phases of Hinduism a special bibliography is given, and many of the more important books have been quoted throughout the article. Here it is necessary only to name those works which are useful for a general survey of the subject or throw light on special topics.

I. GENERAL ACCOUNTS OF ONE OR MORE ASPECTS OF HINDUISM: L. D. Barnett, *The Heart of India*, London, 1909, *Brahma-Knowledge*, do. 1907, *Hinduism*, do. 1908; A. Barth, *The Religions of India*, Eng. tr., London, 1882; H. T. Colebrooke, *Essays on the Rel. and Philos. of the Hindus*, do. 1858; J. A. Dubois, *Hindu Manners, Customs, and Ceremonies*, ed. H. K. Beauchamp, Oxford, 1906; P. Deussen, *Philos. of the Upanishads*, Eng. tr., Edinburgh, 1906; H. J. Eggeling, 'Hinduism,' in *EBR*¹ xiii. 501 ff.; J. N. Farquhar, *A Primer of Hinduism*², Oxford, 1912; R. W. Frazer, *Lit. Hist. of India*, London, 1898; E. W. Hopkins, *The Religions of India*, do. 1896; C. N. Krishnaswami Aiyer, *Sri Madhwa and Madhwaism*, Madras, n.d.; C. N. Krishnaswami Aiyer and Pandit Sitanath Tattvabhushan, *Sri Saṅkarāchārya: his Life and Times, his Philosophy*³, do., n.d.; M. M. Kunte, *The Vicissitudes of Aryan Civilization in India*, Bombay, 1880; A. C. Lyall, *Asiatic Studies*², London, 1907, 'Hinduism,' in *Rel. Systems of the World*, do. 1889; A. A. Macdonell, *Hist. of Skr. Lit.*, do. 1900, *Ved. Mythol. (GIAP, Strassburg, 1897)*; A. A. Macdonell and A. B. Keith, *Vedic Index of Names and Subjects*, London, 1918; J. D. Mayne, *Hindu Law and Usage*, do. 1878; J. Murray Mitchell, *Hinduism Past and Present*², do. 1897; M. Monier-Williams, *Hinduism*, do. n.d., *Brāhmanism and Hindūism*⁴, do. 1891, *Ind. Wisdom*, do. 1875; J. Morrison, *New Ideas in India during the 19th Cent.*, do. 1907; J. Muir, *Orig. Skr. Texts*, do. 1858-72; F. Max Müller, *Chips from a German Workshop*, do. 1867-75, *Contrib. to the Science of Mythol.*, do. 1897, *Hist. of Skr. Lit.*, do. 1869, *Lects. on the Origin and Growth of Religion, as illustrated by the Religions of India (HL, do. 1878)*, *Selected Essays on Language, Mythology, and Religion*, do. 1881, *India, What can it teach us*⁵, do. 1883; Guru Prasad Sen, *Introd. to the Study of Hinduism*, Calcutta, 1893; Shridhar V. Ketkar, *An Essay on Hinduism, its Formation and Future*, London, 1911; T. E. Slater, *The Higher Hinduism in relation to Christianity*, do. 1902; W. Ward, *View of the Hist., Lit., and Relig. of the Hindus*⁶, do. 1817; A. Weber, *Hist. of Ind. Lit.*, Eng. tr., London, 1878; W. J. Wilkins, *Modern Hinduism*, do. 1887, *Hindu Mythology, Vedic and Puranic*, Calcutta, 1882.

II. TRANSLATIONS OF THE SACRED BOOKS OF THE EAST: see esp. F. Max Müller, *The Upanishads*; G. Bühler, *Sacred Laws of the Aryas, Institutes of Manu*; J. Jolly, *Institutes of Viṣṇu*; K. T. Telang, *Bhagavadgītā*; J. Eggeling, *Satapatha Brāhmaṇa*; H. Jacobi, *Jaina Sūtras*; G. Thibaut,

Vedānta Sūtras—all published in the Oxford Series, 1879-1900. To these may be added M. Haug, *The Aitareya Brahmanam*, Bombay, 1868; Kesari Mohan Ganguli, *Mahābhārata*, Calcutta, 1893-96; R. T. H. Griffith, *Rāmāyana*, Benares, 1895; F. S. Growse, *Rāmāyana of Tulsī Dās*, Allahabad, 1877-80.

iii. **GENERAL HISTORIES OF INDIA:** Mountstuart Elphinstone, *Hist. of India*⁶, London, 1874; H. M. Elliot, *Hist. of India, as told by its own Historians*, ed. J. Dowson, do. 1867-77; V. A. Smith, *Early Hist. of India*², Oxford, 1908, *Aśoka*², do. 1909, *History of Fine Art in India and Ceylon*, do. 1911; the series of trr. of Gr. and Lat. authors describing India, by J. W. McCrindle, *Anc. India as described by Megasthenes and Arrian*, Calcutta, 1877, *The Commerce and Navigation of the Erythraean Sea*, London, 1879, *Anc. India as described by Ktesias the Knidian*, do. 1882, *Anc. India as described by Ptolemy*, do. 1885, *Anc. India as described in Classical Literature*, do. 1901, *The Invasion of India by Alexander the Great*, 1st ed. 1893, 2nd ed. 1896. See also trr. of the travels of the Buddhist pilgrims—*Fa-hien*, by J. Legge, Oxford, 1886; *Siyu-ki, Buddhist Records of the Western World*, by S. Beal, London, 1884. Other important books on early Buddhism are: A. Cunningham, *The Bhilsa Topes*, London, 1854, p. 154, *Mahābodhi*, do. 1892, *The Stupa of Bharhut*, do. 1879; T. W. Rhys Davids, *Buddhism*, do. 1878, *Buddhism, its Hist. and Lit.*, New York, 1896, *Origin and Growth of Religion, as illustrated by Indian Buddhism* (HL, London, 1881), *Buddhist India*, do. 1903. On Jainism: J. G. Bühler, *The Indian Sect of the Jainas*, ed. J. Burgess, London, 1903; U. D. Barodia, *History and Literature of Jainism*, Bombay, 1909; H. Warren, *Jainism*, Madras, 1912.

iv. **GENERAL TREATISES ON THE ETHNOLOGY OF INDIA:** M. A. Sherring, *Hindu Tribes and Castes in Benares*, Calcutta, 1872-81; H. H. Risley, *TC*, do. 1891-92; D. C. J. Ibbetson, *Punjab Ethnography*, do. 1883; J. Wise, *Notes on the Races, Castes, and Trades of Eastern Bengal*, London, 1883; E. T. Dalton, *Descr. Ethnol. of Bengal*, Calcutta, 1872; W. Crooke, *TC*, do. 1896, *PR*², London, 1896; E. Thurston, *Castes and Tribes of S. India*, Madras, 1909, *Omens and Superstitions of Southern India*, London, 1912; H. A. Rose, *A Glossary of the Tribes and Castes of the Punjab and North-West Frontier Province*, Lahore, II. (all published 1911); A. Baines, 'Ethnography (Castes and Tribes),' in *GIAP*, Strassburg, 1912.

v. **THE SERIES OF CENSUS REPORTS.** of which the most useful are: *India*, by J. A. Baines, Calcutta, London, 1893, E. A. Gait and H. H. Risley, 1903, the latter revised and reprinted in part as *The People of India*, Calcutta, 1908; *Bengal*, by C. J. O'Donnell, 1893, E. A. Gait, 1902; *Assam*, by E. A. Gait, 1892, B. C. Allen, 1902, J. McSwiney, 1912; *Punjab*, by D. C. J. Ibbetson, 1883, E. D. MacLagan, 1892, H. A. Rose, 1902, Pandit Harikishan Kaul, 1912; *Bombay*, by J. A. Baines, 1882, R. E. Enthoven, 1902, P. J. Mead and G. L. Macgregor, 1912; *Madras*, by W. Francis, 1902, J. C. Molony, 1912; *Mysore*, by T. Ananda Rao, 1903, V. R. Thyagaraja Aiyar, 1912; *Baroda*, by J. A. Dalal, 1902, Govindbhai H. Desai, 1912; *Travancore*, by N. S. Aiyar, 1903, N. Subramanya Aiyar, 1912; *North-West Frontier Province*, by C. Latimer, 1912; *United Provinces of Agra and Oudh*, by E. A. H. Blunt, 1912.

vi. **VARIOUS MONOGRAPHS ON SPECIAL SUBJECTS:** J. M. Campbell, *BG*, Bombay, 1873-1901, *Notes on the Spirit Basis of Belief and Custom*, do. 1885; E. T. Atkinson, *Himalayan Gazetteer*, Allahabad, 1882-84; B. L. Rice, *Gazetteer of Mysore*, 1897, *Mysore and Coorg from the Inscriptions*, 1909; V. N. Aiyar, *State Manual of Travancore*, 1908; C. Achyuta Menon, *Cochin State Manual*, Ernakulam, 1911; *Bulletins of the Madras Museum*, ed. E. Thurston, Madras, 1897 ff.; E. Thurston, *Ethnographic Notes in S. India*, do. 1906; L. K. Anantha Iyer, *Cochin Tribes and Castes*, do., I. (1909), II. (1912); the series of monographs on the tribes of Assam: P. R. T. Gurdon, *The Khasis*, London, 1907; E. Stack, *The Mikirs*, do. 1908; T. C. Hodson, *The Meithei*, do. 1908, *The Naga Tribes of Manipur*, do. 1911; A. Playfair, *The Garos*, do. 1909; S. Endle, *The Kachāris*, do. 1911; J. Shakespear, *The Lushai Kuki Clans*, do. 1912; V. Kankasabhai, *The Tamils: Eighteen Hundred Years Ago*, Madras, 1904; H. Kern, *Manual of Ind. Buddhism* (GIAP, Strassburg, 1896); J. E. Padfield, *The Hindu at Home*, Madras, 1896; Shway Yoe [J. G. Scott], *The Burman, his Life and Notions*, London, 1882; *Gazetteer of Upper Burma and the Shan States*, Rangoon, 1900; Sarat Chandra Roy, *The Mundas and their Country*, Calcutta, 1912. W. CROOKE.

HINGLĀJ (said to be derived from Skr. *hiṅgula*, a preparation of mercury with sulphur, vermilion; possibly, on account of the smearing of a sacred stone with red pigment, a survival of a more primitive blood-sacrifice [Tylor, *PC* ii. 164]).—One of the most famous places of pilgrimage in Baluchistān; situated in lat. 25° 30' N., long. 65° 31' E., in British Makrān, on the W. bank of the Hingol river, a few miles from its mouth. The place is specially interesting inasmuch as it is the furthest western point to which Hindu polytheism extends. By Hindus it is held sacred to the goddess Pārvatī, Mātā, or Kālī, the mother-goddess in her malevolent form. The local legend

tells that after the quarrel between Śiva and Dakṣa, Viṣṇu cut in pieces the body of Ūmā, wife of Śiva, and that the crown of her head fell here (*Gopatha Brāhmaṇa*, Calcutta, 1872, p. 30 ff.; *Ain-i-Akbarī*, tr. Blochmann and Jarrett, do. 1873-94, ii. 313).

Like many other sacred places in the East, Hinglāj is venerated by other faiths. Muhammadans revere it as the abode of Bibī Nānī, 'the lady grandmother.' This title, as was suggested by Masson (*Narrative of a Journey to Kalāt*, 1843, p. 391), may be identified with Nanea (RV *Nanea*) of 2 Mac 1¹²⁻¹⁵, the mother-goddess, worshipped in Syria, Persia, and Armenia, and other parts of Asia, under the titles of Anaiti, Anæa, Aneitis, or Tanais, the primeval Babylonian goddess Nanā, the Lady of the temple E-anna of her city Uruk (Erech) (*HDB* iii. 485; G. Maspero, *Dawn of Civ.*, Eng. tr.², London, 1896, p. 665 ff.; M. Jastrow, *Rel. Bab. Assyr.*, Boston, 1898, i. 81, 85, 206). Scholars are now beginning to admit that there is possibly a stratum of Babylonian culture underlying the early civilization of India, either antecedent to, or possibly influencing, the Aryan or Dravidian culture, or both. This view seems to be not unreasonable. The Tell el-Amarna records disclose an extension of Bab. culture in W. Asia as early as the 12th cent. B.C., and a wave of the same culture may well have passed eastward, particularly if, as Risley (*Census of India*, 1901, i. 509 ff.) remarks, remains of buildings, irrigation works, and terraced cultivation indicate that at an early period—how early it is at present impossible to decide—Baluchistān, which now is largely desert, was a highly cultivated, thickly populated country (see **HINDUISM**, § 5). It is not possible to assign a date to this western extension of Hindu polytheism; but it is certain that long before the invasion of Maḥmūd of Ghaznī (A.D. 1001-30) the mass of the people in that region were Buddhists (H. M. Elliot, *Hist. of India*, London, 1867-77, i. 136, 147, 190, 504); and this condition of things must have existed from a very much earlier period.

This inaccessible shrine has been visited by few Europeans. The best account of it is that of Goldsmid, who explored it in 1861. Moving along the course of a stream bisecting the Hinglāj hill (3740 ft. high), he observed the place of sacrifice, a hollow in the hill smeared with the blood of animals sacrificed to the goddess, and the rocks decorated with sectarian marks (*tilak*) in a red pigment. From this place up to the temple itself many of the stones under foot were smeared with blood. About a quarter of a mile higher up the hill is the shrine itself, quite surrounded by mountain peaks. It 'boasts of no architectural magnificence or beauty. It is the sort of thing that an infantine taste for architecture would create out of wooden toy bricks. But its appearance and site are in good scenic effect.' In a cavity to the left, far deeper and more confined than the sacrifice hollow, is visible, surmounted by a long arch of pale sandstone, the so-called abode of Marī or Nānī, the presiding goddess of the place. It is a low castellated mud edifice with a rude wooden door. In the penetralia of the temple 'we found the shrine of the goddess. Two diminutive domes, one at the head and the other at the foot, of short, tomb-shaped mud erection, marked the chosen sanctum of this divinity of the Hindu pantheon. A wooden rail has been set at the front and at the sides.' This, as is the case at the shrine at Pandharpur and at other places, seems to be intended to prevent access to the holy place. 'Some rods steeped in vermilion were placed near the wall at the back. These were intended for the use of pilgrims unprovided with the wand of office borne by their *aguas*, or leaders.' The ritual

directs that the worshipper should creep on all-fours through a narrow entrance, and it is believed that no person burdened with grievous sin can accomplish this feat.¹

There appears to be no image of the goddess; at least, nothing of the kind is noticed by travellers. Though situated in a dreary, desert region, Hinglāj is surrounded by abundant verdure—the wild plum and various other shrubs and flowering plants; one report states that 'near the Hinglāj Ziārat [shrine] there is verdure enough to make glad the heart of a pilgrim even from Southern India. To the Panjābī it must be a veritable garden of Eden.'

Bands of pilgrims from all parts of India, each conducted by a leader known as *agwā*, make the journey by land from Karāchi. Fees are collected at Miāni by a *bhārtī*, or hereditary pilgrim overseer, from all except devotees and unmarried girls. The proceeds amount to about £40 annually. On the return of the pilgrim, at Tatta he is invested with a string of white beads like grains of pulse, which, he is told, is the petrified grain of the Creator, left on earth to remind men of the Creation. These are found and pierced at Jhirak in Sind (Burnes, *Travels into Bokhara*, ii. 33 f.). A native pilgrim, Hāji Abdul Nabī, who recently visited Hinglāj, adds that near the shrine is a well,

'the water of which rises up at times with a bubbling noise, discoloured like that of a river fresh swollen after rain, and carrying mud in suspension. The Hindu pilgrims, when this takes place, throw in betel-nuts, cloves, cardamoms, and coconuts. Should there be a delay in the rising, pilgrims in the most abject manner call on Mātā to give them a sight of herself, exhorting each other to reveal their sins and inwardly repent. When the water rises, they salaam with both hands joined, and throw in their offerings, which, after some time, on a second rise, are brought back again, when they are collected and formed into large cakes, which they bake near the spot.'

It is thus an example of those oracular wells from which omens are taken in many parts of the world (Frazer, *Pausanias*, London, 1898, iii. 388, iv. 151). The shrine is much frequented by the Kāpdī devotees of the goddess Āsāpūrnā, 'she who fulfils desires,' who is much revered in Cutch. It is said that, if dawn overtake their Rājā or headman at the Hinglāj hill, the goddess will drown or otherwise destroy him (*BG* ix. [1901]

¹ The habit of creeping under a sacred stone or through an orifice pierced in it is common in many parts of the world. Sometimes the intention seems to be that the person performing the rite may receive some benefit from the stone, or rather bring himself into communion with the spirit occupying it, and thus gain some spiritual or material advantage. This belief is illustrated by the English custom of passing children through a cleft ash-tree as a cure for rupture or rickets, a sympathetic connexion being thus established between them and the tree (J. G. Frazer, *GP* iii. 394 ff.). E. W. Lane (*Mod. Egyptians*, London, 1860, i. 325) describes how women pass in silence, with the left foot forwards, seven times under and over the stone table on which the bodies of decapitated criminals are washed before burial, as a cure for ophthalmia, to obtain children, or to expedite delivery. Musalmāns at Samarkand creep under the marble desk which holds the Qur'ān in the great mosque as a cure for spinal disease (E. Schuyler, *Turkistan*, London, 1876, i. 250). The custom of creeping through the *foramina* of rocks, dolmens, and other megalithic monuments is common in Ireland as a means of procuring spiritual benefits (W. C. Borlase, *The Dolmens of Ireland*, London, 1897, iii. 757 ff.). Women in Gujarāt creep under the litter of a Jain monk when he has taken the vow of suicide by abstinence, believing that they thus obtain male offspring by communication with the spirit of the holy man (A. K. Forbes, *Rās Mālā*, London, 1878, p. 611). In the present case the performance of the feat is regarded as a test of virtue or chastity. At the tomb of a Musalmān saint at Baroda there is a perforated slab, through which it is believed that no thief can creep; and at Malabar Hill, near Bombay, a famous perforated rock is supposed to purify or regenerate those who pass through it, as the Mahārājā of Travancore, on his installation, passes through a golden cow, and thus becomes a member of the 'twice-born' class (*BG* vii. [1883] 548; J. Douglas, *Bombay and W. India*, London, 1893, ii. 240 n.; S. Mateer, *Land of Charity*, do. 1871, p. 69; E. Thurston, *Ethnographic Notes*, Madras, 1906, p. 271). A good instance of the rite as a test of virtue is found in the case of the 'threading' of St. Wilfrid's 'Needle' in the crypt of Ripon Cathedral (*FLJ* ii. [1884] 286 f.; R. Burton, *Anatomy of Melancholy*, ed. Shilleto, London, 1893, iii. 328; *NQ*, 8th ser., iii. [1893] 335 f.).

pt. i. p. 85). The goddess has another shrine on a hill at Cheul in the Kolāba District of the Konkan (*ib.* xi. [1883] 287, 301). The Hinglāj Devī is revered throughout India. A Rājputānā legend tells that Ugrā Prabhū, one of the early rulers of Mār-wār, made a pilgrimage to her shrine, and that the goddess caused to rise from her fountain a magic sword with which he conquered all the southern countries touching the ocean (Tod, *Annals of Rajasthan*, Calcutta reprint, 1884, ii. 6). She is the family-goddess of many tribes in W. India (*BG* v. [1880] 49, 74, ix. [1901] pt. i. p. 247); and even as far west as Mirzapur in the United Provinces the Kharwārs sacrifice a goat to her, saying: 'O Devī Hinglāj! Go and destroy my enemy!' (*NINQ* i. [1891] 195). Many Dasnāmī Gosāins from western Bengal make the pilgrimage to her shrine (Buchanan, in M. Martin, *Eastern India*, London, 1838, i. 197).

LITERATURE.—This article is based mainly on a collection of original, unpublished reports on the place, for which the writer is indebted to Mr. R. Hughes-Buller, Superintendent of the Ethnographical Survey of Baluchistān. Among accounts by earlier travellers may be noted: C. Masson, *Narrative of a Journey to Kalāt*, London, 1842-43, p. 390 ff.; A. Burnes, *Travels into Bokhara*, do. 1834, iii. 82 ff.; M. Postans, *Cutch*, do. 1839, p. 166; A. W. Hughes, *Gazetteer of Sind*, do. 1876, ii. 96 f., also *Balochistan*, do. 1877, p. 148 f.; T. H. Holdich, *The Indian Borderland, 1880-1900*, do. 1901, p. 206.

W. CROOKE.

HISTORIOGRAPHY.—The profound changes which have so drastically altered the whole situation in the religious thought and practice of modern times make their appearance in various spheres, and assail the traditional Christian view of the world from the most diverse quarters and with the most manifold results. To begin with, there is the modern conception of Nature, which, as comprised in the mathematico-mechanical method, has dissolved the purely metaphysical teleology of Nature given by Aristotle, demolished the cosmology of the Bible, and provided modern philosophy with all its essential problems. There is, secondly, the new conception of history, which has radically altered our whole attitude to the past and the future, and with which the present is a link in the whole concatenation of things. Thirdly, there is the modern ethics of humanity, which, besides the unworldly virtues of love to God and one's neighbour, has emphasized the intrinsic excellences of artistic and scientific culture—treating them, indeed, as peculiar and indispensable ideals—and has also recognized the positive ethical imperatives involved in political, social, economical, and industrial problems. There are, finally, the new conditions of social life on its economical and industrial sides, and the sociological mode of thought issuing from them, which, in contrast to mere abstract speculation, insists upon the novelty of the whole situation in its social and economical aspects. The first three movements sprang from the Renaissance, while the fourth is a product of the Illumination, and, under the influence of 19th cent. thought, has become a force that towers above all else.

Among these various tendencies, of course, there exists a manifold inter-relation and inter-action. But, if they are to be properly understood, they must be isolated and severally analyzed. In this article only the second, i.e. modern historical reflexion, will be specially dealt with, and its nature and results set forth in the shortest possible compass.

I. The development, function, and results of modern historiography.—In history, as in natural science, systematic thought is the product of a relatively high state of civilization. Primitive man is content with the recollections of his family and clan, his tribe and race. As all unknown things coalesce in his mind with religion and mythology, so, in particular, his ideas of the

beginning and primitive history of things are bound up with religious cosmology, the myths of holy places, and the legends of his tribal deities. In this domain he delights in the extraordinary and the fantastic, the ingenious and the intricate. Hence the beginnings of history are found in religious traditions, legends, myths, and tales, and among almost all peoples primitive recollection is embedded in a vast romanticism. At this stage there is not the slightest trace of a desire for real knowledge or of a critical spirit. And not only does primitive man lack the sense of continuity and criticism; he likewise tends to regard himself as something apart and absolute. His origin, his mode of life, and his morality seem to him to be the only true and primordial forms, in comparison with which all that is foreign is barbarian and inferior. The ties of custom and morality avail only in his own circle, and do not concern those beyond it. He has no conception whatever of the unity of mankind or of the concatenation of events. The chronological eras with which he deals are purely fanciful—sometimes idyllically short, sometimes fabulously long. The only people of ancient times who in the fullest sense consciously passed beyond this stage of popular legendary reminiscence, of priestly tradition and royal annals, were the Greeks; and in this, as in all other provinces, it was they who laid the foundations of science. Among the Greeks, the traveller and the inquirer, untrammelled by the traditions of temples and the archives of princes, and impelled only by a thirst for knowledge, began to investigate and reflect historically. Here Herodotus, Thucydides, and Polybius, partly as a result of their contact with the non-Hellenic world, partly from the need of elucidating their own people's affairs and the operation of them, and, finally, impelled by their predilection for a philosophical generalization of knowledge, laid the foundations of history as an explanation of public movements by material or psychological causes, and, in particular, as a reasoned concatenation of events occurring in the *Europæo-Asiatic* arena. Even these early writers took account of analogies and uniformities with a view to reaching general historical conceptions; and in their idea of a Hellenic civilization, and, later, of a cosmopolitan civilized State organized by the Roman Empire, they had a focus into relation with which they endeavoured to bring all that occurred.

These earliest manifestations of historical reflexion, however, were extinguished by Christianity and the great religious revolution of later antiquity. It is true that Christianity itself operated throughout with historical conceptions of universal application, and that for the purely anti-barbarian civilized State it substituted the central conception of humanity, and a supreme ethical and religious end for the race. These provided new and powerful incentives to historical reflexion. In reality, however, they served to produce, not a scientific, but a revived mythological representation of history. The early Christian conception of mankind, alike as regards time and as regards space, was narrow in the extreme, and was involved in all manner of purely speculative pre-conceptions. The history of the human race, with respect to both its beginning and its end, was saturated with mythology; in the middle stood the miracle of the Incarnation and the rise of the Church. Interest was once more concentrated upon the inexplicable, and the desire to explain came to be regarded as the mark of a profane mind. Heathen and Biblical myths regarding the origin of things were combined: Paradise with the Golden Age, the primeval transgressions of Cain and Ham with the spiritual lapse to the Silver and Iron Ages, Nimrod's tower-

building with the Trojan war; and, again, the Messianic outlook of the prophets with the hymns and eclogues of Vergil; the miracles of Elijah, of saints and martyrs, with those of Orpheus and Herakles. In the eschatological sphere, again, the Second Advent of Christ was brought into connexion with the universal conflagration of the Stoics, Heaven with Elysium, Hell with Hades, and the stages of the soul's purification with the *Empyræan*. The history of the intervening period fell into three parts: a relatively short and wholly supernatural period, in which prophecy and miracle prepare the way for the coming of the God-man; an intermediate epoch, in which the God-man Himself appears as the bodily investment of the whole supersensual world, leaving behind Him His permanent incarnation in the Church as a Divine institution for the redemption and salvation of man; and, finally, the longer and for the most part non-miraculous era of secular history, which, although it is largely controlled by Satan and by demons, does not wholly fail to show the intervention of a redeeming God. The mythology of redemption, assimilating the mythical traditions of the ancients, now takes the place of historical reflexion. The all-embracing scheme of the four Danielic world-kingdoms was constructed by Jerome, and held its ground till the 18th century. Mediæval thought grafted its histories of the world and of nations upon this scheme, and combined with it its love of the fabulous and its legends of the saints. The fresh narratives of fact or arid annals occasionally incorporated with them produced no essential modification.

It was in reality Humanism and the Renaissance that first reverted to the traditions of ancient historical composition and historical reflexion, and thus laid the foundations of modern historiography—as in the school of Bruni, where it was influenced by the style of the ancient rhetoric; in that of Blondus, where it showed proficiency in the rendering and criticism of documents; and in that of Machiavelli and Guicciardini, where it sought to explain events by their psychological and material causes. Wherever the culture of the Renaissance took root, there also modern history was evolved, being written, for the most part, by commission of State. From this, again, sprang the historiography of the Illumination in the school of Voltaire, in the hands of Hume, Gibbon, Robertson, and Schlözer—a type of history which elaborated and appraised its materials with the freedom of an emancipated scholarship, extended its operations to the whole compass of human history and to the various factors of civilization, and, in its criticism of tradition as in its psychological explanations and its search for causes, far surpassed the methods of antiquity and the Renaissance. Then, in the 19th cent., there arose philological criticism, the idea of organic evolution, the new analyses of the State and of parties, pre-historic ethnography, the historical study of economics and society, the development of a history of art, of literature, and of religion, taking a place beside the too restricted political history, and, finally, the expansion of politics on a world-wide scale in its bearing upon European events.

This vast array of facts, ideas, and judgments has greatly amplified and complicated the subject-matter of historiography, has made its procedure more delicate and more difficult, and has enormously enlarged and at the same time disintegrated the web of causality. From all this has accrued an immense mass of historical work, moving on various lines, yielding magnificent results, and, nevertheless, with every supposed solution of its problems, giving rise to a fresh group. The total result, however, is not a mere mass of unsolved

problems, but is rather the full development of modern historical reflexion, which, notwithstanding all misgivings as to its conclusions, consists, precisely like the modern conception of Nature, in a purely scientific attitude to facts. The history of mankind merges in the evolutionary history of the earth's surface; it takes its rise in the prehistoric life of primitive peoples; it is determined throughout by the general laws of geographical conditions, and by the various phases of social life, and forms an unspeakably complex, yet altogether coherent, whole of immeasurable duration both in the past and in the future. It is as a part of this array and system that we must survey and estimate our own existence, and find its rationale and origin. On the analogy of the events known to us we seek by conjecture and sympathetic understanding to explain and reconstruct the past. From this point, again, we advance to the criticism of extant traditions and to the correction of generally accepted historical representations. Since we discern the same process of phenomena in operation in the past as in the present, and see, there as here, the various historical cycles of human life influencing and intersecting one another, we gain at length the idea of an integral continuity, balanced in its changes, never at rest, and ever moving towards incalculable issues. The causal explanation of all that happens, the setting of the individual life in its true relations, the interpretation of events in their most intricate interaction, the placing of mankind in a rounded system of ceaseless change—these constitute the essential function and result of modern historical reflexion. The latter, viewed as a whole, forms a new scientific mode of representing man and his development, and, as such, shows at all points an absolute contrast to the Biblicotheological views of later antiquity.

2. The purely scientific character of historiography.—Modern historical reflexion, precisely because of what has been said, certainly involves a multitude of fresh and difficult problems. These relate partly to the significance of such a view of history for our conceptions of ideal truth, and for our theory of the universe in general, and partly to the question regarding the scientific nature of historical study itself. The latter is the more restricted problem, and must be discussed first. It is, at the same time, the only problem that is directly concerned with historical reflexion as such. Here it is necessary to emphasize one particular principle. In so far as historical thought purports to be scientific, its specifically theoretical or scientific element must be clearly marked off and defined. For, besides the purely scientific attitude to historical fact, there are numerous other attitudes which must be rigorously distinguished from it, but are seldom distinguished in a proper degree. There is, for instance, the æsthetic attitude to history, which centres in its teeming wealth of incident, and the suggestive action and romantic charm of the individual; or which is concerned with an artistically rhythmical construction of the course of events. There is mere curiosity, and that liking for the remarkable, the astonishing, and the unconformable which is ever ready to be excited and kindled to sympathy by graphic description. Then there are some whose aim it is to estimate the ethical value of human actions, and to derive from history an insight into that which reveals itself everywhere as moral force. Others, again, see in history a manual of politics and a means of educating national and political opinion—an education which, they hold, can never be acquired by merely abstract doctrines, but results only from the concrete observation of the whole historical process. Some seek in history support for the sociological and

economical principles which, they believe, can be attained only by abstracting from various particular developments, and which must form the basis of our own conception and organization of society. Finally, history often serves as a school of scepticism and caution, on the ground that very divergent representations of historical facts may be given, that criticism is uncertain and tradition not uniform, and that, accordingly, history yields but little real information, and more than anything else brings home to man the limitations of his knowledge.

Now, these various attitudes to the facts of history are all quite competent in their own place and in their own way, and the idea of excluding or avoiding them altogether is not to be entertained. Nevertheless, they all lie outside the purely cognitive and theoretical sphere, and within that of judgment and appraisal. So far as historical study is concerned with distinctively theoretical and scientific interests, these other interests, as being here of secondary importance, must be scrupulously guarded against and excluded. We may grant that, if descriptive historical works were composed upon such rigid lines, they would lack interest and charm for the majority of readers, and that the impression they make depends precisely on the effective combination of purely historical knowledge with the motives and incentives that may be drawn from it. Delineations of this type, however, are necessarily composite, and must be recognized and studied as such. They combine the interest of the first degree, *i.e.* that of purely historical knowledge, with interests of the second degree, *i.e.* those relating to the significance of such knowledge for human feeling and human action. Such works are, accordingly, not purely scientific at all, and historical knowledge is to be obtained from them only by a process of elimination.

What is it, then, that constitutes the essential element of pure historical knowledge? The answer to this question is furnished by the foregoing discussions, and it becomes increasingly clear in the history-writing of the present day. History as pure theoretical science is different from history as an element of *belles lettres*, politics, economics, and the like. In history, as in other things, purely theoretical knowledge is knowledge based upon general conceptions, and that signifies primarily knowledge derived from causal conceptions. The sole task of history in its specifically theoretical aspect is to explain every movement, process, state, and nexus of things by reference to the web of its causal relations. That is, in a word, the whole function of purely scientific investigation. What is so explained may then quite well become the subject-matter of interests lying outside the sphere of theoretic science, and the resultant treatment may unite the two constituents as closely as desired. But it will always be possible and necessary to isolate either element, and this will be the more or less easy as the specifically scientific side has been the more or less conscientiously dealt with.

Only in one single point is this simple process of discrimination attended with any real difficulty. One may ask whether, in view of the peculiar nature of psychical causation, or motivation (which will be more fully discussed presently), the insight necessary to determine and appreciate it must not be drawn from personal experience and personal judgment. Such insight, it will be said, is always bound up with subjective estimates of what ought to be. Thus, *e.g.*, only those who feel that certain ethical, political, and artistic excellences ought to exist will seek and discover them as real springs of action, while those who do not so regard them

will seldom be able to recognize them as motives, and the less so as historical causes do not lie on the surface or force themselves into notice, but are, as a matter of fact, always brought to light by the sympathetic imagination. Such a view is certainly not wrong. Yet it does not subvert our fundamental principle, since the causes so discovered and realized are, in the sphere of historical study, taken account of as facts only, and not as grounds for the corrections and criticisms of the historian, whose subjective attitude to the facts must, accordingly, be once more discounted. Besides, every supposed and, on grounds of analogy, probable cause must be shown to be actually operative in the particular case. Knowledge of the power of motives is thus, as a means of discovery, doubtless bound up with personal judgments, and the knowledge of what should be often serves as a heuristic principle for the understanding of forces actually at work. But the 'ought-to-be' must in turn always be separated from what really is. Historical study is concerned only with the latter, and the personal judgments which have lent keenness to the power of perception must give way before the evidence of the real facts. Historical investigation is, in practice, always subjectively conditioned by the fullness, depth, and range of the personal experience of the investigators themselves, and is thus always marked by irreducible differences in their several starting-points. But the purely scientific aim of historical reflexion is not thereby surrendered.

3. The nature of historical causality.—This brings us at length to what is really our main problem, viz. that relating to the nature of historical causation. Here we find ourselves in the sphere of the logic or epistemology of history. Of the various provinces of knowledge this was the last to be won for modern logic, and it is as yet the most imperfectly elucidated. The Aristotelian philosophy dominant in the Mediæval Church found no difficulty here. It regarded the operations of Nature and the processes of history as essentially of the same kind, and it applied to both spheres a metaphysico-teleological conception of development, and knew nothing of the modern conception of a causality immanent in experience. The latter conception was first set forth by natural science, and by philosophy as modified thereby; but it was, in fact, framed originally to suit Nature only. Down to the time of Herder and Hegel, accordingly, modern philosophy either took no account of history at all, and abandoned it to historians, litterateurs, or theologians; or else brought historical occurrences under a causal conception, which was simply that of natural science philosophically generalized. Descartes surrendered history to the theologians and to revelation; Hobbes and Spinoza treated it in a naturalistic fashion. The naturalistic view prevailed also in the case of Hume and Kant, notwithstanding the great diversity in their respective views of causality. This is the case even to the present day among the successors of Hume—the adherents of the Positivism of Comte—and we need here recall only the names of Buckle and Taine. In the Kantian school, in its development towards Hegel's Panlogism, the knowledge and ætiology of Nature were, on the other hand, subjected to extreme violence by historical thought, inasmuch as the latter became simply the application of the law of dialectical movement to the cosmic process and the course of human affairs. But if this was a violation of natural science, it was no less a violation of historical thought itself, which by such procedure gained only a finer sense of order and continuity, but no clearer comprehension of its own fundamental conceptions. It was only with the return

to the Kantian theory of knowledge, and the emancipation of psychology, that the task of framing a logic of historical science, in contradistinction to the logic of natural science, came to be clearly recognized. Wundt, Dilthey, Windelband, and Rickert were the pioneers of this new and powerful method of investigation.

Here the primary fact was the recognition of the difference between the causality of natural science and that of historical science. The causality of natural science implies the absolutely necessary principle that events are bound together by a changeless, all-pervading, and, in all particular cases, identical law of reciprocity. The scientist demonstrates the laws thus ascertained by artificially constructed examples or experiments, and by means of these submits natural processes to exact calculation. The method finds its highest expression in the establishment of a perfect equivalence between the amount of energy that disappears in the first form of an occurrence and that which re-appears in the second, i.e. the law of mere transformation and quantitative conservation of energy. To this end, by abstracting from all qualitative distinctions, the method of natural science reduces events to mere manifestations of energy, and attends only to the aspects of reciprocity and transformation in the quantity of energy present. Now, historical causation is something entirely different, being almost exclusively a matter of psychological motivation. In the historical sphere nearly everything passes through the medium of consciousness, and in the last resort all turns upon the constant interaction of conscious efforts, into which even the unconscious elements tend to resolve themselves. Thus the peculiar irrational quality and initiative of the individual consciousness make themselves felt in the ultimate result, alike in the individual life and in the life of groups. Here, therefore, it is not permissible to reduce events to non-qualitative forces, or to explain effects by causal equivalence. Then we must also bear in mind the infinite complexity of the motives that arise on all sides and act upon one another—a complexity which gives a special and peculiar character to every particular case, and so defies all calculation and experimental proof. Further, all occurrences, whether in the individual life or in the life of groups, are so affected by the entire psychical condition of the individual or the group that another quite incalculable element is introduced. In the historical process, moreover, there ever emerges the fact of the *new*, which is no mere transformation of existent forces, but an element of essentially fresh content, due to a convergence of historical causes (cf. art. CONTINGENCY, vol. iv. p. 89^a). Accordingly, psychological motivation differs in all respects from natural causation.

It might thus appear that the peculiar character of historical ætiology could be interpreted and methodized by means of psychology, as is proposed by Dilthey and Wundt. But on various grounds this is impossible. For one thing, historical study does not work with psychological motivation alone, but very frequently has recourse to natural causation as well. Polar limitations, glacial periods, earthquakes, famines, destructive winters, uninhabitable regions, and the like, often play a great part in history, and certainly not always by their purely psychological effects. The destruction of Napoleon's army by the Russian winter was due only in part to the psychological effects of the cold; and even in cases where geographical and physiological conditions eventually produce psychical results, we have something very different from purely psychological motivation. Further, psychology cannot supply any kind of real pre-

calculation of historical events and developments. If that were possible, it would imply that the facts of history were known beforehand, and then traced back to the soul, as something that had issued from it. This is the case especially with the so-called folk-psychology, which is simply a rendering of history in terms of psychological laws, but does not explain the former by the latter. Here, indeed, the facts are always anterior to the psychology, and it would be more accurate to say that the history helps to explain the psychology than to assert the converse. The peculiar nature of the causality of motives points, no doubt, to the distinctive nature of historical knowledge, but it cannot properly provide a basis for it. Nor can such basis be found in the subject-matter; it is to be derived from the method alone. The method, however, is determined, not by the subject-matter, but by the epistemological end in view; for knowledge is never a mere reproduction of experience, but always an abstract selection of particular elements of experience for a definite intellectual end. Thus, *e.g.*, the method of natural science is determined by the interest of selecting that aspect of experience in which it manifests itself as absolutely determined by universal laws, and, accordingly, the method in question abstracts from all that is qualitative and individual. The method of historical science, on the other hand, is determined by the object of selecting from the flux of phenomena that which is qualitatively and uniquely (1) *individual*, whether on a larger or on a smaller scale, and of making this intelligible in its concrete and specific relations. It therefore abstracts from the universal laws which may possibly regulate even its subject-matter, but which fail to explain the peculiar and concrete elements of it, and it operates not with the conception of causal equivalence, but with that of individual causes, which, precisely because of their infinite complexity, produce the unique.

Now the method of history, with its logical determination by a distinct intellectual end, answers to the peculiar characteristics of the historical material, just as the method of natural science answers to those of its material. The processes of the physical world demand in greater degree the first-mentioned type of isolating interest (universal law); those of the psychical world, the second (individual causality). It is not the methods themselves, but their respective intellectual ends, that spring directly from the nature of the subject-matter; and, accordingly, the distinctive characteristics of the material correspond in either case to the ends determining the respective methods. The physical world invites us to understand it by the deduction of general laws; the psychical world by a sympathetic reconstruction of the causal connexions in which the actual facts of history have taken shape. Here, then, the true nature of historical knowledge comes to light. Historical knowledge selects its materials as it may require—a national history, a state of civilization, a biography, an intellectual development, etc.—and seeks, by means of the individual causality proper to history, to make it as intelligible as if it were part of our own experience. Even the history of mankind, were it within our grasp, would be a freely selected and individually concrete subject-matter, inasmuch as its development could be understood only as a particular concatenation, and in no sense as an instance of the operation of universal laws. Such purely objective causal explanation, based upon the widest possible experience and the most methodical application of experience, constitutes the distinctive character of history as a pure theoretical science.

Precisely because of this, however, historical thought shows itself to be (2) *conceptual* thought,

though the concepts which it must frame are different from those of the natural sciences. The universal application of the category of causality in the special form of individual causality subjects the entire material to a uniform conceptual mode of treatment. Moreover, the several isolated subjects of inquiry which are to be causally explained in this way are conceptual unities, for which, it is true, we have as yet no logical term, but which may be designated 'historical aggregates' (*historische Totalitäten*). Such would be, *e.g.*, a human life, a nation, a condition of affairs, the spirit of an age, a legal constitution, an economical condition, a school of art, etc. These aggregates are selected freely and one after another by the investigator, but may be re-combined, till at length the highest concept of historical totality, *i.e.* humanity itself, is reached. It is, indeed, true that this highest concept can be described only by the successive descriptions of its separate components and factors. The conception of mankind as a whole, just because mankind cannot be brought within a single, simultaneous, and all-embracing view, can never be more than an incomplete work of the imagination.

Now, inasmuch as these totalities are processes, and internally coherent congeries of phenomena, there emerges a third fundamental principle of historical reflexion—(3) the principle of *development*. This conception must certainly be taken in its purely historico-empirical sense, and must not be confounded either with the idea of development in natural science or with that found in metaphysics. The scientific conception of development signifies the explanation of becoming by the addition of infinitesimal mechanical changes; the metaphysical conception denotes the interpretation of reality as the expression of an absolute intelligence which realizes itself therein. In contradistinction to these, the conception of historico-empirical development denotes the progress that issues from the essential element of certain psychical efforts, the working out of the consequences that are latent in the earliest beginnings, the dynamic element in psychical forces which are not exhausted in a single manifestation, but work out towards a result—forces in which exists a tendency to a development akin to logical evolution. Thus there is development in religious, ethical, and philosophical ideas; likewise in the character of individuals and peoples, as also in forms of government and economic conditions. Wherever this tendency asserts itself, it constitutes a principle that organizes the aggregates, and moves them onward from within—a principle that absorbs and elaborates the various causes, and supplies them with a focus of attraction or repulsion.

Nevertheless, the value of the conception of historical development must not be over-estimated, as it often is at the present day. For, in the first place, it does not mean an infinite progress, but in every particular case implies only a single concrete impulse controlling a given aggregate. It manifests itself in the fact of exhaustion as well as in that of advance. All progressive developments work also towards regression, so as to make room for fresh movements. The conception in question has, therefore, nothing to do with the conception of an unlimited and continuous progress found in the philosophy of history. Then, again, besides the fact of continuity, we must also recognize the fact of historical contingency, *i.e.* the convergence of a series of mutually independent causes (see art. CONTINGENCY, vol. iv. p. 87 ff.). In virtue of this contingency, processes of development are commingled, furthered, amplified, obstructed, and sometimes even completely arrested; though, of course, the syntheses thus fortuitously brought

about may occasionally give rise to new and fruitful developments, for the spiritual life of man has everywhere a tendency to unify the elements of a given situation, however produced, and thus also to mould them into new stimuli to development. To the sphere of accident or contingency belong the supremely important influences of climate, atmosphere, fertility, geographical position, and natural wealth. That sphere also embraces physiological occurrences and conditions—deaths, interbreeding, mixture of races, food-supplies, and the like. To the domain of chance must likewise be reckoned, so far at least as we at present know, the distribution of individual qualities, as, *e.g.*, talent and genius, which sometimes occur but sparingly, sometimes in amazing profusion. It is true that such 'accidents' are rightly so designated only when judged with reference to the conception of historical aggregates and the developmental tendencies that give rise to them. They may, to a very great extent at least, be brought under the conception of natural law. The idea of contingency is, in fact, one in regard to which the historical and scientific modes of thought are discriminated with special clearness.

In the sense specified, accordingly, the causal explanation of historical aggregates constitutes the purely theoretical function of historical investigation. It is certainly obvious that such causal explanation has a rather restricted range. It is dependent upon the existence of a tradition, upon a critical examination of that tradition, and upon the imaginative and synthetic powers of the investigator. It can never re-constitute its objects in their entirety, but must decompose them; it can depict them only consecutively, and never in their simultaneous inter-dependence. Hence it can proceed only by analyzing, and by moving from subject to subject. This explains why the work of history must ever be taken up afresh. The accession of new material, the fresh sifting of facts by criticism, new ideas and views in the linking of causes to historical aggregates—all of these call for ever new beginnings, and lead to a revision of previous delineations. The writing of history can never be exhaustive, and never complete; it will never be able to compass the All in its extension and in its intension. It will never be able fully to analyze the individual peculiarities of souls or groups of souls, or to explain that power of initiative and self-determination which we call freedom. It will never be able to find the ultimate derivation of a historical world of personalities, or even of the movements at work within that world, in anything else. There will always be limits to its realization of its intellectual end, and always residua incapable of being rationally determined. But the writing of history is not on that account futile or valueless. For it enables man to comprehend himself so far as a causal comprehension of himself is possible or necessary. It is, in fact, only on the basis of such causal self-comprehension that our own historical work can be clearly and circumspectly extended. The ages of naive traditionalism and naive rationalism required no such understanding of oneself. But, as they pressed against their narrow bounds, and made a beginning with historical reflexion, they found it necessary to carry the latter to its ultimate issues. The cultured man of to-day is a person who thinks historically, and can construct his future only by means of historical self-knowledge. This holds good for every sphere of life, even for the religious sphere, in which, it is true, such self-knowledge is still opposed by the naive traditionalism and rationalism of large masses of mankind.

4. The relation of historiography to the philo-

VOL. VI.—46

sophy of history.—Our concern with history, however, is by no means exhausted in causal interpretation and the formation of aggregates. For, on the one hand, there arises the problem regarding the relation of the historical process in the world to the fundamental forces of the universe, and, on the other, the problem regarding the significance of that process for the living and operative will of each particular age—the will which is nurtured by the events of history, and yet manifests at every instant a creative power of its own. To the former problem belong the questions concerning the foundation of the psychical world in the Universal Spirit, the connexion between the physical and the psychical world, the Divine direction and sustaining of the cosmos, and the distinction between the purely natural life of the soul and the spiritual and civilized life that strives to transcend it. The second problem comprises the questions relating to the teachings of history for the active and constructive will, to the inward meaning and significance of that substance of life which takes concrete form in the process of history, the ideal values to be won from that process and to be recognized in it; and, finally, its ultimate meaning and aim. These questions all lie outside the sphere of empirical historiography, and belong in reality to the philosophy of history which explains and estimates metaphysically. Empirical and philosophical history must be clearly distinguished in principle, though in the actual delineation of events they are usually found in some degree of combination.

But the philosophy of history itself, as has just been indicated, includes very different kinds of problems. The questions of the first group noted above relate to purely metaphysical matters; and, whether they are dealt with as lying within the sphere of a complete system of metaphysics, or agnostically set aside as unanswerable, it is comparatively easy to keep them apart from history proper. The metaphysical background will be discerned only in delineations on a large and comprehensive scale, and even there it will assert itself rather in the intellectual attitude as a whole and in occasional aphorisms than in elaborately constructed theories. This is, at all events, what we find in so purely empirical a historian as Ranke. Modern historiography, as contrasted with the mediæval and theological types, has certainly in principle wrenched itself free from the metaphysical element, whatever the personal views of the historian regarding the latter may be. This, however, is no more than a theoretical emancipation. In view of the practical importance of the metaphysical presuppositions, their separate consideration and discussion are matters of the highest import to philosophy, and the historian must take care to keep such vital questions open, and not to foreclose them by casual remarks and ostensible truisms.

The other group of questions in the history of philosophy are not so easily kept distinct from historical composition. It is true that purely historical delineations, like the delineations of natural science, may conceivably be given in purely empirical categories, as, *e.g.*, Tocqueville, Fustel de Coulanges, and Eduard Meyer endeavour to do. This, however, cannot possibly be the regular procedure, because the reader aspires not only to a knowledge of causes, but to a point of view from which he may pass judgment on the facts of history, and because the questions that thus arise cannot be answered by themselves alone, or apart from a mental picture of the entire field of history. Nevertheless, with a view to clearness in the questions involved, the distinction must, in principle at least, be strongly insisted upon. This

is demanded also by the fact that the valuations and interpretations thus conjoined with description are sometimes contradictory to one another. We meet here with interpretations from various points of view—political, legal, artistic, moral, and religious. These may show an altogether one-sided character, or they may be combined with one another. Each of these points of view, moreover, may itself exhibit variations, and may even give rise to extreme contrasts within its own sphere. This chaos of value-judgments, the perplexing impression made by which is but intensified by the perpetually fluctuating course of history, can be transcended only by grouping the questions together and finding their answers in (1) *a complete system of values*. Such a system of values, however, is neither more nor less than Ethics—to take that term in its ancient sense of a doctrine of absolutely essential qualities and goods, as formulated anew most definitely by Schleiermacher among modern thinkers, and as employed—in effect—in the Hegelian ethics and philosophy of history. On this view history is to be interpreted and evaluated by comparison with a system of values which it is the task of ethics to construct. Every single historical aggregate must, therefore, be judged by the measure of its approximation to this system, or to particular standards forming part of it. Whether that judgment is carried out with glowing personal emotion or with graphic and impressive imagery, it is always based upon such an objective system of values, of which the writer may be unaware, but whose validity he assumes.

The great obstacle to this procedure, however, lies in the fact that ethics itself must derive its knowledge of values from the facts of history, and can furnish nothing more than a critical delimitation and adjustment of these values. We are thus confronted with a logical circle: we must interpret history by the degree in which it approximates to ethical values, and at the same time we must derive these ethical values from history. The circle is not to be evaded, and the difficulty can be solved only by the thinker's own conviction and certainty that amid the facts of history he has really recognized the tendencies that make for ethical ideals, and that he has truly discerned the dynamic movement and progressive tendency of the historic process. A complete proof of the accuracy of his view, *i.e.* of his system of values, is impossible, and, accordingly, ethical interpretations of history will exhibit manifold divergences in the future, just as they have done in the past. Still, such a system of values, notwithstanding its irretrievably subjective character, involves no mere abstract subjectivism; on the contrary, the critical survey of the objective phenomena is through and through a matter of *insight*, and proceeds upon a true homage to the facts. The system would be more accurately described as intuitional rather than subjective. Its demonstration can, therefore, be given only by letting the critic repeat the observation in his own experience, and by leading him to draw from the historian's view of the facts a view of his own in keeping with it. This shows how great a part imagination plays in the framing of those conceptions. But the process cannot be dispensed with except by such a claim to have received a system of the kind by revelation.

From the standpoint of such a system, the historical process appears as an approximation to the complete harmony of ethical values. But here emerges another important conception of the philosophy of history, *viz.* that of (2) *metaphysical or ethical development*. This, as already noted, must be carefully distinguished from the conception of historical development in the empirical

sense, and is not to be demonstrated by means of the latter. The empirical conception of historical development shows only partial, or progressive and regressive, developments, but not the advance of mankind as a whole towards a final and universal end. It certainly exhibits the formation of ethical aggregates, but not their synthesis in a uniform and progressive continuity. Hegel made the mistake of reducing each of these conceptions of development to the other, and also of basing both together upon the metaphysico-logical movement of the Absolute. In reality, the conception of ethical development is merely a postulate of faith—in the Kantian sense—a postulate based upon the actual occurrence of the aggregates of ethical life, and our personal experience of them. Consequently, it must remain an open question whether this kind of development attains its end in the present life, or in a further progress of souls in a life beyond. Certainly experience does not support the former alternative. Similarly, as the system of values can be realized only approximately, and as the possibilities of an approximation are, for the individual, so varied, his share in the final system must also remain an open question.

In connexion with this conception of development, mention must be made, finally, of still another important element in the philosophy of history, *viz.* (3) the problem of *individualization*. The system of values is no rationally demonstrable abstract system, such as would confront all the phenomena of empirical history as an absolute and everywhere identical standard. If we designate the system of values as the 'Idea,' then the course of history is not a sometimes more and sometimes less effective progress towards the realization of the ideal, which is everywhere the same. The truth is, rather, that all spiritual manifestations—in individuals, in groups, or in periods—are individualizations or concrete manifestations of the ideal. This accords perfectly with the earliest, merely descriptive, and non-nomothetic type of historiography; and it accords likewise with the metaphysic of spirit—which cannot be more fully dealt with here. But in that case every historical phenomenon, viewed from the standpoint of the ethical philosophy of history, bears a double character: it is, on the one hand, a concrete manifestation of the Idea, having a relative right of its own, and, on the other, a mere approximation to the absolute system of values. In spite of all obstacles and defects, there obtains everywhere an individual and concrete progress towards the ideal. Final perfection itself, indeed, might be conceived of as simply the sum of the individual realizations of the Idea. Here, however, we encounter the antithesis between universal validity and individualization—an antithesis which cannot be theoretically reconciled at all. Hence each historical phenomenon is to be estimated by reference only to that degree of approximation to the Idea which is set before it and is possible to it. In this way every epoch has a relative justification, though it must, at the same time, be judged in the light of an absolute end. This shows the necessary relativity of the philosophy of history, and yet makes it possible that the relative shall appear to be included in the movement towards the absolute. The absolute *in* the relative, yet not fully and finally in it, but always pressing towards fresh forms of self-expression, and so effecting the mutual criticism of its relative individualizations—such is the last word of the philosophy of history. This implies, however, that in the writing of history and the description of historical phenomena—in spite of all appraisements by reference to final and absolute values—there still remains the concrete individual character of the objects dealt with, and there

remains also the non-rationality of personal life, with its rightful claims in face of all the ideals of universal value that hover before the human mind.

LITERATURE.—E. Fueter, *Gesch. d. neueren Historiographie*, Munich, 1911; E. Bernheim, *Lehrbuch d. historischen Methode*⁵, Leipzig, 1908; W. Dilthey, *Einleit. in d. Geisteswissenschaften*, do. 1883; W. Wundt, *Logik*, Stuttgart, 1903-08; H. Rickert, *Grenzen d. naturwissenschaftlichen Begriffsbildung*, Tübingen, 1902; R. Eucken, *Die Einheit d. Geisteslebens*, Leipzig, 1888; G. Simmel, *Die Probleme d. Geschichtsphilosophie*⁶, do. 1907; Schleiermacher, *Entwurf eines Systems der Sittenlehre*, ed. A. Schweizer, Gotha, 1835; W. Windelband, *Geschichte u. Naturwissenschaft*, Strassburg, 1894 (also in *Präludien*⁴, Tübingen, 1911); E. Troeltsch, *Die Absolutheit d. Christentums u. d. Religionsgeschichte*², Tübingen, 1912; H. Münsterberg, *Philosophie der Werte*, Leipzig, 1908. E. TROELTSCH.

HITTITES.—1. Ethnography and history.—

The Hittites were a people, possibly of mixed Aryan and Caucasian elements, who controlled, during the second millennium and a part of the first millennium B.C., large portions of the Nearer East. In the OT they are frequently mentioned under the name Hittim (חִיְתִים), rendered in the Greek by the word *Xettaioi*. They appear on the Egyptian monuments under the name *Ht*; commonly rendered in English as *Kheta*, and they were known to the Babylonians, Assyrians, and Haldians as *Hatti*, the form of the name by which, according to the Cappadocian tablets, they called themselves.

In early times there seems to have been no central Hittite power, but a number of separate and independent city-states, each with its king, who seems also to have been chief priest. Later, the Mitannians, apparently a Hittite people, established a centralized Hittite kingdom, with Carchemish perhaps as their capital; and the rulers succeeded in extending their sway not only over the north Mesopotamian region, their proper domain, but also over North Syria and, possibly, the plain to the east of the Tigris.

The Hittite sphere of influence can be fairly well determined by their monuments and mounds. Two groups of isolated rock sculptures,¹ near the Ægean Sea, and close to the end of the natural trade-route from the great central plateau of Asia Minor, would seem to indicate that they controlled this route for a time, though they apparently did not hold sway over the mountainous regions west of Lycaonia and Phrygia. Beginning, however, with the territory represented by those two provinces, their influence was felt eastward to the Euphrates, as well as in North Syria, northern Mesopotamia, and Assyria. It is interesting to note that both the first builder of the wall of the city of Ashur in Assyria and the founder of the temple to the god Ashur in the same city bore Hittite names²—a fact which goes far to prove Hittite or Mitannian control of this region before the end of the third millennium B.C. It was, doubtless, an army from this southern band of Hittites that invaded Babylonia about 1800 B.C.,³ overthrew the first dynasty of Babylon, and set a Hittite king on the throne, maintaining their power there for something like twenty years. In the same general period, the beginning of the second millennium B.C., or possibly at the end of the third millennium, must have occurred the southward expansion of the same people into Palestine, where we find their early importance reflected in the Abraham episode (Gn 23), despite the late origin of the present narrative. Whether they made their way south by force of arms or through peaceful migration is uncertain; but they are, at any rate, considered in the Biblical passages as a part of the settled population.

¹ Garstang, *Land of the Hittites*, pls. III., IV.

² Ungnad, *Urkunden aus Dilbat*, *Beiträge zur Assyriologie*, vol. VI. pt. 5 [1909], p. 12.

³ Jastrow, *RS xviii.* [1910] 87 f.

Our knowledge of the Hittites up to the 14th cent. B.C. is very fragmentary. An Egyptian stela of the XIIth dynasty¹ may possibly refer to Hittites settled in Southern Syria, and Thothmes III. records² that he received tribute from Kheta. However, the magnificent find of some 2500 cuneiform tablets, unearthed by H. Winckler³ at Boghaz Keui, enables us, with the help of the Amarna tablets, to form a fairly clear idea of the succession of events in the 14th and 13th centuries B.C.

The central figure of this period is Subbi-luliuma, ruler of the Hittite capital in Cappadocia known as the 'City of Hatti,' the modern Boghaz Keui. At the beginning he seems to have been little more than a city-king; but, by uniting the neighbouring States in friendly alliance, and by a series of campaigns in North Syria and northern Mesopotamia, he succeeded in establishing a Hittite Empire, including Syria north of Kadesh on the Orontes, the Mitannian kingdom, and the central portions of Asia Minor. Subbi-luliuma was followed successively by two sons, Arandas and Mursil, both of whom lacked the energetic spirit of their father, to the extent that both Assyria and Egypt made successful campaigns into the Hittite territory. Mursil's son and successor, Mutallu, immediately upon his accession, set about rebuilding the Hittite power. His influence may be judged from the array of nations that gathered to his standard: troops from Arinna and Pisidia, Dardanians and Mysians, Lycians and Cataonians, together with contingents from all North Syria, banded together and marched to meet the Egyptians led by Ramses II. Battle was joined at Kadesh on the Orontes. Neither side seems to have been signally victorious. Shortly after, Mutallu was assassinated, and his brother Hattusil fell heir to the throne. This ruler, about the year 1271 B.C., made an offensive and defensive alliance with Ramses II., the terms of which were inscribed on a silver tablet and sent by the Hittite king to Ramses. The treaty is preserved to us in an Egyptian translation engraved on the wall of the temple at Karnak, and another translation, now very fragmentary, in the Ramesseum, as well as in a cuneiform tablet from Boghaz Keui, written in the Bab. language.

The rising power of the Assyrians and of the Muski on the north now not only checked any further desire for conquest which the Hittites may have had, but gradually reduced the limits of their realm. Only two further rulers of the Hatti dynasty, Dudhalia and his son Arnunata, are named in the Boghaz Keui tablets. It is very likely that not long after this the Hittite Empire was dissolved, and before the end of the 8th cent. B.C. the greater part of its territories had been absorbed by Assyria and Phrygia.

2. Religion.—The chief sources of our knowledge of Hittite religion are the sculptured monuments and seal cylinders, the inscriptions in Assyrian and Egyptian, and the Boghaz Keui tablets. Pending the complete decipherment of the Hittite language,⁴

¹ Stela, C. 1, Musée du Louvre.

² *Annals of Thothmes III.*, 33rd and 41st years.

³ *Mitteilungen der deutschen Orient-Gesellschaft*, xxxv. (Dec. 1907) 1 ff.

⁴ Contributions towards the decipherment of the Hittite pictographs have been made by J. Halévy, F. Hommel, J. Menant, L. Messerschmidt, and others, while more or less complete systems have been put forward by O. J. Ball, C. R. Conder, P. Jensen, F. E. Peiser, and A. H. Sayce. Only the systems of Sayce and Jensen have received recognition from scholars, and it is now generally considered that the chief value of Jensen's work consists in his excellent list of symbols, and his division of inscriptions into word groups. Sayce's system, on the contrary, is slowly gaining adherents. His work began with the investigation of proper names such as Carchemish, Tyana, Mar'ash, Hamath, and Sandon, appearing in various forms, purely phonetic or partly ideographic. A considerable list of values has thus been formed. Doubtless, many of these values will require modification; but the system seems in the main

these sources are meagre. While the sculptures deal, in the great majority of cases, with representations of deities and scenes from the cult, they afford us at present none of the names of the gods concerned, and in very few instances can the deity be identified and the name supplied from the Assyrian and Egyptian sources. The case is much the same with the carvings on the seal cylinders. A fairly large mass of material is preserved in the later Græco-Roman writers; but, like the historical material they present for the Nearer East, this can be used with confidence only when checked by the sources already mentioned.

Primitive animistic conceptions stand out clearly in the historical form of the religion. Springs, rivers, trees, and mountains were considered sacred. At Aflatun Bunar, west by south from Iconium, is the familiar monument which stands as the remains of a building, with sculptured front, dedicated to the spirit of the copious fountain which here flows forth. On the shoulder of Mount Argæus, the highest peak in Asia Minor, is another fountain, whose sacred character was marked in Hittite times by a spring house with an inscription, parts of which remain. The tetrastyle temple, which is a feature of some of the Argæus coins, may have stood on the same spot; and that the sanctity of the place was transmitted to later times is evidenced by the discovery, in the same place, of the remains of a Christian church or chapel. High up in the Anti-Taurus range above Comana Aurea, and near the small village of Qoqar Quyu, is a lion monument¹ with Hittite inscription, which owes its position, no doubt, to the sacred character of the mountain. The peak of Argæus likewise was considered sacred, and further evidence is furnished by the representation in various instances of deities standing on mountain tops. Moreover, the treaty of Hattusil with Ramses II. mentions 'the Lady of mountains and rivers.' The sacred tree appears in one perfectly preserved sculpture from Sakje-Geuzi, and it is perhaps used as a symbol in the inscriptions.

However, in the period represented in the Hittite monuments, the religious belief of the people had long passed the primitive stage. Animals were still used as emblems, and the people may have continued to believe in the sacred character of springs, mountains, and trees; but a higher plane had been reached, and we may believe that the religion stood on about the same level as that of Babylonia before the time of the first dynasty of Babylon. The selective processes of time had exalted a comparatively small number of the primitive Nature-spirits into gods directly concerned with the welfare of the people; and these had taken on anthropomorphic forms, assuming the appearance and dress of the Hittites. The distinguishing garb of the male deity, as seen on the monuments, consists of the short tunic and conical hat; that of the goddess, the long robe and high cylindrical hat. Shoes pointed and turned up at the toes were a feature common to the dress of both. The Hittite artist, as a rule, made no attempt to differentiate the deities through varied portraiture, but relied in

well grounded, notwithstanding the fact that translations of connected passages are not altogether satisfactory. The chief obstacle to further advance is lack of well-preserved inscriptions, though new material is constantly coming to light. It is confidently expected that the Hittite language will be recovered in great part from the cuneiform material discovered by H. Winckler at Boghaz Keui, which is now being investigated by Ernst Weidner of Berlin. The grammatical structure of the language and a considerable vocabulary once determined, the complete decipherment of the hieroglyphic inscriptions will shortly follow (cf. P. Jensen, *Hittiter und Armenier*, Strassburg, 1898; L. Messerschmidt, 'Bemerkungen zu den hethitischen Inschriften,' *MVG*, 1898, p. 179 f.; A. H. Sayce, 'Hittite Inscriptions,' *PSBA*, 1907, pp. 207-218, 253-259).

¹ Olmstead, Charles, and Wrench, *Travels and Studies in the Nearer East*, vol. I. pt. 2, figs. 27-29.

this matter on accessories such as insignia, arms, or totemistic emblems. In many cases the name also is appended, so that to one who knew the native writing there need be no uncertainty.

The status of the Hittite religion in the early period was much the same as that of religion in early Babylonia. Each city-State had its own gods worshipped in the local temple or temples; and this situation seems, as in Babylonia, to have continued to the end of Hittite history, notwithstanding the later establishment of a pantheon. Predominant among these city deities seem to have been some of the local forms of the Mother-goddess and of the storm-god. The former, as the personification of the productive forces, and, in connexion with her son, of the reproductive forces of Nature, was always a favourite with the Hittite peoples, as with the later races who occupied Asia Minor; and it is not surprising that a land so favourable to this cult should at a later time prove such fertile soil for the development of the cult of Virgin and Son. Among male deities, the storm-god, who seems to have been the tutelary deity of the armies, was the favourite. When, therefore, with the formation of an empire, a well-defined imperial pantheon was established, it was but natural that this pair should stand at the head; and thus we find them represented in the sacred gallery of Yazyly Qaya,¹ the holy place of the city of the Hatti.

Although in the enumeration of the Hittite gods preserved in the famous treaty the sun-god is mentioned first, the storm-god seems actually to have held the foremost place in the pantheon. From a perusal of the list in the treaty it is evident that the native translator has made a rather unsatisfactory attempt to render it into intelligible Egyptian. As the sun-god, if actually a native deity, appears to have received scant recognition among the Hittites in general, his appearance at the head of the list would seem to demand explanation. Three explanations suggest themselves: (1) the native translator considered the Mother-goddess a solar deity, and, unable or unwilling to conceive of such a deity as feminine, identified her with the sun-god, lord of heaven; (2) the Hatti themselves, as a concession to Egypt, may have placed the solar deity, as an adopted god, at the head of the list; (3) the Hittite king, whose emblem is formed in part by the winged solar disk, may himself be the sun-god referred to.

The chief male member of the pantheon, then, was the storm-god. He was known in the capital as Teshub—a name common also among the Mitannians and Haldians as the designation of important local storm-gods. He corresponds closely to the West Semitic and Babylonian god Adad. Representations of him vary considerably, but he generally bears in one hand his distinctive weapon, the three-pronged thunderbolt. His most characteristic representation is that found at Malatia.² He is here clothed in the typical dress of the male deity, and bears the bow and thunderbolt as weapons. He stands on a bull, whose roaring, apparently represented by a line drawn from his mouth to the thunderbolt held in the god's hand, is a fit emblem of the thunder, while from the horns issue flames, typical of the lightning. In the procession in the sacred gallery at Boghaz Keui his weapons are the trident and mace, and he is borne on the necks or shoulders of two men, possibly priests; while in the Zinjerli sculpture he is a bearded god armed with trident, hammer, and dagger, and does not support bull or priest. The monument at Isbekjür,³ on which he stands

¹ Garstang, *op. cit.*, pls. lxiv.-lxxi.

² Olmstead, Charles, and Wrench, *op. cit.*, fig. 41.

³ *Ib.* fig. 33.

on a charging bull, may be taken as depicting the god in action.

The name of the Great Mother is not yet determined, though it seems likely that the original Cappadocian form was something like *Mā*—the name under which she was worshipped later at Comana. Perhaps the most satisfactory representation of her is that in the sacred procession at Boghaz Keui. Her skirt is here pleated and provided with a train. Her hair falls in a long braid, and on her head is the 'mural crown.' She has no weapons, but bears in her left hand her peculiar symbol and in her right a staff. The totemistic emblem on which she stands is the lioness or panther. Her son, who follows her in the procession, is a beardless youth in the typical masculine dress, bearing in one hand a staff, and in the other a double axe, while a dagger rests in its sheath at his belt. The animal on which he stands is the same as that of his mother. His Hittian designation has not been determined, though he was known in the West as Attis. A similar deity of fertility, perhaps Sandan or a local form of the son of the Great Mother, is the bearded god in the Ivriz sculpture, carved near a copious spring.¹ He holds in his right hand a cluster of grapes and in his left the heads of several stalks of grain. That he is not a god of the harvest or a Bacchus is evident from the fact that both grain and grapes are seen to be still attached to growing stalk and stock. A reminiscence of this or a similar early god still lingers in Damascus in a tradition, reported by J. E. Hanauer,² of a steel idol representing the deity who guaranteed the crops, holding in one hand, as a symbol of his function, a cluster of grapes, and, in the other, stalks and ears of wheat and barley.

The numerous other deities, male and female, in the sacred procession, like the majority of divinities pictured by the Hittites, cannot at present be identified. Prominent among them may be mentioned a mountain-god who stands behind Teshub, the two goddesses of the double-headed eagle, and a grotesque figure with human head, body formed of lions, and lower extremities replaced by the blade of a dirk or dagger.

Among other deities who seem to be native, but of whom little more than the name is known, may be mentioned Hipa, Sallu, Tarqu or Tarhu, and Tilla, most of whom appear only in personal names.

Though each city had its tutelary deities and the Empire its pantheon, there was no hesitancy in recognizing and adopting foreign gods; and as a result native and foreign deities are often so associated that, in the present state of our knowledge concerning such religious systems as the Phœnician and the Assyrian, it is difficult, and at times impossible, to assign a god to his rightful people. Ashur (or Ashir) appears frequently in personal names in the so-called Cappadocian tablets;³ and, notwithstanding the rôle he played as chief Assyrian god, his origin is by no means certain. Ishhara is mentioned in the treaty with Egypt as a Hittite goddess, and her name appears on the Indilimma bilingual,⁴ but she may have been adopted from a neighbouring people. A Hittite Reshpu is mentioned in the Egyptian records, but this also is a Phœnician and Aramæan deity.

Perhaps the most remarkable element in this complex of divinities connected with the Hittites is represented by four names of Mitannian gods found on one of the Boghaz Keui tablets:⁵ *mi-it-*

ra-as-si-il, u-ru-w-na-as-si-el, in-da-ra, na-sa-at-ti-ia-an-na; that is, Mithra, Varuna, Indra, and perhaps Nāsatya, the 'Twins.' An attempt to discuss this interesting admixture would be premature, but it clearly shows some very close connexion between the Hittite culture and that of the Aryans of India, possibly the addition to the Western people of a fresh stratum of population, representing a migration during the middle of the second millennium.

We shall doubtless find, when the tangled mass of Asiatic religious ideas is understood, that the Hittite religion contributed in no small degree to the later classical mythology. Two of the sculptured blocks dug from the mound of Arslan Tepe near Malatia¹ contain a scene which reminds us forcibly of a classical myth. One block contains the figures of two gods in ornate pointed caps and the ordinary short tunics. One of these, a bearded god, bears a dagger, club, and lance. He is preceded by a beardless figure who seems to be combating with his lance a many-headed serpent coiled in the water. The scene is not complete, but several of the serpent's heads with open mouths and fangs ready to strike are clearly discernible. This may prove to be the prototype of Hercules' slaying of the hydra, assisted by his friend Iolaus.

The sanctity of Mount Argæus from Hittite to Christian times is well attested. Moreover, *Argaios* is a title of Zeus in Cappadocia, and Argæus is known from Maximus of Tyre to have been a god as well as a mountain. This god Argæus, then, must be identified with the Apollo-like deity represented on the Argæus coins, who was doubtless originally the Hittite god of this mountain. It is interesting to note that in this instance the myth seems to have come down to the present day; for we must see in the modern legend to the effect that Ali Dagh, the cone-shaped mountain below Argæus, was formed by a basketful of earth which fell here as the result of the breaking of Ali's basket an adaptation of an earlier legend in which the god Argæus was the actor.

It is very possible that the sources of the Amazon stories will also be found among the Hittites, perhaps suggested to the story-teller of later times by a vague tradition of some rite connected with the cult of the Mother-goddess, or by an actual war-band of women. The possibility of this source is suggested by the discovery of an armed lady sculptured on a post of one of the gates of the Boghaz Keui fortifications.

The figure,² which is one of the best examples of Hittite art, is that of a woman with short skirt, girdle, coat of fine mail, and the pointed hat adorned with horns, her dress thus closely resembling that of the male deities. The lady's arms are the single-bitted axe, which she bears in her right hand, and the dagger, which rests in a sheath attached to her belt. While the figure is of great interest in its suggestion of a possible connexion with the Amazon legends, too much stress must not be laid upon this theory. It is more natural to suppose that the sculpture represents a Hittite Athene, and that she stands here as the guardian of gate and city.

3. Death, etc.—The common method of burial among the Hittites seems to have been interment in large jars after a partial cremation of the bodies. In 1907 a mound was discovered by the Cornell Expedition in the plain south of Mount Argæus, at the hamlet of Egri Keui, which was used as a cemetery and seemingly also as a crematory. Here were found human bones, fragments of large jars, some of them painted ware, and pieces of charred

¹ Garstang, *op. cit.*, pl. lvil.

² *PEFSI* (April 1910), p. 85 f.

³ Delitzsch, *ASG*, Philolog.-Histor. Classe, xiv. [1894] 207 ff.

⁴ Messerschmidt, 'Corpus Inscr. Hettiticarum,' Tafel xlv. 8.

⁵ *Mitteilungen der deutschen Orient-Gesellschaft*, xxxv. 61.

¹ Olmstead, Charles, and Wrench, *op. cit.*, fig. 43.

² *PSBA* xxxii. [1910] 25 f.

wood. This and the further discovery of such jar-burial at the pre-classical Iconium as well as at Carchemish would indicate that this was the chief method. That other methods were in vogue is suggested by the discovery, made by the Cornell Expedition, of an instance of cist-burial at Sevinjik in Lycaonia south of Ilghin, the grave in this case containing a small earthen pot unmistakably Hittite in type. Persons of note, however, were interred in mounds built in a conspicuous spot, such as the summit or shoulder of a mountain. Whether the manner of interment was the same as in mounds further west is not known, as no tumulus definitely shown to be Hittite has been investigated.

It is to be expected that a people so favourable to the cult of the Mother-goddess who yearly revived Nature should have a steadfast belief in a life after death. Strangely enough, none of the larger monuments sheds any light on the subject. Several most interesting seal cylinders,¹ however, though showing strong Babylonian and Egyptian influence, may be taken as pictures of the Hittite lower world. In these the deity who judges the dead sits in a high-backed chair, and the soul of the departed is brought before him by an attendant with two faces, one of which he turns towards the judge, while with the other he watches the deceased. Three figures following the dead suggest the three assessors, Minos, Æacus, and Rhadamanthus, associated by the Greeks with Pluto, and indicate one more line of connexion between pre-Hellenic Greece and Asia Minor. Other scenes on the cylinders represent the dead partaking of food, some of which is furnished by kindly monsters; and in one place² we seem to have a cremation scene.

4. Status of woman.—From the prominence of the Great Mother cult as well as from the importance of other female deities in the pantheon, it was natural to conclude that the status of woman among the Hittite peoples must have been comparatively high. This conclusion is confirmed by the records. Whether monogamy was the rule is uncertain, but it is interesting to note that, when Subbi-luliuma supported Mattiuaza as heir to the throne of the Mitanni land, he conditioned his support on a monogamous marriage of the Mitannian prince with a princess of Hatti. The high position of woman is shown further by the importance of the queen as chief priestess alongside the priest-king, as well as by her prominence in State affairs, as evidenced by her seal affixed to treaties and royal edicts. A similar position of importance was held by the queen-mother, whose seal also appears on such documents; and one queen-mother of the Hatti dynasty, Putu-hipa, is mentioned as co-ruler, and later as regent, during a short interregnum.

5. Cultus.—In the course of the excavations at Boghaz Keui, the foundations of four buildings which seem to have been temples were laid bare, three in the upper city and one on a lower terrace. The last mentioned is the site where a portion of the collection of cuneiform tablets was unearthed. The foundations of all four temples are massive, and in their plan and construction have features in common with buildings excavated at Cnossos, Tiryns, and Mycenæ. The lower temple, which Winckler considers to have been the sanctuary of Teshub, consists in the main of a large rectangular court, with entrance from the south, opening northward through a hall of columns or pillars into the *adyton*, another rectangular room at the north side of which stands an immense basis, undoubtedly the pedestal of the god's statue. Added

¹ Ward, *Seal Cylinders*, nos. 854-860.

² *Ib.* no. 857.

to this main plan is a system of long, narrow chambers, which served as magazines for the stores and accessories of the temple; and the whole is surrounded by paved streets. Only the foundations of the temple complex remain. These consist of massive squared blocks of limestone forming a socle about a metre high, the upper surface of which is provided with rows of holes, doubtless designed for the reception of long poles supporting the clay superstructure. The three buildings in the upper city have a similar plan and structure, though the construction is not so massive. It is of interest to note in this connexion that the Anu-Adad temple at Ashur in Assyria shows a distinct departure from the usual Bab. type, revealing features which may prove to be Hittite.¹

Very little of the cult can be reconstructed from the monuments. These clearly show that libation and animal-sacrifice played an important part, the victims, so far as we can judge from the sculptures, being sheep and goats. The king or queen is represented in various instances as standing before the deity pouring a libation with a high one-handed pitcher, the stream from which, in some cases, falls into a two-handed urn set on the ground, as in the sculptures at Malatia and Isbekjür.² In several scenes of this character an attendant is pictured in the background, leading or holding the sacrificial animal. The Fraktin sculptures show the priest pouring a libation while the offering is on the altar, presumably burning.

6. Divination.—Among the interesting discoveries made at Boghaz Keui was that of a number of clay representations of sheep's livers closely resembling the Bab. model coming from the time of Hammurabi. This shows clearly that hepatoscopy, introduced from Babylonia, was practised among the Hittites, and we may believe that other forms of divination were adopted at the same time; indeed, it is not at all unlikely, considering the long occupation of these regions of the Nearer East by the Hittites, that this people, whose intercourse with the Ægean races is well attested, transmitted hepatoscopy and astrology to the West.

7. Relation to other civilizations.—Our present knowledge of the Hittites is too meagre to permit a discussion of the mutual interchange of cultural elements between the Hattian and the Assyro-Babylonian civilizations on the one hand and the Ægean world on the other. That such interchange between Hittites and Assyro-Babylonians occurred, and in no small measure, might, if no other evidence existed, be safely conjectured from the facts that before the end of the third millennium B.C. we find Hittites or Mitanni in control of Assyria, that from very early times Hittites lived peacefully in Babylonia and Assyria, and that in a period possibly as early as 2000 B.C. we find Assyrian names and name-elements in the Cappadocian tablets. We have seen that Bab. divination, in one of its phases at least, was borrowed by the Hittites, and that they were not averse to recognizing Assyro-Babylonian gods. Their greatest debt to the Euphratean civilization, however, is represented by the cuneiform script, which came to be used in all their commercial and legal transactions as well as in their international correspondence. With every advance in our knowledge of the Hittites it becomes increasingly apparent that these debts were not left unpaid. It seems clear from a study of the monuments and seal cylinders that the Hittites exerted a by no means inconsiderable influence on the architecture, as, for example, in the well-known *bit hilāni*, and on

¹ See W. Andrae, *Der Anu-Adad-Tempel in Assur*, Leipzig, 1909, p. 82 ff.

² Olmstead, Charles, and Wrench, *op. cit.*, figs. 42 and 34.

the art, a notable example of which is found in the Maltaya sculptures¹ so obviously akin to the processions of gods at Boghaz Keui; while a strong Hittite influence on the religion must be predicated from the large number of names of Hittite deities forming a part of the personal names found in the Assyrian business documents.² That the Hittites exerted an equally important influence on the peoples of the Ægean cannot be doubted; but how far the constant similarity between the two is due to actual influence and how far to racial identity no one may safely say. These and similar questions which meet one at every stage of the investigations we may raise, but even such general hypotheses will continue to be of doubtful value until we have much more complete collections of material, and especially until the deciphering of the Hittite and allied languages has been accomplished.

LITERATURE.—For the native inscriptions: L. Messerschmidt, 'Corpus Inscr. Hettiticarum,' in *MVG*, Berlin, v. (1900) nos. 4-5, vii. (1902) no. 3, xi. (1906) no. 5; A. T. Olmstead, B. B. Charles, and J. E. Wrench, *Travels and Studies in the Nearer East*, vol. i. pt. 2, Ithaca, 1911. The results of the Boghaz Keui excavations are given by H. Winckler, in *OLZ* ix. [Leipzig, 1906] 621 ff., and by H. Winckler and O. Puchstein, in *Mitteilungen der deutschen Orient-Gesellschaft*, xxxv. [Dec. 1907] 1 ff. The best study of the Hittite-Egyptian treaty is that by W. Max Müller, 'Der Bündnisvertrag Ramses II. und des Chetiterkönigs,' in *MVG* vii. [Berlin, 1902] 193 ff., and the best Eng. tr. is to be found in J. H. Breasted's *Ancient Records of Egypt* (Chicago, 1906-07), iii. 163 ff. For the history: J. Garstang, *The Land of the Hittites*, London, 1910; J. H. Breasted, *Hist. of Egypt*, New York, 1911; G. Maspero, *Struggle of the Nations*, do. 1897, *Passing of the Empires*, do. 1900. Cf. for the later period also A. T. Olmstead, *Western Asia in the Days of Sargon of Assyria*, New York, 1908. For the art and architecture: F. von Luschan, C. Humann, R. Koldewey, and others, *Ausgrabungen in Sendschirli*, Berlin, ii. (1898), iii. (1902), and iv. (1911); J. Garstang, *Land of the Hittites*; O. Puchstein, *Bauwerke von Boghazköi*, Leipzig, 1912. Cf. also Perrot-Chipiez, *History of Art in Sardinia*, etc., New York, 1890. The seal cylinders are collected in W. H. Ward, *Seal Cylinders of Western Asia*, Washington, 1910. The religion is discussed, sometimes in considerable detail, in most of the foregoing works. There is a special study by W. M. Ramsay, in *Lake the Physician*, London, 1908. The religions of Asia Minor in general are fully dealt with in J. G. Frazer's *Adonis, Attis, Osiris*, London, 1907. Special phases of the subject are treated in the various special periodicals in artt. by Ramsay, Sayce, Ward, and others. B. B. CHARLES.

HIUEN TSIANG.—See YUAN CHWANG.

HOS.—A tribe classed by Risley as Dravidian or non-Aryan, found in the Singhbhum District of the Chota Nāgpur Division of Bengal, where, according to the Census of 1901, they number 385,125. The tribal name seems to be a contracted form of the word *horo*, 'man,' which is used by the cognate Munda and Santāl tribes as their national designation, and which appears in various forms in the tribal names Oraon, Kol, Korwā, Korkū, etc. Risley further remarks that the Mundas and Santāls are not called *horo* by outsiders; and 'in the case of the Hos, the tribal name of the original stock whence Hos, Mundas, and Santāls are sprung has obtained popular recognition, in a slightly altered form, as the distinctive name of the branch which inhabits Singhbhum, and which may now be regarded as a separate tribe. For intermarriage between Hos and Mundas or Santāls, though not absolutely forbidden by custom, is certainly uncommon, and may be expected soon to fall into disuse' (*TC* i. 319 f.).

1. Tribal legends.—The Hos possess a remarkable tradition concerning the creation of the world and the origin of the human race, recorded by Tickell (*JASB* ix. [1841] 797), and thus summarized by Dalton (*Descrip. Ethnol. of Bengal*, 185):

'Otā Borām and Sing Bongā were self-created, and they made the earth with rocks and water, and they clothed it with grass and trees, and then created animals, first, those that man domesticates, and, afterwards, wild beasts. When all was prepared for the abode of man, a boy and girl were created, and Sing Bongā placed them in a cave at the bottom of a great

¹ Perrot-Chipiez, *History of Art in Chaldaea and Assyria*, London, 1884, ii., fig. 123.

² Cf. Jastrow, *Aspects of Religious Belief and Practice in Babylonia and Assyria*, New York and London, 1911, Index, s.v. 'Hittites.'

ravine, and finding them to be too innocent to give hopes of progeny, he instructed them in the art of making illi, rice beer, which excited the passions, and thus the world became peopled' (cf. Tylor, *PC*⁴, London, 1903, ch. xvii.; Lang, in *EBR*¹¹ xix. 142 ff.). 'When the first parents had produced twelve boys and twelve girls, Sing Bongā prepared a feast of buffaloes, bullocks, goats, sheep, pigs, fowls, and vegetables, and, making the brothers and sisters pair off, told each pair to take what they most relished and depart. Then the first and second pair took bullocks' and buffaloes' flesh, and they originated the Kole (Hos) and the Bhūmij (Matkum); the next took vegetables only, and are the progenitors of the Brahmans and Chattris (Skr. *Kṣatriya*, the warrior class); others took goats and fish, and from them are the Sūdras (menials in the Hindu caste system). One pair took shell-fish, and became the Bhuiyās (q.v.); two pairs took pigs, and became Santāls. One pair got nothing, seeing which, the other pairs gave them of their superfluity, and from the pair thus provided spring the Ghāsis, who toil not, but live by preying upon others (for the Ghāsi or Ghasiyā tribe of out-castes, see Risley, *TC* i. 277 f.; Crooke, *TC*, Calcutta, 1896, ii. 408 ff.). The Hos have assigned to the English the honour of descent from one of the first two pairs, the elder. The only incident in the above tradition that reminds one of the more highly elaborated Santāl account is the divine authority for the use of strong drink' (cf. the legends which attribute the invention of wine to Noah, Dionysus, and Osiris).

From the ethnological point of view this legend is interesting, as it admits the common origin of the forest tribes occupying this region. On the other hand, it is ætiological, inasmuch as it purports to explain the present status of these tribes; it is comparatively recent, since it embodies Hindu beliefs; and the account of the origin of the English must be quite modern.

2. Religion.—According to Dalton, the Hos at the present day have no conception of a heaven or hell which may not be traced to Brāhmanical or Christian teaching.

'They have some vague idea that the ghosts of the dead hover about, and they make offerings to them; and some have, like the Chinese, an altar in the house on which a portion of the "daily bread" is offered to them; but, unless under a system of prompting often inadvertently adopted, they will not tell you that this after existence is one of reward or punishment' (*op. cit.* 204).

Their burial customs certainly indicate a belief that the spirits of the dead abide in the neighbourhood of their graves. Ball (*Jungle Life*, 64), writing of them under the name of Laṛkā Kols, describes one of their cemeteries which contained a number of ancient stone monuments:

'The major part of them had a sort of truncate pyramidal shape, and were marked superficially with groovings, which may possibly have some signification; they recalled to my recollection the ancient Ogam inscriptions of Ireland, though not actually similar to them in form. In this neighbourhood, too, I saw an ancient cross; but regret to say, I do not retain any description of it, as I did not, at that time, fully recognise the importance of the symbol occurring otherwise than in connection with the Christian religion. The assumption, however, that it is the exclusive property of Christianity is clearly unwarranted by certain now well-established facts' [quoting *PASS*, 1877, p. 189; *JASB* xlv. (1877) pt. ii. p. 179; to which may be added D'Alviella, *Migration of Symbols*, Eng. tr., London, 1894, p. 12 ff. and *passim*]. 'Most of these stones were erected as memorials to worthies of the tribe' (*op. cit.* 163).

Another account of the death-rites shows more clearly the belief in the survival of the soul after death. After the cremation of the corpse, the ashes are placed in an earthen vessel until all the arrangements for interment have been completed.

'Then the chief mourner, carrying the vessel with the remains of the deceased on her head, leads the funeral procession to every house in the village, the inhabitants of which come out and pay their last tribute of respect to the dead. The deep solemn notes of the drum and the low-voiced grief of the women form a weird funeral march as the procession winds from house to house, returning at last to the grave prepared close to the house of the deceased. Rice and other food is first thrown in, and then the vessel containing the remains is lowered into the hole and covered over with earth (see FOOD FOR THE DEAD). A huge uncut slab of stone is placed over the spot to mark the grave and guard it against desecration. Outside the village, the Hos, like the Mundas, put up another monument to the deceased's memory in the form of a huge pillar of rock varying in height from four to twelve or fourteen feet' (Bradley-Birt, *Chota Nagpore*, 101).

3. Other religious beliefs.—Besides the cult of deceased ancestors, the worship of the Hos is directed towards the propitiation of a host of malignant spirits of forest, hill, and stream, which

are practically identical with those of the kindred tribes, Kols, Mundas, and Santāls (*q.v.*).

LITERATURE.—E. T. Dalton, *Descrip. Ethnol. of Bengal*, Calcutta, 1872, p. 177 ff.; H. H. Risley, *TC*, do. 1891, i. 319 ff.; F. B. Bradley-Birt, *Chota Nagpore*, London, 1903, p. 82 ff.; V. Ball, *Jungle Life in India*, do. 1880, p. 476 ff.; Sarat Chandra Roy, *The Mundas and their Country*, Calcutta, 1912.

W. CROOKE.

HOBBES.—1. Life.—Thomas Hobbes, known to his friends as 'Malmesburiensis Philosophus,' an original and forceful English writer on political philosophy, was born at Westport, in Wiltshire, on 5th April 1588. His early education was received at the Westport church school, at a school in Malmesbury, and also at one kept by a Mr. Latimer, who is described as 'a good Grecian, and the first that came into our parts since the Reformation' (J. Aubrey, *Brief Lives*, ed. A. Clark, Oxford, 1898, i. 329). Later, Hobbes entered Magdalen Hall, Oxford, where he became discontented with the traditional learning of the University and turned his attention to the study of men and current affairs. After admission as bachelor on 5th Feb. 1608, he became tutor to the son of William Cavendish, later the second Earl of Devonshire, and began the life-long intimacy with a family whose social position and political fortunes carried him into that turmoil of public life wherein his opinions were formed. Through the travels incident to this connexion, Hobbes became acquainted with the work of such men as Galileo, Kepler, and Montaigne. This fired his imagination and led him to conceive a system of philosophy worked out in the spirit of the new learning, and applied especially to the moral, social, and political problems of human life. He felt his project to be the more urgent because of the political disturbances of his time and the uncertainties of life and fortune incident to the Civil War. Although his political writings were not his earliest essays in philosophy, and although his political theory was probably worked out as a part of his general theory before the Civil War gave to it a special impetus, the publication at Amsterdam in 1647 of *de Cive*, and at London in 1651 of *Leviathan*, was felt by Hobbes himself to be a matter vitally important for the trend of events. He professed the ambitions of a scholar, owned a preference for scientific inquiry secure from the excitements of public life, and yet, in spite of self-confessed timidity, sought repeatedly the opportunity to make his writings felt by those in power. His contributions to political theory, together with his observations on human nature, are by far the most important parts of his philosophy. His own time and times subsequent have found little of marked significance in his other work. Yet the student of philosophy can find many illustrations of keen insight into logical problems and the theory of science, and the student of literature can find a real treasury of forcible and clear English prose. He died on 4th Dec. 1679, in his ninety-second year, and 'was buried,' as told by James Wheldon, 'in the parish church of Hault Hucknall, close adjoining to the raile of the monument of the grand-mother of the present Earle of Devonshire, with the service of the Church of England by the minister of the parish' (Aubrey, i. 382).

Hobbes is described by John Aubrey, his friend and contemporary, as six feet high and something better; with a good eye of hazel colour; with a head of mallet form approved by the physiologists, and with a temperament 'sanguineo-melancholicus,' similarly approved; of temperate and regular habits; as an harmonical soul and not a woman-hater, although never married; of a sharp wit which was also sure and steady; as one who contemplated more than he read, and who remarked 'that if he had read as much as other men, he should have been as ignorant as they'; and as a man who 'would have the worship of God performed with musique' (*ib.* i. 348 f., 354).

2. Writings.—The writings of Hobbes show how wide his intellectual interests were. Especially

noteworthy is his interest in Greek literature, rhetoric, and mathematics. His translations are vigorous and suggestive. His rhetoric is largely an unacknowledged reproduction of Aristotle. His mathematical writings expose his deep interest in the subject and also an incapacity to handle the more difficult problems. He believed he had squared the circle, and he engaged in controversies which redounded more to the credit of his adversaries than himself. The complete list of his writings is as follows:

The History of the Grecian War written by Thucydides, London, 1628; *de Mirabilibus Pecci*, do. 1636; *Objectiones in Cartesii de Prima Philosophia Meditationes*, Paris, about 1641; *Tractatus Opticus*, do. 1644; *Elementa Philosophica de Cive*, Amsterdam, 1647 (a few copies were privately printed in Paris, 1642, with the title *Elementorum Philosophicæ Sectio Tertia, De Cive*; in English: *Philosophical Rudiments concerning Government and Society*, London, 1651); *Human Nature*, do. 1650; *de Corpore Politico, or Elements of Law*, do. 1650; *Answer to Davenant's Preface before Gondibert*, Paris, 1650; *Leviathan*, do. 1651; *Of Liberty and Necessity*, do. 1654; *Elementorum Philosophicæ Sectio Prima, de Corpore*, London, 1655, published in English, do. 1656; *Six Lessons to the Professors of Mathematics*, do. 1656; *Questions concerning Liberty, Necessity, and Chance*, do. 1656; *Marks of the Absurd Geometry, etc., of John Wallis*, do. 1656; *de Homine, sive Elementorum Philosophicæ Sectio Secunda*, do. 1657; *Examinatio et Emendatio Mathematicæ Hodiernæ*, do. 1660; *Dialogus Physicus, sive de Natura Aeris*, do. 1661; *de Duplicatione Cubi*, do. 1661; *Problemata Physica*, do. 1662; *Considerations upon the Reputation, etc., of Thomas Hobbes*, do. 1662; *de Principiis et Ratiocinatione Geometricarum*, do. 1666; *Appendix ad Leviathan*, Amsterdam, 1668; *Quadratura circuli, Cubatio sphaeræ, Duplicatio cubi*, London, 1669; *Letter to the Right Honourable Edward Howard*, do. 1669; *Rosetum Geometricum*, do. 1671; *Three Papers presented to the Royal Society*, do. 1671; *Principia et Problemata aliquot Geometrica*, do. 1672; *Luz Mathematica*, do. 1672; *The Voyage of Ulysses*, do. 1673; *Epistola ad Anthony a Wood*, do. 1674; *The Iliad and Odyssey of Homer*, do. 1675; *Letter to the Duke of Newcastle, on the Controversy about Liberty and Necessity*, do. 1676; *Decameron Physiologicum*, do. 1678; *T. Hobbes Malmesburiensis Vita Carmine Expressa*, do. 1679, published posthumously; *An Historical Narration concerning Heresy, 1680; Behemoth: the History of the Causes of the Civil Wars of England*, London, 1680 (an edition from a defective MS was published without the authority of Hobbes in 1679 shortly before his death); *T. Hobbes Malmesburiensis Vita*, do. 1681; *The Whole Art of Rhetoric*, do. 1681; *The Art of Rhetoric*, do. 1681; *The Art of Sophistry*, do. 1681; *A Dialogue between a Philosopher and a Student, of the Common Laws of England*, do. 1681; *Answer to Bishop Bramhall's Book called 'The Catching of Leviathan'*, do. 1682; *Seven Philosophical Problems*, do. 1682; *Historia Ecclesiastica*, do. 1688; a few letters have been published by Molesworth in vol. v. of the *Latin Works* and vol. vii. of the *English Works*.

3. Philosophy.—Although Hobbes is best known for his political theory, he himself regarded that theory as a part of a comprehensive and unified philosophy, and as a specific illustration of its principles. His statement in the 'Preface to the Reader' prefixed to his *Philosophical Rudiments* is a characteristic expression of his point of view:

'I was studying philosophy for my mind sake, and I had gathered together its first elements in all kinds; and having digested them into three sections by degrees, I thought to have written them, so as in the first I would have treated of *body* and its general properties; in the second of *man* and his special faculties and affections; in the third, of *civil government* and the duties of subjects. Wherefore the first section would have contained the *first philosophy*, and certain elements of physics; in it we would have considered the reasons of *time, place, cause, power, relation, proportion, quantity, figure, and motion*. In the second, we would have been conversant about *imagination, memory, intellect, ratiocination, appetite, will, good and evil, honest and dishonest*, and the like. What this last section handles, I have now already showed you. Whilst I contrive, order, pensively and slowly compose these matters (for I only do reason, I dispute not;) it so happened in the interim, that my country, some few years before the civil wars did rage, was boiling hot with questions concerning the rights of dominion and the obedience due from subjects, the true forerunners of an approaching war; and was the cause which, all those other matters deferred, ripened and plucked from me this third part. Therefore it happens, that what was last in order, is yet come forth first in time' (*English Works*, vol. ii. p. xix).¹

The Latin titles of his three principal works reflect this general plan—*de Corpore, de Homine, de Cive*. These main divisions of philosophy are in their turn subdivided, but his philosophy finds its unity in the conception of bodies and their

¹ All references are to the Molesworth edition of Hobbes' works.

relations to one another. There are two kinds of bodies, 'one whereof being the work of nature is called a *natural body*, the other is called a *commonwealth* and is made by the wills and agreement of men' (*ib.* i. 11). Accordingly, the whole body of knowledge may be divided, as he divides it in the elaborate table of the sciences in ch. ix. of the *Leviathan*, first of all into those sciences which deal with 'consequences from the accidents of bodies natural' and those which deal with 'consequences from the accidents of politic bodies.'

This general and comprehensive scheme of a system of philosophy indicates one of the two chief ideas which are characteristic of Hobbes's thinking. Bodies, that is, things which can be moved, are the elements with which he deals. They are, including the human body, natural, and they move according to laws of motion which are natural to them. There is, consequently, a natural condition or state of bodies which follows from their mutual interactions and is the basis for any control or manipulation of them. This, in his view, is true not only of inanimate bodies, but also of man himself. There is a natural condition of mankind which illustrates the results which flow from his natural motions. This natural condition may be so controlled and regulated that a commonwealth is constituted. The State becomes thus the organized control of the natural motions—'the dispositions, affections and manners'—of men. It is a product of art utilizing Nature.

The other idea which markedly determines his reason is found in his conception of science itself.

'There are,' he writes in ch. ix. of the *Leviathan* and elsewhere, 'of knowledge two kinds; whereof one is knowledge of fact, and the other knowledge of the consequence of one affirmation to another. The former is nothing else but sense and memory, and is absolute knowledge. . . . The latter is called science and is conditional.'

This 'conditional' character of science does not, however, impair its usefulness. The ability of man to organize his observations in a connected discourse is responsible for all the benefits of civilization.

'The end of knowledge is power; and the use of theorems (which, among geometricians, serve for the finding out of properties) is for the construction of problems; and, lastly, the scope of all speculation is the performing of some action or thing to be done. . . . Now, the greatest commodities of mankind are the arts; namely, of measuring matter and motion; of moving ponderous bodies; of architecture; of navigation; of making instruments for all uses; of calculating the celestial motions, the aspects of the stars, and the parts of time; of geography, etc. By which sciences, how great benefits men receive is more easily understood than expressed' (*English Works*, i. 7).

The conditional character of science does, however, involve an important consequence for Hobbes's philosophy. Science is concerned with consequences, with results that follow from accepted premisses or initial truths. It is dependent on these premisses and truths, and is conditioned by them. So far as we have the chain of possible consequences in mind, there is no source of difference of opinion in science itself which industry, discipline, and method may not remove. The source of controversy is exterior to science itself, in the initial premisses from which the consequences are drawn. These take their beginning from experience, from that other kind of knowledge which is not science, but fact. If the similar experiences of men were free from variations, from prejudices, and from self-interest, science, so far as it rests on fact, would be free from dispute. But experiences are not uniform. It thus happens that men differ in their opinions, not because of differences in their reasoning, but because of differences in their experiences which reason cannot settle. Such differences can be settled only by mutual agreement, or by the intervention of a constituted authority which arbitrarily decides all points at issue. Hobbes does not blink the rigid consequences of this conception of science. While he would commend his own

philosophy because of its consonance with every man's experience and its conformity with facts accessible to all, he repeatedly asserts that in questions of fact individual differences may be so great that only authority can settle them.

In these two principal ideas—(1) the idea of a natural order through the control of which all advantages of civilization and all social institutions arise, and (2) the idea of science as a body of consequences drawn from premisses which are often so subject to variation that they must be standardized by authority—the essential things in Hobbes's philosophy are contained. Nature is inadequate for man's uses without science and art, and these are inadequate to this service without a constituted authority. The problem of authority would not, however, be a serious one if it did not involve men so seriously in their social and civil relations; if it did not, that is, involve the whole problem of man's peace and safety. The problem of society becomes the problem of authority. With Hobbes it is the great problem of philosophy and overshadows all his other interests.

Hobbes's contributions to the philosophy of bodies in general do not deserve particular notice. He is influenced throughout by Galileo, and sees everywhere motion and the laws of motion. It is his transference of these ideas to psychology that is first of all significant. Sense, imagination, the association of ideas, the passions, and the will are all conceived and expressed by him in terms of motion, or, more precisely, in terms of the reactions called forth in men by the stimuli which affect them. Thus, sense is defined as a 'phantasm made by the reaction and endeavour outwards in the organ of sense caused by an endeavour inwards from the object, remaining more or less' (*ib.* i. 391). Imagination is 'decaying sense' and illustrates the law that motion, once started, continues until opposed by contrary motion; referred to the past, it is memory. The association of ideas—Hobbes speaks of the 'train of imaginations' or the 'train of thoughts'—arises from the fact that motions which are simultaneous or successive in sense tend to recur as a whole when any one of them recurs. Passions are the 'interior beginnings of voluntary motions,' and will is defined as the 'last appetite in deliberation,' that is, as the last motion in a delayed or suspended series of motions.

These ideas Hobbes deliberately opposes to the traditional psychology of his day. They made comparatively little impression at the time, but we can see in them now the first important general statement of the basal positions of the physiological psychology of a much later day. It is the reacting organism on which Hobbes lays emphasis, an organism which, excited by external stimuli, reacts only after the excitations received have been internally assimilated and organized.

'There is no other act of man's mind, that I can remember, naturally planted in him, so as to need no other thing, to the exercise of it, but to be born a man, and live with the use of his five senses. Those other faculties, of which I shall speak by and by, and which seem proper to man only, are acquired and increased by study and industry; and of most men learned by instruction, and discipline; and proceed all from the invention of words, and speech. For besides sense, and thoughts, and the train of thoughts, the mind of man has no other motion; though by the help of speech, and method, the same faculties may be improved to such a height, as to distinguish men from all other living creatures' (*ib.* iii. 16).

Because life itself is but motion, man can never be without desire or fear, just as he cannot be without sense. Thus, according to Hobbes, felicity is 'continual success in obtaining those things which a man from time to time desireth' (*ib.* 51); it is not 'the repose of a mind satisfied.' Nor does a man desire to enjoy once only, but rather 'to assure forever the way of his future desire; and this he can do only by having the power to do it'

(*ib.* 85). This is one of Hobbes's most important generalizations in view of his theory of the State. He expresses it most emphatically in these words:

'In the first place, I put for a general inclination of all mankind, a perpetual and restless desire of power after power, that ceaseth only in death. And the cause of this is not always that a man hopes for a more intensive delight, than he has already attained to; or that he cannot be content with a moderate power: but because he cannot assure the power and means to live well, which he hath present, without the acquisition of more. And from hence it is, that kings, whose power is greatest, turn their endeavours to the assuring it at home by laws, or abroad by wars: and when that is done there succeedeth a new desire; in some, of fame from new conquest; in others, of ease and sensual pleasure; in others, of admiration, or being flattered for excellence in some art, or other ability of the mind' (*ib.* 85 f.).

Associated with this is a second generalization of similar importance:

'Nature hath made men so equal, in the faculties of the body, and mind; as that though there be found one man sometimes manifestly stronger in body, or of quicker mind than another; yet when all is reckoned together, the difference between man, and man, is not so considerable, as that one man can thereupon claim to himself any benefit, to which another may not pretend, as well as he. For as to the strength of body, the weakest has strength enough to kill the strongest, either by secret machination, or by confederacy with others, that are in the same danger with himself' (*ib.* 110).

From this equality of ability men entertain equal hopes of securing the ends they desire.

'And therefore if any two men desire the same thing, which nevertheless they cannot both enjoy, they become enemies; and in the way to their end, which is principally their own conservation, and sometimes their delectation only, endeavour to destroy, or subdue one another. And from hence it comes to pass, that where an invader hath no more to fear, than another man's single power; if one plant, sow, build, or possess a convenient seat, others may probably be expected to come prepared with forces united, to dispossess, and deprive him, not only of the fruit of his labour, but also of his life, or liberty. And the invader again is in the like danger of another' (*ib.* 111).

Thus, in so far as men depend upon their natural powers, they are virtually in a state of war 'of every man against every man.' War is a man's natural condition, the results of which Hobbes thus eloquently describes:

'Whatsoever therefore is consequent to a time of war, where every man is enemy to every man; the same is consequent to the time, wherein men live without other security, than what their own strength, and their own invention shall furnish them withal. In such condition, there is no place for industry; because the fruit thereof is uncertain: and consequently no culture of the earth; no navigation, nor use of the commodities that may be imported by sea; no commodious building; no instruments of moving, and removing, such things as require much force; no knowledge of the face of the earth; no account of time; no arts; no letters; no society; and which is worst of all, continual fear, and danger of violent death; and the life of man, solitary, poor, nasty, brutish, and short' (*ib.* 113).

This 'natural condition of mankind' is not, as Hobbes expressly declares, the primitive condition in which men once lived. It was never universal. The nearest approach to it is, he thinks, represented in the 'savage people in many places in America.' Yet it is man's natural condition if we consider how his propensities express themselves in the absence of a restraining and superior power, and that the function of government is restraint and control, and observe that the police and the systematic guarding of property are evident indications of the suspicion men naturally have of one another. In other words, man is not naturally what the Greeks called a 'political animal.' Naturally he is an impulsive animal seeking the gratification of his desires, and the security of his life, and finding that this seeking brings him into competition with his fellows. As such his rights are measured and determined solely by his power to secure what he desires. He knows nothing of right and wrong, of justice and injustice, as over against his fellows.

'Where there is no common power, there is no law; where no law, no injustice. Force, and fraud, are in war the two cardinal virtues. Justice, and injustice, are none of the faculties neither of the body, nor mind. If they were, they might be in a man that were alone in the world, as well as his senses, and passions. They are qualities, that relate to men in society, not in solitude. It is consequent also to the same condition, that there be no propriety, no dominion, no mine and thine distinct; but only that to be every man's, that he can get;

and for so long, as he can keep it. And thus much for the ill condition, which man by mere nature is actually placed in; though with a possibility to come out of it, consisting partly in the passions, partly in the reasons' (*ib.* 115 f.).

It is upon such a foundation that Hobbes conceives the State, and, with the State, the moral laws, to be built. The fear of death, the necessity of a sure provision for the needs of life, the disastrous consequences of enmity and war, are tendencies which naturally incline men to peace. These tendencies are supplemented by reason, which leads men to agree or attempt to agree with one another and to set up certain rules of conduct which make for peace. These rules suggested by reason Hobbes calls 'laws of nature,' of which the two most fundamental are: (1) 'that every man ought to endeavour peace as far as he has hope of obtaining it, and, when he cannot attain it, that he may seek and use all helps and advantages of war'; and (2) 'that a man be willing, when others are so too, as far forth as for peace and defence of himself he shall think it necessary, to lay down this right to all things; and be contented with so much liberty against other men, as he would allow other men against himself' (*ib.* 117 f.). From these fundamental natural laws or dictates of reason Hobbes deduces others, all looking towards the establishment of peace through mutual agreements, concessions, and covenants.

He insists, however, that these laws are contrary to our natural passions, as they impose restrictions on our desires. They are obeyed only so long as obedience to them is necessary and profitable, if there is no established power to enforce them. 'Covenants without the sword are but words and of no strength to secure a man at all' (*ib.* 154). Consequently, *mutual* concessions and covenants are not sufficient. To live peaceably men must agree to transfer all their individual power to a single individual or a group of individuals, that is, to a sovereign. Only then is a State established. But the transfer of power must be absolute and thereby the sovereign becomes an absolute sovereign. To him belong ultimately all decisions of right and wrong, of justice, and of property. By him all disputes are settled. From his decisions there is no appeal, for the idea of appeal contradicts the idea of a sovereign power, and is, therefore, irrational.

'This is the generation of that great Leviathan, or rather, to speak more reverently, of that mortal god, to which we owe under the immortal God, our peace and defence. For by this authority, given him by every particular man in the commonwealth, he hath the use of so much power and strength conferred on him, that by terror thereof, he is enabled to perform the wills of them all, to peace at home, and mutual aid against their enemies abroad. And in him consisteth the essence of the commonwealth; which, to define it, is *one person, of whose acts a great multitude, by mutual covenants one with another, have made themselves every one the author, to the end he may use the strength and means of them all, as he shall think expedient, for their peace and common defence*' (*ib.* 158).

The sovereign power may be attained by voluntary agreement or by natural force.

It is thus clear that Hobbes regards the State as a product of man's attempt to control, through the use of his reason, his natural desires and propensities. No such control would be necessary if the desires of men did not conflict. The existence of the State implies, therefore, restriction, and consequently needs to be supported by force. In other words, men do not *naturally* consent to be governed. Government can exist, therefore, only so long as it is absolute. Any other condition is incipient war or revolution. It is to be noted, further, that Hobbes bases all morality on the decisions of the sovereign power. There is no natural right or wrong, justice or injustice. Virtue is not, like sense, the natural exercise of a natural faculty. It is a thing imposed on nature, and is practised only so long as there is interest or power

to enforce it. Hobbes is thus not properly classified as either an egoist or a hedonist. With him morality is wholly a political matter, and politics is wholly the work of reason.

Religion Hobbes defines as 'fear of power invisible, feigned by the mind or imagined from tales publicly allowed' (*ib.* 45). If the tales are not publicly allowed, the fear is superstition. It is thus clear that Hobbes makes religion also a political matter. Yet he recognizes also a 'kingdom of God.' That which is significant in his philosophy here is not its positive content, but the separation of the doctrine of God from all that concerns the doctrine of Nature.

'The Scripture was written to show unto men the kingdom of God and to prepare their minds to become his obedient subjects; leaving the world and the philosophy thereof to the disputations of men for the exercising of their natural reason' (*ib.* 68).

To enter the kingdom of God it is necessary to believe that Jesus is the Christ and to obey the laws of God. In a Christian commonwealth there can be no conflict between allegiance to God and to the State. It is only when the civil sovereign is an infidel that such a conflict may arise, for it is a law of God, found out by reason, that subjects should obey their sovereigns. Yet even here the conflict can arise, Hobbes thinks, only when an infidel sovereign commands a Christian subject to renounce Christ. Then the subject has no resource

but to 'go to Christ by Martyrdom.' Apart from what Hobbes regards as the essential tenet of the Christian faith—namely, that 'Jesus is the Christ, the son of the living God'—all the public regulation of religion rests with the sovereign. He is thus to the end of his doctrine the political philosopher who would have the State supreme in all those matters which affect the mutual relations of men. Yet his emphasis on absolute power does not fall in the interests of the rights of sovereigns, but in the interests of peace and public safety.

LITERATURE.—The principal ed. of Hobbes's works is that by W. Molesworth (London, 1839-45) in 16 volumes, 11 containing the works in English, 5 the works in Latin, an extensive index, and a number of plates. This ed. contains also the chief sources of his life, namely, his autobiography and the account of him by John Aubrey. The best ed. of the *Leviathan*, his most widely known work, is the Cambridge Press ed. of 1904. In addition the following may be mentioned: G. Croom Robertson, *Hobbes*, Edinburgh, 1886; F. Tönnies, *Hobbes Leben und Lehre*, Stuttgart, 1896; E. H. Sneath, *The Ethics of Hobbes*, Boston, 1898; F. J. E. Woodbridge, *The Philosophy of Hobbes*, in extracts and notes collated from his writings, Minneapolis, 1903; Leslie Stephen, *Hobbes*, London, 1904; Mary W. Calkins, *The Metaphysical System of Hobbes*, Chicago, 1905. FREDERICK J. E. WOODBRIDGE.

HOFFMANNITES.—See FRIENDS OF THE TEMPLE.

HOLI.—See DRAVIDIANS, FESTIVALS (Hindu).

HOLINESS.

General and Primitive (N. SÖDERBLOM), p. 731.
Greek (I. F. BURNS), p. 741.
NT and Christian (R. H. COATS), p. 743.

Roman (J. S. REID), p. 750.
Semitic (O. C. WHITEHOUSE), p. 751.

HOLINESS (General and Primitive).—1. Holiness is the great word in religion; it is even more essential than the notion of God. Real religion may exist without a definite conception of divinity, but there is no real religion without a distinction between holy and profane. The attaching of undue importance to the conception of divinity has often led to the exclusion from the realm of religion of (1) phenomena at the primitive stage, as being magic, although they are characteristically religious; and of (2) Buddhism and other higher forms of salvation and piety which do not involve a belief in God. The only sure test is holiness. From the first, holiness constitutes the most essential feature of the divine in a religious sense. The idea of God without the conception of the holy is not religion (F. Schleiermacher, *Reden über die Religion*, Berlin, 1799). Not the mere existence of the divinity, but its *mana*, its power, its holiness, is what religion involves. This is nowhere more obvious than in India, where the men of religion, through their art of acquiring holy power, became dangerous rivals of the gods, who, in order to maintain something of their religious authority, were obliged to adopt ascetic holiness themselves (*Sat. Brāhm.* ii. 2. 4, ix. 1. 6, 1 ff.). The definition of piety (subjective religion) runs thus: 'Religious is the man to whom something is holy.' The holy inspires awe (*religio*).

The original idea of holiness seems to have been somewhat indeterminate, and applied to individual things and beings. Then the great systems were evolved which are found (1) in barbaric societies, such as the Polynesian, West African, etc.; and (2) in nomistic religions such as the Avestan, and in Judaism, where everything is arranged under the categories of 'tabu' (holy) and ordinary (profane). The 'holy' is apart from ordinary life. Spiritual religion tries to abolish the outwardness of this distinction and to make it a purely personal one.

Hence it strives to bring the whole of life under the sway of holiness. The prophetic religion in Israel considered the whole people of Israel as holy (Lv 19² 20^{7, 24}, Jer 2³, Is 62¹² 63¹⁸ etc.) by bringing the idea of 'the chosen people' into connexion with the idea of holiness. But the ideal of spiritual religion—that every person and every thing should be holy—is an absurdity to primitive tabu systems and to nomistic holiness, because something must be left free for use. In the same way ascetic schemes of salvation presuppose that some people are not holy, religious, in a strict sense. If every one were 'religious,' 'holy,' there would be no families, no future generations, nobody to till the ground, constitute society, and perform the daily labours.

2. Holiness is viewed as a mysterious power or entity connected with certain beings, things, events, or actions. Amongst the Melanesians everything that exceeds the ordinary capacity of man or the ordinary course of nature is called *mana*.¹ In some cases, as with this Melanesian *mana*, the power is expressly reserved for certain beings. Some souls, e.g., have no *mana*, and, therefore, are soon forgotten and receive no worship. In other cases, as with the Iroquoian *orenda*, 'this hypothetic magic is held to be the property of all things, all bodies,' etc. (J. N. B. Hewitt, 'Orenda and a Definition of Religion,' in *Amer. Anthropologist*, new ser., 1902, p. 33 ff.). But in any case only its concentrated appearance in some beings and things is of practical importance. Of the somewhat analogous conceptions and words

¹ From the classical work of R. H. Codrington, *Melanesians* (Oxford, 1891), this term has been adopted, through L. Marillier, R. R. Marett, etc., as the general term for positive holiness working as power, as distinguished from negative holiness involving the conception of danger, interdict, prohibition, which in current terminology is now designated by the Polynesian word *tabu*.

which are to be found everywhere in primitive religions, we mention here a few examples:

The Australian *joia* (A. W. Howitt, *Native Tribes of South-East Australia*, London, 1904); the ancient Indian *brahman* (q.v.; cf. H. Oldenberg, in *Anzeiger für indogerm. Sprach- und Altertumskunde*, viii. [1897] 40; and N. Söderblom, *Gudstrons uppkomst*, Stockholm, 1913); the *tendi* of the Bataks; the *sunangat*, 'life-stuff,' and the *pemali*, 'extraordinary,' 'mysterious,' of the Malays (A. C. Kruijt, *Het Animisme in den indischen Archipel*, The Hague, 1906; W. W. Skeat, *Malay Magic*, London, 1900; Skeat-Blagden, *Pagan Races of the Malay Peninsula*, do. 1906; J. Warneck, *Die Religion der Batak*, Leipzig, 1909); the *hasina* of the Malagasy (defined in the dictionaries as 'indwelling or supernatural power, which renders a thing good and effective; the power of a medicine; the truth of a word; the efficacy of amulets and incantations; the holiness of a thing,' etc.; cf. A. van Gennep, *Tabou et totémisme à Madagascar*, Paris, 1904); the *nlongo* of Congo languages (*nlongo* signifies 'medicine,' 'charm' [K. E. Laman, in his forthcoming *Dictionary*]); the *orunda* of the Mpongwe; the *eki* of the Fans (cf. A. Le Roy, *La Religion des primitifs*, Paris, 1909, and P. H. Trilles, *Le Totémisme chez les Fân*, Münster, 1912); the *dzo* of the Ewe (D. Westermann, *Wörterbuch der Ewe-Sprache*, Berlin, 1905); the *oudah* of the Pygmies (R. R. Marett, *The Threshold of Religion*, London, 1909); the *wakanda* of the Siouan Indians (which was used 'indiscriminately as substantive and adjective, and with slight modification as verb and adverb,' which may be translated by 'mystery,' 'power,' 'sacred,' 'ancient,' 'grandeur,' 'animate,' 'immortal,' although 'no English sentence of reasonable length can do justice to the aboriginal idea expressed by the term wakanda' [W. J. McGee, 'The Siouan Indians,' 15 *RBEW*, 1897, p. 182 ff.; J. O. Dorsey, 'Omaha Sociology,' 3 *RBEW*, 1884, p. 211 ff.]); the *orenda* of the Iroquoian Indians (denoting a mystic potency which is particularly great in the shaman, in the skilful hunter, in any man or animal who in fight, hunting, or play outmatches another; and which is 'regarded as related directly to singing and to anything used as a charm, amulet, or mascot, as well as to the ideas of hoping, praying, or submitting' [J. N. B. Hewitt, *loc. cit.*, p. 38 ff.]); the old Norse *hamingja*, 'luck,' 'success,' 'protecting genius,' 'fate,' of individuals and of clans (W. Groenbech, *Lykkemand og Niding*, Copenhagen, 1909, and *Soul or Mana*, do. 1913; cf. *Reports of the Intern. Congress of the History of Religion in Leyden*, 1912); the *makt*, 'might,' 'power,' of Swedish folk-lore (men and animals can be 'might-stolen' [*makt-stulna*], through evil influences; the old Norse said *hamstoli*, 'ham-stolen').

This mysterious holiness is to be found, in the first place, in the medicine-man, or priest-king, who is powerful and sacred (J. G. Frazer, *Lectures on the Early History of the Kingship*, London, 1905), and in the sacred formula which is used as a spell or a prayer. Further, it belongs to special objects which are connected in any way with the holy rites and the exercise of religion or magic, e.g. the *churinga* (*tjurunga*, Strehlow) of the central tribes of Eastern Australia (Spencer-Gillen^a, 1899, ^b 1904; C. Strehlow and M. F. von Leonhardi, *Die Aranda- und Loritja-Stämme in Zentralaustralien*, pt. iii., 'Die totem. Kulte,' Frankfurt, 1911), the bull-roarers, drums, rattle-staffs (the Mexican rattle-staff was called *chicauaztli*, 'that through which one makes strong, powerful' [E. Seler, in *Veröff. aus dem kön. Museum für Völkerkunde*, vi. (Berlin, 1899) 89]), and other things used in the mysteries; the West African *minkisi*, 'fetishes' (M. H. Kingsley, *West Afr. Studies*, London, 1899; R. E. Dennett, *At the Back of the Black Man's Mind*, do. 1906; Laman and other missionaries, in Nordenskiöld, *Etnografiska bidrag af svenska missionärer*, Stockholm, 1907). It also belongs to relics, amulets, divinities, their images, and everything connected with them. In a wider sense the mysterious power of holiness is supposed to be the cause of everything which is out of the ordinary course, and which, therefore, demands special explanation. Primitive man not being as yet an individual, but only part of society (the real unity), holiness is not a thing to be used for individual, anti-social, or selfish purposes—in which case its use becomes the worst of abuses, namely, sorcery or black art—but constitutes the great treasure of the community, manifested in its sacral institutions, in manifold objects, and in its members, who derive their life, power, and happiness from the general holiness, and at the same time have to enhance and concentrate this common mysterious influence through their ritual celebrations and

manly actions. But the essential connexion between 'the sacred' and society does not imply that the notion of the 'sacred' is merely a kind of objectifying and idealizing of the community as a power mysteriously superior to the individual (E. Durkheim, *Les Formes élémentaires de la vie religieuse*, Paris, 1912).

We meet, of course, with somewhat different lines of evolution in proceeding from the most primitive stages onwards, and a supposed uniformity must not be allowed to obscure the peculiar features of holiness in particular societies at the lower stages of civilization. But, as far as we can see, the psychological origin of the conception of holiness seems to have been the mental reaction against what is startling, astonishing, new, terrifying. This reaction may have expressed itself in a cry or an exclamation. Individual experiences influenced the collective mind, which by degrees created forms of language which gave more durable expression to the mental reaction in face both of what was really new and of certain often recurring phenomena which never cease to startle and awaken a vivid emotion. A motley series of beings, things, events, and actions are named by such words as 'the great one,' 'the powerful,' 'very old,' 'dangerous,' 'successful,' 'divine,' etc.; and—what is still more significant—those things are surrounded, by a natural reaction, with a fence of precautions and interdictions. The first point is that these startling things are not to be treated lightly. It is evident that the idea of the extraordinary (this seems also to be the original meaning of the Semitic *qds*; cf. below, p. 751^b), as distinguished from the ordinary, already exhibits a tendency towards the conception of the supernatural. Primitive man is unable, indeed, to conceive anything beyond Nature or higher than Nature; yet the term 'supernatural' may perhaps supply the best conception of what 'the holy' means to him.

'Holiness' so conceived is the most valuable source of health, strength, food, success, influence; at the same time, it involves a constant danger. Hence the rites to which the conception gives rise have either a positive or a negative character.

3. The positive rites have as their object the acquiring, concentrating, and utilizing of holiness. (1) *Augmenting rites* are to the greatest extent employed in order (a) to produce or augment the supply of food—e.g. Australian *intichiuma* and ceremonies analogous to the agricultural rites in which the holy power may be concentrated in the last sheaf, a cake, an image, an animal, a tree, or a man. Phallic or sexual religion is also chiefly concerned with the well-being of the herds and of the field. In order to secure fertility, the art of producing rain and sunshine was exercised; and fishermen needed a suitable wind. Everything is accomplished through the power of holiness, natural or acquired; at the same time a certain technique is elaborated, with impersonal rules and laws. (b) The power may also be acquired in other ways than those connected with the procuring of ordinary food. One may receive it through blood, which is either drunk or smeared over the body. It may be communicated by saliva or breath. Parts of beasts or men imbued with the mysterious thing may be eaten; or men, perhaps one's own sons, may be killed in order to add to one's capital of life. Sacrifice served as a means of endowing with holy power, before it was brought into connexion with a divinity, in the way of communion or by being considered as a gift. The sacrifice exercises an immediate effect. This is obvious, e.g., in the foundation- or building-sacrifice, where the life that is sacrificed communicates *mana*, strength, to the foundations and to the house. Even when a sacrifice is presented to a divinity, the original

conception may prevail. The sacrifice communicates holiness or power. Therefore the images of the gods are smeared with blood, the precious fluid which contains the *mana*. In the religion of blood *par excellence*—that of ancient Mexico—the men pour out their blood from tongue or members in order to strengthen the gods, and the divinities are portrayed as catching in their mouth the jet of blood from the victim. Blood appears with grim frequency in the Mexican sacred rites; it enabled the divinities to pursue their beneficent tasks in Nature (G. E. Seler, *Gesammelte Abhandlungen zur amer. Sprach und Altertumskunde*, ii. [Berlin, 1904] 704 ff. and *passim*; *Codex Borgia*, i. [Berlin, 1904] 174 ff.). The scalps which are seen hanging in the clubhouses of the Pacific islanders are not mere decorations; they are mainly sources of power to the community. To this group may also be assigned the ceremonies intended to secure help against sickness, and success in hunting, love, or war. To the category of augmenting rites belongs also the art of injuring or killing enemies, because this increases the vitality of the community. But *corruptio optimi pessima*. When used against members of one's own blood or one's own community, such practices become the blackest sin.

(2) *Revealing rites* have the object either of (a) revealing the future—oracles, prophecy; or of (b) indicating the guilty—ordeals, which originally operated directly without any divine intervention.

(3) In the *initiatory rites* to (a) manhood, (b) secret societies, or (c) the priesthood, the positive element, i.e. the acquiring of holiness, is still more closely bound up with the negative element of danger and prohibition.

(4) In the *interdicts and observances imposed on holy persons* it is impossible to determine in every case whether the value or the danger of holiness is the predominant motive. As we have seen, value and danger are blended together in 'the holy.' The holy man exposes himself to personal danger in performing acts which are forbidden or tabu. At the same time such precautions are intended to preserve the precious power in him which guarantees the welfare of the community. They may be said to have also a positive purpose. Holy persons are subjected to more severe restrictions than ordinary people, because they stand in a more important relation to holiness and religion (just as orthodoxy is more rigidly required of clerics than of laymen).

4. The negative or prohibitory rites are designated in current language by the word *tabu* (the leading collection of tabu rites is that made by J. G. Frazer, *Taboo and the Perils of the Soul*, London, 1911). The word belongs in this form to the Tonga dialect in the Friendship Islands, and is a compound of *ta*, 'marked,' and *pu*, an adverb with an intensive force, hence = 'marked thoroughly' (Frazer, in *EBr.*, s.v. 'Taboo'). It is used in many regions of the Pacific in the sense of 'sacred,' 'holy,' 'prohibited,' 'forbidden' (besides other words, such as *rahui*, which is more common in Easter Island [W. Lehmann, *Anthropos*, ii. [1907] 258]). C. E. Meinicke (*Die Südseevölker und das Christentum*, Prenzlau, 1844) called attention to its signification as a divine power, manifesting itself in such a way that everything to which it is applied is withdrawn from the use of ordinary people. Everything was divided into two classes: *moa*, that which was withdrawn from ordinary use; and *noa*, the usual, the common, the profane. Thus the tabu is closely connected with the idea of *mana*.

Takao tapu means 'a secret word,' *vahi tapu*, 'a prohibited place,' 'a place regarded as holy'; *kiri tapu*, 'a sacred skin, one not to be touched or approached.' Verbal forms are *tabu*, 'to abstain from'; *tapui*, 'to make sacred'; *akatai u*, 'to make holy,' 'to consecrate' (E. Tregear, *Maori-Polyn. Comp.*

Dict., Wellington, 1891, s.v.). The forbidden is in Malagasy *fady*; *mifady* means 'to abstain from.' Among the Ba-Ronga (H. A. Junod, *Les Ba-Ronga*, Neuchâtel, 1899) *yila* corresponds to *tabu*. The Zulu says *zila* (*ila* with reflexive *zi*), 'to abstain from.' In the Bondai language *zila* means 'detest'; Congo dialects have *kizila* with the meaning of 'sacred object,' 'fetish.' A more special word is the Zulu *hlonipa* (*inhloni*, 'shame,' 'respect,' and *pa*, 'give'), 'to give respect,' 'to show special reverence,' in observing several rules of ritual. The wife has to *hlonipa* her husband and his parents by not using their proper names or words that resemble their proper names, by not touching their milk-vessels, etc. Mother-in-law and son-in-law must *hlonipa* each other by avoiding each other. Everybody must *hlonipa* the king and dangerous animals by not using their right names, etc. The Malays give their children *pantang* (= *tabu*) rules.

The close connexion of the tabu with the mysterious power is found in the common idea of extraordinariness. Tabu is thus what is new, e.g. the foreigner, the new-born child, the firstfruit, the new metal (iron); certain phenomena which constantly recur, but always seem to be extraordinary, e.g. sexual life, death, war, hunting; and animals and men endowed with special prudence, power, or success.

5. Later the tabu is often connected with the soul—a fact which admits of different explanations. The relation to the soul is sometimes secondary or imaginary; e.g., the reason alleged by the Bataks of Sumatra for not cutting all the hair of the child is connected not with *begu*, the soul (especially after death), but with *tendi*, the impersonal life-stuff, or *mana*. But sometimes the interdict refers to the soul or to other considerations equally foreign to holiness proper, although the general features are very similar. The distinction may be difficult or impossible to draw in every single case. Nevertheless, it is required by the essence of the tabu-holiness. Thus, a sacred being is subjected to a multitude of awkward rules and interdicts. He must not behold the sea or a lake, the sun must not shine on him, he must not touch the ground, not even his own head, nor eat with others, etc. Why? Because his soul is exposed to danger and may be injured or taken away? It is not so much a case of personal danger for the soul as of precautions against dissipating the precious holiness concentrated in the chief. Therefore he is himself dangerous to others who cannot bear contact with his *mana*. In death-rites the necessity of distinguishing the two motives—concern for the soul and for holiness—is more evident. (a) A dead body, either of man or of beast, is dangerous. A Kaffir who has killed a python is purified in water. A Laplander becomes tabu for three days after having killed a bear. At the ritual murder of the bear among the Ainu, in Siberia, and in Lapland, or of the bull at the *Bouphonia* in Athens, the killed animal is wept over and the killer undergoes a sham punishment. This may have something to do with fear of the ghost. But it may also depend upon the holiness of the animal or its kinship with man. The case is clearer with the widower in British New Guinea, who must hide himself like a wild beast and go about armed with a tomahawk against the dangerous soul of his dead wife. (b) Love, not fear, may also lead to special precautions. Pointed objects and knives must not be used after death, lest they may harm the dead. The Chinese even avoid using their eating-sticks during a certain time. Those rules do not belong to the tabu. (c) But it is impossible to explain the tabu of hunters and warriors, and mourning prohibitions in general, by fear or love of the dead person. The killing of a man or a beast shows the possession of a *mana* which makes it necessary for others to avoid him and his weapons and snares, and for him to submit himself occasionally to precautions analogous to those always observed by the sacred priest-king. The corpse also suggests uncanniness. Hence its im-

purity, and the withdrawal of the mourners from ordinary life. In Polynesia they must not carry food to the mouth with their own hands for ten months. The chief is always subjected to this rule, because of the holiness of his head. In this instance concern for the soul is excluded as an explanation. The tabu of the Laplander and the Kaffir and its purification mentioned above may both depend on their being charged with 'holiness,' *mana*. Or take the interdict as to preserving severed hair and nails or remains of meals. The reason is lest some one may take them and harm or kill their original owner by means of sympathetic magic, according to which the whole can be influenced through a part of it. This has nothing to do with tabu or holiness. But the case has another side. If the person to whom the hair and nails or the meal belonged is holy, it is tabu to touch them, because they are charged with holiness. The holy man in question must also take precautions against losing any of his precious power. Knots are often forbidden because they suggest complication and difficulty. Sympathetic magic uses them in order to cause hindrance and harm. The prohibition can acquire a secondary relation to holiness. The *flamen Dialis* in Rome, e.g., was forbidden to have any knots on his clothes, because they might be a hindrance to the beneficent action of his holiness.

6. It is, in fact, the essence of the tabu-interdict that it is not merely the avoiding of a definite danger by avoiding its cause (this may be a soul, sympathetic magic, the interest of society, or anything else); rather it amounts to an unconditioned and unreasoning 'you shall not.' The imperative character of duty, which Kant called the 'categorical imperative' and which he admired as the divine in man, is characteristic of primitive tabu, in spite of the differences as to the content of the prohibition or commandment. There is something mysterious, dreadful, about the danger of breaking a tabu (Marett, *op. cit.*). The aborigines cannot always tell the reason why a tabu is forbidden or why a thing or a being is holy. It is a fact, and a most important one. Of course, the tabu originates to a certain extent in natural observations. The rules can sometimes be traced back to a real practical interest and use. At a later rationalistic stage of religion, Jews, Parsis, and Hindus, with the help of Western scholars, have tried to trace in their tabus great improvements and discoveries in hygiene, breeding, and agriculture. Moses, Zarathushtra, and Manu, to whom the tabu systems were erroneously ascribed, have been praised as early discoverers of the conditions of health. This is not completely devoid of truth, but it misses the characteristic of tabu, which foreshadowed the idea of the supernatural rather than of the rational. The common custom of isolating the woman in child-bed in a miserable birth-hut, and handing her food on long poles, or of subjecting boys, and sometimes also girls, to barbarous tortures at initiation, is not a matter of hygiene. It is the danger due to holiness that demands such practices.

7. The unreasoning awe of tabu appears in the consequences of breaking it. (a) Death or sickness immediately follows. An Australian died when he heard that he had lain upon his wife's blanket. A Hova youth in Madagascar fell into convulsions when he learnt that the meat he had eaten belonged to an animal holy to his kin. How would the reader of the present article feel if he were told that he had been feeding on dog cutlets or human kidneys? The origin of death and sickness is often explained by the breaking of a tabu. The Ningpo in Bengal, we are told, were immortal until some one entered a pool which was tabu.

Pandora's box was not to be opened; when it was opened, diseases came out. The effect may be a direct one, just as fire burns or poison kills, without the intervention of a divinity, which constitutes a secondary explanation. With the development of worship, tabu-rules come to be regarded as divine commandments. In other cases society sanctions the tabu through punishments inflicted upon the guilty, for holiness is the very source of life and strength to society. Such was the cause of the massacre of Marion and his crew in the Pacific in 1772. They had tried to catch fish in a holy place. In 1899 the men of the ship *Boyd* were murdered in New Zealand, because the captain had treated the son of a chief, i.e. a tabu person, in an ignominious way. Animals as well as men are killed if they defile holy ground by entering it or in any other way. In 1 S 5¹² 6^{19a}, 2 S 6^{6a}, 1 Ch 13^{7a}, Jos 6¹⁸, death or plague follows directly (in Jos 3¹³ the holy object exercises its power otherwise). In Lv 10 God punishes the breaking of a tabu. Even where a divine punishment is referred to, the original meaning sometimes seems to have implied an immediate consequence of touching the holy, as Nero's illness after his sacrilegious bath in holy water (*Tac. Ann.* xiv. 22). In Jos 7²⁵ the punishment is inflicted by the community, as the Ewe used to burn alive a man who had killed the holy python. Such punishments occupy a large portion of sacred law everywhere (cf. E. Krueger, *De Romanorum legibus sacris*, Königsberg, 1912). Sometimes, as in Ex 19^{12a}, Lv 19⁸, Nu 1³¹, we do not exactly know whether the penalty of death is referred to the inherent holiness of the thing, to God's vengeance, or to judicial punishment.

(b) There are also milder consequences, punishments, which at the same time effect a purification; or the immediate harmful consequence or punishment has its place taken by ceremonies for removing the contagion. There is anxiety to get rid of the dangerous stuff, whether it is considered as too strong a dose of holiness or as entirely bad. If a man had happened to touch a Tonga chief, he dared not put his food into his mouth with that hand before he had returned the mysterious power to the chief by rubbing the front and the back of his hand against the sole of the chief's foot and afterwards cleansing his hand with water. To such averting rites belong all kinds of purifications and atonement after murder, sexual intercourse, child-birth, etc. A scapegoat may be made to bear the impurity. Tabu food may be vomited up. Likewise the heart is disburdened of its sin by confession. (1) The medicine-man gives 'a pretended emetic' to one whose breaking of some tabu is manifested by pains, sickness, misfortune. Confession itself effects a deliverance; sin and its evil consequences are lessened by confession. The modern idea of sin as sickness is, in fact, the primitive one. (2) At a later stage, sin is considered as an offence against God or man, and confession is addressed to Him, and is not merely a kind of physical deliverance. But the immediate comfort of confession is not forgotten (Ps 32). Adversities show that God is angry. Why? Because of sin, of which the guilty one himself is perhaps unaware. He confesses his sins, known and unknown, in order to remove the cause of his misfortune. (3) Sin has two consequences: physical, material disaster; and the sense of guilt. At a higher stage the latter consequence is more feared than the former. Confession is intended to obtain pardon and to remove the guilt rather than the material results of the sin.

(c) In many cases the breaking of a tabu cannot be avoided. It is impossible entirely to avoid touching 'the holy.' The new-born child must be cared for. The woman in child-bed cannot be left

completely alone. The corpse requires to be moved and attended to in some way. One cannot help seeing and meeting foreigners. The firstfruit is full of mysterious power, but it constitutes the very sustenance of men. How is the precious power to be appropriated without incurring risk? By taking an antidote or a homœopathic preventive, or by rendering oneself immune in some other way against the danger of holiness. Such precautions form the kernel of a set of primitive rites which, later on, assume another meaning. The most important are: (1) 'politeness' ceremonies *vis-à-vis* strangers, in which, no doubt, natural kindness accounts for much, and is closely connected with the tabu fear (E. Westermarck, *MI*, London, 1906, i. 585 ff.); (2) funeral rites (see DEATH AND DISPOSAL OF THE DEAD); (3) puberty rites and wedding ceremonies, which are intended at once to indemnify against the danger of sexual holiness-tabu and to secure its efficacy in the matter of fecundity; (4) firstfruit rites at the birth of children and animals and before the eating of the first crops in the spring (see FIRSTFRUITS). In these ceremonies as well as in sacrifice (H. Hubert and M. Mauss, *Mélanges d'histoire des religions*, Paris, 1909; cf. *Satapatha Brāhmaṇa* [*SBE* xii. etc.]) and other rites mentioned above, we can sometimes distinguish introductory rites designed to prepare for intercourse with the holy in order to avoid its dangers; and averting rites, which are intended to remove the holiness before resuming ordinary life.

8. The value of primitive holiness or tabu lies (a) in the strength and coherence it gives to society, for 'the holy' supplies a perpetual centre of gravity, manifested in holy things, beings, places, and actions. In his doings and feelings the individual more or less approaches 'the holy,' but he is never completely out of touch with it. To us the tabu rules and the objects charged with holiness seem to be pure nonsense. But to the primitive mind they constitute the precious treasures of the community, from which strength, success, and confidence are derived. How strict and elaborate the systems of holiness are, e.g., in West Africa, has been told by M. H. Kingsley, Dennett, Ellis, Nassau, Spieth, Laman, Hammar, and others. Certain widely diffused festivals, in which the usual bonds and rules of society are relaxed, seem to have been designed for the purpose of renewing the quickening and strengthening essence of holiness in the tribe or people.

The social assurance afforded by the tabu systems appears in the superiority felt over tribes that have less numerous or less severe tabus. The tabu is regarded as a mark of distinction. The Zulu boy, in refusing to eat fish among the Thonga, the northern neighbours of the Zulus, boasts of belonging to a race superior to those wretched Ba-Thonga who eat fish (H. A. Junod, *The Life of a South African Tribe*, ii., Neuchatel, 1913, p. 67).

(b) The tabu imposes upon primitive man numberless intolerable, cruel, and harassing observances, which make his life a bondage. Freedom does not lie at the bottom, but is found perhaps at the top, of the scale of human development. At the same time the superstitious sanction of the rules of holiness has had an inestimable influence on civilization and the improvement of society. Animal desires were restrained; in the hard school of tabu man was taught self-control. Through abstinence and self-restraint man acquires strength and power not only over himself but also over others. It is not impossible that such an experience underlies the institution of tabu (Marett, at the Summer School of Theology, Oxford, 1912). At any rate such was its effect. J. G. Frazer has shown in his treatise entitled *Psyche's Task, a Discourse concerning the Influence of Superstition on*

the Growth of Institutions (London, 1909), what the system of holiness meant for the establishment and stability of government, for the security of private property against theft and destruction, for the sanctity of marriage, and, above all, for the respect for and protection of human life. Civilization and progress are inconceivable without the profoundly unreasoning sanction afforded by holiness. The tabu

'is inspired by strange, unscientific physiological ideas regarding defilement and contagion which will disappear when scientific knowledge has spread amongst them. But let these ideas be somewhat amended, let the natives understand that what is taboo is not physical uncleanness but moral evil, and their strong aversion to the act tabooed may become a powerful moral impulse for good' (Junod, *op. cit.* i. 9; cf. the Edinburgh Conf. on Missions, 1910, *Rep. of Com.* iv. 11).

Rational insight has gradually superseded barbarous rites and dispelled superstitious awe. As to the main principle of holiness—its unconditional imperative character and 'supernatural' sanction—the question is whether humanity can dispense with it in the future, and be guided by merely rational motives without religious guarantee and enforcement. This question has both a practical and a theoretical side. The practical problem is whether the self-restraint and effort necessary to civilization can be maintained without the unreasoned element inherent in the conception of holiness and developing its intrinsic value throughout the history of civilization. The theoretical problem lies deeper: Has the imperative and absolute form of duty any metaphysical grounds, or is it based on an initial error, by which humanity has been misled throughout its whole existence?

9. In order to apprehend the chief kinds of holiness, we make the following divisions:

(1) Original tabu may be *continuous* or *intermittent*. (a) Certain men, animals, things, and actions are always charged with holiness, and are therefore tabu. Such are shamans, priest-kings, and others. A chief in New Zealand was charged with holiness to such a degree that no one was allowed to touch him, even if he were in mortal danger. If he breathed on a fire, it could not be used for cooking. The vessels from which the Mikado used to eat were, as a rule, afterwards destroyed. If another man ate food from them, his mouth and throat would swell. Sometimes an animal is tabu for a whole people, as the pig in Syria, and the cow in Irān and India. Sometimes the tabu extends only to a clan or a kindred. Words are tabu, such as names of higher human or divine beings, holy or dangerous animals. Occasionally we find a whole tabu language, which is learnt at initiation, and used on special occasions, as in the mysteries, in the chase, in fishing, in reaping, and in war. Objects and places belonging to the sacred rites, to gods, or to holy men or secret societies are tabu. The holy man or animal is divine, and is worshipped in proportion as real worship is instituted and the notion of divinity evolved. They may be worshipped even during life, but especially after death, when the general awe of ghosts enhances the conception of their *mana*. Sometimes the holy power of a man is detected only after his death, through actions attributed to his soul. Such a *tindalo* receives worship amongst the Melanesians (Codrington, 125 ff.); other dead people are forgotten. So also the Veddas in Ceylon are concerned to know whether a dead man's spirit is a *yaku*, i.e. a powerful or holy one whom reverence and prudence bid them worship (C. G. and B. Z. Seligmann, *The Veddas*, Cambridge, 1911). The same idea underlies the system of relics and the worship of saints in higher religions. Their holy, wonder-working power is utilized and duly revered.

Certain days are full of danger. Work, pleasure, and undertakings which are carefully specified

must be omitted on these days. The institution of sacred or tabu days is known to several 'primitive' peoples in modern times, and was familiar to ancient peoples in different forms, e.g. the Egyptians, the Babylonians, and the Romans (*dies nefasti*). Such was probably the origin of the Sabbath (*q.v.*) in the OT. The genius of Mosaism gave to the tabu-day a new positive character of rest after work (otherwise R. Kittel, *Gesch. des Volkes Israels*², i. [Leipzig, 1912] 623); but in later Judaism the day recovered something of its gloomy tabu-character (cf. J. Hehn, *Siebenzahl und Sabbat bei den Babyloniern und im Alten Testament*, Leipzig, 1907; H. Webster, *Rest Days*, Lincoln, Nebraska, 1911).

Our abstract and conventional conception of time and space as measure is foreign to primitive man. To him time is, or rather times are, real and concrete. Some days and occasions contrast as extraordinary or tabu with the ordinary days. Such holy times, e.g. festivals and dangerous days, mark epochs in the general flux of existence, and give rise to the religious calendar. Thus the primitive apprehension of time originates in the conception of the holy. In a similar way tabu places awake a distinctive emotional notion of space.

(b) After death and on special occasions during life every one is tabu. The sexual life is accompanied by strange entrancing feelings and uncanny phenomena. In hunting and warfare even the ordinary man experiences the mysterious power, and must submit himself to restrictions and observances that are not required in his everyday life, but which are often identical with what shamans, priests, and kings are bound to observe always. We often encounter the notion that women dying in child-bed, fishermen drowned, or hunters killed during the performance of their perilous work, and warriors slain in battle (the *valr* of the Norse Valhall) obtain a better lot after death than other mortals. If two realms of the dead are recognized, these men and women come to the place reserved for 'better people,' i.e. for the *mana*-endowed, hence mighty and rich and noble in life, whereas the common man retains his dull and inferior condition also after death. It is tempting to adopt the explanation of this which attributes a higher moral value to the chief female and male vocations in life. But the reason, no doubt, lies in the holiness, or *mana*. The mysterious power that confers good fortune and superiority works also after death. Some men possess it always, ordinary mortals only in child-birth, war, hunting, and on certain other occasions.

(c) Some tabus affect every one, others only certain people. Mother-in-law and son-in-law are tabu to each other, also men and women in general to a certain extent (A. E. Crawley, *The Mystic Rose*, London, 1902, *passim*). A man may not marry a woman of his own clan, or even of any other clan indifferently. In Australia the totem (see TOTEMISM) as a rule is tabu to the members of its clan; in North America this is not so.

(2) *Artificial holiness* is acquired through ascetic exertions, such as fasting, abstinence from sexual life, mortifications, etc. (see ASCETICISM). The ascetic *śrāmyati*, 'exerts himself.' Indian literature abounds in accounts of the superhuman powers acquired by devoted ascetics, making them superior to the gods and arousing their admiring envy. Such a state of artificial holiness is designated in several religions and languages as 'heat' (Skr. *tapas*). At Saa in Malanta in Melanesia, men and objects who have *mana* in themselves are said to be 'hot' (*saka*; Codrington, 191). In the Ewe language (D. Westermann, *Wörterbuch der Ewe-Sprache*) the magic power is called *dzo*, 'heat.'

(3) Holiness and impurity are *contagious*, as we have already seen (e.g. Ex 19¹⁷, Nu 16³⁷, Ezk 44¹⁹ 46^{19a}, Ha 2¹²). Therefore every one in whose house a death has taken place or who has taken part in a funeral must submit himself to special observances before returning to ordinary life. In the Avesta, e.g., the degree of tabu is strictly defined for each relative of the deceased, and it is stated through how many people the contagion is able to penetrate.

(4) Besides this involuntary communication of holiness, a holy man or a body of men has the power of *imposing tabu*. This has been largely used by individuals and by societies for selfish purposes, in order to augment their property and influence (H. Webster, *Primitive Secret Societies*, New York, 1908, p. 95 ff.). In Melanesia, nobody dares to touch fruits on a piece of ground where *solo* (tabu-marks) have been put. Holiness throughout its history has seldom proved a bar to the acquirement of wealth. The ruling class in Polynesia, the *areoi*, have a special reputation for skill in utilizing their tabu. In Madagascar, European settlers have complained of the administrative use of *fady* in order to prevent improvements. But it must be added that the tabu has also often been deliberately applied in cases where the public interest required a prohibition. The Hawaiian government tabued the cattle even as late as 1846, because the diminution of the stock had aroused legitimate anxiety. Gluttony during the great festivals in Tonga and Hawaii made it necessary to tabu pigs, coco-nuts, and other food for several months. Sometimes language indicates the difference between natural or acquired holiness and imposed holiness. On the Banks Islands the former is called *rongo*, the latter *tapu* or *tambu*. In the New Hebrides the former is called *sapuga*, the latter *gogona*, etc.

10. A more important division of holiness is recognized in some primitive languages, which have special names for the good and for the bad varieties of holiness. Thus, in addition to ordinary magical processes, the Central Australian Arunta (Strehlow, *Aranda*) have a bad, noxious 'power,' *arungquiltha*, which is used to injure enemies. Tregear speaks of 'unclean tabu.' Amongst the Huron Indians the *orenda* gradually fell into disuse, giving place to the *otkon*, the bad species of mystery or power. Besides the 'evil eye' there is the wholesome influence of the 'good eye'—e.g. the Iranian *sag-did* (*ERE* iv. 503; cf. S. Seligmann, *Der böse Blick*, Berlin, 1910). This distinction must not be confounded with the differentiation of tabu into holiness and impurity.

11. *Holy and unclean*.—In primitive religion one cannot tell whether tabu is holy or unclean. It simply means, 'Thou shalt not'—interdiction and danger. Later on, the tabu becomes either holy or unclean. Primitive man does not realize this difference. The original meaning of tabu as including both survives in language. The Latin *sacer* (French *sacré*) means 'holy' as well as 'cursed.' 'Holy' and 'impure' are combined in the Greek *ἅγιος*, which is then differentiated etymologically: *ἅγιος* means 'holy,' 'initiated' (in a secondary sense also 'pure,' 'clean,' 'immaculate,' 'permitted'); *ἐναγής* means 'accursed,' 'guilty.' The pig was unclean among the Jews. But, according to Plutarch, the Greeks did not know whether the Jews abhorred it or worshipped it. The mysteries alluded to in Is 65⁴ 66^{3, 17} seem to imply the holiness of the swine (or only its cleanness). In Crete, pigs were holy, according to Athenæus (ix. 18 [p. 375 f.]), and must not be eaten. To both Jews and Cretans the pig was tabu, as in the great temple at Hierapolis. According to Lucian, *de Dea Syria*, 54, pigs were not sacrificed or eaten, the swine was de-

tested by the Syrians, but 'some believed that . . . they are not accursed (*εὐαγέτας*), but holy (*ἁγίους*).'² Among the Minas, south-east of Ajmer, the boar was holy. They identified this belief with the abhorrence of the Muhammadans for the unclean beast, and half adopted Islāmism, but called the boar 'father Adam.' Then Siva-worshipping Brāhmans taught them to identify father Adam with Śiva, and worship the cow as well as the boar (A. C. Lyall, in *Great Religions of the World*, London and New York, 1901, p. 97 f.). How near akin holiness is to impurity is shown by the Talmudic pronouncement that the Holy Scriptures defile the hands (see below, 'Semitic' section, p. 759^a), whereas the Gospels, the books of the *Minim* (heretics), and the books of later authors do not (Tos. *Jadaim*, ii. 13). In the OT, despite the strongly monotheistic differentiation of holiness from impurity, there are still some cases where it cannot be decided whether the tabu-interdict implies holiness or impurity: Lv 19¹⁹, cf. Dt 22⁹⁻¹¹; Lv 19^{23a} (cf. 17⁷). To an outsider, holy things and beings appear rather as something evil and maleficent through the mysterious dread that they inspire. European settlers or travellers often call the whole sacral system of the natives 'devil-devil.' In the Congo the first missionaries translated 'devil' by *Nzambi* ('the great maker,' also 'the one that causes death'). Now *Nzambi* is universally used as the term for 'God.' As we have seen, something of the same ambiguity belongs to the primitive conception of holiness. There is no doubt whatever, at this stage, as to whether a being or a thing inspires awe or not, whether it is 'supernatural' or ordinary, whether it belongs to the proper sphere of religion and mystery or not; but the distinction between good and bad in this 'holiness' is far from being conscious; it is scarcely adumbrated. Higher religion, in its ethical varieties, has a tendency to accentuate the difference between good and bad in a way which sometimes comes very near to obliterating the distinction essential to religion—that between holy and profane.

It is not possible in every case to discover why a tabu becomes holy or unclean. Tabu connected with death and with sexual life becomes unclean. Association with a divinity renders the tabu holy, e.g. the animals, which were kept in the temples and temple-precincts in Egypt, Syria, Greece, etc. In Israel the idea of God was such as to exclude the divinity, i.e. holiness, of animals—a notion highly developed in the religions of Egypt and India. Where the differentiation is complete, the holy and the unclean retain the character of tabu (forbidden), in opposition to the profane (common) and the clean, both of which may be freely used. Originally 'profane' (*noa*, *h*, *κοινός*, *gemein*, 'common') had not a bad meaning at all. The old correlation finds its classical expression in Lv 10¹⁰, Ezk 22²⁶ 44²³: on the one side, holy and unclean; on the other, profane and clean. The important thing in religion is to know and observe the distinctions—

holy unclean
profane clean

Three principal factors have a tendency to modify or reverse that order, namely, the evolution of language, morals, and other practical aims and demands of culture, and the conception of divinity. This process consists in bringing together 'common' and 'unclean' on the one hand, 'clean' and 'holy' on the other hand. The question is whether 'clean' or 'holy' will become the chief word. Where practical and utilitarian purposes prevail, as in the Avesta, 'clean' eclipses 'holy.' Where the idea of the Godhead prevails, as in the OT, 'holy' keeps the foremost place.

(a) The 'common' becomes despised and bad. Language operates in this direction—that which is

much 'used' becomes 'used-worn.' Thus 'profane' has a tendency to approach towards 'unclean.' This is seen in the evolution of the words for 'profane.' The verb *לָקַח*, 'to give out for use,' assumes more and more the sense of 'to profane,' 'to unhallow,' and approaches the meaning 'to defile.' Even an author so deeply versed in sacred and clerical language as Ezekiel sometimes identifies 'profane' with 'defile' (43⁷, cf. v. 8; 23³⁸, cf. v. 39), although, as a rule, 'to profane' is used in connexion with the holy, the Sabbath (20¹³, 16, 24 22²⁶, 28 23³⁸, cf. 44²⁴ etc.), the Temple (7²² 23²⁹ 28¹⁶ [of the sanctuaries of Tyre], etc., but see 5¹¹ 9⁷ 23³⁸), the sacrifice (20³⁹), the holy things (22²⁶), God's holy name (20^{39a}, 36^{20a}, 39⁷, etc., but see 43^{7a}); 'defile' is mostly used of idolatry (5¹¹ 14¹¹ 20⁷, 18 36^{17a}; cf. 20¹³, 16 *לָקַח* of the Sabbath, and 20³⁹ of the holy name, etc.), or of the dead (4^{13c} 39^{14a} 43^{7a}, etc.). Likewise in Ex. and Lev., instead of being opposed to each other, 'profane' and 'unclean' become either occasionally identical or related as indicating a wider circle of objects and a narrower circle within it (e.g. Lv 6¹¹, 16 16¹⁹ 20⁸ 21⁴, Ezk 23³⁸). Something of the same evolution may be traced in *κοινός*, which in LXX and the NT acquires the sense of 'unclean' or 'forbidden' (see below, 'Greek' section); in *gemein* in the secondary meaning of 'vile,' 'mean'; and in 'common' in a bad sense. The sacred fruit in Paradise was 'profaned first by the Serpent, by him first made common and unhallowed' (*Paradise Lost*, ix. 930). But the adjective *h* still retains its indifferent sense in modern Judaism. At the same time, 'unclean' is brought into opposition to 'holy,' which comes (e.g. Lv 6¹¹, cf. v. 18) to be considered as a stronger variety of pure, clean, its one-time contrast.

(b) In this evolution, morals play a part. Morally, 'pure' cannot be separated from 'holy' (Is 1¹⁸). This is true of every language, because in ethics the 'holy' cannot mean the forbidden, but the thing that is commanded (see below, § 14). Not only ethics, but practical considerations of human life and civilization in general, draw 'holy' and 'clean' more closely together and set them in opposition to 'unclean,' as we shall see in the next paragraph. Their correlation approaches the form:

holy clean
profane unclean

But this process cannot be completed without ritualizing religion so as to leave mere rules and forms devoid of mystery and indwelling power, or without a certain secularizing of religion. 'Holy' must lose most of its tabu-character, i.e. its awe-inspiring mystery; and 'pure' or 'clean' becomes the chief word in religion instead of 'holy.' All the dangerous element in religion is included in the unclean, all the valuable element in the clean. At the same time, 'pure' or 'clean' expresses a stronger idea and receives a wider signification, as we shall see. Holy-profane vanishes from religion to a certain extent. All existence is divided into clean and unclean, where the clean includes also the tabus that have advanced to the divine, valuable side of existence. Such a process is positively favoured in Avestan religion by the practical purposes of culture that prevail. The Avestan dualism is a conflict between clean and unclean. This contrast prevails over the religious difference between holy and common. In India the same process was negatively favoured by the dethroning of the gods in favour of the sacrifice, the sacrificers, the ascetics, and the teacher of salvation. The gods were only invisible beings, the priests visible deities (*Sat. Brāhm.* ii. 2. 2. 6 f.), who sustained the world and by whose favour the gods resided in heaven (*Inst. of Viṣṇu*, xix. 20 ff.). The divine lost its strong tabu-character, and was not capable of enhancing holiness. In Semitic religions, and, to a certain

extent, in Roman heathenism, 'holy,' instead of yielding place to 'clean,' became the chief term, because the awe and dread remained in or were introduced into the feeling towards the divine.

(c) Especially in Semitic cult and piety the Godhead appeared as an overwhelming power. This is nowhere felt so strongly as in Mosaism (with its descendants). Notwithstanding the emphasis laid upon morality in the prophets from Moses onwards, 'holy' was never displaced by 'clean' or identified with it. The moral feeling contributed to widen the gulf between holy and unclean. The supernatural and active power in the Godhead worked still more in this direction. Here the divinity became 'holy' in an emphatic sense. Between the holy and the unclean an intermediate realm was left of indifferent and permitted, i.e. 'profane' (or 'common') and 'clean' things, with a tendency in 'common' to decline to 'unclean,' and

holy

in 'clean' to rise towards 'holy': clean common
unclean.

But even in those passages in the OT where this process has advanced furthest, it never identifies 'holy' and 'clean.' 'Holy' is too mysterious, powerful, and divine; God's holiness, being His own essence, not primarily His relation to men (cf. Ezk 36²²), implies danger; there is nothing so much to be feared as the divine. Here not every danger inherent in the tabu has been banished to the unclean. The being not to be treated lightly in OT religion is, above all, Jahweh (Ex 19, Is 5¹⁶ 6⁸, Jer 2³, Ezk 20⁴¹ 38^{16a}, and *passim*). Tabu-holiness has made its most important contribution to the history of religion by finding room for the awe-inspiring, supernatural, and yet active character of God characteristic of Mosaism. A reciprocal action was exercised by the idea of holiness and by the Mosaic-prophetic conception of God.

12. Pure.—In the Avesta, as well as to a great extent in India, the chief concern, as regards tabu, is not to pollute the clean by the unclean. The tabu 'holy' has lost its inherent superhuman awfulness and power. There is no instance of a man being visited with immediate destruction, without interference of man or society, through coming into too close contact with the holy-tabu. The words that come nearest to the idea of personal holiness (Skr. *ritavan*, Avest. *asavan*) do not suggest any tabu or supernaturalness. 'Pure,' not 'holy,' has become the characteristic word of religion. In such Indian languages as have not borrowed the word and the conception from the Arabs, Christian missionaries are at a loss to express 'holy' in its proper sense. The Skr. word *buddha*, *paribuddha* (and its later forms), 'pure,' 'clean,' as a translation of 'holy' in 'Holy Ghost,' the threefold 'Holy, holy, holy' (Is 6³ etc.), transfers the idea from the sphere of Biblical to that of Indian religion. The same term, 'pure,' is used in India for 'saint,' e.g. in the names St. Matthew and St. Paul. Man has more to say, the divine-tabu less. We may compare the Talmudic 'Holy Scriptures defile the hands' with the anxiety of Parsi *mobeds* lest the glance of an infidel should defile their holy Scriptures. The holy-clean must be protected rather than the holy-dreaded. The mysterious awfulness of Jahweh has no analogy in the Avesta, where everything was divided between the Good One and the Evil Terrible One. Even Brāhmanism retained more of the mystery of tabu than Avestism. To both, cattle are tabu-holy, i.e. they must not be killed; they are unclean after death, and thus may not be eaten. In India, only Pariahs eat the dead cow (which is often given as wages for work). Among both peoples the cow is revered.

'Scratching the back of a cow destroys all guilt, and giving her to eat procures exaltation in heaven. In the urine of cows dwells the Ganges, prosperity dwells in the dust (rising from their couch), good fortune in cow-dung, and virtue in saluting them' (*Inst. of Vignu*, xxiii. 60 f. [*SBE* vii. 105 f.]).

But the holy bulls and cows (of Śiva, a secondary connexion), feeding in the temple-precincts or strolling in streets and market-places and allowed to do as they please, are unknown to the Parsi system. This irrational residue of the tabu-holiness has its counterpart in the Avesta, in an enhanced cleanness of cows. Thus tabu, apprehended as danger, becomes either holy or unclean, if it does not keep its undifferentiated character. Tabu, apprehended as valuable power, becomes, as we have seen, e.g., in the OT, 'holy.' But it can also take another direction. The valuable thing or being may get rid of its mysterious danger and become directly clean—not clean in the sense of allowed (*noa*, *hól*), but clean in an accentuated, concentrated sense. This is typical of holy-clean in the *Vendidad*, our second main witness (besides the OT) to the evolution of tabu. We have already mentioned the twofold cause: the strict theological division of all existence into the Good (clean) and the Evil (unclean), and the practical aims—care of cattle and pastures and an ordered life—which inspired the prophet of this religion. Almost the only instance of anything like original tabu-holiness is furnished by the *haoma* (*q.v.*), which, when prepared, i.e. fully sanctified and powerful, cannot be defiled by a corpse (*Vend.* vi. 43). Here the difference comes out between the clean, which must be guarded against pollution, and the *mana*-charged holy, which is affected by nothing.

Beings and things exalted above the ordinary through their cleanness, but devoid of the awe of holiness, are: (1) the cow (*Ys.* xlvi. 6; *Vend.* iii. 2 ff.), the dog extolled above man (*Vend.* xiii.; cf. iv. 40, vi. 1, xv. 45, etc.), the hedgehog, the otter (*Vend.* xiv.), and in a lesser degree other animals (*Vend.* xvii. 9, xviii. 15 ff.); (2) the elements: the earth, fire, water, the purity-holiness of which explains the exposure of corpses to be eaten by animals, a practice which involved a special impurity to the Greek mind (*Soph. Antig.* 1017); (3) plants; (4) the objects belonging to the holy service: the *barsom* (*q.v.*), the bowls, the mortar, and the sacred formula.

All these things must be guarded against pollution. At the same time they possess an intrinsic power to purify and to restore purity, but less effective than that of the *haoma*. The urine of the cow is used, as in India, as a means of purification (*Vend.* xix. 21 ff.). If a cow has eaten of a corpse, she becomes pure of herself after a year (vii. 76 f.), whereas a man in the same case must be put to death without any possibility of purification (vii. 23 f.). As to the dog, the purifying look, the *sag-did* (see DEATH [Parsi]), seems also to be an attribute of the corpse-devouring birds (*Vend.* vii. 29 ff., viii. 16 ff.). Sometimes the eating (viii. 99 ff.), sometimes the look (*ib.* 16), appears to be the means by which these animals lessen the impurity of corpses. Since all animals belong either to Ahura Mazda or to Anra Mainyu, there are many that take part in the fight against the devils; all the animals of Ahura Mazda are clean; but we can still trace something of an original tabu in the extra cleanness and purifying power of some of them. The same clean power resides in the elements. Clothes infected by a dead body are rubbed with earth to be cleansed (*Vend.* vii. 15). The cleansing capacity of fire is universal. A corpse that has been exposed to the light of the sun during one year can work no more harm (vii. 45 f.; cf. v. 13). Water is used against uncleanness everywhere. It has the power of purifying itself when it has rained on a dead body (v. 19). In

India, purification is effected by water, earth, air, sun, etc. (*Inst. of Viṣṇu*, xxii. 88, 91). There also earth has a special cleansing power (*Manu*, v. 136). Hot water mixed with sulphur and gold-dust has the power of revealing guilt (*Vend.* iv. 46, 54), and so has the well-known ordeal by melted metal. The tests by water and by fire occupy an important place among the ordeals prescribed by Indian law ('Quotations from Nārada,' vi. [*SBE* xxxiii. 247 ff.]). The holy formula, which purifies with water and fire (*Vend.* viii. 72, xii. 2), is necessary against destruction (*Vend.* xix. 8 f.; cf. xviii. 8 f.). The position and practical character of the clean-holy in the Avesta are seen perhaps most clearly in a fifth group of things and actions, which work against impurity, the weapon of the devils. Something of the same practical sense is occasionally found in the agricultural Indian lay society:

'Among all modes of purification, purity in (the acquisition of) wealth is declared to be the best; for he is pure who gains wealth with clean hands, not he who purifies himself with earth and water' (*Laws of Manu*, v. 106 [*SBE* xxv. 187]). 'Of all pure things, pure food is pronounced the most excellent.' The learned is also purified by forgiveness of injuries, by liberality, etc. (*Inst. of Viṣṇu*, xxii. 89f.; *Manu*, v. 107). But austerities, the renouncing of the world (*Inst. of Viṣṇu*, xxii. 91), and abstinence (*Manu*, v. 159) belong to a higher state of purity and religion.

In the Avesta the point of view is more consciously conceived and more consistently carried out. A house with priest, cattle, woman, children (*Vend.* iii. 2, iv. 47), the cultivating of corn, grass, fruit-trees, irrigating and draining (*Vend.* iii. 4, 23 ff., 30 ff.), good appetite (iii. 33, iv. 48), the giving of food (xiv. 17) and other gifts (iii. 34 f.), the filling up of the burrows of Anra Mainyu's animals (iii. 22), the building of bridges (xiv. 16), etc., are co-ordinated as purifying means with, e.g., the holy power of the cow and the dog. Likewise the unclean is assimilated to acts injurious to industry and culture.

There is a stock of tabus common to Brāhmanism and Avestism (see, e.g., the *Laws of Manu*, v., and the *Institutes of Viṣṇu*, xxii. ff.); but the difference becomes obvious (a) in that more consistent utilitarian tendency of Avestan purity which, of course, is not carried out, but permits many barbarous tabu-rites, e.g. at child-birth, to remain; (b) in the high appreciation of purity, cleansing, *yaozh-dao*, which is considered already in the *Gāthās* (*Ys.* xlviii. 5) as the greatest thing next to birth (*Vend.* v. 21, x. 18); the law of purity is the foremost word (v. 24 ff.); the devils tremble before the man that smells of purity after death (xix. 33); and (c) in the dualistic systematizing of clean and unclean. Something of the same process occurs in the OT. The gloomy character of the tabu-day gives place to the rest (Ex 20¹⁰, Dt 5¹²⁻¹⁴) and the delight (Neh 8^{9a}) of the Sabbath.

13. Exceptions to tabu-rules are due, in most cases, to practical considerations. The claims of real life prevail to a certain extent over the rule of infection by tabu-holy (Hag 2¹²) or tabu-unclean (Lv 11^{36a}, but see Hag 2¹³). According to *Vend.* v. 3 f., a bird that has eaten of a corpse does not defile the tree on which it perches; v. 6 f., infection of the dead brought by wolf or fox does not spoil the irrigated field; viii. 34, a dried corpse does no harm; vii. 71, a woman may drink pure water although she has brought forth a still-born child. The motive is assigned in *Vend.* v. 4: otherwise the whole of the created world would become polluted, because innumerable creatures die. In the case of the cow becoming clean of herself in one year (*Vend.* vii. 76 f.), we cannot decide whether this is due to her own dynamic purity or is an exception for practical reasons. To the same category belongs the universal rule that the corpse of a clean animal does not defile (cf. Lv 5³ 11¹¹). According to Indian

law, the hand of an artisan, things exposed for sale in a shop, food given to a Brāhman (if not by a Śūdra), or food obtained by begging, which a student holds in his hand, the mouth of a woman in the process of kissing, a bird in pecking fruit, a dog when catching a deer, and flesh of animals killed by a dog, etc., are always pure notwithstanding the logic of tabu-infection (*Manu*, v. 129 ff., *Inst. of Viṣṇu*, xxii. 48 ff.). Carpenters and other workmen are not to be hindered in their work by defilement. To the group of practical exceptions belongs also the rule that impurity does not arise when the whole country is afflicted with a calamity, or in times of great public distress, such as an epidemic or a famine (*Inst. of Viṣṇu*, xxii. 51, 54 f.). In these instances the pedantry of laws of cleanness is temporarily abrogated by the hard necessities of life. Quite different are the exceptions noted in the Avesta which are due to the logic of dualism. The corpse of the *asavan* (holy, pious man) is unclean, because his death means a defeat to life and holiness. On the other hand, the wicked becomes pure after death: his death is an advantage; the infection of a dead body diminishes with the holiness of the man during his life until it disappears in the case of the ungodly (*Vend.* v. 35 ff., xii. 1 ff.). For that reason a dead dog is impure (vi. 1). On the contrary, there is the clerical exception in Brāhmanism of the priest Brāhman being so holy as to remain clean also after death. The indwelling holy power overcomes impurity in different degrees according to its strength. The impurity lasts ten days for a Brāhman; it lasts twelve for a Kṣatriya, fifteen for a Vaiśya, and a month for a Śūdra (*Manu*, v. 83). On several occasions the indwelling power is exempt from any defilement. The taint of impurity does not fall on kings, at least while engaged in the discharge of their duties; on devotees performing a vow; or on a man engaged in a sacrificial ceremony (*Manu*, v. 94; *Inst. of Viṣṇu*, xxii. 48 ff.). When the ceremonies connected with the installation of the monument of a deity or marriage rites have begun, impurity is powerless—it cannot arise (*Inst. of Viṣṇu*, xxii. 53). The explanation of the fact that no impurity attaches to the king—viz. because he incarnates the eight guardian-deities of the world, who cause and remove purity and impurity of mortals (*Manu*, v. 96 f.)—is evidently of a secondary character; the real reason is found in his own power of holiness or in the claims of practical life.

14. Holiness and morals.—In the tabu-interdicts, what we call moral rules and ritual or 'superstitious' commandments are intermingled without any attempt at differentiation. In the Congo the laws belonging to the fetish Mbuzi contain such prescriptions as not to eat newly slaughtered meat, not to steal, not to lie, not to stand upright when stirring the contents of a pot, not to whistle in the twilight, not to drink palm-wine without having a cap on the head (E. Nordenskiöld, pp. 123, 146). Amongst the rules prescribed for a *snātaka*, a young Brāhman who has just completed his studentship, are, e.g., not to carry water and fire at the same time, not to drink out of his joined hands, not to step over a rope to which a calf is tied, always to speak the truth, to conduct himself as an Aryan, to take pleasure in the Veda, never to hurt any being, to restrain his senses, etc. (*Gautama*, ix. [*SBE* ii. 218 ff.]; cf. *Apastamba*, i. 11. 30 [*SBE* ii. 92 ff.]). In ch. 125 of the Egyp. Book of the Dead the departed protests his purity: 'I have not oppressed the feeble one . . . I have not degraded anybody . . . I have not let any one hunger . . . I am not a murderer . . . not an adulterer . . .' The ritual of the Great Purification, *Ō-harai*, in Shinto ceremonial, counts

among 'heavenly sins': to destroy the divisions between the rice-fields, to put sticks in the rice-fields, to flay living animals backwards; and among 'earthly sins': leprosy, incest, snake-bite, killing the cattle of another, sorcery (H. Weipert, 'Das Shintogebet der grossen Reinigung,' in *Mitteil. der deutschen Ges. für Natur- und Völkerkunde Ostasiens*, 1901, Suppl.; E. Satow and K. Florenz, 'Ancient Japanese Rituals,' in *TASJ* vii. ix. xxvii. 1). Similarly, the Law of Holiness in Lv 19 includes fear of mother and father, prohibition of theft, of deceit, of lying, as well as prohibitions against eating anything with the blood or rounding the corners of the head.

The tabu imperative covers a very wide area in primitive and barbarous culture. In higher civilization a process of reduction takes place. At the same time the idea of obligation is deepened. The separation of ethics from ritualistic rules belongs to a higher moral appreciation of holy and unclean, represented in Greece and Rome by thinkers and poets from Heraclitus (frag. 5, in H. Diels, *Fragmente der Vorsokratiker*², Berlin, 1912, i. 78), e.g. Diogenes of Sinope (cleansing water cannot take away a moral fault any more than a grammatical blunder; will an initiated thief have a better lot in Hades than Epaminondas? [Diog. Laert. vi. 2. 42]; Cicero, *de Leg.* ii. 10. 24: 'animi labes nec diuturnitate evanescere nec omnibus ullis elui potest,' etc.). These protests probably referred to the cathartics of the Mysteries (*q.v.*) and of Orphism (*q.v.*). Orphism started as a special, higher 'holiness,' *ἀγνεια*. Primitive tabu-rules on food, clothing, sexual life, etc., were revised and united into an ascetic and pedantic 'orphanic life,' destined to secure a happy life after death. This was the theory of the great Pythagoras also, with whom a higher morality prevailed. In opposing the later purifying Orphic charlatans, and in taking cleanness in a purely moral sense (=righteousness [*Rep.* 364]), Plato enhanced the ascetic tendency of the Apollonian, Orphic, and Pythagorean cathartics (the soul must be delivered from the body even in this life through spiritual occupation, 'philosophy,' and completely after death [*Phædo*, 66 ff.]), and the religious character of ethics as a means of salvation and happiness in the life to come (*Phædo*, 86 ff.; a more positive appreciation of morals prevails in the *Rep.* and other dialogues). The moralization of holiness and cleanness is urged in the OT by Amos and other prophets, and distinctly stated by Christ (Mk 7^{15a}). The general principle of Lv 19, etc., 'Ye shall be holy: for I the Lord your God am holy,' is repeated in 1 P 1¹⁶, but applied to moral behaviour (*ἀναστροφῆς*, v. 16), and the quotation 'holy people' in 1 P 2⁹ has no ritual meaning. The paradoxical claim laid on the whole people to be holy (see above, § 1) receives a new and higher significance in this way, and can be fulfilled without any limiting or clericalizing of life.

In India, Buddha opposed an outward and non-moral conception of purity. At the end of the *Dhammapada*, a set of verses explain what it means to be a true Brāhman:

'A man does not become a Brāhman by his platted hair, by his family, or by birth; in whom there is truth and righteousness, he is blessed, he is a Brāhman. What is the use of platted hair, O fool! what of the raiment of goat-skins? Within thee there is ravening, but the outside thou makest clean.' (*Dhammap.* xxvi. 393 ff. [*SBE* x. 2 pt. i. p. 91]).

According to the *Sutta-Nipāta*, Kassapa explained the sin of eating raw flesh (*āmagandha*) in this way:

'Destroying living beings, killing, cutting, binding, stealing, speaking falsehood, fraud and deception, worthless reading, intercourse with another's wife, this is *āmagandha*, but not the eating of flesh.' 'Neither the flesh of fish, nor fasting, nor nakedness, nor tonsure . . . purify a mortal who has not conquered his doubt' (*Sutta-Nip.* ii. 2. 4 [241], ii. 2. 11 [248], in *SBE* x. 2 pt. ii. p. 89 ff.).

In Buddhist polemics against Brāhmanism the question of purifications always played a part: if water could cleanse from sins, frogs and tortoises, water-snakes and dolphins, would get to heaven and be happy. The title of the Pāli work, the *Visuddhi-magga* of Buddhaghosa, 'The Way of Purity,' has nothing to do with ritualistic purifications (H. C. Warren, *Buddhism in Translations*, Cambridge, Mass. 1900, *passim*; M. Winternitz, *Gesch. der ind. Lit.* II. i. [Leipzig, 1913], p. 164 ff.). The momentous step in the evolution of holiness and purity consists in this, that holiness becomes a personal quality of the deity and of man, instead of being a substance in things as well as in wills. This evolution is favoured by autonomous moral refinement, as in Greece, India, and China, and also by the preponderating conception of the deity as an ethical will, as in Mosaism. The later process has had the greater importance for the internal history of religion. As to man, 'holiness' retained its aspect of something supernatural and divine in the NT, notwithstanding its being moralized and personalized. In its essence, holiness does not depend on man, but is a divine influence. But the making holy of man by God obliges man to strive for perfection. Holy means 'good,' 'perfect' in an ethical sense in so far as religion implies ethics. It is used of God (Jn 17¹¹), His name (Lk 1⁴⁹), the city (Mt 4⁵), and temple (1 Co 3¹⁷) connected with His service; of Christ (Mk 1²⁴); the angels (8³⁸); of the prophets (Lk 1⁷⁰), the men (Mt 27⁵²) and women (1 P 3⁶) of old; of John the Baptist (Mk 6²⁰); and of Christians as God's sacred property and servants (Ro 1⁷, 1 Co 1², 1 P 2⁶), bound, therefore, to purity in life (Eph 1⁴, 1 Co 6¹¹). The language is ritualistic (Ro 12¹ 11¹⁶ [firstfruit, see above, § 7 (c)], Jn 10³ 17¹⁹); the sense is personal and moral, but it is entirely kept under the sway of religious sacredness.

15. In the Church 'holy' never became a merely ethical word, but chiefly suggests divine, supernatural power. The original meaning of *sancire* and *sanctus* in the heathen Roman language recalls *tabu*, 'well defined,' 'particularly marked,' as far as *sancitus*, *sanctus* meant *definitus*, *destinatus*, *determinatus* (G. Link, *De vocis 'sanctus' usu pagano*, Königsberg, 1910, p. 9). It was used of things, places, and men, withdrawn from the common and ordinary (see below, 'Roman' section). In early Christianity all the faithful were called 'saints,' because they had been selected and separated by God from the worldly life and common humanity—which meant also essentially a moral change and a severe moral obligation. But the word *sanctus* was used especially of the departed brethren and of the martyrs, over whose remains altars were erected as centres of divine holy power as well as of pious commemoration. Later on, *sanctus* indicated the religious dignity of the *religiosi*, monks and priests. In the 5th and 6th centuries this honourable title was usually reserved for the bishops, until the word 'saint' finally received the sense it has kept in the Roman Catholic Church—that of one who receives and also deserves the general veneration of the religious community. The recognition of a dead believer as a saint depended upon the verified fact that he had had a festival of his own for a long time past, that his tomb had been held in special honour, etc. (H. Delehaye, 'Sanctus,' in *Analecta Bollandiana*, Brussels, 1909, xxviii. 145 ff.; cf. *Les Origines du culte des martyrs*, do. 1912). When the Church became more scrupulous about the dignity of saint and began to submit the claims to it made by local heroes of piety or of some religious genius to a regular Roman commission, primary importance was, and is still, attributed to miracles performed by the alleged holy person before or after his death.

Here we encounter, in a higher sphere, the same test as is applied by primitive peoples—to learn whether the departed possesses the power of holiness or not (cf. above, § 9 (1) (a)), whether his bones, when touched, or his soul, when invoked in prayer, are capable of healing sick people, revealing guilt, and accomplishing other wonders. The chief question about holiness is not: Did he or she attain to moral perfection? but, in fidelity to the essence and tradition of religion, Was there something divine or supernatural about the man? (cf. P. Chauvin, *Qu'est-ce qu'un saint?* Paris, 1910). We may refer to the important rôle played in the process of canonization of Joan of Arc (introduced in 1869, ended by the decree of Pius X. on 11th April 1909) by certain healing miracles performed by her on nuns who implored her help, even at the end of last century. The underlying thought is that holiness means revelation of divine power. Only religion might recognize that supernatural manifestation, not in cases of auto-suggestion or the like, but in creative genius, high personal idealism, and ready obedience to the mysteries of divine guidance and to vocation. Joan of Arc could well stand that more severe test. See, further, HOLINESS (NT and Christian).

16. Holiness has had its most notable history in Western civilization with its antecedents. There it has become the greatest word in religion, the last word of piety so far, as well as the first. Western observers, who form their conception of religion from Biblical or Islâmic examples of piety, have often been struck by the relative absence of awe in Eastern religions. In the West (using this term in a wide sense, to include Persia; cf. Wassilief-Conrady-Stübe, *Die Erschliessung Chinas*, Leipzig, 1909, § 51) the unweakened sense of the 'holy' has accompanied religion all through its history and has gained strength on the heights of religious experience. But at the same time magical practice and 'superstitious' feelings, which still survive in modified forms in the lower strata of civilization and in highly cultured and delicately organized minds, still draw their nourishment from a primitive conception of the holy.

17. The imperative and unconditioned character of the holy, being anterior to any definite idea of divine commandments (cf. K. T. Preuss, 'Der Ursprung der Religion und Kunst,' in *Globus*, lxxxvi. [1904] 321 ff., 355 ff., 375 ff.), cannot be derived from it. Nor has it originated in precautions for the soul (§ 5), nor in calculations of negative magic (§§ 6 and 7) or of hygiene. To say that the categorical tabu is an initial mistake of humanity (§ 8) gives no explanation, only an appreciation. The time-honoured sociological theory recognizes the momentous importance of society to religion. But, as far as lower culture is concerned, the derivation of the holy institutions and beings from a mysterious apprehension of society seems to be artificial. In the higher culture, holiness and mysticism most consciously put their ideals beyond society. According to the history of religion itself, the conception of the tabu results, as we have seen, in the idea of the supernatural.

LITERATURE.—This is indicated in the article. See also T. Wächter, *Reinheitsvorschriften im griech. Kult*, Giessen, 1910; E. Fehrle, *Die kultische Keuschheit im Altertum*, do. 1910.

NATHAN SÖDERBLOM.

HOLINESS (Greek).—In its ordinary use 'holiness' is a word both of religious and of high ethical significance. But, while it is always a religious word, it has often little or no ethical content. Thus, in primitive religion, holiness is often conceived as *physical*, though doubtless with an implicit sense of something deeper. It is an essentially physical quality inherent in persons or things reckoned divine, or, on the negative side,

it is freedom from bad spirits, which are conceived as physical, and against which physical precautions are taken (W. R. Smith, *Rel. Sem.*², London, 1894, p. 161; J. E. Harrison, *Proleg. to the Study of Gr. Rel.*², Cambridge, 1908, pp. 39, 165, etc.). Sometimes, again, 'holiness' indicates what is merely *formal*, as the relation in which a particular place stands to a divine being, or a restriction upon human freedom to enter within it (W. R. Smith, 118, 150). It would be easy to illustrate these non-ethical conceptions, as well as the tabu customs founded upon them (cf. Söderblom's art. HOLINESS above), from the history of Greek, especially primitive Greek, religion. But in the present article we shall deal only with the higher conception of holiness, meaning thereby, on the one hand, the moral perfection of God, and, on the other, human goodness viewed in relation to God. How and how far did the idea of holiness, as thus defined, enter into Greek religious thought?

1. Greek national religion.—From at least as early as the Homeric age two contrasted types of worship prevailed in Greece. The one was directed to the sunny deities of Olympus, the other to the gloomy chthonian, or under-world, powers (cf. W. M. Ramsay, in *HDB* v. 143). The latter is usually regarded as the earlier of the two, and, though it never became a part of the national religion, was preserved in local cults throughout the historic period (cf. Harrison, p. 11, and *passim*; L. R. Farnell, *CGS*, Oxford, 1896-1909). In spite of serious defects, it contained much of ethical value, which, as we shall see, entered into later Greek religious thought. Meantime our concern is with the religion which centred in the Olympian gods and goddesses. Canonized by Homer and Hesiod, these became the objects of national, or pan-Hellenic, as distinct from merely local, worship.

For our present purpose we may consider this national religion, first in its popular, and then in its literary, aspect.

(1) *Popular religion*.—The Greek religion was one of easy trust in the gods, of simple and serene piety. It was satisfied to acknowledge the blessings of the gods by the payment of traditional observance. Such a religion was prone to become 'the art of giving something in order to get more in return, a species of higgling in the celestial market' (F. B. Jevons, *Introd. to Hist. of Rel.*, London, 1896, p. 224), and this is in fact the account given by Socrates in the *Euthyphro* (Plato, *Euth.* 14 E) of the current conception of holiness (*δσιότης*). Plato may have rated the popular religion too low (cf. F. B. Jevons, *Introd. to The Makers of Hellas*, by E. E. G., London, 1903, p. xxiv). Its sacrifices must often have expressed real gratitude. But it is certainly true that the idea of moral purity, as a matter vitally affecting man's relations to the gods, was foreign to the spirit of Greek religion. That spirit was essentially one with the spirit of Greek art, which derived its inspiration not from the supernatural, but from the visible, world. Hence the Greek gods were but magnified men, superior, as G. L. Dickinson points out, in external gifts such as strength, beauty, and immortality, but not in spiritual or even moral attributes. This being so, the average Greek did not trouble about his spiritual relation to the gods. 'To the Puritan, the inward relation of the soul to God is everything; to the average Greek, one may say broadly, it was nothing' (Dickinson, *The Greek View of Life*, London, 1896, p. 18). Greek ethics no less than Greek religion was dominated by the artistic spirit. And hence human goodness meant to the Greek, not indeed a relation to the gods, but an inward harmony. 'The good man was the man who was beautiful—beautiful in Soul' (*ib.* 134).

(2) *Literary ideals*.—Here we shall consider

chiefly the moral aspect in which the gods are presented to us in Greek literature. In Homer and Hesiod, from whom popular religion drew its chief inspiration, we can hardly be said to find any idea of divine holiness. It is true that Homer often presents the gods, especially Zeus, in a noble and even sublime moral aspect. He and Hesiod habitually regard them as the champions of Justice, whom the latter even describes as the daughter of Zeus (*Opp.* 254). Yet their conduct, as reflected in the myths, is often an outrage upon morality. And the reason is that moral perfection was not felt or seen to be an essential part of the divine nature. 'Never,' says Nägelsbach, speaking of Homer, 'is an epithet applied to the Godhead, indicating a consciousness similar to that with which the Bible speaks of the holiness of the true God' (*Homer. Theologie*², Nüremberg, 1861, p. 31). But as time goes on we meet with deeper conceptions of the divine nature. Not only is polytheism gradually purged of its grosser elements, not only is there an approach to monotheism in the more assured supremacy of Zeus over the other gods (J. Adam, *Relig. Teachers of Greece*, Edinburgh, 1908, p. 83; J. P. Mahaffy, *Social Life in Greece*, London, 1875, p. 94), but Zeus is himself regarded in a more spiritual aspect. This is particularly true of Æschylus and Sophocles. In Æschylus 'we find an ideal of divine righteousness which is strikingly parallel to that of Hebrew prophecy' (L. Campbell, *Relig. in Gr. Lit.*, London, 1898, p. 380). Sophocles, on the other hand, comes nearer the Christian standpoint in the more gracious aspect under which he views the divine justice. 'Zeus is no longer solely the awful dispenser of doom, but "he hath Mercy for the partner of his throne"' (A. M. Adam, in *Early Ideals of Righteousness*, Edinburgh, 1910; Soph. *Æd. Col.* 1298; cf. *Phil.* 196). The idea of divine purity, however, was especially associated with Apollo (L. R. Farnell, in *HDB* v. 145). And the growing conception of the divine nature is measured by the purity which Apollo demanded of his worshippers. At first it was freedom from homicidal guilt, and such as could be attained by ritual; later it was viewed as inward, and as extending to all the relations of life (*ib.* 145, 147; E. E. G., *Makers of Hellas*, p. 335 ff.; cf. esp. the story of Glaucus, in Herod. vi. 86).

2. Mystical conceptions of holiness.—From the ideas of holiness proper to the national religion we pass to others, different in kind, and likewise more profound, which flourished during the period of its decadence. Before considering them, however, in detail, we have to ask how the phase of thought from which they sprang entered as a powerful, though not, as we shall see, a wholly new, factor into the religious life of Greece.

In the 6th cent. B.C. the Greek colonies of Asia Minor were profoundly stirred by a new spirit of religious mysticism, which probably came to them from the Semitic peoples (cf. W. R. Smith, 358), and also by a new spirit of philosophic inquiry. These influences were widely diffused by various teachers, and by the end of the 5th cent. had revolutionized the religious thought of Greece. It was, says Campbell, 'one of those epochs in the history of our race which mark a wide-spread access of spiritual vitality' (p. 127). Greek philosophy was undermining traditional belief in the more thoughtful minds. And side by side with the intellectual awakening there was a 'deepening sense of guilt requiring atonement, of pollution crying for purgation' (*ib.* 128), which many sought to satisfy, partly by an ascetic discipline, and partly by mystical rites, including a sacramental meal, which was regarded as an act of union with the divine. Such, as far as we need describe it here, was the character of the Orphic movement,

which powerfully affected Greek religious life from the 6th cent. onwards. Although it probably owed much to foreign influence—including its chief mystery, the sacramental feast—yet Orphism appealed to a religious instinct already potent in the old chthonian religion, previously mentioned, namely, to its profound sense of evil, seen in the conception of the Erinyes (*q.v.*; cf. Harrison, 6, 29, 213), and in rites of purification (*ib.* 24-29, 162). It should be added that philosophy and mysticism were to a large extent but two aspects of a single movement. Orphism had its speculative side, while philosophers like Pythagoras and, at a later time, Plato were steeped in mysticism. There can be no doubt that speculation and mysticism had much to do with the growing spirituality of the national religion (cf. *HDB* v. 147), but they were both foreign to its spirit. We have now to examine conceptions of holiness which were essentially mystical, though they were to some extent reflected in Greek philosophy.

In doing this we are directly and chiefly concerned with the human aspect of holiness. It is true that Greek philosophy sometimes lays stress on the goodness of God. Thus we find in Plato (*Rep.* ii. 379 A) that the fundamental duty prescribed for teachers of the young is to represent God as He really is, and that the first article of their teaching must be that God is good. But there is nothing in such teaching that might not have been applied to the Zeus of the national religion. It is true also that a deepened conception of the divine nature is involved in Orphism; but as this, like all mystical religion, is primarily concerned with inner experience, we shall discuss it rather in connexion with the human aspect of holiness.

(1) *Holiness as likeness to God.*—Humanly regarded, holiness is more than goodness. It always involves a relation to God. But the relation, and with it the *nuance* of the idea of holiness, varies. Perhaps its most familiar implicate is that of likeness to God. The conception became prominent in Greek religious thought chiefly through the teaching of Pythagoras and of Plato. Probably Pythagoras owed it to the influence of the mysteries, as it is closely related to the essential kinship of the human and divine natures, which is a cardinal doctrine of Orphism. 'The Pythagorean ethical doctrine . . . has a thoroughly religious character: to follow God and to become like Him is its highest principle' (Zeller, *Pre-Socratic Phil.*, London, 1881, i. 491; cf. also E. E. G., 335, W. H. S. Jones, *Greek Morality in relation to Institutions*, London, 1906, p. 7, and authorities cited by these two writers). The same doctrine, which is hinted at by Socrates, occupies a prominent position in the teaching of Plato, whose 'conception of the ethical end . . . is "assimilation to God"—*ὁμοιωσις τῷ θεῷ*' (J. Adam, 401; cf. also p. 18, and Jones, 155; for Plato, cf. *Theæt.* 176 B, *Laws*, 716 C, *Tim.* 29-30). We cannot here attempt to trace fully the influence of this idea in Greek literature, but we may add that it is reflected in the cardinal doctrine of the Stoics, that man should live according to Nature—which, in their view, was only another name of God.

(2) *Holiness as communion with God.*—But, again, the relation to God implied in holiness is often thought of as communion. This aspect of holiness is represented in the mystic union with his god which the Orphic regarded as the goal and crown of the spiritual life. The god in question was Dionysos Zagreus, who was born again after his dismemberment by the Titans. And it is significant that Dionysos, though admitted to the Olympic pantheon in his character as a wine-god—an aspect foreign to Orphism—belonged essentially, as he does in this his Orphic aspect, to the class of

chthonian powers. Like the worshipper in that old religion, the Orphic sought deliverance from evil, but his conception of evil was more ethical. And, while to the former purity meant freedom from divine anger, to the latter it meant union with the divine life. Holiness in this high Orphic sense is *δαιμόνης*. The words *ἅγιος* and *ιερός* also refer to holiness, the holiness that comes of consecration—in the former case, to the powers of the lower world, in the latter, to those of Olympus. But in both the consecration is thought of chiefly in its negative aspect, as prohibition or tabu; it is the devotion to unseen powers, in which the idea of the blessing readily passes into that of the curse. On the other hand, *δαίμων* and *δαιμόνης* are words of positive content. Their prevailing sense is that of freedom, which to the Orphic meant freedom from the bonds of the flesh, or moral purity (Harrison, 57 ff., 505 f.). 'Consecration (*δαιμόνης*), perfect purity issuing in divinity, is . . . the keynote of Orphic faith, the goal of Orphic ritual' (*ib.* 478).

We have been dealing with what may be called the mystical aspect of holiness. But in this sense especially holiness may be said to involve the element of love, which is itself an aspect of goodness. It is just here, however, that we see the limitations of the Greek idea of holiness. Even the Orphic, though steeped in the mysticism of love, did not perceive that holiness and love are really inseparable ideas. Accordingly, in actual religion he turned to Dionysos, in mystical dogma to Eros, or Love. Eros is to the Orphic the Creator of all things; especially he is thought of as the source of life, and of life's ecstasy (cf. Harrison, ch. xii.). But he is not a god of holiness; he is a poetical as much as a religious conception. Yet the Orphic did unconsciously associate holiness with love, since he showed that the pathway to both lay through a mystical union with the divine.

Orphic views had a deep influence on Greek literature. Of this, so far as concerns our subject, two illustrations may be given:

(a) *Euripides*.—Euripides is certainly not to be described as an exponent of Orphism. On the other hand, the *Bacchæ*, whatever may be its central motive, is full of Orphic mysticism.

'No other ancient poem shows so rapturous a feeling of the kinship between man and nature. The very hills are "thrilled with ecstasy" in sympathy with the frenzied votaries of the god (*Bacch.* 726). We feel that Dionysus has become a power pulsating throughout the whole of nature, both inorganic and organic, making the universe into a living, breathing whole; and we are stirred with a new sense of unification with the mystery that surrounds us' (J. Adam, 317).

Again, we have the Orphic longing for spiritual freedom, seen in lines like the following:

'Happy he, on the weary sea,
Who hath fled the tempest and won the haven.
Happy whoso hath risen, free,
Above his striving!'

(*Bacch.* 901 ff., Murray's tr.).

Finally, Holiness is personified in the chorus beginning '*Ὅσα πάντα θεῶν*' (*Bacch.* 370). It will be seen that she is addressed by her Orphic name, and J. E. Harrison refers to her as 'Hosia, the real Heavenly Justice, she who is Right and Sanctity and Freedom and Purity all in one' (*op. cit.* p. 507). Nor is her aspect less lofty in Murray's exquisite free rendering of the opening lines of the chorus:

'Thou Immaculate on high;
Thou Recording Purity;
Thou that stoopest, Golden Wing,
Earthward, manward, pitying,
Hearst thou this angry King?'

That an idea of holiness as high as it is mystical is reflected in the *Bacchæ* may be safely gathered from these citations. At the same time, it is important to remember that what we have before us is not a monotheistic, still less a Christian, conception of divine Holiness. The ground note of religious feeling in the *Bacchæ*, here as elsewhere,

is pantheistic. Holiness is, indeed, personified by the poet, and, so regarded, is one among many divine beings. But in its religious and ethical significance it is simply an aspect, profoundly realized, of the divine running through the whole of Nature.

(b) *Plato*.—But the Orphic view of holiness is most fully reflected in Plato, although to some extent modified, chiefly by being rationalized. We have seen that Plato described the ethical end as assimilation to God. But he also taught that perfection consists in communion with or participation in the divine, of which, indeed, as J. Adam has pointed out (p. 436), 'the theory of likeness is only a kind of explanatory gloss' (cf. Plato, *Parm.* 132 D). It is in the *Phædo* that the theory of participation in the divine nature (*κοινωνία, μέθεξις*, etc.) is most fully developed. In the *Symposium*, on the other hand, Plato describes human perfection under the imagery of love. It is the soul's marriage with her ideal, or it is the beatific vision of the realities of an eternal world. It must, indeed, be observed that in Plato the soul does not enter into direct relation with the Supreme Being, 'the Good' (cf. esp. *Rep.* vi. 508 E, 509 B, with *Tim.* 28 C), but only with the Ideas, to which, however, he also attributes a real transcendental existence (*Rep.* v. 476 A ff., *Tim.* 57 D ff.; and Aristotle's account of Plato in *Met.* A 6, 987^a 29–987^b 10). Again, the relation is predominantly intellectual. Even the love described in the *Symposium* is primarily an *amor intellectualis*. But, on the other hand, the Ideas 'are in very truth the Platonic equivalent of Gods' (J. Adam, 431); while to Plato true knowledge, that which grasps the real and abiding, and which is man's highest good, is an act, primarily, indeed, of the intellect, yet affecting also every part of the soul. Lastly, Plato marks an advance on Orphism in that it is one and the same divine being whose perfection the soul shares, and after which its love aspires.

In Orphism and in Platonic speculation we reach the highest Greek conception of holiness. It does not lie within the scope of this article to discuss its obvious limitations. It must suffice to say that the loftier Christian conception depends upon a nobler and more satisfying conception of God, as a supreme Father, who enters into direct personal relations with His children, and whose goodness is at once perfect holiness and perfect love.

LITERATURE.—This is sufficiently indicated in the article.

I. F. BURNS.

HOLINESS (NT and Christian).—I. *NEW TESTAMENT DOCTRINE*.—The NT continues and completes the most spiritual teaching of the OT prophets and psalmists with respect to holiness (cf. 'Semitic' art.). The background to Christian doctrine, however, is still priestly and legalistic, and many instances of the ceremonial conception of holiness appear in the NT writings. Inanimate things or places, such as Jerusalem, the Temple, the inner sanctuary, the Scriptures, the Mount of Transfiguration, are spoken of as 'holy' by virtue of their special association with God. Indeed, the whole NT terminology on the subject is directly borrowed from ceremonial sources, in respect of altars, sprinkling, oblations, putting away sin, and the like. But this ritual phraseology is now given an inward spiritual signification, its former use having been sanctioned only 'until a time of reformation' (He 9^a 10). Christians themselves must now be veritable temples, priests, vessels, and altar gifts, sanctified for the offering of purely spiritual sacrifices (Ro 12¹, 1 Co 3¹⁶, 1 P 2⁵, 2 Ti 2²¹). Thus the emphasis in the conception of holiness becomes increasingly ethical, having advanced from the outward to the inward, from the

negative to the positive, from the merely ceremonial act to the moral and spiritual motive.

An interesting illustration of the passing of the word *ἁγιασμός* from its ceremonial to its ethical use is seen in 1 Co 7¹⁴, where the unbelieving husband is spoken of as being 'sanctified' in the believing wife. 'Paul wishes to prove that the holiness of a Christian transmits itself forthwith to those who are closely allied to him' (J. Weiss, *Der erste Korintherbrief*⁹, Göttingen, 1910, p. 182; see also Ro 11¹⁶, 1 Ti 4^{4, 5}). For a study of the Greek terms used in the NT to designate holiness and kindred ideas, see *HDB*, s.v. 'Holiness' and 'Sanctification'; for the extension of the conception of holiness to things and places, see artt. CONSECRATION and HOLINESS (General and Primitive); and for a discussion of ritual purification as a means of holiness, see L. R. Farnell, *The Evolution of Religion*, London, 1905, pp. 152-162.

Partly, perhaps, because of these ritual associations, Jesus makes very little use of the technical vocabulary of holiness. He prefers the prophetic form of expression, 'Be ye perfect, as your Father in heaven is perfect' (Mt 5⁴⁸; cf. Dt 18¹³), to the more priestly formula, 'Be ye holy, for I am holy' (Lv 11⁴⁴).

Jesus avoided almost entirely the usual OT designation of God as the 'Holy One' of Israel, except in the phrase 'Holy Spirit.' The reason appears to be that Jesus regarded the Levitical "holiness"—which many of His countrymen thought to be real holiness—as negative and temporary. True "holiness" is to be applied to spiritual things, and is to be positive, not negative. It is to consist in imitating the Holy One, not in washings, nor in abstaining from meats, but in being, as He is, "perfect"—that is, perfectly good in will and deed, benevolent and beneficent to all' (E. A. Abbott, *The Son of Man*, Cambridge, 1910, p. 582 f.; see also C. G. Montefiore, *The Synoptic Gospels*, London, 1909, ii. 522-527).

It is, then, in moral likeness to God that man's perfection or holiness consists. The NT has no hesitation in applying the same term to both God and man, and in bidding us be 'holy as he is holy.' God is holy, because, as the absolute moral Reality of the world, separate from all evil and infinite in every excellence, He is pledged by His own nature to secure a perfect and loving righteousness everywhere, even at the cost of redemption. Man is holy when he is brought by grace into that relationship to God by which the Divine righteousness may be honoured and conserved. The progressive ethicizing of this idea constitutes the Biblical revelation, and Christ's advance on the OT teaching in this respect consists in His own unique conception and manifestation of God. God is the 'Holy Father,' a Being who freely loves and saves His guilty children, not only without any sacrifice of His Divine sanctity, but even by its supreme exercise. This combination of holiness and love in God constitutes His excelling glory. The holiness humbles us and forbids an unethical presuming on His kindness. The Fatherhood attracts us and forbids a despairing dread of His commandments. And the acknowledging of this essential glory of the Father, by a reverent hallowing of His name in life and service, must ever be bound up with the coming of His kingdom and the doing of His will on earth as it is done in heaven.

This characteristic NT association of the holiness of God with the Divine Fatherhood recurs in an important passage, Heb. 12⁷⁻¹⁰, where God is spoken of, in the language of the home, as a Father chastening His children 'that they may be partakers of His holiness.' Here, too, we have a breaking away from the more negative OT view of the Divine holiness. God disciplines us through suffering, that we may enter into that filial relationship of obedient and trustful love (*pietas*) in which true holiness consists. On the meaning of God's holiness and its relation to holiness in man, see *PRE*³, s.v. 'Heiligkeit Gottes im AT'; Sanday-Headlam on Ro 17, and Hort on 1 P 1¹⁵.

Man's holiness thus consists in a perfect moral sonship, the consecration of all his powers and opportunities to the worship of God, and the realization of His gracious purposes in history. Of such a perfect holiness Jesus Christ Himself is the unique example. For this very purpose the Holy Father consecrated Him and sent Him into the world, so that He was holy from the beginning (Lk 1³⁵, Jn 10³⁶). To the same purpose Jesus steadfastly consecrated Himself to the end (Jn 17¹⁹

18³⁷). Through an eternal Spirit He offered Himself without blemish to God (He 9¹⁴). The result was something more than mere sinlessness. It was the full presentation, in the first instance to God Himself, of the moral glory of the Father's own holiness, through the pouring of the Spirit without measure upon Him, and His own perfect obedience to the Father's will—a holiness manifesting itself not in withdrawal from the world, but in a life of perfect love and action among men, and finding its inevitable consummation and ratification in the power of the Resurrection (Ro 1⁴). It is in keeping with all this that Christ is referred to throughout the NT as pre-eminently 'holy,' by the announcing angel (Lk 1³⁵), the disciples (Jn 6⁶⁹), and the believing Church (Ac 2²⁷, He 7²⁶, 1 Jn 2²⁰, Rev 3⁷).

The supreme test and manifestation of this perfect sanctity of Christ was the death upon the cross. By this crowning act our Lord honoured, secured, and satisfied the Divine holiness as well as perfected His own, on a world scale and at history's moral centre, in a supreme judgment upon and victory over sin, through the sacrifice of an active and complete obedience. By this perfect purification of human guilt (He 1³) Christ both fulfilled and abolished the whole sacrificial system (9²⁸ 10²⁶), and became unto men 'sanctification' (1 Co 1³⁰), the objective ground or warrant of the believer's new standing of holiness before God. Through the one offering of His body on the cross He 'perfected for ever them that are being sanctified' (*ἁγιαζομένων*), i.e. He effected in principle the complete sanctification of His followers in the eternal future, rendering them independent of every other sacrifice (He 10¹⁴).

Further, the holiness of Christ, which conditions that of the Christian, also guarantees it. 'Both he that sanctifieth and they that are sanctified are all of one' (He 2¹¹). Being separated unto God in baptism, believers find themselves washed, sanctified, justified in the name of the Lord Jesus (1 Co 6¹¹), and, entering into all the privileges of the old covenant on a new plane, they know themselves to be 'an elect race, a royal priesthood, a holy nation, a people for God's own possession' (1 P 2⁹, Dn 7¹⁸). Such believers are already called 'saints,' not because of their attainments, but because of their new standing as regenerated or 'sanctified in Christ Jesus' (1 Co 1²), who is the encompassing sphere, as it were, in which the whole process is begun, continued, and ended. Having Him as *ἀγιασμός*, they themselves are *ἅγιοι*, earmarked, destined, and set apart from everything profane, as belonging to God and His kingdom, although as yet they may be no more than babes in Christ, or even carnal.

It still remains, however, that this preliminary implicit hallowing of the inmost personality shall become explicit in a holy character and manifest itself in every sphere of daily conduct (cf. Hort on 1 P 1¹⁵). The Christian must work out in practice what he already is in principle, since deliverance from the guilt of sin through justification involves deliverance from its power through sanctification. There is thus a growth *in* holiness rather than into it (1 Ti 2¹⁶). The NT is explicit in emphasizing the ethical nature of true holiness, its contrast to all licence and uncleanness (Ro 6¹⁹⁻²², 1 Th 4³⁻⁷). Christians must consecrate body as well as spirit; and all sins against the body, which is God's temple, are tantamount to sacrilege (Ro 12¹, 1 Co 6¹⁸⁻²⁰). Stress is also laid on the importance of our co-operating effort and initiative in sanctification (2 Co 7¹, Ja 4⁸, 1 P 1²², 1 Jn 3³). Yet the whole process is spoken of as wrought by the Holy Spirit in our hearts (Ro 15¹⁶, 1 Co 12¹¹, Eph 3²⁰) in conjunction with our faith (Ac 15⁹ 26¹⁸, Gal 3¹⁴).

Indeed, the two agencies are regarded as complementary and inseparable (Eph 1^{13, 14}, Ph 2^{12, 13}, 2 Th 2¹³). To the extent that we consecrate, the Spirit sanctifies. Nor is NT holiness a merely negative or self-regarding sinlessness, an ascetic purity or abstention from known sin. It implies the constant activity and positive exercise of all goodness in the realm of daily life. As such, Christian holiness is necessarily a social grace, and it ripens many gifts and adjusts many idiosyncrasies of character. So impossible is the perfecting of holiness in isolation that the NT never contemplates a single 'saint,' but speaks constantly of 'the saints' or a 'holy people.' The root of Christian holiness is faith, and its flower is love; and the sphere for the cultivation of this holy love in Christ is His Body, the society of the Christian Church (1 Co 12¹²⁻²⁷, Eph 1^{23, 4¹⁰}, Col 2¹⁹).

The final goal of the Christian life is complete holiness, the deliverance of the soul from the guilt, power, and even presence, not of sin only but of sins also, through its perfecting in holy love (1 Jn 1^{9, 2¹⁻⁶, 3⁴⁻⁹}). It is the teaching of John that this follows inevitably from the believer's dwelling in Him who is the negation of all sin and its destroyer, and who came not only to impute but also to impart righteousness, even as He is righteous. Where the Divine 'seed' of the Holy Spirit abides in the child of God, the kinship to Satan is necessarily annulled, and the Christian need not, must not, does not, and cannot sin, since it is impossible that Christ and sin should dwell together in the same breast. Whether John is here speaking of an actual attained experience (G. G. Findlay, *Fellowship in the Life Eternal*, London, 1909, pp. 114, 253-269), or is merely affirming the moral implications of an ideal faith (P. T. Forsyth, *Christian Perfection*², London, 1910, pp. 1-49), is a matter of dispute. Strictly speaking, only the eternal Son was fully perfect. Even in regenerate Christians, allowance has still to be made for occasional lapsing into transgression through ignorance, surprise, or hostile circumstance (2¹). Such sin, however, does not *reign*, as it does in the unregenerate. It is not unto death, and can plead the Advocate with the Father. The Christian perfection taught in the NT is not faultlessness but blamelessness and loyalty, the staying of the heart in the obedience and love of God through faith, however the feet may be betrayed by the deceitfulness of sin into hidden snares. It is (a) *relative* to our creaturely experience and earthly limitations; (b) *derived* from God's grace in Christ, not based on any merits of our own; (c) *progressive*, or capable of indefinite improvement; (d) *alienable* or forfeitable, not guaranteed to perpetuity, but (e) *conditional* on faith, our striving against sin, and steadfast abiding in the love of God. It will also be characterized by humility, contrition, and self-disparagement. Such earthly or relative perfection, which *consists* in faith, is necessarily different from that full and final perfecting which *crowns* our faith, and which awaits the consummation of Christ's atoning work (Ro 8^{29, 30}, 2 Co 3¹⁸, Ph 1⁶, Col 1^{22, 23}, 1 Jn 3⁹).

We may now attempt to gather into a few propositions the teaching of the NT on this subject, without losing sight of the warning reminder of Lord Morley, that holiness is the 'deepest of all the words that defy definition' (*Voltaire*³, London, 1878, p. 175).—(1) Holiness is the sovereignly moral or self-preserving element in perfect love—that element in it which, to secure the ends of righteousness, exerts a reaction of wrath or self-defence against all that would impair its purity and intensity. 'It is the holy that makes love divine, makes it racial, eternal, sure, changeless, and invincible' (P. T. Forsyth, *The Principle of Authority*, London,

1912, p. 211).—(2) Christian holiness results from the imparting to man of God's own holiness, as it is mediated through Christ in a new creation.—(3) In one aspect, it is the fruit of sanctifying grace in us, the effect of the Holy Spirit working in our faith, to separate us from sin, perfect us in goodness, and enable us to do the will of God.—(4) In another aspect, it is the result of our own moral effort and aspiration of faith—an effort engaging the entire personality, body as well as soul, in the life of righteousness and love.—(5) Such holiness implies the existence of the Christian community, as the necessary soil and atmosphere in which it lives, and (6) it is a continuous and progressive spiritual discipline.—(7) Finally, while the NT distinguishes holiness as something larger than morality,¹ it yet knows of no divorce between holiness and virtue. 'Holiness is virtue rooted in the religious relation. . . . The distinction between holiness and virtue is qualitative, not quantitative' (W. R. Inge, *Faith and its Psychology*, London, 1909, p. 240).

II. *HISTORICAL DEVELOPMENT*.—The materials presented in the NT were very variously utilized in the history of the Church. Now one aspect, and now another, of the full-orbed Christian doctrine was singled out and emphasized, and the conception of holiness changed with every changing view of the nature of the evil to be shunned and the goal of ideal perfection to be attained.

1. Gnosticism introduced into the Christianity of the early Church a crude Oriental dualism and a fantastic Greek system of speculation, which tended to substitute a metaphysical or semi-physical cosmology of redemption, with an allegorizing of history, for the NT gospel of the Incarnation. Evil was identified with matter, and salvation consisted in the exaltation of the soul from unhallowed immersion in the material world of sense to its true spiritual home in the Divine *pleroma*, by means of ascetic purifications, mystical rites, and the illumination of a special *gnosis* granted to the pneumatic or truly spiritual Christian, and superior to the historic *pistis* which sufficed for the ordinary believer, or merely psychic Christian. Insight was elevated above faith. The result was a kind of *esoteric holiness*, more theosophic and speculative than ethical and spiritual.

2. On the other hand, Montanism, or *prophetic holiness*, was a protest against the rapid 'secularization' of the Church as it spread through the Roman Empire in the 2nd century. It sought, by a more ascetic discipline and the cultivation of the spirit of ecstatic 'prophecy' among the laity, to distinguish the congregation of the 'holy' not only from the world outside the Church, but also from the worldly elements within it, in view of the expected advent of the Lord in Phrygia. Montanism went beyond the NT conception of holiness in affirming a new dispensation of the Spirit. 'The Paraclete has revealed greater things through Montanus than Christ revealed through the Gospel' (pseudo-Tertullian, 52).² Yet it was a serious attempt to realize the ideal of the 'holy Church' by insisting that a pristine purity of communion must necessarily accompany established purity of doctrine. Montanism was the first of many efforts made within Christianity to restrict the membership of the Church to those actually holy or spiritually elect. Negatively, it forced the Church

¹ 'No holy person is not good, but not every good person is holy. The distinguishing feature of holiness would seem to reside in something which lies beyond goodness, or at any rate is an addition to it. . . . There lies a touch of excess in holiness. It is not a matter of rule and policy . . . of more or less, but of nothing and all. Holiness needs fervour' (G. G. Montefiore, *Truth in Religion*, London, 1906, pp. 89, 95). 'For holiness is wanted a harmony of will, a perfect self-devotion, death to self and absolute submission' (Amiel's *Journal*, Eng. tr., London, 1892, p. 207).

² Migne, *PL* ii. 91.

gradually to take up the position, especially after the Novatian and Donatist controversies of the 3rd and 4th centuries, that its holiness consists not necessarily in the spiritual purity of all its members, but in the official and inalienable connexion of its orders with the Holy Spirit, the true doctrine it teaches, the eminent saints it can produce—in fact, in its possession of the means of all grace and holiness in the deposit of faith and in the sacraments. 'The Church . . . was legitimised by the possession of the apostolic tradition instead of by the realising of that tradition in heart and life' (A. Harnack, *History of Dogma*², Eng. tr., London, 1894-99, ii. 83).

3. The recognition thus openly given to higher and lower planes of sanctity within the Church led, first of all, to a duality of practice, still under ordinary social conditions, reflected in a theory of the 'Two Lives' (cf. C. Bigg, *Christian Platonists of Alexandria*, Oxford, 1886, p. 83 ff.; E. Hatch, *Influence of Greek Ideas*, London, 1890, p. 164 ff.), and finally to Monasticism as a fresh type of *ascetic holiness*. Early monasticism may be regarded as a continuation of the aims of Montanistic 'Puritanism,' without its anti-ecclesiastical elements, and welcomed by the Church itself. Despairing of making the majority even of its own members holy, the Church sought to counteract the prevailing laxity by approving, side by side with ordinary Christianity and in loose attachment even to the sacraments, the pursuit of holiness by particularly religious persons, released from ordinary social obligations. Thus, whereas Jesus bade *all* His followers be 'perfect,' and the NT ἀγιοι and τέλειοι were sanctified or mature Christians in the ordinary walks of life; and whereas even Clement regarded the ideal 'Gnostic' as one who took his place in the daily round, 'acting the drama of life which God has given him to play' (*Strom.* vii. 11), monasticism confined 'the religious' to a professional class, who should make the cultivation of holiness a distinct calling by fleeing from the world. Based thus on a religious egoism and an essentially dualistic view of the world, both of them alien to Christ's spirit, monasticism cultivated a negative or retired type of holiness. It attached a unique sanctity, not to inner renunciation or detachment from the world, with an exemplary practice of the ordinary Christian virtues, but to an external abnegation of all property and marriage, and to the practice of artificially selected virtues such as poverty, chastity, and ecclesiastical obedience. In monasticism, too, the holy man tended to identify himself with the sufferings and death of Christ rather than with His glorious risen life and quickening Spirit. Holiness was to be attained and peace won by refinements of mortification, a severe penitence, and the rigours of self-disciplinary effort, rather than by the free gift of God's sanctifying Spirit acting on the soul through faith.

¹The Ascetic theory has always rested in the contest between the human spirit and the flesh: too often forgetting that the Divine Spirit is not merely the umpire and witness, but the Almighty Agent also in the destruction of sin' (W. B. Pope, *Compendium of Christian Theology*², London, 1880, iii. 68).

There was, no doubt, gain as well as loss in the ideals of monasticism. It kept the light of religion burning in dark ages, and rebuked all diletante forms of holiness by the example of a heroic and thoroughgoing renunciation. But its defect was that it made asceticism an end in itself rather than a means, withdrew the practice of holiness from its proper sphere in the ordinary life of the community, depressed and falsified the standard of holiness to be attained by the average man, and left to itself the world which it should have leavened. The degree of individualism marking monasticism varied in different countries and at different epochs, often becoming, especially in the

West, social and co-operative within the narrow circle of the monastery, as well as devoted to works of general utility. But still its holiness remained at heart a 'sublime individualism,' in marked contrast to the ideals of the NT.

4. A new conception emerged in Pelagianism, which may perhaps be described as a kind of *natural holiness* or Christian Stoicism. Pelagius claimed that, by means of the freedom of the will and the help afforded by God's grace in revelation, man is capable of perfect conformity to the will of God, who prescribes nothing impossible. In so far as man is *not* capable of conforming to the Divine ideal, he cannot be charged with sin for failing to do so, since there is no sin prior to the actual choice of evil by the free will.

¹Quaerendum est, utrumne debeat homo sine peccato esse. Procul dubio debet. Si debet, potest; si non potest, ergo nec debet; et si non debet homo esse sine peccato, debet ergo cum peccato esse; et jam peccatum non erit, si illud debere constiterit. Aut si hoc etiam dici absurdum est, confiteri necesse est debere hominem sine peccato esse, et constat eum non aliud debere quam potest' (Pelag. apud Aug. *de Perf. Just.* 3).

This essentially rationalistic system of belief in the inherent capacity of man to achieve all the righteousness required of him appears in history in various forms, such as Socinianism and modern Naturalism. But it belittles the Divine demand, lays stress on sympathetic goodness rather than on the holiness that is mediated through faith, rejects both atonement and regeneration, and conflicts with the normal Christian consciousness of sin and grace. 'Grace is needed to make a man into a saint, and if any man doubt this he knows not what is a saint nor what is a man' (Pascal, *Thoughts*, Eng. tr., London, 1889, p. 296).

5. This truth was brought out by Augustine, who made the keystone of his entire system the utter dependence of the believer, for the beginning, middle, and end of Christian holiness, on the free, indispensable, supernatural, prevenient, and irresistible grace of God. Two other aspects of Christian holiness received prominence in Augustine: (a) its personal, emotional aspect, as a cleaving to the Lord God, the living individual relationship of faith, humility, and love, which appropriates the Divine Spirit and leads at last to life's blissful goal of perfect knowledge, vision, righteousness, fruition, and eternal rest; and (b) its social aspect, as a grace mediated to us only by means of and within the Christian Church, which is the *civitas dei*, the Kingdom of God on earth, and the sole sphere of salvation. Augustine may thus be said to have attached equal importance to the inward experience of grace and to its outward ecclesiastical attestation; but the emphasis which he laid on the moral effect of the infused love of God, as conditioning our holiness, rather than on the soul's new religious standing through forgiveness and regenerating faith, gave a direction to the Church's doctrine on this subject which was not to receive a corrective until the Reformation.

6. From Augustine sprang the mediæval conception of *sacramental holiness*, which was developed in systematic detail by the schoolmen, and reached its final form in the Catholicism of the Council of Trent. The characteristic features of this type are the objective provision for man's holiness in the supernatural grace of the sacraments, and the place assigned to merit in the process of sanctification. The one perfect treasury of all holiness and righteousness is Jesus Christ. We become members of His body, and share in the fruits of His Incarnation and Passion, when we receive the sanctifying grace of His Holy Spirit. This prevenient grace is a supernatural power or quality infused into the soul by means of the Divinely appointed sacraments or through prayer. It imparts the impulse towards righteousness and God, obliter-

ates sin both original and mortal,¹ and produces, on the condition of our co-operating trust, that inner sanctification or disposition of assenting faith and justifying love which warrants the Divine forgiveness, inaugurates a state of supernatural sonship or infused habit of holiness, and enables the soul to acquire those merits which are requisite for salvation.²

¹ By a justifying faith the [Catholic] Church understands qualitatively the theoretical faith in the truths of Revelation, and demands over and above this faith other acts of preparation for justification: namely, fear, hope, charity, penance, and almsgiving (*The Catholic Encyclopædia*, vi. [1909] 701 f.; cf. *Council of Trent*, vi. 7, 9).

These good works, however, are themselves the fruit of co-operating grace,³ which incites and stirs into activity the latent goodness of man, and enables him, by a refined synergism, to fulfil the law of Christ, to receive justification, and to merit, *ex condigno*, or in strict justice, increase of grace, eternal glory, the *fruitio dei*, and participation in the Divine nature, which are the rewards of holiness.⁴ In Catholicism, justification is not simply a formal declaration of the forgiveness and remission of sins, with an external imputation of the holiness of Christ through faith; it is the actual result of the sacramental renewal of the inner man, by means of the acquisition of a new *qualitas* within the soul, as it is appropriated through incorporation in the Holy Catholic Church. As such, justification is necessarily gradual and not instantaneous. It admits of increase and decrease or even loss, according to each man's co-operating disposition to receive it,⁵ the plain precepts of the gospel sufficing for ordinary Christians of the second order, while higher counsels of perfection remain additional and optional for such as 'in a better and quicker way' would attain to eternal life by totally abandoning the good things of this world.⁶ These not only attain to a religious level 'quæ statum perfectionis profitetur,' but they may even so excel in holiness beyond what is strictly required of them ('bonum superexcedens' [*Summa*, II. i. qu. 109, art. 2]) as to accumulate a treasury of merit or works of supererogation, which are available for less mature Christians in the form of indulgences (*q.v.*), by a kind of transferred holiness, yet always on the basis of the mystic union of believers in the One Head.⁷ The absence of any assurance of salvation in this system⁸ constrains the believer to supplement his faith by making diligent use of the Church's means of grace and by applying himself eagerly to salutary acts of virtue, in order to acquire, 'by many repeated efforts after obedience,' that holiness which is necessary for future blessedness (see J. H. Newman, *Parochial and Plain Sermons*⁹, London, 1844, i. 1-16).

7. Side by side with this sacramental type of holiness, and partly in protest against its spirit, there was fostered within the Church the piety of Mysticism, or immediate *subjective holiness*. Mysticism has assumed many forms in the history of the Church, but its characteristic ethical feature is the desire for inward purity as a neces-

¹ Thomas Aquinas, *Summa*, III. qu. 69, 86, 87; *Council of Trent*, v. 5, vi. 14, 1611.

² *Summa*, I. qu. 110-114; *Trent*, vi. 7.

³ Augustine, *de Gestis*, 85; *Trent*, vi. 16.

⁴ *Summa*, II. I. qu. 114, art. 3; *Trent*, vi. 5, 1622.

⁵ *Trent*, vi. 10, 15.

⁶ *Summa*, II. I. qu. 108, art. 4. See, further, art. COUNSELS AND PRECEPTS. Official Catholicism, however, does not require withdrawal from the world as a condition of complete holiness. 'For the canonization of a servant of God it is sufficient that there be proof that he has practised those virtues which occasion demanded, in an eminent and heroic degree, according to his condition in life, rank, and circumstances' (Benedict XIV., *de Servorum Dei Beatific. et Beatorum Canoniz.*, Padua, 1743, III. 21).

⁷ *Summa*, III. suppl. qu. 13, 25. Cf. III. qu. 48, art. 2; *Trent*, vi. 16; *The Catholic Encyc.*, x. [1911] 203.

⁸ *Summa*, II. I. qu. 112, art. 5; *Trent*, vi. 9, 1612-13.

sary condition of beholding and being united to God, through purgation, illumination, the renunciation of all creatures, and the elevation of the soul above the distractions and multiplicities of the world of time and sense. In its extreme forms, mysticism tends to dispense with everything external and intermediary, and to wander into vague regions that are non-Christian, non-historical, and even pantheistic, thus making a fatal sacrifice of the Divine holiness. Christian mysticism frequently tends to depart from NT holiness by seeking to approach God otherwise than through the Incarnate Word, the means of grace, and the sole relationship of faith, as well as in its whole manner of laying emphasis on finitude rather than sinfulness, immanence rather than transcendence, communion rather than forgiveness, feeling and imagination rather than will and conscience, the bliss of personal absorption in the life of God rather than a life of filial obedience to His will. Yet mysticism has ever served piety by insisting on inward experience and spiritual passion in religion; and in a St. Bernard it exhibited intense personal love of the suffering and lowly Jesus, the Bridegroom of the soul, as an all-important element in Christian holiness.

8. In the Mendicant Orders we find a still further reaction against the clerical ideal of sanctity, in the emphasis laid upon *lay holiness*. St. Francis and the friars brought back holiness from monasteries, churches, and the technicalities of hierarchical religion to the homes and haunts of ordinary men and the service of one's neighbour, by the preaching of penitence, humility, love, and a joyous imitation of the poverty of Jesus.¹

9. The chief corrective, however, to the sacramental conception of holiness was to come not from mysticism within the mediæval Church, but from Protestantism outside it. The Reformers contended for a *fiduciary holiness*, based on the religious experience of faith.

¹ Augustine and Catholicism attached great weight to sin; but behind sin stood *concupiscentia*, virtually a physical conception: and behind righteousness the hyper-physical *infusio dilectionis*, etc. Hence Catholicism culminates in ascetic morality and mysticism. For Luther there stands behind sin in the ethical sense sin in the religious sense, i.e. unbelief, and behind the being righteous the fundamental religious virtue, i.e. faith. . . . Luther attained that which Augustine, owing to his Neo-Platonism, was not fortunate enough to reach, notwithstanding numerous approaches to it; he made Christianity again a religion' (F. Looft, *Leitfaden*⁴, Halle, 1906, p. 787 f.).

(a) To the mystical doctrine of holiness through spiritual absorption in God in a love that replaces faith, Luther opposed the evangelical doctrine—itsself essentially mystical—of the soul's present justification and holiness through the forgiveness of sins and a personal acceptance with the Father, for Christ's sake, by means of a sincerely penitent and trustful faith which neither need be nor can ever be outgrown. To the semi-Pelagian Catholic doctrine of holiness, with its mysterious stream of forces in the sacraments, its infused and almost quantitative grace, its merely assenting faith, its elaborate penitential apparatus for the removal of sin, its toil and uncertainty, its emphasis on co-operating merit as imparting to the believer an objective and inherent righteousness before God—to all this Luther opposed the more religious conception of a joyous present certainty of individual salvation as a result of the direct personal relationship of childlike faith in the Father who has opened His loving heart to us in Christ Jesus, and won our unswerving trust by the free forgiveness of our sins. In such a system, sanctification, so far from being a stage in the process of justification, issues from justification as its necessary obverse; for there is no other or further holiness possible

¹ For the Friends of God, Waldenses, and other holiness sects of the Middle Ages, see separate articles.

to the Christian than that of faith, which is simply the continual daily appropriation, not of forgiveness only, but of God Himself in Christ, as the source of the believer's peace, power, righteousness, and good works. In the teaching of Luther, Christ Himself assumed the central place which in Scholasticism was occupied by infused grace; and the holiness of monasticism, with its ascetic morality and withdrawal from the world, was rejected to make way for a holiness of faith which could nowhere be better exemplified than in one's ordinary calling as ordained by God.

'Perfectio Christiana est serio timere Deum, et rursus concipere magnam fidem, et confidere propter Christum, quod habeamus Deum placatum, petere a Deo, et certo expectare auxilium in omnibus rebus gerendis, juxta vocationem; interim foris diligenter facere bona opera, et servire vocationi. In his rebus est vera perfectio et verus cultus Dei' (*Augsburg Confession*, 1630, ii. 27).

(b) The teaching of Calvin on this subject was governed by his doctrine of Divine predestination, electing grace, and the sovereign will of God. His aim was to cultivate an *intensive holiness* which should consist not simply, as Luther so breezily taught, in that free and loving service of all men which results from the joyous experience of the Divine forgiveness, but rather in reverent obedience to God's commandments and the observance of 'such legitimate worship as is prescribed by the law' of God (*Inst.* i. ii. 3). True holiness is possible only to such as are elect by the decree of God (III. xxii. 2), and it follows by a Divine inner necessity from justification, yet only within the sphere of the Christian Church, because of its possession of the Word and sacraments (IV. i. 4, 16). Not that all the members of the Church are equally holy,

'only that with their whole heart they aspire after holiness and perfect purity; and hence, that purity which they have not yet fully attained is, by the kindness of God, attributed to them.' 'The Church is sanctified by Christ, but here the commencement only of her sanctification is seen: the end and entire completion will be effected when Christ, the Holy of holy ones, shall truly and completely fill her with His own holiness' (iv. i. 17, viii. 12).

Hence the importance attached by Calvin to a strict ecclesiastical discipline as a means to holiness (IV. xii.).

'According to Luther the primary purpose of the Church was to proclaim the Gospel of God's forgiving love in Christ; according to Calvin it was to train the elect in holiness. . . . The notion of the Church as a communion of holy people, pure both in doctrine and in conduct, because wholly governed by the will of God, increasingly overshadowed the idea of it as an agency for the proclamation of God's forgiving love' (A. O. McGiffert, in *Essays in Modern Theology and Related Subjects*, New York, 1911, p. 218f.).

These characteristics profoundly influenced modern Europe and gave birth to the *austere holiness* of Scottish Presbyterianism and English Puritanism, with their occasional excesses of harsh casuistry, Sabbatarian gloom, and iconoclastic zeal, but with compensating glories of spiritual grandeur and imaginative power. These types aimed at recovering the full *ethical* content of holiness, as well as the due emphasis on the holiness of God, and, by a new asceticism, they were all the more mighty in outwardly dominating the world because they had inwardly and spiritually renounced it (see E. Troeltsch, *Protestantism and Progress*, Eng. tr., London, 1912, pp. 79-85, 136-141).

10. The ferment caused by the Reformation gave rise to several attempts, mostly non-ecclesiastical, to establish a more *experimental holiness*, the various forms of which may be studied in the Anabaptists, Seekers, Quakers, and other sects, in Pascal and the Port-Royalists, and in Molinos, Fénelon, Madame Guyon, and the Quietists. In Germany in the 18th cent. the movement took the form of Pietism, a reaction against the stiff scholastic dogmatism of the Lutheran Church and current rationalism. Spener, Francke, and Gottfried Arnold were the leaders of a school which sought to transfer

the emphasis in religion from belief in an orthodox creed, and reliance upon institutions and means of grace, to the more emotional and personal appropriation of saving truth and the exemplification of it in holy conduct. The experience of conversion and regeneration was insisted on as an indispensable preliminary to the true knowledge of God or the fruitful study of theology. 'Awakened' Christians were encouraged to meet together for free prayer, and an attitude of aloofness or antagonism was taken up towards worldly amusements and secular culture. The movement gave rise to both philanthropic and fanatical developments, and in passing over into Moravianism it revealed strong separatist as well as missionary tendencies.

11. Moravianism in its turn did much to inspire Methodism, with its characteristic doctrine of *perfect holiness*. Already in his undergraduate days at Oxford, John Wesley had been known as the founder and leader of the 'Holy Club.' When he was about twenty-two, the reading of Thomas à Kempis led him to see that

'true religion was seated in the heart, and that God's law extended to all our thoughts as well as words and actions. . . . I set apart an hour or two a day for religious retirement. I communicated every week. I watched against all sin, whether in word or deed. I began to aim at, and pray for, inward holiness' (*The Journal of John Wesley*, ed. N. Curnock, London, 1909, i. 466f.).

These and subsequent experiences, rather than any abstract theorizing on the subject, led Wesley to become the life-long champion of doctrines which he afterwards unfolded in 'A Plain Account of Christian Perfection, as believed and taught by the Rev. Mr. John Wesley, from the year 1725 to the year 1777' (*Works*, London, 1830, xi. 366-446).¹ Wesley 'believed and preached that the Divine Spirit was as mighty in administering redemption as the Divine Son in accomplishing it' (*A New History of Methodism*, ed. W. J. Townsend, etc., London, 1909, i. 214). In opposition to the Catholic doctrine of meritorious perfection, the mystical conception of perfection through isolated communion with and absorption in deity, and the general view of perfection as something to be attained only in a future life, Wesley maintained the doctrine of a present evangelical or Christian perfection in the entire sanctification of perfect love. Such perfection is not to be confused with absolute or angelic or 'Adamic' righteousness, and is consistent with a thousand defects arising from our ignorance, infirmity, and creaturely limitations, being relative to the helps and opportunities of every moment. 'It is the perfection of which man is capable while dwelling in a corruptible body; it is loving the Lord his God with all his heart and with all his soul and with all his mind.' The sin from which it is free is 'the voluntary transgression of any known law,' and it implies constant self-renunciation and even fasting, the careful observance of Divine ordinances, a humble, steadfast reliance on God's forgiving grace in the Atonement, a pure intention to regard God's glory in all things, and an increasing exercise of the love which itself fulfils the whole law and is the end of the commandments.

'The perfection which I have taught these forty years cannot be a delusion, unless the Bible be a delusion too; I mean, *loving God with all our heart*, and our neighbour as ourselves. I pin down all its opposers to this definition of it. No evasion! No shifting the question! Where is the delusion of this?' (*Journal*, 27th Aug. 1768).

This doctrine of full sanctification was 'the grand *depositum* which God has lodged with the people called Methodists; and for the sake of propagating

¹ Wesley's doctrine of perfection may be studied further in the *Journal*, 24th July 1762, 14th May 1765, 27th Aug. 1768, 26th June 1769; *Sermons*, nos. xliii., lxxvi., cxx.; and the *Letters* dated 5th Apr. 1768, 7th July 1761, 15th Sept. 1762, 12th May 1763, 21st Feb. 1771. See also *Minutes of Conversations*, June 1744 and Aug. 1745, and the *Methodist Hymn Book*, section 'For Believers Seeking Full Redemption.'

this chiefly, He seems to have raised them up.' Wesley even doubted whether any who preached against it could continue in the Society (*Letters*, 15th Sept., 26th Nov. 1790).

12. The influence of these doctrines has been far-reaching. In the various branches of Methodism to-day 'the emphasis is everywhere laid . . . on the calling to the life of entire sanctification which is brought about by the reign of perfect love in the heart' (*A New History of Methodism*, ii. 421). This is especially prominent in the most recent offshoot of Methodism, the Salvation Army. 'Even among our worst enemies it has been admitted that the strength of the Salvation Army lay in its Holiness teaching' (*Holiness Readings . . . reprinted from the War Cry*, London, 1883, p. v; see also *S.A. Orders and Regulations for Field Officers*, London, 1886).

13. The rise of modern Holiness Movements in Europe and America, where the work of Pres. C. G. Finney of Oberlin helped to prepare the soil, may be traced largely to the revival of religion through the work of Moody and Sankey in 1875. But it had already begun several years before, first in America and then in England, its pioneer with both word and pen being W. E. Boardman,¹ who together with R. Pearsall Smith held a long series of special meetings for ministers and others in 1873 and 1874. A striking issue of these was a conference held at Broadlands Park, Romsey, in 1874, on the invitation of Lord Mount-Temple, for the purpose of considering 'the Scriptural possibilities of faith in the life of the Christian in the daily walk (a) as to maintained communion with God; and (b) as to victory over all known sin' (C. F. Harford, *The Keswick Convention*, London, 1907, p. 26). In the same year a larger conference, under the leadership of Smith and Boardman, met at Oxford 'for the promotion of Scriptural holiness'; and in 1875, by invitation of Canon Harford-Battersby, the first 'Convention for the Promotion of Practical Holiness' was held at Keswick. Among the chief leaders of the convention have been included Théodore Monod, Andrew Murray, A. T. Pierson, F. B. Meyer, and H. C. G. Moule. 'The Keswick Convention has set up no new school of theology, it has instituted no new sect, it has not even formed a society, but exists for the sole purpose of helping men to be holy' (Harford, *op. cit.* 4).

In 1875, Smith visited Berlin and inaugurated what came to be known as the modern German *Gemeinschaftsbewegung*. His work was earnestly taken up by Schlümbach, Christlieb, Paul, and others, and led to the formation of the *Deutscher Evangelisationsverein* (1884), the *Gnadauer Pfingstkonferenz* (1888), the *Blankenburger Allianzkonferenz* (1905), and similar associations. In some cases these broke away from the Established Church, but for the most part their aim was to cultivate a deeper holiness by means of special organizations in touch with it. The best theological exponents of this school were Jellinghaus and Lepsius, whose views, however, have been regarded as unduly moderate by the more advanced sections. In German Switzerland, O. Stockmayer is its chief representative. In America, apart from more special organizations like A. B. Simpson's 'Christian Alliance,' the *Northfield Convention*, established near Moody's own home in Massachusetts in 1880, has proved most influential. Out of it has sprung the *Student Christian Movement*,

¹ Boardman's *Higher Christian Life*, written before 1860, ran through many editions on both sides of the Atlantic, and quietly prepared many minds for the movement when it began to take more overt form in 1870 in Union Holiness Conventions under his leadership. It is still perhaps the most valuable introduction to the study of the modern Holiness Movement. See his *Life* (London, 1886).

and other similar associations for the deepening of the spiritual life.

Modern Holiness Movements have advocated the privilege and possibility of our attaining, here and now, to the peace, power, and purity of full sanctification, through the surrender in faith.

Keswick sets before men 'a life of faith and victory, of peace and rest as the rightful heritage of the child of God, into which he may step not by the laborious ascent of some "Scala Sancta," not by long prayers and laborious effort, but by a deliberate and decisive act of faith' (Harford, *op. cit.* 5f.). 'In the blood and death of Jesus there is to be had not only forgiveness but also a direct and immediate breaking of the power of sin, cleansing from sin, and continual victory over sin, in the surrender of faith' (Th. Jellinghaus, *Das völlige gegenwärtige Heil durch Christum*², Basel, 1903, pp. 20, 440).

In more popular statement, a 'higher life' or 'second blessing' of 'full salvation' may be experienced through a single act of perfect consecration to God, who in response completely neutralizes or eradicates the sinful nature so as to grant a present deliverance from the power of sin, on the sole condition of 'abiding' in an attitude of dependent life-union with the exalted Christ. The degree to which this last condition, which involves exercise of the personal will of the believer, is explicitly dwelt on accounts largely for the different types of Holiness teaching. How far some forms of it can go may be judged by the affirmation of pastor Paul, 'I have for a long time now seen nothing of my old nature' (*Gnadau Conference Report*, 1904, p. 298). Such a claim to perfect holiness, however, is to be interpreted in a religious rather than in a moral sense. It admits of moral progress through growing 'light' in the conscience—and this the more rapidly because a new and normal attitude of obedience to God's will as known has been consciously and once for all accepted by faith. 'In reality we are not yet fully holy' (H. Benser, *Das moderne Gemeinschaftschristentum*, Tübingen, 1910, p. 36).

Generally speaking, the modern Holiness Movement seeks to conserve a neglected truth, and in an age of materialism and busy externalism in religion it has incalculably deepened the spiritual life of the Church. Yet its actual forms, apart from the extravagances of human frailty and error, have frequently suffered from narrowness of theological outlook and a lack of both psychological and ethical insight into the deep implications of the gospel. It is plainly unscriptural to suggest that any 'second blessing' can confer on certain Christians a higher *kind* of sanctification than the holiness that flows essentially from justifying faith, or bestow a new grace of spiritual infilling and deliverance from sin 'distinct from and additional to' the gift of the Holy Ghost granted in conversion and regeneration. 'It is a fatal mistake to think of holiness as a possession which we have distinct from our faith and conferred upon it. That is a Catholic idea, still saturating Protestant pietism' (P. T. Forsyth, *Christian Perfection*³, 1910, p. 7). Further weaknesses may be seen in the tendency to identify holiness with quietistic self-abnegation, even to the loss of personality, and with the 'rest of faith,' dis severed from inspired moral effort; to frown on all 'secular' culture and brand as essentially sinful habits and pursuits which are in themselves indifferent; to overstimulate feeling and to confine the grace of God to stereotyped forms of conversion; and to claim with overweening confidence the special sealing of the Holy Spirit and direct inspiration in the details of thought and action. In these respects the modern Holiness Movement is not an advance upon but rather a retrogression from Reformation standards (see P. Gennrich, *Die Lehre von der Wiedergeburt*, Leipzig, 1907, pp. 204-215; and C. R. Erdman, 'Modern Spiritual Movements,' in *Biblical and Theological*

Studies, by members of the Faculty of Princeton Seminary, New York, 1912, pp. 359-392).

There is noticeable at the present day a certain avoidance and dislike of the special advocacy of holiness, even within the Christian Church. This may be due to (a) the trend of modern thought, so far as it seems to have weakened the transcendental claims of theology, and consequently of Christian ethics; (b) absorption in social and economic problems, from which Holiness Movements have too frequently and ostentatiously withdrawn themselves; (c) a reaction against the unscientific and narrowly pietistic interpretation of the Bible; (d) a mistaken identification of holiness with asceticism, morbid introspection, other-worldliness, or professional religion. Hence we have such statements as the following:

'The idea of a holy working man is even grotesque. The virtues which the working classes at their best have recognized have been rather those of integrity, generosity, sincerity, good comradeship, than those of meekness, purity, piety, self-abnegation, and the like' (E. Belfort Bax, *The Ethics of Socialism*, London, 1889, p. 17).

The remedy would seem to lie in a recovered sense of the personality, transcendence, and holy character of God as the ground of all Christian holiness; in a fuller recognition of the social obligations of a holy life; and in a return to the harmonious NT ideal of holiness, with all its comprehensive religious and ethical implications.

'I do feel that holiness consists in hearing Christ and following Him step by step in the minutest part of the minutest duty, and in acknowledging an ordinance of Christ in all the natural and social relations' (T. Erskine of Linlathen, *Letters*, London, 1878, p. 152).

LITERATURE.—(1) *BIBLICAL*.—Besides the best commentaries and text-books of NT Theology, see artt. 'Holiness' and 'Sanctification,' in *HDBand DCG*, and art. 'Heiligkeit Gottes im AT,' in *PRE*³; E. G. Marsh, *The Christian Doctrine of Sanctification*, London, 1848; R. C. Trench, *Synonyms of the NT*¹, do. 1871, §88; O. Stockmayer, *Grace and Sin*, Eng. tr., do. 1879; A. Jukes, *The New Man*², do. 1881; J. H. Oswald, *Die Lehre von der Heiligung*³, Paderborn, 1885; E. Issel, *Der Begriff d. Heiligkeit im NT*, Leyden, 1887; E. H. Askwith, *The Christian Conception of Holiness*, London, 1900; B. Froget, *De l'Habituation du Saint-Esprit dans les âmes justes*², Paris, 1901; De Bellevue, *L'Œuvre du Saint-Esprit, ou la sanctification des âmes*, do. 1901; G. G. Findlay, 'Sanctification according to Christ,' in *Expositor*, 6th series, iv. [1901] 1-15; T. Cook, *NT Holiness*, London, 1903; J. A. Beet, *Holiness Symbolic and Real*, do. 1910.

(2) *HISTORICAL*.—The artt. 'Grace' and 'Holiness,' in *The Catholic Encyclopædia*, London, 1907-12, vi. and vii.; H. T. Cremer, art. 'Heiligung,' in *PRE*³; the *Histories of Dogma*, by A. Harnack, Eng. tr., London, 1894-99; F. Loofs⁴, Halle, 1906, and R. Seeberg, Leipzig, 1910; A. Ritschl, *Gesch. des Pietismus*, Bonn, 1880-86, *Die christl. Lehre von der Rechtfertigung und Veröhnung*, 8 vols., Bonn, 1870-74 (Eng. tr. of vol. iii. = *Justification and Reconciliation*, Edinburgh, 1900); W. B. Pope, *Compendium of Christian Theology*², London, 1880, iii. 61-99; A. V. G. Allen, *Continuity of Christian Thought*², do. 1895; E. Troeltsch, 'Prot. Christentum und Kirche in der Neuzeit,' in *Die Kultur der Gegenwart*, Leipzig, 1906, i. iv.; J. Jüngst, *Pietisten*, Tübingen, 1906; H. Benser, *Das moderne Gemeinschaftschristentum*, do. 1907; P. Gennrich, *Die Lehre von der Wiedergeburt*, Leipzig, 1907; R. M. Jones, *Studies in Mystical Religion*, London, 1909; R. H. Coats, *Types of English Piety*, Edinburgh, 1912; C. R. Erdman, 'Modern Spiritual Movements,' in *Biblical and Theological Studies*, New York, 1912; and artt. *ASCETICISM, MONASTICISM, PIETISM, METHODISM*, etc.

(3) *GENERAL*.—Jeremy Taylor, *Holy Living*, London, 1650, *Holy Dying*, do. 1651; R. Baxter, *Saint or Brute*, do. 1662; J. Owen, *Indwelling Sin*, do. 1675; W. Marshall, *The Gospel Mystery of Sanctification*, do. 1692; W. Law, *Christian Perfection*, do. 1726, and *A Serious Call*, do. 1729; Jonathan Edwards, *The Religious Affections*, Boston, 1746, iii. iii.; W. Wilberforce, *A Practical View*, etc., London, 1797; F. W. Faber, *Growth in Holiness*, do. 1855; T. Goodwin, 'Of Gospel Holiness in Heart and Life,' in *Works*, Edinburgh, 1862, vol. vii.; E. M. Goulburn, *The Pursuit of Holiness*, London, 1869; C. G. Finney, *The Endowment of Power*, and A. Mahan, *The Baptism of the Holy Ghost* (in one), do. 1875; Th. Monod, *Life More Abundant*, do. 1881; W. E. Boardman, *The Higher Christian Life*, London, 1883; H. C. G. Moule, *Thoughts on Christian Sanctity*, do. 1885; A. Murray, *Holy in Christ*, New York, 1888; J. Baird, *Studies in the Spiritual Life*, Edinburgh, 1890; H. C. G. Moule, *Spiritual Fulness*, London, 1892; J. W. Diggie, *Short Studies in Holiness*, London, 1900; H. W. Webb-Peploe, *Calls to Holiness*, do. 1900; W. James, *Varieties of Religious Experience*, do. 1902; Th. Jellinghaus, *Das völlige gegenwärtige Heil durch Christum*⁵, Basel, 1903; Francis Thompson, *Health and Holiness*, London, 1906; C. G. Montefiore, *Truth in Religion*,

do. 1906, pp. 73-101; H. C. G. Moule, *Holiness by Faith, etc.: A Manual of Keswick Teaching*, do. 1906; G. Tyrrell, *Lez Crendi*, do. 1907, pp. 54-61, 132-152; E. V. Jackson, *The Life that is Life indeed*, do. 1910; P. T. Forsyth, *Christian Perfection*², do. 1910, *The Principle of Authority*, do. 1912, ch. x.

R. H. COATS.

HOLINESS (Roman).—A definition of 'holiness' in relation to the Roman spirit is not easy to frame. Perhaps 'purity under divine sanction' may be taken as a rough explanation for the present purpose. In the earliest religion of the Roman State, ceremonial obligations were minute and exacting, and their relation to conduct is obscure, but the idea that character was in some way dependent on a power unseen and superhuman was not entirely wanting. The conception that moral perfection is pleasing to heaven is embodied in some of the oldest forms of cult—that, for instance, which the Vestal Virgins served. On not a few critical occasions the anger of the gods, bursting upon the community, was traced to their displeasure against an erring Vestal. As time went on, moral abstractions, treated as divinities, were publicly revered—chastity, for instance (*Pudicitia*); and these forms go back to an age when in religious matters Rome had as yet not been very deeply affected by Greece. Indeed, reverence for such abstract powers was always more characteristic of Italy and the West than of Greece and the East. We must ask and, if possible, answer the difficult question, What effect upon the individual life had the belief that morality is under the protection of Heaven? If we regard only the utterances of the Latin satirists who paint the manners of a small clique in the capital as though they were representative of the whole world, or the equally indiscriminate denunciations of Paganism by early Christian writers, we may be tempted to answer 'None.' But a great amount of evidence exists which tells a different tale.

Thus, the vast mass of private memorials unearthed in the Western world by excavation bears testimony to a family life far different from that which is almost exclusively presented in the literature of the Empire. The fact that Vesta was the presiding deity of the family circle, as well as of the State conceived as a larger family, is a sign of a general belief that the ultimate sanction of morality is found in a supernal world, and that moral cleanliness among those of this world is a precept which issues from the other. This idea finds general expression in language, particularly in the use of the words *castus, purus, sanctus, pius*. Of course, these terms sometimes have a hard and somewhat lowly significance. They may be employed in a limited sense, not in reference to character taken as a whole, but to abstinence from some particular class of immoral acts. It is not easy to trace the moral life of a people or an empire. But it is not too bold to say that the history of these words in the Latin language shows a steady elevation of the ideal of morality.

The conviction that, in spite of the many horrible misrepresentations which a long line of pagan poets and philosophers denounced, the gods favour personal purity is exhibited in much Roman ritual besides that connected with Vesta. Priests and priestesses were often subject to severe restrictions. Boys and girls, being innocent, were employed in divine service, as we see in the *Carmen Sæculare* of Horace. This famous hymn may be said to have done homage to the efforts of Augustus, who strove to cure the sickness of the world by the union of moral and religious reform. His policy made an epoch in the social history of the Western Empire. The great Greek tide which had swept the educated classes into scepticism began to turn, and a belief in the divine govern-

ment of the world was renewed and penetrated society. An increased yearning, after moral purity manifested itself in many ways. New forms of religion and new applications of philosophy alike show the influence, although then, as after, religion and philosophy were not always on the side of morality. There were Stoic and Cynic antinomians as there have been Christian. And the new divinities, Isis and Mithra and others, who were so ardently accepted, could debase their worshippers. But, on the whole, these new cults were popular, at least in part, because they satisfied to some extent the desire to find a way of escape from the corruption of unregenerate human nature—a way not opened by the older civic faiths. The seeds of Christianity could hardly have thriven as they did in the field of the Roman world if it had been still, morally, the world of the ancient Cato.

Not unnaturally we find purity as a cult more prevalent among women than among men. On the principle of 'corruptio optimi pessima,' satirists specially loved to depict the degradation of women. But an attentive reader, say, of Mayor's notes on Juvenal, will see something of the other side of the shield. And a perusal of the very numerous gravestones of women will leave an impression that there was, even at the worst time of the Empire, a wide range of sound family life, resting on the purity of the matron and mother. The commendations of the untainted lives of mothers of households are, in a multitude of cases, far from being hypocritical or merely conventional. The celebrated eulogy by a consul, Lucretius, on his wife Turia, in the Augustan age, praises her for chastity and religiousness without superstition. It was just this hope of stainlessness, combined with worship cleansed from superstition, that drew women, and in a less degree men, not only to Christianity, but to the cosmopolitan pagan divinities. A common type of inscription praises a wife for her 'old-time sanctity and modesty.' In spite of loose views of the marriage tie, we hear much of marriages which endured through long lifetimes, and the title *univira*, 'wife of one husband,' was prized. This turning away from the superstitious exaggerations of the ancient cults, combined with a recoil from impurity, is well seen in that strange apology for Christians rather than for Christianity, the *Octavius* of Minucius Felix, written in the latter half of the 2nd cent. A.D.

Until the rise of the Neo-Platonic philosophy, which was not a great force until the last Imperial centuries, the tendency of the later philosophers, both in the East and in the West, was to eschew theory and enforce morality. This was characteristic of all the schools alike, by whatever name they were called. It is impossible to mistake the trend in educated circles in the West during the first three centuries of the Empire towards an elevation of morality, whose moving force was a higher view of the relation of the individual to God. There is an ever strengthening vein of puritanism in the later philosophy, which reached its full development in the Neo-Platonic scheme. This vein is especially traceable in Stoicism. The dry logic of earlier Stoicism was softened, so that the moral lessons of the school might reach a large circle of Roman disciples. Every attempt was made to bridge over the gulf between the philosopher and the vulgar. The philosophic missionaries, who wandered about the world preaching to the multitude, though accused, like other teachers, of criminality, found a hearing from the crowd just because of the vague yearning after a better life. There was a gradual approximation to the Christian idea of sin, and the necessity was realized of a divine deliverance from the burden of the flesh,

with its impulse to immorality. Virtue was explained as attainable only by the will of God, and by imitation of the divine; duty, as the outcome of the divine law. 'No man is good without God,' said Seneca. The philosophic teacher was more and more presented as the curer of sick souls. The wide difference between doctrine and practice among the followers of this teaching was the theme of satirists, but there is much reason to doubt whether they were more open to this kind of reproach than the adherents of other religious and moral systems in the past and in the present.

LITERATURE.—Information on the subject is scattered about in works on Roman religion and Philosophy and Social Life. Especially may be mentioned: G. Wissowa, *Religion und Kultus der Römer*² (in Müller's *Handbuch der klassischen Altertumswissenschaft*), Munich, 1912; L. Friedländer, *Darstellungen aus der Sittengeschichte Roms in der Zeit von Augustus bis zum Ausgang der Antonine*³, Leipzig, 1881; E. Zeller, *Philosophie der Griechen*⁴, do. 1898, iii. J. S. REID.

HOLINESS (Semitic).—The conception of holiness when traced to its historic origins among Semitic peoples is stripped of all the ethical qualities with which our Christian modern consciousness has invested it. The ethical elements which have become absorbed into its content entered at a much later stage in the evolution of ideas which became attached to the term. This change of connotation will be duly noted in its proper place.

I. HOLINESS AT THE EARLIER STAGE.—I. The original meaning of the Semitic word for 'holy,' 'holiness,' *k-d-s* (*s*).—The use of the Assyrian *kuddusu*, 'to purify,' and of the corresponding adjective *kuddusu* in the sense of 'pure,' 'bright' (to which the syllabaries give us the synonyms *ellu*^m and *ebbu*, 'clear' or 'bright'), might tempt us to assume that the original connotation of the term was 'brightness,' especially when the Arab. *kadasa* and its derivatives might seem to lend some support to this view. But it would be precarious to build upon the infrequent use in Assyrian of derived forms, and in Arabic of what may be a derived meaning. Our only safe course is to generalize from the use of *k-d-s* both as verb and as substantive in the earliest documentary sources, and of other words, such as *k-r-m*, found in all the Semitic languages possessing a similar meaning. We are thereby led to the conclusion that the term *k-d-s* expresses the separation or reservation of a thing or a person for Divine use or a Divine cult, and the state of an object or person so reserved and brought into close relation with Deity as inaccessible or hardly accessible, and invested with a quasi-Divine character and power.

We are here touching upon the common ground of primitive custom where Semitic and non-Semitic traditions blend. The saying of Statius, quoted with approval by E. Renan (*Hist. d'Israël*, Paris, 1887-94, i. 29), 'Primus in orbe deos fecit timor,' here finds its application. The element of fear, which invests the relations of primitive man (see the 'General' art. above) with the occult personal or quasi-personal agencies with which he appeared to be surrounded, is expressed in the Heb. phrase for religion, *יְהוָה יִרְאָה*. This feeling of awe was extended to all objects which stood in more immediate contact with the gods whom the Semite worshipped.¹

¹ Robertson Smith is dominated by his conception of sacrifice as expressing communion between God and the worshipper. Therefore, when he says (*Rel. Sem.*² 54 f.), 'It is not with a vague fear of unknown powers, but with a loving reverence for known gods who are knit to their worshippers by strong bonds of kinship, that religion in the only true sense of the word begins,' he is expressing only a partial truth. S. I. Curtiss, who travelled among the inhabitants of the Hinterland of Syria and Palestine, is probably right in asserting that the worship of the modern primitive Semite is simply the product of fear. The answer of his Arab guide Hamdân to the question what made the Arabs religious might almost as well be given by the primitive

Analogies to the primitive conceptions of holy things may be found in Hebrew religion. The mountain Sinai, Jahweh's abode, was holy and could not be touched without peril to life (Ex 19^{12, 13, 21-24}). Similarly Uzzah's temerity in touching the ark of God (2 S 6^{6f.}) led to his death. We have an instructive example of the survival of such magical conceptions regarding holy objects in the ceremony of trial by ordeal of a woman suspected of adultery (Nu 5¹¹⁻²⁸ [P]).

The passage is difficult because it shows, if Baentsch's analysis be correct, that the text has been worked over at different times. After various ceremonies we read in v. 17⁸: 'And the priest shall take holy¹ water in an earthenware vessel; and of the dust which is on the floor of the tabernacle shall the priest take and put it into the water.' After further ritual, as unloosing the woman's hair,² the officiating priest takes in his hand the 'baleful water that brings a curse' and makes the woman swear a solemn oath (vv. 19-22). After reciting the words at its close, 'And this water that brings a curse shall enter thy bowels to cause thy womb to swell and thy thigh to fall,' to which the woman replies, 'Amen, Amen,' the priest writes the words of the curse in a book and immediately dissolves the writing³ completely in the baleful curse-bringing water, and, after waving a meal offering before Jahweh and burning it, he causes the suspected woman to drink the 'holy' baleful water.

Robertson Smith holds that the water is here called 'holy' because it is derived from some sacred spring. 'Ēn-Mishpāt at Kadesh, as well as 'Ēn-Meribhah, he would explain as sacred springs whose waters were used in decisions based upon ordeals of this kind. On the other hand, Baudissin, with at least equal probability, explains the 'holiness' of the water as due to the fact that it was kept in a vessel belonging to the sanctuary (Ex 30¹⁶). The example we have cited is instructive as showing that *kodesh* includes a positive as well as a negative element, viz. the positive element of Divine *power* which may break forth with destructive effect. Baudissin's statement, that 'holy' does not properly designate a quality but a relation as God's property, is scarcely adequate (*Studien zur sem. Religionsgesch.* ii. 45). Moreover, this writer's view, that the materialization of holiness in Ezekiel is late (*ib.* 141), is certainly contrary to fact.

Further illustrative examples will make this clearer. In Is 65⁵ we have primitive conceptions of holiness in respect of persons as a mysterious potency which can pass from one individual to another with whom he comes in contact. The latter is therefore warned: 'Stand apart, for I make thee holy.'⁴ This expression occurs in a passage crowded with obscure references to the cults of Palestine into which the resident Hebrew population in the middle of the 5th cent. had

Semite: 'Every misfortune comes from God. Nothing comes except from Him. We fear God and the Wells. We take our vows in order to guard against injury. God receives our vow like a baksheesh. When all goes well, I offer a *fedu* that no misfortune may overtake us' (*Ursem. Rel. im Volksleben des heut. Orients*, Leipzig, 1903, pp. 293, 64 f.).

¹ Some doubt exists as to the validity of the reading of our text קִיִּים קִיִּים, for the LXX have ὕδαρ καθαρὸν ζῶον. This has induced Dillmann, Nowack, and others to substitute for the somewhat unusual קִיִּים the words חַיִּים חַיִּים or חַיִּים only. On the other hand, Robertson Smith (*Rel. Sem.*², 181) contends for the validity of the reading 'holy water' as an 'isolated survival of an obsolete expression' in post-Exilic Judaism derived from the old language of Hebrew ritual. In this case 'pure water' and 'living water' would be the later interpretative glosses which came to be substituted in the texts employed by the Greek translator.

² See ICC, *ad loc.* Cf. on unloosing the hair, Wellhausen, *Reste*², 199.

³ Gray (ICC, 'Numbers,' *ib.*) cites the custom practised in Egypt of writing passages from the Qur'an on the inner surface of a bowl and using the water that had dissolved the writing for medicinal purposes.

⁴ Here reading, of course, the Pi'el instead of the impossible Kal of the Heb. text; so Geiger and other recent scholars. Another interpretation than that given above has been suggested to the present writer by Haddon, viz. that the initiated person is anxious not to lose his sacred potency by contact with another. Similarly in Mk 5³⁰ Jesus is well aware (*επίγινους*) that a potency (*δύναμις*) had passed out of Him when touched by the diseased woman.

lapsed. One who had passed through a ceremony of consecration warns another to keep at a distance, because contact with his own consecrated person might infect that other with holiness, and thereby surround him with a circle of tabus or restrictions which would disqualify him from discharging the ordinary duties of life. This becomes evident from a comparison with Ezk 44¹⁹. There special instructions are given to the Zadokite priesthood that, when they pass from the inner to the outer court of the sanctuary, they are to put off their official vestments wherewith they have ministered before Jahweh in the inner court (cf. v. 18¹.) and place them in special holy chambers, lest by their contact the people whom they meet are made *holy*. Other ordinary garments must be substituted by the priesthood in the outer court in order to prevent this contagion of holiness. The same principle of contagious holiness applies to the utensils employed in sacred rites. Since special holiness was ascribed to the sin-offering, it could be eaten only in a holy place, i.e. the court of the tent of meeting (Lv 6¹⁸⁻²³). Contact with the flesh of this most holy sacrifice creates holiness, and every garment on which the blood is sprinkled must be washed in a holy place. In other words, a circle of tabus of a stringent character is set up. Hence the earthenware vessel in which the sacrificial flesh is boiled must be broken, and, if the vessel be bronze, it must be carefully scoured and rinsed. Holiness is treated in every respect as something material (vv. 21-22). We should also compare Lv 11³³⁻³⁵ 15¹². These last passages deal with cases in which something unclean has come into contact with an earthenware vessel. Thus, if a weasel, mouse, or other unclean animal (Lv 11^{29f.}) fall into an earthenware vessel, or if that vessel be touched by a person who is unclean by reason of a discharge, it shall be broken. Here we see that there is a close analogy between uncleanness and holiness. The effect on the vessel is the same; it has to be broken whether it has contained sacrificial flesh or that of an unclean animal. This close point of contact has been investigated by writers on Semitic religion, e.g. Robertson Smith and Lagrange. The common factor in both impure and holy objects is that a certain element of danger, owing to the action of a superhuman agency, invests the object in both cases (*Rel. Sem.*² 153, 447-452), and serves to debar it from human use and contact. For contact in both cases involves contagion, and in certain cases uncleanness.¹ Thus in Heb. שָׁׁ the familiar root meaning 'approach' is used in Arabic in the sense 'be impure.' At the same time, the distinction between holy and unclean is a real one, though both are blended in various forms of tabu in savage custom (see the 'General' art.).

Primitive life deals with concrete conceptions. Thus in primitive Semitic religion, holiness might be regarded as the nimbus or outflow of Deity which attached itself to everything that mediates in worship, whether persons or things, between the god and his worshipper. So closely is holiness attached to the Divine personality that Jahweh swears by it (Am 4²) just as He does by His life (Nu 14^{21, 28}, Dt 32⁴⁰, Jer 46¹⁸; cf. 1 S 14^{39, 43}, 2 S 2²⁷, etc.), or just as the Divine *name* became associated with Himself and men swore by it (Lv 19¹², 1 S 20⁴², Zec 5⁴; cf. Jer 44²⁶ etc.). Thus we find 'holy gods' in the inscription of Eshmun'azar (line 9).

The ideas of withdrawal, restriction, and reservation expressed in Heb. by *k-d-s*, applied to objects connected with worship, are in Arabic exhibited by other terms. Chief among them is the

¹ See the reference to the Holy Scriptures 'defiling the hands,' at the close of the present article.

word *haram*, of which the root frequently appears in Canaanite Hebrew, Aramaic, and occasionally in Assyrian. In this case etymology enables us more easily than in that of $\text{ḥ} - \text{d} - \text{š}(s)$ to arrive at a definite connotation. Its meaning is 'to seclude,' 'debar,' or 'render inaccessible.' What is sacred and also legally prohibited is called *ḥarām*, and any object or woman who may not be approached is designated *ḥarīm*. Thus *ḥarām*, a substantive, is specially used by a Muslim of the sacred enclosure of the Ka'ba at Mecca. With the Hebrew-Canaanite *ḥērem*, or 'ban,' which was specially connected with war, we shall deal later. The noun-form *ḥaram* also meets us in Aramaic Nabataean inscriptions.¹ In these, *ḥaram* means something inviolable. Thus in an inscription on a tomb in el-Hejra the deities Dūsharā (properly 'owner of Sharā'), Manūthū, and Kaishah are invoked to bring a curse on any one who shall dispose of the tomb in any way or alter the inscription, 'for the sepulchre and its inscription are an inviolable object' (*ḥaram*). The same word is used to express what is sacred and inviolable in the inscription of Petra (CIS ii. 350), where the sepulchre and surrounding gardens and purlieus are called 'the consecrated and inviolable possession (חרם חרין) of Dūsharā, the god of our lord.'² Here *ḥaram* approximates the use of the same word in Arabic.

Another Arabic term of closely similar meaning is *ḥimā*, designating something forbidden or reserved, or, more properly, guarded or protected from intrusion.³ Thus we read of the *ḥimā* of Wajj attached to the sanctuary of Al-Lāt at Tāif, which was under stringent rules like the Polynesian tabu. 'If a woodcutter intruded on the *ḥimā* of Wajj, . . . he forfeited his hatchet and his clothes; if a man unlawfully grazed his cattle on the *ḥimā* of Jorash, the cattle were forfeit' (*Rel. Sem.*² 146). We find also that dress which was employed in ordinary life is distinct from dress worn in sacred functions. Accordingly, shoes or sandals soiled by travel were put off when the sacred enclosure, such as a mosque, was entered (cf. Ex 3⁵, Jos 5¹⁰). Clothes were either washed (in case of poor worshippers) or changed (Gn 35², Ex 19¹⁰). Even cattle which had strayed from outside into the *ḥimā* could not be reclaimed.

The opposed term to *kōdesh* in Heb. is *ḥōl*,⁴ properly that which is free or set loose for ordinary human use, in other words, not subject to the restrictions involved in holiness. In Lv 10¹⁰ the distinction is sharply drawn, and priests are exhorted to observe it as they would that between clean and unclean (cf. Ezk 22²⁶ 42²⁰ 44²³). This stringency of distinction became specially emphasized in the days of the Exile (Is 52¹¹), and still more in the days of Ezra, when laxity of usage required stern correction combined with strict rule. Without this the result would not probably have been 'the final extinction of Israel' (Travers Herford, *Pharisaism*, London, 1912, p. 10).

But this was only to accentuate a tradition that

¹ Respecting חרם in Aramaic inscriptions, both as verb and as substantive, see Lidzbarski, *Nord.-sem. Epigraph.*, Berlin, 1898, p. 280. The verb simply means 'to be holy'; the Aphel is used for 'consecrate.'

² See G. A. Cooke, *North Semit. Insc.*, Oxford, 1903, nos. 79 (lines 5-8), 94 (line 3); cf. Lagrange, 183.

³ حَمَى, Heb. חָמַם (root of חָמַם, 'wall'), meaning 'protect,' 'guard,' 'hinder.' Perhaps the fundamental meaning is 'to be hot with anger' (in defence of rights); cf. חָמַם, חָמַם, חָמַם (Lidzbarski).

⁴ Root חָלַל, Arabic حَلَلَ; the latter, being 'applied to the discharge (lit. the untying) of a vow, is the same which is regularly used of emergence from a state of taboo (the *ḥarām* . . .) into ordinary life' (*Rel. Sem.*², 492).

had its roots in the past. Theory and prescription, however, have to give way under the presence of practical necessities, and in the pre-Exilic period of Israel's life such cases must have frequently arisen. Originally the right of asylum (*q.v.*), even for stray or stolen cattle that passed within some *ḥimā*, or sacred enclosure, was pretty strictly enforced in primitive usage, as the story told by Wellhausen (*Reste*², 52, taken from the narratives of Ibn al-Kalbi) respecting Saifi, the priest of the deity al-Fals, who had stolen a milch-camel and detained it under the deity's protection, clearly shows. But this right was modified by the Hebrews. Justice could overtake a murderer, even though he took refuge in a sacred enclosure. Such asylum availed only in the case of accidental manslaughter (Ex 21^{12c}), and even in this case the asylum came to be limited to only a few selected spots (Dt 4⁴¹⁻⁴³ 19²⁻¹⁰, Jos 20²⁻⁹, Nu 35¹¹⁻¹⁵). Probably, as Robertson Smith suggests, the community of interest which subsisted between the people and its deity tended to mitigate rules which might otherwise have pressed with excessive severity on his worshippers. Thus the money stored in the sacred precincts of the temple of Ba'al-berith was even employed by Abimelech to hire a company of desperadoes (Jg 9⁴). In the textually difficult passage 1 S 21⁴⁻⁷ (see Driver and Budde, *ad loc.*), we read that in the lack of ordinary unconsecrated bread (לֶחֶם הַקֹּדֶשׁ) the holy bread that stood on the table before the Divine presence (לֶחֶם הַקֹּדֶשׁ in v.⁵ = לֶחֶם הַקֹּדֶשׁ in v.⁷) was distributed among David's starving followers by the priest. The fact that the distinction between *kōdesh* and *ḥōl* is here expressed, and that the priest endeavours to exact conditions of purity, points to the conclusion that we have a departure from ancient and normal custom (cf. Mk 2²⁶).

The distinction between *kōdesh* and *ḥōl* above indicated is obviously different from that between Divine property and human property, for it is the distinction between objects in the use of which there are severe restrictions, and objects which are free for ordinary human use. This idea of sacredness, involving restriction of use and danger accruing from its violation, was far more primitive than the conception and usage of property, though it may be admitted that the latter came afterwards to supervene.

It is not possible within the compass of this article to deal with all the ramifications into which the ancient conception of holiness extended among the Semites. It must suffice to classify their varied departments concisely under the following heads.

2. Holy things.—(a) *Places* which are invested with holiness are those in which the supernatural power and presence are supposed to be manifested. These elements of power and presence were often expressed in Semitic by the word *name* (see below under (k)). Hence a sanctuary was said in Hebrew parlance to be a spot (*par excellence* Jerusalem) in which God had 'put his name' (Ex 20²⁴, Dt 12⁵ 16⁵ 11 16 26², 1 K 8²⁹). Such a place would in Heb.-Canaanite be called *kōdesh* and be invested with the qualities of holiness and its restrictions. In the primitive life of the Arabian desert, from which it is generally held that the Semitic peoples emerged, the main physical characteristics associated with holy spots would be fertility, the spring arising from the soil and creating a verdant oasis of shading trees in the bare desert. These manifestations of a full vitality were ascribed to the presence of a supernatural Power who took up His abode there; and some portion, or even the whole, would be regarded as His sanctuary, and invested with the restrictions of holiness. Canaan abounded in such holy places. But there were other causes besides fertility which might invest a spot with special

sanctity as manifesting a Divine power and presence. Thus the sacred stone Eben-ezer was erected by Samuel at the place where Jahweh manifested His power in the defeat of the Philistines (1 S 7¹²). In the spot where God appeared in a dream to Jacob, the stone marked the spot, and oil was poured upon it (Gn 28¹¹⁻¹³), and the sanctuary was named Bêthêl.

Heaven is properly the abode of Jahweh, though He dwells with Israel in certain spots, especially on mountains. Hence the 'holy mountain' of Zion (Is 11⁹, Ps 15¹ 24⁸, Wis 9⁸). But from earliest times Jahweh was regarded as the atmospheric deity, and thus in later literature heaven, being His place of abode, is designated holy (Ps 20⁶, Wis 9¹⁰), and even came to be used as a substitute for the Divine name.

(b) As just indicated, any sacred spot separated off and surrounded by restrictions as to access and ordinary use (Ex 3⁵) would be marked by a stone, which served for an altar, on which the blood of the offered animal was sprinkled or smeared, and at the same time also as a symbol for the Divine presence. There can be no doubt that the *numen* of the deity was thought somehow to reside in the stone.¹ Hence the primitive objection to hewing the stone or in any way violating it by the application of a tool (Ex 20²⁵). Moreover, the smearing of the blood, which in the primitive form of worship was shed over the upright stone (Heb. *maš-šêbhah*, Arab. *nošb*), or over the heap of stones or cairn (such as the *gal'êdh* of Gn 31⁴⁶),² contains in itself a very clear indication that the sacred stone embodied the Divine presence, which was thereby made participator of the sacred meal or offering. Such a conception of sacrifice persisted into post-Exilic times and survives in its legislation (Lv 21¹⁷; cf. Mal 1⁷).

(c) The sacred *spring* was a frequent accompaniment of the sacred place. In fact, as Wellhausen remarks (*Reste*², 104), wherever human beings settled down by a sanctuary there must of necessity be water. Moreover, the fertile spot marked by the stone symbol would naturally possess a flowing spring arising from the mysterious water-depth (קְהוּם).

¹Of all inanimate things, that which has the best marked supernatural associations among the Semites is flowing (or, as the Hebrew says, "living") water. In one of the oldest fragments of Hebrew poetry (Nu 21¹⁷) the fountain is addressed as a living being (*Rel. Sem.*² 135).

Such a manifestation of life around which verdure spread and which was endowed with properties of cleansing, and in many cases with medicinal or healing virtues, sometimes regarded by the Arabs as inhabited by serpent *jinn*, obviously possessed a sacred character (cf. 2 K 5¹⁰⁻¹⁴). An interesting text of Anubanini, King of Lulubi, published by V. Scheil (*Textes élamites-sémitiques* [= vol. ii. of J. de Morgan's *Mémoires de la déléation en Perse*, Paris, 1901 ff.], 1st ser., p. 67, cited by Lagrange, 160), shows how seas and streams were endowed with personality and invoked:

'May the upper and lower sea of the abyss destroy his parents and his offspring.' Here the sea is invoked to work out a curse. In another case the waters of a river have the power to absolve or condemn: 'May the rivers Tigris and Euphrates, the canals Mekalkal, and the canals Ši-kut and Arahtum, dear to Marduk, deliver and absolve thee.' That such streams were regarded as 'holy' is clear from the third tablet of the Šurpu series published by Zimmern. To drink their water in an impure cup (col. i. 21), or to spit into or otherwise pollute the sacred stream (col. ii. 59 f.), was a crime from which priestly absolution through Marduk was needed.

The presence of the sacred spring in many of the holy places of ancient Israel is attested by such names as Be'er-Sheba', 'En-Mishpāt, and the holy stream issuing from the sanctuary in Ezekiel's

¹ So Robertson Smith and also Baudissin, in *ZDMG* lvii. (1903) 829; Lagrange, 194; and *HDB* iii. 879^b, footnote.

² On the occasion of the covenant-sacrifice between Jacob and Laban, cf. Jos 24²⁷.

vision (47¹⁻¹²). Also somewhere in the Negebh we may picture Hagar's Be'er-laḥai-rōi (Gn 21¹⁴⁻¹⁹).

(d) Another accompaniment of the sacred place was the sacred *tree*. That trees were endowed with supernatural life may be illustrated by numerous examples of primitive belief. This supernatural life would be suggested by the vitality of the tree itself and its fruit-producing capacity, whereby mankind is supported, or by its medicinal leafage (as in the case of the trees that grow on the banks of the sacred stream flowing from the sanctuary in Ezekiel's vision [47¹²]). In primitive Arab. religion certain trees were believed to be demon-haunted (Wellhausen, *Reste*², 105). The deity 'Uzzā was considered to dwell in one of three Samura trees at al-Naḥla, and on the track between Mecca and Medina there were many Samura and other sacred trees. With the worship of the date-palm at Najrān (*ib.* 104) we may compare the palm-tree of Deborah (Jg 4⁵). This subject is very extensive, and the reader may be referred to the treatment in Barton's *Semitic Origins*, 75-92. The special sanctity ascribed to the palm in Arabia is to be connected with its importance to man as furnishing sustenance both for himself and for his cattle. The traditional sanctity of trees passed into Islām, and Muhammad was held to have rested and prayed beneath the sacred trees between Mecca and Medina, just as Elijah rested and slept beneath the *rōthem* (Arab. *ratam*) tree and there received an angel visitant (1 K 19⁵). In Arabia and in Palestine such trees become *dhāt anwāt* wherever festivals are celebrated; and the boughs are laden with dedicatory offerings of clothes, weapons, or ostrich eggs. Among the ancient Hebrews, sacredness chiefly belonged to the terebinth. It frequently appears in the Abraham-narratives (Gn 13¹⁸ 14¹³ 18¹). By a terebinth tree the angel of Jahweh appeared to Gideon (Jg 6¹¹). We find several allusions to the fact that Divine communications were made in close connexion with terebinths. Thus we have the terebinth of the soothsayer (מִרְיָה) in Gn 12⁸ (cf. Jg 9³⁷, Dt 11³⁰); and in the syncretic worship of the high places incense was burned under its shade (Hos 4¹³), as well as under oaks and poplars.¹

(e) Out of the sacred tree arose the sacred symbol of the *stem* or *pole* standing near the altar, regarded as the symbol of the deity *Ashērah*, goddess of fertility and prosperity. The existence of this goddess was formerly doubted by Wellhausen, Robertson Smith, and others, who maintained that *Ashērah* designated only the sacred pole. But Assyriology has clearly demonstrated the existence of this goddess in the proper names Abd-Ašratum, Abd-Ašrati, and Abd-Aširti (A. Jeremias, *Das AT im Lichte des alten Orients*², Leipzig, 1906, p. 322, n. 1; *KAT*³, 432 f.). We might regard its rude representation in the pole fixed in the ground as a kind of roughly modelled ξόανον, or wooden image, of the goddess (Lagrange, 176), analogous to the *maššêbhah* (perhaps an approximate representation of the human figure).

(f) Holiness was naturally ascribed to the *apparatus* of worship, such as altar-bowls, cups, and other vessels of the sanctuary (Nu 3¹, 1 K 8⁴ מִכְסֵי הַקֶּדֶשׁ). It was also applied to materials with which consecration of persons was affected or with which it was accompanied, e.g. oil, water, the diadem, and, in general, the garments worn by the priest (Ex 28¹⁻⁴),² as well as to the offerings presented by the people, which were hallowed (Ex 28³⁸, Lv 22¹⁴⁻¹⁶). Any act of ritual inadvertence was a sin of pro-

¹ In ancient Egypt, on the other hand, the sycamore was regarded as sacred (see Maspero, *Histoire*, Paris, 1894-99, i. 121, and Gressmann, *Altoriental. Texte und Bilder*, Tübingen, 1909, ii. 47).

² In Aramaic we find the word *kedāshā*, ear- or nose-ring, regarded as an amulet with sacred devices or names.

fanation, which had to be borne by the officiating priest. An inevitable condition of the holiness of persons and things was that they must be *pure* or *clean*. We shall afterwards observe purity and holiness taken up into the ethical realm (Ps 24¹). Here all that it is necessary to note is that, though not identical, they come into close connexion.

Just as a woman unclean through child-birth could not enter the sanctuary (Lv 12⁴), so uncleanness in things was incompatible with their presence or employment in worship. According to the conceptions of the ancient Orient, demons and uncleanness, decay, disease, and dirt go together.¹ Over the preservation of the purity of holy things the sons of Levi had to watch (1 Ch 23²⁵). The sins of Israel were considered to affect the holy place and render it unclean. Consequently, on the great Day of Atonement, expiatory blood was sprinkled on the altar horns to cleanse the tent of meeting (Lv 16^{18, 19}). Similarly, in Ex 29^{38, 42} special sin-offerings of a slaughtered bullock were needed for 'cleansing' (properly 'unsinning,' Heb. כִּפָּר; see Driver, *ad loc.*) the altar. Cf. Lv 8^{15, 14, 49} (in ref. to a house contaminated with leprosy), Ezk 43^{20, 22, 23, 45, 18}. A high degree of sanctity belonged to holy vessels, so that any who touched one became affected by its magic circle of tabus, or, in the language of the original, 'became holy' (שִׁבְּרָה). According to Nu 4¹⁵, death might result from such contact. In this connexion we may note also that a special and necessary condition in the manufacture of sweet incense was that it should be pure (Baudissin, *Stud. zur sem. Rel.*, Leipzig, 1878, ii. 46 f.; Ex 30^{34, 35, 37, 20}).

(g) The sacredness of *certain animals*, such as the camel, ox, cow, horse, pig, mouse, etc., is an obscure subject discussed by Robertson Smith in *Rel. Sem.*², 271 ff. Probably not the same element, but varied elements, operated in various cases in determining the sacredness of an animal and the sacrosanct character of its flesh. It is just here that we come to one of those interesting meeting-points between the idea of uncleanness and the ideas of holiness and tabu. The *unclean* animal may not at ordinary times be sacrificed, because it is a *specially sacred animal* (*Rel. Sem.*² 290). It is only on specially solemn occasions—annual public celebrations or special crises—that such a sacrifice can take place. This may partake of the character of a mystic peculiar sacrament or ceremony. One operative cause that constitutes an animal sacred was held by Robertson Smith to be the fact that it was originally regarded as the totemic ancestor of the clan. Subsequent writers on this subject are disposed to abandon this view. Other reasons than totem ancestry are assigned by Benzinger.³ In the case of the pig it was holy as belonging to the Adonis-Tammuz legend, or it was sacred to Ninib (Zimmern, in *KAT*³, 409 f.). In other cases, as in that of the hare, magical or demonic powers were ascribed to it. The Arabs used the head and feet as charms (*Rel. Sem.*² 133). On the sacredness of the horse (cf. 2 K 23¹¹ in reference to sun-worship; *Rel. Sem.*² 293), the mouse (Is 66¹⁷), and the swine (65^{4, 66}), explanations will vary, since the motives are various. One operative element is suggested by Agatharchides (K. Müller, *Geographi graeci minores*, Paris, 1855, i. 153 f.) in his account of the troglodyte polyandrous nomads of E. Africa, who derived their whole sustenance from their flocks and herds. 'They gave the name of parent to no human being, but only to the ox and cow, the ram and ewe, from whom they had their nourishment.' We have already seen that the sacredness of the palm-tree is probably due to a like reason. 'The beasts are sacred and kindred beings, for they are the source of human life and subsistence. They are killed only in time of need, and the butchers are unclean, which implies that the slaughter was an

¹ Hence in Babylonian magic, fire and water are summoned to the magician's aid in expelling demons (see 'Magic,' in *HDB* iii. 209).

² *Heb. Archäol.*², Tübingen, 1907, p. 408 f. See the instructive note by Bertholet on Lv 11 (pp. 37-40), in which the varied motives and traditions of ancient and primitive races are set forth. While due weight is assigned to the theory of totemic ancestors as applied to Israel (p. 40), other causes, especially demonic and magic, are likewise admitted.

impious act' (*Rel. Sem.*² 296 f.). Owing to the polyandrous character of this nomadic people, the cow would be regarded as more sacred, since man is nourished by its milk, and kinship is also reckoned through woman.¹

(h) As certain portions of space were regarded as holy and subject to restrictions of human use, so also were *certain portions of time*. Certain holy seasons were regarded as belonging to or specially related to God, as were certain persons or things. Consequently human actions during these holy seasons were specially limited or conditioned.

Among the Babylonians, special importance belonged to the solemn festival held at the beginning of the year called *Zagmuku*, or in Assyrian *reš satti*, 'beginning of the year' (Heb. רֵאשִׁית שָׁנָה), which was synonymous with the feast of *Akitu*. It was a festival in which Marduk was carried in procession on a sacred barque, and Nabu proceeded from his temple in Borsippa to salute his father Marduk. On this sacred day—the Babylonian New Year's Day (i.e. 1st of Nisan)—the king performed the ceremony of 'taking hold of the hands of Bel (i.e. Marduk) and receiving from him royal authority.' In the light of this custom, it is highly significant that we read in the annals of Nabonidus that in the ninth year, one of national disaster, 'the king did not visit Babylon (Tintir-ki) in the month Nisan. Nabu went not to Babylon. Bel came not forth. The Akitu festival ceased' (*ba-til*). See Schrader, *KIB* iii. 130.

Among the early Semites the moon was determinative of the sacred days of the calendar. In the lunar month of 29½ days the sacred days were, as we learn from the pre-Exilic Heb. prophets (Am 8⁵, Hos 2¹³ [AV v. 11], Is 1¹³; cf. 2 K 4²³), the New-Moon and the Sabbath. The appearance of the new moon signalized the commencement of the month (cf. Sir 43⁶⁻⁸). Conjoined with the New-Moon, mention is made of the Sabbath. A remarkable list, discovered by Pinches (*PSBA*, 1904, p. 51 f.), places the significance of the Hebrew Sabbath in a somewhat new light. In Babylonian, *sapattu* is the name given to the 15th day of the moon, or beginning of the 3rd quarter, i.e. full moon. In the days of the Ptolemies, as we learn from an inscription at Narnaka (?)², the days on which the sacrifices were offered in Phœnicia were new-moon and full-moon.³ So also among the Hebrews the festivals of *Massôth* and *Sukkoth* began on 15th Nisan and Tishri respectively.

From these facts Meinhold has drawn a sweeping inference. He holds that in primitive Israel, down to the close of the Judaean Kingdom, Sabbath meant only the full-moon celebration. He regards Ezekiel as the originator of the sanctity of the Sabbath as a seventh day celebration (Ezk 46¹; cf. 20^{12, 13, 18, 20, 24, 22, 23}). But, if this be the case, it is difficult to see on what ground Ezekiel is justified in reproaching Israel for the non-observance of a *recent innovation* without the binding force of old usage. On the other hand, a variety of OT passages conducts us to the inevitable conclusion that the *seventh-day* Sabbath of a seven-days' week was an ancient pre-Exilic institution. For in Israel the sanctity of the number seven was evidently fundamental. We have it in the Niph'al form שָׁבַע, 'swear'; and in derivatives שָׁבַע, 'oath'; and in the name Be'er-sheba'. Moreover, the seventh day of rest was parallel to the seventh year of release in early legislation for the slave, and also for the field, which was to remain fallow (Ex 21^{2, 28}; cf. 34²¹).

(i) Various theories have been advanced for

¹ Cf. the statement of Herodotus (iv. 186) that the Libyans would not touch cows' flesh, though they ate that of oxen. Here, as in so many other cases, utility consciously or unconsciously co-operated in enforcing this abstinence from the flesh of so valuable and necessary an animal as the cow to a primitive nomadic race. Respecting sacred animals in ancient Egypt, see art. EGYPTIAN RELIGION, vol. v. p. 244 f., and especially Wiedemann, *Der Tierkult der alten Aegypter*, Leipzig, 1912.

² Von Landau, *Beiträge zur Altertumskunde des Orients*, ii. (Leipzig, 1899), 'Die phöniz. Inschriften,' no. 106, p. 46 f., cited in Benzinger, *Heb. Archäol.*², 389. But the reading is doubtful.

³ Special sanctity belonged to the Ethiopian moon-god, who is called significantly *Mahrem* (see Nielsen, in *ZDMG* lxxvi. (1912))

the sacredness of the number seven. Wellhausen (*Proleg.*², Berlin, 1883, p. 117) and others, who base the week or seven-day portions of the month merely on the moon phases, do not indicate a probable origin for the widely prevailing and firmly rooted tradition among the Semitic peoples (cf. *Rel. Sem.*² 181 f.) of the sacredness of the number seven. Without committing ourselves to Winckler's astral theories, we may agree that Schrader, Winckler, Zimmern(?), A. Jeremias, and Benzinger are justified in holding that the sacredness of the number seven is based on the seven planetary deities, including moon and sun. The order of these planetary deities in ancient Babylonia varies. Zimmern (*KAT*³ 623) says that the original order was: Moon (*Sin*), Sun (*Samaš*), Mercury (*Nabu*), Venus (*Istar-Dübat*), Mars (*Ninip*), Jupiter (*Marduk*), Saturn (*Kaimanu*). Probably the seven-branched golden candlestick in Zec 4²¹, with its seven lamps, which (v. 10) correspond to the seven eyes of Jahweh, is based on the seven planets of the celestial world.

The Hebrew Sabbath signified, according to its Hebrew etymology, that it was a sacred day, i.e. consecrated to Jahweh, in which ordinary human employments ceased (Gn 2²⁻³, Ex 20⁸⁻¹¹, etc.). In this sense the primitive Heb. Sabbath corresponded to the Bab. seventh day, which was more strictly beset with restrictions, like the Jewish post-Exilic Sabbath. The seventh day in Babylonia was sacred to *Kaim(v)anu*, or Saturn, the planet of evil fortune. This character attaches to the 7th, 14th, 21st, and 28th days of the Bab. month. We here cite the following from iv. Rawl. 32 respecting the 7th day of the month Elul. This 7th day was dedicated to Marduk and Sarpanitu^m:

'Evil day. The shepherd (=ruler) of the great nations shall not eat flesh roasted on coal, food brought into contact with fire (?); shall not change his coat, shall not put on clean garments; shall not pour out a drink offering; the king shall not mount the chariot; shall not . . . shall not announce any decision; in the place of secrecy the soothsayer shall not deliver an oracle. The physician shall not lay his hand on the sick one. For the discharge of business (the day) is not suited.'

Likewise on the day of full-moon Gudea (c. 3000 B.C.), in a tablet to which Winckler refers, makes the statement: 'The work of their (i.e. the workman's) hands ceased . . . no corpse was buried . . . no man who had a suit at law went to the place of the oath' (*Religionsgeschichtlicher und geschichtlicher Orient*, Leipzig, 1906, p. 61, cited by Benzinger in his *Heb. Archäol.*², 390).

In nomadic Arabia the *Hajj* corresponds to the sacred processions of the gods on their barques in the Bab. towns. The original *Hajj*, or pilgrimage to Mecca, was in the month Rajab, which corresponds to the Heb. Nisan. This, with traces of other early customs of Arabic heathendom, became adopted into those of Islām. But Ramadān became the most sacred month of the Muslim (Wellhausen, *Reste*², 79). The rule for the *hajjī* is that he must entirely abstain from secular employments and devote himself wholly to his religious duties. Similarly a '*šarah* in Hebrew is the time when man is under such restrictions' (Marti). Muḥammad's rule of conduct is stated in Qur. v. 96: 'O ye who believe, slay no game while ye are on a pilgrimage.' In fact, the restrictions as carried out by orthodox believers during this 'truce of God' are grotesque.¹ The thirty days' fast during Ramadān involves abstinence from food, drink, and intercourse with women, from sunrise to sunset. It 'kindles in Moslem spirits, even of the wild Arab, a new solemnity of religion' (C. M. Doughty, *Arabia Deserta*, Cambridge, 1888, i. 509). For it was during this month that Muḥammad retired for medita-

¹ See Sell, *Faith of Islam*², London, 1896, p. 291, and citation from *Ṣaḥīḥu'l-Būkhārī*, i. 458. The pilgrims are girded with the *iḥrām*, or 'pilgrims' loin-cloth, which covers them to the knee; and a lap may be cast over the shoulder. They are henceforth bare-headed and half-naked; and in this guise must every soul enter the sacred precincts' (Doughty, *Ar. Des.* ii. 479).

tion to the cave of Hirā, and the Qur'ān was sent down from the Seventh Heaven. Just as Rajab corresponded in time to the month Nisan, so Ramadān corresponded to Tishri, the seventh month of the ecclesiastical Bab.-Heb. calendar. We can hardly doubt that Jewish traditions of the great Day of Atonement (the 10th of the month) influenced Muḥammad's institution of the Ramadān.

Respecting Muḥarram, or the first month of the Muḥammadan year, and the mourning celebrations of the Shi'ah sect who commemorate the deaths of 'Alī and his two sons, Ḥasan and Ḥusain, see Sell, 306 f. For a graphic description of a Persian Tazi, see Arminius Vambéry, *Life and Adventures*, London, 1884, p. 68 f.

(j) *Certain operations or processes* were also invested with special sanctity. Among these may be mentioned the *sacrificial act*, of which the essential element is the shedding of blood. Without entering into the intricate problem as to the fundamental and primitive meaning of sacrifice (*q.v.*), which appears to have involved the conception of a blood-tie between the Deity and the worshipper,¹ there can be little question that the blood, which embodied life (Gn 9⁴, Lv 17^{11, 14}, Dt 12²³), was held to possess a magic potency. Doughty (i. 499) points out that it is the custom of the Arabs to slaughter a young sheep and smear the blood on camels and cattle as a protection. The recent researches of Westermarck in Morocco reveal that the blood of the slaughtered victim was believed to visit a curse on the object for whom the sacrifice was offered.² It is hardly possible to doubt that in the original form of the rite described in Exodus the smearing of the blood on the lintel and doorposts had special reference to the plague-demon (חַיָּה, Ex 12²³ [J]), over whom it possessed a magic power of arrest.³ Among the Greeks the solemn act of sacrifice was attended by the silence of the worshippers enjoined by the word *εὐφημείτε*, *favete linguis*. Iphigeneia, when led to sacrifice, is bound with the 'speechless might of gags' (*Æsch. Ag.* 239).

Respecting *vows*, special note should be taken of the *ḥayy*, of which we have a vivid example in 1 S 14²⁴, where Saul binds his warriors under oaths involving self-imposed curses not to eat or drink until the enemy is wholly destroyed. Another example meets us in Ac 23^{12, 21} (cf. Ps 132³⁴).⁴ The enactments concerning the vows of men and women were strict according to the late legislation in Nu 30, even in the case of rash vows (Lv 5⁴⁴). The special and extraordinary vows involving abstinence of the Nazirite are codified in Nu 6 (see *ICC*).

War presents an interesting example of a sacred mode of activity, based on the conception of the patron-deity of a State who is its war-god. For war, like other State enterprises, was undertaken under the sanction and direction of the patron-deity. Thus Sennacherib begins his description of his fourth campaign in his Prism-inscription, col. iii. 42: 'In my fourth campaign Ašur inspired me with confidence; then I summoned my mighty forces.' Ašurbanipal (in the Rassam cyl.) recites the names not only of Ašur but also of Sin, Samaš, Bel, Nabu, and Istar of Nineveh and also of Arbela. Istar was the Assyrian war-goddess. So also among Canaanites (acc. to Egyptian data) were Anat and Reshef. Similarly, on

¹ Robertson Smith, *Rel. Sem.*², 313 f.; Herod. iii. 8. 'The sacrifices eaten in fellowship in the desert . . . are as a calling of the Lord the Allgiver, in his guests, a mystical communion of their bread and salt with Him' (Doughty, i. 452).

² See his paper, 'The Influence of Magic on Social Relations,' in *Sociological Papers*, ii. (London, 1906) 160.

³ Haddon suggests that the demon in the more primitive form of the rite was supposed to consume the blood, and was thereby arrested or placated or diverted from his quest.

⁴ See art. 'Gelübde,' in *PRE*³.

the Stone of Mesha', it is the god of Moab, Chemosh, who says to Mesha': 'Go take Nebo against Israel' (line 14). Among the Hebrews, Jahweh Š'bhāōth, Jahweh of the celestial star-hosts as well as of Israel's armies (cf. Jg 5⁴⁻²⁰), goes before Israel in the ark carried into the battlefield (1 S 4³⁻⁶), and is consulted by the priest-soothsayer with the ephod before every military operation (1 S 14^{16, 19, 23, 30, 37}, 2 S 5²³). The Syrians had the same custom; for we read in the Annal-inscription of Ašurnasirpal (col. iii. 20) that in overcoming a hostile Syrian tribe the *barū*, or soothsayer-priest, who went at the head of their host (*alik pan ummanātisunu*), was captured. Like other Semites, the Hebrews inaugurated war by sacrifices. This was said to 'consecrate' war (עָרַף מִקְרָב, Mic 3⁵, Jer 6⁴, cf. Jos 3⁵); hence the burnt-offerings at the opening of a campaign (Jg 6^{20, 26}, 1 S 7^{9, 13}, cf. 1 S 11⁷). With this conception of holy war and consecrated warriors (Is 13⁹) we must connect the sexual abstinence which was maintained during military expeditions among Hebrews and Arabs (*Rel. Sem.*² 455; cf. 1 S 21⁵, 2 S 11¹⁰). With this we must also associate the gruesome custom of the 'ban' (בָּרָא), which surrounded all objects, animate and inanimate, captured in war, and forbade their appropriation to human uses. This meant the wholesale destruction of the 'devoted' objects expressed by the denominative Hiph'il of the same root *h-r-m* (see p. 753^a); cf. Jos 6^{17, 21}, Jg 21¹², 1 S 15⁷⁻²³, in which v.¹⁸ is a close parallel to the Stone of Mesha', lines 14 f., 32. In the latter case Mesha' devotes to Aštar-kemōsh (line 17, הַחַיִּים) the entire population of Nebo, both men and women.¹

(k) The sacred name of Deity had a special and awful potency, since in ancient Semitic conceptions it involved the actual presence and personal power of the Deity, which, when the name was uttered, were summoned into active exercise. Thus the tetragrammaton (יהוה) was too awful for pronunciation by ordinary human lips, according to the usage of post-Exilic Judaism. We know that in the 3rd cent. B.C. it was avoided in the public reading of the Hebrew Torah, יְהוָה, reproduced in the LXX by κύριος, being substituted for it. Even the combinations ה' and י', though abbreviations of the sacred name, came to be avoided as numerical signs of 15, 16 (ו and ט being respectively substituted). On the use of the Divine names and those of the Hebrew patriarchs in exorcisms, and generally in magical formulæ, see artt. 'Exorcism' and 'Sorcery,' in *HDB* i. 812, iv. 604; Conybeare, in *Trans. of the Third Internat. Congress for Hist. of Relig.*, Oxford, 1908, ii. 358 ff. The wide prevalence of the potency of sacred names in Bab. incantations needs only to be mentioned here.

3. Holy persons.—(i.) Chief among these were the priests. In Ex 29, Lv 8⁹, elaborate details of the rites of initiation are given whereby priests are installed in their office. In these rites we shall merely note (1) the washing of the person with water (Ex 29⁴; cf. washing the garments in Ex 19^{11, 14} at Sinai); (2) splashing bullocks' and rams' blood on the altar-horns and round about it (vv.^{10, 16}), the ram's blood being placed on the right ear, toe, and thumb of the Aaronids (v.²⁰); (3) special garments and 'holy crown' (v.⁶); (4) anointing with oil (v.⁷). The fundamental conception underlying these ceremonial cleansing operations (washing and blood-sprinkling) is to remove all contamination which would disqualify the priest for his sacred functions. These functions are defined in Nu 18²⁴ as the keeping of the tent of meeting, the handling of the holy vessels, and the approach to the altar. In the later Heb. legislation, which has just been

¹ A further treatment will be found in art. 'War,' in *EBi*, § 2, and F. Schwally, *Sem. Kriegsaltertümer*, Leipzig, 1901.

quoted, these functions belonged to the sons of Aaron. It is, however, fully recognized that the substance of P's ceremonial legislation is very ancient; and, if we possessed fuller documentary material from ancient Babylonia, we should probably be able to show a larger number of close parallels between the ceremonies of initiation for the Babylonian priesthood and those contained in P than have yet come to light. Several interesting and important analogies may nevertheless be noted.

(a) The king (*q.v.*), like the priest, was anointed with oil (שָׁחַט). Anointing (*q.v.*) doubtless arose from the ancient magical custom of smearing or pouring unguent on the body to endow the subject with certain qualities. Thus the Arabs of E. Africa believe that lion's fat inspires a man with boldness, so that a wild beast flees from him (see *GB*² ii. 364 f.). From the Tell el-Amarna tablets we learn that the custom of anointing kings prevailed in Western Asia in the 15th cent. B.C. In a letter from Adad-nirāri, king of Nuḥašši in N. Syria, addressed to the king of Egypt (Schrader, *KIB* v. no. 37), it is stated that a previous Egyptian king had poured oil on the head of the writer's grandfather and established him as king. Frazer's *GB*² i. 137-156, and his *Lectures on the Early History of the Kingship* (London, 1905), have familiarized us with the supernatural endowments attributed to the early king, who was regarded as a deity or quasi-deity. Israel similarly stood in awe of the 'Lord's anointed,' whose person, like that of a priest, was sacrosanct (1 S 24^{6, 10}, 2 S 1¹⁴). The Assyrian king called himself the offspring or favourite of a god (*binutu Ašur, naram Šin*). Moreover, the king assumed priestly functions. This we know to have been done by David (2 S 6¹⁷) and Solomon (1 K 8⁶³). This was also the tradition in Assyria. Tiglath-Pileser I. (1100 B.C.) calls himself *išippu*, or priest, of the god Šamaš. Sargon calls himself the *saknu*, or vicegerent of Bēl, and the *išakku*, or chief priest, of Ašur.

(b) Physical defects were disqualifications for a Hebrew priest and also for a Bab. soothsayer (cf. Lv 21¹⁷⁻²³). Among the Babylonians, squinting (*saktu enā*), lack of teeth (*hepu sinnā*), and a maimed finger (*nakpi ubani*) were accounted disqualifications (H. Zimmern, *Beiträge*, Leipzig, 1896-1901, p. 87).

(c) As the Aaronic priesthood was hereditary, similarly the Bab. *barūtu*, or office of soothsayer, belonged to a sacred hereditary caste whose functions involved special mysteries of knowledge (*e.g.* inspection of the liver). This tradition can easily be traced back as far as the time of Hammurabi (c. 2100 B.C.; see Zimmern, 82 f., 87).

(d) In the ritual tablets of the *asipu*, or priest-magician, who dealt in conjurations (*siptu*) whereby diseases were removed, or in expiations whereby sins were atoned, we read (Zimmern, no. 26, col. iii. 19 f.) that the *mašmašu* (who held an office closely allied to that of the *asipu*) (Zimmern, p. 93) is to pass forth to the gateway, sacrifice a sheep in the palace-portal, and smear the threshold and posts of the gateway right and left with its blood (cf. Ex 12⁷ [P]). Respecting these incantation-rituals and the multiplicity of the sacred offices, see Zimmern, *Beiträge*, and the art. 'Priest,' in *EBr*¹¹. Israel also in pre-Exilic days had the *ro'eh*, *kōsem*, *m'ōnēn*, *yidd'ōnt*, and *ba'al obh*. Others are obscurely mentioned in Dt 18^{10, 11}.

In early times the priest in Israel was essentially soothsayer, who declared the Divine will by Ūrīm and Tummīm, rods, arrows, or other forms of the sacred lot. Carrying the ephod, he gave the answers needed on any expedition. In early Arabia the *kāhin* (Heb. קָהֵן) was the soothsayer who employed the divining rods or arrows, denounced by Muḥammad as an abominable work of

Satan (Qur. v. 92; cf. Mic 5¹², Jer 27⁹). Cf. art. 'Soothsayer,' in *HBD* iv. 598.

In later times the priestly function in Israel became chiefly ceremonial and sacrificial, while the function of soothsayer (*kōsēm*, etc.) was separate and specialized. Out of the priest-seer of early times, called *rō'eh*, emerged the prophet (*nābhī'*), whose person as 'man of God' was also sacred, whose rod possessed magical power (2 K 4²⁹⁻³¹) as well as his garment (2 K 2¹⁴; cf. Mk 5²⁷⁻³¹), on whom God's spirit rested, and to whom 'the word of the Lord' came. See art. 'Prophet,' in *EBR*¹¹.

One of the most primitive and significant as well as non-ethical among 'holy' persons of the Semitic peoples was the *kādēsh* (sodomite priest attendant) and the *k'dēshāh*, or priestess-prostitute, who infested the Canaanite-Hebrew sanctuaries like the corresponding *kadistu* and *harimtu* of Babylonia. The wide prevalence of this phase of ancient Semitic life is attested by Gn 38^{21f.}, 1 K 14²⁴ 15¹² 22⁴⁶, 2 K 23⁷, Am 2⁷, Hos 4¹¹, Dt 23¹⁷ [Heb. 18], and is especially connected with the Istar cult (G. A. Barton, *Sem. Origins*, London, 1902, p. 83; N. Nilsson, *Etudes sur le culte d'Ichtar*, Leipzig, Paris, and St. Petersburg, 1911; see, further, *HIERODOULOI* [Sem. and Egypt.]).

(ii.) We have represented in Israel the conception of a *holy people*. Of this the *locus classicus* is Ex 19⁵⁻⁶ (JĒ), in which the privilege is made conditional on obedience to the terms of the Sinai-covenant. Israel is called a Divine possession above all the peoples of the world. But this was in reality the re-assertion of a long recognized fact. Israel was Jahweh's people, just as the Moabites were 'people of Chemosh' (cf. Jg 5¹¹, Ex 15¹⁶). Israelites as individuals were just as truly sons and daughters of Jahweh. Similarly Palestine, the land occupied by Jahweh's people, was holy also (cf. Wis 12⁸), and is called Jahweh's house (Hos 8¹ 9¹⁵, cf. 9³ and Harper in *ICC*). All sacrifices outside Jahweh's land are, therefore, unclean. The corollary to this conception of Israel as a holy people is found in the prohibition of marriage with foreign races prescribed by later legislation (Dt 7³). This became rigorously applied in the days of Ezra, who sternly repressed such connexions, whereby the 'holy seed' became 'mingled' and thus contaminated (Ezr 9²⁴).

II. *THE CONCEPTION OF HOLINESS RAISED TO AN ETHICAL LEVEL.*—We have hitherto traced, though only in outline, the far-reaching dominion of the conception of holiness in its earlier stage, over a wide extent of persons, material objects, and modes of human activity. In all of these holiness appears as a positive quality derived from close contact with a Deity or supernatural power which becomes deterrent and restrictive, circumscribing human activities which are free as to ordinary or non-holy objects. Holiness in primitive religion, like much else, is concrete and quasi-physical, and, moreover, is bound up with magical elements of tabu. We have now to investigate how in its more advanced stage it became gradually and partially emancipated from the material and magical characteristics of primitive religion as it became ethicized.

Holiness, as we have seen, is closely associated with the personality of Deity. That which is brought most closely into contact with Him is most holy of all. Thus the hindermost recess of the Temple (קֹדֶשׁ, *naōs*), where His presence dwelt and where only the high priest on the most sacred day of the post-Exilic calendar (the Day of Atonement) could enter, was called the Sanctuary *par excellence*, the most holy place (קֹדֶשׁ הַקֹּדְשִׁים). Accordingly, sanctity, with all its associated elements of restriction and reserve, admitted of degrees until at length we come to the Deity Himself, who in His exalted and inaccessible loneliness and power is called by the thrice repeated and so emphasized

'Holy' in Isaiah 6³. The same principle that applied to things would *a fortiori* apply to God Himself. If eating the remainder of the *sh'lamim* (rendered 'peace-offerings'), which should be burnt on the third day, was an act of profanation because it was God's 'holy thing' (Lv 19⁸), it was a far more terrible thing to behold God Himself. No man can behold God and live (Ex 33²⁰; cf. Jg 13²², Is 6⁵). The quality in the Deity which avenged with terrible penalties all violations of His presence, dignity, name, or belongings was called 'jealousy,' and He was accordingly designated 'a jealous God' (אֱלֹהֵינוּ לֵא, Ex 20⁵ 34¹⁴).

God's position of inviolable supremacy and power was designated by this term שָׁקֵט, and He Himself was שָׁקֵט, 'holy.' But in His external self-manifestation He was invested with 'glory' (קְבוֹד). These two characteristics of Divine personality—'glory' and 'holiness'—are closely combined; but with this distinction, that, while 'holiness' marks out His inaccessible exaltation and power, which are restrictive on human activities, His 'glory' exhibits Him in His earthly and visible self-manifestation (Is 6³; Baudissin, *Stud. zur sem. Religionsgesch.* ii. 82, 104-107).

The prophets, who were the great teachers of Israel, did not in any degree diminish, but rather exalted, these conceptions of Jahweh's unapproachable and terrible power and His manifested grandeur. The universality of His sovereignty and power is emphasized by Amos, by Isaiah, and above all by Deutero-Isaiah (Am 9⁷, Is 6³ 40¹²⁻²⁶). But the teaching of the 8th cent. Judæan prophets did not end here. The stress which Amos and Isaiah placed on the righteousness of Jahweh and His ethical requirements (Am 5⁶⁻¹¹, 21-27, Is 1¹⁰⁻¹⁷, 21-23 5⁸⁻²³) shifted the centre of gravity in religion from ceremonial to conduct. Ceremonial tabus and sacrificial forms count for little. In Jeremiah's teaching the externalities of Israel's formal religion have disappeared with the destruction of the State and the Temple. Jahweh has established a 'new covenant' with His people independent of external ordinances and enactments, for it is internal, spiritual, and personal: 'I will put my law within them, and in their heart will I write it' (Jer 31³¹⁻³³).

The effect of all this was far-reaching, and it gradually brought about an 'Umwertung aller Werte'—a transmutation of all values, which affected the conception of the Divine Holiness and all related thereto. Since God's character and demands were essentially expressed in righteousness, this permeated also the essence of holiness whether in God or man. The fast wherewith a man is to afflict his soul is to set the oppressed free and bestow bread on the hungry (Is 58^{6f.}). 'Rend your heart, and not your garments' (Jl 2¹³). This affected the language, not only of prophecy, but of legislation. Circumcision was to be of the heart (mind), and not of the flesh only (Dt 10¹⁶ 30⁶). It entered even into the priestly legislation of the guilt-offering (Lv 5¹⁻⁷), and in the 'Code of Holiness' finds its due place (25³⁵⁻⁵⁵). This was doubtless a reinforcement of ethical elements which belonged to Israel's old religion, since all religion involves social relations and a social order, and therefore these elements found a place in the older codes of legislation. But prophetic teaching gave them a new and primary importance, and they came to displace the externalities of ceremonial religion. This is manifest in some of the Psalms, e.g. 50⁹⁻¹⁵, where sacrifices are repudiated as irrational; 51¹²⁻¹⁹, where the true sacrifices are a broken and contrite heart. Perhaps the most notable expression is to be found in Ps 15 (which reflects the spirit of Mic 6⁷⁻⁸): 'Who shall dwell in thy holy hill? He that walketh uprightly, and worketh righteousness, and is faithful in his thoughts [and not merely in

external acts]. The following verses expound this fundamental conception. Cf. Ps 24³², Sir 35²⁻⁸, 12-17.*

We have entered here into a higher realm and atmosphere, and these new conceptions would be fostered by the new conditions of post-Exilic Judaism, when there was a vast Diaspora, and the Synagogue with its worship took the place of the national Temple with its sacrificial ceremonial. Consequently prayer (which in some form accompanied sacrifice) now took the place of sacrificial ceremonial (which was legitimate only in the central Jerusalem sanctuary).

Moreover, we now find a tendency to shift 'holy,' which was ethical, from non-ethical things to personal objects, to which it can more properly apply. God in Deutero-Isaiah is 'Israel's Holy one' *par excellence*. Purity is closely associated with holiness, and has moral values. In Hab 1¹²⁻¹³ 'holy' is applied to Jahweh in His ethical purity, which is so great that He cannot behold evil—an echo of Is 6³⁻⁷. From these ethical conceptions of God's holiness it is but a step to the conception of God's 'Holy Spirit' (Is 63¹⁰, Ps 51¹³, Wis 9¹⁷). Those who form God's retinue, the angels, are called 'holy ones,' since they are the 'sons of God' (Job 5¹ 15¹⁵, cf. Ps 89⁶⁻⁸).

Nevertheless, the old and primitive non-ethical ideas of holiness still held sway and persisted in post-Exilic Judaism. They permeated Ezekiel's ideal scheme (chs. 40-48) of Israel's restored commonwealth, and the subsequent Levitical legislation. We even find them in the Mishna (*Yad*. iii. 2. 4 f., iv. 5. 6; cf. *Eduyyôth* v. 3), where it is stated that the canonical Holy Scriptures 'defile the hands,' according to the teaching of the schools of both Hillel and Shammai. In other words, this holiness thereby becomes contagious (Weber, *Jüd. Theol.*², Leipzig, 1897, § 21. 1). Texts from these inspired Holy Scriptures are still employed by Jews as magical charms and prophylactics, just as verses from the Qur'an are used among Muslims. See artt. 'Demon,' 'Magic,' 'Sorcery,' in *HDB*. In fact, the Arabic language of the Qur'an is sacred, and any translation into another tongue is a violation of that sanctity (Sell, *Faith of Islam*², 265, 301-305). Among peasants in the inland regions of Syria, both Christianity and Islâm are but a thin veneer over forms which are essentially those of ancient Canaan. Ethical monotheism is not the dominant religious influence, but a belief in the local *nabi* (whose tomb is sacred), or the local *wali* and *jinn*, who are merely substitutes for the former gods and demons.

What, however, unites the most primitive ideas of holiness to the later and modern conceptions, which are ethical, is the fundamental principle of close union and association with the Divine. This is common to the present and the hoary past. Whatever is deemed incompatible with such association is necessarily excluded. Holiness, therefore, will always be restrictive, and jealously close its doors to all forms of human action which are held not to be in harmony with this fundamental principle. And with holiness so restrictive and secluded there is also involved a positive element of Divine power.

LITERATURE.—The dissertation on 'Holiness' by W. W. Baudissin, in his *Studien zur sem. Religionsgesch.*, pt. II., Leipzig, 1878, still remains a very valuable treatment, especially from the standpoint of OT usage. A useful list of earlier literature is given on p. 3f. Valuable material respecting Arabic heathendom may be gathered from J. Wellhausen, *Reste arab. Heidentums*, Berlin, 1887 (21897). W. Robertson Smith's *Religion of the Semites*² (London and Edinb. 1894) is still the best contribution to the subject, especially owing to its

* In the face of Bertholet's extreme statement that *kôdesh* and *kadosh* are nowhere to be found in the Psalter in the special sense of moral holiness (*Bibl. Theol. des AT*, Tübingen, 1912, II. 249, footnote), it is at least obvious from Ps 16 and 51¹³ that an ethical as well as ceremonial connotation is implied.

full presentations of Arabic illustrative materials as well as those derived from the wider field of the comparative study of religion. M. J. Lagrange's *Études sur les religions sémitiques*², Paris, 1905, esp. chs. iv.-viii., contains a mine of well-sifted material in which the results of Assyriology find their due place. In addition to these, J. Skinner's art. 'Holiness,' in *HDB*, and R. Kittel's 'Heiligkeit Gottes im AT,' in *PRE³*, should be consulted. Among commentaries, see G. Buchanan Gray, 'Numbers' (*ICC*, Edinburgh, 1903), and A. Bertholet, 'Leviticus' (*Kurzer Handkommentar*, Tübingen, 1901) (see esp. on ch. 11); K. Marti, *Geschichte der israelitischen Religion*⁴, Strassburg, 1903, §§ 9-11; B. Stade, *Biblische Theologie des AT*, Tübingen, 1905, I. §§ 46-70. Cf. also the other works cited in the course of the article. OWEN C. WHITEHOUSE.

HOLY ORDERS.—See MINISTRY.

HOLY PLACES.—See PLACES.

HOLY SPIRIT.—See SPIRIT, HOLY.

HOLY WATER.—See WATER.

HOLY WEEK.—See FESTIVALS AND FASTS (Christian).

HOME.—The word (see *OED*, *s.v.*) signifies 'a dwelling-place,' regarded from the moral and the social point of view as the *fixed residence* of a family, providing for its members a place of refuge from the labour and turmoil of active life, and cherished as the abode of those to whom a man is bound by the closest and most intimate ties of relationship. The ideas which the word suggests are, accordingly, those of *permanence, security, familiarity*. To be 'at home' implies that a man has reached, at least for a time, the end of his wanderings (cf. Pr 27⁸); that he is beyond the reach of the perils of wayfaring; that he is no longer a stranger and foreigner, but a member of a household, surrounded by those who understand him and sympathize with him. When, for example, St. Paul speaks of the Gentiles as *olkeioi tou theou* (Eph 2¹⁹), he is contrasting their former outcast and alienated condition with the privileges of membership in God's family or household. Under all the aspects mentioned above, death is sometimes spoken of as 'going home' (cf. Ec 12⁵ 'long home,' with Plumptre's note), and the disembodied state is described by St. Paul as the being 'at home with the Lord' (2 Co 5⁸).

There were, doubtless, numerous instances of beautiful domestic life among the Hebrews. The narratives (J and E) of the 9th and 8th centuries B.C. throw much incidental light on the family life of ancient Israel. There was apparently a tendency (except in the case of the monarch) towards monogamy; and, though paternal authority was absolute, and extended to the *jus necis*, we do not find instances of harsh or unjust treatment. The same remark applies to slaves. They were the private property of their masters, but despotic rights do not seem to have been as a rule abused. The duties of hospitality were held in honour, and guests were welcomed with kindness and liberality. The Book of Proverbs illustrates the high esteem in which family life and family duties were held in ancient Israel. As regards the later Judaism it has been said that 'there were no homes like those in Israel,' and two familiar Talmudical sayings are probably the fruit of common experience: 'Marriages are made in heaven,' and 'God dwells in a pure and loving home' (see A. Edersheim, *Life and Times of Jesus the Messiah*, London, 1883, bk. II. ch. 9, and *JE*, *s.v.* 'Family and Family Life'). To a smaller extent the feeling for 'home' may be traced in classical antiquity (see, for instance, Hom. *Od.*, *passim*; Soph. *Ajax*, 850-860, *Phil.* 492-496; Ovid, *Trist.* III. 4. 53 ff.; Virg. *Ecl.* I.; Tib. *Eleg.* I. 1; Plin. *Epp.*, etc.; cf. S. Dill, *Roman Society from Nero to M. Aurelius*, London,

1904, p. 188 f.; and, for the witness of Latin inscriptions, etc., see hints in C. Bigg, *The Church's Task under the Roman Empire*, Oxford, 1905, Lect. 4), and also in India (cf. the statement of the *Pañchatantra*, v. 49, that even heaven is not so precious as one's birthplace, however humble it may be; see, further, Böhtlingk, *Ind. Sprüche*², Leipzig, 1870-73, nos. 1013, 1943, 6048, 6939); but it has been said with truth that

'home is specially Teutonic, word and thing. . . . The life of home has become the great possession, the great delight, the great social achievement of our race; its refuge from the storms and darkness without, an ample compensation to us for so much that we want of the social brilliancy and enjoyment of our Latin brethren. Reverence for the household and for household life, a high sense of its duties, a keen relish for its pleasures, this has been a strength to German society amid much to unsettle it' (R. W. Church, *The Gifts of Civilisation*, new ed., London, 1880, p. 336 ff.).

In England the new conception of life which Puritanism introduced tended powerfully to raise the standard of family life.

'Home, as we conceive it now, was the creation of the Puritan. . . . The sense of spiritual fellowship gave a new tenderness and refinement to the common family affections' (J. R. Green, *Hist. of the English People*, London, 1880, iii. 19).

So Emerson, writing in 1847, testifies that 'domesticity is the taproot which enables the [English] nation to branch wide and high. The motive and end of their trade and empire is to guard the independence and privacy of their homes' (*English Traits*, London, 1856, ch. vi.).

The special development, then, of the home-forming tendency seems to be characteristic of the Teutonic race; but it is a common human instinct, and, as such, finds its peculiar consecration in the gospel. Naturally, the spread of Christianity in the pagan world was responsible for many tragedies of domestic life. Christ's own words foreshadow the strain upon affection and conscience which would inevitably follow conversion (Mt 10^{21, 34-37}), and such a passage as 1 Co 7^{10a} indicates one class of problems that was bound to arise. In early Christian documents we read of wives embracing Christianity and refusing to live with their husbands (e.g., *Just. Apol.* ii. 2; cf. *Eus. HE* iv. 17); in the persecutions, frequent instances are recorded of parents pleading with their children, and children with their parents; of sons disowned by their fathers, and slaves by their masters; of wives divorced, and children disinherited (see Harnack, *Expansion of Christianity*, Eng. tr., London, 1904, bk iii. ch. 2, for references). But, where the gospel had free course, it issued in the consecration and elevation of family life—a fact of which the Apologists supply ample evidence.

The fundamental weakness of family life in Roman society was the exaggerated idea of the *patria potestas*. Domestic duty, it has been well said, was summed up in a single article—that of absolute submission to the head of the household. It was only by a very gradual process that the wife rose from being the chattel and slave to be the equal of her husband. Filial affection was the rarest of virtues under a system which placed the son at the absolute disposal, and under the despotic control, of his father. In the early centuries of the Empire, various reforms tended to mitigate this state of things. Not only the sons, but the slaves, of the Roman householder found their position improved by a series of legislative reforms (see Lecky, *Hist. of Europ. Morals*, London, 1869, i. 297 ff.). But, as has been pointed out, the moral consecration of family life was the special task of Christianity.

This consecration may be said to begin with our Lord's subjection to the discipline of home life at Nazareth (Lk 2⁵¹) and with His readiness to hallow family life by His presence and blessing (see Jn 2^{1a}, 11^{1a}, Lk 10^{38a}). In his letters to the churches of Asia (Eph., Col., Philem.), St. Paul deals with the leading principles of home life in some detail, possibly because 'in the social traditions of "Asia" a certain prominence appears to have attached to

the family idea' (H. C. G. Moule, *Colossian Studies*, London, 1898, p. 231 f.). Each natural relationship—that of husband and wife, that of parent and child, that of master and servant—is exhibited in the light of the Christian ideal. The teaching of 1 P 2¹⁸⁻³⁷ is similar in its tone, and is addressed to readers of the same race. Perhaps the leading idea of St. Peter is that the gospel confirms and sanctifies the element of order and subordination which lies at the root of stable social life. Both to wives and to servants he preaches the duty of 'subjection.' St. Paul's precepts (Eph. *l.c.*) seem also to apply, in the region of family life, the general duty of mutual submission (Eph 5²¹); but he lays more stress on the principle of active love which subordinates self to the service of others. Both teachers appear to regard the family or home as the appointed sphere of moral discipline and probation for the great majority of mankind, and St. Paul derives its sanctity from the fact that it reflects the mysterious relationships which subsist within the very being of Deity itself (cf. Eph 3¹⁵ 5^{22a}). It should also be remembered that to the mind of our Lord Himself the family presents the closest analogy to the new social order which it was His mission to reveal. God is the Father of a family; mankind are His children, and all are 'brethren' (Mt 23⁸⁻¹⁰; cf. the use of ἀδελφοί, ἀδελφότης in the Epp., and see Harnack, *op. cit.* bk. iii. ch. 3). In such early documents as Clem. *ad Cor.* 1, Polyc. *ad Phil.* 4, we find echoes of this line of teaching and proofs of its actual influence.

It does not fall within the scope of a short article to deal with the social and economic tendencies, or the moral and scientific theories, which threaten the Christian home. It may suffice to point out that the purity and sanctity of Jewish homes was mainly due to the prevailing regard for the chastity of woman, and that, where there is any lowering of standard in this particular, the institution of home is threatened. In Rome the growth of moral corruption, avarice, the love of ease, and extravagance led directly to the aversion for marriage, the perilous consequences of which Augustus strove to avoid by direct and drastic legislation (see Marquardt, *Das Privatleben der Römer*, Leipzig, 1879, p. 71 ff.). The rise of monachism and the passion for cœnobite and solitary life became the occasion of vehement and one-sided disparagement of family duties and the frequent rupture of family ties (see Lecky, *op. cit.* ii. 125). Nor can it be denied that the institution of family life is threatened in modern times by a spirit of individualistic selfishness which prefers the comparative freedom and ease of a celibate life to the duties and responsibilities involved in marriage. But, apart from considerations of this kind, we may observe that the possibility of home life, as contemplated by the NT writers, depends to some extent upon conditions which can no longer be taken for granted. The problem of the family is closely connected with the modern problem presented by the aggregation of masses of people in large cities; and it is certain that deep-seated industrial causes are tending to undermine and break up family life. To a large proportion of the working classes in Europe and America, anything like home life in its highest form is virtually prohibited by the conditions amid which they pass their lives. A further danger which threatens home life is involved in defective and unspiritual ideas of what constitutes true human well-being. It is the obvious duty of the Christian Church to encourage any corrective tendencies, any social endeavours, which make for the integrity and purity of family life. What has been called 'the battle with the slum' is a real contribution to the family problem; and all Christians are bound to take an interest in any scheme for the better

housing of the poor, multiplication of suburban homes, improved sanitation, etc. (on this subject, see F. G. Peabody, *Jesus Christ and the Social Question*, London, 1901, ch. iii.). Further, family life is threatened by certain socialistic theories, which find in the family an insuperable obstacle to their cherished ideal of a corporate life in which personal interests are to be sacrificed to the welfare of the community. Such theories regard marriage and the family as a stronghold of individualism, hindering the citizen from 'complete devotion to the socialist ideal' (Peabody, *op. cit.* p. 140 ff.). On the other hand, the tendency of anthropological speculation seems to be in the direction of vindicating against socialistic attacks the permanent function of the family, regarded as the highest result of the historic process of social evolution. And, again, if it is true that the individual finds his true self-development in subordination to or co-operation with his fellows, if corporate life is in reality the great instrument for training character, it is obvious that the family has higher social significance than was once perceived. Home life is the fundamental form which life in common can assume. It involves precisely that training in social affections, that discipline in self-sacrifice and mutual service, which corresponds most closely to the Christian conception of worthy human life.

'The family exhibits in the simplest and most unquestionable types the laws of dependence and trust, of authority and obedience, of obligation and helpfulness by which every form of true activity is regulated. . . . In the family we learn to set aside the conception of right and to place in its stead the conception of duty, which alone can give stable peace to peoples or to men' (B. F. Westcott, *Social Aspects of Christianity*, London, 1887, Lect. II.).

The gospel, then, gives a complete and final sanction to the institution of home. In the home, —'Charity begins at home'—Christianity finds the needful conditions for training men in the highest and most Christ-like of all graces (1 Co 13). In the home, character is trained and ripened for the wider service of man that lies beyond and outside its range. By a round of common duties and mutual services, men and women are educated for the larger ministries of citizenship and churchmanship. Thus the gospel transfigures the home by treating it as the ultimate type of the new society which Christ came to establish on earth. God is a heavenly Father; men are His children, linked to each other by ties of brotherhood; the Church is His household (1 Ti 3¹⁵), in which all have their mutual duties and peculiar calling, and all alike are dependent on the Father's gifts of grace (Mt 23³⁵, 1 Co 12²⁵, Eph 4 and 5). So St. Paul enjoins Timothy to treat those committed to his pastoral charge as relatives of the corresponding age—the aged men as fathers, the elder women as mothers, the young men and women as brothers and sisters (1 Ti 5¹⁵). Again, it is noticeable that the gospel does not multiply directions in regard to the Christian's conduct in the larger spheres of human life—the world of business, of politics, of professional life. It confines itself to regulating family life with special minuteness and care; nor does it attempt so much to safeguard the rights of individuals as to enforce their duties. Thus, in Eph. and Col., St. Paul gives a summary of the simple but far-reaching rules which should control home life. He addresses in turn husbands, wives, children, and servants—that is, all members of the typical household. Each in his turn is exhorted to bear in mind his or her duties and the rightful claims of others, and thus there emerge the great principles that give to home life its sacredness and importance.

(i.) There must be before all else *the fear of God*, the root and ground of Christian life with all its manifold relationships; the fear of God regulating

the desire for wedded life and controlling the choice of a partner (cf. 1 Co 7³⁹); inspiring the 'nurture and admonition' of children and lending a sanction to their obedience (Eph 6¹⁵); imparting dignity to the necessary tasks of the household and even to the fulfilment of menial duties (Eph 6⁵, Col 3²³). All is to be planned and fulfilled 'in the Lord,' in union with His mind and under the leading of His Spirit; all duties are to be discharged 'as to the Lord and not unto men,' in the consciousness of His continual presence and in single-hearted desire to serve Him.

(ii.) The home is to exhibit in its perfect beauty the working of *the law of love*. Love is the duty commended to the husband in particular. Men are to love their wives with reverent, tender regard; with them resides the element of authority, but the rightful exercise of authority is not to be allowed to become a 'root of bitterness' or cause of irritation. And love is to be kept true and pure by habitual recollection both of the entire dependence of the wife on her husband, and of the sacred mystery which wedded love symbolizes—the self-sacrificing love of Christ for the Church (Eph 5²⁵). The mutual love of those who are brothers by birth (*φιλadelphia*) is a type and earnest of that larger love of those who are brethren in the family of Christ, the family in the strict sense being an image of the Divine Kingdom, or, as it has been described, 'a State and a Church in little,' in which the binding and inspiring power of affection may be first realized.

(iii.) St. Paul and St. Peter alike lay stress on the law of *dutifulness*. While the gospel recognizes woman's spiritual equality with man, it also guards the rightful responsibility and leadership of the man; on the other hand, nothing is said to favour the assertion of leadership on the part of the husband. On the children is impressed the duty of obedience; nothing is said to them of possible pretexts for resisting parental authority; on the other hand, the parent is warned against the misuse of authority over either children or servants (Eph 6⁴⁻⁹). Finally, servants are exhorted to show diligence and faithfulness; nothing is said to them of 'rights' or 'liberties' or of the 'indignity' of a dependent position. The master, for his part, is urged to keep alive in himself the sense of responsibility towards those who are his equals in the sight of the heavenly King and Judge (Eph 6⁹; see Moule, *Ephesian Studies*, London, 1900, chs. xv., xvi., *Colossian Studies*, ch. xi.).

(iv.) Another principle implied, though not expressly indicated, in the NT treatment of the Christian home is the law of *social service*. Home love is in germ the love which is to fulfil its obligations in every relationship of life. It includes

'Loves filial, loves fraternal, neighbour loves
And civic.'

The home, in fact, lays the foundations of social morality in the wider sense. It is a school of humanity and Christ-like service. It has to be guarded from narrowness and exclusiveness by free intercourse with others, and especially by the fulfilment of the duties of hospitality—a virtue on which great stress is laid in the NT (cf. Ro 12¹³ 16¹, 1 P 4⁷, He 6¹⁰ 13², 3 Jn 8²). In the earliest period of the Church's life, circumstances made this duty very urgent. It was the most direct and useful way in which members of the Christian brotherhood could aid the advance of the gospel (Harnack, *Expansion of Christianity*, i. 219). It is implied also in certain sayings of St. Paul that social intercourse is a duty and may minister to mutual edification (Eph 4²⁹). Family life is, in short, intended to be a school of brotherly love in its widest sense, not developing a mere *égoïsme à*

plusieurs, but training men in large-hearted sympathy and wide social affection.

'The closer and warmer the home affection, the larger and stronger should become those social instincts which make life inconceivable except in a community; . . . And if they stop short at the domestic limits, and refuse to open out to their wider office, they sin against the home as much as against the State' (H. S. Holland, in *Lombard Street in Lent*, London, 1894, p. 134 f.; see also J. S. Mackenzie, *Introd. to Social Philosophy*, Glasgow, 1890, p. 315 ff.).

Home life, in a word, fails of its divinely ordained purpose, if it does not educate and fortify the spirit of social service, if it does not awaken compassion, and deepen insight into the social needs of mankind.

In this article we have been concerned with the ideals presented by the NT. But it should not be forgotten that, while the home is an institution which has been evolved by the needs of the race—an institution to which the Christian spirit has added new grace, lustre, and stability—modern conditions have brought us to what may be a period of re-construction, when it will be the task of Christianity to define anew the essential principles of 'family ethics.' Industrial conditions, new phases of religious thought, the movement for the higher education of women and their free admission to independent professions and occupations—these and such-like changes have materially affected the normal features of home life. 'Our democracy is making inroads upon the family, and a claim is being advanced which in a certain sense is larger than the family claim' (J. Addams, *Democracy and Social Ethics*, London, 1902, p. 77).

The position of boys and girls earning an independence at a comparatively early age, the modern revolt against domestic service, the new ideals of social usefulness which have been inspired by a wider outlook and an improved education—these things have raised personal problems in family life, the solution of which depends upon submission to the progressive guidance of the Christian spirit. It must suffice to indicate the circumstances which, apart from the conditions which directly tend towards the decay of home life, render the fulfilment of home duty a less easy task than it was in the first age of Christianity (on this subject the work by J. Addams quoted above is interesting and suggestive). It remains true that the first of Christian social duties is 'to show piety at home' (1 Ti 5⁴), and that home must always continue to be the school of those graces and virtues which men need for effectual service, whether in the State or in the Church.

LITERATURE.—Besides the various books mentioned in the body of the article, see the works of Harless, Dorner, Martensen, and Newman Smyth on *Christian Ethics*; C. Gore, *The Epistle to the Ephesians: a Practical Exposition*, London, 1898, pp. 211-236; *HDB*, art. 'Family,' l. 846.

R. L. OTTLEY.

HOMER.—The religion and ethics of Homer—whether they belong to an actual evanescent 'Achæan' period in the history of Greece, or are the result of a combination of older and newer elements effected as part of a general process of evolution and harmonization extending over many centuries—have at least a superficial aspect of consistency. This is, no doubt, partly due to the peculiar quality of Homeric art, its unexampled lucidity and clearness of outline; to the Homeric spirit with its hatred of vagueness and mysticism. But this temper and art are themselves so characteristically Hellenic that we cannot look to them for an explanation of the startling divergence between the religion of the *Iliad* and *Odyssey* and that of historical Greece. For the beliefs of Homer are as distinctive as they are definite, and are now admitted by every one to be the product of historical causes. What those causes were is becoming every day more and more obviously the real

problem at the heart of the 'Homeric question.' Till they have been discovered, we must be content with a statement of the facts really within our knowledge, although it must be admitted that the whole significance of these is altered according as one does, or does not, regard them as representing an actual stage (to which the Homeric poems themselves are our only witnesses) in the development of Greek religious thought.

It will be understood that 'Homer' is used throughout this article as a synonym for the *Iliad* and *Odyssey*, without reference to the question of their authorship. The books of the *Iliad* are quoted according to the capital letters of the Greek alphabet, the books of the *Odyssey* by the ordinary letters.

I. RELIGION.—1. The gods.—These are, of course, anthropomorphic, as all Greek gods were or tended to become. They are, indeed, taller and more beautiful, wiser and more powerful, than men, and are exempt from old age and death; but otherwise they are scarcely thought of as physically different. They are said to have 'houses on Olympus,' either as actually dwelling upon the Thessalian mountain—and this is certainly the original meaning of the phrase—or, as in the *Odyssey*, inhabiting a kind of heaven which has nothing of Olympus but the name (§ 42 ff.). They form a somewhat insubordinate family-group under the government of Zeus, Olympian society being organized upon the same loosely patriarchal principles as society among Homeric men. They intervene constantly in human affairs, generally in human form, but sometimes in the semblance of birds. They are the sources of good and ill to men; although it is only some special skill or excellence that is regarded as the gift of a particular god, as skill in archery comes from Apollo (B 827; cf. E 51, 61, § 233). They are, theoretically, omnipotent and omniscient; or, at least, Zeus is so. They are subject to human passions and actuated by human motives. All this is quite in accordance with Greek religion in its classical form, although the wealth and vivacity of detail in which the anthropomorphic aspect of the gods is realized are peculiarly Homeric. What is really most important and characteristic in the religion of Homer is the clear perception of a fundamental distinction between the human and the divine. Whatever may have happened in the remote past, as when Ino was made immortal (ε 334 f.), in Homer's world no man is a god or can become a god. This is the poet's special contribution to Greek religion, and, historically considered, it is one of the most important ever made; for the conception of the Divine King was one that died hard in the Ægean world (G. Murray, *Rise of the Greek Epic*, 158 f.).

Andrew Lang makes a distinction between what he calls the ethical religion of Homer and his attitude to mythology (*World of Homer*, 120). So far as they are religious beings, Homer's gods are very grand and imposing figures, worthy of all respect and reverence. They are usually just, kindly, and placable, although their goodwill is often purchased and their wrath appeased, merely, it seems, by sufficient sacrifice. They are bound by their oaths, which they make by the water of Styx (O 38, ε 186). Their relation to Fate (Moira, Aisa) is apparently not consistently stated, no doubt because it has not been clearly thought out. Sometimes the poet uses the language of fatalism (X 5; cf. Z 487 f.); but, speaking generally, Moira coincides with, or is, the will of the gods, more especially the will of Zeus. It is, in fact, in a quite literal way to begin with, his 'portion' (Διὸς αἰσα)—the division of the tribe which belongs to him. This conception of Moira invests Zeus with a very real moral grandeur when he subdues his own feelings of love and pity in voluntary obedience to it, as when he allows his son Sarpedon to fall by the hand of Patroklos (II 431 ff.), and is moved by the

tragedy of the war (T 21). It is to Zeus that the poor woman at the millstone prays in the palace in Ithaca, when she calls down his thunder upon her oppressors (v 115 ff.). He is the protector of suppliants and strangers (η 165; cf. 181, ι 270) and beggars (ξ 57). He punishes those who give crooked judgments in the assembly and drive out Dikē, the Right Way of things, disregarding the anger of the gods (II 387 ff.), who elsewhere are said to wander disguised over the earth observing the lawlessness and righteousness of men (ρ 485 f.). 'Evil deeds do not prosper' (θ 329), for 'the blessed gods love not heartless actions' (ξ 83). The helplessness of man, which is so much in the mind of Homer, makes him dependent upon divine aid: 'All men feel the need of gods' (γ 48).

Such are the gods of Homer when he thinks of them religiously. Even so, they are apt to be vengeful and capricious, while from another point of view they are decidedly unsympathetic, being lifted so far above human needs and weaknesses. But they do move us to a half-unwilling respect and awe. One can understand the emotion evoked by the great statue of Zeus at Olympia which was inspired by a famous passage in the *Iliad*; for, as Lang has remarked (*op. cit.* 117), the Olympians of Homer are the Olympians of Pheidias. But, when the poet comes to deal with the gods of mythology, he adopts a very different tone. In his hands they cease to be moral. The charge of Xenophanes, that Homer attributes to the gods all that is accounted a shame and a reproach among men—theft and adultery and deceiving of one another (fr. 11, Diels)—can be literally justified (*e.g.* τ 396, the 'Lay of Demodokos' in θ, the Deceiving of Zeus in ε; cf. the 'Battle of the Gods' in φ 385 f.—an episode on the verge of burlesque). Yet perhaps the protest of Xenophanes—admirable and tonic at the time it was made—is somewhat beside the mark. Homer is not preaching irreligion; he is trying to solve a very difficult artistic problem. He could not avoid the mythology of his subject, but the gods as actors in that mythology he could not respect. A naive faith can jest at what it holds most sacred, but the religion of which we have quoted some instances was anything rather than naive. Homer simply took the gods of mythology as he found them, much lower in the moral scale than any of his own heroic men and women, and treated them, as it were, decoratively (see Murray, *op. cit.* 280 f.). The truth is that Homer does not sympathize with, scarcely seems to understand, the old folk-religion of Greece which existed so long before and after him. Its leading divinities, Dionysos and the Mother and Maid, Demeter and Persephone, he barely mentions; the various Mysteries, which were so important a feature in it, he does not mention at all. Neither do we find in Homer any certain reference to the belief in heroes in the technical sense of the term, 'the divine race who are called half-gods,' as Hesiod describes them (*Erga*, 159), whose innumerable cults sufficiently prove how ancient and influential their worship was in Greece; for the lines describing the divine honours paid to Erechtheus in Athens occur in the Catalogue of the Ships (B 546 ff.), and even there are perhaps an Athenian interpolation. Herakles, the typical 'hero,' is for Homer 'the man Herakles' (φ 26).

Certain important aspects of the gods who appear in the *Iliad* and *Odyssey*—and these the aspects which counted for most in the popular faith—are completely ignored. Homer will have nothing to do with the gods of the people, and makes light of the 'sacred stories' of which Greek literature is so full from Hesiod to Pausanias and Plutarch. Indeed, it is obvious that a religion like that which we find in the Homeric poems—a

religion of which we are tempted to complain that it makes too much rather than too little of reason and sanity—involves the criticism and ultimate destruction of the simple faith which could accept the myths as a decent account of the life and behaviour of the gods. That this is not due to the personal predilections of a single poet with an eclectic creed follows from the very nature of the Epos. Homer had to deal with the saga or heroic tradition; he had to retell an old tale. The fact that the story involves the prominence of certain gods and beliefs and the exclusion of certain others is ground for concluding that the former must have been prominent and the latter absent at all periods in the life of the saga. Without Zeus and Apollo, for instance, there could be no *Iliad*; without Poseidon and Athena, no *Odyssey*. These, then, were in the saga from the beginning; that is to say, they were gods of the people whose beliefs were enshrined in it. If we apply this criterion to the Homeric poems, it leads to important historical conclusions. For it seems reasonable to hold that the divinities whose action is most vital in the organic structure of the poems were the 'Achæan' gods, while those whom Homer dislikes or disregards were non-Achæan. This conclusion is strengthened by a good deal of evidence from the history of Greek religion. We know now the general spirit and character of the old Cretan and Mycænæan religions—the worship of the Bull-god, the prevalent cult of the Earth-goddess, the careful tendance of the dead; and it is certain that, at a date which can only be conjecturally fixed, the ancient faith was overlaid and, for a time, evidently eclipsed by the worship of certain deities clearly of Northern origin, especially the Father-god Zeus. That this worship was introduced by the tribes who, in the times of the Migrations, pushed down from the North into Greece is the obvious and accepted hypothesis. The Homeric poems clearly reflect a period of Northern ('Achæan') predominance, which implies and includes the predominance of the Northern religion over the native 'Ægean' worship of ghosts and goddesses. That the divinities of the Homeric pantheon are all gods of the invaders is not true; there has demonstrably been some fusion with, and affiliation to, certain divinities of the native peoples. But Homer does preserve more clearly than anything else in Greek literature the memory of a religion more distinctly Northern in character than that of pre-Homeric or classical Greece, and with an observable bias in it against the indigenous agricultural and chthonian cults. This is the historical basis of his 'Olympianism,' the root from which it has grown, although we must not assume that the flower represents the creed of any actual age or people. It grew out of popular religion, but, as it appears full-blown in our *Iliad* and *Odyssey*, it is not itself popular religion. It is too selective for that, too systematic. 'It was Homer and Hesiod,' says Herodotus, 'who composed a "theogony" for the Greeks, and who first gave the gods distinctive titles, and defined their forms and functions' (ii. 53). (For a description of the process by which the Olympian ideal was evolved by gradual differentiation from popular notions of divinity, see J. E. Harrison, *Themis*, ch. x. p. 445 ff.)

Of the Homeric gods, the most prominent in the *Iliad* are (besides Zeus) Apollo, Poseidon, and Ares; Hera, Athena, and Aphrodite; in the *Odyssey* (besides Zeus), Athena, Poseidon, Helios, and Hermes.

(1) Zeus is the supreme god, the 'father of gods and men' (A 544), and, among men, in a special sense of kings, who often have the epithet 'Zeus-born.' He is clearly the deity of a people with patriarchal institutions, and exercises a kind of

patria potestas among the other Olympians. His authority is effective, although not unchallenged, especially by *Hera*, his wife, the ancient goddess of Argos, whose rebelliousness towards him may possibly reflect some earlier conflict between their worshippers. Whether Zeus was a specifically Achæan god from the first is not at all certain. There is evidence which indicates that he was worshipped at Dodona long before the coming of Achæans there. But it is certain that he became the chief god of the people whom Homer calls Achæans, and his characteristics in Homer are nearly all 'Northern.' Nor is his earliest home in the far north-west forgotten, for Achilles prays to him as 'Zeus the Lord, God of Dodona, Pelasgian' (Π 233). But normally he dwells upon Mount Olympus; he is, indeed, pre-eminently 'the Olympian' (A 508, 583, 589). This also without doubt has its historical justification, taking us back to a time when his worshippers dwelt in North Thessaly, as tradition always maintained. Originally, then, 'the Olympian' meant 'he who dwells on Olympus' in Thessaly, although, as many mountains in Greece were named Olympus, and at least one famous seat of Zeus-worship was called Olympia, the epithet 'Olympian' gradually extended its connotation. Homer, indeed, speaks of the gods generally as 'the Olympians.' What is certain is that Zeus dwells by preference on the summit of a mountain (e.g. Θ 3). He watches the fortunes of the war from Gargaros, a peak of Mount Ida in the Troad, where he has a precinct and altar (Θ 47 f.; cf. X 171, Γ 276, Ω 308). This explains why Zeus seems all through the *Iliad* to favour the Trojans. He is the god of both sides, and the god of Ida is opposed to the god of Olympus (Murray, *op. cit.* 90). He is said to dwell in the upper air (B 419). This is natural in a divinity who is primarily a Sky-god, lord of the elements, above all of the thunderstorm, from which he derives many epithets (τερπικέρανος, ἐριγδουπος, etc.; cf. A 580, Π 298). He is armed with the thunderbolt and the ægis, and is himself a great war-god (ταμῆς πολέμοιο, Δ 84). The Homeric Zeus is, in fact, an excellent illustration of the way in which certain primitive traits of a divinity may persist side by side with others which obviously belong to a totally different stage of religious thought. He never loses his original character of a Sky- and Thunder-god, but he is gradually moralized into the Zeus of certain great passages already quoted.

(2) The same process has been at work in the case of *Apollo*; but it has gone much further, and eliminated almost every trace of his original nature. The probability is that he was, to begin with, a Sun-god; but no one could infer that from Homer. He appears in the *Iliad* as a great warrior, strong upon the side of the Trojans and Lycians. Apollo, as his cults testify and Homer well knows (A 37 f.), was the great divinity of the Troad; and his favour towards the Lycians would also be explained if we could accept as proved Wilamowitz's hypothesis of his Lycian origin, and translate his epithet λυκηγενής (Δ 101) by 'Lycian-born.' Outside Troy and the Troad, 'rocky Pytho' is already sacred to him (I 405), and he has a consecrated grove at Ismaros in Thrace (ι 200) and in Ithaca (ν 278). But it is strange to find that one of the greatest of Greek gods in the estimation of Homer himself has so little connexion in the Epos with Greece proper. He is armed with the bow (A 45 f.)—an archaic touch. Hence his commonest epithet is 'the Far-Darter' (ἐκηβόλος, etc., A 14, 75, 385, 479, etc.). References to other aspects afterwards prominent in the Apolline religion are neither numerous nor important. But the ideal figure of Apollo in Homer, rising at times to sublimity, exercised an

incalculable influence upon Greek art, and, through Greek art, upon modern notions of what is implied in Hellenism.

(3) Conjoined with Zeus and Apollo in the recurring formula of appeal to the gods (B 371, Δ 288, etc.) is *Athena* (Ἀθήνη). The association is evidently significant, for it reappears in Athenian religion (see Harrison, *Themis*, 501 f.). Of all the gods, these are the three most highly honoured, Zeus, of course, in the highest degree (cf. Θ 540). Athena is his daughter and favourite child, although reference is nowhere made to the legend of her birth from his head—not the kind of story likely to appeal to Homer. She carries the ægis, like her father the Thunder-god (B 447, E 738); and the explanation of this seems to be found in her development, as Pallas, from the *palladion* (two round shields placed so as to touch at the rim and form the figure 8), which was regarded as a 'thunder-shield.' Hence she is a great war-goddess—indeed, the chief Achæan divinity of war, and more than a match for Ares. Her other name, 'Athene,' connects her with Attica. Whether Homer thought of her as a specially Athenian goddess is not clear from the poems themselves, although the epithet 'Athenaië' is evidence enough of her historical association with Athens. Another of her epithets, 'Glaukōpis,' points in the same direction; for, although in Homer it evidently means no more than 'grey-eyed' or 'bright-eyed,' it must be derived from γλαῦξ, and the owl, as every one remembers, was the sacred bird of the Athenian goddess. So with the title 'Boōpis' applied to Hera, the ancient Cow-goddess of Argos (A 551). But these traces of primitive religion are not consciously realized, or are deliberately suppressed, in Homer, who imagines Athena in the form of a woman 'fair and tall and skilled in gleaming crafts' (ν 289)—wise, also, and mighty in war. It is the Athena of Pheidias.

(4) The same idealizing tendency has been at work upon *Poseidon*; and it has been remarked that Apollo, Athena, and Poseidon, who are never made to appear mean or ridiculous like most of the other Olympians on occasion, were the chief deities of the Ionian race. Whatever inference may be drawn from that, the Poseidon of Homer is certainly an impressive creation, with something about him of the turbulence and splendour of the sea. For it is as god of the sea that he is consistently presented in both the *Iliad* and the *Odyssey*; although the *Iliad* seems not unaware of his function as the god of horses (Ψ 307, 584). The epithet 'Earth-shaker' (ἐννοσίγαιος, ἐνοσίχθων) does not help us, for it is at least as applicable to his power of making earthquakes as to his shaking the land with his waves; while the title γαίηχος is of uncertain meaning. For the most part Poseidon is a vehement partisan of the Achæans. But he is wroth with them for building a wall that is like to eclipse the glory of that built for Troy by Apollo and himself when they toiled for Laomedon (H 448 ff.); and Zeus gives him permission to destroy the Greek fortifications after the war. To this there is doubtless some background of fact, and we become sure of it when the god rescues Æneas from Achilles, that the descendants of the Trojan hero may reign in Troyland (Υ 302 ff.). The persecution of Odysseus by Poseidon finds its poetical motive in the blinding of Polyphemos, the uncouth son of the god. But it, too, perhaps rests on some ground of actuality, since the injunctions of Teiresias seem to point to the foundation of some known cult of Poseidon among a people ignorant of the sea (λ 121 f.).

(5) *Ares* and *Aphrodite* are associated in both the *Iliad* (E 359 ff., Φ 416) and the *Odyssey* (θ 266 f.). They are treated unsympathetically by Homer,

especially Ares. The explanation seems to be that both are 'Thracian' divinities, and the Homeric Thracians are enemies of the Achæans. Ares at least is a Thracian in Homer (N 301, θ 361); while there is ground for thinking that Aphrodite was originally his wife; although in the fabliau-like Lay of Demodokos she is represented as the wife of Hephaistos. On the other hand, the wife of Hephaistos in the *Iliad* is Charis (Σ 382). Aphrodite is called the daughter of Zeus and Dione (E 348, 370). She is named the 'Cyprian' (E 330, etc.), and has a sanctuary at Paphos (θ 363). This recalls her undoubted kinship with the Oriental Love-goddess whom the Greeks called Astarte (*q.v.*); for Cyprus early received a large Semitic element in its population. She is also named the 'Cytherean' (θ 288, σ 193). She intervenes to save her son Æneas from the lance of Diomedes (E 311 ff.)—a reminiscence, perhaps, in the tradition of her original nature as a war-goddess. Homer, however, regards her as simply the goddess of Love, peculiarly unfitted, in fact, for the strife of battle (E 429). She serves for the standard of beauty, the 'golden' Aphrodite, and is already essentially the type embodied in the statue of Praxiteles. Ares, on the other hand, typifies the rage of battle, the war-spirit as a mere explosion of animal ferocity; while Athena represents the same spirit controlled and directed by reason.

(6) *Hermes* and *Iris* are messengers of the gods, more strictly perhaps of Zeus. *Hermes* provides us with a vivid illustration of the contrast between Homeric and popular Greek religion. There is a whole world of difference between the ithyphallic idol worshipped by the Arcadians and Athenians and the god of Homer 'like a young man in the most gracious season of youth' (κ 278). There is, however, one aspect of the Homeric god which accords with the popular conception of him, namely that in which he is *Psychopompos*, Conductor of the Dead to the under world; for in the cults *Hermes* has important chthonian functions (*ω ad init.*; the passage, however, is late). His magic golden wand (ε 47) belongs to him in this capacity. The epithets he bears (*ἐπιούριος, ἀγκυρα, διάκτορος, ἀργεῖφόντης*) are all unexplained. It is one of the distinctions between the *Iliad* and the *Odyssey* that in the former it is *Iris* who is normally the messenger of Zeus, while in the latter it is *Hermes*.

(7) Of the Olympians, *Hephaistos* is most definitely connected with a special locality—Lemnos (A 593, θ 283 ff.). As Fire-god he appears sometimes to be almost identified with the element he controls (*e.g.* φ 342 ff.). His skill as a craftsman is much celebrated (A 608, θ 195, etc., esp. Σ 478 ff.); but for the most part he is treated in a vein of good-natured comedy.

(8) *Helios* (μ 376 ff.) is even more elemental in his nature, being simply the personified Sun, one of the ancient Nature-gods dwelling in the background of Homeric religion. To this background also belong not only *Dionysos* and *Demeter* with certain minor divinities such as *Aiolos*, *Kirke*, *Proteus*, *Leukothea*, but the great company of nymphs, river-gods, and the like, who have in all ages been very real to the imagination of the Greek people (see J. C. Lawson, *Modern Greek Folklore*, etc., Cambridge, 1910, p. 130 ff.). The essential nature of *Dionysos* and *Demeter* as spirits of the changing seasons prevented their becoming Olympians, for these do not suffer age or death, whereas the central fact in the ritual of *Dionysos* and *Demeter* was a drama of the death and re-birth of the god.

2. The world of the dead.—The Homeric conception of the soul and its destiny differs as much

from that which seems to have been at all times current in Greece as his Olympians differ from the gods of the people. Yet it is a logical accompaniment, either as cause or effect, of the Homeric practice of cremation, and it can be paralleled from history. In Homer the dead man is habitually burned, and a mound heaped over his ashes. Only in this way can his soul (*ψυχή*) be set free to enter the realm of Hades, from which the ghost of the unburned and unburied is excluded by the dead already there (Ψ 71 f.). It is impossible for a race which burns its dead, consuming flesh and sinews (λ 219) until only the charred bones are left, to have the materialistic conception of the soul natural to a primitive people accustomed to bury its dead entire. So Homer imagines the soul as little more than a vapour exhaling from the pyre, and thereafter leading an apathetic life in the under world, a mere shadow (*σκιά*) now. The essential thing about the Homeric ghost is its futility. It is the sense of this, and not any positive suffering, that calls forth the lament of Achilles, that it is better to be a poor labouring man on earth than king over all the dead (λ 488 ff.). Life has lost colour and intensity for the dead, and their existence is a mere reflexion or parody of their earthly lives. This is most clearly brought out in the latter part of the eleventh book of the *Odyssey* (568 ff.)—a passage which is believed to show the influence of Orphic ideas, and at any rate contains other ideas than the rest of the *Nekyia* (λ). Here we find Minos dealing judgments among the dead as he judged his people once in Knossos, and the phantasm of Herakles with his bow as in life, and Orion hunting the wild creatures as he hunted them on earth. This conception of the life after death was perhaps the normal Greek one (cf. Pind. fr. 129), and does not seem inconsistent with the Homeric doctrine of the soul. But in the 'Orphic interpolation' we also find certain great criminals—*Tityos*, *Tantalos*, *Sisyphos*—evidently being punished for their sins. There is probably some misunderstanding here of the original meaning of the myths of *Sisyphos* and the rest; and there is no mention elsewhere in the *Nekyia* of a separate abode or destiny for the good and the wicked; there is no Heaven and no Hell.

Archæologists have found no evidence of any period in historic or pre-historic Greece when inhumation was not the usual mode of disposing of the dead. We can only infer that, while cremation may have been universal among the Achæans when they entered the Hellenic lands, they quickly learned to bury their dead from the earlier inhabitants, who certainly buried theirs. The Homeric doctrine of the soul, which we may assume to have been the Achæan doctrine, since it goes with cremation, likewise speedily disappeared before the native belief in the effective powers of dead men. And, in fact, the language of Homer is not perfectly consistent (see Rohde, *Psyche*, i. 1–67). *Odysseus* digs a trench and pours into it the blood of a black ram sacrificed to *Teiresias* (λ 23 ff.; cf. Paus. ix. 39. 6). The shade of the prophet drinks of the blood before he speaks. This feeding of the dead was a ritual act performed by the Greeks throughout antiquity. But it has no meaning unless the dead man is there to be fed, that is, unless he is buried and not burned; for the feeding was literal enough, the blood being sometimes conveyed to the corpse through a hole in the tomb. As a matter of fact, *Teiresias* had a pre-historic tomb in Bœotia, where he was regarded as a prophet still capable of delivering his oracles. The sacrifice, which was properly offered at this tomb, is made in Homer to his shade at the limits of the earth. Again, the descriptions of funerals sometimes surprise us by details which look like survi-

vals from an age of embalming and inhumation (e.g. use of *ταρχύειν* [Ω 413, ω 65]). The exact weight to be assigned to these indications is not easy to judge. They may qualify a little, but they do not alter, the fact that in Homer the dead are always burned, and that their souls exist in separation from their bodies in a world reached at the verge of Oceanus in the extreme West; whereas the normal Greek practice was to inhume the dead, and the normal Greek belief was that the soul after death somehow maintained its connexion with the body, and that the realm of Hades was under the earth—as at least one passage in the *Iliad* implies (T 61)—to be reached by certain known caverns or clefts in the ground. The contradiction is radical. Ghost-worship, hero-worship—the whole of that chthonian religion which meant so much to the Greeks of history—are steadily ignored in Homer; Hades and Persephone are mere names.

3. Ritual and priests.—The gods are approached by men with prayer and burnt-offering. The two things naturally go together; and, when prayer is made to a god without sacrifice, it usually contains a reminder of sacrifices offered on previous occasions (cf. A 40). That is because the attitude of the worshipper is not unfairly expressed as *do ut des*. For the same reason a prayer usually includes a vow to make an offering to the god, if the request be granted. Doubtless there is in Homer some lingering feeling that the sacrifice is more than a mere business transaction, that the god of one's own tribe will be more disposed to accept it than an alien deity, perhaps even that the relation thus established between worshipped and worshipper has a certain mystical force. But he does not think of sacrifice as a sacrament. The ritual is elaborately described for us, most fully in the third book of the *Odyssey*, when Nestor sacrifices an ox or cow to Athena (431 ff.). The victim had to be appropriate, as a bull to Poseidon (A 728, γ 6), a white male lamb to Helios (Γ 103), and so on. The victim was expected to be unblemished, and the sacrificers must be ceremonially clean. Sacrifice offered in confirmation of an oath is exceptional in admitting a mimetic or at least symbolical element: 'whichever side breaks the oath first, may their brains be spilt on the ground like this wine!' (Γ 300); and the flesh of the victim was not eaten (310). Since we have to do in Homer with burnt sacrifice to the heavenly gods, the altars he speaks of are the high *bōmoi*. The low *eschara*, which served as altar in hero-worship, means in the Homeric poems simply a hearth (η 153). Temples are rarely mentioned, and then in passages whose evidential value is questioned (see Cauer, *Grundfragen*², Leipzig, 1909, p. 297 f.). There are certainly many reminiscences of a time when temples did not as yet exist, and the altar of the god stood in the open air, in a grove or sacred enclosure (*τέμενος*), or by running water (B 305, 506, I 404, ζ 291, etc.). Only one statue is mentioned—that of Athena in her temple at Troy, which must have represented the goddess as seated (cf. Z 303), although the earliest images of the gods were standing. As to priests, they are always attached to some special sacred place and the service of some special divinity. There is no priestly caste in Homer any more than in historical Greece. Sometimes we meet with a priest of a very primitive type, like Maron who 'dwelt in the grove of Apollo' (ι 200), like Chryses, who is called an *ἀρητήρ*, or cursing-man (A 11), like the Selloi at Dodona, who had unwashed feet and slept on the ground (Π 235). These last were perhaps prophets rather than priests; and prophets, as we must expect in every saga, play a considerable part in both the *Iliad* and the *Odyssey*, especially Kalchas in the

former and Teiresias in the latter. Theoklymenos had the gift of second sight (ν 351 ff.).

There were also oracles to consult. Homer mentions two: that of Zeus at Dodona (ξ 327), and that of Apollo at Pytho (Delphi [θ 80]). We hear a great deal of omens, drawn mainly from signs of the weather and the flight of birds, but sometimes also from such things as a chance word (*φήμη*, *κληιδών* [β 35, σ 117]) or a sneeze (ρ 541). There is no instance, however,—and this can hardly be accidental—of augury from the inspection of entrails or from the behaviour of the sacrifice as the fire consumed it. On the other hand, a dream comes from Zeus (A 63); and we hear of an interpreter of dreams (E 149), which may be false or true (τ 562 f.). Of magic, except in the fairyland of Odysseus' wanderings, where incredible things may allowably happen, there is practically no mention (see, however, E 845, τ 457). Curses were addressed to Hades, Persephone, and the Erinyes (I 454, 569); to make them hear, the mother of Meleagros beat with her hands upon the earth.

II. *ETHICS*.—The morality of Homer has an appearance of even greater uniformity and consistency than his religion. It is, on the whole, that characteristic of a feudal society. The cardinal virtue is, no doubt, Courage. Next to Courage comes Wisdom, the capacity for thought and speech. The praise of Achilles and Agamemnon is that they are the first of the Danaoi in council and in battle (A 258); and again Achilles was taught to be 'a speaker of words and a doer of deeds' (I 443). But it is in Odysseus that both virtues are most justly combined; and that example helps us to remember—what no Greek was likely to forget—that the mere possession of wisdom was not enough without the eloquence necessary to recommend it.

Besides these special qualities, and, as it were, beneath them, we have to take account of a more comprehensive feeling, which, although scarcely conscious enough of itself to be in the full sense ethical, is the basis of nearly all the moral virtues in Homer. The classical Greek writers spoke of it as a feeling for the exact 'limit' or 'measure' to be observed in the quality of a man's actions. But in Homer it is still in what may be called its instinctive stage, and one detects behind it a greater reinforcement of emotion than goes with the Aristotelian doctrine of the Mean. It has both a positive and a negative side. That is to say, the feeling is positive enough, but it tends to take the form of a protest against excess. The positive emotion is called by Homer 'Aidōs'; Aidōs is what impels us to avoid the excess. The emotion stirred in us by the lack of Aidōs he calls 'Nemesis.' Thus Nemesis comes to be, as it were, the sanction of Aidōs. But the good man may feel Aidōs in a case where he need not fear the condemnation of gods or men. Then there enters something like the sentiment of chivalry. Achilles would not despoil the dead Eetion of his armour (Z 417 ff.); chieftains must not be laggards in the fight like a mean man (N 114 f.)—*noblesse oblige*. But Aidōs and Nemesis together include more than the mediæval ideal, although they have not all its heroic quality. They are applicable to pretty nearly all the relations in which human beings can stand to one another, but especially to that relation which forms the standing moral problem in a society in dissolution or frankly based upon physical force—the relation of the stronger to the weaker. Aidōs and Nemesis step between conquered and conqueror, preventing the latter from abusing his advantage, from overstepping a certain limit and so becoming guilty of 'Hybris,' which is the violation of Aidōs and the object of Nemesis. In practice, the limit is roughly defined by what is usual—custom

('Dikē'), to which time has brought the moral authority of Law. To observe Dikē is to be just (*δίκαιος*). For Dikē, the Right Way, we may generally substitute 'Themis,' which is specialized to a slightly more ethical sense. It is the nearest word in Greek to what we mean by the Moral Law, but its roots lie in mere ancient use and wont; the plural *themistes* means pronouncements of what is customary, and therefore right and just, in particular cases. In this way a body of precedents may arise, capable in time of being systematized into a legal code. But in Homer we have not yet reached that stage. Even on a point of tribal law there is room for diversity of private opinion—that judgment is best which obtains the applause of the assembled tribesmen (Σ 503 f.). Here public opinion counts for something. But it is only in an ordered society that public opinion can be brought to bear effectively upon individual conduct. Now, Homeric society is not highly organized; and so in it *Aidōs* and *Nemesis* have a supreme value and importance, because, in the absence of an effective administration of justice, it is to them alone in the last resort that the helpless can appeal with any hope of success. The entirely defenceless in this society consist of the dead, the aged, strangers, and suppliants, every one, in fact, who cannot assert his rights by force and has no one to assert them for him. Such people are *αἰδοῖοι*; *Aidōs* is due to them, even belongs to them, almost like an attribute. If a man violates *Aidōs* in dealing with them, they become for the first time dangerous, endowed with some baneful power over his life even in their own death. Homer expresses this by saying that they embody the wrath of the gods (*θεῶν μῆνιμα* [X 358, λ 73]), and often speaks of Zeus as the protector and avenger of the stranger and suppliant. But that is only a more theological way of expressing the more primitive notion that the helpless are charged with a quality which contains in itself some mystic power of punishing its violation. And not only the helpless have this quality, but kings and even, to some extent, old men, the former because of the divinity that hedges them and in primitive communities (not, of course, in Homeric society) guards them by a tabu, the latter because of the sanctity attaching to the male heads of families in a patrilinear tribe. Hence, in Homer, kings and old men are *αἰδοῖοι*, the latter for a double reason. *Aidōs* and *Nemesis*, indeed, are found to inspire nearly the whole of Homeric morality: truthfulness, for instance, and the faithful keeping of a pledge or oath (*ῥῆκος*).

This morality at its best is singularly pure and noble, humane and at times even tender, in spite of the atmosphere of passion and struggle in which the poems are involved. This may easily be illustrated by quotations, from the ringing 'Hateful to me as the gates of Death is the man who hides one thing in his heart and says another' of Achilles (I 312 f.) to the words of Odysseus towards the end of the *Odyssey*: 'It is an unholy thing to boast over the slain' (χ 412). But individual quotations scarcely show it so well as the general tone of both epics. Nay, the mere working out of their plots reveals a profound ethical sense. No one can follow the tragedy of Achilles to its conclusion in the last book of the *Iliad* without an enrichment of moral experience; and, when in the *Odyssey* the suitors at last meet their doom, we feel that this is more than 'poetic justice'; it is a kind of *theodictē*.

The morality of Homer, however, does not everywhere reach this high level. The declensions are rare, but their very rarity makes them instructive. They may be explained in two ways: as justified by the circumstances under which they occur, or as survivals of an earlier stage in the growth of the *Iliad* and *Odyssey*, these being regarded on this

hypothesis as traditional poems. If, for example, we take the treatment of the dead, we find side by side with the thrilling humanity of the sentiment that it is an unholy thing to boast over the fallen, and with the implied condemnation of the mutilation of Hektor's body, instances of both kinds of brutality (A 146 f., N 202 ff., P 126 ff., Σ 177; boasting over the dead—N 374 ff., 414 ff., 445 ff., etc.). These things, it may be said, are done in hot blood; in his normal moments no warrior would be guilty of them. Perhaps it is because there was a certain deliberateness in the actions that Achilles' treatment of Hektor's body (X 395, Ψ 24) and the sacrifice of twelve Trojan youths on the pyre of Patroklos (Ψ 176) offend the poet. There is only one case of torture in Homer (X 474 ff.), which would be justifiable, if torture were ever justifiable. But it is certain that Homer dislikes and makes as little as possible of these inhumanities of warfare; and, if we do find them here and there, it is because they were inherent in the tradition; for they are not romantic horrors invented by the poet, but relics of barbarism, the battle-customs of the Achæans. It has, in fact, been argued that the Homeric poems contain traces of actual expurgation.

The Expurgation Theory is primarily Gilbert Murray's (*op. cit.* ch. v.). The evidence for this cannot be presented except in detail, since it is in minutiae only that expurgation is likely to be detected. It may be, for instance, that the incident of the dragging of Hektor behind the chariot of Achilles has been rehandled so as to make it clear that Hektor was already dead, and not, as another and evidently more primitive version insisted, still alive. There is a line in which it is said that Agamemnon 'drew on,' instead of 'drew off' or some equivalent word, the tunics of certain men whom he had slain; stripping the dead and tearing their tunics being regarded as permissible practices (A 100; cf. B 416, II 841). There has perhaps been expurgation of some outrage to the corpse of Hektor at Ψ 24 ff., where the language is not easily intelligible except on the supposition of an omission after line 25. Again, it is said in one passage that Odysseus obtained poison for his arrows (α 261). But this is repugnant to the general tone of the Epos. Accordingly it has been thought that the mention of poisoned arrows elsewhere has been suppressed, notably in one passage where Menelaos is wounded by a shaft and Machaon sucks the wound (Δ 218).

But expurgation (it is pointed out) is not always successful: witness the instances given of mutilation and cruelty. At the same time it should not be forgotten that Homer is describing a society disorganized by war and recent conquest—the kind of society in which strangers were asked 'whether they were merchants or pirates' (γ 73 f., ε 252 ff.; cf. Thuc. i. 5). In times like those the morality even of good men is put to a searching test, and the surprise comes to be that the Homeric standard is so high. Moreover, it is what is best in the ethics of Homer that is most characteristic; for, as we have seen, its defects are largely traditional or conventional. It is the same with what may be called the domestic morality of the poems. There is a wonderful tenderness in the relations of Hektor to Andromache, of Odysseus to Penelope, of Achilles to Thetis, of Alkinoos to Arête and Nausikaa. One must, of course, allow a little for deliberate idealization, but the nature of the ideal helps us to understand the atmosphere of the normal Homeric household. Sometimes we catch sight of uglier possibilities. Helen and Paris are scarcely a happy pair. There is the extremely painful and pathetic story of Phoinix related in the ninth book of the *Iliad* (447 ff.). Klytëmnestras figures prominently in the background of the *Odyssey*. Yet here again it is the more favourable picture that gives the truer view. The *Odyssey* might almost be called a celebration of the domestic virtues.

In essentials, Homeric morality is that of the great period of Athenian history, although there are things in Homer which shocked the moral sense, of philosophers at least, in Ionia and Athens, just as, on the other hand, there were certain

practices tolerated by public opinion in Classical Greece with which Homer will have nothing to do. It must be admitted that he has no moral philosophy, in the same way and for the same reason that he has no philosophy of religion. One has but to think of Æschylus or even Pindar to realize how unspeculative he is. But that was inevitable. Apart from the fact that a poet is not a moralist, a poem like the *Iliad* must reflect the national point of view—at any rate the point of view of a dominant class in the nation—and not that of the individual artist. Hence the morality of the Homeric poems is popular morality, raised to a new power in virtue of the new splendour of expression given to it. For this reason they were for centuries regarded, in spite of an occasional protest like that of Plato, as a kind of handbook of ethics; as such they were taught in schools. It is impossible to exaggerate the positive influence of Homeric religion and morals in the ancient world and upon modern ideas concerning paganism. They do, in fact, constitute a great deal of what has hitherto been understood by that elusive word.

LITERATURE.—Since the religion and ethics of Homer form an important chapter in the history of Greek religion and morality as well as one of the central problems of the 'Homeric Question,' the literature is very large. Of the older books, C. F. Nägelsbach, *Homeric Theologie*², Nuremberg, 1861; E. Buchholz, *Die homerischen Realien*, Leipzig, 1871-85 (iii. 'Die homer. Götterlehre,' etc.); and W. E. Gladstone's books on Homer have collected the facts. One may now use T. D. Seymour's *Life in the Homeric Age*, New York, 1907, in its relevant chs., and O. Gruppe's *Griech. Mythol. u. Religionsgesch.* (in Iwan Müller's *Handbuch d. klass. Altertumswissenschaft*), Munich, 1906. The evidence is discussed in L. R. Farnell, *Cults of the Greek States*, Oxford, 1896-1909; in J. E. Harrison, *Prolegomena to the Study of Greek Religion*, Camb. 1903, and *Themis*, do. 1912; in E. Rohde, *Psyche*⁴, Tübingen, 1907; in Gilbert Murray, *Rise of the Greek Epic*², Oxford, 1911, and *Four Stages of Greek Religion*, London, 1912, ch. ii.; and in Andrew Lang, *World of Homer*, London, 1910.

The articles in Roscher and Pauly-Wissowa may also be consulted. Of the historians of Greece, perhaps E. Meyer has treated the subject most suggestively in his *Gesch. des Alterthums*, ii., Stuttgart, 1893, p. 42 f.

J. A. K. THOMSON.

HOMICIDE.—See **CRIMES AND PUNISHMENTS**.

HOMILETICS.—See **PREACHING**.

HOMOIOUSIA, HOMOOUSIA.—See **ARIANISM**.

HONESTY.—Honesty, or the quality of being honest, is a virtue which belongs to the ethical *genus* justice. In common usage, it often approximates in meaning to honour (*q.v.*). As the original *honestas* is the character or repute attaching to the holder of an *honor*, or position of dignity, so honesty may be distinguished from honour as cause from effect, when the latter is used in its objective sense as the respect in which the individual is held by society. If we trace the usage of the word in English literature, we find that it has various shades of meaning, including *chastity*, or virtue in the limited sense (cf. the famous passage in Shakespeare, *Hamlet*, III. i. 107, and also *As You Like It*, III. iii. 30), *generosity*, *uprightness*, *truthfulness*, and *fidelity* in one's relationships with others. Inasmuch as the virtue of honesty involves regard both for moral rights and for rights of property, it may equally well be classified under benevolence and under justice; for Aristotle's definition of justice as the practice of entire virtue towards one's neighbour (*Eth. Nic.* v. 13) is in modern ethics widened out by the concept of benevolence (*q.v.*), which is the principle of seeking the good of the individual as man and not merely as a member of the same *polis*, or community (cf. J. H. Muirhead's classification of the forms of good in *Elements of Ethics*², London, 1910, p. 201). Breaches of the law of justice or benevolence, when these take the form of dishonesty, untruthfulness, or covetousness, are

commonly judged bad on the ground of the harm that they inflict on others. The essence of honesty as an other-regarding virtue consists in conduct based on the conviction that the interest of our neighbours is identical with our own. The Christian conception of 'the Kingdom of heaven' in its social aspect implies a standard of conduct in which the well-being of others is not distinguished from one's own well-being. Hence, in comparing the utilitarian formula, 'every one should count for one and no one for more than one,' with Kant's categorical imperative, T. H. Green (*Proleg. to Ethics*³, Oxford, 1890, p. 224 f.) pronounces the latter superior as the rule on which the ideally just or honest man acts. Whether the *summum bonum* be defined as self-realization or 'the Kingdom of heaven' in the Christian scheme of life, humanity in the person of every one is always to be treated as an end and never merely as a means. 'Every one has a *suum* which every one else is bound to render him' (*ib.* 231).

Cicero (*de Offic.* III. xxi. 83) identifies *honestum* (the Latin form of τὸ καλόν) with *utile*, after the manner of the Stoic ethics (cf. 'honestate dirigenda utilitas est, et quidem sic ut haec duo verbo inter se discrepare, re unum sonare videantur'—a dogma of ancient philosophy which is perpetuated in the maxim 'honesty is the best policy'). The identification of honesty with expediency belongs to an obsolete view of society.

'It is to the duties of Justice and Benevolence taken together that we should ultimately refer the duty of Loyalty to existing social institutions and particularly to the State; the duty of Honesty, which means respect for the existing laws of property so long as they are not capable of immediate improvement by the individual's own action' (H. Rashdall, *Theory of Good and Evil*, Oxford, 1907, ii. 273).

The scrupulous regard for the rights and possessions of others which honesty is commonly held to imply is capable of extension in various directions. There is, for example, the duty of producing (or trading with) nothing which is not what it professes to be. J. S. Mackenzie (*Manual of Ethics*⁴, London, 1900, p. 221) refers to Ruskin's teaching on modes of artistic expression (see ch. 'The Lamp of Truth,' in the *Seven Lamps of Architecture*) and also to the knowledge of the 'crammer.' An 'honest day's work' means no shirking, just as an 'honest' piece of cloth means just length or breadth (see quotation from Bischoff, *Woolen Manuf.*, 1862, ii. 95, in *OED*, s.v. 'Honesty'). There is also the duty of being honest with one's self, the courageous acknowledgment of failure or defect. Many problems of casuistry arise out of the *suppressio veri* or *suggestio falsi* adopted, e.g., by a legal advocate engaged in the attempt to save the guilty (see H. Sidgwick, *Methods of Ethics*⁶, London, 1901, on 'Veracity'); or, again, out of the practice of subscribing to a formula or creed the terms of which can no longer be interpreted in their original sense; or out of the failure of individual members of a trade union to keep the obligation entered into by their leaders. Such cases are, in general, to be determined by the consideration of the effects of our action on the moral world of which we are members (cf. Mackenzie, *op. cit.*, on 'The Commandments,' cxi., with quotations in the footnote, p. 206). The honest life, which includes honesty of speech and deed and motive, is not to be regulated by any outward code of duties; for, if in ethical theory it is based on respect for the social order, from the religious standpoint it owes its sanctions to the Divine ideal of perfection expressed by the Psalmist in the words, 'Thou desirest *truth* in the inward parts' (Ps 51⁶).

LITERATURE.—See authorities mentioned under art. **HONOUR**.

R. MARTIN POPE.

HONEY.—I. Honey was highly valued among the ancients, both as a food and on account of the inherent properties which it was supposed to pos-

sess. The esteem in which it was held by the ancient Hebrews is indicated by the insistence upon the character of the Promised Land as a land flowing with milk and honey (Dt 6³ and often), while it is frequently used in simile or metaphor in the OT, especially in the Psalms—e.g. of the word of Jahweh, 'sweeter than honey and the honeycomb' (Ps 19¹⁰). The remembrance of a good man is 'sweet as honey in all mouths' (Sir 49¹). Three different kinds of honey are mentioned in the Bible. Of these, however, the term *d'bbhash* (very frequent) covers not only the glutinous bee honey or vegetable honey, but a syrup of dates or dates themselves, and the syrup of grapes; the last, under the name of *dibs*, is still common in Arabia, and looks like coarse honey; indeed, since the spread of Islām it has become the principal form in which the grape is used. The other forms of honey mentioned are *ya'ar* (Ca 5¹), the honey of bees only; and *nōpheth* (Pr 5³ 24¹³ 27⁷, Ca 4¹¹), usually associated with the honeycomb. Josephus mentions bees' honey as a natural product of the Plain of Jericho (*BJ* iv. viii. 3), probably referring to the honey of wild bees found in the rocks. Although there is no reference in the OT to the domestication of bees, it was of great antiquity in Syria; it is first mentioned by Philo, who says that the Essenes were fond of honey. The Jews took honey by smoking out the bees, but two combs were left for the winter. It was eaten alone as a delicacy (cf. the use made by Samson of the honey taken from the lion [*Jg* 14⁹]), or as a relish with other articles, sometimes with curdled milk. It was also used to sweeten cakes (cf. Ex 16²¹, Ps 119¹⁰³). A drink resembling mead was composed of wine, honey, and pepper. Honey also formed an important staple of commerce, being exported in jars through Tyre. With butter and milk it is still one of the favourite foods of the Bedawin.

2. Throughout the whole Mediterranean area, honey was used for *sweetening purposes* until the introduction of sugar under the Roman Empire. The ancient Egyptians made a sweet beer from honey; the Homeric heroes drank a liquor of which honey was an ingredient (cf. *Il.* xi. 630 f.). In later times, honey was used largely by the Greeks in making the many varieties of cakes (*πλακοῦντες*, *πέμματα*) eaten as dessert, of which they were extremely fond, special varieties being made at Syracuse, Samos, Alexandria, and elsewhere (Athenæus, xiv. 645 f.). The Pythagoreans are said to have lived on a diet of bread and honey (*ib.* ii. 47). The *metheglin* of the ancient Briton and the *mead* of the Teutonic races were compounded of honey; in the Chronicle of Saxo Grammaticus (tr. Elton-Powell, London, 1894, p. 393 ff.), Starkad includes the drinking of mead among the luxurious habits introduced into Scandinavia by the Teutons. A mead or honey ale is mentioned in the Rigveda. The Roman *mulsum*, the Russian *lipetz*, and the *clary* and *bragget* of mediæval England, are beverages in the composition of which honey was used.

3. At one period in Egypt and Assyria, honey was used for *embalming the dead*. The Muhammadan writer 'Abd al-Latif mentions the case of a child whose body was found in a sealed jar of honey. Anointing the dead with fat and honey for purposes of preservation is mentioned in Homer (*Il.* xix. 38, xxiii. 170). The body of Alexander the Great was preserved by this method; and Josephus (*Ant.* xiv. vii. 4) says that the body of king Aristobulus was kept in honey until Antony sent it to the royal cemetery in Judæa.

4. Honey forms an important element in the diet of many primitive peoples. In Australia, where food is frequently difficult to obtain, it is in great request.

When the honey has been ladled out with mops from the hollow tree in which the nest is usually situated, it is mixed with water in wooden troughs, and sometimes left to ferment. In a children's game imitating the taking of honey, the piled-up hands are removed one by one to represent the lopping of the boughs; if girls are playing, their arms are supposed to be lopped at the elbow, as women are allowed to touch only the honey from the lower limbs of the tree where the drippings are (N. W. Thomas, *The Natives of Australia*, London, 1906, pp. 111, 133). Honey is also obtained by digging out the nests of the honey ant (Spencer-Gillen, *Across Australia*, London, 1912, i. 122), or direct from flowers by sucking or soaking.

Honey-beer or honey-wine is commonly drunk by most of the tribes of South and East Africa. In Nigeria, honey and millet is a favourite drink (A. J. N. Tremearne, 'Notes on the Kagoro and other Nigerian Head-Hunters,' *JRAI* xlii. [1912] 177).

The honey of the wild black bee, which is used by the Bathonga for purposes of divination in magical horns, is obtained by digging out the nests, which are some two to three feet underground. Although any one may eat the honey, the nests can be found only by members of certain families (H. A. Junod, *The Life of a South African Tribe*, London and Neuchâtel, 1912, i. 363).

The Anyanja of Central Africa, whose only bread is a roll called *mkate* made of maize-flour, bananas, and honey, use honey from the nests of wild bees, found in hollow trees, but the river people hang cylindrical boxes on the trees in which the wild bees build. The cylindrical bee-box is in use as a hive for wild bees among most East African peoples. Rights of property in these boxes are recognized. Among the Atharaka, who cultivate honey in barrels similar to those in use among the Akamba, ownership is established by brands consisting of elaborate arrangements of dots and strokes. Honey is taken by smoking the bees, and is eaten or, more frequently, used for making beer (A. M. Champion, 'The Atharaka,' *JRAI* xlii. 81). Both the Akikuyu and the Akamba regard the theft of honey as a serious offence. The Akikuyu enforce strictly the equitable distribution of a dead man's property, of which honey forms an important part. After the death of a father, none of the sons may go into the woods to take honey from the father's hives until the paternal uncle has done so. Any who break the law become *makwa*, and can take honey only when the paternal uncle has provided a sheep to be sacrificed, after due observance of a ritual, by one of the elders.

It has been suggested that the custom has been devised to prevent appropriation of the honey before the estate has been regularly divided up (C. W. Hobley, 'Further Researches into Kikuyu and Kamba Religious Beliefs and Customs,' *JRAI* xli. [1911] 412).

The Rock Veddās of Ceylon recognized the rights of a family group to collect honey over certain lands from which other families were barred. With them, honey was used not only as a staple of diet, but also as the chief article of barter. The importance attached to it is indicated by the elaborate ceremonial preceding the honey-getting to propitiate the spirits and secure a good crop. It is recorded that in olden days a hollow bough containing a wild bees' nest was frequently kept in the rock shelter. The nests are usually found in clefts in the cliffs, and the honey is taken by men who swing down by ladders. Boys are systematically taught to collect honey (C. G. and B. Z. Seligmann, *The Veddās*, Cambridge, 1911, pp. 62, 91, 252 ff., 326 ff.).

Honey is also used as an article of barter among the Suk of East Africa, honey-wine being part of the price for which a stranger may hire land, the other part being two goats. The meat is eaten by the fighting men of the tribe, while the elders drink the wine (M. W. H. Beech, *The Suk*, Cambridge, 1911, p. 17). The Masai youth opens negotiations for his marriage by sending a pot of honey to the parents of his future bride (J. R. L. Macdonald, 'Tribes met with during the Juba Expedition of 1897-99,' *JAI* xxix. [1899] 233).

The custom of reserving the honey-wine for the elders also obtains among the Akikuyu, except at certain festivals, and the Masai. At the Masai circumcision ceremonies, the honey-beer, which forms an important part of the feast, may be drunk only

by the elders (S. Bagge, 'The Circumcision Ceremony among the Naivasha Masai,' *JAI* xxxiv. [1904] 167, 169).

5. Honey was largely used by the ancient Egyptians as an *ingredient in medicine*, and appears frequently in the formulæ of the Ebers and other medical papyri. Pliny (*HN* xxii. 50) gives a long list of bodily disorders for which it was believed to be an efficacious remedy. The Greeks regarded a diet in which honey was the chief element as especially efficacious in securing longevity; and Democritus was said to have delayed his death some days by its smell or exhalation (*ἀναφωρά*) alone (Athenæus, ii. 47 f.). In Brand's *Popular Antiquities* (1870 ed., iii. 54), old honey is mentioned as a favourite cure for cough or bile, and is said to increase strength and virility.

Medicinal and health-giving properties are attributed to honey by primitive races as well as by the ancients. The Veddas regarded the good health they formerly enjoyed as due to the fact that at one time their diet consisted largely of honey (Seligmann, 326). The Akikuyu medicine-man mixed honey with the decoction of herbs which he administered in cases of illness (H. R. Tate, 'Further Notes on the Kikuyu Tribe of British East Africa,' *JAI* xxxiv. 262).

Possibly the same idea underlies the custom followed by the Wa-Sania of British East Africa which decrees that, after the birth of a child, the mother during the period of seclusion shall eat only honey mixed with hot water. Male children after circumcision, which takes place at the age of three or four years, for seven days eat nothing but honey mixed with a very little water (W. E. H. Barrett, 'Notes on the Customs and Beliefs, etc., of the Wa-Giriama of British East Africa,' *JRAI* xli. 28, 31). Nandi boys, after circumcision, must eat from honey-barrels, and not from their usual hide-platters (A. C. Hollis, *The Nandi*, Cambridge, 1909, p. 55). In Madagascar, before circumcision, a drop of honey is placed on the tongue (J. Sibree, *The Great African Island*, London, 1880, p. 814), while in India the Deccan Brâhman drops honey into the mouth of the newborn child; the higher-class Hindus, especially the Brâhmins, do the same, but use a gold spoon or a ring (J. M. Campbell, 'Notes on the Spirit Basis of Belief,' *IA* xxiv. [1895] 259). Honey is sometimes used among the Muhammadans of the Panjâb as the chief ingredient of the *ghuṭṭ* given frequently for a period extending over some days to a new-born child by the most respected matron of the family, as a part of the birth ceremonies, in order that the child may absorb her virtues (H. A. Rose, 'Muhammadian Birth Observances in the Punjab,' *JRAI* xxxvii. [1907] 242).

6. Honey was regarded by the ancients as a substance of great purity, not unnaturally, in view of the supernatural origin and powers attributed to bees in primitive belief. Milk and honey in the early Christian Church was held to suggest consecration, while a portion of milk and honey was placed in the mouth of the newly-baptized, in allusion to the name anciently given to Canaan (Augusti, *Christl. Archäol.*, Leipzig, 1836, ii. 446; cf. also Drews, *PRE³* xii. [1903] 704). On the other hand, in some of the instances cited, honey was administered at critical seasons, namely, at initiation or soon after birth, when evil spirits might be expected to be specially potent. Honey and sweet things were believed to drive evil spirits away. In the ceremonies following birth among the Hindus of the Panjâb, sweetmeats play an important part, and at one stage are passed around the head of the child for the stated purpose of driving away evil spirits (H. A. Rose, 'Hindu Birth Observances in the Punjab,' *JRAI* xxxvii. 231). Marriage is another occasion on which the influence of malignant powers is specially to be feared, and we may attribute the use of honey in marriage ceremonies to its power over spirits, even though another explanation of the custom be offered by the people themselves—usually that it will secure harmony in married life. Among the Deccan Hindus, when the bridegroom comes to the bride's house, honey and curds are given him to sip. In Bengal the bride has certain parts of her body anointed with honey. The gypsies and other peoples of the Balkan Peninsula follow the same custom.

Among the gypsies in Servia, in the course of the ceremonies which last for several days preceding the marriage, the bridegroom sends the bride skeins of yellow silk, and the next day these are stuck all over her face with honey and purple stain. She then leaves her father's house, and is driven to that of her father-in-law in a cart. On her arrival, there is handed to her by her mother-in-law a sieve of oats and some honey. She scatters the oats from the sieve and smears the honey on the door-posts.

In Croatia and Turkey a cup of honey is handed to the bride at the door. The Poles ornament the bride's lips with honey. At Vlach weddings, the bride is given honey and butter with which to anoint the door. It is also the custom among the Balkan peoples mentioned above for the bride and bridegroom to eat together, in the evening, a cake baked some days before, which is dipped in honey as it is eaten (E. O. Winstedt, 'Forms and Ceremonies,' *Journ. Gypsy Lore Soc.*, new ser., ii. [1909] 352 f.). Among the Bathonga, however, who regard honey as a 'mysterious thing,' a man visiting the relatives of his betrothed must avoid honey, and it must not be eaten in the presence of the bride in the first year of married life; if she perceived that her husband had eaten honey, she would return to her parents 'as honey flows' (Junod, *op. cit.* p. 239).

Among the Argives a cake made with honey was sent from the bride to the bridegroom (Athenæus, xiv. 645). In Modern Greece the priest, bride, and groom walk round the altar through the incense fumes while the guests pelt them with sweetmeats, and among the peasantry honey is smeared on the lintel of the young bride's door (R. Rodd, *Customs and Lore of Modern Greece*, London, 1892, pp. 91, 96). In connexion with the power of honey over evil spirits, significance attaches to the belief in its cleansing powers held by the Hindus, who use it to wash their household gods.

7. An explanation of the power of honey as a protection against evil spirits may be sought in its use in connexion with religious ritual. Reference has been made to the belief in its purity. By this quality it was peculiarly fitted to be the food of the gods. In the Rigveda, it was regarded as of divine origin; the *Asvins* carry it to the bees (cf., further, Macdonell, *Ved. Myth.* p. 49 f. [*GIAP* III. i. A. (1897)]; Hillebrandt, *Ved. Myth.*, Bonn, 1891-1902, i. 239-241). It is held to be the food of the gods and of divine origin by the Hindus; and, when they take the honey from the hive, they hold in their hand a plant (*Ocimum nigrum*) sacred to Viṣṇu. Viṣṇu, it will be remembered, was represented as a bee on a lotus leaf, while Kṛṣṇa has a blue bee on his forehead. Honey-mixture was employed in greeting a king, Brâhman, or other guest of honour (Manu, iii. 119 f.; Hillebrandt, *Rit.-Lit.* p. 79 [*GIAP* III. ii. (1897)]), and it is also employed in the Vâjapeya sacrifice (*Satapatha Brâhmana*, v. i. 1. 6 ff.; *Kâtyâyana* XIV. ii. 9, iv. 15-18; cf. on this Hillebrandt, 141-143). It is one of the substances given a new-born child in the *Âyusya* rite and at its first feeding with solid food at the age of six months, as well as, according to *Kausika Sûtra*, xxiii. 1, at the first meal eaten in a new home; and it is also enjoined as part of the sacrificial food at the *Anvaṣṭakya* in honour of the manes (Hillebrandt, 45, 48, 82, 95; see also Hillebrandt, *Ved. Myth.* i. 238-244). In Finnish mythology the bee is implored to fly over the moon and sun into the dwelling of the creator and to carry health and honey to the god (de Gubernatis, *Zool. Mythology*, London, 1872, ii. 218). In Teutonic mythology, honey was the chief ingredient of the divine drink (Grimm, *Teut. Myth.*, tr. Stallybrass, London, 1882-88, ii. 695 f.), as was nectar among the Greeks. In the Edda a divine fall of honey trickled from the tree Yggdrasil. The Nandi believe that the Thunder-god takes honey from their barrels from time to time (Hollis, 135),

while the Veddas invoke the *yakina* (the female spirits who form one of the chief elements in their religious beliefs) in the ceremony which precedes the taking of honey; they are closely associated with the bees, because they live at the top of high rocks, and some of the honey is poured on the rocks for them when the nests are taken—an ancient custom called 'to charm the drawing of honey' (Seligmann, pp. 162, 252, 291).

Honey thus forms a peculiarly appropriate offering to the gods. It was, however, forbidden to the Jews to offer it on the altar (Lv 2¹¹), Maimonides says (J. Townley, *The Reasons of the Laws of Moses: from the 'More Nevochim' of Maimonides*, London, 1827, p. 275), because the heathen nations around offered honey to their gods; according to another suggestion, it was prohibited because it fermented and gave off an unpleasant smell when burnt (Aben Ezra), which was incompatible with a 'fire of sweet savour.' Firstfruits and honey, however, were offered for the support of the high priest (2 Ch 31⁶). A papyrus fragment found at Oxyrhynchus, dating from the 2nd cent. A.D., contains a bill for, among other things, '16 cakes, oil, honey, milk, and every spice except frankincense,' supplied to the Strategus of the nome for 'the sacrifice of the most sacred Nile.' The offering of a honey cake is of frequent occurrence in Greek ritual, especially in connexion with chthonian deities, apparently because bees were regarded as the souls of the dead (Gruppe, *Gr. Mythol. und Religionsgesch.*, Munich, 1906, p. 801; cf. 909 f.), and honey was also used in rain-charms (*ib.* 801, 819).

Athenæus (xiv. 645) mentions cakes offered to Artemis when the sun was rising and the moon setting. Though no mention is made of honey in their composition, it may be recalled that a priestess of Artemis and Demeter was known as Melissa. At Lebadea, at the shrine of Trophonios, the suppliant went with an offering of a honey cake in each hand for the prophetic snake. A honey cake was put in a hole for the goddess Ge when a certain medicinal herb was gathered in Attica. Cakes of barley and honey were thrown down a chasm near the sanctuary of Ge in the *temenos* of Zeus Olympios at Athens every year (L. R. Farnell, *CGS* iii. (Oxford, 1907) 10 ff.). Sosipater at Olympia had, like Trophonios and Erechtheus, the snake's service of the honey cake (see Pausanias, vi. xx. 8, 6). The cakes were brought for the serpent, the animal form of the god. Sosipater is apparently the fertility spirit (J. E. Harrison, *Themis*, Cambridge, 1912, p. 282), but the snake is usually associated with the chthonian aspect of Greek belief; and the other chthonian deities mentioned, though connected with fertility, were prominent in their connexion with the under world.

8. Honey was included in the offerings to the dead. The sweet beer of the Egyptians is mentioned in the Liturgy of Funerary Offerings as well as various kinds of sweetmeats. In view of the fact that the offerings as a whole were intended as food for the dead (*q.v.*), it would be unsafe to lay too much stress upon this custom as evidence for a peculiar connexion of honey with the spirits. There are, however, several customs followed in parts of Africa which suggest a course of development in which an offering, of which honey forms a part, becomes a protection. In Abyssinia, honey-beer is drunk before a solemn conference. Among the Suk, before drinking a fresh brew of honey-wine, the elder entrusted with the wine-jar fills a cup and pours the wine out on each side of the door, invoking the spirits of the dead to keep them in safety. The elders of the Kikuyu of East Africa, at a burial, pour some honey and cooked fat on the grave after it has been filled in, saying: 'We give you this to drink' (Hobley, *JRAI* xli. 419). Further, in the course of the ceremony by which the *kirume*, or dying curse, is removed, the elders, or rather the members of the special class of elders competent to perform the ceremony, pour fat, milk, honey-beer, etc., into a hole in the ground. From other elements in the ceremony it appears that this is an offering to the spirit of the

departed, but in the underlying ideas propitiation and protection closely approximate. The identification of the two aspects appears to be complete in the folk-stories of the Ekoi of S. Nigeria, in which it frequently happens that the living who have penetrated to the land of ghosts are pursued on their return, and save themselves from further pursuit by spreading food across the entrance to their town (P. A. Talbot, *In the Shadow of the Bush*, London, 1912, p. 36).

LITERATURE.—See references given in the article. For beliefs and practices connected with honey, especially in India, see J. M. Campbell, 'Notes on the Spirit Basis of Belief and Custom,' in *IA* xxiv. (Bombay, 1895) 259. References for the use of honey in Ancient Palestine will be found in *EBI*, and in McClintock-Strong's *Cyclop. of Bibl. Literature*, New York, 1872, s.v.

E. N. FALLAIZE.

HONOUR.—1. Ethics.—Honour is high regard or esteem, whether felt, given, or received. It implies, like honesty (*q.v.*), a sense of what is due or right, and fidelity to one's obligations; like 'honesty,' it is used from Gower onwards (see *OED*, s.v.) of chastity or purity; and, finally, it takes on a concrete, objective meaning as equivalent to exalted rank or position (or in plur. of marks of regard, distinctions, decorations, and the like). The word has passed into colloquial speech in such phrases as 'on one's honour,' 'honour bright,' etc. (see *OED*). In the phrase 'code of honour,' the word implies 'a certain system of reciprocal rights and obligations . . . and also the individual's recognition of these' (see *DPhP*, s.v.), and in such phrases as 'the honour of an artist' or 'a soldier,' or 'the honour of the army' or 'the church' and other institutions, we have a personal or collective connotation implying recognition of self as a member of this or that community or class or profession. Sometimes the phrase amounts to little more than reputation, e.g. 'the honour of a husband,' when impaired by conjugal infidelity or the failure to observe personal obligations.

The 'code of honour' is a species of etiquette observed by particular classes, trades, professions, etc. It thus belongs to the department of 'minor morals' (see Mackenzie, *Manual of Ethics*⁴, p. 7, who points out the ethical value of 'Mrs. Grundy' and other conventional laws as safeguards against wrong and injustice). Whether honour takes the form of high-mindedness in business or commercial transactions, or of politeness and good-breeding in society, or of loyalty to one's particular class or caste or denomination, it is to be placed among the virtues as a descendant of benevolence ('justice touched with emotion'; see Muirhead, *Elem. of Ethics*², p. 201). The duties imposed by the code of honour in graver matters, or the code of politeness or good-breeding in lighter matters, according to Sidgwick (*Methods of Ethics*, p. 31), are often undistinguished from moral duties by unreflective persons; e.g., there is the practice of duelling (*q.v.*)—a custom which is imposed by an unethical society and which an individual may reject on moral or religious grounds. His conduct would be classed by some as dishonourable, by others as a virtuous act. Thus 'honour' not infrequently involves a conflict with ethical right in certain stages of social development. No discrepancy is felt, e.g., in Hellenic civilization, where the idea of *καλοκάγαθία*, the code of honour, and the moral code are not differentiated as they are in mediæval and modern times. See the valuable discussion in *DPhP* already quoted, where the distinction is described as 'a purely sociological distinction quite independent of ethical theory,' and where reference is made to subtle points of casuistry arising out of the distinction, as when a freemason betrays his country rather than a member of his own chapter (honour *versus* honour). We find a similar conflict of duty in the well-known

couplet of the Elizabethan song-writer, Sir Richard Lovelace,

'I could not love thee, dear, so much,
Loved I not honour more,'

where it is implied that the passion of love has to be subordinated to the higher morality.

In Christian ethics the idea of honour is associated with belief in a moral Judge. So v. Haering (*Ethics of the Christian Life*, Eng. tr., p. 256 ff.) remarks that 'in the idea of "honour" there is the implicate of the splendour of the Good as exhibited to a judge, whether this judge is the person himself or another; or, finally, God as the reader of all hearts, and the sole Judge of all.' The same writer proceeds to argue that to strive for recognition by a moral judgment is a task which the Christian cannot forgo, and quotes with approval Luther's saying at Worms: 'They have deprived me of fame and honour, but sufficient for me is my Saviour and Redeemer Jesus Christ.' The honour of man is always subordinated by NT writers to the honour to be hereafter accorded by a Righteous Judge (cf. Ro 2⁷, 'seek for glory and honour and immortality'; and I P 1⁷, 'found unto praise and glory and honour,' where the idea of a future life is prominent). But the honour of the Judge perpetuates the honour of this world. The Pauline distinction (2 Ti 2²⁰) of vessels 'unto honour' and 'unto dishonour' implies a destiny belonging to time, whatever may be the final issues; it is the destiny of unselfish service, in which the particular ability of the individual is consecrated to the uses of the Master of the 'great house.' The only scintilla of honour belonging to the sinner is, according to v. Haering, the fact of his eternal destiny—a statement which largely defines the assumption underlying Christ's teaching regarding man; for to Him humanity, even in its most degraded form, is endowed with immortality.

2. Psychology.—We may derive some hint as to the psychological value of honour in Paulsen's definition of honour, social or political, as 'ideal self-preservation' (*System of Ethics*, Eng. tr., ch. vi.); or in v. Haering's remark that 'shame is the guardian of honour' (*op. cit.* p. 257), which implies that there is a connexion between the moral concept involved in honour and an emotion which, according to Macdougall (*Social Psychology*, p. 145), is 'second to none in the extent of its influence upon social behaviour.' The conduct of the man of honour is undoubtedly regulated by social blame and praise. The very idea of 'honour' involves a reference to our social surroundings, the circle in which we move, or the larger world to which our influence inevitably extends. Psychologically, this is an advance on an earlier stage in the development of self-consciousness when natural impulse is regulated by the system of rewards and punishments imposed upon us by external authority, e.g. in the family or the school. It is a distinct advance when character and conduct are alike shaped by regard for the moral approval and disapproval of our fellows. Finally,

'this regard leads on sane men to the higher plane of conduct, conduct regulated by an ideal that may render them capable of acting in the way they believe to be right, regardless of the approval or disapproval of the social environment in which their lives are passed' (Macdougall, *op. cit.* p. 202).

The nobler sense of honour which we associate with the saint or with natures peculiarly sensitive and refined lifts such individuals far above the coarse consideration of the verdicts of the circle to which they belong. R. Browning's Rabbi ben Ezra, with his conviction,

'All I could never be,
All, men ignored in me,
This, I was worth to God,'

expresses devotion to a spiritual ideal which is

unaffected by the praise or blame of men. At the same time, no ideal of conduct can be perfect unless it is a synthesis of the self-regarding and altruistic sentiments. The life of honour is one which we aim at realizing for all men, while we seek its perfection for ourselves.

LITERATURE.—H. Sidgwick, *Methods of Ethics*⁶, London, 1901; T. H. Green, *Prolegomena to Ethics*³, Oxford, 1890; J. H. Muirhead, *Elements of Ethics*³, London, 1910; J. S. Mackenzie, *Manual of Ethics*⁴, do. 1900; F. Paulsen, *System of Ethics*, Eng. tr., do. 1899; T. v. Haering, *Ethics of the Christian Life*, Eng. tr., do. 1909; H. Rashdall, *The Theory of Good and Evil*, Oxford, 1907; W. Macdougall, *Introd. to Social Psychology*⁵, London, 1912.

R. MARTIN POPE.

HOOKER. — 1. Life and works. — Richard Hooker, author of *Of the Laws of Ecclesiastical Polity*, was born at Heavitree, a suburb of Exeter, probably in March 1553–54. He was the son of Roger Hooker and his wife Joan. Roger and his elder brother John are described as the fifth in descent from Iago Vowell of Pembroke, who married the daughter and heir of Richard Hooker of Hurst Castle, Southampton. Vowell is, therefore, probably the Welsh surname. Roger's father and grandfather, with the name Hooker, filled the position of Mayor of Exeter in the years 1529 and 1490. His brother John, as a result perhaps of his genealogical researches, described himself in early years as Vowell *alias* Hooker, and later in life as Hooker *alias* Vowell. This uncle's influence upon Richard's career was of such importance, and his work as an antiquarian and historian in originality and thoroughness has so much in common with the more famous achievement of his nephew, that some account should be given of him in any description of Richard's life.

John Hooker's father died when he was about ten years old, and John was educated by Dr. Moreman, Vicar of Menheniot, in Cornwall. He proceeded to Oxford, to Corpus Christi or to Exeter College, where he engaged in legal studies, but took no degree. From Oxford he went to Germany, pursuing his legal studies at Cologne and also at Strassburg, where he lodged in the house of Peter Martyr, and acquired a sympathy with his religious position. Further travels on the Continent were stopped by war, and he returned to Exeter to devote himself to 'the reading of histories and seeking of antiquities and somewhat to armory.'¹ He was made first chamberlain of the city in 1555. He has left large collections regarding the history of Exeter; but his chief literary monument is his edition of Holinshed's *Chronicles* in 1586–87, and his own contributions to that compilation. He is the author of a graphic account of the rebellion in the West country in 1549, and of recent Irish history. He went to Ireland as the agent of Sir Peter Carew of Mohun's Ottery, near Exeter, who claimed estates in Ireland, and found John Hooker's skill in deciphering and interpreting old deeds and records very useful in promoting his claims. Hooker's first letter from Ireland, dated May 1568,² urges Sir Peter to come to Ireland, and advises him to engage as his steward, to manage his Irish household, Roger Hooker, the writer's brother and the father of Richard. Roger had been 'sometime servant and steward to Sir Thomas Chalonier,' and 'now dwelleth with the old Lady Mountjoy.' It is clear, therefore, that Roger's education and social status were below his brother's. Sir Peter brought Roger to Ireland in 1568, and we find him writing as steward from Leighlin, County Carlow, to ask for protection against rebel raiders. He is stated to have died in 1591. John outlived his more famous nephew, dying in November 1601.

We can now turn to Isaac Walton's *Life of Richard Hooker*, which was undertaken at the request of Archbishop Sheldon, in consequence of the imperfections of the *Life* prefixed by J. Gauden to his edition of Hooker's *Works*, published in 1662. Walton's famous and beautiful biography appeared in 1665, and has become one of the classics of English literature. But in using it one ought to keep in mind that Walton was born in 1593, and was therefore only seven years old when Hooker died, and allowance must be made for the 17th century tone and atmosphere of the biography, which is conveyed with such exquisite literary art. The facts we have given above explain why we hear nothing of Hooker's father in Walton's *Life*;

¹ Harleian, 5827, p. 51, Brit. Mus. Lib.

² John Maclean, *Life and Times of Sir Peter Carew*, London 1857 pp. 202, 222, 223.

they also give a reason why a special effort should have been made to send Richard to college in 1568—because both his father and his uncle were out of England. John Hooker had made the acquaintance of Jewel in 1559, when the Government appointed the latter a commissioner in the West, and it was natural that he should seek the Bishop's help in sending his promising nephew to college. Walton tells us that Richard's exceptional ability was discovered by the schoolmaster of Exeter Grammar School, who declared him a 'little wonder.' But it is Walton rather than the schoolmaster who gives the description:

'At his being a schoolboy he was an early questionist, quietly inquisitive why this was and that was not to be remembered; why this was granted and that denied! This being mixed with a remarkable modesty and a sweet, serene quietness of nature.'¹ Bishop Jewel's patronage obtained for the lad admission to Corpus Christi College, Oxford, probably at first as chorister, and afterwards as clerk; but on Jewel's death in 1571 his pension failed, and Richard's maintenance at college was difficult. His name occurs five times between 1570 and 1575 in the list of poor scholars helped by the London merchant, Robert Nowell.² In 1582 the 'Mayor and Chamber' of Exeter granted him a pension of £4. This last assistance was, no doubt, obtained by the influence of John Hooker, who was not the 'rich uncle' Walton supposes him to have been. But the President of the College, W. Cole, out of regard for Jewel and also from a perception of the unusual gifts of his pupil, befriended him steadily. The appointment of the choristers and the clerks was in Cole's hands. It was not till December 1573 that Hooker was admitted one of the twenty *discipuli*, or scholars, of the College. To help towards his maintenance, pupils were obtained for him. Jewel's friend Sandys, Bishop of London in 1571, interested himself in this matter. His son Edwin, at about the age of twelve, was put under Hooker's charge (the tutor being nineteen), as well as a younger lad, George Cranmer, a great-nephew of Archbishop Cranmer. To the list of those who befriended Hooker in his need we must, no doubt, add his tutor John Reynolds, who came from the village of Pinhoe, close to Exeter.

A full account of the history of Corpus Christi College during Hooker's residence, with a careful treatment of the question of his maintenance, has been written by T. Fowler, and it forms a valuable and important addition to the *Life* by Walton. The latter makes it clear that the chief influences upon the young student were those of the dominant school of evangelical reformers. His patron Jewel remained for Hooker 'the worthiest divine that Christendom hath bred for the space of some hundreds of years';³ while his tutor Reynolds, who became President of the College in 1598 and the leader of the 'doctrinal Puritans' at the end of the century, was Hooker's critic and confidant throughout the composition of the *Ecclesiastical Polity*. It is, therefore, of special interest to find in Fowler's *History* the point established that there existed in Corpus Christi College 'the leaven of secret Romanism . . . long after the Reformation was definitely settled, certainly through the reign of Elizabeth.' This fact may in part explain Hooker's enlightened use of Roman Catholic books and authorities. Among his fellow-collegians were men of ability and scholarship who sympathized with the old religion, but had yet learned of necessity to respect and tolerate the new. Hooker's natural passion for truth and tolerance would make him instinctively appreciate and assimilate this attitude of mind.

¹ Church and Paget, l. 7.

² See Grosart's *The Spending of the Money of Robert Nowell*, Manchester, 1877, pp. 206, 220, 224, 226; and T. Fowler's *Hist. of Corpus Christi College*, Oxford, 1893, p. 149.

³ Church and Paget, l. 814.

There is extant a short Latin tract,¹ written probably between 1582 and 1585, by a certain Nicholas Morice, one of the Fellows of Corpus Christi College. It is an account of the yearly journey of the President and Fellows to collect the rents of their estates, and is written with amusing vivacity and humour. The writer sympathizes with the old religion: 'A good Papist I love; for an honest Protestant I can die the death; but an aged trimmer, as I live, I abominate.'² He gives us one glimpse of Hooker. A steward has made a foolish speech; 'if Reynolds had been listening,' says Morice, 'he would have averted his eyes at many parts; if Hooker, he would have smiled, with bent head.'³ Walton testifies in famous words to Hooker's bashfulness at the end of his life, when 'his poor parish clerk and he did never talk but with their hats both on or off at the same time'; but his biography does not take into account Hooker's humour which Morice's remark recognizes. William Nutt, for whom Morice wrote his dialogue, was another Fellow of Corpus, obviously of kindred tastes and sympathies. This party in the College was not without its influence on Hooker's development. It ought perhaps also to be remembered that Corpus Christi College was founded in the early part of the century by Bishop Foxe when the 'new learning' of Erasmus and Colet was influencing educational ideals. Foxe appointed a lecturer in Greek, and attempted in theology to replace mediæval schoolmen by the Greek and Latin Fathers of the early centuries. Hooker's rationalism may have been fostered by the traditions of his College and his study of Theodoret and Augustine.

Hooker graduated B.A. in 1574, M.A. in 1577, and was made a full Fellow of his College in 1579. His special work was to lecture in Logic; and from this, according to Wood, 'his fame grew.' His writings, both in their vocabulary and in general form, retain throughout signs of his early pre-occupation with logical terms and logical analysis. In 1579 the Regius Professor of Hebrew was ill from some obscure mental disease, and Hooker was appointed his deputy, and delivered the Hebrew lecture while he remained in Oxford. There is no record when he took orders; but it was before 1581, when he preached in London at St. Paul's Cross. It is probable that his reputation at Oxford was the reason of his being invited to preach this sermon, which was in a true sense the beginning of his career. It contained a distinction between God's 'antecedent' and 'consequent' will, which was supposed to contradict a pronouncement of Calvin (*Inst.* iii. 24, § 16), that 'nothing is less accordant with the nature of God than that He should have a double will.' Hooker was, therefore, branded as a man who refused to treat Calvin as infallible. He had probably no intention of opposing Calvin, but from the first the spirit of his preaching and teaching was free, and acknowledged no master but the truth.

The visit to London resulted also, according to Walton, in Hooker's unfortunate marriage to Joan Churchman. R. W. Church has shown reason for doubting the accuracy of Walton's picture of Hooker's married life. It was not till December 1584 that Hooker was presented to the vicarage of Drayton-Beauchamp in Buckinghamshire, and it seems probable that his decision to give up his Oxford life was come to when he was ordained, and was not forced upon him by Mrs. Churchman, as Walton would have us believe. If Hooker had acted with the ludicrous weakness of Walton's story, his friends could hardly have recommended him to Whitgift⁴ for the position of Master of the Temple. Hooker was not Whitgift's first choice. His candidate was a certain Dr. Bond, whom the Queen considered too old for the post. Lord Burghley supported Walter Travers, already the afternoon lecturer at the Temple. Hooker was ap-

¹ *Dialogus de Illustratione Geitonica, qui inscribitur Nuttus*. It is in the Bodleian Library.

² 'Papistam equidem ingenium diligo: pro honesto Protestante emori possum: neutrum seniculum, ita vivam, abominor.'

³ 'Si Hookerus, demisso capite, subrisisset.'

⁴ Whitgift writes to the Queen about the Mastership that 'the living is not great, yet doth it require a learned, discreet, and wise man.'

pointed Master on 17th March 1584-85, perhaps by the support of Archbishop Sandys and Bishop Aylmer; but all the circumstances indicate that he was a man whose ability, learning, and piety were well known, and from whom much might be expected. What immediately followed upon his appointment was a pulpit duel between himself and Walter Travers, the afternoon lecturer, which increased in intensity until, in about a year's time, Travers was inhibited by the Archbishop. Travers at once wrote a 'Supplication' to the Privy Council in defence of his conduct. Hooker replied in an 'Answer,' which he addressed to Whitgift. Besides these documents, there are extant certain sermons in Hooker's *Works* which contain those opinions of Hooker which Travers specially attacked. These are the sermon 'of the Certainty and Perpetuity of Faith in the Elect,'¹ and the 'Learned Discourse of Justification.'² They were printed by Jackson in 1612; and, while the first can be identified satisfactorily with a sermon objected to by Travers, the second is not a sermon, but an amalgamation of several sermons which cannot be quite certainly related to those mentioned by Hooker and Travers. From these documents it is clear that the first cause of difference between the two men was Hooker's refusal to be a party to Travers' attempts to introduce surreptitiously into the congregation his own Presbyterian methods and practices. Travers wished Hooker to submit to some ceremony of 'allowance' by the congregation, because he held that Hooker had been ordained 'by virtue only of a human creature'; he objected to Hooker praying before his sermon instead of after, to his mentioning bishops in his prayer, and to his kneeling at the reception of the Holy Communion. On these points the two rivals conferred together without coming to any result, so that, as Hooker says, quoting from Travers, it was natural enough that 'many of my sermons have tasted of some sour leaven or other.' Travers' complaints against Hooker's preaching deal with three occasions. He brought up again the sermon of 1581 already referred to; he objected to a position of Hooker, 'that the assurance of that we believe by the Word is not so certain as of that we perceive by sense'; but, thirdly, the matter which finally roused Travers to deliver 'three public invectives' against the Master's teaching was a remark about Roman Catholics. The 'mother-sentence whereof I little thought that so much trouble would have grown' was

'I doubt not but God was merciful to save thousands of our fathers living in popish superstitions, inasmuch as they sinned ignorantly.'

Travers understood Hooker to say 'the fathers,' but his outcry caused Hooker to attempt that summary of the good and bad in the Roman Church which is contained for us in the extant 'Discourse of Justification.' He was, no doubt, unaware of the strength of the fanaticism against which he was measuring himself. He was anxious to be fair to his Roman adversaries, and not to 'give them an occasion to say, as commonly they do, that, when we cannot refute their opinions, we propose such instead of theirs as we can refute.'

Hooker therefore outraged the prevailing Puritan views on two crucial points: he declined to accept Calvin's opinion as final, and he insisted on giving even Rome a fair hearing. His originality on these two points has not been justly appreciated. Even to-day his point of view is not fully accepted by controversialists. We must realize upon what broad grounds his practice was based. Travers complained³ that Hooker had said to him 'that his best author was his own reason'; Hooker replied indignantly:

¹ Sermon i., in Church and Paget, iii. 469.

² Sermon ii., *ib.* iii. 483.

³ Travers' 'Supplication,' *ib.* iii. 559.

'I alleged therefore [because Travers had objected to the quotation of authorities] that which might under no pretence in the world be disallowed, namely, reason; not meaning thereby mine own reason, as now it is reported, but true, sound, divine reason; reason whereby those conclusions might be out of St. Paul demonstrated, and not probably discoursed of only; reason proper to that science whereby the things of God are known; theological reason, which out of principles in Scripture that are plain, soundly deduceth more doubtful inferences, in such sort that being heard they neither can be denied, nor anything repugnant unto them received, but whatsoever was before otherwise by miscollecting gathered out of darker places, is thereby forced to yield itself, and the true consonant meaning of sentences not understood is brought to light. This is the reason which I intended.'¹

Passages like this and many others in the 'Discourse of Justification' reveal to us the ardent enthusiasm which burnt beneath the shy exterior of the lecturer in Logic. And to his passion for truth and for the search after truth a second characteristic has to be added which in all Hooker's writings is felt by the reader:

'I take no joy in striving, I have not been nuzzled or trained up in it. . . . There can come nothing of contention but the mutual waste of the parties contending, till a common enemy dance in the ashes of them both. . . . Things of small moment never disjoin them whom one God, one Lord, one Faith, one Spirit, one Baptism, bands of great force, have linked.'

These are the chief points of the dispute with Travers at the Temple. It is to be noted how important they were for the subsequent Church of England. Without the treatise 'Of the Laws of Ecclesiastical Polity' they might not have effected much; but, enlarged and expounded in the first five books of that work, they made the Church of England neither Rome nor Geneva, but a Church distinct from both. Hooker's treatise did for the Church of England what Calvin's *Institutes* had done for the Genevan Church; it gave it a voice and a character. It is tempting to dwell on the many anticipations of the *Polity* which are to be found in these early writings of Hooker, and it is necessary to insist upon their importance, both as historical documents and as revelations of Hooker's mind and disposition. But there is a difference between his point of view in the dispute with Travers and in the composition of the *Polity*. Hooker distrusted 'extemporal dexterity'; he believed time to be 'the only mother of sound judgment and discreet dealing'; and in this spirit he began to examine the questions that Travers had raised. But he found his position at the Temple incompatible with profound and concentrated study. He wrote to Whitgift that he was 'weary of the noise and oppositions of this place'; his contest with Travers had been

'the more unpleasant to me because I believe him to be a good man; and that belief hath occasioned me to examine mine own conscience concerning his opinions; and to satisfy that I have consulted the Scripture and other laws, both human and divine, whether the conscience of him and others of his judgment ought to be so far complied with as to alter our frame of Church-government, our manner of God's worship, our praising and praying to him, and our established ceremonies, as often as his and others' tender consciences shall require us: and in this examination I have not only satisfied myself, but have begun a Treatise, in which I intend a justification of the Laws of our Ecclesiastical Polity. . . . My meaning is not to provoke any, but rather to satisfy all tender consciences, and I shall never be able to do this, but where I may study, and pray for God's blessing upon my endeavours, and keep myself in peace and privacy and behold God's blessing spring out of my mother earth, and eat my own bread without oppositions.'²

He asks Whitgift to appoint him to a country living. Another draft of this letter speaks of his desire 'not to provoke your adversary Mr. Cartwright, nor Mr. Travers, whom I take to be mine (but not mine enemy).' When we read the *Polity*, we find, after the first book, that continually 'T. C.' is quoted as the recognized champion of those opinions for which Travers and his party at the Temple contended. Thomas Cartwright is Hooker's antagonist; Walter Travers is forgotten. This means that Hooker's book is a continuation and review of a controversy that had been going

¹ Hooker's 'Answer,' *ib.* iii. 594.

² *ib.* i. 67.

on since the beginning of Elizabeth's reign. Cartwright returned from Geneva to England in November 1572, probably in time to assist in the writing of 'A Second Admonition to the Parliament'; the first had appeared earlier in the year. In these appeals to Parliament the writers frankly declare their hostility to the English Church as established, and demand a reformation; they insist that the controversy is not 'for a cap, a tippet, or a surplice, but for greater matters concerning a true ministry and regiment of the Church according to the Word.' The tracts made a great impression, and Whitgift, with Archbishop Parker's approval, was called upon to reply to the Admonitioners. Before the end of 1572 he published 'An Answer to a certain Libel entituled An Admonition to the Parliament'; a second edition, augmented, was ready in 1573. Whitgift had been Vice-Chancellor of Cambridge University when Cartwright was deprived of his professorship¹ and his fellowship. T. C. therefore came forward as the champion of the Admonitioners against Whitgift. By the middle of 1573 he issued 'A Reply to An Answer made of M. Doctor Whitgift against the Admonition to the Parliament.' It was a book so much more considerable than the Admonitions that Whitgift could not leave it unanswered. In a folio of 800 pages he went over the whole controversy again, producing the work in 1574 and calling it 'The Defence of the Answer to the Admonition against the Reply of T. C.' The length of the book is partly due to Whitgift's fairness in printing large portions of the arguments of his opponents. Next year (1575)² Cartwright was ready again with 'The Second Reply of Thomas Cartwright,' which he followed up in 1577 with 'The Rest of the Second Reply.' To the 'Second Reply' of Cartwright no answer was made by Whitgift or by any other representative of the Church as established. Whitgift's friends thought that he had written all that was necessary on the controversy, and his appointment in 1577 to the see of Worcester left him no time for literary controversy. He was made Archbishop of Canterbury in 1583, and in his primacy the attempt to introduce a disciplinarian or consistorial system into the English Church was resisted and defeated. It was, therefore, providential for Whitgift that such a champion as Hooker appeared, to remove the reproach that Cartwright's last book had not been answered, and to review the whole controversy with a mastery of logical analysis, a breadth of learning, and a dignity of style beyond the reach of any other disputant. Hooker's book was the last word in the long controversy between Cartwright and Whitgift, but when the first instalment of it appeared in 1594 it was in spirit something altogether new. The sober Hallam declares that Hooker 'mingled in these vulgar controversies like a knight of romance among caitiff brawlers.'³ Because he was by temperament and conviction 'no mere champion,'⁴ he proved himself the judge and umpire of the lists.

Whitgift did not move Hooker from the Temple till 1591, when he appointed him to the parish of Boscombe, six miles from Salisbury, making him in the same year prebendary and sub-dean of Salisbury Cathedral. In 1595 he was presented to the Crown living of Bishopsbourne, near Canterbury, where he remained till his death. A chill 'taken in his passage by water betwixt London

¹ He was made Lady Margaret Professor in 1569.

² In the same year Walter Travers' celebrated treatise was published in both Latin and English, with a letter from Cartwright in its praise. It is called in English, 'A full and plain Declaration of Ecclesiastical Discipline out of the Word of God, and of the Declining of the Church of England from the same.'

³ *History of England*, London, 1850, t. iv. 214.

⁴ F. D. Maurice, *Moral and Metaphysical Philosophy*, London, 1873, II. 195.

and Gravesend' brought on his last illness. He made his will, 'though sick in body, yet sound in mind,' on 26th October 1600; it was proved on 3rd December. There is, therefore, no reason for doubting the Latin note in Archbishop Laud's copy of one of the books of the *Polity*, which states that Hooker died about 2 o'clock in the afternoon on 2nd Nov. 1600. His will made Joan Hooker, 'my well-beloved wife,' sole executrix, and 'my well-beloved father, Mr. John Churchman and my assured good friend,' Mr. Edwin Sandys, overseers. The inventory was £1092, 9s. 2d. It is probable, therefore, that Isaac Walton's account of Hooker's marriage is a distortion of the facts. That Hooker's faculties were unimpaired at the end of his life is clearly shown by the vigour, acuteness, and erudition of the notes he scribbled upon his copy of 'A Christian Letter,' an anonymous attack, published in 1599, upon bk. v. of the *Polity*.

2. The 'Ecclesiastical Polity.'—Only five books of the work entitled, 'Of the Laws of Ecclesiastical Polity, Eight Books,' were published in the author's lifetime. The Preface 'to them that seek, as they term it, the reformation of laws, and orders ecclesiastical in the Church of England,' and the first four books, without date, were published in 1594.¹ At the end of the Preface there was a short summary of the proposed eight books, indicating that in some form they were nearly complete at that date. It is probable that the defence of the Prayer-Book in bk. v., which is longer than all the others combined, became more elaborate than Hooker at first intended. The final description of the fifth book is different from that in the summary of 1594; Hooker finds he must resist the accusation that there is 'much superstition' in the Prayer-Book, and this necessitates a detailed examination of it. But for the effect which Hooker's book produced upon the public mind it was an advantage that it came out in instalments. The portion published in 1594 was in several respects so counter to popular tendencies, that, if there had been more of it, readers might have found it too much to assimilate. The Preface, just at the time when the infallibility of Geneva was becoming almost a dogma among the reformed Churches, reviewed Calvin's character and career impartially, recognizing him as 'incomparably the wisest man that ever the French Church did enjoy,' and praising 'his exceeding pains in composing the Institutions of Christian religion,' and 'his no less industrious travails for exposition of holy Scripture,' but insisting that 'wise men are men,' and that what Calvin did for the establishment of his discipline was 'more commendable than that which he taught for the countenancing of it established.' The Preface has not received the praise which it deserves as a piece of historical literature. If we compare it with the notes upon Calvin made in 1599 on the margins of the 'Christian Letter,' we shall realize that Hooker's account of Genevan affairs was founded upon a careful reading of Calvin's letters and other documents, and shall appreciate the restraint of its style. It is to be regretted that Hooker did not live to expand his note, 'Remember to make a comparison between Calvin and Beza. . . . For Beza was one whom no man would displease, Calvin one whom no man durst.'² But in the Preface the touch of irony and humour which Hooker allows himself is more effective than direct invective, and runs through his whole exposition of the claims and teaching of the disciplinarian party.

¹ They were entered in the Stationers' Register, 29th Jan 1592-93.

² Church and Paget, t. 134.

The most famous book of the *Polity* is the first. It deals with 'laws and their several kinds in general.' It shows that man is subject not to one law, but to many, and insists that the welfare of society depends upon the proper adjustment and correlation of these kinds of law. The inquiry is impressive in its scope and in the range of authorities upon which it is founded. There is a true imaginative grandeur in Hooker's vision of the whole universe of angels and men subordinated under God to the reign of law, which is in all its various forms essentially an expression of the Divine reason. Aristotle and the philosophy of Greece, the Greek and Latin Fathers, and, finally, St. Thomas and the schoolmen, are co-ordinated with the teaching of the Bible in support of an analysis which leads up to the position that 'to measure by any one kind of law all the actions of men were to confound the admirable order, wherein God hath disposed all laws, each as in nature, so in degree, distinct from other.' Hallam has pointed out that Suarez, writing on the Continent about the same time as Hooker, arrived at nearly identical conclusions.¹ Raleigh, in his *History of the World*, starts from Hooker, as an authority already recognized, and the famous passage on law is re-echoed on the stage² before 1611. In the latter half of the century, Locke's theories of civil government are founded upon quotations from 'the judicious Hooker.'³

The second book resists the Puritan assertion 'that Scripture is the only rule of all things which in this life may be done by men.' Hooker, admitting that Scripture is an infallible guide, denies that it is the only guide by which men are led, and carries the war into the enemies' camp in the remarkable passage which describes the results which would follow from the extreme Puritan position:

'For in every action of common life to find out some sentence clearly and infallibly setting before our eyes what we ought to do (seem we in Scripture never so expert) would trouble us more than we are aware. In weak and tender minds we little know what misery this strict opinion would breed, besides the stops it would make in the whole course of all men's lives and actions.'

The third book deals with the view 'that in Scripture there must be of necessity contained a form of Church polity, the laws whereof may in nowise be altered.' Hooker does not insist that the polity of the Church he is defending is contained in Scripture; the special point and merit of his argument is that he refuses to allow Scripture to be made a code strangling growth and reasonable freedom. Although he believes episcopal government to be Scriptural, he does not refuse to the Scottish and the French Reformed communions the title of Churches. He argues from the controversy on re-baptism in the African Church, in the time of Cyprian, that 'heretics are not utterly cut off from the visible Church of Christ.' All visible Churches, being human, have their blemishes and failures.

The fourth book concludes the general argument by considering the allegation that the English Church 'is corrupted with Popish orders, rites, and ceremonies, banished out of certain reformed Churches.' It therefore treats generally what the fifth book considers in detail.

The fifth book was published in 1597. It contains 81 chapters. The question of the manner of the ordination of ministers is not reached till ch. 76. The first 75 chapters review public worship as it was regulated by the Elizabethan Book of Common Prayer. In the dedication of the book

¹ H. Hallam, *Literature of Europe*, London, 1837-39, iii. iv. 20.

² In Lodowick Barry's *Ram Alley*, London, 1611; W. O. Hazlitt's *Dodsley* 4, do. 1874-76, x. 288.

³ H. Hallam, *op. cit.* ii. iv. 40.

to Whitgift, Hooker complains that the controversies concerning 'complements, rites, and ceremonies of church actions are in truth for the greatest part such silly things that very easiness doth make them hard to be disputed of in serious manner.' His treatise, therefore, at every point—whether he is discussing the use of the apocryphal books, or set prayers, or the use of the psalms, or the celebration of matrimony—strives to discover the first principles upon which practice is founded, and can never lose its interest while public worship is a part of religion. But the most important and masterly chapters are those in which he discusses sacraments and the Lord's Supper (chs. 50-57, and ch. 67). He rejects as discredited the extreme view that the bread and the wine are 'bare signs,' and claims that the 'Sacramentarian' or Reformed Churches have reached a 'general agreement concerning that which alone is material, namely, the real participation of Christ and of life in His body and blood by means of this sacrament.' The Lutherans and Papists also accept this 'general agreement'; and the only matter of dispute is 'about the subject where Christ is.' As to this, 'no side denieth but that the soul of man is the receptacle of Christ's presence.' Lutherans and Papists agree so far, but insist further that 'His body and blood be also externally in the very consecrated elements themselves,' either by consubstantiation or by transubstantiation. Hooker, therefore, makes the proposal, which is still too broad in its toleration to be accepted by the Churches: 'Let it be sufficient for me presenting myself at the Lord's table to know what there I receive from Him, without searching or enquiring of the manner how Christ performeth His promise.'

It can hardly be doubted that Hooker left the last three books of his treatise finished at his death, but the finished copies were lost or made away with, and the books as printed have not received final revision. The sixth book as we have it is not the examination of lay eldership promised in 1594, but a quite different treatise on penance. The genuine sixth book has disappeared. Books vii. and viii. are the rough copies of the promised discussions of episcopacy and the relations of Church and State. Books vi. and viii. were printed in 1648, book vii. in 1662.

LITERATURE.—The standard edition of Hooker's *Life and Works* is the revision by R. W. Church and F. Paget (7th ed., 3 vols., Oxford, 1888) of Keble's ed. of 1836, in 4 vols. Bk. i. of the *Polity* has been edited with notes and introduction by R. W. Church, 2nd ed., Oxford, 1876; bk. v. by R. Bayne, with notes and prolegomena, including a life of Hooker, in the *English Theological Library*, London, 1902. F. Paget prepared for the Clarendon Press an Introduction to bk. v. (Oxford, 1899). The first five books with two sermons are reprinted, with an Introduction by R. Bayne, in *Everyman's Library* (London, 1907). A careful Bibliography of early editions, Lives, general criticism, and literature is given in the *Cambridge History of English Literature* (Cambridge, 1909), iii. 547. Consult the Life in *DNB*, and the art. 'Richard Hooker,' in *EB*¹¹. The latest criticism of Hooker's style is in G. Saintsbury, *History of English Prose Rhythm*, London, 1912, ch. v. RONALD BAYNE.

HOOLIGANISM.—The word is derived from 'hooligan,' a street rough. Subjectively, it is a spirit or temper; objectively, an outbreak of lawlessness. It is usually applied to lads, sometimes to men and women, and always as a term of opprobrium for lawless behaviour.

i. Origin of the name.—Various origins have been suggested, some of them fanciful. (1) It is said to be due to the blunder of a policeman in describing a gang of young roughs as 'Hooly's gang'; (2) it is traced to a fictitious Irish character called 'Hooligan' (Irish for 'Hoolihan'), who figured weekly in a comic paper called *Nuggets* (*NQ*, ser. ix., vol. ii. [1898] pp. 227, 316). His German counterpart appeared in the *Garland* as

'Schneider.' According to *NQ* (15th Oct. 1898), 'Hooligan' and 'Schneider' had then been familiar personages for about five years. (3) It has been derived from a popular music-hall song which (about 1890) described the doings of a family named Hooligan. A writer in the *Evening News* of 21st Nov. 1900 said he had often heard the song sung, and quoted the following :

'There's a family living near us—
The Hooligans!
Always in some terrible fuss
Are the Hooligans.
Never known to tell a lie,
They'd sneak yer teeth, and say "Goodbye,"
They could drink the Carlton Brew'ry dry,
Could the Hooligans.'

Hooliganism is an international phenomenon. Witness the 'hoodlum' of California, the 'larrikin' of Australia, the 'khuligani' of St. Petersburg, the 'Hooligane' of Germany, and the 'Apaches' of France and Italy.

2. Characteristics.—Lack of self-control, love of malicious mischief, indifference to the comfort or suffering of others, idleness passing into dishonesty and crime, horseplay passing into violence—mark the hooligan. In one sense, hooliganism is no new thing. We read of it in the *Fortunes of Nigel*, and in the accounts of the street fights which took place between the apprentices for the 'crown' of the causey.' University students have always given themselves over periodically to a form of hooliganism—smashing lamps, breaking seats, and turning the Graduation ceremony into pandemonium. In Norman Macleod's day the Glasgow students were declared to be a 'disgrace to the High Street,' and yet a well-marked distinction is always drawn between them and, say, the Govan rivetters who are out to 'paint the town red.'

3. Classification.—Modern hooliganism may be classified under various heads.

(1) *Mob hooliganism*, the conduct of the population on occasions of public rejoicing and national victory, as on 'Mafeking' nights. Then the people seem to lose their heads altogether and become disorderly and reckless. Viewed as a symptom of growing instability in the national character, such conduct is serious. Mob mind is a malady of our time (Ross, *The Foundations of Sociology*, New York, 1905, p. 113). Mob hooliganism varies with the density of the crowd. 'The way in which hooliganism asserts itself all depends upon the atmosphere in which the hooligan finds himself' (*Westminster Gazette*, 6th April 1900, p. 2).

(2) *Political hooliganism*, the glaring illustration of which is the conduct of the militant suffragettes. Smashing shop-windows, defacing monuments, setting fire to theatres, throwing hatchets, and assaulting Cabinet Ministers cannot be described as anything but hooliganism of a very bad type. There is manifest lack of self-control, love of malicious mischief, and callous indifference to the sufferings of others. It is only fair to say, however, that militants are in a minority in the Suffrage movement, and that their tactics are strongly disapproved by many as unworthy and unwise, and calculated to hinder rather than help their cause.

(3) *Industrial hooliganism*, seen during strikes in assaults upon fellow-workmen, over-zealous picketing, and the destruction of goods, rolling-stock, and property. The workers, as a whole, are not lacking in self-respect or self-control, and the vast majority condemn violence. They showed the most exemplary patience and self-control during the big strikes in Great Britain amongst the miners and dockers (1911-12). When workmen indulge in hooliganism, it is due either to a passionate sense of wrong or to the sinister influence

of the baser sort who mingle with the workers and exploit them for their own nefarious ends.

(4) *Literary hooliganism*, manifested in savage criticism of books, of policies, and of parties. The classic examples of the first are the *Quarterly's* attack on Tennyson, Macaulay's attack on Robert Montgomery, and *Blackwood's* attack on John Keats. The reviews in those days frequently led to duels, such as that between Jeffrey and Tom Moore. For sufficiently savage and hooliganesque attacks on policies and parties one has only to read the popular magazines and newspapers—especially religious—of the present day.

(5) *Criminal hooliganism*.—This is the most serious phase. In all great cities there are gangs of hooligans with sensational names, such as the 'Forty Thieves,' the 'Pontoons,' 'Velvet Caps,' 'Tim Malloys,' 'San Toys,' 'Crush Boys,' 'Plug Uglies,' 'Cop Beaters,' 'Tough Kids,' and 'Crook Gang.' Jacob Riis, writing of New York, says that 'a bare enunciation of the names of the best-known gangs would occupy the pages of this book' (*How the Other Half Lives*, 229). Every street-corner has its gang, with a programme of defiance of law and order. In the United Kingdom things are not quite so bad, and Charles Booth thinks that in London there is a decided improvement (*Life and Labour of the People in London*, final vol., London, 1902, p. 201).

4. Causes of hooliganism.—The great root-cause is the undisciplined life, revolt against all authority, human and Divine, which characterizes the lower orders to-day, Roman Catholic as well as Protestant. The present writer's experience as a Prison Chaplain enables him to say that, contrary to a prevailing impression, hooliganism is as rife in Roman Catholic circles as in Protestant. This undisciplined life, however, is itself an effect, the resultant of many causes, some of which may be here indicated.

(1) *Defective education*.—Street lads have, as a general rule, managed to slip through the meshes of our educational system with the minimum of instruction. Reading remains for them an irksome task. They find no pleasure in it, and so are cut off from one of the greatest helps to a good life, one of the strongest safeguards against temptation. But their education is defective on the moral side as well as on the literary. Character has not been developed and strengthened, the will has not been cultured, self-control has not been taught. They are children of impulse and passion, and ill fitted to stand amidst the complex conditions of modern civilization.

(2) *Wretched housing* is another potent cause of hooliganism. Growing lads and girls in the poorer parts of our big cities are shamefully overcrowded. They have literally no room to live a decent human life, no opportunity of self-realization, no home life to speak of, and so they are driven out to the streets. Home to them means simply a place to eat in and sleep in, and not a place for social recreation or happy fellowship, still less for mental or spiritual culture. The loss is infinite, and tragic in its results upon character.

(3) *Lack of playgrounds and open spaces for wholesome recreation*.—When the children are sent out of doors to make more room in the house, they are turned into the street or back-alley. The slum is their playground, and there is no finer breeding-place for young hooligans and criminals. Everything there, the whole environment, conspires to degrade and ruin the boy and girl. The process is sure, and the waste of young life and capacity is awful.

(4) *Misdirected energy* follows naturally. There is nothing wrong with the energy, any more than there is with steam or electricity. What it needs

is guidance into proper channels—not repression, but proper expression. It is easily misguided, misdirected; and the result is hooliganism.

(5) *Parental inefficiency* must also be named as a cause. The home is to blame as well as the school. Home training is at a discount. Obedience is a lost habit. The parental example is often bad. The parents themselves are largely the creatures of circumstances, the resultant of our social, educational, and industrial system. The children take after their parents, follow the only example they know, and so the vicious circle continues to be trod.

(6) *Mental and moral defect*.—A very moderate first-hand knowledge of hooligans will convince any one that many of them are mentally and morally weak. They are defectives; and experience shows that defectives soon become delinquents. Mental instability is frequently found associated with hooliganism and crime. As already hinted, hooliganism may fairly be described as a by-product of our civilization. Our social system is largely responsible for it. It is, therefore, a social problem. We must cease to manufacture hooligans.

5. *Cure of hooliganism*.—The first serious attempt to deal with it was made in 1788, when the Philanthropic Society was formed in England by Robert Young. In 1806 the Dalston Refuge was founded, and in 1815 the Prison Discipline Society. Parliament began to tackle the subject in 1793, when Pitt brought in a Bill which, however, proved abortive. In 1811 and again in 1819 Parliament condemned the imprisonment of children for lawless conduct. Royal Commissions dealt with the matter in 1834 and 1837. The *Edinburgh Review* for Oct. 1851 said:

'The young offender gains ground upon us, the plague of the policeman, the difficulty of the magistrate, a problem to the statesman, and a sorrow to the philanthropist.'

That same year a Committee of the House of Commons recommended the establishment of Reformatory Schools, and in 1857 the Industrial Schools Act was passed. Its results were remarkable. In 1856, no fewer than 13,981 children under seventeen years of age had been committed to prison. In 1897, thanks to Industrial Schools, the number had fallen to 1688. Up to 1901 (according to figures given by John Trevarthen, Secretary of Redhill Farm School, in an article in the *Nineteenth Century* for Jan. 1901), out of 3511 reported on by Reformatories, 2666 were in regular employment, 123 in casual employment, 541 had been convicted, and 181 were unknown. Of 8233 reported on by Industrial Schools, 6379 were in regular employment, 430 in casual employment, 460 had been convicted, and 964 were unknown; *i.e.* nearly 80 per cent were doing well, and only some 15 per cent had been convicted—a very satisfactory record. The charge, then, that 'Reformatories are hooligan manufactories,' is singularly unjust and ill-informed. Considering the material supplied, the proportion of failures is surprisingly small, and a good many of the failures are caught up and reclaimed by the Borstal system. One-third of our burglars are boys from 16 to 21, and 20 per cent of crimes against morals are committed by those under 21. In 1852, Dickens visited the Philanthropic Society's Farm School, Redhill, and wrote an interesting article about it in *Household Words*, ending as follows:

'The system must be devised, the administration must be reared, the preventable young criminals must be prevented, the State must put its Industrial and Farm Schools first, and its prisons last—and to this complexion you must come. You may put the time off a little, and destroy (not irresponsibly) a few odd thousands of immortal souls in the meantime, but the change must come.'

These words were prophetic. The change has come. We are now putting our schools first, and our

prisons last, that is, educative methods are displacing punitive methods. Hence the new treatment of juvenile offenders, wise and firm, known as the 'Borstal.'

6. *Preventive measures*.—Reformatory and reclamatory treatment, however necessary and valuable, does not go to the root of the matter, and will not eradicate hooliganism. Therefore preventive measures must more and more be adopted. Generally, whatever makes for social amelioration makes for the extinction of hooliganism, and the production of a law-abiding, well-behaved, self-respecting population. The following reforms, however, have a special bearing upon the social phenomenon which we have been considering. Hooliganism will never disappear until we have—

(1) *An improved system of education which will aim deliberately at moral training, the disciplining of the will, the formation of character*.—To secure this we could well afford to drop much with which the curriculum is at present overloaded. Boys especially are ruled by ideals, and we must instil into them higher ideals than that of the robber knight and the pirate chief.

(2) *Industrial training*.—Much of our hooliganism is due to casual labour, blind-alley occupations, unemployment, and consequent street-loitering and larking. H. Dyer, a leading educational expert, truly says that

'one of the most important problems of the day is the deliberate and complete organization of the whole field of boy labour, as it is recognized that many of the most serious social problems have their origin in the degeneration which takes place in the years of adolescence' (*Education and National Life*, London, 1912, p. 77).

(3) *Better housing*.—The nation is waking up to the need for the better housing of the poorer classes. So long as the children of the poor are deprived of the advantages of a true home life and home comforts, so long will hooliganism be a blot upon our civilization. That is part of the price we must inevitably pay for our folly.

(4) *Sufficient playgrounds*.—Next in importance to a good home is a good playground. It is here that the modern city, in its shortsightedness and parsimony, has sinned most grievously against the child. All over the city, and especially in the poorer districts, there should be ample open spaces, well-lit at night, where the abounding energy of adolescence may find safe and legitimate outlet. Let us not forget that 'Waterloo was won on the playing fields of Eton.'

(5) *Helpful agencies*.—Boys' Brigades, Life Brigades, Boy Scouts, and Lads' Clubs, with their educative, social, and recreative departments, are invaluable for the suppression of hooliganism. They fill the empty life with wholesome interests, and provide centres of fellowship and intercourse, where pure and uplifting friendships are formed. They furnish stimulating ideals, and appeal to what is high and chivalrous, the best side of the boy's nature. They also satisfy the gregarious instinct of youth. It has been well said that we never see one boy, but always two or three. The gang spirit is deep and strong, and we must utilize it for the redemption of youth. Physical training is also of the utmost value, and many social reformers believe that universal military training would act as a powerful corrective to hooliganism. Finally, all efforts will stop short of the highest and best which do not bring our youth under the sway of religious faith. That is the work of the churches. It is for them to see that our growing boys and girls are won to the service of Christ, who is the supreme maker of manhood and womanhood.

LITERATURE.—G. Stanley Hall, *Youth*, Chicago, 1908; R. A. Bray, *The Town Child*, Philadelphia, 1910; E. J. Urwick, *Studies of Boy-Life*, London, 1908; Jacob A. Riis, *How the*

Other Half Lives, London, 1891; W. D. Morrison, *Juvenile Offenders*, do. 1896; D. Watson, *Social Advance*, do. 1911; J. MacCunn, *The Making of Character*, Cambridge, 1900; Octavia Hill, *Homes of the London Poor*, London, 1875; Government Reports on Deterioration, Physical Training, and Employment of School Children.

DAVID WATSON.

HOPE (Christian).—Hope is the name of a grace which is characteristic of the religion of the Bible. St. Paul sums up the misery of the Gentile world in a single sentence, when he speaks of them as *ἐλπίδα μὴ ἔχοντες καὶ ἄθεοι ἐν τῷ κόσμῳ* (Eph 2¹²). The Bible, on the other hand, is the book of hope. One strange book (Ecclesiastes) reflects the deep melancholy which was a pervading note of ancient literature; but hope cherished in the darkest times, hope continually kept alive by the labours of the prophets, hope of a future never abandoned and ever shining out anew in spite of every conceivable discouragement—this is the dominant note of the OT. Whatever is written therein was ‘written for our learning, that through patience and through comfort of the scriptures we might have hope’ (Ro 15⁴). The God whom the OT presupposes is ‘the God of hope’—the Author and Giver of hope (Ro 15¹³). The ‘hope of Israel’ (Ac 28²⁰; cf. 26⁶) might be understood in widely different senses. For St. Paul at least it included not only the complete fulfilment of the Messianic expectation in its widest sense, but the fulfilment of the true destiny of the individual in the glory of the resurrection life. To many modern Jews it may mean little more than the expectation of a brighter day for their oppressed and down-trodden nation—an expectation based on faith in God’s justice and His unique relation to Israel. But in any case, hope—the boundless expectation of good—is the deepest note in the poetry and prophecy of the OT; in a transfigured form, corresponding to the light shed upon the purpose and character of God by the Gospel, it re-appears in the NT. (For the meaning and use of the word in the OT and NT it may suffice to refer to *HDB*, s.v.; and *JE*, s.v.).

Hope, like faith and love, is a Scriptural virtue. It cannot be said to have a place in heathen ethics. There are isolated passages in praise of hope. A fragment of Menander is quoted by Jeremy Taylor, *Life of Christ*, pt. 3, § 15:

ἄνθρωπος ἀτυχῶν σώζεσθ' ὑπὸ τῆς ἐλπίδος,

and Eurip. *Herc. Fur.* 105 may be compared:

οὗτος δ' ἀνὴρ ἄριστος, ὅστις ἐλπίσει
πέποιθεν ἀεὶ, τὸ δ' ἀπορεῖν ἀνδρὸς κακοῦ.

But heathen hope was low or aimless. ‘Thou dost not hope,’ says Augustine to the Christian, ‘as the Gentiles hope.’ ‘Sperent illi inania saeculi, speres tu aeternam vitam cum Christo’ (*Serm.* cxcviii. 2). In both Testaments, indeed, the duty of hope is based on the revealed character of God: (a) as omnipotent and therefore able to fulfil His purposes, even against human expectation (Ro 4¹⁶); (b) as specially pledged to be the Saviour and Sanctifier of His elect people (Jer 14⁸ 17¹³ 50⁷, Ps 46⁵, etc.); (c) as the righteous moral Governor and Judge of mankind, whose ways are destined to be finally vindicated in spite of all the enigmas which burden the just man with a sense of unfathomable mystery.

The exact objects of hope differ to some extent in the two Testaments. The Anglican article (VII.) expressly denies that ‘the old fathers did look only for transitory promises.’ The hopes of merely temporal good, which were characteristic of primitive men, were doubtless chastened and purified by the discipline of calamity, so that hope itself became spiritualized (cf. Ps 63³ 17¹⁵ etc.). On the other hand, the gospel is the religion of the ‘better hope’ (He 7¹⁹), because it is the religion ‘through which men for the first time enter into intimate fellowship

with God’ (see Bruce, *Ep. to the Hebrews*, Edinburgh, 1899, p. 271 f.). Thus the hope of the Christian is a ‘good hope’ (2 Th 2¹⁶), a ‘blessed hope’ (Tit 2¹³), a ‘hope of glory’ (Col 1²⁷); a ‘hope of righteousness’ (Gal 5⁵), of ‘salvation’ (1 Th 5⁸), of ‘eternal life’ (Tit 3⁷). It is an expectation of spiritual blessings already realized and potentially conveyed to man in Christ. Nay, Christ Himself is ‘our hope’ (1 Ti 1¹), the living pledge that the divine promises of life, immortality, and glory will find their fulfilment for all who are lovingly united to Him. His resurrection is the ground of hope because it is an earnest of the fulfilment of man’s destiny (1 P 1² 21). So Aug. (*c. Faust.* xi. 8) strikingly says that the Christian expectation of future bliss and immortality ‘in Christo iam non spes sed res erat.’ The believer, he adds, ‘in Christo iam habet quod in se sperat.’ The present article will deal with the function of hope in the moral life of the Christian.

1. The *object of hope* is, of course, some form of future good, the true blessedness of which man is capable. The object of hope is the highest good—‘bonum futurum, arduum, possibile haberi’ (Aquinas, *Sum.* ii. 2. xvii. resp.). This is described in various ways in the NT. In the Synoptic Gospels the *summum bonum* is the Kingdom of God or of Heaven; in the Fourth Gospel, eternal life; in St. Paul’s Epistles, the righteousness of God; in Hebrews, access to God and unrestricted fellowship with Him. All these are simply different descriptions of one supreme blessing, viz. that spiritual state which results from the very presence of God in the human spirit. In a true sense, then, God Himself is the supreme object of hope; ‘bonorum summa Deus nobis est’ (Aug. *de mor. Eccl.* 13; cf. *de Trin.* viii. 4. 6). God, says T. H. Green, ‘is all which the human spirit is capable of becoming’ (*Proleg. to Ethics*, Oxford, 1883, § 187). The final ‘beatitudo’ for which we look is the reign of God in man, i.e. that perfection of our nature which results from His indwelling presence in man. ‘Non aliud aliquid a Domino Deo tuo speres, sed ipse Dominus tuus sit spes tua’ (Aug. *Enarr. in Ps.* 39 [40]⁷). So Aquinas, *Sum.* ii. 2. qu. xvii. art. 2, says: ‘Proprium ac principale spei objectum est ipsa aeterna beatitudo.’

2. We may next discuss the *claim of hope to be a Christian virtue*. We must remember that man’s nature, being disordered by the Fall, can be restored only by an act of Divine power. The revelation of God in Christ, making known His character, purpose, and requirement, necessarily affects the normal springs of human action. Thus, for a Christian the primary springs of action—the affections, appetites, passions, sentiments—yield to certain higher principles directly resulting from man’s changed relation to God. These are the ‘theological virtues,’ Faith, Hope, and Love, so called because they bring man into a right relation to God and are Divinely communicated to him.¹ The Gospel revelation of God is, in fact, a new inspiration; it develops in man a new attitude towards God, and, consequently, a new disposition or character. It sets before him a new end or aim of action, viz. union with God. Hence the necessity of *faith*, which appropriates the revealed facts—the good-will and Fatherly love of God, the Divine victory over sin, the possibility of blessedness; of *love*, which responds to the goodness of God, and embraces in union with God the Divine aim of creation—an end which is wider than any merely personal good, and includes the well-being of others; and, finally, of *hope*, which, in reliance on the revealed character of God, looks forward with confidence to the fulfilment of the Divine

¹ Aquinas, *Sum.* i. 2. qu. lxxii. art. 1 resp.

purpose; which waits for the 'coming' of the Kingdom, for the perfection of which man's nature is capable, and for the complete manifestation of God (Ro 5²).

These three principles are inseparably connected (see Aug. *Enchir.* 8, on this point), and hope not less than the other two is a principle of moral action, acting directly upon the will (Aquinas, *Sum.* ii. 2. qu. xⁱⁱⁱ. art 1 concl. '[Spes] in voluntate est ut in suo proprio subjecto'). It inspires endurance and self-control, stability and firmness. It colours man's intellectual outlook upon life. It hits the due mean between shallow optimism and pessimism. It fortifies the will and nerves it for the task of self-conquest, and for that 'patience' which, according to NT conceptions, is itself a form of moral energy, demanding the output of strength (Col 1¹¹). It is the chief element in perseverance. 'Spes facit Deo adhaerere . . . in quantum scilicet per spem divino auxilio innitimur ad beatitudinem obtinendam' (*Sum.* ii. 2. qu. xvii. art. 6).

Thus hope forms a great part of heroic virtue. It is related to faith 'as the energetic activity of life is related to life . . . Hope gives distinctness to the objects of faith' (Westcott on He 3⁶). Hence the heroes of faith in the Bible are also patterns of hope: Abraham (Ro 4¹⁸), the Psalmists, the Prophets, the Apostles, the martyrs and saints of the OT and NT (He 11; cf. Wis 3⁴, 2 Mac 7¹⁴, 2 Es 7⁵⁰, Bar 4²²). And, being a virtue, hope is accordingly a duty, and is a frequent topic of exhortation in both Testaments. (See esp. the First Epistle of St. Peter, 'the Apostle of hope,' and note the frequency of the word in the Pauline Epp. and Hebrews.)

3. The *moral fruits of hope* may be summarized as follows. (1) The joyous temper which St. Paul describes as 'joy and peace in believing' (Ro 15¹³), the confidence which springs from the assurance that God controls and overrules for good all that dismays or perplexes the soul, and that 'all things work together for good to them that love God' (Ro 8^{28, 35}, 12¹², 1 Th 5¹⁶, Ph 1^{20, 4}, He 3⁶).—(2) Perseverance in prayer. 'Without hope it is impossible to pray; but hope makes our prayers reasonable, passionate, and religious; for it relies upon God's promise, or experience, or providence, and story. Prayer is always in proportion to our hope zealous and affectionate' (J. Taylor, *Holy Living*, ch. iv. § 2).—(3) Patience and endurance in the duties and trials of common life. 'Patience worketh experience, and experience hope' (Ro 5³⁴). The Bible is the book of hope, because it is a record of sufferings endured, surmounted, and overruled for good. The special value of the OT lies in the fact that throughout its pages the Hebrew mind is, as it were, being prepared for the appearance on the stage of human life of the Man of Sorrows. The Bible shows us the various methods by which man is disciplined for the service of God and humanity; it discloses in repeated instances 'the end of the Lord; that the Lord is very pitiful, and of tender mercy' (Ja 5¹¹). In all these, hope finds its unfailing encouragement and support.

4. It remains to say something of the *chief vices opposed to hope*. The excess of hope, ill-grounded or immoderate confidence, is presumption. The promises of God, which constitute the ground of hope, are not unconditional. He has not, for example, promised forgiveness to those who persevere in sin or who cease from well-doing. Presumption may spring from pride—inordinate trust in one's own powers or in the mercy of God, that is to say, from an exaggerated estimate of self, or from a defective sense of the difficulty of goodness, or from that self-ignorance which induces us to forsake without necessity the ordinary path of duty, and so involve ourselves in self-induced difficulties.

Such conduct is contrary to the spirit of the petition, 'Lead us not into temptation' (see W. H. Mill, *Five Sermons on the Temptation*, Cambridge, 1844, no. 5; Bernard, in *Ps.* 'Qui habitat,' Serm. xiv.). The remedy against presumption is the spirit of humility and holy fear, and attention to the warning implied in 1 Co 9³⁶, 10¹², He 3¹⁶⁻⁴¹, 6⁴⁸, Jude⁵ (see Taylor, *Holy Dying*, ch. v. § 6; and Aquinas, *Sum.* ii. 2. qu. xxi.).

The defect of hope, on the other hand, is despair, which springs not necessarily from infidelity but from lack of confidence in God and servile fear. The Heb. verb for 'despair' (צָרָה) is an uncommon one (Ec 2²⁰; see also 1 S 27¹, Job 6²⁶, Is 57¹⁰, Jer 2²⁵ 18¹²). The conception occurs in the NT only to be negatived (2 Co 4³; the exception in 2 Co 1⁸ is, as the context shows, only apparent). Despair is, in fact, incompatible with the spirit of faith (2 Co 4¹³). It is, as Aquinas points out, a principle of sin (cf. Eph 4¹⁹), and that for three reasons. (1) Just as hope is based on a true conception of God's character, so despair results from a false and unworthy one, by which God is robbed of His due honour. (2) Despair acts on the will and leads to recklessness of living. 'Sublata spe irrefrenate homines labuntur in vitia et a bonis laboribus retrahuntur.' (3) Further, despair implies that 'aversion from the unchangeable good' which is the very essence of sin. 'If sin is the death of the soul, despair is its descent into hell' (Isidore, quoted by Aquinas, *Sum.* ii. 2. qu. xx. art. 3; cf. Aug. *Enarr. in Ps.* 144¹¹).

The causes of despair are various. Moralists specially mention two sins: luxury and 'accidie' (*g.v.*)—that spiritual sloth which robs a man of hope and so casts him down that he thinks the good unattainable. To these may be added the lack of gratitude for God's benefits, impatience, and culpable 'weakness of spirit' (Taylor, *Holy Living*, ch. iv. § 2).

The remedies suggested for despair are at the same time means for sustaining or augmenting hope. Taylor advises (*loc. cit.*): (1) Soberness and moderation in our expectations, and consequent indifference to the changes and chances of human life. (2) Reflexion upon the character of God 'in whom there are all those glorious attributes and excellences which in the nature of things can possibly create or confirm hope'; the soul must contemplate the power of God and His fidelity to His promises. (3) Recollection of Christ's travail for our redemption, as witnessing to the infinite willingness of God to save and pardon. In this connexion Augustine (*in Joan. Evang. tract.* xxxiii. 8) refers to Ezk 18²⁷ as a text of comfort for the despairing. (4) Remembrance of the past mercies of God, and of His providential care for the soul. This is implied in St. Paul's words, 'experience worketh hope' (Ro 5⁴). To these may be added (5) the abiding and continuous spirit of penitence—contrition for sins already forgiven and often-repeated acts of repentance. 'Spes sua cuique est in conscientia propria, quemadmodum se sentit ad dilectionem Dei et proximi cognitionemque proficere' (Aug. *de Doct.* iii. 14).

LITERATURE.—Augustine, *Enchiridion*, 8, and *passim*; Bernard, in *Ps.* 'Qui habitat,' Serm. vii.; Aquinas, *Summa*, i. 2. qu. lxii.; ii. 2. qu. xvii. and xx.-xxii.; Jeremy Taylor, *Holy Living*, ch. iv. § 2 (*Works*, ed. C. P. Eden, London, 1856, vol. iii. p. 150 ff.); T. B. Strong, *Christian Ethics*, London, 1895, Lect. iii.; J. R. Illingworth, *Christian Character*, do. 1904, ch. iv.; R. W. Church, *Advent Sermons*, do. 1885, no. 4; B. F. Westcott, on He 3⁶ 6¹⁹ 10²³; I. A. Dorner, *Syst. of Chr. Ethics*, Eng. tr., Edinburgh, 1887, § 46.

R. L. OTTLEY.

HOPE (Greek and Roman).—The etymological association of ἐλπίς with *voluptas*, 'pleasure,' 'will,' 'desire,' is perhaps illustrated by Pindar, *Pyth.* ii. 49; but the neutral meaning 'expectation,' whether of good or evil, common from Homer to

Herodotus, is still for Plato the normal one (*Laws*, 644 C [which Liddell and Scott, s.v. *ἐλπίς*, II., misunderstand] and *Philebus*, 39 E). The verb throughout Homer seems to mean 'expect' or 'deem'; the noun occurs twice in the *Odyssey* (xvi. 101 and xix. 84), in a formula, in the sense of 'hope.' There is no personification of hope in Homer.

In the myth of Pandora (Hesiod, *Works and Days*, 96), Hope remains in the jar when other evils have flown forth and been dispersed among men. The natural and traditional interpretation of this is that hope stays with man as his sole consolation (Campbell, *Pleasures of Hope*, i. 30-40; Shelley, *Masque of Anarchy*, xxii.-xxiv.; Cowley, *The Mistress*). On this view the jar contained a mixture of good and evil, corresponding vaguely to the two jars in the Homeric apologue (*Il.* xxiv. 527-533). Further confirmation is found in a fable of Babrius (58), in which the jar contains only blessings, hope remaining when the others are dispersed and lost. But, if we may press the logic of a myth, it can be plausibly argued from the phrase 'other evils' that hope too is an evil.¹ It is the delusion which, in Cowper's words (*Hope*, 153), 'sets the stamp of vanity on all, That men have deemed substantial since the fall,' and there is abundant confirmation of this view in the many passages of the moralizing poets which warn the too easily elated Greek against the special danger of his temperament, 'the chase of a cheating prey with hopes that shall never be fulfilled' (Pind. *Pyth.* iii. 23). Another ingenious mediating interpretation makes the blessing to consist in the absence of hope in the sense of foreknowledge of fate. This would do for humanity what the Prometheus of Æschylus (*Prom. Vinc.* 250) boasts that he did by implanting in them 'blind hopes that they might hide with thin and rainbow wings the shape of death' (Shelley, *Prom.* II. iv. 62). (O. Gruppe [*Gr. Mythol. und Religionsgesch.*, Munich, 1906, p. 1025 n. 1] is inexact in saying that *ἐλπίς* is an evil in Æschylus; and Walz's citation of *Perseæ*, 803, is equally irrelevant. So in Pindar, *Isth.* ii. 43, *φθόρον* . . . *ἐλπίδες*, which means merely the hopes of envious enemies, is misunderstood by Schmidt and many others.) The question has been much debated of late, but there is little prospect of agreement (see Paul Girard, 'Le Mythe de Pandore,' *REG* xxii. [1909] 217 ff., and Walz, 'A propos de l'Elpis hésiodique,' *ib.* xxiii. [1910] 49-57). There is no interpretation of the myth that will satisfy all requirements of a captious logic. Why, for example, should Zeus in the accomplishment of his revenge wish to console mankind? And how, on the other hand, can in the one case the escape from the jar and in the other the remaining behind in it consistently symbolize the presence with mankind of a blessing or a bane?

In post-Hesiodic literature we may distinguish, though we cannot keep apart, (1) the idea already glanced at that hope is an illusion and an evil; (2) the topic of the better hope of the initiated or the good; (3) the anticipation of such modern ideas as the duty of hopefulness; (4) the personification of hope.

(1) 'Creatures of a day,' says Simonides of Amorgos (i. 3-7),

'They live like cattle, knowing not how God
Shall bring each thing to its appointed end.
But Hope and suasive confidence maintain
The agitation of their vain desires.'

(See on this Wilamowitz, *Sappho und Simonides*, Berlin, 1913, p. 272 ff.)

¹ By the Sanskrit poets hope was classed among the evils which the true sage must renounce to secure perfect tranquillity of mind (cf. Böhlingk, *Ind. Sprüche*², St. Petersburg, 1870-78, nos. 1046-52, 1477, 2448, 2609).

Solon re-echoes the thought (xii. (iv.) 33 ff.):

'We mortals think alike, the good and bad:
Anticipation maketh all men glad,
Till evil strikes, then we deplore our fate
Who gaped on airy hopes in vain elate.'

This general moral he applies to every trade and vocation in turn, in illustration of 'the ample proposition that hope makes in all designs begun on earth below' (Shakespeare, *Troilus and Cressida*, I. iii. 3). In similar vein, Theognis writes (637):

'Hazard and Hope, two cruel gods are they,
Who equally on all mankind do prey.
Men's fortunes prosper oft beyond their thought
And hope, and oft good counsel comes to naught.'

After Theognis, Pindar (*Nem.* xi. 46) and the dramatists (Soph. *Antig.* 616; Eurip. *Sup.* 479) take up the parable. Thucydides incorporates it in his cynical philosophy of human motives (see P. Shorey, *Transactions of Amer. Phil. Assoc.*, vol. xxiv. [1893] p. 71; F. M. Cornford, *Thucydides Mythistoricus*, London, 1907, p. 167 f.). 'Hope easily led astray' is one of the elements of which the mortal soul is compounded by the divinities that came to the making of man in Plato's *Timæus*, 69 D, and hope is a motive of crime in Antiphon (fr. 58, Diels) and Democritus (fr. 221).

This is the prevailing tone. But, of course, hope is also described as a blessing and a consoler, and there are parallels with most familiar quotations, from Pope's 'Hope springs eternal' (Theognis, 1135) to Gay's 'While there is life there is hope' (Theoc. iv. 42), and Prior's 'For Hope is but a dream of those that wake' (Pindar, *ap. Stob. Flor.* 111. 12). Æschylus' 'Exiles feed on hope' (*Ag.* 1668) became a proverb. (For a collection of commonplaces, see *Stob. Flor.* 110 ff.; C. F. Nägelsbach, *Nachhomer. Theol.*, Nürnberg, 1857, p. 383 f.; L. Schmidt, *Ethik der alten Griechen*, Berlin, 1882, ii. 70-75.)

(2) The better or fairer hope is almost a technical term for the assurance of a blessed immortality which the mysteries brought to the initiated (see C. A. Lobeck, *Aglaophamus*, Königsberg, 1829, i. sect. 11, pp. 69-73; Pindar, in Plato, *Rep.* 331A, and Plato, *Phædo* 63 C, where Burnet comments, 'Elpis is Orphic for faith'). This better hope extends to worldly prosperity also, and is sometimes the reward of moral and not merely ceremonial purity (cf. Isocr. iv. 28 with viii. 34-35, i. 39, and xv. 322). In Antiphon, vi. 5, it is a sanction of the oath and of the righteous administration of justice.

(3) The friendly exhortation not to despair but to cling to hope (Soph. *Trach.* 125) passes by insensible transition into the affirmation of the duty of hopefulness (Pind. *Isth.* vii. [viii.] 16; Eur. *Herc. Fur.* 105; Horace, *Od.* II. x. 13). The transition and the blending of the idea with the better hope of the righteous appears in a notable passage of Plato's *Laws* (732 C). More simply Demosthenes (*de Cor.* 97), in an often imitated passage, declares to the Athenians:

'Good men should attempt all honourable things, casting before them good hope as a shield and bearing bravely what God gives.'

Similarly Menander (fr. 572, Kock):

'When thou dost well, thrust forth to cover thee
Good hope a shield, in confidence that God
To righteous boldness lends a helping hand.'

But there is a wide gap between these sayings and Emerson's optimistic Americanism: 'We judge of a man's wisdom by his hope.' To Epictetus (fr. cxlv., Didot) and Democritus (fr. 185, Diels) is attributed the saying that 'The hopes of the educated are better than the wealth of the ignorant.' The saying, 'The hopes of right-thinking men are attainable, those of the foolish not' (Democr. fr. 58, Diels), may be ultimately derived from Plato's *Philebus*, 40 A-B.

(4) Hope is freely personified in Greek poetry, and Clytemnestra's 'My hope shall never tread

the halls of fear' (*Æsch. Ag.* 1434) is as bold as Lady Macbeth's 'Was the hope drunk, wherein you dressed yourself?' Hope is represented on a marble vase in Rome and on coins, holding a branch in the left hand and a pomegranate flower in the thumb and first finger of the right, the symbolism of which is doubtful (see Roscher, *s.v.* 'Nemesis,' and Müller-Wieseler, *Denkmäler der alten Kunst*, Göttingen, 1835-81, ii. fig. 670). But there is no evidence of an actual cult in Greece. Theognis' admonition to pray to Hope first and last (1146) proves as little as the association, in *Anth. Pal.* ix. 146, of Elpis with Nemesis, or with Tyche in *Anth. Pal.* ix. 49 (cf. *Roman Sepulchral Inscriptions*, xi. 6433) and 134, or the plural Elpides in *Anth. Pal.* x. 70 and vii. 420. Any half-personified abstraction may be a 'god' in Greek poetical rhetoric from Euripides down.

It is otherwise with the Roman Spes, to whom a temple was erected in the *forum holitorium* in 258 B.C., and who perhaps had a still earlier worship indicated by the term *Spes Vetus*, referred to a district near the *Porta Labicana*. She first appears in literature in Plautus (*Cist.* 670, 'Spes sancta'; cf. *Bacch.* 893, *Pseud.* 709, *Merc.* 867, *Rud.* 231). The theory of Preller that she was originally a garden-goddess, the farmer's hope of harvest, is rejected by Wissowa and Axtell (*Deification of Abstract Ideas in Roman Literature*, Chicago, 1907, p. 18). Whether the more specific *Bona Spes* is an essential part of the conception, or a later development, or a mere literary epithet, is open to debate. She was worshipped at Ostia and Aricia by the Emperors, and appears once in the prayers of the Arval Brothers. The Romans made more of the cult of personified abstractions than the Greeks, but even in Latin literature the line is hard to draw. In Horace (*Odes*, i. xxxv. 21) and Tibullus (i. i. 9, and ii. vi. 20-28), there is little to choose between poetic personification and cult. The insistent repetition of the name at the beginning of the line in the Tibullus passage may be nothing more than a literary *motif* common in Latin elegy, and traceable as far back as the speech of Nestor in *Il.* xxiii. 315 f.

The relation between these Greek and Roman ideas and the Christian virtue of hope does not seem to have been adequately studied. It is sometimes stated that the symbolism of the anchor of hope is classic. But the anchor on Greek coins does not appear to be associated with hope, and the association in Greek poetry is rare. In Aristophanes, *Knights*, 1244, 'the frail hope on which we ride' is apparently a raft.

In *Æschylus, Ag.* 505, 'when many hopes are broken' or torn away, the scholiast says that the metaphor is from an anchor. Epictetus said (fr. xxx., Schenkl), 'We should not moor a ship from one anchor, or life from one hope.'

LITERATURE.—This is given in the article.

PAUL SHOREY.

HOPI.—A body of American Indians, numbering 2218 in 1912 (as compared with 1839 in 1896 and 1878 in 1904) and occupying, within a reservation of 2,472,320 acres in N.E. Arizona, the six pueblos of Walpi and Sichumovi on the 'East Mesa,' Shongopovi, Mishongnovi, and Shipaulovi on the 'Middle Mesa,' and Oraibi on the 'West Mesa,' to which must also be added the Tewan pueblo of Hano, a little N. of Sichumovi. Practically the sole map of the region is the one herewith reproduced from *JAEA* ¹ iv.

The language of the Hopi belongs to the Shoshonean stock; yet in their ritual many Keresan words occur, and Zuni influence is potent, while

¹ Special abbreviations employed in this art.: *AmAn* = *American Anthropologist*; *FCMAS* = *Field Columbian Museum, Anthropological Series*; *JAEA* = *Journal of American Ethnology and Archaeology*.

there are marked analogues with Nahuatl culture. The composite character of the Hopi is also substantiated by their legendary history, which

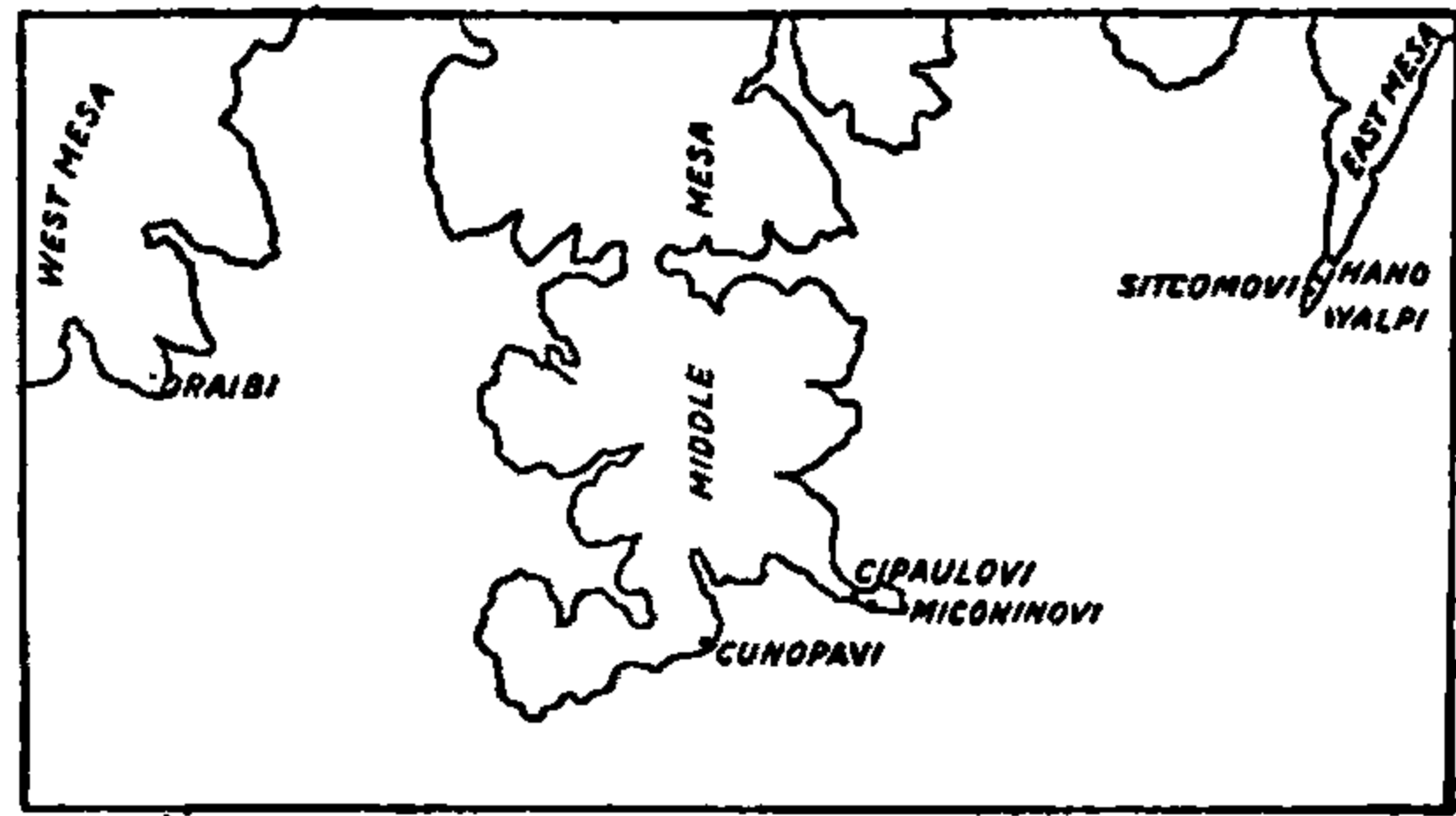

represents different portions as coming from widely separated parts of the country.

The term 'Hopi,' which these people prefer, and which alone should be applied to them, is a contraction of *Hopitáh*,¹ 'peaceful ones,' or *Hopitáh-shinnumáh*, 'peaceful all people'; and the common appellation of *Moqui* (with many variant spellings), which means 'dead' in Hopi, is an offensive misnomer.

As a tribal name *Moqui* 'is seemingly of alien origin and of undetermined signification—perhaps from the Keresan language (Mósfcha in Laguna, Mo-ts in Acoma, Mótsi in Sia, Cochiti, and San Felipe), whence Espejo's "Mohace" and "Mohoce" (1583) and Oñate's "Mohoqui" (1598)' (Fewkes, *HAI* i. 560). They are known to the Apache also as Earke ('live high up on the mesas'), and the Zuni sometimes derisively call them *Amukwikwe* ('smallpox people') and *Hapeka* ('excrement people'). The name for their country is *Tusayan* (Apache, 'place of isolated buttes'; for further synonyms, see Fewkes, *op. cit.* 567 f.).

i. History.—The districts from which the phratries came were, according to Fewkes (19 *RBEW*, 582): Tokonabi (S. Utah)—Chua, Ala; Palatkwabi² (S. Arizona) and the Little Colorado—Patung, Lengya (?), Patki, Kukuch, Piba, Tuwa, Tabo; the Muiobi (Rio Grande valley) and New Mexican pueblos (Zuñi, Acoma, Jemez, etc.)—Honau, Kokop, Pakab, Asa, Buli,³ Honani. The order in which these clans reached *Tusayan* is very uncertain (Fewkes, 19 *RBEW*, 585 f.; for the native traditions, cf. the very full account by Stephen, *ap. Mindeleff*, 8 *RBEW*, 18 ff.; also Voth, *FCMAS* viii. 22 ff.), but perhaps the most reliable summary is that of Fewkes (*AmAn*, new series, ii. 694 f.).

Of the existing Hopi pueblos, Walpi, Shongopovi, Mishongnovi, and Oraibi (the Oraibi colonized from Shongopovi) were established before 1629; Sichumovi (colonized from Walpi) and Shipaulovi (colonized from Walpi and Mishongnovi) were founded about 1750; and Hano was built early in the 18th cent. (Fewkes, *AmAn* vii. 414, and 19 *RBEW*, 581 f.; see, further, *HAI* ii. 901, 553 f., i. 871, ii. 142 f., 564, 551, i. 531). The inhabited pueblos are elaborately described by Mindeleff (8 *RBEW*, 61-79), who also describes the ruins of Old Walpi, Old Mishongnovi, Shitaimu, Awatobi, Kokopki (called by him 'Horn House'), Chackpahu (called by him 'Bat House'), Kawaika (called by him *Mishiptionga*), Moen-kapi, Kwaituki, Tebugkihu, Chukubi, and Payupki (*op. cit.* 45-60; for the tradition regarding Payupki, see Stephen, *ap. Mindeleff*, 40 f.).

These are only a few of the ruined sites, and to them may be added Chubkwichalobi, Honanki, Kachinba, Kisakobi, Kukuc-

¹ The spelling of Hopi names is by no means uniform; in the present art. the vowels have their Continental value; *u*=*u* in 'but'; *p* and *b*, and *t* and *d*, are indistinguishable; *tc*=*ch* in 'chink'; *ñ*=*n* in 'finger'; *c*=*sh* in 'shall'; *q*=German *ch*.

² For the Hopi tradition of the destruction of Palatkwabi, see Voth, *FCMAS* viii. 48-63.

³ On this clan, traditionally said to be Tewan in origin, and to have migrated to Zuñi and thence to the Hopi, being one of the components of the population of Awatobi, see Fewkes, *AmAn*, new ser., xli. 576-594.

homo, Lengyanobi, Lululongturkwi, Tukinobi, Wukoki, and Wukopakabi; as well as the legendary sites of Etipsikya and Hushkovi, and villages mentioned by the early Spanish writers, such as Cuanrabi and Quiana (cf. *HAI* i. 293, 559, 638, 703, 733, 764, 778, ii. 834, 976, i. 442, 591, 369, ii. 339, and the references there given). Mindeleff (*19 RBEW*, 644) doubts whether any of the ruins of Tusayan are more than 400 years old.

In 1774 or 1775 the Hopi population numbered, according to Fr. Escalante, 7494, of whom two-thirds were at Oraibi; in 1780 they had been reduced by famine to 798. In 1850, M'Call estimated their number at 2450 (Bancroft, *Hist.* 261, 266, 462, note 28). The first visit after the American occupation of Arizona was by Ives in 1858, and in 1869 an Indian Agency was established for the Hopi. See Fewkes, in *HAI* i. 560-562; Bancroft, *Hist.*, esp. 46 f., 87 f., 154, 173, 201, 221 f., 225-230, 234, 239, 246, 256, 349, 363-367, 391-398, 547 f.

2. Culture and organization.—The Hopi are essentially agricultural, and, at least in its present form, their religion centres in the need for rain and in ceremonies designed to promote the growth of the harvest. It is maintained by Fewkes (*AmAn* ix. 172) that, the further back they are traced, the closer is their resemblance to the general culture of the so-called cliff-dwellers (cf. *ERE* i. 685*), and their history indeed suggests, in its stories of the moving of pueblos from low ground to the tops of the mesas (as after the massacre of the Spanish priests in 1680), the way in which the cliff-dwellings came to be constructed. The pueblos themselves (on which cf. *ERE*, *loc. cit.*) are, as Mindeleff points out (*19 RBEW*, 639 ff.), essentially a product of the plateau country into which the migrations of the Hopi led them. They learned the custom of storing grain to provide both against drought and against the forays of hostile tribes, such as the Apache and the Ute, and this forced the small villages to amalgamate, at first on the foothills, and later on the summits of the mesas. Yet the necessities of continued agriculture—or, rather, horticulture—obliged them to construct summer villages near their fields, a notable example being the present village of Moen-kapi, about 40 miles N.W. of Oraibi (see Mindeleff, *8 RBEW*, 77-79).

Within the villages the Hopi are divided into 'clans,' or *wingwu*, these being descendants of sisters; and into groups of *wingwu* from the same female ancestor and possessed of a common totem, or *myimu* (Stephen, *ap.* Mindeleff, *8 RBEW*, 16). The whole Hopi system is, as will be seen (below, § 4), matriarchal, and the form of the Hopi pueblo is materially affected by this fact. Accordingly, as Mindeleff notes (*19 RBEW*, 647),

'as the men who are adopted into it by marriage take up their quarters in the family home and children are born to them, more space is required. But additional rooms, which are still the family property, must be built in the family quarter, and by a long-established rule they must be built adjoining and connected with those already occupied. Therefore in each village there are constant changes in the plan; new rooms are added here, old rooms abandoned there. . . . It is not unusual to find in an inhabited village a number of rooms under construction, while within a few steps or perhaps in the same row there are rooms vacant and going to decay.' Since, moreover, care is taken, when first laying out the pueblo, to secure sunny exposures for entrances and terraces, as well as protection against cold and wind, the general growth of the pueblos has been N.W. or S.E. (Fewkes, *AmAn*, new series, viii. 88 ff.).

In the building of the houses all the heaviest work is done by the men, but the women normally do the plastering and all else that their physical strength allows, both in the houses and in the kivas, or chambers for ceremonial gatherings and the general purposes of a club-house (Mindeleff, *8 RBEW*, 100 ff., 111 ff., where the simple rites connected with building are also given).

An instrument peculiar to the Hopi among the American Indians is the *putshkohu*, or 'rabbit stick' (represented in the accompanying cut from a specimen in the collection of the U.S. Government), which

'is delivered in the same way as the Australian (boomerang), and its course after it strikes the ground often brings it to the right or left of the thrower and nearer to him than the farthest point reached in its flight. It makes one or more revolutions in its flight toward a rabbit, and if it does not strike the animal directly, its rapid gyration when it touches the



ground makes probable the hitting of any object within several feet. So far as is known this is the only aeroplane club used in America. The material is Gambell's oak (*Quercus gambellii*), and a branch of the proper curve is selected for its manufacture. One end is cut to form a handle, and the club is usually varnished with resin and painted with an invariable design in black, red, and green. Of late years a rabbit figure is frequently painted thereon. The weapon has a religious significance, probably arising from its use in ceremonial rabbit hunts' (Hough, *HAI* ii. 348). The *putshkohu* constitutes part of the equipment of the Makto and Tcilikomato kachinas¹ (Fewkes, *81 RBEW*, 118, 116, plates xlix., li.).

3. Birth, naming, and initiation.—The parturient mother is usually attended by her mother (or, if her mother is dead, by her aunt or other female relative), who is not, however, generally present during actual parturition, except in a case of difficult labour or the like. The father likewise remains away under ordinary circumstances. After the child has been born, its head and the head of the mother are washed with amole suds, and the infant's body is rubbed with ashes, after which an ear of maize is placed in its cradle to guard it. The care of the new-born child devolves mainly upon the paternal grandmother (or, if she is dead, upon her sister or other female relative on the father's side), and until the 5th day the mother must not see the sun or receive any solar light. On the 5th day the washing is repeated, as well as on the 10th, 15th, and 20th. During this period the mother may eat no meat or salted food, and all sustenance must be prepared, at least in part, with a decoction of juniper leaves; and for these 20 days the mother is, furthermore, forbidden to be barefoot. Shortly after birth four horizontal lines are drawn upon the wall of the room, these being called the child's 'house,' and on each of the days of washing one of these lines is solemnly effaced—a ceremony whose real meaning is still unknown²—and is offered to the rising sun with a prayer for old age.

The 20th day marks the purification of the mother, the naming of the child, and its presentation to the sun. On this day both mother and child are again solemnly washed, the former also being obliged to stand over a steaming vessel into which juniper is thrown, thus receiving the final purification. The bowl with its contents, together with sweepings and everything connected with the mother during her ritual impurity, is then thrown away without ceremony. The after-birth, which has been kept until this time, is sprinkled with sacred meal, a feather is added, and the whole is rolled together, waved over the mother's head, and carried away to be shaken out or buried by the paternal godmother. When the latter returns, she rubs the mother's arms, neck, and face, and the child's face (on the Middle Mesa she takes ears of maize and makes four passes over the front of the child, without touching it, from head to foot), and with prayer-meal and ears of maize she makes some such prayer as, 'May you live to be old, may you have good maize, may you keep well, and now I name you N.' All the other

¹ On kachinas see artt. CALENDAR (American), vol. iii. p. 67, and DRAMA (American), vol. iv. p. 871 f.

² It may be queried whether these lines do not represent the four 'houses,' or stages, of the Hopi creation legends. On the child's 'house,' see Voth, *FCMAS* vi. ii. 49.

women belonging to the father's clan do likewise, one of the many names thus given being finally selected to be borne until initiation into one of the fraternities. The child is now placed in its cradle, and, when the father (whose presence or absence during these ceremonies has been immaterial), announces sunrise, the infant is carried by the godmother, escorted by the mother, bearing prayer-meal. The face of the child is uncovered, and the godmother and mother pray over the meal and cast it towards the rising sun (on the Middle Mesa the godmother plants two *bahos* [on which see below, § 11]—one for the mother and one for the child).

Meanwhile, provision has been made for a feast, in which *nugkwibi* (stew of mutton and shelled maize) and *pikami* (sweet mush) are indispensable. The first morsel of each food is given in sacrifice to the sun, and the child then receives a small bit. After the feast, when the mother has returned a larger portion of maize meal than was given her for her child, the guests return to their own homes.

About the age of eight or ten, children undergo what may be the survival of an initiation rite. In the course of the Powamû ceremony the children are led into the presence of the two Tuñwupkachinas either by their mothers or by their godfathers (godmothers in the case of girls). The children, who carry ears of maize, a handful of prayer-meal, etc., are then flogged by the kachinas with yucca whips, the boys severely, the girls more gently. After them the godfathers (but not the godmothers) are whipped, and then men with various ailments. Previous to this whipping the children have believed that the kachinas are real; after it they know that they are in reality only personations (Fewkes, 15 *RBEW*, 283-285, 21 *RBEW*, 36, 69; Voth, *FCMAS* III. ii. 103 f.).

Children are initiated into the various fraternities at about the age of fifteen or eighteen, and they then receive the names by which they are permanently known (for the initiation rites of the Antelope fraternity, see Fewkes, Stephen, and Owens, *JAEA* iv. 62-65). 'All Hópi proper names have some reference to the name of the Name Giver, never, unless coincidentally, to the clan totem of the Bearer of the name' (Voth, *FCMAS* VI. iii. 68). The real meaning of these names varies according to the clans which give them; and, even when the meaning of the individual components of proper names is known, grammatical vagueness often renders precise determination of the meaning of the whole very doubtful.

4. Marriage.—The matriarchy of the Hopi comes strongly to the fore in their marriage customs. The choice of partner usually depends upon the youth and maiden concerned, but the actual proposal is generally broached by the girl or by her representatives. Gifts are exchanged, but there is no marriage by purchase. Marriage is rare in summer or late spring, but is common in autumn or winter, when agriculture is at a standstill. Escorted by her mother (or, if she is dead, by her aunt), the girl goes to her future husband's house, where she grinds maize for three days, during which time she is expected to talk as little as possible. On the morning of the fourth day the heads of the pair are washed by their respective future mothers-in-law,¹ after which they pray, casting the sacred meal towards the dawn. After a wedding breakfast a mixture of lime, black stuff, etc., is thrown

¹ At Oraibi, after this first washing separately, 'usually the hair of the young couple is then washed thoroughly together in each bowl, and this hair washing, and especially the washing of the two heads in the same bowl, is said to be the "crucial moment" in which the two are supposed to "become one"' (Voth, *FCMAS* XI. ii. 148; in one instance observed by Voth the groom refused to have his head washed, this fact giving rise to jocular doubts whether he could be regarded as really married).

at one another by the older female relatives of the pair, especially of the bride, and by the father of the groom, this solitary representative of the sterner sex soon having the worst of the encounter. A few days later it is announced that the cotton for the bride's garments is to be spun. This work is performed by the men in the kivas, their food being cooked by the women in the bride's house. Her costume itself is made by the groom, assisted by his male relatives, especially the father. After it is completed—a task that may require several weeks—the bride, whose hair has meanwhile been dressed in the married women's style of two coils hanging down in front instead of the girls' side whorls in imitation of squash blossoms, returns to her mother's house, whither she is followed, during the day, by her husband. She is required to give his family a large compensation, usually in ground maize. The newly wedded pair live with the bride's mother until they can provide a home of their own. When sick, the groom returns to his mother's house, and he is even frequently regarded as an outsider in his wife's home. Among the Hopi pre-nuptial life is usually chaste, but, though unchastity is disapproved, it is condoned if marriage follows. If, however, illegitimate children are born, they enjoy the same legal status as others, in consequence of the matriarchal system in vogue among the Hopi.

The average Hopi family consists of 5.5 persons, and the population is gradually increasing; sterility is somewhat rare; cases of voluntary abortion are not unknown (A. Hrdlička, *Physiological and Medical Observations* [= *Bull.* 34 *BE*], Washington, 1908, pp. 42 f., 6, 52, 164). A remarkable pathological feature is the prevalence of albinism, which is restricted almost entirely to the Hopi and the Zuñi, the proportion among the former being 5.5 per 1000, and no marked increase or decrease being perceptible. Although albinos are not despised, and may marry those of normal colour, they themselves are very sensitive. Their marriages are frequently barren or their families are unusually small (*ib.* 191 ff.); and it is believed that albinism may be a punishment for the mother's violation of some tabu (54). According to the report of Dr. Jacob Breid, dated 4th Feb. 1905 (reproduced by Hrdlička, Table 9), out of a Hopi population of 1878, there were then 5 cases of complete albinism for each sex (2 each of children and 3 each of adults), 4 of goitre (female adults), 2 of epilepsy (1 child of each sex), 4 of idiocy for each sex (3 each of children and 1 each of adults), 1 deaf and dumb female child, 5 cases of spinal curvature (3 males and 2 females), and 67 of tuberculosis—24 pulmonary (males: children 3, adults 9; females: children 4, adults 8); 26 of bones and joints (males: children 10, adults 5; females: children 8, adults 3); 17 glandular (males: children 4, adults 1; females: children 8, adults 4).

5. Burial.—The hair of the corpse is washed and dressed; the chin and the lower cheeks are painted black; the brow is bound with a cotton cord; the face is covered with a rain-cloud masque; the body is bent together, tied, and wrapped; and prayer-sticks are placed in the hand. There is crying and mourning after death, but no screaming or loud lamenting, although there is wailing during the washing of the body and on anniversaries of the death, professional mourners being not unknown (A. C. Fletcher, in *HAI* i. 952). The adult dead are buried at night or early morning in a sitting posture, facing the east, in graveyards on the slope of the mesas or of hills near them, or they may simply be laid in crevices in the rock; the former is the normal practice at Mishongnovi and Oraibi, the latter at Shongopovi. The soul is afforded communication with the outer world by a

stick touching the body and projecting above the ground; and dishes, often filled with food, as well as a few petty ornaments, are placed by the grave, which usually has some mark indicating to what fraternity its occupant belonged. The graveyards are utterly neglected. The faces of children dying before initiation into any of the fraternities are not painted, nor do their foreheads have the cotton cord. Their bodies are thrust into rock-crevices.

On the 3rd day after death the last food- and prayer-offerings are prepared for the dead. The latter consist of a double green *baho*, a single black *baho* (the *chochokpi*, or 'seat'), an eagle breath-feather (the *pühu*, or 'road'), and about six *nakvakvosis* (a sort of prayer-bearer). The 'road' the father, brother, or uncle of the deceased

* places on the ground west of the grave, the thin string pointing westward. From this road he sprinkles a meal line westward denoting the continuation of the road. According to a belief of the Hopi, the *hikvsi* (breath or soul [on which see below, § 15]) of the deceased ascends early the next morning from the grave, partakes of the *hikvsi* of the food, mounts the *hikvsi* of the seat, and then travels along the road to the *masski* (skeleton house), taking the *hikvsi* of the double *baho* along as an offering. In the case of the death of a small child that has not yet been initiated into any societies, the road is made from the grave towards the home of the child, because it is believed that the soul of that child returns to the house of its parents and is reincarnated in the next child that is born in that family. Until that time the little soul is believed to hover over the house. It is said that when an unusual noise is heard in the house, for instance a crackling in the roof, they think the little soul is moving about, and the mother then often secretly deposits a pinch of food on the floor in some part of the house for her departed child. When I asked one time what became of that child-soul in case no further birth took place in the family, I was told that in such a case the soul remained near the house until its mother died, who then took the little soul with her to the other world' (Voth, *FCMAS* xi. ii. 103).

6. Religion: general character; ancestor-worship.—Hopi religion is broadly characterized by Fewkes (*JAF* xi. 180 ff., 19 *RBEW*, 625) as based on a composite totemism overlaid with rites for rain and corn, the two prime necessities of the arid environment. There is also some trace of a form of ancestor-worship in so far as the dead are apparently represented by the *gnelüpk*i, or crooks, placed about the altar of the Antelope fraternity—the shortest being for the oldest, since old age is most bowed—and the use of the *gnelüpk*i by the supervisor of snake-racers may have a similar implication (Fewkes, Stephen, and Owens, *JAEA* iv. 23, 75; Voth, *FCMAS* iii. iv. 311). Again, at the feast connected with the Humiskachina and Nimankachina one of the *kachinas*, who are also connected with the ancestor-cult, collects from the bowls of food given by each woman a pinch of every sort, this being placed in a shrine in a rock-crevice 'as food for the "early dead"' (Fewkes, *JAEA* ii. 43); while during the building of a house the future owner takes some food and places it in a niche of the unfinished wall (Fewkes, *JAF* x. 198 f.).

7. Sympathetic magic.—All Hopi ritual is permeated with the concept of sympathetic magic. Fewkes observes (*AmAn*, new series, iii. 211) that every Hopi clan owns sacred objects which 'are thought to possess magical powers by the use of which the priests can obtain sacred results, are almost universally totemic, and are intimately connected with the ancients, the worship of whom runs through all Hopi ritual.' He happily compares these objects—called *wimi*—with the Australian *churinga* (on which see *ERE* ii. 244b). When the clans combined, the *wimi* passed into the possession of priest fraternities, and are revered by several clans, although still owned by the descendants of the clans which introduced them.

Fewkes also suggests that in the dramatic attack upon the bearers of the sun-shield in the *Soyalünya* rite there is a representation of an onslaught on the sun by hostile powers, and that the purpose of the dramatization is to draw back the luminary from its threatened disappearance (15 *RBEW*,

271 f., *AmAn* xi. 102). In like manner the drenching with water and filth in the course of the *Wüwüchinti* ceremony is probably a rain-charm (Fewkes, *Proc. Boston Soc. of Nat. Hist.* xxvi. 436, 448). Again, smoking is

'a ceremonial religious custom; the pipe is the *O'mow-uh* (cloud-god), and the smoke the rain cloud.' 'The smoke carries the prayer from the chief; it transfers the wish of the smoker to the object; moreover, it is a cloud, and is symbolically efficacious in bringing that which clouds produce—rain' (Fewkes, *JAEA* ii. 124; *AmAn*, new series, iv. 504, note 2; cf. iii. 222, 445). Moreover, as Fewkes says (*AmAn* x. 144), 'the most prominent symbols and figurines on several Tusayan altars of widely different societies refer to the sun, rain-clouds, and the fertilization, growth, and maturity of corn. Masked performers represent supernaturals connected with the production of the latter. The ceremonial acts about the altars or in the public exhibitions have one intent, to affect the gods who control these necessities. In their complicated rites the priests believe they can do this by reproducing ancestral ceremonies, and are guided in their presentation by current legends. Personifications, masked or unmasked, are therefore introduced that the performance may be more realistic—a more accurate reproduction of the ancient.' The whole principle of the Hopi 'altar' is based upon this concept of sympathetic magic (see *ERE* i. 386). Women do not enter the *kivas* except to renovate them annually at the *Powamü*, and in the course of some of the other festivals when their presence is necessary (Mindeleff, 8 *RBEW*, 129, 134).

8. Mythology.—It is scarcely possible, in our present state of knowledge, to give any list of the worshipful beings of the Hopi. We have, for instance, *Cotokinüwü* ('Sky-heart'), this being also the Hopi name for the Christian God (Fewkes, *JAF* xv. 24, note 2; on the possible influence of Christianity upon the concept of *Cotokinüwü*, see Fewkes, *Proc. Boston Soc. Nat. Hist.* xxvi. 445); *Müyinwü*, the god of growth; *Omowüh*, the rain-god of the cardinal points; *Palülüköñ*, the Plumed Serpent; the war-gods *Püüköñhoya* and *Paluña-hoya*; *Masanü*, the god of the under world; *Kokyänwüqti*, the Spider-Woman; *Huzrüwüqti*, the 'Woman of Hard Substances'; *Hahaiwüqti*, the Old Woman, etc. Yet, as Fewkes declares (*AmAn*, new series, iii. 214),

'although apparently very complicated, Hopi mythology in reality is simple, as most of the names of the gods are attributive. Especially is this true of the Sky- and Earth-gods, the names of which are numerous and perplexing. It would, in fact, seem that every clan had its own name for each of these gods, and it is this multiplicity of names which makes a proper identification very difficult. Every clan had a great Sky-god and an Earth-god or -goddess, the former being the father, the latter the mother of all minor gods. Each clan also had its totemic ancestral members—the ancients, male and female—resembling each other in type but not in name. Three supernaturals, differing in name and personation, appear in connection with most Hopi altars. These three are (a) Sky-god, (b) Earth-god, and (c) Cultus hero or heroine. They are personated symbolically and may be represented by a human being, a graven image, or a picture, or by all these combined.'

An important feature of Hopi mythology is the pairing of divinities into male and female, so that Stephen (*op. Fewkes*, *JAEA* ii. 153, note) could observe that

'there are numerous dual gods. These are not good and bad, but male and female, as expressing essential completeness. There is no male deity without a corresponding female counterpart, but there are one or two which would seem to indicate that the two were united in one being. . . . In one or two instances two male deities are associated, but each of these has also a corresponding female deity known by the termination *má-ná* ['maid']. . . . *Dá-wá*, the sun, and his male relative, *Tái-o-wá*, divide the task of bearing the shining shield across the sky, each carrying it four days alternately.' Furthermore, Fewkes suggests (*AmAn* v. 17, note 3) that the Plumed Serpent (*Palülüköñ*) is the dualistic counterpart to the earth.

9. Totemism.—It has already been observed (above, § 6) that the basis of the Hopi religion is totemistic—a totemism which

'has become the worship of anthropomorphic parents, male and female, a reverence which amounts to worship of the souls of the dead; of beasts or animals as sharing in part a supernatural element possibly due to metempsychosis; and of the great elements foreign to simple totemism' (Fewkes, *JAF* xi. 194).

The principle of totemism comes conspicuously to the fore in the famous snake ceremony, where, according to Fewkes (19 *RBEW*, 1008 f.), the presence of snakes

'is generally supposed to show that this rite is a form of snake worship. It is rather a worship of the ancestors of the Snake clans, which are anthro-zoöomorphic beings, called the Snake youth and the Snake maid; but neither of these represents the Great Snake, nor has their worship anything to do with that of this personage, who was introduced into Hopi mythology and ritual by the Rain-cloud clans.'

This totemism is also the keynote of the ceremonial washing of the snakes in the kivas before the public celebrations (on this see Fewkes, *AmAn* xi. 313-318).

10. Nature-worship.—Like Hopi mythology in general, and like their altars, their conception of the Sky-god is, at least in its present form, composite. The general system of 'Sky-God Personations in Hopi Worship' has been discussed in detail by Fewkes (*JAF* xv. 14-32). The sun is his shield or masque, 'a visible symbol of the magic power of the Sky-god conceived of as an anthropomorphic being' (14). Ahüla, the Sun-god of the kachina clans, returns in the Powamü; and, when Eototo, the Germ-god and the ruler of the under world, leads these clan-ancestors in their westward departure at the Nimankachina, he can only be deemed the same deity under another aspect (19, 24). Indeed, the kachinas in general are connected with the solar cult. In the bird-men represented in the Soyaluña we again see a personation of the Sky-god (26 f.); and, when feather designs are found on almost three-quarters of all ancient Hopi decorated ware, while over two-thirds of the animal pictographs on pottery represent avian forms, we are here to find yet another mode of representation of the same deity (Fewkes, *AmAn* xi. 1-14), and it is for this reason that turkeys and, next to them in importance, eagles (in ancient times probably parrots as well) are kept for their feathers, which are used in the preparation of *bahos* (on which see below, § 11) and in countless ceremonies (Fewkes, *AmAn*, new series, ii. 690-707).¹ The Plumed Snake (Palülüköñ), which in the Palülüköñti religious ceremony emerges from sun-symbols and knocks over a symbolic field of maize, is a representation of the Sky-god wielding the lightning (Fewkes, *JAF* xv. 29); and the Bird-Snake personation in the Soyaluña at Walpi represents the return of the Sun-god (28), for

'the serpent represents the lightning, one attribute of the Sky-god, and the bird, another; combined we have the Bird-Serpent, the great Sky-god of those Hopi clans whose ancestors once lived in the "far south" (i.e. Palatkwabi)' (81).

An extremely interesting cult in this connexion is that of the Alosaka, the ancestors of the Aaltü ('Horn-Men'), who, in their personations—especially at Mishongnovi, where the cult was introduced by the Patuñ, the founders of the pueblo—wear close-fitting wicker caps bearing large curved projections of buckskin, painted white, and resembling the horns of the mountain sheep, which the Aaltü imitate in some of their actions. In Walpi the cult survives in the ceremonies of the Lefikapi, Wüwüchimti, and Soyaluña (see Fewkes, *AmAn*, new series, i. 524). Like the other horned gods—Ahüla, Calako, Tuñwup, and the Natackas—the Alosaka are intimately connected with the sun. At the same time, they represent the mountain sheep, and their cult is a highly modified form of animal totemism, while the purpose of the rites performed in this cult is the germination and growth of seeds—particularly maize—and the bringing of rain.

11. Sacrifice and prayer.—Reference has been made above (§ 6) to cases of sacrifice to the dead; but the most important form of Hopi sacrifice is that to the deities. At many feasts the first morsel is taken by the head priest and set on one

¹ All the full-grown eagles in the pueblos are killed, by choking only, on the day after the Nimankachina, and whistles of eagle bone are used in many ceremonies (Voth, *FCMAS* xi. ii. 108 f.).

side, probably as a sacrifice (Fewkes, *JAEA* ii. 29 f.; cf. above, §§ 3, 6). When departing from or returning to the pueblo, a stick or stone is thrown on a pile of such objects, especially at shrines of Masauñ, the god of the under world (Fewkes, *JAF* x. 195, *JAEA* iv. 41, note 1), for whom bits of food are placed in the rafters of the house, that he may not hasten the departure of any of the family to the under world (Mindeleff, *8 RBEW*, 102); the 'prayer-meal,' which is so important throughout Hopi ritual, is also to be considered a form of sacrifice, as is the *baho*, which is presently to be noted (Fewkes, *JAF* x. 196-200). In 1892, Fewkes witnessed a dog sacrifice at Sichumovi; and certain details in the treatment of rabbits after their death in the ceremonial rabbit-hunts may point to a former system of animal sacrifice. At the present time such sacrifice is rare; and, if it does occur, its type is highly modified (*ib.* 189). It is also noteworthy that the Hopi have a tradition of human sacrifice in connexion with their deluge legend.

An interesting object, which seems to be the medium between sacrifice and prayer, is the *baho*, or 'prayer-stick,' which bears the prayers to the deities. These 'prayer-sticks' are not confined to the Hopi, but are found also among the Navaho and Apache, with analogues among many other stocks (Hough, *HAI* ii. 304; Solberg, *AA* xxxii. 73). These *bahos*, which range from a few cm. to $\frac{1}{2}$ m. in length, are ordinarily double, 'male' and 'female,' bound together, and are made of sprigs of various sorts of willow and cottonwood trees, being adorned with pine needles, eagle feathers, etc., and painted in various colours.¹ They are prepared with fasting and other purifications, but are seldom made for the personal advantage of their manufacturer, being rather for others (cf., for an example, above, § 3), the personal prayer-bearer, or *nakvakvosi*, being somewhat similar; after they have been used, their sanctity is at an end. The *bahos* are placed in clefts in the rocks, in sacred spots and shrines, etc., usually in honour of specific deities or by special societies, and on certain ceremonial occasions. While they are being made or set in place, prayers are murmured over them, and, in their symbolism of colour, components, etc., the Hopi see a medium between him who prays and his god, so that they are a strengthening of the verbal prayer and the bearer of the petition in permanent form (Solberg, 58-59).

Like the prayer-meal, the *bahos* are regarded by Fewkes (*16 RBEW*, 297; cf. *JAEA* ii. 30, note 3) as 'sacrifice by symbolic substitution'; and he continues:

'Offerings of corn or meal would be natural among an agricultural people like the Hopi. Substitutes for human sacrifice to the gods were sometimes made by the Aztecs in the form of dough images, so that the method of substitution, common in Europe, was not unknown in America (see, further, *ERE* iii. 60b). . . . In these days sacrifice has come to be a symbolic substitute of products of the field—corn, flour, or *pahos*—still retaining, however, the names "male" and "female," and with a human face painted on one end of the prayer-stick.' The snake-whips are also to be regarded, according to Fewkes (*loc. cit.*), as true *bahos*.

Yet another form of substitutional sacrifice is seen by Fewkes (*JAF* x. 193) in the *tihus*, or dolls, which, carved especially at the Powamü, Palülüköñti, and Nimankachina, and presented to the little girls, are 'simulacra of the gods,'

¹ The pine needles are brought from the San Francisco Mountains; certain seeds from the region south of Holbrooke, Arizona (100-110 miles from Walpi); ochre from Teska (several days distant); and the colouring materials—red hematite and green malachite—often from the Havasupai (N.W. Arizona), etc. On the sites of Homolobi, Shakwabalyaki, and Chubkwichalobi, Fewkes (*AmAn* ix. 359-387) found Pacific coast shells, such as *Petunculus giganteus*, *Conus princeps*, *Haliotis fulgens*, *Oliva hiatula*, and *O. bispicata*, which he believes to have been brought by the Hopi in their migrations from the south.

and are analogous to the dough images of the Aztecs.

As a single example of the many verbal Hopi prayers may be cited the following, used at the Snake and Flute ceremonies and recorded by Dorsey, *FCMAS* iii. 213:

'Now we joyfully and encouraged are going to perform a ceremony here. May these clouds from the four world quarters have pity on us! May the rain-water meander through our fields and our crops! And then the corn, quickly having seeds, our children will eat; and they being satisfied, we shall also eat and be satisfied. And then after that it shall mature and we shall gather it in and put it up in our houses, and after that we shall eat and live on it. Therefore we are happy, and being strong shall perform this ceremony.'

12. Purification.—Ritual purity is as necessary to the Hopi as to any other people. Before many ceremonies continence is obligatory. At the conclusion of some ceremonies, particularly the Snake ceremony, before there can be a return to the ordinary mode of life, it is requisite to remove all that has been associated with the individual during the sacred period, this being accomplished by the taking of a strong emetic. It must also be noted that expectoration forms a portion of a number of rites, apparently with a religious signification (Fewkes, *JAEA* ii. 76, 93, 98, 103).

13. Symbolism and sinistration.—Symbolism, here a side of sympathetic magic (see above, § 7), runs through all Hopi ritual. The connexion of feathers with the sun has already been noted (above, § 10). Passing mention may be made of the representation of lightning by the snake (see above, § 10), as well as of the numerous rain-cloud symbols, such as the terraced forms found on many of the kachina masques, and the rich symbolism of the altars. To give a full account of Hopi symbolism would practically be synonymous with detailing the entire ceremonial system of this people (cf. Fewkes, *AmAn* v. 9-26).

As a single concrete example of Hopi symbolism we may cite that of the *sipapuh*, the representation, in the floor of the kiva, of the aperture through which mankind reached the surface of the earth.¹ According to Mindeleff (*8 RBEW*, 135),

'The *sipapuh*, with its cavity beneath the floor, is certainly regarded as indicating the place of beginning, the lowest house under the earth, the abode of Myuingwa, the Creator; the main or lower floor represents the second stage; and the elevated section of the floor is made to denote the third stage, where animals were created. Mr. Stephen observed, at the New Year festivals, that animal fetiches were set in groups upon this platform. It is also to be noted that the ladder leading to the surface is invariably made of pine, and always rests upon the platform, never upon the lower floor, and in their traditional genesis it is stated that the people climbed up from the third house (stage) by a ladder of pine, and through such an opening as the kiva hatchway; only most of the stories indicate that the opening was round. The outer world is the fourth world, or that now occupied.'

Symbolism likewise attaches to the cardinal points, of which the Hopi recognize six: north, west, south, east (in the order named), above, and below. The north really lies between the true north and west, being determined at Tusayan

'by the notch on the horizon from which the sun sets in the summer solstice; the second (west) by its setting in the winter; the third by its rising in winter; the fourth by its rising in summer' (Fewkes, *JAF* vi. 270, note). Each of these cardinal points has its own symbolical colour: north, yellow; west, blue or green; south, red; east, white; above, all colour; below, black (*HAI* i. 325).

A remarkable feature of Hopi ceremonial is the fact that circumambulation (*q.v.*) is performed sinistrally—north, west, south, east. This extremely curious phenomenon has been studied by Fewkes (*JAF* v. 33-42), his conclusion being that the north forms the initial point because, according to Hopi tradition, the *sipapuh* of the creation legend is far away to the north, whence even those

¹ The *sipapuh* is associated, in the Indian mind, with the orifice through which individuals are born (Fewkes, *JAEA* ii. 26).

aces which, according to tradition, came from the south originally emerged.¹

If this be so, it may perhaps be suggested that the reason why the west was taken as the next point, instead of the customary east, was because the legends of the cult-heroes—notably the Snake—represent them as journeying toward the west, the region associated with the dead (Voth, *FCMAS* iii. iv. 811, note 5).

14. Fire, bull-roarer, games.—The ritual preparation of fire among the Hopi, as at the Wüwüchinti and Sumaikoli, is by the drill method, and, as in India, the sticks are 'male' and 'female' (Fewkes, *AmAn*, new series, iii. 445; cf. *ERE* vi. 26^b, 29^a).

The bull-roarer (*q.v.*) is an important feature of Hopi ceremonies. It is regarded 'as a prayer-stick of the thunder and its whizzing noise as representing the wind that accompanies thunderstorms.' The Hopi 'make the tablet portion from a piece of lightning-riven wood, and measure the length of the string from the heart to



the tips of the fingers of the outstretched hand' (Hough, in *HAI* i. 170 f.). As is shown by the accompanying cut of the bull-roarer from a Hopi painting of the Tcolawitze kachina, the Hopi bull-roarer is, in many cases, markedly of the rain-charm type, having a terraced top to represent rain-clouds and bearing the lightning-snake (see Fewkes, *21 RBEW*, plates iii., xxx., xxxv., xlvi., xlviii., lviii.).

The games of the Hopi have been fully considered by Culin, in his 'Games of the N. Amer. Indians' (= *24 RBEW* [1907]), among these games being archery (390), ball race (666, 678 f.), bean shooter (760), buzz (755), cat's cradle (774; said by the Zuni to have been taught by the Spider Woman to her children, the twin War Gods [761, 779]), dice (160-165), double ball (649), hidden ball (337-339, 357-364), hoop and pole (495-498), races (807), shinny (633-635), stilts (731), tops (743 f.). At least some of these games are regarded by Culin as possessing a religious connotation, as ball race (666), double ball (649), hidden ball (337-339), and hoop and pole (424-426; cf. also 34, 433, 441).

Among the Hopi games, mention should also be made of a children's dance, called *wahikwinema*, or 'we-go-throwing dance,' from the fact that piñon knots are tossed to the spectators at its close. It is a secular imitation of the kachina dance, and, when observed by Fewkes on 16 Jan. 1900 (*AmAn*, new series, iv. 509 f.; cf. *21 RBEW*, 30), was performed by about 15 boys and girls, wearing ceremonial kilts and blankets, with painted bodies and with feathers in their hair, but without masques. The little girls play with *tihus*, or dolls, which are generally made by the participants in the Powamú, Palúluikoñti, and Nimankachina, but which possess no religious significance of value (Fewkes, *AE* vii. 45-74).

15. Anthropology and eschatology.—The theological anthropology of the Hopi is thus described by Fewkes (*AmAn* ix. 161 f.):

'The modern Hopi recognize in man a double nature, corresponding to body and soul, and to the latter they are said to give the expressive name breath-body. This breath-body man shares with organic and inorganic nature, and it likewise forms an essential part of objects of human manufacture. The figures which are so constant and prominent on altars have breath-bodies, and it is this essence, not the idol, which is worshipped. The prayer-bearer, or paho, has likewise a breath-body, and this is the essential part of the offering taken from the shrine by the god to whom it is addressed. The material stick remains in the shrine; the supernatural is taken by the God.

It is the breath-body or shade of man which passes at death through the *sipapuh*, or gateway, to the under-world, the place of its genesis before it was embodied as well as the post-mortem home. In this future abode, in their cultus of the dead, these shades or spirits live, engaged in the same pursuits they followed on earth. Even the different religious sodalities perform there much the same rites as in the upper-world, but

¹ The place of emergence was the Grand Cañon of the Colorado, whence also came the white men, who went to the east (Fewkes, *AmAn*, new series, i. 536, note 3).

with more resplendent paraphernalia, the magnificence of which is correlated with the imagination of the priest who may tell you of them.'

The best summary of Hopi concepts of the future life is that of Voth (*FCMAS* XI. ii. 99):

'The belief in a future state and in a continued existence after death is well defined in the religious conception and in many rites and ceremonies of the Hopi. That part of man which they believe to be immortal they call hikvsi. . . . In its practical application the hikvsi is to the Hopi what to us is the soul in its ethical sense. At death the hikvsi leaves the body. When asked whether it is this hikvsi or the deceased person that continues to live in the skeleton house, the average Hopi may get confused. He knows that the body of the dead decays, and believes that it is by virtue or through the part that escapes from the body through the mouth at death, that the dead continue their existence in the future world. The details, with regard to this fact, are more or less vague in the mind of the Hopi, and vary considerably in the different traditions, clans and villages.' Ten Broeck (*ap. Schoolcraft, Ind. Tribes*, iv. [Philadelphia, 1854] 86) reports a belief of the Hopi that at death they would be changed into animals, plants, or things.

With regard to the under world (*masski*, or 'skeleton house'), it is believed by the Hopi that the seasons are reversed—when it is summer above, it is winter below. On asking why the five summer 'moons' are named like those of the winter 'moons,' Fewkes (*15 RBEW*, 258) received

'this interesting hint, dropped by one of the priests: "When we of the upper world," he said, "are celebrating the winter Pa moon the people of the under world are engaged in the observance of the Snake or Flute, and vice versa." The ceremonies in the two worlds are synchronous. "That is the reason," said my informant, "that we make the Snake or Flute pahos during the winter season, although the dance is not celebrated until the corresponding month of the following summer."

From their many stories of the under world I am led to believe that the Hopi consider it a counterpart of the earth's surface, and a region inhabited by sentient beings. In this under world the seasons alternate with those in the upper world, and when it is summer in the above it is winter in the world below, and vice versa. Moreover, ceremonies are said to be performed there as here, and frequent references are made to their character. It is believed that these ceremonies somewhat resemble each other and are complementary. In their cultus of the dead the under world is also regarded as the abode of the "breath-body" of the deceased, who enter it through a sipapu, often spoken of as a lake. I have not detected that they differentiate this world into two regions, the abode of the blessed and that of the damned.'

16. Sources of culture and religion.—As has been stated above, both the culture and the religion of the Hopi are composite. That the Hopi are ultimately connected with the peoples of Mexico is energetically maintained by Fewkes, who writes (*AmAn* vii. 51 f.):

'The pueblos are frontier towns of house-builders, not of nomads, and are peopled by the descendants of colonists from Mexico, mingled with other stocks, by which they have been more or less modified and changed: hence, while comparatively low in the stage of culture, there is still enough to indicate that there are relationships to Central America. It is not improbable that both Mexican and Pueblo cultures originated from a region in northern Mexico, developing, as environment permitted, in its northern and southern homes. The refugees to the province of Tusayan lived under adverse conditions to reach any high degree of culture. They have, no doubt, much in their religious ceremonies, their arts, and their language in common with the nomads; they have intermarried to a limited degree with those of a hostile stock, and symbolism similar to theirs, and stories of like import may be repeated in tribes of widely different modes of life. These were not only the agriculturists; the Indians of the north-west coast were likewise house-builders, but in a very different way; yet with all the similarities which may be pointed out, the Pueblos are still a distinct people among the aborigines of the United States, and their closest affinities are with the peoples of the Salado, those of Casas Grandes, and those of Central America, including Mexico. There is need of further observation to demonstrate the truth of this theory, for such only can it be considered at present; but it can hardly be doubted that new researches must lead to important discoveries in this direction.'

In this connexion it must be borne in mind that the Nahuatl languages are held by such Americanists as Brinton, Chamberlain, and Kroeber, following the researches of J. C. E. Buschmann ('Spuren der aztek. Sprache im nördl. Mexiko und amerikan. Norden,' in *ABAW*, 1859), to be cognate with the Shoshonean, to which Hopi belongs (cf. Henshaw, in *HAI* ii. 556; for a meagre account of the Hopi language, see *NR* iii. 671-674). Moreover, it is generally agreed that the Aztecs, in

their invasion of Mexico, moved southward, dislodging the Huastecans, and driving them to Guatemala and Yucatan (cf. Keane, *Man Past and Present*, Cambridge, 1900, p. 411; Seler, in *28 Bull. BE* [1904] 541 f.). It would seem, accordingly, that from some common point certain clans of Shoshones who, in virtue of their environment, or through some other cause, had attained a certain degree of civilization, migrated, the one part southward into Mexico, the other northward to Tusayan. Just as the Aztec branch showed their receptivity of Huastecan culture, the Hopi branch were affected by their new surroundings, and accepted Navaho, Apache, Tewan, Keresan, and Zuñi elements of culture and religion.

LITERATURE.—The only general summaries of the Hopi of any value are the artt. on them by J. W. Fewkes, in *HAI* i. [1907] 560-568, and by J. Mooney, in *Cath. Encyc.* vii. [1910] 463 f. Much older material is summarized in T. Waitz, *Anthropol. der Naturvölker*, iv. [Leipzig, 1864] 207-209, and H. H. Bancroft, *NR* i. 528-556 (on all the Puebloan peoples), 600 f., and especially *Hist. of Arizona and New Mexico* (San Francisco, 1889 = *Works*, xvii.). On the early Spanish references, besides Bancroft's *Hist.*, see especially A. F. A. Bandelier, in *Papers of the Archaeolog. Inst. of Am.*, Am. Series, III. i. [1890] 114-117, 135, II. [1892] 366 ff. Among the chief early sources accessible in edited form are Pedro de Castañeda de Nagera, *Relation du voyage de Cibola*, tr. H. Ternaux-Compans, *Voyages . . . pour servir à l'histoire de la découverte de l'Amérique*, i. ix. (Paris, 1838); Antonio de Espejo, *Viaje en el año de 1583*, ed. and tr. in Hakluyt, *Voyages*, London, 1598-1600, III. 383-396 (= Glasgow reprint, ix. [1904] 169-204), and *Relación del viaje*, ed. in *Colección de doc. inéd. rel. al descubrimiento . . . de las poses. españ. en América y Oceanía*, xv. [Madrid, 1871] 163-189; Juan de Oñate, *Memorial*, ed. in *Colec. xvi.* [1871] 188-227; Francisco Garcés, *Diario*, ed. in *Doc. para la hist. de México*, Mexico, 1853-57, II. i. 309-337 (cf. E. Coues, *On the Trail of a Spanish Pioneer: The Diary and Itin. of F. G.*, 2 vols., New York, 1900). See also 'Moqui Pueblo Indians of Arizona and Pueblo Indians of New Mexico,' *Extra Census Bulletin*, Washington, 1893, and P. G. S. Ten Broeck, in H. R. Schoolcraft, *Ind. Tribes*, iv. [Philadelphia, 1854] 81-88.

The first modern study of the Hopi is by J. G. Bourke, *Snake-Dance of the Moquis* (New York, 1884). The most important literature is as follows: Nathalie Curtis, *The Indians' Book* (London, 1907), 473-532 (especially for Hopi songs, with music); J. W. Fewkes, 'A Few Tusayan Pictographs,' *AmAn* v. [1892] 9-26; J. W. Fewkes and J. G. Owens, 'The Lá-lá-kón-ta: A Tusayan Dance,' *ib.* 105-129; J. W. Fewkes and A. M. Stephen, 'The Mam-zrau-ti: A Tusayan Ceremony,' *ib.* 217-245; J. W. Fewkes, 'A Central Amer. Ceremony which suggests the Snake Dance of the Tusayan Villagers,' *ib.* vi. [1893] 285-306, 'A-wa'-to-bi: An Archaeolog. Verification of a Tusayan Legend,' *ib.* 363-375, 'On Certain Personages who appear in a Tusayan Ceremony,' *ib.* vii. [1894] 32-52, 'The Kinship of a Tanoan-Speaking Community in Tusayan,' *ib.* 162-167, 'The Kinship of the Tusayan Villagers,' *ib.* 394-417, 'Prehistoric Culture of Tusayan,' *ib.* ix. [1896] 161-178, 'Pacific Coast Shells from Prehistoric Tusayan Pueblos,' *ib.* 359-367, 'Tusayan Totemic Signatures,' *ib.* x. [1897] 1-11, 'Morphology of Tusayan Altars,' *ib.* 129-145, 'The Feather Symbol in Ancient Hopi Designs,' *ib.* xi. [1898] 1-14, 'Winter Solstice Ceremony at Walpi,' *ib.* 65-87, 101-115, 'Hopi Snake Washing,' *ib.* 318-318, 'The Alósaka Cult of the Hopi Indians,' *ib.*, new series, I. [1899] 522-544, 'The New-Fire Ceremony at Walpi,' *ib.* II. [1900] 80-138, 'Property-Right in Eagles among the Hopi,' *ib.* 690-707, 'The Owaküiti Altar at Sichomovi Pueblo,' *ib.* III. [1901] 211-226, 'The Lesser New-Fire Ceremony at Walpi,' *ib.* 438-453, 'Minor Hopi Festivals,' *ib.* IV. [1902] 482-511, 'The Sun's Influence on the Form of Hopi Pueblos,' *ib.* VIII. [1906] 88-100, 'Hopi Shrines near the East Mesa,' *ib.* 346-375, 'Hopi Ceremonial Frames from Cañon de Chelly, Arizona,' *ib.* 664-670, 'The Butterfly in Hopi Myth and Ritual,' *ib.* XII. [1910] 576-594, 'A Suggestion as to the Meaning of the Moki Snake Dance,' *JAFI* IV. [1891] 129-133, and 'The Ceremonial Circuit among the Village Indians of North-eastern Arizona,' *ib.* v. [1892] 33-42; J. W. Fewkes and A. M. Stephen, 'The Ná-ác-nai-ya: A Tusayan Initiation Ceremony,' *ib.* 189-221, and 'The Pa-lü-lü-koñ-ti: A Tusayan Ceremony,' *ib.* VI. [1893] 269-282; J. W. Fewkes, 'The Walpi Flute Observance,' *ib.* VII. [1894] 265-288, 'The Destruction of the Tusayan Monsters,' *ib.* VIII. [1895] 132-187 (four folk-tales), 'The Oraibi Flute Altar,' *ib.* 265-282, 'The Micoñinovi Flute Altars,' *ib.* IX. [1896] 241-255, 'The Sacrificial Element in Hopi Worship,' *ib.* X. [1897] 187-201, 'Growth of the Hopi Ritual,' *ib.* XI. [1898] 173-194, 'Hopi Basket Dances,' *ib.* XII. [1899] 81-96, 'Sky-God Personations in Hopi Worship,' *ib.* XV. [1902] 14-32, and 'A Few Summer Ceremonials at the Tusayan Pueblos,' *JAEA* II. [1892] 1-160; J. W. Fewkes, A. M. Stephen, and J. G. Owens, 'The Snake Ceremonials at Walpi,' *ib.* IV. [1894]; J. W. Fewkes, 'The Group of Tusayan Ceremonials called Katcinas,' *15 RBEW* [1897], 251-313, 'Tusayan Snake Ceremonies,' *16 RBEW* [1897], 273-312, 'Tusayan Migration Traditions,' *19 RBEW* [1900], 577-633, 'Tusayan Flute and Snake Ceremonies,' *ib.* 903-1011, 'Hopi

Katemas,' 21 RBEW [1903], 13-126, 'Dolls of the Tusayan Indians,' *AE* vii. [1894] 45-74, 'Provisional List of Annual Ceremonies at Walpi,' *ib.* viii. [1895] 215-237, 'A Study of Summer Ceremonials at Zuñi and Moqui Pueblos,' *Bull. Essex Inst.* xxii. [1890] 89-113, 'Tusayan New-Fire Ceremony,' *Proc. Boston Soc. Nat. Hist.* xxvi. [1895] 422-458, and 'A Theatrical Performance at Walpi,' *Proc. Wash. Acad. Sci.* ii. [1900] 605-629; B. I. Gilman, 'Hopi Songs,' *JAEA* v. [1908]; W. Hough, 'The Hopi in relation to their Plant Environment,' *AmAn* x. [1897] 33-44; E. G. Mearns, 'Ornitholog. Vocab. of the Moki Indians,' *ib.* ix. [1896] 391-403; C. Mindeleff, 'An Indian Snake Dance,' *Science*, vii. [1886] 507-514, and 'Localization of Tusayan Clans,' 19 RBEW [1900], 639-653; V. Mindeleff, 'Study of Pueblo Architecture,' 8 RBEW [1891], 13-228 (includes the valuable 'Traditional Hist. of Tusayan,' compiled from materials gathered by A. M. Stephen, 16-41); J. G. Owens, 'Natal Ceremonies of the Hopi Indians,' *JAEA* ii. [1892] 163-175; O. Solberg, 'Gebrauche der Mittelmessa-Hopi (Moqui) bei Namengebung, Heirat und Tod,' *ZE* xxxvii. [1905] 626-635, and 'Über die Bähos der Hopi,' *AA* xxxii. [1906] 48-74; A. M. Stephen, 'Legend of the Snake Order of the Moquis, as told by Outsiders,' *JAFI* i. [1888] 109-114; H. R. Voth, 'Oraibi Marriage Customs,' *AmAn*, new series, ii. [1900] 238-246; H. R. Voth and G. A. Dorsey, 'Oraibi Soyal Ceremony,' *PCMAS* iii. i. [1901] 1-59; H. R. Voth, 'Oraibi Powamu Ceremony,' *ib.* iii. ii. [1901] 60-158; H. R. Voth and G. A. Dorsey, 'The Mishongnovi Ceremonies of the Snake and Antelope Fraternities,' *ib.* iii. iii. [1902] 159-261; H. R. Voth, 'The Oraibi Summer Snake Ceremony,' *ib.* iii. iv. [1903] 262-358, 'Oraibi Natal Customs and Ceremonies,' *ib.* vi. ii. [1905] 40-61, 'Hopi Proper Names,' *ib.* vi. iii. [1905] 61-113, 'The Traditions of the Hopi,' *ib.* viii. [1905], 'The Oraibi Marau Ceremony,' *ib.* xi. i. [1912] 1-98, and 'Brief Miscel. Hopi Papers,' *ib.* xi. ii. [1912] 99-149 ('Notes on Modern Burial Customs,' 99-108; 'Notes on the Eagle Cult,' 107-109; 'The Oraibi New Year Ceremony,' 113-119; 'Tawa Baholawu of the Oraibi Flute Societies,' 123-136; 'Four Hopi Tales,' 139-143; 'Hopi Marriage Rites on the Wedding Morning,' 147-149).

LOUIS H. GRAY.

HORACE.—In the lifetime of Horace (65-8 B.C.) a great change came over the Roman world. If he had been in Rome at the time—but he was at Athens—he might have listened to the *Philippics* of Cicero, as a young man of twenty-one or twenty-two. In his later years, it had become obvious that Augustus had not only secured his own monarchical power, but was determined to provide for the succession to what was virtually a throne. In Horace's boyhood, it is fairly clear that the prevailing creed of educated Romans was Epicureanism. Lucretius had expounded with force and fervour the theory which denied all intervention of the gods in human affairs, and construed the universe as an aggregate of material atoms acting under mechanical laws; and, long before, a speaker in a tragedy of Ennius had put it in an epigrammatic form: 'That the gods exist I hold and shall continue to hold, but I deny that they are concerned with the doings of men; if they were, it would go well with the good, ill with the wicked,—but it is not so in the world I know' (*Telamo*, frag. 1, Ribbeck). In a time of disintegration and civil conflict, when the Republic seemed to be drifting to utter shipwreck, it was natural for men to think that the gods were careless of the welfare of Rome; just as, in a later day, the mob of the city is said to have stoned their temples when the news came of the death of Germanicus (Suet. *Calig.* 5). When Augustus restored peace and prosperity, it was possible to believe in Providence once more, and the new government made a deliberate attempt to revive the old religion of Rome; temples were rebuilt, and old ceremonies revived with unheard of splendour. According to Dio Cassius (lii. 36), Maecenas advised Augustus to practise and encourage religion, but to set his face against foreign superstition. The advice is characteristic of Horace's friend and patron, and of the strange contrasts in his nature. An indolent voluptuary at most times, he could on occasion display the greatest energy and tact; somewhat eccentric in his own literary tastes, he made no error in selecting for encouragement the really great writers of the time; interested in astrology, and perhaps ascribing his recovery from an illness to the benign influence of the planet Jupiter (Hor. *Odes*, ii. xvii. 22 f.), he

dissuaded Augustus from showing any favour to the Oriental creeds and rites which had already made considerable inroads at Rome. The revival of the old religion was undoubtedly a sound policy. The new government had to seek stability in continuity with the past, and political institutions at Rome were closely bound up with ancient rites and ceremonies. Maecenas made no slight contribution to the success of the design when he conciliated the ablest of the rising poets; and he must have been specially gratified by the accession of Horace, who had fought at Philippi under Brutus and Cassius. Horace was a later and more reluctant convert than Virgil.

Epicureanism still had its disciples, though it was no longer, perhaps, professed quite so openly. It has been remarked that the Augustan poets show a reluctance to name Lucretius or extol him directly. Virgil, exalting the knowledge of nature and the defiance of death that it brings, uses a phrase which shows us that he is thinking of Lucretius (*Georg.* ii. 492, 'strepitumque Acherontis avari'—Lucretius had spoken of the 'metus Acheruntis'). Horace, on his journey to Brundisium with Maecenas, is asked to believe that incense takes fire spontaneously on the threshold of a shrine; he refuses to do so, and uses words that belong to Lucretius, 'deos didici securum agere ævum' (*Sat.* i. v. 101). In saying 'didici,' Horace almost professes himself a disciple of the earlier poet; and it can hardly be doubted that Epicureanism was his prevailing belief, though he interested himself at times in other views. Probably Maecenas and he were as free from superstition as any two men of their time. Their ideal of life was progress towards the tranquillity and quiet good sense of Epicurus. 'You are free from avarice, you say. Well, but have all the other vices taken their departure too? Meaningless ambition? The fear of death? Anger? Dreams, the terrors of magic, miracles, witches, ghosts by night, and Thessalian portents,—have you a smile for them all? Do you count up your birthdays with a grateful heart? Are you forgiving to your friends? Do you grow kindlier and better with advancing years?' (*Epp.* ii. ii. 205 ff.). Horace had dealt scathingly with the sorceries of Canidia in the *Epodes* (v. and xvii.) and in an early *Satire* (i. viii.). Spiritual or unseen powers seem to have little place in his creed. He is a man of the world, who has arrived at some measure of mental tranquillity by the help of Epicurus.

In the *Satires* and *Epistles*, Horace speaks in a familiar tone, as to a friend or friends. He does so, too, in many of the *Odes*; but some of the latter are much more public and formal in character. He is addressing his countrymen generally, as the lyric poet of Rome (*Odes*, iv. iii. 23); and here we find him lending his support to the revival of the old religion. It was neglect of the gods that brought trouble upon Italy (*Odes*, iii. vi.), and only the restoration of the temples would avert its continuance. He goes far in the direction of deifying Augustus,—he imagines him seated among the gods and 'quaffing the cup of nectar with glowing lips' (*Odes*, iii. iii. 11 f.),—further, perhaps, than Augustus himself would quite approve; for, as far as Rome itself was concerned, he does not appear to have consented to more than the association of his *genius* with the twin *Lares* of the crossroads. In the *Carmen Saeculare*, Horace is the official poet of the State: that he was definitely commissioned to write a choric hymn has been confirmed by the record of the celebration found on stone: CARMEN COMPOSUIT HORATIVS FLACCVS. Here in carefully chosen phrase he exalts the deities of the festival and the deities in whom Augustus professed a special interest. Apollo was

his chosen guardian, who appears with his bow in Virgil's picture of the battle of Actium (*Aen.* viii. 704 f.), and to whom the Palatine temple with its libraries had been dedicated ten years before. Diana is, of course, associated with Apollo. Diana as Ilithyia, the Parcae (l. 25), and Tellus (l. 29) had received special homage during one of the nights of the festival. Venus *genetrix*, the ancestress of the Julian house, is not forgotten (l. 50), and Jupiter Capitolinus appears as sovereign of the gods in the closing stanza (l. 73). It seems a curious anticipation of the future that special honour is paid to the sun (l. 9 f.), when we recall the importance which the worship of Mithra was to assume in the third century of the Empire. Poetry was not the only art enlisted in the service of the new government. The ideas of the *Carmen Saeculare* are found also expressed in stone: on the breastplate of the great statue of Augustus, found on the site of Livia's Villa, we again meet with Apollo and Artemis, the rising sun climbing the sky in his chariot and the recumbent figure of the fruitful earth.

There is, no doubt, a considerable difference between the familiar writings of Horace and his more formal lyric compositions. In the former we have seen him deny the activity of the gods; in one of the latter he professes to have been converted from this 'insaniens sapientia' when he heard the thunder roll and saw the lightning flash in a cloudless sky (*Odes*, l. xxxiv.). Some such declaration may have been expected from the lyric poet of the new age. But, as far as the old religion of Rome is concerned, we must beware of charging Horace with gross inconsistency or hypocrisy; to do so is to some extent to misunderstand the nature of that religion. The religion of Numa was not dogmatic: it made but small claim upon the belief or faith of its votary; it asked for no deep spiritual change in his life. It was largely a system of ceremonies intended to propitiate certain unseen powers, whatever their precise nature might be. If they existed, they might influence the fortunes of Rome for good or evil; to continue their rites was at least prudent, and it was prompted by patriotism and veneration for ancient institutions. Such a religion probably had not lost its hold upon Italy to the extent we are apt to suppose; to revive it was not so very artificial and unreal an effort, nor did it involve any great mental or spiritual change in those who promoted the revival or acquiesced in it. See art. ROMAN RELIGION (Fourth Period).

LITERATURE.—W. Warde Fowler, *Rel. Exper. of the Rom. People*, London, 1911, Lect. xix.; W. Y. Sellar, *Horace and the Elegiac Poets*, Oxford, 1892, chs. iii., vi.; J. Wight Duff, *Lit. Hist. of Rome*, London, 1909, pp. 503 f., 513 f.; E. S. Shuckburgh, *Augustus*, do. 1908, pp. 222 f., 235 f. For references to dissertations on Horace's religious and philosophical views see M. Schanz, *Gesch. der röm. Lit.*, u. i. (Munich, 1901) § 263.

W. R. HARDIE.

HORÆ (Ἠραί, 'seasons').—In the development of Greek religion man's interests and emotions were focused first upon the earth as the source of his food, and then upon the heavenly bodies as the controllers of earth's fertility and seasonal changes. 'In analysing a god we must look for traits from earth, from "weather," from moon, from sun' (J. E. Harrison, *Themis*, p. 392). So the Horæ as weather-deities were preceded by a form or aspect in which they were the seasons of earth's fertility. In the decay and mutual shiftings of these primitive ideas and types, partly also from the very nature of religious conceptions, over-emphasis and over-precision are hard to avoid, and the analysis here made for the sake of clearness must not be mistaken for a historical evolution.

1. The Horæ as Nature-deities.—Primarily the Horæ were Nature-powers, controlling earth's fer-

tility through the weather¹—'warders of the gates of Olympos, whether to throw open the thick cloud, or set it to' (*Il.* v. 749 ff.), i.e. they send or withhold rain and dew—at first doubtless as autonomous powers, but later doing the will of Zeus, so that they tend to sink to the position of menial adjuncts of Olympian state.²

In Attica (a dry land with few streams) the dew was a precious thing (see Neumann-Partsch, *Physikal. Geog. v. Griech.*, Breslau, 1885, p. 30 f.), and the Horæ were there worshipped along with Pandrosos (Dew-maiden).³ Philochoros (in Athenæus, xiv. 656a) says that the Athenians offered boiled, not roast, meat to the Horæ, praying them to avert drought and excessive heat, and to send kindly warmth and timely rains⁴—'an interesting example of the admixture of religion with sorcery, of sacrifice with magic' (J. G. Frazer, 'The Magic Art' [= *GB*], pt. i., 1912, i. 310). The wreaths of mist and cloud which they spin are their own raiment, and in art their long flowing garb distinguishes them from the Graces (Charites [*q.v.*]), who finally put off all clothing (Paus. ix. 35. 6). The Horæ are always draped, and even partially veiled (see the beautiful Sosias cylix, Berlin, no. 2278, reproduced in J. E. Harrison's *Mythol. and Mon. of Anc. Athens*, London, 1890, p. 384).

Flowers and fruit were the gift of the Horæ; this was symbolized in art by their basket⁵ or laden bosom, and expressed in the local Athenian cult by their names—Thallo (Sprouting) and Karpo (Fruit). It was natural to associate them especially with the season of Nature's awakening, the spring-time (*Anth. Pal.* v. 70: *ελαρωῶν Ἠρῶν*; and cf. Meleagros, *ib.* ix. 363; in Hesiod [*Works and Days*, 75] they crown Pandora with flowers of spring, while the Charites bedeck her with jewellery). Thus identified with youthful grace and beauty in Nature,⁶ the Horæ appear in art as fair maidens, and there is hardly any attempt to differentiate the figures by means of attributes before Græco-Roman times (see P. Herrmann, *De Horarum apud veteres figuris*, Berlin, 1887). On the other hand, they were also closely connected with the gifts of harvest-tide, as is shown by the Procession of the Eiresione (*ειρεσιώνη*) at the Thargelia and Pyanopsia festivals (about May and October respectively), in honour of Helios (Apollo) and the Horæ; branches twined with figs and other fruits (*τὰ ὠραία πάντα*) were carried in procession, and finally set up before the house-door.⁷ Their noblest gift was the grape (*Od.* xxiv. 343 f.: *ἐνθα δ' ἀνὰ σταφυλαὶ παντοῖαι ἔασω, | ὄππότε δὴ Διὸς ὠραὶ ἐπιβρίσειαν ὑπερθεν*—where edd. should write Ἠραί; Athen. ii. 38c: *αὗται γὰρ τὸν τῆς ἀμπέλου καρπὸν ἐκτρέφουσι*).

The naturalistic significance of the Horæ explains their association with other deities, e.g. Hera (Paus. v. 17. 1 and ii. 17. 4), Aphrodite (Paus. v. 15. 3), Dionysos (Athen. ii. 38c), Demeter (*Homer. Hym. Dem.* 54), Apollo ('Pind. Pæan,' in *Oxyrh. Pap.* v. p. 25: *Ἠραὶ τε θεμλίγονοι φιλιππον ἀστὺ θήβας ἐπὶ ἡλθον Ἀπόλλωνι δαῖτα φιλοστέφανον ἀγοντες*), Pan (*Oxyrh. Hym.* x. 10: *σύνθρονος Ἠραῖς*).

2. The Horæ as seasons of the year.—The regular recurrence of the gifts of the Horæ is the primary mark of the recurring seasons, and so the Horæ

¹ The word ὠρα seems at first to have been almost equivalent to 'weather' (O. Gruppe, *Gr. Myth.*, Munich, 1906, ii. 1063, note 8).

² Paus. v. 11. 7: *καθὰ περ τινὰς φύλακας βασιλείως αὐτῆς. Cf. Il.* viii. 433, where they tend the horses and chariot of Hera.

³ Paus. ix. 35. 2: *τῆ δὲ ἐτέρᾳ τῶν Ἠρῶν νέμουσιν ὀμοῦ τῆ Πανδρόσῃ τιμὰς οἱ Ἀθηναῖοι θαλλῶ τὴν θεὸν ὀνομάζοντες.*

⁴ *μετὰ ὑδάτων ὠραίων ἐκτελεῖν τὰ φυόμενα.*

⁵ Euseb. *Præp. Evang.* iii. 11. 38: *κάλαθον ἔχουσι, τὸν μὲν τῶν ἀνθέων σύμβολον τοῦ ἔαρος, τὸν δὲ τῶν σταγῶν τοῦ θέρους.*

⁶ Pind. *Nem.* viii. 1 f.: *ὠρα πότνια, κάρυξ Ἀφροδίτας . . . ἄτε παρθενίῳ παιδῶν τ' ἐφίλοισα γλεφάροις.*

⁷ Schol. in Aristoph. *Knights*, 729: *Ἠλίῳ καὶ Ἠραῖς ἐορτάζονσι οἱ Ἀθηναῖοι. φέρονσι δὲ οἱ παῖδες τοὺς τε θαλλοὺς ἐρίοις περιειλημένους.* See A. Mommsen, *Feste d. Stadt Athen*, Leipzig, 1898, p. 279, and J. E. Harrison, *Prolegomena*, p. 79.

come to be identified with periods of time in the abstract; but they 'are not abstractions, divisions of time; they are the substance, the content of time' (J. E. Harrison, *Themis*, p. 185). The original dual¹ Horæ (mother and maid?) brought to men the gifts of Spring and early Summer (the flowers), and those of late Summer and Autumn (the fruits). Their number thus coincided with the obvious division of the year into the fruitful and unfruitful seasons (*θέρος* and *χειμών*); but it is not to this bi-partition that the duality of the Horæ must be traced, for Winter is no true Hora. Later came the distinction of *three* seasons,² perhaps connected with the observation of the lunar phases (cf. Servius on Verg. *Æn.* iii. 284: 'magnum sol circumvolvitur annum. Magnum, ne putemus lunarem esse . . . antiqui . . . dixerunt primo lunarem annum triginta dierum').

The Moon is the true mother of the triple Horæ, who are themselves Moiræ; and the Moiræ, as Orpheus tells us, are but the three *moiræ* or divisions (*μέρη*) of the Moon herself, the three divisions of the old Year. And these three Moiræ or Horæ are also Charites' (*Themis*, p. 189 f.).

But the development of divine dualities into trinities is probably not to be explained by any single formula; and the heraldic groupings beloved by archaic art had some influence here (see J. E. Harrison, *Prolegomena*, p. 288).

In function, and originally perhaps in name also, Horæ and Charites are hardly to be distinguished; the popular consciousness, at any rate, was not quite clear on this point (Paus. ix. 35. 2: *τιμῶσι γὰρ ἐκ παλαιῶν Ἀθηναῖοι Χάριτας Ἀψὼ καὶ Ἥγεμόνην. τὸ γὰρ τῆς Καρπῶς ἐστὶν οὐ Χάριτος ἀλλὰ Ὅρας ὄνομα*). Two Charites and two Horæ supported the front and the back of Apollo's throne at Amyklai (*ib.* iii. 18. 10); three of each surmounted that of Zeus at Olympia (v. 11. 7); Horæ and Charites together decorated Hera's crown at the Heraion (ii. 17. 4). The Borghese Altar (Louvre), an archaic work freely reproducing types of the 5th cent. B.C., shows three groups of Moiræ, Charites, and Horæ (see Friederichs-Wolters, *Gipsabgüsse*, Berlin, 1886, no. 422).

The earliest representation of the triple Horæ is that on the François vase (in Florence; *Mon. d. Inst.* iv. 54-57, early 6th cent. B.C.); in literature Hesiod first makes Horæ (as well as Moiræ) three, and names them (*Theog.* 902). Homer has no definite number for either Horæ, Moiræ, or Charites. The notion of *four* Horæ is, however, attained very early, for it occurs in Alkman³ (7th cent. B.C.)—'three Seasons set he, summer and winter, and autumn third, and fourth the spring, when trees burgeon, but man may not (yet) eat his fill.' Athenæus preserves a fragment of Kalixenos describing a pageant at Alexandria (time of Ptolemy II. Philadelphos [285-246 B.C.]), in which walked four Horæ dressed in character, each carrying her own fruits.⁴ In Roman art the type of the Horæ was modified as four allegorical figures with conventional emblems (for description, see Nonnos, xi. 488-519; the order of the figures and the interpretation of attributes are not always easy). The extension of their functions to embrace the hours as divisions of the day, and the consequent increase of their number to twelve, is a late and frigid conceit, of no religious or artistic significance (cf. Ovid, *Mét.* ii. 26).

3. The Horæ as deities of Fate.—The Moiræ in Hesiod are sisters of the Horæ, and both are children of Zeus and Themis (Hes. *Theog.* 901 ff.: *Θέμιν, ἣ τέκεν Ὅρας, . . . ἀτ' ἔργ' ὠρεῦνται καταθητοῖσι βροτοῖσι, Μοῖρας τε*). Themis is Social Order. Both

¹ Two Horæ at Megalopolis (Paus. viii. 31. 3); cf. Amyklai, *ib.* iii. 18. 10. At Athens they are grouped with Pandrosos to form a triad, just as the Charites are grouped with Hegemone (Artemis). Two Moiræ at Delphi (Paus. x. 24. 4).

² Cf. *Homer. Hym. Dem.* 398 f.: *οἰκήσεις ὠρέων τρίτατον μέρος εἰς ἐνιαυτὸν | τὰς δὲ δύο παρ' ἐμοῖ τε καὶ ἄλλοις ἀθανάτοισιν*; and Aristoph. *Birds*, 708.

³ Fr. 76, Bergk:

Ὅρας δ' ἔστηκε τρεῖς, θέρος
καὶ χεῖμα κῶπύραν τρίταν,
καὶ τέτρατον τὸ ἦρ, ὅσα
σάλλει μὲν, ἐσθίεν δ' ἄβαν
οὐκ ἔστιν.

⁴ Athen. v. 198b: *Ὅραι τεσσαρες διεσκευασμεναι καὶ ἐκάστη φερούσα τοὺς ἰδίους καρπούς*.

Horæ and Moiræ are agents of the will of Zeus¹ (Paus. i. 40. 4: *ὑπὲρ δὲ τῆς κεφαλῆς τοῦ Διὸς εἰσιν Ὅραι καὶ Μοῖραι· δῆλα δὲ πᾶσι τὴν Πεπρωμένην μόνῃ οἱ πείθεσθαι, καὶ τὰς ὥρας τὸν θεὸν τοῦτον νέμειν ἐς τὸ δέον*—which illustrates the way in which the sense of personality had gradually faded out of these figures). Cf. Theocritus (*Id.* xv. 104 f.: *βάρδισαι μακάρων Ὅραι φίλαι, ἀλλὰ ποθεῖναι | ἐρχονται πάντεσσι βροτοῖσι αἰεὶ τι φορεῦσαι*)—'Nor is there any God so slow as they; Yet longing eyes to them all mortals lift, For each Hour brings a gift' (J. W. Mackail, in *CLR* xxvi. [1912] 36). This aspect perhaps grew out of the perception of the recurrence of the seasons ever coming round with unvarying content (cf. *Od.* xi. 295: *ἄψ περιτελλομένου ἔτεος κα. ἐπήλυθον ὥραι*, and x. 469: *ἀλλ' ὅτε δὴ ῥ' ἐνιαυτὸς ἔην, περὶ δ' ἔτραπον ὥραι*).²

4. The Horæ as ethical powers.—Closely akin to the foregoing is the conception of the Horæ as guardians of the moral order. To this idea Hesiod gave first and final expression, and named the triad Eunomia,³ Dike, Eirene—Order, Justice, Peace (*Theog.* 902). In Pindar the two conceptions of the Horæ, as Nature-deities, and as invested with moral attributes, find their noblest expression, e.g. *Ol.* xiii. 6 ff.: 'Therein [in Corinth]⁴ dwell Order and her sisters, sure foundations of cities, even Justice and like-minded Peace, dispensers of wealth to men, golden daughters of wise Themis.' Bacchylides has the same sentiment (xii. 186)—'Eunomia, who keeps the cities of righteous men in peace.' 'As in the natural sphere the Horæ represent a fixed order, so as ethical powers they are Loyalty, Justice, and Peace' (Jebb).⁵

In this connexion we must refer to the Hymn of the Kouretes found (1904) at Palaikastro in Crete (R. C. Bosanquet, in *BSA* xv. [1908-09] 339 ff.; and J. E. Harrison, *Themis*, p. 1 ff.). One of its verses⁶ describes 'the blessings which flowed from the rule of Zeus,—order in the universe, the regular succession of the seasons, the beginnings of justice and peace on earth' (Bosanquet, *loc. cit.*)—'And the Horæ began to teem with blessings year by year (!), and Justice to possess mankind, and all wild living things were held about by wealth-loving Peace.' The date of this Hymn is perhaps about 300 B.C. (but the actual inscription belongs to about A.D. 200; we have to do with a 'revival').

LITERATURE.—W. Rapp, in Roscher, collects most of the literary references, and gives the monuments, which hardly concern us here; published in 1890, his article is somewhat obsolete in method. J. E. Harrison's *Proleg. to the Study of Gr. Rel.*², Cambridge, 1908, is now supplemented and often corrected by her *Themis: a Study of the Social Origins of Greek Religion*, do. 1912; both of these are important.

W. J. WOODHOUSE.

HORNS.—Horns play an important part both in religious symbolism and cult and in magic, and this for reasons which go back to a comparatively primitive stage of thought, as well as to early observations made by man regarding the use of horns

¹ Hence figures of both were seen together at Amyklai (Paus. iii. 19. 4), and above the head of Zeus at Megara (i. 40. 4).

² Here must be mentioned the erroneous idea that there was a festival called *Ὅραία*, explained by Hesych. as *νεκρία*, a festival for the dead. The word here is a mere epithet meaning 'what is seasonable,' *sc.* for the sacrifice (see Dittenberger, *Syll. inscr. Gr.*², Leipzig, 1900, no. 680: *ἐπάργματα ὧν αἱ ὥραι φέρονται*; and 616. 38: *Ζηνὸς ἐνιαυτῶν Ὅραία*); it has nothing whatever to do with the cult of the Horæ (see Stengel, *Opfergebr. d. Gr.*, Leipzig and Berlin, 1910, p. 163).

³ The name Eunomia was used in several Cretan towns as a collective title for the college of magistrates (Xanthoudides, in *Erh. Arch.*, 1908, p. 208).

⁴ *ἱερὸν* of the Horæ in Corinth (Paus. ii. 20. 5).

⁵ Cf. Diodorus, v. 73: *Ὅρων ἐκάστη δοθῆναι τὴν ἐπώνυμοι τάξιν τε καὶ τοῦ βίου διακόσμησιν*, alluding to the names given by Hesiod.

⁶ Text restored by G. Murray (*BSA* xv. 357)—

Ὅραι δὲ βροτῶν κατῆτος
καὶ βροτῶν Δίκα κατῆχε
πάντα τ' ἄγρι' ἀμφεπε ζῶ
ἃ φιλόλοσος Εἰρήνη.

by animals possessing them. These reasons will appear more clearly after certain facts regarding the place which horns hold in representations of divinities have been reviewed.

1. Divinities with horns.—In many religions, especially in those of antiquity, divinities are frequently represented in statue or image or picture wearing the horns of an animal on the head, or this characteristic is referred to in myths. In Babylonia the higher gods and genii often wear a head-dress with a double pair of horns surrounding the sides and front. Nin-tu, a form of the goddess Mah, is depicted with a horn on her head. Ramman is represented with four horns (see CROWN, vol. iv. p. 341^a).¹ Hittite deities also wore caps ornamented with several pairs of horns, probably those of a bull, as in the sculptures found at Ibriz, Carchemish, and elsewhere. Melkarth of Tyre was represented as an almost bestial god with two short horns on his head, and the Syrian Hadad has similar horns.² Phœnician goddesses usually have the horns of a cow, like Ashtaroth-Qarnaim, 'of the two horns,' but these may be borrowed from the Egyptian Hathor, identified with 'Ashtart.'³ Hathor, with whom the cow was identified, is depicted with a cow's head and horns, or merely with horns. Isis was assimilated to her, and cows were sacred to this goddess. Her usual ornament was a pair of horns with the solar or lunar disk between, but sometimes, as the female counterpart of the Ram of Mendes, she wore ram's horns. Ra has sometimes the disk with ram's horns, Osiris sometimes a crown with horns, and Nephthys has also the horns and disk. Kneph has a ram's head with horns, curving or long and projecting. The goddess Seti wears the crown of Upper Egypt, and from it project the horns of a cow.⁴ In Greece, Dionysos, one of whose forms was that of the bull, was called the 'horned,' or 'bull-horned'; and myth told how Persephone bore him as Zagreus, a horned infant.⁵ Pan and the satyrs showed traces of their goat origin in the goat horns with which they were depicted. Rivers were personified by divinities with horns or a bull's head, e.g. Achelous (q.v.) and others on coins. Ocean also had a bull's head.⁶ Some horned divinities may have been represented with horns through Egyptian influence, e.g. Io (equated with Isis), whom myth declared to have been changed into a cow by Hera, and with whom Hera was sometimes identified. Both goddesses had horns.⁷ The Gauls had a god of the under world with horns, called Cernunnos (perhaps = 'the horned,' from *cerna*, 'horn'); and a group of nameless gods, some with stags' horns, have affinities with him. Some goddesses also have horns.⁸ In India the sharp horns of Brāhmanaspati are referred to in a hymn, and the horns of Agni, who is sometimes characterized as a bull, are also mentioned.⁹ Yama, in Buddhist mythology, has horns. Northern Buddhism (Tibet) has also images of horned divinities in temples, and Mañjuśrī (= Yama) wears a pair of horns.¹⁰ In the lower culture, gods sometimes have horns. A carving from a temple in Fiji shows such a god,

¹ R. O. Thompson, *Semitic Magic*, London, 1908, p. 63; Maspero, *Dawn of Civilization*, London, 1894, p. 663.

² Perrot-Chipiez, iii. 568 f.; G. A. Cooke, *Text-book of North-Semitic Inscriptions*, Oxford, 1903, p. 164.

³ G. F. Moore, *JBL* xvi. [1897] 155 f.

⁴ Budge, *Osiris and the Egyp. Resurrection*, London, 1911, l. 53, 320, ii. 281; Petrie, *Rel. of Anc. Egypt*, do. 1906, pp. 23, 52, 60; Wilkinson, *Anc. Egyptians*, London, 1878, iii. 6, 30; Herod. ii. 41.

⁵ Clem. Alex. *Adhort.* ii. 15 ff.; Diod. Sic. iv. 4.

⁶ L. F. A. Maury, *Hist. des rel. de la Grèce ant.*, Paris, 1857-59, l. 162; Eur. *Orestes*, 1877.

⁷ Herod. ii. 41; Diod. Sic. i. 11.

⁸ MacCulloch, *Rel. of the Anc. Celts*, Edinburgh, 1911, p. 32 f.

⁹ *Rigveda*, l. 140, viii. 49, x. 155.

¹⁰ A. Grünwedel, *Myth. des Buddhismus*, Leipzig, 1900, pp. 62, 101, 188, and figures; L. A. Waddell, *Buddhism of Tibet*, London, 1895, p. 269.

and many examples are also found among the American Indians.¹

In many of these instances there can be no doubt that the horns worn by the gods are the relic of their earlier animal forms. Earlier worshipful animals became anthropomorphic; or, again, a worshipful animal was blended with a god. Myth and art retained for the god some part of the animal—head, or pelt, or hoofs, or limbs, or, in this case, the horns. But these last were also a symbol of power, naturally retained for the powerful god. In other cases, however, such symbols of strength may have been given to a god who had no animal past. One of the most obvious things about horned animals noted by man was the use made of their horns as instruments of destructive force. Animals butted with their horns, or tossed men or other animals with them, or ripped open their bodies. There was also a period in man's history when he made use of horns as weapons or tools. During the Stone Age, and also surviving into the Bronze Age, weapons and tools—harpoons, picks, wedges, chisels, punches, hammers, etc.—were made of reindeer's or stag's horn, and the same material sometimes served as hafts or sockets for axes.² The Columbia Indians of N. America still use axes, etc., of horn.³ This use of horns by man was transferred to the gods; e.g. in Teutonic mythology, Freyr, for want of a sword, slew Beli with a buck's horn.⁴

Thus the horn or the horned animal became a natural symbol of strength. Early religious poetry, art, and myth frequently compare gods or heroes to powerful horned animals. Balaam describes God as having towering horns like a wild ox.⁵ The tribe of Joseph is said to have horns like those of the unicorn, with which he will push the peoples.⁶ Early Egyptian monuments depict a huge bull destroying the walls of town or fortress, or piercing enemies with his horn; he represents the animal-god, or a god, or the king his descendant.⁷ In *Iliad*, ii. 480 f., Agamemnon is compared to a bull, the most conspicuous animal in the herd. Celtic heroes and kings bear such titles as *Brogi-taros* or *tarb in chōicid*, 'bull of the province'; or they are called 'bull-phantom,' 'prince bull of combat'; or their personal names—Donnotaurus, Deiotaros—show that they were named after the Divine bull.⁸ The Vedic god Indra is likened to a horned bull which will repel all peoples, and Soma and other divinities are described in the same way.⁹ Mythical animal-gods are also said to destroy demoniac enemies by means of their horns.¹⁰ Hence the word 'horn' is sometimes used figuratively as the equivalent of power or strength. So, in Hebrew usage, raising the horn of a people or an individual signifies victory or pride, 'breaking' it signifies defeat;¹¹ and God is called 'horn of salvation,' or He raises up for His people 'a horn of salvation.'¹² The Latin usage is similar, *cornu* being used metaphorically for strength and courage.¹³ In Dn 7⁷,²⁴ and Rev 17¹² horns signify

¹ *Handbook to the Ethnog. Collections* (Brit. Mus.), 1910, p. 139; E. R. Emerson, *Ind. Myths*, London, 1884, pp. 154, 276, 298 f.; F. S. Drake, *Ind. Tribes*, Philadelphia, 1884, l. *passim*; 21 *RBEW* (1903), pp. 69, 81, 101, 121, etc.

² R. Munro, *Prehist. Scotland*, Edinburgh, 1899, p. 159; B. C. A. Windle, *Remains of the Prehist. Age in England*, London, 1904, p. 108 ff.; *Guide to the Antiq. of the Stone Age* (Brit. Mus.), 1902, pp. 57, 79, 81, 113; *Guide to the Antiq. of the Bronze Age* (ib.), 1904, pp. 93-95.

³ *NR* l. 117.

⁴ Grimm, p. 1355.

⁵ Nu 23²².

⁶ Dt 33¹⁷; cf. Ezk 34²¹.

⁷ G. Foucart, *Hist. des rel.*, Paris, 1912, p. 69 f.

⁸ MacCulloch, 139, 209.

⁹ *Rigveda*, vii. 19; E. W. Hopkins, *Rel. of India*, Boston, 1895, pp. 116-119.

¹⁰ Cf. *Bundahis*, xix. 6 (*SBE* v. [1880] 68).

¹¹ See Ps 75⁵, 10 89¹⁷ 92¹⁰ 148¹⁴, 1 S 21¹⁰, La 2³, Jer 48²⁵.

¹² Ps 18², Lk 16⁹; cf. 1 K 22¹¹, where horns of iron are used to symbolize future victory—'pushing the Syrians.'

¹³ Ovid, *Am.* iii. 11. 6; Horace, *Od.* iii. 21. 18.

kings and their power, and in En. 90⁹⁵. a lamb with horns signifies Judas Maccabæus, and other horned lambs the Maccabees.

It is thus obvious that the addition of horns to the image or representation of a god might symbolize his divine power apart from his being related to any earlier animal-god. This is analogous to the addition of a third horn to the pair already possessed by horned animal-gods—the triple-horned divine bull or boar of the Celts, or the three-antlered stag of a Fionn story,¹ or the giving of a horn to an animal which naturally does not possess it, e.g. the serpent, as in the case of a horned serpent on a Gaulish altar, the Thracian horned snake Zagreus, and a similar horned snake in American Indian legend.²

Some moon divinities were represented with a crescent moon on their heads or were symbolized by it. This crescent bears a certain resemblance to a pair of horns, the likeness being occasionally emphasized, and there was a tendency to confuse the crescent moon on the divinity's head with horns. This is seen, e.g., in the case of the Bab. moon-god Sin, the Greek Io, and the Egyptian Isis. But there is no clear reason for supposing that the crescent moon is the origin of all horns as applied to divinities.³

2. Semi-divine and demoniac beings with horns.—Nothing is more usual than to find various beings of a semi-divine, but more usually of a demoniac, character invested with horns. The fauns and satyrs of Greek mythology are an example of this, and more or less corresponding to these are the Russian wood-spirits, or *ljesyj*, with goat-horns. These may be regarded as later anthropomorphic forms of earlier woodland spirits conceived as goats. Bab. demonology attributed to many of its monstrous demoniac beings animal heads or horns, e.g. a sea-monster with the ears of a basilisk and horns twisted into three curls, while the demon of the S.W. wind had the horns of a goat. It should be noted that Ea-bani has goat-horns as well as other animal features.⁴ In ancient Persia the conglomerate animal representations of evil powers were often horned, though here the figure of a good genius is also horned.⁵ Hebrew and later Jewish demonology had similar creatures—in some instances, perhaps, the semi-divine beings of the surrounding paganism transformed into demons, e.g. the *š'irim* of Lv 17, 2 Ch 11¹⁵, Is 13²¹ 34¹⁴, probably horned beings akin to the Greek satyrs and, like them, of goat origin. There was a demon called Keṭeb Meriṭi with the head of a calf and a revolving horn; and an ox-like demon dwelling in desolate places.⁶ Hindu and Buddhistic mythology and belief also know horned demons; and the Japanese *oni* are frequently seen in human form but with bulls' horns.⁷ Demons in later Slav belief often have horns; but this is a conception which is common to Christian demonology in general, as a glance at mediæval and later pictures of hell or of demoniac or witch orgies will show.⁸ Invariably also the devil presented himself to popular imagination with horns, goat-like face, hoofs, and tail. In both cases we have here a reminiscence of horned demi-gods—Pan, the satyrs and fauns, the Celtic *dusii*⁹—to all of whom, as far

¹ MacCulloch, 209 ff., 213.

² RA xxxi. (1897) 313, xxxv. (1899) 210; S. Reinach, 'Zagreus, le serpent cornu,' *Cultes, mythes, et religions*, Paris, 1906, ii. 63 ff.; M. A. Owen, *Folk-Lore of the Musquakie Indians*, London, 1904, p. 4; a so-called 'horned serpent' (*cerastes cornutus*) is known in Egypt and Palestine (cf. Gn 49¹⁷ RVm; Herod. ii. 74).

³ See the conclusive remarks of Scheftelowitz, in ARW xv. 461 ff.

⁴ R. O. Thompson, *Devils and Evil Spirits of Bab.*, London, 1903-04, ii. 147; Maspero, 576, 632.

⁵ G. Rawlinson, *Five Great Monarchies of the Ancient Eastern World*, London, 1867, iv. 337.

⁶ JE, s.v. 'Demonology,' vol. iv. pp. 616^b, 617^c.

⁷ See ERE iv. 611^a. The Greek Medusa is sometimes horned (F. T. Elworthy, *Evil Eye*, p. 198).

⁸ See, e.g., A. F. Le Double and F. Houssey, *Les Velus*, Paris, 1912, plates, *passim*.

⁹ Aug. de Civ. Dei, xv. 23.

as they existed in folk-memory, a demoniac form was given. Grimm, however, connects the goat-like form of the devil with the goat which was the sacred animal of Donar, 'whom the modern notions of the Devil so often have in the background.'¹ Thus, while, in some instances, horned spirits or demons derive from earlier animal-gods or are earlier anthropomorphic horned gods transformed to demoniac shape through the influence of a new religion, in others, horns seem to have been deliberately assigned them along with other bizarre attributes, in order to intensify their monstrous and awe-inspiring aspect.

3. Horned men.—Horned head-dresses were frequently worn by certain persons. Kings sometimes wore such head-dresses, probably because they were regarded as incarnations or representatives of horned gods, or simply as an emblem of their power. Part of the head-dress of an Egyptian king consisted of horns, like those attributed to Osiris.² Bab. and Assyr. kings wore rounded caps with parallel horns encircling them from behind, and curving upwards towards the front without meeting. These resembled the head-dresses of the gods.

Ovid relates a curious story which shows how horns were regarded as a symbol of kingship. Cipus the prætor, looking at his reflexion in water, saw that horns were on his forehead and then found that they were actually there. Anxious to know what this portent meant, he offered sacrifice, and the augur, after inspecting the entrails and seeing the horns, addressed him as future king. Rather than consent to be king, he desired sentence of banishment; but, though this was agreed to, his head with the horns attached to it was engraved on the posts of the gate (*Metam.* xv. 565 ff.). This is not unlike the legend of Alexander the Great, who is referred to in the Qur'an (xviii. 82) as horned. The origin of this is probably to be found in the fact that he identified himself with the god Ammon, and was represented on some of his coins with ram's horns, like the god himself.

In painting and statuary, Moses was often represented with horns. This is usually referred to the text of Ex 34²⁹, where it is said 'the skin of his face shone,' lit. 'sent forth horns.' 'Horns' is here taken to mean 'beams of light,' but not improbably there is a textual error (see *EBi*, s.v. 'Horn'). Aquila and the Vulgate translated the text 'quod cornuta esset facies sua,' and thus the legend grew. But it may have been influenced by that of Alexander as well as by the Bab. and Egypt. representations of horned gods.³

Among some savage peoples, horns occasionally form part of the insignia of chiefs. This custom is found among the American Indians, the horns being sometimes still attached to the animal's skin, which covers the head, or they may be made of metal.⁴ Priests and medicine-men sometimes wear horns—either as identifying them with some horned god, or because of some magical power attributed to the horns, or as a symbol of office. This is found among savage tribes, and it was also customary with the priests of Babylonia.⁵ Again, the horn decoration may be worn by the men of a tribe or by its warriors, as among the Alundu, where the men wear horns as part of their headgear.⁶

The wearing of *horned helmets* may have been derived from an earlier custom of wearing a head-dress composed of the skin of the head with the horns of an animal, but the horns on the helmet were probably also intended to have some apotropaic force in face of danger. The Sardinians are represented on Egyptian monuments wearing horned casques.⁷ Such helmets were also in use among the Etruscans, Romans, and Greeks, as is

¹ *Teut. Myth.* pp. 996, 1003.

² Foucart, p. 186.

³ In a Talmudic legend, Cain is said to have had a horn on his forehead—the mark of Cain (Baring-Gould, *Legends of OT Characters*, London, 1871, i. 103).

⁴ G. Catlin, *North Amer. Indians*, London, 1844, i. *passim*; F. Boas, *Internat. AE III* (1890) 10.

⁵ Scheftelowitz, ARW xv. 472.

⁶ H. H. Johnston, *George Grenfell*, London, 1908, ii. 699.

⁷ Wilkinson, i. 219, 245.

shown by examples which have been discovered as well as by designs on coins. They were also worn by Celtic warriors, and some specimens which have been found have large curving horns elaborately ornamented.¹ Similar horned helmets are figured on the Gundestrup vase, and some Anglo-Saxon helmets were horned.

Mimetic dances, usually for the purpose of securing luck in hunting, are found among savages, e.g. the American Indians; men disguise themselves with the skin and horns of the animal to be hunted.² In Germany and in Gaul, during the Kalends of January, riotous processions of men masquerading in a similar manner took place, and, continuing in Christian times, were vigorously combated by the Church. These had probably some connexion with the earlier animal-cults of Celts and Germans.³ In different parts of England, e.g. in Staffordshire, and sporadically elsewhere, masquerade dances of men wearing deer-horns, etc., occur periodically. Thus at Bromley six men carry reindeer-horns, and dance through the town. The horns are kept in the church tower. Whether these are connected with the older practice just referred to, or whether, as is alleged, they represent a custom connected with an ancient privilege of the *custodes silvarum*, is uncertain.⁴ In Bulgaria at carnival time the actors in a masquerade wear masks combining, e.g., a man's head and an animal's horns.⁵ Elsewhere—in Hungary, Bohemia, Sweden—the human representative of the corn-spirit in animal form wears a goat's or cow's horns;⁶ and the grotesque masks worn by savages on ceremonial occasions often have horns attached to them.

The expression, used of a husband whose wife has been unfaithful to him, 'to give horns to' or 'to graft or plant horns on' (Fr. *porter les cornes, cornifier*; Germ. *einem Hörner aufsetzen*; Ital. *portar le corna*), occurs with great frequency in popular literature from at least the 15th cent. onwards.⁷ Caricature also commonly represented the husband wearing horns. But the phrase is of much earlier occurrence and was known to the Greeks, as Artemidorus cites it, *κέρατα αὐτῷ ποιῆσαι*.⁸ With this is also connected the gesture of reproach, either reproach generally or for this particular misfortune, which consists of pointing with the index and little fingers outstretched like horns—'to make or point horns at' (Fr. *faire les cornes à*; Ital. *far le corna a*). It was an old custom, when a wife was wrongfully accused, for the husband to be dragged in procession wearing antlers, or for the wife to carry his horned effigy. Brand⁹ cites many suggested explanations of the phrase 'to give horns to,' none of them satisfactory. Dunder¹⁰ finds the origin in the old practice of engrafting the spurs of a castrated cock on the root of the excised comb, which caused them to grow like horns, and adds that Germ. *Hahnrei, Hahnreh*, 'cuckold,' was originally 'capon.' If, however, the gesture of contempt (originating in the similar gesture against persons suspected of the evil eye, who would therefore be held in contempt), the *mano cornuta*,¹¹ was made commonly to wronged husbands, who have been the subject of popular jest in all ages, it might easily give rise to the other phrase 'to give horns to.' Jorio¹² speaks of the gesture as being used by the ancient Greeks. It should be noticed also that in Spain it is an insult to put up horns against a neighbour's house.

4. Magical aspects of horns.—Any part of a sacred or sacrificial animal tends to be regarded as containing the virtues of the whole. This is especially true of the horns, a comparatively indestructible part; and, as they are an adjunct of the skull or head, which is peculiarly regarded as possessing virtue, the spirit of the animal acting through it,¹³

¹ Diod. Sic. v. 30; *Guide to Antiq. of Bronze Age* (Brit. Mus.), 1906, pp. 88, 95; R. Munro, *Prehist. Scotland*, p. 238 f.; J. Romilly Allen, *Celtic Art*, London, 1904, p. 93 f.

² *FL* viii. [1897] 70.

³ MacCulloch, 260; E. K. Chambers, *Medieval Stage*, Oxford, 1903, App. N, for evidence from councils and canons.

⁴ *FL* vii. [1896] 382, xxi. [1910] 26 ff.

⁵ *ARW* xi. [1908] 408 f.

⁶ Frazer, *GB*², pt. v. [1912] i. 89, ii. 327.

⁷ Cf. Shakespeare, *Merry Wives*, ii. 2, v. 5, *Much Ado*, ii. 1, *Titus And.* ii. 3; and innumerable other instances, especially in the dramatists.

⁸ *Oneirocr.* ii. 12.

⁹ *Pop. Ant.*, London, 1854, ii. 181 ff., s.v. 'Cornutes.'

¹⁰ *Germania*, xxxix. [1884] 50.

¹¹ See § 4 (c).

¹² *Mimica degli antichi*, Naples, 1837.

¹³ See HEAD, § 6.

the power attributed to them is thus intensified. Hence the horns of any animal, whether sacred or not, are thought to have special virtues.

(a) *Horns on houses*.—As the heads of horned animals are sometimes placed over doors as protectives, so occasionally the horns, alone or attached to the frontal part of the skull, are thus used. The Greek and Roman custom of placing the head of the sacrificial ox over the door of a house to ward off evils—*βουκράνιον, bucranium*—is a case in point.¹ Cows' horns were hung up on the temple of Diana on the Aventine, and deer-horns on other temples of Diana, while horns were a common adjunct of shrines and altars.² Cows' horns are frequently placed over doorways of dwellings, stables, or cowhouses in Italy and Germany; and in Asia Minor, India, Persia, and Afghanistan the horns of stags, oxen, wild goats, or rams are often seen in a similar position.³ The custom is not unknown in England, but at Horn Church, Essex, the horns fastened over the east part of the church are of lead.⁴ Horns of oxen are placed on gables of houses in Sumatra; and in Tibet a ram's skull and horns protect doorways.⁵ Horns may have been similarly used in pre-historic times.⁶

(b) *Horns of the altar*.—Hebrew altars had projections at each corner called 'horns of the altar,' and upon these the blood of sacrifices at the consecration of priests and at the sin-offering was sprinkled. The altar being a sanctuary for the criminal, it was customary for him to take hold of the horns.⁷ The Cretan and Mycenaean 'horns of consecration,' found as models, or depicted in cult scenes, consist of a base from which rise two horn-like uprights, curving outwards. They are found on shrines, altars, etc., and in some cases the sacred pillar or the double axe rises out of them. These 'horns' are now generally recognized to be conventional representations of an earlier *βουκράνιον*: a vase-painting actually shows the two forms together, and from both rises the double axe.⁸ The *βουκράνιον* may have been affixed to the altar as a protective or as representing the animal-god, and would tend to become more and more conventional or symbolic. Similar horns have been found crowning models of shrines, and in connexion with pillars, at the sanctuary of Aphrodite at Paphos,⁹ and they have also been discovered in Malta.¹⁰ On Greek and on Arabian altars, heads of oxen are depicted—a surrogate for the actual *βουκράνιον*.¹¹ Although various theories have been proposed for the origin of the horns of the altar in Hebrew usage, this probably explains their presence, as W. R. Smith suggested.¹² The same usage of affixing wild sheep's horns to altars is found in Tibet.¹³ In Greece, altars made of horns, as at Delos, were not unknown.¹⁴

(c) *Horns as amulets*.—It has been seen that horns are used as protectives for houses, etc. Actual or artificial horns are also worn as a defence against the evil eye, and this custom is one of great antiquity, as Jorio has shown.¹⁵ Artificial horns are made of the precious metals, coral, amber, etc.,

¹ See HEAD, § 6.

² Martial, *de Spect.* i. 6; W. Warde Fowler, *Roman Festivals*, London, 1899, p. 199.

³ Elworthy, *Evil Eye*, pp. 213-216; *ARW* xv. 477; *FL* xii. [1901] 192; Croke, *PR*², London, 1896, ii. 225.

⁴ G. L. Gomme, *Ethnol. in Folklore*, London, 1892, p. 35.

⁵ Elworthy, 213; L. A. Waddell, 484.

⁶ M. Hoernes, *Urgesch. der bildenden Kunst*, Vienna, 1898, p. 502 f.

⁷ Ex 27² 29¹² 38², Lv 47², Am 3¹⁴, Ezk 43²⁰, 1 K 1⁵⁰ 22⁵.

⁸ See *ERE* i. 144 f.; *ARW* viii. [1905] 145, 513.

⁹ Frazer, *Adonis*², London, 1907, p. 29.

¹⁰ R. N. Bradley, *Malta and the Mediterranean Race*, London, 1912, pp. 99, 130.

¹¹ W. R. Smith, *Rel. Sem.*², London, 1894, p. 436 n.; D. Nielsen, *Die altarb. Mondreligion*, Strassburg, 1904, p. 111 f.

¹² See, however, ALTAR (Semitic). ¹³ Waddell, 283.

¹⁴ Maury, i. 176; *Plut. Thes.* 21.

¹⁵ *Mimica degli antichi*, p. 89 ff.

and they are carried on the person or attached to the harness of horses, and the like. Such amulets have been found in Crete, in Etruscan graves, etc., and their use is wide-spread in the southern lands of Europe—Spain, Portugal, Italy.¹ The *mano cornuta*, or horned hand—a gesture in which the index and little finger are pointed outwards, the others being folded under the thumb—is extensively used, and is found also in early Roman, early Christian, and Hindu art, while it was formerly known in Great Britain. It is sometimes enough to utter the word *cornu* to repel an evil influence.² Artificial amulets representing horns or horned heads were used in ancient Egypt.³ In India the horns of gazelle, antelope, etc., either in whole or in part, repel sicknesses, and horned amulets are in use against demonic influences, while pieces of horn are still effective as ghost-scarers.⁴ Horn amulets are also much used in Further India, China, and Japan.⁵ Among the lower races similar uses of horns are found. In Africa and among the American Indians they are worn as amulets, either in the hair or suspended from the neck, as protectives against sickness or witchcraft.⁶ In Sierra Leone they are attached to a fetish.⁷

Horns are placed on graves to protect the dead from evil influences, e.g. in ancient Peru, in Flores, and among the Nuba of the Upper Nile.⁸ Among the Bari, on the occasion of a death, ox-horns are suspended from a pole above the spot.⁹

Horns ground to powder form an occasional folk-medicine. Among the Wajagga, warriors drink a potion of horn-shavings and rhinoceros-hide in order to obtain the animal's strength.¹⁰ In Egypt an antidote for poison is to drink out of a rhinoceros' horn and to rub in the draught a piece of the horn.¹¹ In Spain, horn-shavings are drunk as a panacea against the evil eye.¹²

In Cyprus, Cos, etc., a so-called snake's horn (perhaps that of the *cerastes cornutus*) is used for medico-magical purposes. It must be obtained when two snakes are coupling. Something is thrown over them, whereupon one of them gives up the horn.¹³

(d) *The cornucopia*, 'horn of plenty,' a horn filled to overflowing with fruits, etc., was an emblem of gods of plenty. Thus it was associated with the goddess Fortuna ('Fortuna cum cornu, pomis, ficis, aut frugibus autumnalibus pleno';¹⁴ 'mundanam cornucopiam Fortuna gestans'),¹⁵ and with Copia ('aurea fruges Italix pleno diffudit Copia cornu').¹⁶ But it was also given to the Tria Fata, to Diana, and to the Lares. The Earth-goddess emerging from the earth on Greek vase-paintings has a horn of plenty, from which sometimes rises a child.¹⁷ The *cornucopia*, as the symbol of fruitfulness, could be associated with any god or personage who aided fertility, e.g. Herakles (whose *cornucopia* sometimes contains φάλλοι), or any form of the Agathos Dæmon, e.g. the hero, in the representations of whose ritual feasts it appears, and also the person who represented the Year in processions, the *Eniautos*. Thus, in the Dionysos procession arranged by Ptolemy Philadelphos, *Eniautos* is

¹ ARW vii. [1904] 127 ff., xv. 476; FL xvi. [1905] 146, xvii. [1906] 465; Elworthy, 204, 258 ff.

² Jorio, loc. cit.; Elworthy, 262.

³ J. Capart, *Primitive Art in Egypt*, London, 1905, pp. 175, 194.

⁴ *Atharvaveda*, III. 7. 11; PR² II. 36, 225; ERE III. 442^a, 470^b.

⁵ ARW xv. 480 f.

⁶ See ref. in ARW xv. 481 f.

⁷ FL xviii. [1907] 425.

⁸ O. Wiener, *Pérou et Bolivie*, Paris, 1880, p. 44; M. Weber, *Eth. Notizen über Flores und Celebes*, Leyden, 1890, p. 7; J. Petherick, *Trav. in C. Africa*, London, 1869, II. 10.

⁹ S. W. Baker, *The Albert Nyanza*, London, 1866, p. 589.

¹⁰ M. Merker, *Rechtver. und Sitten der Wadschagga*, Gotha, 1902, p. 28.

¹¹ E. W. Lane, *Modern Egyptians*, London, 1846, II. 80.

¹² R. Ford, *Handbook for Travellers in Spain*³, London, 1855, p. 632.

¹³ FL xi. [1900] 120 f., 321. For a Greek instance of a magical snake-horn, see ERE III. 403^b.

¹⁴ Arnob. vi. 25.

¹⁵ Ann. Marc. xxii. 91.

¹⁶ Hor. *Epist.* I. 12, 28 f.

¹⁷ Farnell, *CGS* III. (Oxford, 1907) 256, pl. xxi b; J. E. Harrison, *Themis*, Cambridge, 1912, p. 167.

said to carry 'the gold horn of Amaltheia.'¹ The *cornucopia* was, in fact, connected (1) with Amaltheia, the goat from whose horn fruits were presented to the infant Zeus, or the nymph possessed of a bull's horn which provided food and drink; and (2) with Achelous, from whose head Herakles had broken it off. Later mythology combined these two myths.² Probably a horn became symbolic of fruitfulness because it belonged to an animal associated with fertility—bull or goat—and perhaps also because it was a drinking vessel not only among primitive but among civilized peoples.³ Gods are mythically represented as drinking from horns, or they or other supernatural beings offer their guests drink from a horn.⁴ But other things besides drink are carried in such horns, e.g. anointing oil,⁵ medicine or fetish stuff (a general practice in Africa, and found in India in Vedic times),⁶ articles used in charms, incantations, etc.⁷ Saxo Grammaticus⁸ relates that the image of the god Svantovit in Rügen held a horn; and from the diminution or non-diminution of wine poured into it by the priest an augury was drawn regarding the scantiness or abundance of the crops. Medicine or healing water is often efficacious only when drunk out of a horn, especially one taken from a living animal.⁹

For all these reasons it was easy for the horn to become a magical property, owned by gods, fairies, etc., which it was desirable for men to obtain. Hence many tales of robberies of drinking-horns from fairyland, which attach themselves to various celebrated horns, e.g. that of Oldenburg. These horns may at one time have been used as archaic vessels in pagan rites, in preference to more recent vessels; and a supernatural origin would later tend to be given to them. The stolen horn is sometimes a source of luck, a veritable *cornucopia*.¹⁰ The *cornucopia* itself, represented on gem amulets, is said to have magic potency.¹¹ But, in whatever ways such rich productive power was assigned to horns, this primarily depended on the fact that such power was first attributed to the animals possessing them, the power often working, however, through their horns. This conception was sometimes mythically represented, as in the case of the stag Eikpyrnir, from whose horns water continually trickles down to feed the rivers of the under world,¹² and the Iranian primal ox Gâyōmarš, from whose horns spring fruits.

A parallel to the horn of Amaltheia is found in a Kafir tale, in which a boy has a wonderful ox which produces food from its right horn when that is struck. The ox tells him to remove its horns for safety, but this power still continues. Horned cattle are cherished possessions of the Kafirs.¹³ In many Cinderella tales the dead mother, transformed to an animal, produces riches or food from her horn.¹⁴ Cf. an American Indian tale in which a sorcerer produces marvels with the aid of a reindeer horn.¹⁵

(e) *Horns as musical instruments*.—The horn was widely used as a wind instrument among primitive as well as more advanced peoples, and from it the trumpet, often shaped like a horn, had its origin.¹⁶ Such horns are blown not only for

¹ Harrison, 186, 311, 365 ff.; Athenæus, v. 198.

² See Apollodorus, II. 7. 5.

³ See, e.g., Omsar, *de Bell. Gall.* vi. 28. 6; and cf. the minnie-horn of the Teutons (Grimm, 69).

⁴ Grimm, 321, 420.

⁵ I S 161. 12, 1 K 139.

⁶ See ERE IV. 767^a.

⁷ Waddell, 488 (Tibet); Thompson, *Sem. Magic*, 32, 34 (Babylonia).

⁸ xiv. 564 ff. (ed. Folkl. Soc., 1893, p. 392 ff.).

⁹ See above, and *New Stat. Account of Scotland*, Edinburgh, 1845, x. 313; W. Gregor, *Notes on the Folklore of the N.E. of Scotland*, London, 1881, p. 46.

¹⁰ Grimm, 372; E. S. Hartland, *Sciences of Fairy Tales*, London, 1891, ch. vi.; MacCulloch, *CF*, London, 1905, p. 220 f.

¹¹ Elworthy, 307, note.

¹² Grimm, 318.

¹³ G. M. Theal, *Kafir Folklore*, 1882, pp. 14, 168.

¹⁴ MacCulloch, *CF*, 220; M. R. Cox, *Cinderella*, London, 1893, *passim*.

¹⁵ E. Petitot, *Trad. Ind. du Canada nord-ouest*, Paris, 1836, p. 73

¹⁶ See *Musio* (primitive).

ordinary but for ritual purposes. But, partly from the powers ascribed to horns in general, partly from the custom of scaring noxious beings by noise, the blowing of horns became a common method of driving off demons, or of producing magical results. It is a common method of frightening away evil spirits in British Guiana.¹ In cases of sickness the Garo blow horns to drive out the demon which is causing it.² Blowing of horns, as well as other forms of noise, is used among many peoples as a method of driving off the monster who is supposed to swallow sun or moon at an eclipse. Among the Jews it is thought that the blowing of the *shôphâr* is effective in scaring evil spirits or Satan.³ It was also through the blowing of rams' horns (*keren*) that the walls of Jericho are said to have fallen down.⁴

Gods are sometimes said to possess horns, e.g. Triton who blows 'his wreathed horn'; and Heimdall, warder of the gods, who possesses a powerful horn, *Giallarhorn*, kept under a sacred tree, and who blows it at the approach of Surtr.⁵

5. Horns in sacrificial and other rites.—Horns are sometimes presented as sacrificial offerings. In Baluchistan ibex or moufflon horns are placed on the shrines of saints as offerings, or to do honour to the saints.⁶ In Ladakh rams' horns are fixed on fruit trees at an eclipse, as a propitiatory offering. Such trees are very fruitful.⁷ Horns of stags were also sometimes offered to Diana, and votive horns were hung on trees.⁸ Where oxen, etc., were sacrificed, their horns were often gilded, and their necks were garlanded. This was the case in Roman sacrifices, and notices in the Edda and other mythical or legendary sources show that it was usual in Teutonic sacrifices.⁹ In later survivals on festal occasions the horns of oxen are gilded, or adorned with gilded apples or with ribbons and flowers; and on the 'cattle-days' of the Pongol festival in India the animals are led about with painted horns.¹⁰

LITERATURE.—F. T. Elworthy, *The Evil Eye*, London, 1895, *Horns of Honour*, do. 1900; I. Scheffelowitz, 'Das Hörnermotiv in den Religionen,' *ARW* xv. [1912] 450 ff. See also the other authorities cited in the article.

J. A. MACCULLOCH.

HOROSCOPE.—See DIVINATION, STARS.

HORROR.—Although, both in its subjective aspect and in its external expression, horror is usually regarded as an extreme form of fear (*q. v.*), there are certain features which almost amount to a difference of kind. It has two forms, which may be called the acute and the diffuse. The latter is felt mainly in regard to the sufferings or disasters of others rather than one's own. The report of an earthquake with great loss of life, a famine, the sinking of a great ship such as the Titanic (1912) with so many of its passengers and crew, any sudden, unforeseen disaster causing wide-spread havoc, excite in the hearers an emotion which is usually called horror. The actual hearing of the cries of pain, the sight of the sufferings or tortures of another, especially of a child, the sight of a mutilation or cruel death, whether by the hands of man or by the resistless forces of Nature, cause a more intense form of the same feeling. Horror is therefore pre-eminently a social emotion; to the individual it is a shock, followed, almost as in cases of physical shock, by prolonged depression and to a certain extent a lowering of the mental and physical tone. It is most marked where the cause of the disaster or suffering is human cruelty, greed, ambition, or even careless-

¹ *FLJ* v. [1887] 320.

² A. Playfair, *The Garos*, London, 1909, p. 91 f.

³ See *ARW* xv. 486.

⁴ *Jos* 6th.

⁵ Grimm, 234, 1361.

⁶ *FL* xii. [1901] 272.

⁷ *VINQ* i. [1891] 33.

⁸ Ovid, *Met.* xii. 266 f.; *Proper.* iii. 2. 19.

⁹ G. Wissowa, *Rel. und Kultus der Römer*², Munich, 1912, p. 416 f.; Grimm, pp. 55, 76, 665, 1303.

¹⁰ Grimm, 50, 665; E. W. Hopkins, p. 450.

ness and thoughtlessness, as the Congo and Putumayo (1912) atrocities, cruelty to children, the 'horrors' of modern war, etc. In these cases there is not only sympathy with the actual sufferers, but also a feeling of outrage done to the human ideal in the sin of the agent. The same feeling stands out strongly in another set of cases, the so-called 'unnatural' crimes—matricide and parricide, incest, sexual perversity, cannibalism; the feeling is that of violence done to the human type, the ideal of humanity which each of us, consciously or unconsciously, carries about with him. Probably the same sort of feeling was at the root of the horror, once universally felt, towards the insane, towards witches and sorcerers, etc. When the ideal of humanity includes saintliness amongst its elements, the same attitude is taken towards atheism, blasphemy, and, to a less extent, towards heresy. A lower form is the instinctive repulsion felt among the uneducated towards human deformities—hunchback, club-foot, dumbness, etc. Thus the diffuse form of horror may be characterized as a humanist emotion, its object being mainly actions, features, traits which outrage or violate the ideal of humanity so far as it is developed in the mind of the individual.

The acute form of horror is more intense, more egoistic, and concerns situations of imminent danger to oneself. The rush of a wild beast of prey, the sudden fall of a support upon which one is standing at a great height, the outbreak of fire from which there is no escape—in these cases the danger, or it may be the certainty, of death is the exciting motive of the emotion; but there must also be the element of suddenness, of surprise; where the issue has been foreseen, emotion follows quite a different course. A special cause of horror of this type is being suddenly brought into the presence of the supernatural. *Horripilatio*, the hair standing on end, has from time immemorial been associated with the sight of the risen dead, the hearing of a supernatural voice, the believed presence of a god, especially an evil god, a devil, demon, hobgoblin, or a human being who has acquired some of their powers, and takes some unnatural shape. Common to all these cases is the real or supposed powerlessness of the individual, whether because of the suddenness of the onset, the conditions of the situation, or the immensity of the force which he has to face—the invulnerability and unlimited power, for example, and unlimited desire to injure, on the part of the evil spirits. The sense of sin, and of the imminence or vastness of the corresponding penalty, or, in more refined natures, the sense of isolation from man or from God which the consciousness of sin brings with it, has, as is well known, stirred up in many souls a sense of horror which has been the motive to religious conversion in some cases, to self-destruction in others. This instance suggests another distinction from fear proper; fear is a shrinking, a relaxing of energy; while horror, as Bell has said (*Anatomy of Expression*⁶, p. 169), 'is full of energy; the body is in the utmost tension, not unnerved (as) by fear.' In fact the expression of horror looks like a spasm of action, an effort so supreme as to throw the mechanism out of gear; sometimes the effort recovers itself, and strenuous resistance to the danger is made; at other times the paralysis extends to a merciful loss of consciousness. In animals, Verworn¹ has shown that the so-called hypnosis or cataleptic state into which frogs, snakes, birds, guinea-pigs, rabbits, and other animals fall, when held down in an unusual position, is mainly a spasm of the muscles, arising from the excessive initial

¹ *Die sogenannte Hypnose der Thiere*, Jena, 1898, p. 65.

effort they exert to recover their upright position, and which they are prevented from renewing by fear and excitement. The 'shamming dead,' which many animals adopt in situations of imminent danger, is probably due to the same cause, and is the analogue in animals of the paralysis of horror in man.

In the expression of horror (cf. art. FEAR), the phenomena may be classified partly as those of shock, and partly as those of fear proper. As Hack Tuke points out (i. 222), in slight fear there is a rapid muscular action preparatory to flight, while other parts of the body are fixed and contracted in what Darwin regarded as the instinctive effort to conceal or diminish their size; but, when fear is more extreme, amounting to terror (and still more to horror), instead of flight there is spasm both of the movement muscles and of those of the breathing; the voice is husky and the general facial expression is that of one struggling for breath. The high shriek, or even squeal, of horror may be referred in the same way to the spasm of muscles under a great effort. The cold sweat, the rising hair, the arrest of the secretions—dryness of mouth, etc.—and the failure of control over many reflex actions may be set down, as in Darwin's second explanation, to the action of shock, with its immediate lowering of the nervous and therefore of the muscular tone; the extreme pallor of the skin—'grey with horror'—may be due in the same way to the paralysis of the dilator muscles of the small blood-vessels. A prolonged period of horror may—there are quite well authenticated cases (see Tuke, ii. 79)—blanch the hair even of a young man in a few hours. The trembling of the body and the perspiration are probably directly due to the same intense and violent effort, so violent as to defeat itself; animals show the same feature in intense fear.

A traveller in India, while sleeping on the verandah of a bungalow, with his European dog beside him, was awakened by the sound of some large animal moving about in the neighbourhood; his dog was making no sign, but, on putting his hand down to touch it, he found it was shivering, and bathed in perspiration; a tiger was found to have visited the village in the night.

The characteristic staring eyes, with widely dilated pupils, and the rapid but shallow breathing—'panting with horror'—have probably a similar origin. Spencer, Bain, Féré, and others regard these phenomena as the result of an association, formed between the expression of actual pain on the one hand and the conditions or accompaniments of pain on the other; but a more likely explanation

is that both pain and the intense emotion of horror involve a violent struggle of the whole system, of which these so-called expressions are secondary results. In neither case can the expression be explained as a useful adaptation to the situation, or as inherited action, ancestrally useful, if now no longer so.

In horror the mental powers are affected similarly with the bodily; the senses are confused or defective, and among others the sensibility to pain seems mercifully lowered, as it is in animals also; a S. American fox, when surprised and 'shamming dead,' will endure without moving the severest blows of the whip, without a sign of life, yet will start up and run the moment its persecutor is out of reach. In the same way, in great disasters, as earthquakes, etc., human beings are unconscious of injuries which normally would cause the most intense pain; in the earthquake of Messina (1908) a woman walked many miles with one eye torn out, of which she was unaware; and in the burning of the Juno several of the men climbed up some iron plates without noticing that the skin of their hands was being flayed off. Here, again, it is probably the concentration of psychic energy on the horrible situation that inhibits impressions, however intense in themselves, from reaching consciousness. There is a spasm of the mind as well as of the muscles: horror blunts the perceptions, paralyzes the judgment and critical faculty, while the will, as Féré has said (p. 197), is blocked as a door is jammed in a too violent effort to open it.

Like physical shock, horror may cause death, when too extreme; and in predisposed natures it may cause insanity, whether of the obsessional or of the depressive, melancholic type. Burton collected a number of instances from the earlier literature; naturally such cases were more familiar in the Middle Ages, when superstition was more wide-spread.

Probably the sympathetic form of horror is more frequent to-day than the egoistic; it certainly is aroused by sights and sounds which a century ago would have left men unmoved; what excites horror in a people might well be taken as a criterion of its degree of civilization.

LITERATURE.—C. Darwin, *Expression of the Emotions*, London, 1872; C. Bell, *Anatomy of Expression*, do. 1872; A. Bain, *Emotions and Will*, do. 1875; D. Hack Tuke, *Influence of the Mind upon the Body*, 2 vols., do. 1884; C. Féré, *Pathology of the Emotions*, Eng. tr., do. 1899; R. Burton, *Anatomy of Melancholy* (ed. Bell, London, 1896), I. 386.

J. L. MCINTYRE.

HORSE.—See ANIMALS, ASVAMEDHA.

HOSPITALITY.

Arabian (D. S. MARGOLIOUTH), p. 797.
 Babylonian.—See 'Semitic.'
 Buddhist (T. W. RHYS DAVIDS), p. 798.
 Celtic (J. L. GERIG), p. 799.
 Chinese (J. DYER BALL), p. 303.
 Christian (G. BONET-MAURY), p. 804.
 Greek and Roman (ST. G. STOCK), p. 808.
 Hindu (A. S. GEDEN), p. 812.

Iranian (LOUIS H. GRAY), p. 812.
 Japanese and Korean (M. REVON), p. 814.
 Jewish.—See 'Semitic.'
 Muslim.—See 'Arabian.'
 Semitic (W. CRUICKSHANK), p. 816.
 Teutonic and Balto-Slavic (O. SCHRADER), p. 818.

HOSPITALITY (Arabian).—The notion suggested by 'hospitality' with the Arabs, as indeed with all other nations (Pindar, *Pyth.* iv. 30), is the bestowal of food; to 'entertain' and to 'give food' are used in the Qur'an (xviii. 76) as synonyms. The usual word for 'hospitality' (*diyāfah*) seems to be connected etymologically with a word *dafaf*, 'crowd of persons sharing a meal'; one that is slightly less common (*qirā*) is thought to be connected with *qaryah*, 'village,' and perhaps is to be explained from the Heb. *qārā*, 'to meet.' Partaking of food makes the guest a temporary member

of the family, and so confers certain rights and duties: when Abraham, immediately on the arrival of the Divine guests, offered them a boiled calf, but found that their hands did not reach to it, he became terrified (Qur'an xi. 73). The partaking of food, therefore, proves that the intentions of the guest are not hostile, while it also lays on the host the duty of protecting the guest as though he were a member of his own family; ordinarily this relationship is established by the partaking of bread and salt (Doughty, *Arabia Deserta*, Cambridge, 1888, i. 228). In the case of an ordinary guest the

relationship so established lasts two days and the intervening night, called by the Arabs three days (*ib.*), supposed to be the period during which the food remains in the body.

The entertainment of guests is thought to have been started by Abraham (Tha'alibī, *Latā'if al-Ma'ārif*, 1867, p. 4). Both ancient and modern descriptions of Arabia usually dwell on the hospitality of the Bedawīn. In early or ostensibly early Arabic poetry the subject is a commonplace; a good collection of verses dealing with it is to be found in the *Hamāsa* (pp. 685-722). The bards boast that in the dead of night their fires attract wayfarers; their dogs welcome these arrivals; without inquiring who they are, or even when the stranger is known to be an enemy, they immediately slaughter a camel and bid the womankind cook it for the stranger's benefit. They clothe him and talk him to sleep; however gentle they may be, they are ferocious in defence of a guest; however ferocious, they will endure anything from one who is partaking of their hospitality. The entertainment of a stranger is a prize which each owner of a tent hurries to secure before the others. Sometimes he is admitted to the family circle, at other times a special tent is erected for him.

The temporary truce which this hospitality involves seems to be an institution which has survived in the desert from remote antiquity, and has helped to render life there possible. Nevertheless, the poets quoted would not boast so loudly of their exercising it, were it exercised by every one; and indeed, where the hospitality involves the harbouring of a hunted man, it is clear that the serious consequences attaching to the act would render many unwilling to perform it. In the Qur'ān (xi. 80), Lot appeals to the people of Sodom not to disgrace him in the matter of his guests; he is apparently ready, if compelled, to yield to *force majeure*. In the biography of the Prophet we find more than one occasion on which such harbouring is refused, or at any rate made dependent on the pleasure of the chieftain.

In spite, therefore, of the fame of Arab hospitality, and the sanctity which is supposed to attach to it, an invitation to a meal would seem to have been a mode of entrapping an enemy common in Arabia as in other Eastern countries. In the legends which explain how the Jews of Medina became clients, this expedient is twice employed (D. S. Margoliouth, *Mohammed and the Rise of Islam*, London, 1907, p. 187). It became a recognized principle of Islāmic statecraft, and as late as 1st March 1811 was employed by Muhammad Ali in dealing with the Mamluks: 'all the principal men of Cairo flocked to the citadel; coffee was then served,' and immediately afterwards a massacre took place (A. A. Paton, *Hist. of the Egypt. Revolution*, London, 1863, ii. 30). Hospitality offered by one chieftain to another is, therefore, apt to be suspected. The Arabic romances not infrequently depict violations of hospitality of another sort. In the *Maqāma* of Ḥarīrī the hero invites a number of guests to a mock wedding, where he treats them to sweetmeats containing a narcotic; when they are unconscious he strips them of everything and makes off. In the *Maqāmas* of Hamadhānī (Beirut, 1889, p. 190) the travellers ask for food at a village; they are refused bread except for a price, but are given milk, which, however, they afterwards discover to have been polluted. The use of poison for disposing of enemies was also common at many periods of the Khalifate. Sometimes the outrage proceeded from the guests: Osman, founder of the Ottoman empire, according to his biographers, got possession of some important fortresses by accepting an

invitation to a wedding-feast, and bringing armed men dressed up as women.

The definition of hospitality in the Qur'ān appears to be 'feeding on a hungry day [*i.e.* a day of famine] an orphan who is also a kinsman, or a poor man who is in need' (xc. 14). The latter act is assigned so high a value that, where the code admits expiation, feeding a certain number of mendicants serves this purpose; the food is to be normal, and the amount specified as a *mudd*.

The value set in the Qur'ān on hospitality has naturally been exaggerated by the Muslim theologians, and in homiletic works some remarkable views are formulated. 'An account will be demanded on the Day of Judgment of all expenditure except of that on the entertainment of guests: God will be ashamed to demand any account thereof' (*Qūt al-Qulūb*, 1310, ii. 182, after Ḥasan al-Baṣrī, † 110 A.H.); 'to refuse an invitation is to disobey God' (*ib.* 187); provided that the place where the hospitality is offered fulfils certain conditions, *e.g.* is not adorned with silk or satin, gold or silver vessels, etc. (*ib.* 190). Sayings attributed to the Prophet are: 'Hospitality is a right'; 'Hospitality for a night may be claimed'; 'Any area or village wherein a Muslim is allowed to pass a night hungry is out of the pale of Islām'; 'Hospitality is three [days]; all above that is charity' (probably meaning 'cannot be demanded as a right,' but ingeniously interpreted by some Sūfis as charity bestowed on the entertainer, who thereby earns heavenly reward [*ib.* 206 f.]).

In spite of such exhortations, the desire to entertain was by no means universal among Muslims, and a whole literature exists in illustration of stinginess; the classical treatise is that by Jāḥiẓ of Baṣra († 255 A.H.; ed. van Vloten, 1900).

The formulæ wherewith guests are greeted, *ahlan wa-sahlan*, *wa-marḥaban*, probably go back to remote antiquity: the last of these words is the 'wide room' of the Psalms (18¹⁹ 31⁸ etc.). The first is said to mean 'you are among your family'; the second is probably a jingle matching the first, but means 'easy.' In modern times the phrases *ānastandā*, 'you have rendered us at home,' and *auḥashtanā*, 'you have rendered us lonely,' are often heard besides. We sometimes hear of gifts given to guests in connexion with the word *nuzl*; but the practice does not appear to have been widespread.

LITERATURE.—To the authorities cited in the article add G. Jacob, *Altarabisches Beduinenleben*², Berlin, 1897, pp. 85-88.

D. S. MARGOLIOUTH.

HOSPITALITY (Buddhist).—This may best be considered under three heads: (1) hospitality of laymen one to the other, (2) hospitality of the laity to members of the religious Orders, and (3) hospitality of the latter to each other.

1. Hospitality among laymen.—In passages in the canonical books dealing with the lower morality and addressed to unconverted laymen we find references to this subject. So in the *Digha* (iii. 190) the ideal wife is said to be hospitable to her husband's family; in *ib.* i. 117 it is stated to be the duty of a good citizen to treat guests with honour and respect; in *Jātaka*, iv. 32 (in the canonical verses), one of the heroes of the tale boasts of the friendly and hospitable reception he always accorded to guests; and in *ib.* v. 388 (again in the canonical verses) it is laid down that his sacrifice is vain who leaves a guest there seated unfed. These injunctions, or expressions of opinion, are not represented as exclusively Buddhist. In the first passage they are put into the mouth of the Buddha, in the others into the mouths of good men not belonging to the Buddhist community. It is evident that the Buddhists adopted current views on the subject, omitting only any reference

to superstitious customs, connected with conceptions of tabu or animistic views.

2. Hospitality of the laity to the religious Orders.—When Buddhism arose, there were quite a number of wandering teachers (*pabbajitā*, 'wanderers') who propagated doctrines as varied as those of the Greek sophists. They belonged to all social grades, though most of them were men of noble birth. It was considered a virtue and a privilege to provide these unorthodox teachers with the few simple necessities of their wandering life—especially lodging, food, and clothing. Many of the 'wanderers' were organized into communities, with such rules as seemed suitable to their founders for the regulation of such bodies of co-religionists. The people supported all alike, though they had their special favourites. The Buddhists adopted this system, and those among the laity who followed them carried out very willingly the current views as to such hospitality to the 'wanderers.' It was enjoined upon them to give to all. Thus, when Siha, a nobleman who had hitherto followed the Jain doctrine, became a Buddhist, it is specially mentioned that the Buddha urged him to continue, as before, his hospitalities to the members of the Jain Order.¹ So in the Edicts of the Buddhist emperor Asoka frequent mention is made of the duty of hospitality to teachers of all the different sects (not only one's own).

3. Hospitality within the Order.—The Buddhist 'wanderers' were accustomed on their journeyings to stay with one another, and a set of rules was drawn up for their guidance when guests of this kind arrived, prescribing the etiquette to be observed both by the incoming *bhikkhus* (the *āgantukā*) and by their hosts. These regulations are of a simple character, such as might be drawn up now under similar circumstances. They are too long to quote, but have been translated in full by the present writer and Oldenberg in vol. iii. of the *Vinaya Texts* (*SBE* xx. [1885]) 273–282.

It should be pointed out that all this is considered to belong to the lower morality of the unconverted; it is taken for granted, and never even referred to in those passages of the books in which the essential doctrines of Buddhism are expounded to the converted. It is really Indian (see HOSPITALITY [Hindu]) rather than Buddhist; though a detailed comparison of the Buddhist doctrine of hospitality with that of other Indian sects would, no doubt, show that the Buddhists laid more stress than the others did on certain details, e.g. on the importance, in such matters, of disregarding, or paying but little attention to, any difference of sectarian opinion.

LITERATURE.—The authorities are quoted in the article.

T. W. RHYS DAVIDS.

HOSPITALITY (Celtic).—I. Gauls.—It has already been noted in art. ETHICS AND MORALITY (Celtic), vol. v. p. 455, that the Gauls manifested a great desire for knowledge of the habits and customs of foreign peoples, and it is in this eagerness for information that we find the source of the hospitality for which they are so often praised. They welcomed the bards not only because they loved to hear them sing of the deeds of heroes, but also because they delighted in the stories of distant nations related by these travellers. They never refused hospitality to a stranger; and, after having done him the honour of their table, they pressed him with endless questions regarding their neighbours; as Cæsar says (*de Bell. Gall.* iv. 5):

'Est enim hoc Gallicæ consuetudinis, uti et viatores etiam invitos consistere cogant et, quid quisque eorum de quaque re audierit aut cognoverit, quaerant, et mercatores in oppidis vulgus circumstant quibusque ex regionibus veniant quasque ibi res cognoverint, pronuntiare cogant.'

Every traveller found a cordial welcome among

¹ *Vinaya Texts*, II. (*SBE* xvii. [1882]) 115.

the Celto-Iberians, because they considered those who were in the company of strangers as beloved by the gods (G. Dottin, *Manuel pour servir à l'étude de l'antiquité celtique*, Paris, 1906, p. 117). It is needless to observe, therefore, that the statement of Diodorus (iv. 19, v. 24), that the Celts were accustomed to put strangers to death, is merely a fiction.

2. Irish.—The Irish terminology for the relations of hospitality is as follows:

dige, gen. *diged*, 'guest'; *oeged-chaira*, 'guest-friendship,' 'hospitality' (Windisch, *Die altir. Heldensage, Tain Bó Cúailnge*, Leipzig, 1905, line 1837); *taige díged*, 'guest-house' (*ib.* p. liii); *bruiden*, 'guest-house, a palace with seven doors' (*ib.* line 2625), cognate with Goth. *baúrd*, 'board' (*Acallamh na Senórach*, ed. Windisch, *Irische Texte*, iv. 1, Leipzig, 1900, p. 89, line 1878; p. 77, line 2731); *digedechta*, 'guesting,' 'hospitality' (*ib.* p. 1, line 12); *brugaid*, 'host' (Windisch, *ib.* [1880] 406); *enech-oir ainech-ruice*, 'face-blush' (Stokes and O'Donovan, *Cormac's Glossary*, Calcutta, 1863, p. 66); *bruighfer* (lit. 'land-man'), 'public hospitaller,' etc.

In Ireland, hospitality was not only practised as a virtue, but enjoined by law from the earliest times, and references to this subject are equally numerous in religious and in secular literature. In the account of the second battle of Moyrath, we find the following statement concerning Ireland in the reign of King Domhnall: 'Her habitations were hospitable, spacious, and open for company and entertainment, to remove the hunger and gloom of guests' (J. O'Donovan, 'The Battle of Magh Rath,' *Irish Archæol. Soc.*, Dublin, 1842, p. 105). Bede (*HE* iii. 27), in writing of the plague of 664, states that many English, both of the nobility and of the lower ranks, had repaired to Ireland at that time either for the sake of study or of continence. The Irish, continues the historian, 'willingly received them all, and took care to supply them with food, as also to furnish them with books to read, and their teaching, all without any charge.'

From what is contained in the *Ancient Laws of Ireland* (London, 1869–73, iv. 237) as well as in the saga, we may conclude that from the very earliest times a king or a chieftain was obliged to entertain any passing stranger or any other person who might seek his hospitality without asking any questions regarding himself or the purpose of his visit. One who neglected to discharge these duties incurred without fail the hostility of his people. For example, in the account of the second battle of Moytura, the people, we are told, complained bitterly of the poor hospitality of King Bres:

'The knives of his people were not greased at his table, nor did their breath smell of ale at the banquet. Neither their poets, nor their bards, nor their satirists, nor their harpers, nor their pipers, nor their trumpeters, nor their jugglers, nor their buffoons, were ever seen engaged in amusing them in the assembly at his court' (P. W. Joyce, *Soc. Hist. of Anc. Ireland*, London, 1903, i. 58).

The poet Coirpré, son of Etan, once presented himself at the castle of this king seeking hospitality. 'He was shown into a small, dark, sombre house where there was neither fire nor furniture nor bed. He was given three small dry rolls of bread on a little plate. Arising the next morning, he was not grateful.' Then Coirpré pronounced against Bres the first magic malediction ever composed in Ireland, and the outcome of all this was that Bres was driven from the throne (H. d'Arbois de Jubainville, *Cours de littérature celtique*, Paris, 1883–1902, v. 414).

Probably the most unique account of hospitality among the Celts is that of Gúaire, king of Connaught, in the 7th cent., who was so constantly giving away that his right hand grew longer than his left.

When Senchán Torpeist became chief of the *file* in Ireland, after the death of Eochaid Dallan Forgall in 658, he sought hospitality of Gúaire, accompanied by a retinue of 150 *file*, or poets, 'as many pupils, as many valets, as many women,' and others besides. Though Gúaire had a building purposely constructed for the reception of Senchán and his companions, he was not prepared for such a multitude. The women especially were most exacting in their demands; 'at first the widow and the daughter of Eochaid Dallan, then the wife of Senchán, and, finally, Senchán himself exceeded all the bounds of hospitality.'

The first maintained that she would die unless she obtained a bowl of beer made with milk, and in addition to this she demanded the marrow from the ankle of a wild boar. Between Christmas and Epiphany, she wished to have beside her, on a yew tree, a small freshly hatched cuckoo. As a belt it was necessary to supply her with a strip of bacon taken from a perfectly white pig. The only kind of mount with which she could be satisfied was a horse with purple mane and white legs. Her dress must be a spider's web of many colours. Marbán, the brother and swineherd of Gúaire, was able to secure for her all that she had asked, and to satisfy the equally exacting requests of the two other women.

But Senchán was a still more embarrassing guest than they. He declared that he would die unless Gúaire could regale him and his retinue, and also the nobility of Connaught, with an ample repast, consisting of the bacon of pigs not born of sows and of beer produced from a single grain of barley. In case of refusal Gúaire was threatened with an incantation. Marbán again came to his rescue. He possessed nine pigs from a sow which was killed by a wolf before they were born; and eleven years previous to this date, he had sown a grain of barley which gave him an ear the following year. The grains of this ear produced seventeen ears the next year, and so on until the end of the eleventh year, when he reaped seven large piles of barley, all coming from the original grain. Consequently Gúaire was able to satisfy the demands of Senchán.

The latter, however, not expecting to be gratified, was displeased, and refused to eat. Gúaire, though irritated by the behaviour of his guest, sent a servant to Senchán bearing a goose prepared expressly for him. Senchán refused to accept the gift, and addressed the servant as follows: 'I knew your grandfather, who had round and ill-kempt nails. Consequently, I will receive nothing from your hands.' A young girl was then dispatched by Gúaire to prepare, in the presence of Senchán, a mixture of flour and salmon eggs, which was then offered to the poet. But he again refused, saying to her: 'I knew your grandmother. One day, from the top of a rock, she showed the way to some passing lepers. Consequently, I can receive nothing from your hands.'

Gúaire lodged and fed these incommensurable guests for a year, a season, and a month, but finally he lost his patience. Marbán recalled to his brother that, though Senchán and his companions had the right to be lodged and fed, they were obliged in return to make music and relate stories. He therefore asked of Gúaire permission to order them to recite the *Táin*, or the *Cattle Raid of Cooley*, from beginning to end. Senchán was unable to comply with his command and asked his companions for help, but of this vast epic they only knew *blaga*, or selections. Then Marbán, by an incantation, forbade them from passing two nights in succession in the same house as long as they had not found the complete text of this famous story. They were obliged then to set forth in search of the epic (*Book of Leinster*, 245; *Transactions of the Ossianic Society*, Dublin, 1854-61, v. 102-105; d'Arbois de Jubainville, vi. 140-143).

Further instances of the hospitality of the early Irish are the following:

First, in the *Feast of Bricriu* it is stated that Conchobar, king of Ulster, established the law that each chieftain should feast the Ulstermen one night in the year. The wife of the hero who did the entertaining was obliged to furnish the wives of the Ulstermen with seven oxen, seven pigs, seven casks, seven barrels, seven mugs, seven pots, seven cups, and seven glasses of beer, seven services of fish, birds, and vegetables (d'Arbois de Jubainville, v. 150). While the three heroes, Conall, Lógaire, and Cúchulainn, are making their long expedition, they are received on all sides with marked attention. In one place a repast sufficient for one hundred persons is served to them, and they are permitted to have their choice of the daughters of the king (*ib.* 161). When they reach the house of Curol, they learn that his wife has received orders from her absent husband to grant them the hospitality of his home. Hence, she prepares for them a bath, intoxicating drinks, and superb beds (*ib.* 136).

In the story of the *Birth and Reign of Conchobar*, we are told that each Ulsterman gave him hospitality for one night, and allowed him to pass it with his wife—a right that this despotic king pretended to exercise ever afterwards (*ib.* 7 f.). In the *Murder of Conchobar*, it is stated that the kings of Munster, Leinster, etc., permitted the poet Aitherné to pass the night with their wives during his sojourn in their countries, for fear of the protection of the Ulstermen which had been granted to him (*ib.* 366 f.).

The regular period for which a guest could claim hospitality was three days and three nights, after which the host could refuse to continue to entertain his guest, if he so wished (cf. *Acallamh na Senórach*, in Windisch, iv. 1, lines 436, 1601, 1823, 2797, 3531, 7352, 7652; *RCel* ix. [1888] 495, note 3). Mael Duin and his fellow-pilgrims are received everywhere with the greatest cordiality, but, at the end of three nights and three days, their host or hostess usually vanishes (d'Arbois de Jubainville, v. 474, 479 f.). The attentions shown them in the 'Island of the Queen and her seventeen daughters' rival those of Gúaire given above (*ib.* 486 ff.). If the lord thought his reception unworthy of his guests

because of his being taken unawares, he usually attempted to atone for his inhospitality during the course of the following days. When Mac Dáthó was surprised by the heroes of Ulster and of Connaught and their retinues, he killed his immense hog, the wonder of his kingdom, in honour of his guests. Fearing that they might still be displeased with their reception, he apologized for his lack of preparations, saying: 'If anything is lacking to-day, I will kill it to-morrow' ('*Scél mucci Mic Dáthó*,' in Windisch, i. 98).

In historical times we find the same esteem for hospitality as in the more legendary periods. Of Owen O'Madden, a Connaught chief, it is stated in the *Tribes and Customs of Hy-many* (ed. O'Donovan, *Irish Archæol. Soc.* v. [1843] 141) that 'he does not refuse any one gold or horses, food or kine, and he is the wealthiest of the race of Gaedhal for bestowing them'; while St. Patrick, in blessing the district of Moy Rein, is reported to have said: 'I leave prosperity to the place so that it shall provide for all [requiring help] even though every cleric should be poor,' which is interpreted by Hennessy to mean that, if the clergy were too poor, the laity should be rich enough to provide for all (Hennessy and Kelly, *The Book of Fenagh*, Dublin, 1875, p. 273).

Among the different classes of society, we find first that the king was expected to keep his house always open to visitors.

'A prince,' says Cormac Mac Art, 'should light his lamps on Samhain Day [the celebration of the beginning of winter on 1 Nov.] and welcome his guests with clapping of hands and comfortable seats, and the cup-bearers should be active in distributing meat and drink' (Joyce, i. 58).

Once a guest had partaken of food in a house, whether of king or of subject, the host was not allowed thereafter to offer him violence or even to show him disrespect.

In A.D. 598, Branduff, king of Leinster, offended at the licentious conduct of Prince Cummascach, set fire to the building in which the latter and his suite were feasting. Glasdám, the prince's jester, who had been entertained a few days before as a guest by the king, exclaimed: 'Lo, I have eaten thy meat! Let not this deed of shame be now wrought on me!' To this Branduff answered: 'By no means shall this be done! Climb up to the ridge-pole and leap out over the flames to the ground. We will let thee pass, and thus shalt thou escape!' But the jester refused to be saved without his master, and gave his mantle and cap to the prince, who escaped from the burning building (S. H. O'Grady, *Silva Gadelica*, London, 1892, ii. xxviii; Joyce, ii. 483).

During the time that the guest was under the roof of his host, the latter was bound by law to protect him. A gloss on the *Ancient Laws* explains the words *t'aurgaire*, 'thy defence,' by the statement that no one—not even an officer of the law—should be allowed to enter one's house and lay hold of his guest (*i.e.* for debts or crime) before the end of the third night. In such an event the host could lay claim to damages against those who had violated the privacy of his home (d'Arbois de Jubainville, 'Introduction et commentaire du Senchus-Mór,' in *Cours de litt. celt.* viii. 145).

When the king or his subject found himself unable to discharge the duties of a host, he suffered the 'blush of honourable shame' or 'face-blush' (*enech-ruice*). In order to 'break or prevent the face-blush' of a king, the *Ancient Laws* (iv. 311) say that the *bruighfer*, or 'public hospitaller,' had the 'snout of a rooting hog'—in other words, he had plenty. If, however, the king or his subject should lack the necessary provisions at the arrival of his guests, through default of another, the defaulter was obliged to pay him the compensation known as the 'blush-fine' (*Ancient Laws of Ireland*, i. 123. 11; 129, note 1; iv. 345, 347, 13; *Cormac's Glossary*, 103, s.v. 'Leos').

Though, according to the *Ancient Laws* (iv. 237), chieftains were held 'bound to entertain without asking any questions,' the *feine*, or farmers, it seems, were given permission to make suitable

inquiries of their guests, in order, without doubt, to afford them better protection in case of necessity (Joyce, ii. 168). As the *Ancient Laws* (iv. 337) specify cases wherein a king might be excused for deficiency of provisions if the number of guests should exceed expectation, it is obvious that a subject was not expected to exceed the limits of his means in order to provide for a number of guests.

As stated above, there was a 'public hospitaller' (*bruighfer, brugaid, briuga*), who had, as a gift from the king, to assist him in fulfilling the functions of his charge, appanage lands of various kinds. He seems to have had, for example, the temporary usufruct of escheated lands, and of such lands as fell into the public domain through failure of heirs, or pending the decision of the courts as to the rightful succession to them. In return for these immunities and lands, he was bound to maintain his establishment in a proper condition. His was a position of high honour, and all who laid claim to his hospitality were bound to show him due respect. Though his revenues came principally from the land, he had other allowances. The extent of his house and premises, the character of the furniture, and the amount of supplies of provisions he was bound to have always in store are minutely given in the *Crith Gablach*, a MS published by E. O'Curry (*Manners and Customs of the Anc. Irish*, London, 1873, ii., App. p. 485). He was specially protected by law from trespass and from wanton or malicious damage to his furniture or premises. In the tract mentioned above, the fines for such trespasses and damages are set down with great minuteness. These fines were heavy, and were evidently intended to restrain within the limits of order and decorum those who were entitled to hospitality (O'Curry, i. p. cclxix). Among the privileges extended to the *brugaid* or *bruighfer* was that of brewing, for his house should never be found lacking the ale necessary for the refreshment of a king, bishop, poet, judge, or other person, and their respective suites entitled to such entertainment (*ib.* p. cclxxxvi). He was also the only man under the rank of a *flaith* ('ruler, prince') entitled to the privilege of having his house over a spring of water.

There were two classes of *bruguids*. According to Stokes (*RCel* xv. [1894] 431), the inferior and more common grade was that of the *brugaid cedach*, or 'hundred hospitaller,' who was required to have one hundred of each kind of cattle, one hundred labourers, and corresponding provision for feeding and lodging guests. The higher and more exceptional grade was that of the *brugaid lethech*, or 'hospitaller of the kneading trough' (*lethech* = 'kneading trough'), who was not only obliged to have two hundred of each kind of cattle, but who had to supply his house with all the necessary furniture and utensils, including one hundred beds for guests. The *Ancient Laws* (i. 47) deny the *brugaid* the right to borrow, stating, on the contrary (iv. 311), that he is 'a man of three snouts, the snout of a live hog rooting in the fields to break the blushes of his face, the snout of a dead hog cooking on the hooks, and the pointed snout of a plough'; i.e., he should have plenty of live animals, meat cooked and uncooked—usually of three kinds—and a plough, with all other tilling appliances. He is also called the man of three sacks; i.e., his house was always to be provided with a sack of malt for brewing ale, a sack of salt for curing cattle-joints, and a sack of *guail*, or charcoal, 'for forging the irons,' in case of accident to the horses or vehicles of travellers (O'Curry, i. p. cclxii). The *Ancient Laws* (iv. 310 f.) prescribe, further, that his kitchen fire should never be permitted to go out, and that his cauldron should always remain on the fire, full

of joints boiling for any guest who might chance to arrive.

In addition to the foregoing, the *Brehon Laws* (v. 17. 7, 79. 22) provide that a number of open roads should lead to the *brugaid's* hostel, so that it might be within access of all; and a man should be stationed at each road to allow no traveller to pass without seeking the hospitality of the *brugaid*. From the account of the destruction of Da Derga's hostel, we are able to ascertain that at night a light was kept burning on the lawn (*faithche*), to serve as a guide to travellers. In fact, Da Derga never closed any of the doors of his house, day or night, with the exception of those to the windward side (Stokes, 'Togail Bruden Da Derga,' in *RCel* xxii. [1901]).

According to Keating (*History of Ireland*, tr. O'Mahony, London, 1866; see Joyce, ii. 170), there were 90 *bruguids* in Connaught, 90 in Ulster, 93 in Leinster, and 130 in Munster. Though these figures are far from being accurate, they indicate how very numerous these houses of hospitality were.

There were a few *bruguids* of a still higher class than those already mentioned, who, it seems, entertained kings, chiefs, and their retinues, and were on very intimate terms with them. With the exception of this fact, their duties were in every way similar to those of the other two classes.

With the creation of the position of *brugaid* arose the necessity of public hostels of which he might be placed in charge. These hostels were called *brudin* or *bruden*—meaning houses of public or State-endowed hospitality. According to the Story of the Pig of Mac Dáthó ('Scél mucci Mic Dáthó,' in Windisch, i. 96), there were in the Red Branch period, about the beginning of the Christian era, six of these royal hostels in Ireland: 'the hostel of Da Derga in the province of Cualann, and the hostel of Forgaill Manach [father-in-law of Cúchulainn] which was located at Lusca [now Lusk, to the north of Dublin], and the hostel of Mic Dareo in Brefney, and the hostel of Da Choca in West Meath, and the hostel of Blai the farmer (*briuga*) in Ulster,' as well as that of Mac Dáthó, who was king of Leinster. In regard to the hostel of Mac Dáthó, it is said that 'there were seven doors in the hostel, and seven ways through it, and seven hearths in it, and seven cauldrons, and an ox and a salted pig in each cauldron. The man who came into the house thrust his fork into the cauldron, and what he obtained at the first thrust, that he ate. If, however, he did not obtain anything at the first thrust, he did not make another' (cf. also Stokes, 'Togail Bruden Da Choca,' in *RCel* xxi. [1900] 397).

The *bruden* of Da Derga was the most important of these hostels. The account of the destruction (*togail*) of it was published by Stokes in *RCel* xxii. [1901], and it relates how Conari I., king of Ireland, and his retinue, who were staying there at the time, were destroyed by a band of Irish and British marauders in the 1st cent. A.D. This hostel was situated on the river Dodder, where excavations were made and remains were discovered by Frazer (*Proc. Roy. Ir. Acad.*, 1879-86, p. 29). The *bruden* of Da Choca, in the destruction of which Cormac Conlingeas, son of Conchobar, king of Ulster, perished, was the next in importance, and was, as stated above, situated in West Meath, a few miles from Athlone. The account of its destruction contains the statement also that 'every *bruden* is an asylum of the red hand,' i.e. for all criminals guilty of murder (*RCel* xxi. 315).

There was still another kind of public hospitaller, called the *biatach* or *biadhach*, though the difference between him and the *brugaid* is not very clear. The Book of the Dun Cow (*Leabhar na hUidhre*, p. 123, line 4 f. from bottom) mentions them together, apparently making no distinction whatever between them. The *biatach* was obliged

to entertain travellers and the chief's soldiers whenever they sought his hospitality. In order to enable him to discharge his functions, he was granted a tract of arable land called the *baile-biadhtaigh*, which was equivalent to about 1000 English acres. Besides this, he was entitled to a much larger amount of waste land.

According to Cormac's *Glossary* (p. 130), there were several female *bruguids* during the time of Finn who entertained chieftains and warriors on their hunting expeditions.

In addition to these, we find in Christian times that every monastery contained a *tech-óiged*, or guest-house, for the reception of travellers. These houses, which were constructed at some distance from the monks' cells, dated from the time of St. Patrick (Joyce, i. 330). According to the *Lives of the Saints* (Stokes, *Lives of the Saints from the Book of Lismore*, Oxford, 1890), it was enjoined upon some of the inmates to receive the stranger, take off his shoes, wash his feet in warm water, and prepare supper and bed for him. This was done in accordance with the *Ancient Laws* (v. 121. 27), which state that 'hospitality is incumbent on every servant of the Church.'

An old Irish sermon on Doomsday contains the following: 'The Lord will say to the just, "I was in need of a guest-house (*tech-aiged*), and ye gave me hospitality"' (Stokes, 'Tidings of Doomsday: a Sermon on Doomsday from the Leabar na hUidhre,' in *RCel* iv. [1879-80]). Once, when St. Columba expected a guest at Iona, he told the brethren to prepare the *hospitium*, or guest-house, and to have water ready to wash the stranger's feet (Reeves, *Adamnan's Life of St. Columba*, Dublin, 1857, p. 27). When St. Ciaran of Clonmacnoise arrived at Saigir (now Seirkieran in King's County), to visit the other Ciaran, abbot of Saigir, the latter, learning that the fire had unexpectedly gone out, said to him with a tone of apology: 'The first thing that ye [the saint and his followers] need is water to wash your feet, but just now we have no means of heating water for you' (Stokes, *Lives of the Saints*, 277). Mac Conglinne, displeased at the poor reception accorded him in the monastery at Cork, complains that on his arrival no one came to the guest-house to wash his feet, so that he was obliged to wash them himself (Meyer and Hennessy, *The Vision of Mac Conglinne*, London, 1892, p. 10). As in secular life, so in monastic life there was no obligation to entertain guests after the third day.

Guest-houses with men-servants (*timthirig*) in charge were also established in the most important nunneries of the country. In the *Féilire*, or Calendar, of Oengus the Culdee (*Trans. Roy. Ir. Acad.*, 1880, p. 72f.), it is related that a chief named Coiríre or Carbery arrived at St. Brigit's Convent in Kildare with a child in his arms, and was conducted to the guest-house. Guest-houses are also found attached to the houses of chiefs and even of persons not so high in the social scale who might be able to bear the expense. They consisted usually of one large apartment, which was always kept prepared for the reception of travellers, and which was in charge of a handmaid who washed the guests' feet (*ib.* 48).

If a monastery was situated on the banks of a river where there was no bridge, the monks usually had a *curragh* ready to ferry any traveller across free of charge (Healy, *Insula Sanctorum et Doctorum: Ireland's Ancient Schools and Scholars*, Dublin, 1890, p. 427). Irish missionaries on the Continent established *hospitalia* for the use of pilgrims on the way to Rome, some of which were in Germany, although they were mostly in France (cf. *Cambrensis Eversus*, ed. for the Celtic Society by M. Kelly, Dublin, 1850, ii. 244 f.).

The public hostels began to diminish in number at the time of the Anglo-Norman invasion, and finally they disappeared altogether. After this the monasteries and some of the wealthier chiefs continued to keep up the custom for some time, but Henry VIII. finally ordered the suppression of all monasteries, and the last vestige of this custom disappeared with them. In 1539, Lord Leonard Gray, the Irish lord deputy, and the Dublin council petitioned the king in vain to exempt six

monasteries from the order, and among their reasons they cite the following:

'For in those houses comenly, and other such like, in default of comen innes, which are not in this land, the Kinge's Deputie, and all other his Grace's Counsaell and Officers, also Irishmen, and others resorting to the Kinge's Deputie in ther quarters, is and hath bene most comenlie lodged at the costes of the said houses. . . . Also at every hosting, rode, and jorney, the said houses in ther [own] propre costes fyndethe [entertainment for] as many men of warr, as they are apoynted by the Kinge's Deputie and Counsaell for the same' (*State Papers, Henry VIII.*, Ireland, iii. 130; see also *Register of All Hallows*, xxv., and Joyce, i. 333).

3. Welsh.—Among the Welsh the same admiration for hospitality and liberality was shown as among the Irish. The house of the Cymro was always open to the traveller. When he came within a district and presented himself at a house, he first delivered up his arms, which signified that he placed himself under the *nawd* (peace) of the *penteuulu* (head of the household). If he expressed the desire of seeking a lodging, for the first two nights he was treated as a guest of the householder with whom he stayed, but on the third night he was deemed an *agenhine*, or member of the man's household, for whom such man was answerable (Hubert Lewis, *The Ancient Laws of Wales*, ed. J. E. Lloyd, London, 1889, p. 281). The guest's way of manifesting his intention of staying overnight was to allow his feet to be washed. But, if he refused the proffered service, it was apparent that he desired only morning refreshments, and not lodging for the night.

'The young men,' says Giraldus Cambrensis (*Opera*, ed. J. F. Dimock, London, 1861-91, i. 10, p. 182f.), 'move about in troops and families under the direction of a chosen leader. Attached only to arms and ease, and ever ready to stand forth in defence of their country, they have free admittance into every house as if it were their own.'

As each house had its young women and its harps allotted to the purpose of entertaining visitors, those who arrived early in the day were entertained either with conversation or music until evening, when the principal meal of the day was served. Though, as Giraldus says (*Descrip. Kambrie*, i. 10, p. 182f.; cf. ETHICS AND MORALITY [Celtic], vol. v. p. 463), this varied according to the number and dignity of the persons assembled and the degrees of wealth of different households, it was almost always a simple repast, for 'the kitchen does not supply many dishes nor high-seasoned incitements to eating.'

The houses of the Welsh were not furnished with tables, cloths, or napkins. The guests were seated in messes of three, instead of couples as elsewhere. All the dishes were at once set before them in large platters on rushes or grass spread on the floor (*ib.*), and the food consisted of milk, cheese, butter, and plainly-cooked meat (Rhys and Brynmor-Jones, *The Welsh People*, London, 1900, p. 250 f.). The bread that they served was a thin and broad cake fresh baked every day, which, Giraldus says (*loc. cit.*), was called *lagana* in the old writings, but which was probably very much the same as the 'griddle-bread' or 'bake-stone bread'—*bara llech* or *bara plane*—of modern times (Rhys and Brynmor-Jones, *loc. cit.*; T. Wright, *The Hist. Works of Giraldus Cambrensis*, London, 1863, p. 493, note 2). To this was usually added broth with chopped-up meat. 'Such a repast,' adds Giraldus, 'was formerly used by the noble youth from whom this nation boasts its descent, and whose manners it still partly imitates.' The family waited on the guests, the host and hostess standing up and taking no food until the needs of their visitors were satisfied. The evening was then passed by the guests in listening to the songs or recitations of the bard of the household, or of minstrels who in their wandering had joined the company. Often all united in choral singing (Rhys and Brynmor-Jones, *loc. cit.*). A bed made of rushes, and covered with a coarse

kind of cloth manufactured in the country, called *brychan*, was then placed along the side of the hall, and the family and guests lay down to sleep in common (Giraldus, *loc. cit.*). The fire on the hearth in the centre of this hall continued to burn all night, and the people were so arranged that it was at their feet.

'But when the under side begins to be tired with the hardness of the bed,' adds Giraldus (*loc. cit.*), 'or the upper one to suffer from the cold, they immediately leap up and go to the fire, which soon relieves them from both inconveniences; and then, returning to their couch, they alternately expose their sides to the cold and to the hardness of the bed.'

Until the end of the third night the host and the people of the house were responsible for the safety of the guest. According to the *Ancient Laws of Wales*, one of the cases where guardians are appropriate is to guard lawful guests (*Dimetian Code*, III. v. p. 300; *Gwentian Code*, II. xxxviii. p. 377; *Anomalous Welsh Laws*, xiv. p. 714, in Aneurin Owen, *Ancient Laws and Institutes of Wales*, London, 1841). If during the period of his visit recognized by law—i.e. before the end of three days—the guest was accused of theft, the testimony of his host could clear him only of theft committed by night (*Anomalous Laws*, xiv. p. 739, § 2); and, if the host failed to clear his guest, he himself was obliged to pay three pounds to his lord and to surrender his property to the complainant, i.e. sufficient, no doubt, to relieve his guest of the punishment he might suffer (*ib.*; also ch. xii. p. 705; and ch. xv. p. 709).

'There are three privileged progressive visits,' say the *Triads of Dyonwal Moelmuad* (W. Probert, *The Ancient Laws of Cambria*, London, 1823, p. 9, no. 24), 'guaranteed by the honour of the tribe of the Cambrians, and no person must presume to hinder them: the visit of an ambassador from a bordering kingdom; the visit of bards from the bordering kingdom in the convention, according to the privilege and institute of the bards of the Isle of Britain; and the visit of foreigners in the peace and protection of God and His tranquillity.'

To illustrate further the attitude of the Welsh towards hospitality, it is stated elsewhere in the same work (§ 12) that 'there are three progressions that, wherever they go, are entitled to their support and maintenance: those who have the privilege of distinction; those who have the privilege of bards; and those who have the privilege of orphans.' Among the 'three progressions that require assistance' are 'bards in their circuit of minstrelsy and foreigners under the protection of the tribe of Cambrians.' Finally, the 'three renowned progressions' are the chief of the tribe and his retinue, bards and their disciples, and a judge with the retainers of his court. 'Wherever they are,' continue the *Triads*, 'they are entitled to their liberty and free maintenance' (*ib.* § 80).

This goes to show how greatly a violation of the laws of hospitality was condemned among the Welsh; and we are not surprised, therefore, to discover that severe punishments were meted out to the guilty. If it happened, for example, that a guest was seen to arrive and enter a house in good health, and in the morning was found dead, and the host and his family had raised no alarm and exhibited no marks of wounds received in his defence, the host and his family could not escape capital punishment, 'unless perhaps they were liberated *per patriam*, if the King's justices should deem that the truth could be ascertained *per patriam*' (Lewis, *op. cit.* 379). It was on this account that laws were made about receiving and parting with guests by daylight. If, on the contrary, the master of the house was found dead in the morning, and his servant or a stranger had passed the night in it, such stranger or servant could scarcely escape danger by the inquisition of the country because of the grave suspicion. 'But if the *patria* could not say the truth as to such *secret* deed, the man was sufficiently acquitted by their not finding him guilty' (*ib.*).

The *Ancient Laws* provide further (*Anomalous Laws*, iv. iv. 402, § 14, ed. Aneurin Owen) that, 'if a person come as an inmate to another person, having an animal or other property with him, when he departs, he is not to take with him the offspring, or dung, or crop, or any piece of furniture; nor anything but what he brought with him to the house, if it remain, unless an agreement assign it to him; as to which it is said: an agreement is stronger than justice.'

As in Ireland, no stranger was to remain beyond three days without 'commendation,' i.e. without being commended to some lord, who should take him under his protection, and answer for him, or without being admitted to some *borh*, or fellowship of mutual responsibility (*Leges Hen. I.*, cviii. in Lewis, 281). In Ireland this was called 'binding the lord's protection,' and was necessary to every stranger to safeguard him through a country (J. Strachan, *Stories from the Tain*, Dublin, 1908, p. 4). Cúchulainn not only accepts the protection of King Conchobar of Ulster on his first visit to Emain Macha, but even requires the Ulstermen to accept protection from himself (*ib.*).

Of the king's guest the *Venedotian Code* (I. ix. 10, § 18, ed. Aneurin Owen) states that he is one of the six persons to be served with food and liquor by the royal steward. The other five who are the recipients of this honour are the king himself, his *henaw*, his *edeling*, his chief falconer, and his foot-holder. And, finally, one of the four persons for whom there is no protection against the king is 'a person to whom the king is a supper guest, who ought to supply him with food that night, and who does not supply him' (*Dimetian Code*, II. viii. p. 214, ed. Aneurin Owen).

LITERATURE.—This is sufficiently indicated in the article.

JOHN LAWRENCE GERIG.

HOSPITALITY (Chinese).—The Chinese are a hospitable people; they enjoy social intercourse; they love to chat together. Notwithstanding the hard struggle for existence which many of them have to carry on, they enjoy life to the full, and extract well-nigh all the pleasure which can be got out of it. One of the first sentences in the Confucian *Analects*¹ runs thus: 'How pleasant it is to have friends come from a distance!' The commentators amplify the wording of this so that it reads: 'How pleasant to have friends come to you from a distance, attracted by your learning!' There is no doubt that the context gives them reason to paraphrase the passage in this way. At the same time, although the attractive power that draws the friends together is learning, it opens the way to hospitality. This is not the only instance in the Classics; others are even more to the point, and in them we find hospitality enjoined as a duty. Now, these Classics are the standard which the Chinese have applied to their conduct, and they contain, according to them, the principles which are to guide them in all affairs.

It might be thought that the etiquette of this Eastern people, with its stiff formality, like a coat-of-mail, would so hamper intercourse that it would act as a kill-joy on all attempts at the offering of hospitality; but under the rigid forms of outward ceremonial there beats a human heart warm with all the elements that foster the exhibition of it. A good corrective to formality of intercourse, lest it should dull the edge of hospitality, is found in a saying of the philosopher Tsang, one of the principal disciples of Confucius: 'I daily examine myself . . . whether in intercourse with friends I may not have been sincere.'² Another disciple of the Sage also gives utterance to much the same idea when he states it as one of the leading principles in the conduct of a man to whom the term 'learned' might be applied: 'If, in his intercourse with his friends, his words are sincere.'³ We thus see that these followers of the Master were carrying out the principles he laid down of 'Hold faithfulness and sincerity as first principles.'⁴

In the compilation of memorials known as 'The Book of History,' extending over about 1700 years from the most ancient times before the day of Confucius, we have, in the portion known as 'The

¹ Bk. I. ch. II.

² *ib.* bk. I. ch. VII.

³ *ib.* bk. I. ch. IV.

⁴ *ib.* bk. I. ch. VIII. ver. 2.

Great Plan' (2205-2198 B.C.), one of the oldest parts of this ancient work, 'the entertainment of guests'¹ laid down as one of the eight objects of government. This would seem to include in its purview 'all festive ceremonies, all the intercourses of society.' In an agreement entered into by an assembly of princes in 650 B.C., one of the injunctions was: 'Be not forgetful of strangers and travellers.'² This was taken to include officers from other countries. 'The Doctrine of the Mean'—one of the Chinese Classics—in a description of the duties of a ruler of a country, says that 'by indulgent treatment of men from a distance they are brought to resort to him from all quarters.'³ The commentators differ as to the meaning of 'men from a distance.' One thinks it includes 'guests or envoys and travellers, or travelling merchants.' The learned translator of the 'Chinese Classics' (J. Legge) doubts whether any others but travelling merchants are intended by it. Another commentator would apply it to 'the princes of surrounding kingdoms.'

Confucius considered that the study of 'The Book of Poetry' taught the art of sociability. This book is a collection of 305 pieces selected by Confucius from more than 3000. They may almost be described as folk-songs, thus collected thousands of years before the vogue for such things in the West. These short poems represent the life of the Chinese some 3000 years ago. Some of them were sung at festive gatherings. In one 'admirable guests' are spoken of.⁴ Merry gatherings they seem to have been, for in one we read: 'As we feast, we laugh and talk.'⁵ In another we have a general returning from all his toils and feasting happily with his friends on roast turtle and minced carp.⁶ Another is descriptive of a feast given by a king.⁷ The hospitality thus sung in these songs seems to have been appreciated to the full.⁸

The clan system brings in its train, among its good features, the development of hospitality on a far more liberal scale than might be expected. Should a European, in adopting a Chinese surname for his cognomen while among the inhabitants of the 'Middle Kingdom,' come across a Chinese gentlemen bearing the same name, he will find the most genuine interest taken in him by his newly-discovered clansman, and the utmost hospitality shown to him. The clansman in trouble or distress finds a refuge in his ancestral home in the heart of his clan in this land where poorhouses are unknown. Not only so, but a clansman, when out of work, can, and often does, go and live for days and weeks with one of the same clan as himself. Bed and board are given to him freely, and he is hospitably entertained until work again comes his way; and he, in his turn, is able to offer the same entertainment to a brother clansman in need.

The teapot in China is always ready to be produced on the advent of a stranger; nor is the Chinaman content with a single teapot, for often each cup serves for one, and each guest has a brew made specially for him, and replenished with boiling water as often as he likes. These cups are slowly sipped while the host does his best to entertain his visitor. Sweetmeats and pipes are also offered. A phrase in the Chinese language which is constantly heard is 'Come and sit down,' being an invitation to the house of those who utter it.

The low status of woman in China, her supposed inferior position in contrast to man, and the false prudery of the Chinese, have hitherto prevented the mingling of the sexes in entertainments, such as dinners, parties, and social gatherings.

¹ *Shu King*, pt. v. bk. iv. § vii. sec. iii.

² *Works of Mencius*, bk. vi. pt. ii. ch. vii. ver. 3.

³ *Ch. xx.* vers. 12 and 13.

⁴ *Ib.* pt. ii. bk. ii. ode ix.

⁵ *Ib.* pt. iii. bk. ii. ode iv.

⁶ *Shi King*, pt. ii. bk. i. ode i.

⁷ *Ib.* pt. ii. bk. iii. ode iii.

⁸ *Ib.* pt. iv. bk. i. ode ix.

Respectable women were excluded from participation in all such functions except when all present were of the same sex as themselves. But with the revolution in manners, customs, and education, as well as in government, which is now taking place in China, a different position is being taken by woman, and she has begun to share with her husband in both the dispensing and the receiving of hospitality.

LITERATURE.—In addition to the ancient sources cited in the footnotes, the following modern works may be consulted: J. Doolittle, *Social Life of the Chinese*, London, 1866; J. H. Gray, *China*, do. 1878; J. Dyer Ball, *Things Chinese*,¹ Shanghai and Hongkong, 1903; R. K. Douglas, *China*,² London, 1887; S. Kidd, *China*, do. 1884.

J. DYER BALL.

HOSPITALITY (Christian).—The foundation of the first hospitals and hospices by the Christian Church shows the practical way in which the principle of hospitality was applied by Christian charity to invalids and weary travellers. Hospitality is proverbial in the East (cf. the story of Abraham, Gn 18³⁻⁸). The guest was sacred and inviolable, even although discovered to be an enemy (Jg 19²³). Before the time of caravanserais, which were unknown until the end of the 7th cent. B.C. (cf. Jer 9²), the stranger, when travelling, was dependent upon the hospitality of private individuals. Hospitality was practised among the Greeks and Romans also, but it was a private rather than a civic virtue. Christianity transformed it into a public virtue, by demanding as a formal duty from members of the Church, and especially bishops, a more merciful and beneficent spirit. In fact, the earliest Christians interpreted Christ's words, 'I was a stranger, and ye took me in' (Mt 25³⁵), in their broadest sense (Mt 10¹², Lk 10⁶ 14¹²⁻¹⁴), and showed hospitality towards pagans as well as Christians.

St. Paul followed in Christ's footsteps: 'In love of the brethren be tenderly affectioned one to another; . . . communicating to the necessities of the saints; given to hospitality' (Ro 12¹⁰⁻¹⁴, cf. 1 Ti 5¹⁰). A 'saint,' i.e. a Christian, provided with a letter of recommendation from his church, could travel from one end of the Roman empire to the other without having any anxiety about a home. Wherever there was a Christian church he was sure of receiving food and shelter, and attention in case of illness. The Christians showed hospitality towards all poor travellers.

I. Hospitality in the East.—Naturally it was travellers attacked by illness that called forth the greatest pity and anxiety. This was the origin of hospitals (*ξενοδοχία, hospitia*), the first of which was founded in the last quarter of the 4th cent. A.D., on account of a famine which had caused a deadly epidemic.

The historian Sozomen (*HE*, iii. 16) relates the foundation in A.D. 370 of the hospital of Edessa in Syria thus: 'The town of Edessa, being afflicted by famine, the hermit Ephraim came forth from his seclusion to upbraid the rich with their hard-heartedness in allowing the poor to die instead of devoting a part of their superfluous wealth to their relief. "That wealth which you are so carefully amassing," he said to them, "will only serve to condemn you, while you are losing your own souls, which are worth more than all the treasures on earth!" Persuaded by these words, the rich people of Edessa informed him of their inability to decide upon the person to be entrusted with the distribution of their wealth, as the people of their acquaintance were all covetous and might put it to a wrong use. "And," Ephraim asked them, "what is your opinion of me?" "You are an honest man," they replied, "and we shall gladly give you charge of the distribution of our alms." He thereupon received large sums of money from them, and immediately ordered about three hundred beds to be fitted up in the public porches, and there attention was devoted to all those suffering from the effects of the famine—strangers and inhabitants alike.'

Basil, bishop of Cæsarea (in Cappadocia), had also opened a hospital in 375, not far from this town, consisting of several separate houses (see Greg. Naz. *Orat.* xlii. 'In laudem Basilii Magni,' 35).

If Osrhoene and Cappadocia can boast of having had the first hospitals, it was Constantinople that first specified the different classes of those requiring relief. Between A.D. 400 and 403 Chrysostom built several hospitals with the surplus of his income from the archbishopric. Each of these he placed under the charge of two faithful priests, to assist whom he engaged physicians, cooks, and capable workmen (Palladius, *Dial. de vita S. Joan. Chrysos.*, p. 19, ed. Montfaucon [PG xlvii. 20]). There were seven different hospitals: (1) the *Xenodochium*, inn for stranger travellers; (2) the *Nosocomium*, home for the treatment of acute complaints; (3) the *Lobotrophium*, shelter for cripples and chronic invalids; (4) the *Orphanotrophium*, home for the reception of orphans; (5) the *Gerontotrophium*, home for old people; (6) the *Ptochotrophium*, home for the reception of the poor; and (7) the *Pandochium*, a refuge for all kinds of destitutes.

Jerome is reputed to have founded the first orphanage in Bethlehem; and John the almoner, who was elected patriarch of Alexandria in 608, organized assistance to the poor and sick of that town.

The Council of Chalcedon (451) recommended the *parabolani*, i.e. 'clerks' employed in the hospitals, to remain in the service of the bishop. Widows were placed at the head of the list of those maintained at the expense of the Church, and in return they and the deaconesses attended to the sick women. Among the qualifications required from a widow in order to receive the Church's bounty St. Paul mentions: 'if she hath used hospitality to strangers, if she hath washed the saints' feet, if she hath relieved the afflicted' (1 Ti 5¹⁰).

2. Hospitality in the West.—Christian hospitality in the West gave rise to two kinds of institutions: (1) *hospitals*, intended for invalids, lepers, and other sufferers, and generally placed under the control of the bishops; and (2) *hospices* or almshouses, adjoining most of the monasteries, situated along the chief roads and in dangerous mountain passes; these extended a welcome to travellers overcome by fatigue or benumbed with cold.

Hospitality was the chief virtue enjoined upon the bishop. 'The bishop,' says St. Paul, 'must be given to hospitality' (1 Ti 3², Tit 1⁹), and the Apostolic precept was confirmed by the most famous Fathers of the Church. Jerome in his *Ep. lii.* ('To Nepotian'), and Chrysostom in his *Second Sermon on Genesis*, advise bishops to keep their houses open to strangers and sufferers in the cause of truth, and their table at the service of the poor, for, in doing so, they are sure to be entertaining Christ in disguise. St. Augustine had started a hospital in his own house, and often sat down at the same table with his guests. The Councils adopted this principle, and entrusted the bishops with the assistance of the poor and the sick (Council of Chalcedon, can. viii.).

In the decrees of the Councils of the Gallican Church are found the earliest regulations concerning the relief of the poor and the sick. The First Council, held at Orleans under Childebert in 511, devoted two canons to them. The fifth decreed that 'of the proceeds of offerings or lands granted to the Church by the king two-thirds shall be employed in the maintenance of the clergy and the poor and one-third in the redemption of prisoners.' The sixteenth adds: 'The bishop shall provide food and clothing, so far as his means will allow, to the poor and the sick who on account of their infirmities are unable to work for themselves.' The Fifth Council of Orleans (549) is quite as formal. After forbidding the unlawful use of any part of the alms bequeathed to the hospitals.

it enjoins upon the bishops (can. xxi.) the care particularly of lepers, and the duty of supplying them to the best of their ability with food and clothing, 'so that Christian mercy might not fail even in the case of victims of that most loathsome disease.' The fifteenth canon mentions the earliest hospital as being in France, and founded at Lyons in 542 by King Childebert and his wife Ultrogotha at the instigation of the bishop. Paris does not seem to have had one until the middle of the 7th cent., when Bishop Landry established (650) a home for invalids and poor travellers near his church—whence the name *Hôtel-Dieu*. It is to Lanfranc, its archbishop, that Canterbury owes its hospital (1070), and the first London hospital was called St. Bartholomew's (1102). In these semi-barbarian ages hospitals were often dedicated to the Holy Spirit, whose emblem, a dove, is found on the frontal of several, e.g. the hospital built by Pope Symmachus in Rome (498).

At first the bishops had the management of the hospitals, but gradually, as the duties increased, they were passed over to the chapters, who delegated this work to a few priests called *provisores* or *præfecti nosocomii*. The *Capitularies* of Charlemagne decreed that the secular and regular clergy should, as one of their first duties, relieve the sick; and, to guard against neglect of duty, they placed the *xenodochia* under the control of royal authority (*Capit.* 183). The Council of Meaux (845) refers to the *Hospitia Scotorum*, complaining that these had been diverted from their original purpose of hospitality, and imploring their reinstatement as almshouses for travellers and invalids.

3. Hospices of the monasteries in the Middle Ages.—While the bishops were the first to establish hospitals for the care of the sick, it was the monks who created a special form of Christian hospitality—the almshouse, or so-called *xenodochium*. Its foundation is generally attributed to St. Benedict of Nursia; this, however, is not correct, as it can be traced back as far as the very beginnings of Eastern monasticism.

The custom of washing the feet of the guests which was in vogue in the Irish convents of the 8th cent. came from the East. Johannes Cassianus, founder of the monastery of St. Victor near Marseilles (410), in his *Collationes* (chapter xvi. 'Magister hospitium'), describes the ceremony performed at the reception of a guest. After the customary salutations the traveller was introduced into the *hospitium*, a wing of the building apart from the rest of the cloister, and taken to his room. After having been shown into the dining-room (*caenaculum*), he had his feet washed by one of the monks. The whole company then shared in the joy caused by the arrival of a guest, breaking their fast and eating cooked food.

When Columban, at the end of the 6th cent., brought Christian principles, along with the elements of civilization, into Gaul, which had been laid waste by the barbarians, he founded monasteries at Anegray, Luxeuil, Fontaine, Bobbio, etc., and urged upon his monks the duty of hospitality towards strangers and poor pilgrims. His disciples, St. Ouen, St. Faron, St. Gall, etc., practised this virtue to such an extent that in the 9th cent. the fame of Scottish hospitality was wide-spread. These are the hospitable monasteries referred to by Charlemagne in his *Capitularies*, by the members of the Council of Meaux (845), and the Council of Quierzy (858), when they speak of the decline of the *hospitia peregrinorum*. The bishops assembled at the first of these Councils implored the Emperor Louis le Débonnaire to restore these *hospitia*, help them by endowments, and place them under their control.

'It is our duty,' they said (can. 40), 'to inform your Majesty concerning the homes established and equipped in the time of your predecessors, and to-day almost annihilated. The Scottish *hospitia* especially, which the kindly people of that nation had built there, and endowed from their wealth acquired because of their goodness, have been completely diverted from their real purpose. Not only are those who ask for hospitality refused

admittance, but even those who, bound by the tie of religion, have served the Lord from their childhood, are being driven from them, and compelled to go begging from door to door.'

Besides Johannes Cassianus and Columban, who imitated the practices of the Eastern Church, Benedict of Nursia also imposed the duty of hospitality upon the monks of the West. The 53rd chapter of his *Regula* is entitled 'de Hospitibus suscipiendis,' and reads as follows: 'Let all visitors who chance to arrive be welcomed as if it were Christ Himself, who will one day say to us, "I was a stranger, and ye took me in." Let due honour be shown to all, especially to servants of the faith and pilgrims' (*PL* lxi. 750; cf. E. Martène, *Commentarius in regulam Sancti Benedicti*, Paris, 1690).

There was practically no monastery in the Middle Ages without its *xenodochium*, and many had a *nosocomium* as well. These hospices rendered valuable service at a time when the roads were infested by robbers, or exposed to frost and snow, e.g. those leading through the passes of high mountains, and subject to thick fogs or snowstorms. Such were the hospices adjoining the cloisters on the three chief Alpine passes leading from Switzerland to Italy and France. The hospice of St. Gothard has been almost abandoned since the completion of the railway from Lucerne to Lugano (1882). That of Simplon is greatly affected by the new road leading from Brieg to Domo d'Ossola. The hospice of the Great St. Bernard still exists, and is prepared to render service to travellers on the road from Martigny to Aosta. The monks living there belong to the Augustinian Order, and their lay brothers are called 'Maroniers.' The adventures of those brave men and their famous dogs are well known. They have rescued from certain death thousands of travellers lost in the snow and almost frozen. For this purpose the monastery of the Great St. Bernard received an annual grant from the kings of France (1760). The grant was confirmed and increased by Napoleon Bonaparte, after the famous crossing of his army through this pass (15th to 21st May 1800).

4. Orders of Hospitallers.—The epidemics which frequently raged among the pilgrims travelling from the West to the Holy Land, and among the soldiers of the Crusades, led to the foundation of hospitals and Orders of Hospitallers in Palestine. The first hospitals were founded at the end of the 6th cent. by Pope Gregory I., and afterwards restored by Charlemagne, who took a great interest in the Christians of the East. The hospice of St. John, established at Jerusalem before the first Crusade by a few Amalfi citizens, gave rise to the first Order of Hospitallers called 'Hospitallers of St. John of Jerusalem,' or 'Joannites,' whose rules were drawn up by Brother Gerard (or Gerhard) (d. 1120). This Order, composed of three classes, priests, knights, and attendants, was of a semi-charitable, semi-military nature. As a consequence of the services it rendered, it spread throughout the whole of Europe, and was divided into eight provinces or 'languages.' After the conquest of Palestine by the Turks, the Joannites transferred the seat of their Order to Rhodes and subsequently to Malta, whence the names 'Knights of Rhodes' and 'Knights of Malta,' by which they are also known. The French branch disappeared at the Revolution of 1789. The German branch was restored by Frederick William IV., king of Prussia, about 1850, and still exists under the name of 'Johanniter-Orden.' The English branch, which was abolished and had its wealth confiscated by Henry VIII., was reorganized in 1826. Its special work is the supervision of convalescent homes and small country hospitals, and the training of sick nurses for the poor. The English Joannites were of invaluable service to the wounded in the Trans-

vaal war. In imitation of the Joannites the 'Hospitallers of the Holy Spirit,' the 'Hospitallers of St. Lazarus' to tend lepers, the 'Hospitallers of St. John of God,' an Order founded in Granada (Spain) by a Portuguese of that name (d. 1550), etc., were formed.

In the Christian Church the care of the sick has never been confined solely to men, but both in the primitive Church and during the Middle Ages was largely participated in by women; so that the number of Orders of Hospital Sisters exceeds that of the Brethren. Among the oldest and most famous, mention is due to the society of 'Hospital Sisters of the Hôtel-Dieu' (of Paris), known as 'Augustine Sisters' (beginning of the 13th cent.), the 'Haudriettes,' the 'Ladies of the Hôtel-Dieu' of Beaume, the 'Filles-Dieu' of Orleans, the 'Sisters of St. Thomas' of Villeneuve, and especially the 'Sisters of Charity,' organized by St. Vincent de Paul to assist the 'Dames de Charité' in the nursing of the sick, and obliged to remain free from monastic fetters.

Hospices and almshouses were also established near the famous pilgrimage places, to afford shelter to the numerous pilgrims visiting them, e.g. at St. Jacques de Compostella in Spain, Our Lady of Loretto in Italy, and Our Lady of the Hermits in Switzerland (Einsiedeln).

The 'Maladreries,' 'Mozelleries,' or 'Hospitals of St. Lazarus,' special homes for lepers, constituting a branch apart from hospitals, do not demand attention here.

5. Hospitality in modern times.—It may be said that individual hospitality has decreased practically in direct proportion to the advances achieved in the means of transport and the number of hotels.¹ It is, however, still practised to a considerable extent in Eastern countries and in the north of Europe, e.g. Scotland. But, if private hospitality has diminished as a result of civilization, public hospitality, on the other hand, has advanced with rapid strides not only by developing existing charitable institutions, but by creating new and very ingenious methods of relieving the sick and destitute.

This leads us to subdivide the remaining discussion into two parts: (1) the development of ancient institutions; and (2) the formation of new methods of relief.

(1) The ancient *xenodochium* has been transformed into various kinds of night refuges. As early as the 12th cent. the Hospital Sisters of St. Augustine in Paris were in a position to provide three hundred vagrants with three nights' lodging in their convent of 'Blancs-Manteaux.'² Destitute women were received in St. Catherine's Home in Lombard Street. In 1872 Massabo founded the first night refuge at Marseilles, and his example was followed by Lamaze and the Philanthropic Society, who opened large night shelters for men and others for women in Paris (1878). The municipal board of Paris, the municipalities of London, and most of the European capitals, following in their train, opened various night shelters. The Salvation Army has distinguished itself in this respect.

As a result of the reforms started in England by John Howard and Florence Nightingale, and in France by La Rochefoucauld-Liancourt, Tenon, etc., the ancient *nosocomium* has developed into the modern hospital with all its hygienic improvements. Before these reforms the best organized hospitals were military or *lazaretto* hospitals. At the end of the 18th cent. the public hospitals in

¹ The Swiss hold the first rank in the management of hotels. At Ouchy, near Lausanne, they have built a normal school for hotel managers, which is admirably organized, and is attended by young people from all countries.

² There is still a street of 'Blancs-Manteaux' in the Temple quarter of Paris.

France had reached such a depth of decay that they were dreaded by the poor, and deservedly called forth the censure of philanthropists and the complaints of medical men.

'You have in Paris,' wrote Voltaire to Paulet on 22nd April 1768, 'a hospital (Hôtel-Dieu) where perpetual contagion reigns, where poor invalids huddled closely together infect their neighbours with the plague and death.' Michelet, the distinguished historian of ancient France, is equally bitter. 'Ancient hospitals,' he says, 'were exactly like reformatories. The sick poor and prisoners confined in them were generally regarded as culprits struck by the hand of God, whose first duty was to atone for their sins, and they were subjected to cruel treatment. Charity of such a dreadful kind arouses our horror. An attempt was made to dispel the terrors of the hospitals by adorning them with enticing names, such as "Hôtel-Dieu," "La Charité," "La Pitié," "Le bon Pasteur," but that did not succeed in imposing upon poor invalids who hid themselves to die at home, so terrified were they at the thought of being forcibly dragged into these places.'

At that time the insane were chained in their cells, and such was the terror inspired by these victims of insanity that they were believed to be 'possessed by the devil.' Dr. Pinel showed great courage in breaking the chains (1792-94).

In England John Howard (d. 1790), who is well known on account of his remarkable zeal, took the initiative towards reforming hospitals, and in France that step was taken by the Academy of Sciences. The fire which took place in the Hôtel-Dieu in 1784, and burned to death several hundreds of the inmates, roused a wide-spread feeling of pity and indignation.¹ £80,000, a large sum at that time, was collected by public subscription for the reconstruction and improved sanitary arrangements of this hospital. The committee appointed by the Academy of Sciences for the reform of public hospitals numbered in its ranks such philanthropists as Bailly, the Duke of La Rochefoucauld-Liancourt, Tenon, etc. The memoir written by Tenon (1787) is a master-piece of technical knowledge and courage, denouncing the horrors referred to by Voltaire. The 'Convention' appointed a committee to carry out the proposed reforms, but the Revolution and the wars of the Empire prevented the realization of Tenon's scheme. Nothing more was achieved until Louis Philippe's reign. Then the Count of Rambuteau, prefect of the Seine department, ordered preparatory investigations concerning the rebuilding of the Hôtel-Dieu, which, however, was not actually achieved until the reign of Napoleon III. (about 1866-68). We would call special attention to the most recent improvements, especially in the maternity and surgical wards of hospitals, resulting from Pasteur's discoveries and Lister's antiseptic method.

Institutions for the maintenance of widows and orphans are as old as the Church. Wherever there was a Christian community it regarded the assistance of those unfortunates as its first duty. But there are several ingenious modern methods of this kind of aid, which we shall merely mention. Having noticed the disadvantages of a widow having to live alone while her children were sent to an orphanage, some philanthropists gave her pecuniary assistance, enabling her thereby to keep her children at home,² and to preserve the family tie intact—a state of affairs beneficial to both mother and children. It was this idea that gave rise to the 'Œuvre des petites Familles' founded in Paris in 1891. Its aim is to bring together orphans of both sexes and all ages in a house where they are under the care of a Christian matron, who treats them as if they were her own children. Here they receive manual instruction, one of the regulations being that every orphanage must have a workshop connected with it.

¹ The Hôtel-Dieu in Paris had become a sort of *caravanseraï*, open to all poverty-stricken, aged, disabled, and vagrants of both sexes, whether they were ill or not. No fewer than 6000 people took refuge there, and it was quite an ordinary occurrence to have three or even four invalids lying in one bed.

² Cf. the 'Œuvre des Veuves' founded by Ed. Vaucher in Paris, 1893.

Ever since the Middle Ages the monasteries have hospitably opened their doors to such fallen women as have repented, and, endeavouring to hide their shame, are making a fresh start. Robert d'Arbrissel, the celebrated preacher of repentance, founded the Order of Fontevrault. One of the convents of this order, St. Magdalene's, was specially set apart for fallen women. In more recent times this admirable work of hospitality and moral aid has been carried on by the Roman Catholic 'Good Shepherd's Nuns,' the Anglican and Protestant deaconesses of Kaiserswerth, and the female officers of the Salvation Army; and to-day it is being done by the rescue-work of the 'Home of Fantine,' founded by Madame d'Avril de St. Croix, and by R. Bérenger's 'League for the Suppression of the Trade in White Women.'

The aged also, afflicted by poverty and infirmities, have at all times aroused the compassion of the faithful. At one time they were received in certain of the monasteries; nowadays there is no town of any size which does not possess its home for the aged. A new feature introduced into these homes in the 19th cent. was the keeping together of old couples, and the association of widows and widowers with young children, so that the melancholy of their old age might be brightened by the happiness of youth. We may mention as examples of the former kind the 'Asile des petits Ménages' at Issy, near Paris, built on the site of the ancient 'Hospital for Lepers' of St. Germain (founded in 1100) and the 'Home of Sainte Périne' in Paris, and as a type of the latter the 'Asile protestant de Nanterre' for old women and little girls.

(2) Among modern forms of hospitality the most noteworthy is what is known as the workhouse—a combination of refuge and workshop. The idea, however, is not quite new, for, even before the French Revolution, workshops had been opened in times of poverty to enable the poor to earn a livelihood.

'But,' says Louis Rivière (*L'Assistance par le travail à Paris*, 1896), 'the characteristic feature of our time consists of a new element, the effort to impart a systematic organization to this method of relief, so that the poor man may obtain something more than pecuniary assistance. All these institutions have a common aim: in the case of an able-bodied pauper, instead of alms, which are degrading and encourage idleness, they substitute ennobling work—provisionally, however; for, although sufficiently remunerative to ensure a livelihood, it also stimulates the desire to obtain something better. The work is compensated either by food and lodgings or by wages.'

This method of aid, hospitality in return for work, has been applied on a very large scale by F. von Bodelschwingh in his admirable settlement near Bielefeld in Westphalia and by J. Rostand at Marseilles; and in Paris large workhouses for women have been founded by Mesdames Suchard de Pressensé¹ and Risler² and Léon Lefebure, and for men by A. Robin and the Earl and Countess of Laubépin.³

Connected with these institutions there are homes for convalescents and for worn-out working men. To the former class belong the 'Villa Helvetia' at Mentone and the National Shelters at Vincennes and Vésinet founded by Napoleon III., and, in the second, mention is due to the Sailors' Homes established in Great Britain and other countries, and maintained in order to provide a home for homeless sailors returning from long and perilous voyages. There, under the care of a matron, they find comfort for body and soul.

The care of children is a characteristic feature of our times, especially of the French nation, which has shown its ingenuity in inventing, in addition to orphanages, other new methods of hospitality to children. In the first rank stands the institution of 'Crèches' (infant asylums), founded

¹ 'Œuvre du Travail,' as it is called, in the Rue de Berlin, 1856.

² 'Asile temporaire pour des Femmes' (1888).

³ 'Œuvre de l'Hospitalité par le travail à Belleville et à Passy.'

in Paris in 1844 by Firmin Marbeau, and now extending their privileges to the children of more than two hundred European towns. Their aim is to nurse and feed young infants whose mothers have to go out to work. To this class belong the 'Crèche Furtado-Heine' and the 'Asile Léo Delibes' in Paris, the 'Pouponnière' in Versailles, etc. The children's shelters established at St. Maur-les-Fossés (near Vincennes) differ from infant asylums in receiving children from two to seven years of age, and not only by the day, but for several years, as long as their parents are unable to attend to them.

The services done by the 'Colonies de Vacances,' started by L. Bion at Zürich and imitated in Paris, Berlin, etc., and by the 'Enfants à la Montagne' organized by Louis Comte, a St. Etienne clergyman, which aim at enabling the delicate and weakly children of large manufacturing towns to get the benefit of country air and good food, are also worthy of the greatest praise. But still more to be pitied than the children of the working-class poor are those wretched little ones whom Jules Simon called 'orphans whose parents are still alive.' Homes for such children were founded in London by Dr. Barnardo, in Liverpool by James Nugent, and at Ashley Down, near Bristol, by George Müller; and in Paris Mesdames A. de Barrau and Kergomard established homes and proffered hospitality and education to the poor creatures who were the victims of unnatural parents.¹ Thousands of these children have by this means been prevented from becoming thieves and criminals.

Children whose defective instincts or undisciplined nature resisted both physical and mental instruction used to be sent to 'Reformatories,' where they often became more corrupted than before by bad company. Attempts have been made to improve this state of affairs by founding agricultural schools at Mettray (at the junction of the Indre and the Loire) and at La Force (on the Dordogne), where military discipline and agricultural work have succeeded in taming the most ungovernable natures.

But more important than all these ways in which modern hospitality has displayed its excellent spirit is its solicitude for young women and girls in search of employment. Many associations, differing in name but having in common this spirit of charity, vie with each other in the enthusiasm with which they not only provide homes for lonely girls, servants, or governesses in search of work in Paris, but also give them valuable advice and secure situations for them in shops and good families. Such are the 'Union internationale des Amies de la jeune Fille,' which has branches in all the European capitals as well as in Paris, the 'Amicitia' club, the 'Adelphi,' and the 'Restaurant pour Dames seules.'

And, lastly, it is an almost incredible fact that charity has not given up hopes of curing what was thought to be an absolutely incurable vice, drunkenness. Establishments have been opened in Switzerland, France, England, Sweden, etc. for the cure of inebriates, and in spite of great difficulties they are beginning to obtain encouraging results.

LITERATURE.—Filassier-De la Croix, *Dict. histor. d'éducation*, 2 vols., Paris, 1837, art. 'Hospitalité'; *Encyc. moderne*, Paris, 1848, art. 'Hôpitaux'; Etienne Chastel, *Études historiques sur l'influence de la charité durant les premiers siècles*, Paris, 1853; H. Häser, *Gesch. christlicher Kranken-Pflege und Pflegerschaft*, Berlin, 1857; J. A. Martigny, *Dict. des antiquités*, Paris, 1865; W. E. H. Lecky, *Hist. of the Rise and Influence of the Spirit of Rationalism*, London, 1865, ii. 263; R. Virchow, 'Über Hospitäler und Lazarette' in his *Gesammelte Abhandlungen*, ii. (Berlin, 1879); F. Lichtenberger, *Encyc. des sciences religieuses*, Paris, 1876-82, art. 'Hôpitaux'; G. Uhlhorn, *Die christliche Liebesthätigkeit*, Stuttgart, 1895 (Eng. tr. of 1st pt., *Christian Charity in the Ancient Church*, Edinburgh, 1883); *Encyc. d'hygiène et médecine*, Paris, 1890, artt. 'Hôpitaux,' 'Hospices'; H. Burdett, *Hospitals and*

¹ Special mention is due to the 'French Union for the Rescue of Children,' under the direction of C. Gayte, and the 'Patronage of young Protestant boys in moral danger,' founded by A. Robin and managed by Etienne Matter, which provide homes for children in the country, where they are taught various trades.

Asylums of the World, London, 1893 (with annual supplement entitled *Burdett's Hospitals and Charities*); W. P. Paterson, 'The Denudation of the Church,' in *ExpT* vi. (1895) 108; *La France charitable et prévoyante, Paris charitable et prévoyant*, 2 vols., Paris, 1896-97; Hamilton-Regnault, *Les Gardes-malades*, Paris, 1901; L. Lallemand, *Hist. de la charité*, Paris, 1902-03; H. Gambier, *Annuaire protestant*, Paris, 1905; B. Kirkman Gray, *A Hist. of English Philanthropy*, London, 1905; A. Harnack, *Mission and Expansion of Christianity in the First Three Centuries*, Eng. tr.², London, 1908, ii. 177; art. 'Hospitals' in *Cath. Encyc.* vii. 480; artt. 'Hospitals' and 'Hospitium' in *DCA* i. 785, 789. G. BONET-MAURY.

HOSPITALITY (Greek and Roman).—Hospitality is the name of a relation and of a quality. In Greek the relation is expressed by *ξενία*, the quality by *φιλοξενία*; in Latin the corresponding words are *hospitium* and *hospitalitas*. It is with hospitality as a relation that we shall first be concerned. In both Greece and Rome the relation was one between members of different States, and it held between families rather than individuals, or, it might be, between a family or individual and a State. This gives us a division of hospitality into private and public. In relation to private persons a man was called in Greek *ξένος*, in relation to a State *πρόξενος*; and the like distinction held between *ξενία* and *προξενία*.¹ In Latin the one word *hospitium*, with its concrete *hospes*, was used for both private and public hospitality. There are some relations, like that between father and son, in which, the relation not being the same on both sides, a different word is required to express each of the terms. But, as the relation of hospitality was reciprocal, he who was host becoming guest in his turn, the Greeks and Romans were content with one word (*ξένος*, *hospes*) to cover both sides of the relation, like our words 'brother,' 'cousin.'² We, however, have differentiated the two words, 'host' and 'guest,' which come ultimately from the same root, in order to distinguish the two sides of a relation which is not with us so necessarily convertible as it was with the ancients. When the Greeks found it convenient to distinguish, they expressed the entertainer by the word *ξενόδοκος*, leaving *ξένος* for the person entertained.³

The word *ξένος*, dialectic forms of which are *ξείνος*, *ξέννος*, is probably connected etymologically with Lat. *hostis*, being for **gzhenvos*, **ghs-en-uos*;⁴ and, like *hostis*, it means originally an outsider or foreigner of some sort. Herodotus twice notices the Lacedæmonian use of the word in this its primary sense, as equivalent to *βάρβαρος*. When Amompharetus plumped down a big stone before the feet of Pausanias, he exclaimed: 'With this pebble I give my vote not to run away from the foreigners' (*τοὺς ξείνους*).⁵

Cicero tells us⁶ that the word *hostis* meant originally nothing more than *peregrinus*, quoting the Twelve Tables in support of his assertion, which philology sanctions by connecting the Latin *hostis* with the German *Gast*. Cicero draws a conclusion as to the mildness of the early Romans, who called their enemies nothing worse than 'strangers,' though they might have called them *perduelles*. Others, however, might argue from the same philological fact that the Romans failed to distinguish between strangers and enemies.

Hospit-, the stem of *hospes*, is regarded by philologists as a contraction for *hosti-pet*; but as

¹ Athen. xiii. 81, p. 603 f.: 'Ἐρμησίλειω δὲ, ξένου οἱ ἴδιος καὶ προξένου Ἀθηναίων.'

² The feminine of *ξένος* was *ξένη*, of *hospes*, *hospita* (Plato, *Laus*, xii. 953 D: ὑποδέχεσθαι τε χρὴ πάντας ξείνους τε καὶ ξένας ἐξ ἄλλης χώρας; Cic. *Verr.* ii. 11. 24: 'femina primaria Servilla vetera Dionis hospita').

³ *Od.* viii. 542 f.: ἰν' ὁμῶς τερπόμεθα πάντες ξενόδοκοι καὶ ξείνοι. Cf. *Il.* iii. 854; *Od.* viii. 210, xv. 54 f. In Homer *ξένος* and its derivatives always appear in the Ionic forms *ξείνος*, etc.

⁴ K. Brugmann, *Gr. Gram.*,⁴ Munich, 1913, p. 112.

⁵ Herod. ix. 55: ξείνους λεγὼν τοὺς βαρβάρους. Cf. ix. 11: ξείνους γὰρ ἐκάλεον τοὺς βαρβάρους. Cf. Plut. *Aristides*, 10.

⁶ *De Off.* i. 37.

to the meaning of the latter element there is a difference of opinion. According to some, it is from *pa-*, the root of *pasco*; according to others, it is connected with *pot-*, as seen in the Latin *potens*. On the former assumption the word would mean 'feeder of guests or strangers,' on the latter 'guest-master,' i.e. master of the house in which guests are entertained (see below, p. 818 f.). In early society, when there was not an Imperial Hotel in every big town, hospitality was one of the most important of the relations of life.¹

The first point to notice about this relation is that it was extra-political. It carried a man beyond the bounds of his own State, and so was the beginning of the brotherhood of man. While all around was hostility or indifference, it was something to feel that there was one foreign city where one's warmest welcome would not be at an inn.

Secondly, the relation was reciprocal, which led one to do as he would be done by. If one were host to-day, he would be guest to-morrow, or, let us say, next year, and dependent for his comfort and well-being on the man whom he was now entertaining. 'And I myself,' says Admetus, 'find in him a most excellent host, whenever I come to the thirsty land of Argos.'² Odysseus in the *Odyssey* is made to utter a shrewd remark about the stupidity of contending in games with one's host.³

Thirdly, the relation was hereditary, descending from father to son. When Glaucus in the *Iliad* had declared his pedigree, Diomedes recognized that the tie of hospitality had been contracted between his own grandfather, Ceneus, and Bellerophon, the grandfather of Glaucus.⁴ 'Why, you are my old hereditary guest-friend!' he exclaims; and so, amid the war of nations, the two heroes conclude a private peace, agreeing to avoid each other's weapons. The beautiful episode of Glaucus and Diomedes, while from the poet's point of view it serves the purpose of filling up the time until Hector returns to the field, having discharged his mission to Troy, has from our point of view the recommendation of throwing a vivid light on the early importance of the tie of which we are speaking. Again, in the *Odyssey* when Athene, under the guise of Mentis, wishes to gain the confidence of Telemachus, she tells him that they are hereditary guest-friends, adding that he can go and ask his grandfather Laertes about the matter.⁵ As a matter of fact, this assertion is untrue, as is that in *Od.* xvii. 522, where Odysseus, disguised as a beggar, claims to be an hereditary guest-friend to himself, but it is illustrative of the fact without which it would lose its meaning. In *Od.* xv. 195-198 we see how the consciousness of hereditary affection makes the hearts of the young Telemachus and of Nestor's son Pisistratus warm to one another.

A fourth point to notice about the relation of hospitality is that it was inaugurated and accompanied by an interchange of gifts. On the discovery that they are guest-friends, Glaucus and Diomedes exchange armour on the field of battle, which gives occasion to the canny saying of Homer:

Then Glaucus of his judgment Jove deprived,
His armour interchanging, gold for brass,
A hundred oxen's worth for that of nine.⁶

¹ In Græco-Roman times the accommodation for travellers does not seem to have been very good—partly perhaps on account of the very system of *ξενία*, or *hospitium*, of which we are speaking. The various words in Greek and Latin for a place of entertainment do not connote more than our word 'inn'—*πανδοχείον* (Aristoph. *Ran.* 550), *καταγωγίον* (Thuc. iii. 68), *κατάλυσις* (Herod. v. 52), *κατάλυμα* (NT); *hospitium*, *devisorium* (Cic. *Cat. Mai.* 84), *caupona* (Hor. *Epist.* i. xi. 12), *taberna* (Cic. *Ino.* ii. 14).

² Eurip. *Alc.* 559.

³ *Il.* vi. 215.

⁴ Lord Derby's tr. of the *Iliad* (vi. 276 ff.).

⁵ *Od.* viii. 210.

⁶ *Od.* i. 187.

In the *Odyssey* the first thought of Telemachus, on being told that Mentis is an hereditary guest-friend, is to press some keepsake upon his acceptance.¹

Fifthly, the parties to the relation secured themselves against impostors by the device of tickets, which were broken between them, one part being retained on either side. *σύμβολον* was the Greek word for a ticket of this kind, and we find Plautus speaking of it as *hospitalis tessera*.² Probably this custom grew up in post-Homeric times. If so, Euripides is guilty of an anachronism when he makes Jason offer such hospitality-tickets to Medea, for her to present to his guest-friends.³ Crito, the contemporary of the poet, might have adopted this method of securing the welfare of Socrates, had that philosopher availed himself of the means provided for his escape into Thessaly.⁴

Lastly, the relation of which we are speaking was no light expression of casual goodwill, but a solemn engagement which had the sanction of religion. The Supreme God in one of his aspects presided over it, so that we hear of *Ζεὺς Ξένιος* and *Jupiter hospitalis*.⁵ What made the offence of Paris so rank, in carrying off Helen, was that it was a violation of the rights of hospitality; and what added a darker horror to the crime of Ægisthus was that he first gave a banquet to Agamemnon and then slew him as one slays an ox in the stall.⁶ It is worth noting that Herakles, who ended by being the greatest saint in the Stoic calendar, started on his career by being a bad man, who slew a guest in his own house.⁷

Besides indicating the special relation of which we have been speaking, the word *ξένος* signifies also any stranger or foreigner as opposed to *ἀσπός*, *πολίτης*, *ἐπιχώριος*. Hence the address *ὦ ξένη* was used like the American 'stranger.' Men did not travel much for pleasure in early times, for that was to cut themselves off from the social organism, of which they were part, and expose themselves to the mercy of strangers. If a man were found wandering about in another country, he had generally some very good reason for having left his own. Perhaps he had killed some one, whether by accident or design, or had in some way made himself obnoxious at home. At all events, he was helpless now, and to the credit of human nature be it said that the appeal to pity is seldom ineffectual. In early Greece, as among the Jews, there was a strong sentiment in favour of the protection of strangers. Any wanderer or refugee was regarded as being under the protection of *Ζεὺς Ξένιος*; nay more, the helper of the helpless, *Ζεὺς Ἰκέσιος*, extended his care over him. This sentiment finds strong and frequent expression in the *Odyssey*.⁸ It is remarked, indeed, of the Phæacians that they have no fondness for strangers,⁹ but even they treat their unknown visitor royally, when once they have accepted him as a suppliant. Had we not the authority of Athene for the statement, we might be surprised that the Phæacians, of all people, should display an aversion from strangers, considering how fond they were of visiting foreign lands. The Cyclopes are a gruesome exception in the Homeric world to the general regard displayed for strangers, but then they are not men but monsters. The inhospitality of the Tauric Chersonese is beyond the ken of Homer. Human sentiment, when it lacks

¹ *Od.* i. 311 ff. See also *Il.* xv. 532; *Od.* xxiv. 285 f., 313 f.

² *Pœn.* v. ii. 92, v. i. 25: 'Deum hospitalem ac tesseram mecum fero'; *Cist.* ii. l. 27: 'confregisti tesseram.'

³ *Med.* 613.

⁴ *Crito*, 45 C.

⁵ *Il.* xlii. 625; Cic. *Fin.* iii. 66, *Deiot.* 18.

⁶ *Od.* iv. 535, xi. 411.

⁷ *Ib.* xxi. 27 ff.

⁸ *Ib.* vi. 207 f., xiv. 57 f., vii. 164 f., viii. 546 f., ix. 269 ff., xiii. 213, xiv. 283 f.

⁹ *Ib.* vii. 32 f.

efficiency, clothes itself in a religious sanction, and appeals to the powers of heaven in favour of what is not, but ought to be. There are many stories which point the moral how the God of Hospitality and the God of Supplication (Zeus *Ξένιος* and Zeus *Ἰκέσιος*) cannot be flouted with impunity. Folklore also declared that the gods assumed the likeness of strangers, and went up and down in the world to keep watch upon the ways of men. The outrageousness of the offence committed by Antinous, when he hurled a stool at the wandering beggar who asked for alms, stands out in high relief when we find that even the unruly suitors were shocked at this conduct, and that it is one of them who expostulates with him thus:

'Antinous, thou hast not done well to hit the unhappy wayfarer, accursed man, if indeed there be a god in heaven! And gods in the likeness of strangers from other lands, taking all sorts of forms, roam about among the cities, keeping watch upon the violence or good behaviour of men.'¹

Thus, in the Hellenic as in the Hebrew world, one might in exercising hospitality be 'entertaining angels unawares' (He 13²). Even in St. Paul's time, in the cities of Lycaonia, there was vitality enough in the idea of 'gods coming down in the likeness of men' to lead to practical expression in the way of sacrifice (Ac 14¹¹). It was the same district which was the scene of the story of Baucis and Philemon, who entertained at table Jupiter and Mercury.²

That there is more about hospitality in the *Odyssey* than in the *Iliad* is probably due to the nature of the subject-matter—the one dealing with peace, and the other with war. When the envoys from Agamemnon come to Achilles in *Iliad*, bk. ix., the first thought of that hero is to call to Patroclus for a bigger bowl and a stronger mixture,³ together with a cup for each. Patroclus' own forethought supplies such trifling accessories to the feast as the chine of a sheep, a goat, and a fat hog. The carnivorousness of the Achæan heroes, we may note in passing, stands in strong contrast with the temperate, and almost vegetarian, diet of the Athenians. When Priam comes as a suppliant to Achilles, in bk. xxiv., he is met with the same prompt and sheep-slaying hospitality; but the hero, aware of the uncertainties of his own temper, has to warn the old man to avoid irritating him, lest he should forget, even in his own hut, that he is dealing with a suppliant, and might thereby transgress the commands of Zeus.⁴

The politeness of an Homeric host required that he should feed his guest before he asked who he was. This is an excellent rule. For, in the first place, it is a tax upon one who is tired and hungry to have to talk at all; secondly, the host makes it plain that his kindness has no respect of persons; and, thirdly, if it should be an enemy that he is entertaining, he will find it more difficult to hate him after doing so.⁵

Gifts, as has been said already, were usual between the parties who entered into a formal relation of hospitality. But, besides this, some dole or gift seems to have been regarded as the right of any stranger as such. The value would, of course, vary with the importance of the stranger and the disposition of the donor. Odysseus at first expects to get some such gift even out of the Cyclops.⁶ As a beggar he does get meat and drink from Nausicaa, with the remark on her part that 'all strangers and poor are from Zeus, and a gift, though small, is welcome';⁷ but, when his name and fame have become known to the Phæacians, he receives

¹ *Od.* xvii. 488-487.

² *Il.* ix. 202 f.

³ *Od.* iv. 60-62; cf. i. 123 f.

⁴ *Ib.* vi. 207 f.

⁵ Ovid, *Met.* viii. 626-720.

⁶ *Ib.* xxiv. 569 f.

⁷ *Ib.* ix. 266 ff.

parting gifts from them which show their appreciation of his dignity. Menelaus also on his travels picked up much wealth from presents.¹ In fact, we derive from the *Odyssey* the impression that in those days (but then, *when* were they?) travelling on the part of a distinguished man was a source of gain, instead of expenditure.

Among the Romans, as among the Greeks, the formal relation of hospitality was inaugurated by the interchange of gifts, either in person or by proxy. So Servius tells us;² and the poet himself illustrates his commentator when he makes Evander ready to receive overtures of alliance from Æneas, on the ground of the gifts which he had received as a lad from the hero's father, Anchises.³ As among the Greeks, also, the relation was kept up from father to son, and might be contracted with the most distant potentates; for instance, we find that Pompey was on terms of hospitality with King Juba;⁴ and Marcus Metius, an obscure person, with Ariovistus.⁵

The words of Ovid descriptive of the Iron Age—'non hospes ab hospite tutus'⁶—are eloquent of the sanctity which in Roman opinion attached to the tie. There is an interesting discussion in Aulus Gellius as to whether *hospitium* or *clientela* came next after one's obligations to parents and to wards. He cites Massurius Sabinus, a writer on civil law, as giving the preference to *hospitium* over *clientela*;⁷ and we find Cornificius, in his treatise addressed to Herennius, putting the duties of life in the same order.⁸ The generally accepted order of claimants, however, was this: parents, wards, clients, guest-friends, kinsmen, connexions. As the relation of hospitality was one which, from the nature of the case, came into operation only at intervals, it was naturally sometimes of a ceremonious character, not implying personal intimacy.⁹

Herodotus tells us that no States were ever so closely connected by ties of hospitality as Sybaris and Miletus;¹⁰ and some language of Plato in the *Laws*¹¹ would lead us to think that there were sometimes formal relations of hospitality between State and State, so that the children of one were taught to look upon the other as their second country; but the public hospitality of which we hear most was an unequal relation—between a State or tyrant on the one side, and a family or individual on the other. A *πρόξενος* was a person who undertook to look after the interests of a foreign State in his own. He thus differed from the modern 'consul,' who, as a rule, is a person who looks after the interests of his own State in a foreign one. The *πρόξενος* was sometimes appointed by the State; sometimes he appointed himself, in which case he was an *ἐθελοπρόξενος*,¹² or honorary consul. At Athens the people appointed their *πρόξενοι*;¹³ at Sparta the appointment was one of the privileges of the kings.¹⁴ Sometimes

¹ *Od.* iv. 90, 125-132.

² 'Consuetudo erat apud maiores, ut inter se homines hospitilura mutuis muneribus copularent, vel in praesenti, vel per internuntios' (on *Æn.* ix. 360).

³ *Æn.* viii. 166 ff.

⁴ Cæsar, *de Bell. Civ.* ii. 25. 4: 'Hulc [sc. regi Jubæ] paternum hospitium cum Pompeio intercedebat.'

⁵ *De Bell. Gall.* i. 47. 4: 'Marcum Metium, qui hospitio Ariovisti utebatur.'

⁶ *Met.* i. 144.

⁷ *Noct. Att.* v. 13. 5: 'In officiis apud maiores ita observatum est: primum tutelae, deinde hospiti, deinde clienti, tum cognato, postea affini.'

⁸ Cornif. *ad Her.* iii. 4: 'Hospitia, clientelas, cognationes, affinitates.' Cf. Cic. *in Cæc. Div.* 66: 'Ab hospitibus clientibusque suis . . . iniurias propulsare.'

⁹ Cic. *Rosc. Am.* 15: 'Non modo hospitium, verum etiam domesticus usus et consuetudo.'

¹⁰ Herod. vi. 21: πόλιες γὰρ αὐταὶ μάλιστα διὰ τῶν ἡμῶν ἰδμεν ἀλλήλοισι ἐξεινώθησαν.

¹¹ i. 642 B: τυγχάνει ἡμῶν ἡ ἑστία τῆς πόλεως οὐσα ὑμῶν πρόξενος.

¹² Thuc. iii. 70.

¹³ *Ib.* ii. 29.

¹⁴ Herod. vi. 57.

there was a salary attached to the position, as we know from the Corcyraean inscription,¹ which contains an account of lands purchased by the State for the use of its *πρόξενοι*. But in most cases the office seems to have been assumed voluntarily by men of wealth and station, the attraction of international importance being reward enough in itself for the honour-loving Greek. Thus we find Alcibiades resuming the hereditary *προξενία* with the Lacedæmonians which his grandfather had for some reason renounced.² As the *πρόξενος* would naturally be a *persona grata* with the State whose interests he espoused, delicate negotiations were often conducted through him. Thus, when Mardonius wished to detach the Athenians from the cause of Hellas, it was Alexander of Macedon that he sent to them as being their *πρόξενος*.³ When, in the time of the Four Hundred, the Athenians were near coming to blows with one another while the foe was without the gates, it was mainly through the good offices of one of their *πρόξενοι*, Thucydides of Pharsalus, who happened to be present, that their rage was checked.⁴ But the action of *πρόξενοι* was not always advantageous to the State to which they belonged. Thus we learn from Thucydides⁵ that the revolt of Lesbos broke out prematurely owing to information being supplied to Athens by the *πρόξενοι* of what was going on in the island. The institution of *πρόξενοι* was a wide-spread and important feature of Greek life. Even the barbarous tribe of the Mossynœci had their *πρόξενος* in Timesitheus of Trapezus, through whom they were approached when Xenophon wished to pass through their country.⁶ The connexion of this institution with hospitality in the modern sense lies in the fact that it was at the house of the *πρόξενος* that foreign ambassadors would naturally be entertained.⁷

Among the Romans we find from the earliest times the same distinction as among the Greeks between public and private hospitality. Livy speaks of Servius Tullius as having linked himself in both ways with the leading men among the Latins.⁸ We read, too, how in the time of Camillus one Timasitheus persuaded his Liparensian countrymen, despite their piratical instincts, to let a Roman offering, which fell into their hands, get safely to Delphi; and how, in return for this service, hospitality was voted to him by decree of the Senate, and gifts were presented by the State.⁹ There is also a picturesque tale told by Livy, which reminds us of the episode of Glancus and Diomedes. The moral is the same, though the treatment is different. In 212 B.C., at the siege of Capua, there was a Roman named Crispinus and a Capuan named Badius, who were connected by ties of hospitality, insomuch that Badius had been nursed through an illness in the house of Crispinus. What, then, was the surprise of the worthy Roman to find himself challenged to single combat by his Capuan guest-friend! No taunts could make him fight, until Badius renounced the tie of hospitality. Then, by permission of his commanders, he took the field on horseback—to the shameful overthrow of his adversary.¹⁰

The year 173 B.C. is noted by Livy as marking a turning-point in the treatment of the allies in the matter of hospitality. One of the consuls of that year having previously had occasion as a private person to visit Præneste, in order to sacri-

fice in the temple of Fortune, had been mortified by receiving no marks of honour there, either in public or in private. So, when sent on a public mission with regard to the State-lands in Campania, he prefaced his coming by a letter to the Prænestines, ordering that the magistrates should come out to meet him, that quarters should be prepared for him at the public expense, and that baggage-animals should be ready for his departure. Up to this time, Livy tells us, the highest magistrates had been content with *privata hospitia* when they visited the allies, but this action served as a precedent for ever-growing demands of the same nature.¹

Turning now to hospitality as a good quality or virtue, it is obvious to remark that it is a form of good-will to men which finds most scope for its exercise, and is consequently most highly valued, in a comparatively rude state of society. The Homeric outlook upon the world makes this the criterion of praise or condemnation—

ἡ μὲν ὄσοι χαλεποὶ τε καὶ ἄγριοι, οὐδὲ δίκαιοι,
οἱ τε φιλόξενοι, καὶ σφιν νόος ἐστὶ θεοῦδης.²

In classical times it was the backward country of Thessaly that was most noted for hospitality. Xenophon³ speaks of Polydamas of Pharsalus as being 'magnificent in his hospitality after the Thessalian fashion.' Admetus, we may remember, whose virtues in other respects were not conspicuous, had this redeeming feature in his character. His house could be addressed as—

ἡ πολίτευος καὶ ἐλεύθερος ἀνδρῶν ἀεὶ πρὸς οἶκος.⁴

When Crito, in Plato's dialogue of that name, wishes to get Socrates out of prison, and to send him to his friends in Thessaly, the philosopher is made to reply with some disparaging remarks about feasting in Thessaly,⁵ implying that he was of the same opinion as that afterwards expressed by the historian Theopompus, that the Thessalians were more anxious about a well-laid table than a well-ordered life.⁶ In other parts of Greece the practice of hospitality must have been rarer, if we may judge from the story of how Miltiades in the time of Pisistratus became tyrant of the Chersonese. Some Dolonkian envoys to Delphi had been instructed by the oracle to take as a new founder of their State the first man who offered them hospitality after they left the temple, and they traversed the whole of the Sacred Road through Phocis and Bœotia without receiving an invitation; it was not till they turned aside to Athens that Miltiades, seeing them as he sat in his doorway, shouted to them to come in; and, after he had entertained them, they communicated to him the oracle, and pressed their leadership upon his acceptance.⁷ The importance attached to hospitality in uncivilized communities is due to that instinctive perception of the needs of men which underlies ethics. In a more developed society it becomes a rich man's virtue, a kind of moral luxury, rather than a necessity. By Aristotle it is brought under the head of 'magnificence,' which displays itself, among other things, in the reception and dismissal of strangers.⁸ Magnificence is a civic virtue, and the entertainment of illustrious guests is a glory to the State, on which grounds Cicero remarks: 'recte etiam a Theophrasto est laudata hospitalitas.'⁹ In the *Economicus* of Xenophon, where the burdens upon the rich at Athens are being discussed, special mention is made of the social necessity of entertaining many foreign guests, and that too magnificently.¹⁰ The obligations of nobility in this respect were so well recognized at Athens that Solon includes a foreign guest among the

¹ Böckh, *CIG* ii. 17, *Inscr.* 1840.

² Thuc. v. 43, vi. 89.

³ Herod. viii. 136-143.

⁴ Thuc. viii. 92. 8.

⁵ *Ibid.* iii. 2. 8.

⁶ Xen. *Anab.* v. 4. 2.

⁷ Xen. *Hell.* v. 4. 22.

⁸ Liv. i. 45. 2: 'Inter proceres Latinorum, cum quibus publice privatimque hospitia amicitiasque de industria iunxerat.'

⁹ *Ibid.* v. 23. 5: 'Hospitium cum eo senatusconsulto est factum doneque publice data.'

¹⁰ *Ibid.* xxv. 18. 9.

¹ Liv. xlii. 1.

² *Hell.* vi. 1. 2 f.

³ Plato, *Crito*, 53 E.

⁴ Herod. vi. 84 f.

⁵ *Dr Off.* ii. 64.

⁶ *Od.* viii. 575 f.; cf. ix. 176 f.

⁷ Eurip. *Alc.* 569.

⁸ Athen. xii. 83, p. 527a.

⁹ *Eth. Nic.* 1123^a 3.

¹⁰ *Ce.* ii. 5.

appanages of the rich and happy man, on a level with his children, horses, and hounds—

Ἰαβίος, ὃ παῖδες τε φίλοι, καὶ μῶνυχες ἵπποι
καὶ κύνες ἀγρευταί, καὶ ξένος ἀλλόδαπος.¹

In the *Meno* of Plato also 'to know how to receive and dismiss fellow-countrymen and strangers in a manner worthy of a good man'² is reckoned among the accomplishments of an aspirant to public life. Callias, the son of Hipponicus, was celebrated at Athens for his princely hospitality; and at Sparta, Lichas, who was πρόξενος to the Argives, but extended his welcome to all strangers who were present in Sparta at the Gymnopædiæ.³

LITERATURE.—In addition to the sources cited in the article, see the treatment of the subject in Smith's *Dict. of Gr. and Rom. Ant.*, by W. Wayte, L. Schmitz, and H. Hager; and in R. von Ihering's 'Gastfreundschaft im Altertum,' in *Deutsche Rundschau*, 1887.

ST. GEORGE STOCK.

HOSPITALITY (Hindu).—Under the conditions of Hindu law and social usage the exercise of hospitality in the ordinary sense of the term, when the host shares with his guest a meal or provision which he has himself furnished, is necessarily precluded. A rigorous and minutely divisive law of caste has long forbidden in India that the stranger, or one not born within the inviolable and usually narrow limits of the caste (*jāti*, 'birth'), should be welcomed to a place at the family meal. In this aspect of the subject, eating in common is entirely repugnant to Hindu feeling and thought; it is inconceivable and impossible that members of different castes should partake together of the same food. And the rule or prejudice, together with that against intermarriage, will be among the last to yield to the solvent of European practice and example.

In all other respects the duty of hospitality is fully recognized, and, subject to this important limitation, adequately discharged by all Hindus. Probably in no country in the world may the passing wayfarer be so confident that his needs will be met in whatever village he may find himself, although the provision will not go beyond the minimum of his requirements. Consideration for a guest is enjoined in the sacred Law-Books of India as an important part of the duty of a householder. It is true that it is generally assumed that the guest will be a Brāhman. In practice, however, the interpretation which has been given by the people themselves to their obligation has not limited it to one caste or group of castes to the exclusion of all others. The Brāhman has always had the prior claim for the supply of his needs, whether in respect of food or of aught else; but the demands of hospitality are not repudiated by whomsoever they may be presented, though these others will be entertained with less satisfaction and with considerable abatement of ceremony.

A further condition which impedes the free intercourse and social communion which the dispensing of hospitality in the European sense of the term involves is that to the Hindu eating is a solemn and sacred religious act. Hence both the preparation and the partaking of food are hedged about with restrictions designed, in the first instance, to secure the ceremonial purity both of the food itself and of him for whom it is provided. To admit a stranger to a share in the meal, or even to allow the motions and acts of eating to be seen by another, would involve an almost certain risk of pollution. No strict Hindu will voluntarily and under ordinary circumstances eat otherwise than in private. A free and open hospitality, therefore, such as obtains in many countries, which invites the guest to an honoured place at the board, is, from this point of view, precluded by religious sentiment no less than by social custom.

¹ Frag. iii., Gaisford.

² 91 A.

³ Thuc. v. 76. 3; Xen. Mem. i. 2. 61.

Apart, therefore, from anniversaries and festivals, and from private occasions for rejoicing, as a wedding or the birth of a son and heir, the lavish entertainment of guests on the part of wealthy natives of India, and of others according to their means, is limited to the feasting of Brāhmans, and the making provision for the poor at an open meal at which all comers may receive a share without question asked. In the latter case the distribution frequently takes the form of a money dole in place of or in addition to the food prepared. All such acts and gifts secure for the donor religious merit, and are often thank-offerings for public or private good fortune or success. They are evidently also more of the nature of alms or charity, the recipients being in poverty and real need of the benefaction, than of true hospitality (see art. CHARITY [Hindu]). The most recent instance of such donations has been the generous gifts for the poor placed at the disposal of Lord Hardinge, the Viceroy of India, in token of thanksgiving for his recovery from the attempt made upon his life at the Delhi Durbar of 1912.

In the formal and elaborate feasting of Brāhmans also the relation of host and guest is of a different nature. The sacred character of the Brāhman places him on a level socially and religiously above that of his host; and the latter may not, and does not, eat until his guests have been satisfied; nor would it be in accordance with usage or social right that he should sit down with them to a common meal. Thus to provide for the wants of members of the higher caste is a sacred duty incumbent upon the Hindu householder which is repeatedly enjoined in the Law-books.¹ The obligation has often pressed hard upon the less wealthy members of Hindu society, and has been a not inappreciable or ineffective cause of the wide-spread indebtedness which has overtaken in the past so many classes of the Indian people. Usage and custom, fortified by religious sanction, has demanded an expenditure in the entertainment of guests at festivals or important events in the family life which has left the householder permanently and hopelessly impoverished; nor can real benefit be said to have accrued to any one from the practice, least of all to those members of the higher castes whom it has encouraged in a life of slothfulness and dependency. Nevertheless, the obligation has been generously recognized throughout the whole course of Indian life and history. And, if in part during recent years the responsibility has been somewhat less scrupulously interpreted and acted upon, the result is due to the general loosening of the bonds of a social system which is found to be out of harmony with European conceptions, and incompatible with the relations of a world-wide Empire.

LITERATURE.—There is no special or distinctive literature. See the works cited in art. ASCETICISM (Hindu), CHARITY (Hindu), HINDUISM.

A. S. GEDEN.

HOSPITALITY (Iranian).—The obligation and the duties of hospitality appear to be taken for granted in the Avesta and Pahlavi writings, and no word for 'hospitality' is recorded.² At the

¹ Cf. Manu, iii. 72: 'He who does not feed these five, the gods, his guests, those whom he is bound to maintain, the manes, and himself, lives not, though he breathes'; *ib.* 99 f.: 'Let him offer, in accordance with the rule, to a guest who has come a seat and water, as well as food, garnished according to his ability. A Brāhmaṇa who stays unhonoured (in the house) takes away all the spiritual merit [of the householder].' The Brāhman guest was always to be held in higher esteem, and given precedence in the entertainment of a member of a lower caste; the latter also was to be fed, but in this case hospitality was not obligatory, although apparently it was always recognized to be meritorious, and an indication of the good-will and virtue of the giver. See Manu, iii. 102-117 and iv. 29, on the duties of a householder.

² Kanga (*Eng.-Av. Dict.*, Bombay, 1909, col. 260) gives as equivalents of 'hospitality,' *raše-iti* and *vaše-yāiti* (occurring

same time, it is indicated that, when one friend visited another, he brought a gift to his host (*Yasna* lxii. 8). The duty of giving not merely contentment, reward, and thanks (*xšnūti*, *areti*, *vyādā*), but also welcome (*paiti-zanti*), to a righteous man is declared, in *Pursišnihā*, xxxix. (ed. J. Darmesteter, in *Zend-Avesta*, Paris, 1892-93, iii. 70), to be one of the three earthly things best for Ahura Mazda; and the duties of friendship—which is scarcely possible without some form of hospitality—are mentioned in the *Avesta* (*Yasna* xliii. 14, xliv. 1, xlvi. 2; *Vendīdād*, iv. 44-46), with special reference to the obligation of friend to succour friend. In a like spirit, generosity (*frārāti*, *rāti*) is lauded (*Yasna* lv. 3, lviii. 4, lx. 5; *Višparad*, xxi. 3; *Pursišnihā*, xxvi.), and is the greatest of good works (*Dinā-i Mainōg-i Xrat*, iv. 4, xxxvii. 4, tr. West, *SBE* xxiv. [1885] 26, 73), while illiberality is a sin (*Vendīdād*, xviii. 34; cf. *Artā-i-Vīraf Nāmak*, xciii., ed. and tr. Haug and West, Bombay, 1872). More than this, the spirit in which the gift is made is of the utmost moment. Accordingly, *Nirangistan*, lxxxiv. (ed. Sanjana, Bombay, 1894, fol. 161, l. 10-fol. 162, l. 27; Darmesteter, *Zend-Avesta*, iii. 133 f.), declares:

'Woe to him, Spitama Zarathuštra, who gives alms when his soul is not joyful over almsgiving; for in alms lies for all the corporeal world the decision for good thoughts and good words and good deeds' (tr. C. Bartholomae, *Altiran. Wörterb.*, Strassburg, 1904, cols. 1544, 733), adding that the best of all libations (*zaōthra*) is to the teacher of religious truth.

Of the actual forms of Zoroastrian hospitality we may have a glimpse in *Yast* xxiv. 62-64 (expanded in *Dinā-i Mainōg-i Xrat*, ii. 147-156), which states that, when the soul of the righteous man arrives in the heaven of Endless Light, it is met by the righteous dead (and by 'angels and archangels of every description'), who begin to ask it various questions, whereupon Ahura Mazda bids that it have food and repose after its journey, and a seat on a richly adorned throne. Even in hell the soul of the wicked receives food of filth before it is permitted to answer the questions of the older denizens (*Dinā-i Mainōg-i Xrat*, ii. 183-192). Similarly, *Artā-i-Vīraf* declares (iii. 16 f.):

'To give the hungry and thirsty food, is the first thing, and afterwards to make enquiry of him, and appoint his task.'

It was customary for the host to rise when greeting a guest (*ib.* xi. 1; *Vendīdād*, xix. 31).

The Greek authors add practically nothing to our knowledge of hospitality in ancient Persia, although there are repeated indications that wine was drunk to excess at banquets, and even that courtesans were admitted to them (Herod. i. 133, v. 18; Xenophon, *Cyrop.* viii. viii. 10; Est 17^a. 5^o 7^a 11^o; for abundant classical references to Persian banquets, see G. Rawlinson, *Fifth Orient. Monarchy*, London, 1862, ch. iii.; A. Rapp, *ZDMG* xx. [1866] 101 ff.; cf. also B. Brisson, *de regio Persarum principatu*, ed. Lederlin, Strassburg, 1710, pp. 104, 223, 311, 465 ff., 797 f.; B. W. Leist, *Alt-arisches Jus civile*, Jena, 1892-96, i. 52).¹

By far the best source for the details of Iranian hospitality is the *Sāh-nāmah* of Firdausī (tr. Mohl, Paris, 1876-78). The great majority of the instances describe, it is true, the scenes in royal circles and the receptions accorded to ambassadors, but there are also accounts which show that the hospitality of the humbler classes differed in degree rather than in kind.

In general, if the guest was in rank inferior to his host, he respectfully saluted him (i. 234, 257), whereas, if the two were of equal rank, the host respectively in *Yasna* liii. 9 and xli. 8); but both words mean simply 'going as one wishes,' 'freedom of motion.'

¹ The statement of Kohler (*ZVRW* v. [1884] 336, note 2), that the Massagetae, who were an Iranian people (J. Marquart, *Erānsahr*, Berlin, 1901, p. 156), showed hospitality by lending their wives to their guests, is based on an erroneous interpretation of Herod. i. 216 (cf. Strabo, p. 513), who says merely that these Iranians practised communal marriage.

went to meet his guest (ii. 12, 58). It was a disgrace for the guest of honour to be seated at the left of his host (iv. 492). The host drank first if he was older and wiser than his guest, but the latter had precedence if he was of higher rank (v. 358). Intoxication at banquets, to which reference has already been made, is repeatedly mentioned by Firdausī (e.g. ii. 60, iii. 249, iv. 505).

The mode of procedure in royal hospitality may be illustrated by Firdausī's description of Rustam's return to the court of Kai Xusrau (iii. 211-214; cf. also i. 234-237, 257-267, ii. 59-64, 282 f., 423-428, iii. 229-231, 323-326, iv. 474-480, vi. 50-54; and, for a description of the hospitality shown ambassadors from a foreign potentate, v. 291 f.).

When the king learns that Rustam is approaching, he leaves the palace, while the people prepare feasts, adorned by wine, music, and singers. The monarch, with a great retinue, proceeds, scattering largess to the populace, until he reaches Rustam, who dismounts and salutes him. Xusrau embraces him and causes him to remount, and they return, conversing, to the palace. There Rustam is seated beside the king, who converses with him and his companions. Next follows the banquet, with wine and music. For a month the festivities continue (in other cases hunting and games add to the enjoyment), and at the end of that time Rustam announces his wish to depart. Thereupon, Xusrau bestows rich presents upon him, and accompanies him a two days' journey, when Rustam again dismounts, and takes formal leave of the king, who returns to his palace.

Among the middle classes the usages were not dissimilar. Bahrām Gūr, in disguise, knocks at the door of a jeweller. He is at once admitted most hospitably, and is entertained at an impromptu feast, after which come wine and music, the cup-bearer and lutist being the host's beautiful daughter, whom the guest, whose identity is known only on the following day, promptly espouses (v. 506-511).

In the Persian stratum of *The Thousand Nights and One Night* (tr. Payne, London, 1882-84) are a number of descriptions of hospitality as exercised at Baghdad under the Abbāsid dynasty (e.g. i. 74-83, ix. 31, 47-49). These throw a welcome sidelight on the descriptions in the *Sāh-nāmah*, and, though both works were composed in Muhammadan surroundings, it is probable that they contain in their accounts a considerable amount of genuine Iranian material.

The humblest classes were equally hospitable, as is illustrated by the adventure of Bahrām Gūr with Lanbak, the poor water-carrier, and the rich Jew, Baraham (*Sāh-nāmah*, v. 450-459).

It was the habit of Lanbak to devote half the day to his calling, and then to seek a guest; and it was his principle to have nothing left over for the next day. Having discouraged the people from purchasing from Lanbak, the king rides in disguise to his house, where he is warmly welcomed, and, after a game of chess, is entertained at table, the meal being followed by wine. Bahrām passes the night as Lanbak's guest, and is besought to remain another day. Since Lanbak is still unable to sell water, he parts with some belongings and purchases food, which he himself prepares for his guest. The third day he urges Bahrām to remain, and pawns his water-bags for the meal which the two prepare; and it is with reluctance that he permits his unknown guest to depart on the fourth day, after having urged him to remain two weeks longer. Bahrām next tries the hospitality of the rich Jew, only to be received with niggardliness and indignity; and he therefore bestows on Lanbak the wealth of Baraham (for other instances, see v. 357-360, 488-493 [where the hospitality of the wife is contrasted with the inhospitality of the husband], vii. 140 f.).

On the other hand, the vice of inhospitality also existed, not only among the poor (v. 489 f.), but also among the miserly rich (v. 519-23).

In Dailam (corresponding roughly to the modern Gilan), it was customary for all the household to withdraw excepting one, who, at a distance, waited upon the guest, who could thus assuage his hunger and thirst, the host scarcely venturing to appear even at the conclusion of the meal (*Qābūs-nāmah* [11th cent.], xii., tr. Querry, Paris, 1886, p. 125 f.). To this al-Makdisī adds that it was not the usage in Dailam to sell bread, but that any stranger might enter a house and get what food he needed; while Ibn Fadlān records similar customs in Khvārizm, and in Arabic anthologies the Persian word for 'guest' is rendered as 'master of the whole house' (Inostrancev, *Sasanidskiye Yetyudy*, St.

Petersburg, 1909, p. 132 f., and the references there given).

Modern Irān is so thoroughly Muḥammadanized that it is difficult to distinguish between Iranian and Islāmic elements. Nevertheless, the following account of hospitality as shown by a relatively primitive Iranian people—the Kurds—may be cited from Soane's *To Mesopotamia and Kurdistan in Disguise* (Boston, 1913, p. 40 ff.):

'They told me that the best room in the place was at my disposal. . . . They possessed little enough of the world's goods, but their best fowl was sacrificed to the occasion, eggs in numbers sufficient for ten men were produced. Every one of them except the headman, who sat by as host, busied himself about something. . . . Surplus eggs they hard-boiled and put up for my journey next day.' Somewhat disconcerted by the evident intention of a young tradesman and his wife to pass the night in the same room, Soane was informed that this was necessary since the whole village possessed but two rooms fit to sleep in; and since he passed for a Kurd 'and a guest, I must excuse their presumption in occupying the room, which was my exclusive property.' Early in the morning he was awakened by his host's wife, who 'herself carried out the small luggage to the carriage, and then two or three villagers turned out and loaded up the heavy things. Last of all, the headman appeared, and, as we drove away, the sound of his hearty, rough farewells rang in my ears.'

LITERATURE.—This has been cited in the course of the article. There seems to be no special treatise on the subject.

LOUIS H. GRAY.

HOSPITALITY (Japanese and Korean).—I. JAPAN.—I. Primitive and mythological period.—The Japanese are a very hospitable people. This spirit is already apparent in their mythology, which reflects the customs of primitive times. One of the earliest cosmogonic myths tells of the great hospitality offered by Uke-mochi-no-kami, the goddess of Food, to Tsuki-yomi-no-mikoto, the Moon-god (see art. COSMOGONY AND COSMOLOGY [Japanese], vol. iv. p. 165*).

It may be noticed in this story that the rice, fish, and game which the goddess 'prepared and set out on one hundred tables for his entertainment' had all come out of her own mouth. This may be a reminiscence of the early times when it was the custom among certain tribes which can claim some connexion with Japanese origins to chew the food of guests in order to soften it (cf. the Polynesian custom [A. Réville, *Religions des peuples non-civilisés*, Paris, 1883, ii. 106])—a hypothesis strongly supported by the existence, even in the 8th cent., of a body of *ihikami*, or 'chewers of boiled rice,' mentioned in the *Nihongi* (i. 104, Aston's tr., London, 1896) among the various groups of women who looked after the little princes of the Imperial house.

The same spirit of unlimited hospitality appears in many passages of the most ancient sources. When Ōho-yama-tsu-mi-no-kami, god of the Great Mountain, was visited by the divine prince Ninigi, the grandson of the gods, he offered him 'merchandise carried on tables holding an hundred' (*Kojiki*, tr. Chamberlain, new ed., Tokyo, 1906, p. 141); and, when the god of the Ocean, Ōho-wata-tsu-mi-no-kami, saw Ho-wori-no-mikoto (His Augustness Fire-Subside) at his door, he immediately 'led him into the interior [of his submarine palace], and spreading eight layers of rugs of sea-asses' [*michi*, perhaps the sealion, or a species of seal] skins, and spreading on the top other eight layers of silk rugs, and setting him on the top of them, arranged merchandise on tables holding an hundred, made an august banquet,' etc. (*ib.* 148).

In these two texts, the reception is preliminary to a marriage, and it has been thought that the presents thus offered were a sort of dowry given by the father; but we see from a variant of the first account, which says that the god of the Great Mountain 'sent his two daughters with one hundred tables of food and drink to offer them respectfully' (*Nihongi*, i. 84), that it was, in the first instance, a question of presents of welcome and the classical meal of hospitality.

Another legend, which is peculiarly significant, shows us Susa-no-wo, the Storm-god, after he has been expelled from heaven because of his crimes against the Sun-goddess, wandering about the earth under a huge hat and a cloak of green grass in search of a shelter for the night (cf. *Nihongi*, i. 50). In his distress he asks a rich miser, Kyotan Shorai, for hospitality, which he refuses; but the

miser's elder brother, Somin Shorai, though a poor man, makes a bed of millet-straw for the traveller and gives him some cooked millet to eat. The god goes away. Some years afterwards he reappears. 'Are your children at home?' he asks Somin. 'There are here,' he answered, 'myself, my daughter, and my wife.' The god replied: 'Encircle your loins with a belt of rushes.' And that very night the god exterminated all mankind except Somin Shorai and his family. Then he said to Somin: 'I am the god Susa-no-wo. If any infectious disease should break out, let your descendants tell their name and girdle their loins, and they will be spared.' Hence, it is said, the New Year custom of hanging a cord of straw (*shime*) over the doors of houses in order to prevent disease from crossing the threshold. This tradition, which is found in a very ancient work, the *Bingo Fudoki*, 'Topography of the province of Bingo' (see Florenz, *Nihongi, Zeitalter der Götter*, Tokyo, 1901, p. 302), and exists to this day in the locality (see Murray's *Handbook for Japan*, ed. 1884, p. 177), shows clearly to what an extent hospitality was considered a sacred duty.

2. Historical period.—Passing now from the primitive period and its legends to the historical period, we find the same hospitable customs in the dealings of the Japanese with strangers to their archipelago. No doubt, following a universal habit (Frazer, *GB*² i. 150), they took certain steps to secure themselves from the demons, *i.e.* epidemics, which the strangers might bring with them; thus, two days before the arrival of foreign envoys in their capital, the Japanese performed a ceremony in honour of the Sahe-no-kami, 'preventive deities' of a phallic description, to ward off evil influences (*Engishiki* [10th cent.], *norito* 13). Nevertheless, the Japanese attitude towards strangers was by no means hostile; it was with a kindly curiosity that they saw strangers come among them, and they offered them a home. All ancient Japanese history is full of stories of how the court gladly welcomed the Koreans, who brought interesting innovations with them—to enumerate the instances would be to relate the whole development of Chinese civilization in Japan, from the introduction of writing (*Kojiki*, 313) down to the introduction of Buddhism itself (*Nihongi*, ii. 66 f.). Even the national gods exhibited a hospitality to foreign gods, and even before the introduction of Buddhism more than one Korean deity had been admitted to the Japanese pantheon (see *Kojiki*, 324; *Nihongi*, i. 169).

The same welcome was accorded the Europeans when they in their turn presented themselves to these distant islands. The Portuguese who landed in Japan, first at Jinguji-uri in 1541, then at Tanegashima in 1542, were received with kindness (see H. Nagaoka, *Histoire des relations du Japon avec l'Europe aux xvi^e et xvii^e siècles*, Paris, 1905, pp. 33, 36, etc.). St. Francis Xavier, who landed at Kagoshima in 1549, was very courteously received by the prince of Satsuma, even although he was the bearer of a foreign religion. At their very first interview, the prince gave him permission to preach the Christian faith in his territory, and, a few days later, sent out letters-patent in virtue of which all his subjects were at liberty to become Christians if they so desired. As a matter of fact, this local prince was not entirely disinterested: he was anxious to enter into relations with the Portuguese and to win over their vessels with a view to commerce, as was clearly shown by the fact that his attitude entirely changed when the saint wished to leave his territory. It cannot be denied, however, that the prince's first welcome was a really generous one—especially if we remember all the difficulties he might have had to

face with regard to the bonzes. The prince of Hirado afterwards received St. Francis Xavier 'with much affection and a good grace,' to use the saint's own words (Letter of 1551). Then at Yamaguchi, the prince made the saint come to him, questioned him graciously before his whole court, asked him where he came from and what he wanted, listened to his doctrine for a whole hour, and allowed him thereafter to preach the gospel with absolute freedom; a little later he presented the saint with a vacant monastery, and published it abroad throughout the town that he had authorized him to propagate his faith. Even in Kyōto, the capital, though St. Francis and his companions could not get an audience of the Emperor, the *shōgun*, or even the chief of the Buddhist Church, yet they were never molested. Finally, the prince of Bungo, the last of the federal princes that Francis had occasion to visit before leaving Japan, wrote letters to the saint saying such things as:

'I beseech you to come immediately, before the sun rises, and knock at the door of my palace where I shall await you with impatience. . . . Give me news of your health so that I may sleep well throughout the night, until the cocks awake me announcing your arrival' (D. Bouhours, *Vie de S. François-Xavier*, Paris, 1682, ii. 64).

In short, during the two and a half years which the first apostle of Christianity passed in Japan, he was treated with a tolerance and good-will which would have astounded Europe; and this explains the delusion which sprang up in his mind 'that a nation so polite and judicious would easily be won to Christianity' (Bouhours, ii. 58).

The persecutions which Christian missionaries had to suffer later do not prove anything against the hospitable spirit of the Japanese. In 1565 the Jesuit Fathers Froez and Vilela were received with honour by the *shōgun* Yoshiteru himself. In 1568, when Father Organtin arrived at Nagasaki, the powerful Nobunaga put a Buddhist temple at his disposal to stay in, and offered him banquets for three days. Why did this same Nobunaga afterwards regret giving this protection to the new religion? And why did Hideyoshi, his successor as dictator of Japan, after first taking the Christians under his protection at Osaka, finish by harshly proscribing Christianity? Because the missionaries made the mistake of involving themselves in the local politics of the feudal princes, causing trouble among the people as a consequence, and finally disturbing the central government. But, in the same edict of 1587 which ordered all the missionaries to leave Japan within twenty days, Hideyoshi decreed that the 'black ships' (i.e. the Portuguese) which came for purely commercial purposes might continue their traffic, and, in another edict of the following year, he recommended his subjects to continue to receive them well (see Suganuma, *Dai Nihon Shōgyō-shi, History of the Commerce of Japan*, pp. 324-326). Finally, Hideyoshi's successor, the great *shōgun* Iyeyasu, who had also begun by showing himself favourable to the Christians, was forced, by new intrigues of the Portuguese Jesuits and Spanish Franciscans and Dominicans, to withdraw his good-will and to decree, in a proclamation of 1614, that 'these must be instantly swept out, so that not an inch of soil remains to them in Japan on which to plant their feet' (see J. H. Gubbins, 'Review of the Introduction of Christianity into China and Japan,' in *TASJ* vi. pt. i. [1888] p. 48). These measures culminated finally when Iyemitsu, the third Tokugawa *shōgun*, by his notorious edicts of 1633 and 1636, laid Christianity under the ban.

Thus, if the religious politics of the Japanese seem to have been an exception to their proverbial hospitality, it was only so from the time when the Roman Catholic missionaries, forgetting discretion

in their zeal, abused this hospitality. The Japanese were willing to be converted; they would not be conquered. The necessity of defending themselves against this religious invasion had the additional effect of calling forth, in the above-mentioned edicts of Iyemitsu, a limitation of the commercial relations which seemed indispensable for the general tranquillity of the country and the solidity of its political system. But this limitation, inspired by legitimate considerations of public safety, did not prevent the Japanese from offering hospitable treatment to the foreigners who came for the single purpose of peaceable commerce; this explains why Holland had almost the monopoly of foreign commerce at Nagasaki till the Revolution of 1868.

3. Modern period.—In the modern period the same spirit may be observed. The Japanese Government employed every means of protection against dangers from America and Europe; it confined the residence and commerce of foreigners to certain open ports and required passports for journeying to the interior, in order both to keep a watch over their movements and to obtain from the foreign powers, in exchange for a more complete freedom for their subjects, the abnegation of the unjust treaties that had been imposed upon them since 1854. When this diplomatic end was attained, i.e. at the end of the year 1899, Japan was opened up anew to foreigners under ordinary conditions. As for the ancient prohibitions against Christianity, they had long fallen into desuetude, the Japanese continuing, as of old, to welcome all religious novelties, provided they do not cloak political schemes. The history of Japan, then, exhibits a remarkable spirit of hospitality among its inhabitants, in spite of the opposite impression made by a superficial observation of the anti-Christian persecutions; a knowledge of the causes of these persecutions reduces their significance to vanishing point, and shows the Japanese character in its true light.

To-day a foreigner travelling in the interior of the country may still find the ancient hospitality, which was never eclipsed except by the fault of those who were the first to profit by it. The present writer can bring his personal experience to witness. One night in 1896, when travelling in Yamato, he found himself lost in the open country. After walking for a long time in the dark and in drenching rain in search of a village where he might find a means of transport, he arrived at a peasant's hut and knocked at the door. Imagine a Japanese travelling in the country in Europe and arriving at midnight at a peasant's house: there would be furious barking from the watch-dog, hostile suspicion of the unknown wanderer on the part of the master of the house, and, to put things at their best, a poor shelter offered at last, with no good grace, in some outhouse. The Japanese cottage, on the other hand, was opened immediately; the father and his family all got up to receive the stranger on their knees; they were very pressing in their offers of a bath and a friendly meal. After this came the classic questions in Homeric style: 'Honourable stranger, whence comest thou? Whither goest thou? What is thy country?' and so on. Finally, when the guest was ready to depart, the father sent two of his sons several miles distant to bring a *jinrikisha* and runners to carry him to Kyōto. It is hardly necessary to add that these poor peasants would not take any remuneration, and the only way in which their guest was able to repay them at all was by discreetly making presents to the youngest members of the family.

II. *KOREA*.—Korea, on the other hand, is quite different. This country, so inaccessible to the foreigner, has been well named 'the hermit nation.' The accounts of missionaries, from the *Relation de*

l'établissement du christianisme dans le royaume de Corée, ed. by de Gouvea, bishop of Peking, in 1797 (in *Nouvelles lettres édifiantes*, v. [1820]), to the *Annales de la propagation de la foi* (from vol. vi. [1833] to the present day), speak of nothing but persecutions which, like those of 1839 and 1866, were accompanied by terrible massacres; and show us also how different their reception was from their first welcome in Japan, the missionaries having had all sorts of difficulties in getting into Korea and being forced to live a secluded life in order to escape being put to death. It is only in virtue of comparatively recent treaties that the diplomatic relations drawn up with the Koreans have led to the opening up of their country (1887). A Japanese traveller, who risked his life in Korea in 1875, gives a picturesque account of his journey. Though dressed in Korean mourning-costume, the broad hat of which covered his face, he had to take the greatest precautions in order to escape recognition as a stranger when going about the interior. In order to escape notice he had bravely to eat the most repugnant rancid food in inns, to sleep on a sort of stable litter in peasants' huts of the most filthy description, while the idea of having a bath was simply out of the question (see W. J. Kenny, 'Account of a Secret Trip in the Interior of Korea,' in *TASJ* xi. [1883] pt. ii.). It is only necessary to compare this account, of the end of the 19th cent., with those of the missionaries who visited Japan in the 16th, in order to measure the gulf which, from the point of view of hospitality, separates these two civilizations.

LITERATURE.—This is given throughout the article.

MICHEL REVON.

HOSPITALITY (Semitic).—Hospitality among the Semites and Eastern peoples in general rests upon religious sanctions (see *ERE* v. 725). 'To be inhospitable was not only to be despicable, it was also to be irreligious. Hospitality was a sacred duty' (Day, *Social Life of the Hebrews*, p. 170).

I. IN BABYLONIA AND EGYPT.—**1. Religious aspects.**—Hospitality was practised by the gods themselves. According to the myth of Adapa, food and water of life, garments, and oil were brought to the hero when he arrived before Anu. Acting on the advice of his father Ea, who feared that the food and water might tend to death instead of life, Adapa refused these, but accepted the garments and oil (R. W. Rogers, *Cuneiform Parallels to the OT*, New York, 1912, pp. 68, 74, 76). It was inculcated by that part of the ritual which was concerned with the offering of gifts to the gods, and by the cult of the dead, which at the outset required that hospitality should be rendered to the corpse in the form of decent burial, and was continued in the supply of food and drink to the deceased. According to the Book of the Dead, the heart which is righteous and sinless addresses the gods of the under world thus:

'I have given bread to the hungry man, and water to the thirsty man, and apparel to the naked man, and a boat to the [shipwrecked] mariner. I have made holy offerings to the gods, and sepulchral meals to the *khus*' (E. A. W. Budge, *Book of the Dead*, London, 1901, il. 372 f.).

A Bab. didactic poem enjoins:

'Give food to eat, give wine to drink. . . . With him who thus acts his god is pleased, he is pleasing to Shamash, he will requite him with good' (Rogers, p. 175 f.).

2. Social aspects.—Hospitality was practised by the community, among those who dwelt together within the walls of the same city. The Egyptians were a pleasure-loving people, and scenes of feasting and banqueting figure in their pictorial remains. The Babylonians and Assyrians, while more staid, also held festive assemblies. As early as the days of Hammurabi (c. 2000 B.C.) we read of laws for regulating wine-shops (Code, §§ 108–111), with evidence that conviviality might be carried to excess (§ 109). The penalty of exile from the city

(§ 154) implies that the fugitive was placed out with the laws of hospitality as well as the laws of the State (cf. Gn 4¹⁴). The curses attached to the *kudurru*, or boundary-stone inscriptions, reveal the same disability in one who has been guilty of violating such landmarks, even while he continues to live within the city:

'Like a dog (may he) pass the night in the streets of his city'; 'seeing angry faces and holding out his hand, without being fed, may he wander through the streets of his city' (W. J. Hinke, *A New Boundary Stone of Nebuchadrezzar I.*, Philadelphia, 1907, p. 60).

3. International aspects.—We are indebted to the Tell el-Amarna Letters for a life-like picture of international relations in the middle of the second millennium B.C., with numerous indications of hospitality, or rather its opposite.

(a) Kings did not themselves travel into the countries with which they held intercourse, but sent their *ambassadors*, and gave *hostages*, the hospitable reception and treatment of whom was essential to the maintenance of friendly relations. There is clear evidence that considerable strain was put upon the patience of one of the parties by detention of messengers, lack of information regarding those given in marriage, and especially shortcoming in the matter of presents. Burra-buriash, king of Babylon, apologizes to the king of Egypt for not having received his envoy at his own table, and given him food to eat and wine to drink, on the ground that his health was not good at the time. He further reproaches his brother, the king of Egypt, because he had not comforted him in sickness, nor sent an envoy to inquire after his condition (*Tell el-Amarna Letters*, Berlin, 7; cf. 2 K 20¹²). A striking accompaniment of national intercourse is the *transit of images* of the gods, that of the goddess Ishtar travelling into Egypt (*ib.*, London, 10), while some time later (13th cent.) that of the Egyptian god Khonsu travelled to the land of the Hittites to effect the cure of the king's daughter. It goes without saying that the images were to be honoured, and that those who attended them were to be hospitably treated. The image of the great Amen himself journeyed with Unamon to Phœnicia (c. 1100 B.C.), but in the decay of Egypt's power failed to win respect as aforesaid and a favourable reception for the envoy. Probably the first *State visit* on the part of a king is that chronicled of Khattusil II., king of the Hittites, who journeyed to Egypt (c. 1266 B.C.) to attend the marriage of his daughter to Rameses II. (H. R. Hall, *The Ancient History of the Near East*, London, 1913, p. 371 f.).

(b) The *petty rulers* of Palestine and Syria represent their discharge of the obligations placed upon them by the king of Egypt as hospitality. Akizzi of Katna gave to the king's soldiers food, drink, oxen, sheep, honey, and oil (*Tell el-Amarna Letters*, London, 36). Aziru, the rebel son of Abd-Ashirta, professes to have treated Hani, the envoy of Egypt, with due respect, lending him horses and asses for his journey, while his brethren supplied him with cattle, sheep, fowls, food, and drink (*ib.*, London, 35). The faithful Rib-Addi of Byblos reports that upon returning from Berytus to his own house he found it barred against him (*ib.*, London, 16).

(c) To *traders* a measure of hospitality was extended. After the conquests of Thothmes III. there were good roads made throughout Syria, 'furnished with post-houses where food and lodging could be procured' (A. H. Sayce, *Patriarchal Palestine*², London, 1912, p. 180). Traders availed themselves of these routes, and travelled securely. Later, when the land became disturbed, caravans were plundered and merchants robbed and slain (*Tell el-Amarna Letters*, Berlin, 7 and 8).

(d) Akiya, a king's *messenger*, on the way to Egypt, bears a passport (*ib.*, London, 58; cf. Neh

27). A postscript to one of the cuneiform letters found at Taanach (dated 14th cent. B.C.) reads *maš-ru maš-ru*, 'Highway, Highway' (i.e. for the messenger) (Rogers, 283; cf. L. B. Paton, *Syria and Palestine*, London, 1902, p. 56 f.).

4. Hospitality towards tribes and peoples.—In the prologue to Hammurabi's Code of Laws the king claims to have sheltered the people of Malgi in misfortune (col. iv. 11-13). Such royal hospitality is seldom disinterested. Thus, Sennacherib exalts Padi, king of Ekron, over the townsfolk who had committed wickedness, but at the same time exacts tribute from him (Taylor Cylinder, iii. 4-11). The Cylinder of Cyrus represents this king as a benefactor to Babylon and its people (l. 25 f.).

5. Hospitality to nomads.—The desert tribes, who in later times afford the most evident instances of the virtue of hospitality, at this epoch appear rather as marauders, a scourge to settled communities and to traders (especially in the Tell el-Amarna Letters). Yet the Egyptian government was at times tolerant to them, as appears in the permission given to the *Mentiu*, or nomads, to settle in a prescribed district (reign of Horemheb, XVIIIth dyn.), and to the *Shasu*, or Bedawin, to pass within the eastern borders of the land of the Pharaoh, Menephtah II., 'to feed themselves and to feed their herds' (Sayce, *The Higher Criticism and the Monuments*, London, 1894, p. 240 f.).

6. Hospitality to exiles and emigrants.—The extent to which hospitality was shown to fugitives and emigrants may be judged from the letter addressed by Amenhotep IV. to Aziru (*Tell el-Amarna Letters*, London, 72), in which whole families are mentioned, and also from the terms of the Hittite-Egyptian Treaty (Hall, 350, 365 f.).

7. Hospitality to individuals.—Three outstanding instances of hospitality (with elements of inhospitality) accorded to travellers, real or fancied, are furnished by Egyptian tales.

(1) The most instructive instance is that of the noble Sanehat or Sinuhe (XIIth dyn.; c. 2000 B.C.). A fugitive from Egypt, he was preserved from death by the hospitality of a Bedawi, who gave to him water and boiled milk. For a time he sojourned with the nomads. Thereafter he was received by a prince of the Upper Tenu (perhaps Syria), Ammuanshi by name, who made him tutor to his children, and gave him his eldest daughter in marriage. He appointed him to rule over part of his territory, and made him commander of the army. He had daily rations of bread, wine, boiled meat, and roast goose, as well as the privilege of hunting game. This kindness reacted on his own practice:

'The messenger who came from the court or went thither stayed with me, I gave hospitality to every one, and I gave water to the thirsty'; 'I set on his journey the traveller who had been hindered from passing by' (A. Erman, *Life in Ancient Egypt*, tr. Tirard, London, 1894, p. 370 ff.; Sayce, *Patriarchal Palestine*², 178).

Towards the end of his life he was permitted to return to Egypt, and was graciously received at court.

'The coarse garments of the Beduin were exchanged for fine linen; his body was bathed with water and scented essences; he lay once more on a couch and enjoyed the luxurious cookery of the Egyptians. A house and pyramid were built for him; a garden was laid out for him with a lake and a kiosk, and a golden statue with a robe of electrum was set up in it' (Sayce, 179; cf. Hall, 157 f.).

(2) The *Travels of a Mohar* is a narrative relating to Syria and Palestine in the reign of Rameses II. (XIXth dyn.; 13th cent. B.C.). Our interest is in the evidence of inhospitality (the hospitality being doubtful) disclosed by this supposed satire. At every stage Nature shows herself inhospitable; and terror, from wild beasts and from man, always seems to oppress the traveller. His clothing is stolen by thieves in the night, and his groom deserts him and joins the robbers. Some time

later, when he comes to Joppa, the maiden who keeps the garden proves his undoing. Here his bow and sword are stolen, his quiver and armour destroyed.

'Prayer does not avail thee; even when thy mouth says, "Give food in addition to water, that I may reach my goal in safety," they are deaf and will not hear. They say not yes to thy words' (for a translation of the whole, see Sayce, 180 ff.; cf. Erman, 380 ff.).

(3) The adventures of Unamon belong to the close of the 12th cent. B.C., and relate to Palestine and Phœnicia. At Dor, near Mt. Carmel, Unamon landed to purchase timber, and was received by Prince Badiel, who sent him bread, wine, and beef. During the night he was robbed by a sailor, who deserted, of the money needed to effect the purchase of the timber. When he arrived at his destination, Gebal (or Byblos), he could accomplish nothing, and was ordered to depart by Zakarbaal, prince of Byblos. After serious delay, however, diplomacy gained the day, and the timber was cut and loaded. Then hostile ships lying outside the harbour hindered Unamon from sailing. The hero sat down upon the beach, and bewailed his fate even with tears. By way of consolation, the prince sent him two measures of wine, a ram, and an Egyptian singing-girl, saying, 'Sing to him that he may not grieve.' His troubles were not yet ended, for in Alashiya the natives would have killed him, but the queen Hatibi intervened. The conclusion is not known (Paton, 168 ff.; A. E. P. Weigall, *Treasury of Ancient Egypt*, London, 1911, p. 112 ff.). This tale is instructive, as showing that hospitality to strangers was largely dependent on the respect entertained for the authority of the land from which they hailed.

On a review of the whole literature, we receive the impression that hospitality had not, as a rule, risen to the level of the virtuous; it was enforced rather than voluntary.

8. Behaviour of guest.—Noteworthy among the precepts of Ptahhetep (Vth dyn.) is the rule for guests:

'If thou art among a company of men and women in the abode of a man who is greater than thyself, take whatsoever he giveth thee, making obeisance gratefully. Speak not oftener than he requireth, for one knoweth not what may displease him; speak when he speaketh to thee, and thy words shall be pleasing unto him' (Budge, *History of Egypt*, London, 1902, ii. 149; cf. Pr 23¹⁷, Sir 31¹², 1 Co 10²⁷).

II. BIBLICAL (OT).—So far as the externals of hospitality are concerned, the Biblical data fit in well with the record from other sources. It will be convenient to observe the distinction between *nokhrî* and *gër*, the former the stranger who is merely passing by, the latter the stranger who acquires a settlement, with certain civil and religious rights, in the land of adoption. It is with the *nokhrî* rather than the *gër* that we are here concerned. While all the categories named above might be repeated for the OT, the clearest examples of hospitality are afforded by private and individual instances. The hospitality of the tent and of the city are found in proximity to each other (Gn 18¹⁻⁸ 19¹⁻⁹). With the help of allied passages (Jg 19, 1 S 28²⁴, 2 S 12⁴, 1 K 17³⁰, etc.) the various stages may be clearly realized. They include: reception (meeting and obeisance), offering of water for washing feet, invitation to rest and to tarry all night, provision of food and drink, and in certain circumstances a feast (an animal, e.g. a calf or a kid, being killed and dressed; bread, butter, milk, and wine also being set before the guests), feeding and housing of animals (asses and camels). Guests were kept inviolate, even at the sacrifice of the honour of daughters (Gn 19⁸, Jg 19²²⁻²⁴). No remuneration was taken, although, when a visit was of set purpose, presents were brought (Gn 24⁶³ 43¹¹, Job 42¹¹). Abraham even went with his guests to bring them on the way (Gn 18¹⁶).

While hospitality was accorded as a rule, there were departures from it (Jg 19¹⁸). Evidently the open space about the city gate was the only 'inn' available in the event of no private house being offered. It was against the laws of hospitality to leave the stranger in such case (Job 31³²), although there was probably little hardship entailed in having to pass the night in the open. Travellers took their own provisions and provender (Jg 19¹⁹), which were husbanded in the event of a host being found (v. 21). On the road to Egypt were halting-stages (inn or lodging place, Gn 42²⁷ 43²¹, Ex 4²⁴), where shelter, and perhaps water, but no food, were to be found (cf. Jer 9²). The instances in Nu 20¹⁹ and Dt 2²⁷ show that even water was paid for. This, however, is an extreme case.

Even among those who are blood-relations the ordinary procedure in respect of hospitality is observed, as, e.g., when Abraham's servant journeyed to the home of Rebekah (Gn 24¹¹). The meeting is like that of strangers, the narrative working up to the disclosure of relationship, which, of course, produces a great change (vv. 31-33; cf. Gn 29¹²⁻¹⁴). Even in such circumstances hospitality is not accepted till the errand has been told (Gn 24³³).

A unique instance is the stated hospitality extended to the prophet Elisha by the great woman of Shunem (2 K 4⁸). As often as he passed by he turned in to eat bread, and in the end had a furnished chamber reserved for his use. This instance is further instructive for the lead taken by the hostess, which recalls the more public part played by women in early times as contrasted with later (Gn 18⁶ 24⁴⁶ 29¹², Ex 2²⁰, Job 1⁴). The act of Jael (Jg 4¹⁷) is to be put by itself as a gross breach of hospitality, notwithstanding the fact that it is justified upon national grounds by the writer of the Song of Deborah and Barak (Jg 5²⁴). In the eyes of the later Semites such a deed would have been reprobated, and such advantage would not have been taken even of an enemy, once the food-bond had been established (W. Robertson Smith, *Kinship and Marriage*², London, 1903, p. 176 f., *Rel. Sem.*², do. 1894, p. 269 ff.). This instance may be set over against Rahab's kindness to the spies (Jos 2), who, in virtue of their hostile mission, could lay no claim to hospitality (cf. Gn 42⁹).

We are reminded of the tale of Sanehat in the experience of Moses (Ex 2²⁰), who, coming as a stranger, tarried with the priest of Midian as one of the family. Like Lot in Sodom, he represents the *gér* at an undeveloped stage.

In the OT the instances of kindness to individual strangers completely overshadow the national and kingly aspects of hospitality. But examples of each are found. The sons of Jacob participated in the hospitality of the Egyptians, although national prejudice required that they should eat bread by themselves (Gn 43³²) and dwell by themselves (46²⁴). In the wilderness the Israelites were denied the minimum of hospitality by the kings of Edom (Nu 20¹⁷) and of the Amorites (21²¹). David, as an outlaw, was the recipient of kindness from Abigail (1 S 25), the king of Moab (22³¹), and Achish, king of Gath (27³²); and, as a fugitive before Absalom, from certain prominent men dwelling on the east side of Jordan (2 S 17²⁷). On the other hand, his envoys, sent with hospitable intent to the court of Hanun of Ammon, were shamefully treated (10⁴), which led to a dire revenge (12³¹). The visit of the queen of Sheba to Solomon (1 K 10¹⁻¹³) is an example of sovereigns standing towards each other as guest and host. A king's kindness to a refugee prince is seen in the Pharaoh's reception of Hadad (III.) of Edom (1 K 11¹⁷⁻²²)—a very close parallel to the story of Sanehat. Hezekiah's hospitable treatment of the envoys of

Merodach-Baladan is shorn of its glory by the prophetic censure following (2 K 20¹²⁻¹⁹).

Hospitality is but rarely marred by deceit in host (2 S 12⁴, 1 K 13¹¹, Pr 23¹¹) or guest (Jos 9²²), or requited by ingratitude (Ps 41⁹; contrast 2 S 9, 19²⁴). By rule, its tendency was elevating (Pr 9¹⁻⁶), but there was the possibility of debasement (Pr 9¹³), especially when luxury was in fashion (Am 6⁴⁻⁶), and feasting was carried to excess (Pr 23^{20, 29}, Dn 5, Est 1).

Some code of hospitality necessarily underlies the political alliances during the monarchy, while trade and commerce imply toleration of, and fair dealing towards, foreigners, and perhaps some measure of kindness.

See also the 'Arabian' article.

LITERATURE.—HDB ii. 427 ff., v. 375^b; EBi, col. 212^s f.; I. Benzinger, *Heb. Archäol.*², Tübingen, 1907, pp. 131-133; W. Nowack, *Heb. Archäol.*, Freiburg and Leipzig, 1894, p. 186 f.; A. Bertholet, *Die Stellung der Israeliten und der Juden zu den Fremden*, do. 1896; E. Day, *Social Life of the Hebrews*, London, 1901; R. A. S. Macalister, *Sidelights from the Mound of Gezer*, do. 1906, pp. 83-106. Most recent works of travel in the Near East contain references to hospitality, illustrated by modern usage; typical of such is H. Clay Trumbull, *Studies in Oriental Social Life*, Philadelphia, 1894, pp. 73-142.

WILLIAM CRUICKSHANK.

HOSPITALITY (Teutonic and Balto-Slavic).—

The ancient records furnish the clearest indications of a widely diffused practice of hospitality both among the Teutons and among the Slavs. As regards the Germans, Cæsar (*de Bell. Gall.* vi. 23) writes:

'Hospitem violare fas non putant; qui quaque de causa ad eos venerint ab iniuria prohibent, sanctos habent, hisque omnium domus patent victusque communicatur';

while Tacitus (*Germ.* 21) says:

'Convictibus et hospitibus non alia gens effusius indulget. Quemcunque mortalium arcere tecto nefas habetur; pro fortuna quisque apparatus epulis excipit. Cum defecere, qui modo hospes fuerat, monstrator hospitii et comes proximam domum non invitati adeunt. Nec interest: pari humanitate accipiuntur.'

Of the Slavs, Mauricius (*Strateg.* xi. 5) speaks as follows:

εἰσὶ δὲ τοῖς ἐπιξενουμένοις αὐτοῖς ἥπιοι, καὶ φιλοφρονούμενοι αὐτοὺς διασώζουσιν ἐκ τόπου εἰς τόπον, οὐ ἂν δέονται, ὡς εἶγε δι' ἀμέλειαν τοῦ ὑποδεχομένου συμβῆ τὸν ξένον βλαβῆναι, πόλεμον κινεῖ κατ' αὐτὸν ὁ τοῦτον παραθέμενος, σέβας ἡγούμενος τὴν τοῦ ξένου ἐκδίκησιν.

The Letts had even a special god of hospitality, called Ceroklis ('ille hospitalitatis deus cui ex omnibus esculentis primas buccas, primos ex poculentis haustus stulta libabat plebes'; cf. H. Usener, *Götternamen*, Bonn, 1896, p. 106).

Teutons and Slavs have another point of contact in the fact that they have a common term for 'guest,' the Goth. *gasts*, ξένος (*gastigóds*, φιλόξενος; *gasti-gódei*, φιλοξενία), corresponding exactly to the O. Slav. *gostĭ*, 'guest,' and both being etymologically equivalent to the Latin *hostis*, 'stranger,' 'enemy.' The Lithu-Letts use a different term: Lith. *wieszėti*, 'to be one's guest,' *wieszne*, 'guest' (fem.), Lett. *wisis*, 'guest,' which are all connected with the Lith. *wiesz-* (cf. Gr. *oikos*, Lat. *vicus*). Should the question be asked how, as in the case of the Goth. *gasts*, O. Slav. *gostĭ*, a word meaning originally 'stranger' or 'enemy' (cf. Lat. *hostis*) should gradually acquire the sense of 'guest,' the answer will be found in the practice of *exchanging gifts*, met with everywhere (see ARYAN RELIGION, vol. ii. p. 51^a; and GIFTS, vol. vi. p. 197), and, in particular, on Teutonic and Slavic soil, in the closest connexion with the practice of hospitality, and which, as the mutual gifts had to be in some degree commensurate with each other, has been aptly called 'trading by gift,' or 'interchange of presents.' Tacitus, in the chapter already cited, expressly says: 'Abeunti si quid poposcerit, concedere moris, et poscendi invicem eadem facilitas'; and the *Hávamál* puts it still more clearly:

'No one is so hospitable or ready to give
That he despises presents;
Nor so little mindful of gain
That he hates return-gifts.'

Here, too, we have the reason why in Old Russian *gostĭ* is quite commonly used for 'merchant' (*kupecĭ*), while *gostiti* means 'to trade,' and *gostĭba*, 'business.'

While the stranger thus literally found an open door because of the wares he carried, we are able to derive from the facts of language a still more precise idea of the way in which the relation between the visitor and his host attained its further development. In the Slavic languages the word *gospodĭ* (from **gosti-poti-s*)—corresponding exactly to the Lat. *hospes* (from **hosti-pets*)—is now for the most part used for 'God,' but originally meant, quite generally, 'master' or 'lord.' The second element of this primitive compound is the Aryan **poti-s* (Skr. *pāti-*, Gr. *πάσις*, Goth. *faps*), 'head of the house.' The Slav. *gospodĭ*, Lat. *hospes*, accordingly mean 'master of the stranger'; and this implies that the guest, during his stay in the house of his entertainer, enjoyed equal privileges with the members of the family. In order to enable us to realize what such friendly treatment meant for a traveller in those days of general insecurity, we quote here a statement regarding Albanian hospitality, taken from a work entitled *Eine Reise durch die Hochländergaue Oberalbaniens (Zur Kunde der Balkanhalbinsel*, ed. C. Patsch, pt. i., Vienna and Leipzig, 1904), by K. Steinmetz:

'Their hospitality, which is unrivalled, may be extolled as the finest characteristic of the North Albanian people,—the South Albanians do not have it in the same degree,—and is of itself sufficient to mitigate considerably the harsh opinions regarding the Albanians often expressed by other travellers. It is not confined to their universal practice of entertaining the stranger, and of regarding a payment as an insult; it goes much further than that. If I eat a morsel of bread in a house, drink a cup of coffee or even but a glass of wine, I at once become a friend (*mik*, i.e. Lat. *amicus*) of the house, and if on my further journey I am robbed or killed before I arrive at another house, the family as a whole will not rest till they have avenged the deed, i.e. shot the perpetrator. . . . If, as happens but seldom, a house does not assume responsibility for a person killed within its precinct, it becomes liable to the blood-revenge of the murdered man's family. This explains why I, though almost always accompanied by only one man, was able to pass through the rudest tribes without danger; for any possible assailant who might think of robbing or killing me knew that he would thereby be exposing himself to the most determined vengeance on the part of the household with which I had last sojourned.'

It thus appears that the family of the host, and especially, of course, the host himself, accept responsibility for the safety of the guest, and, further, that this responsibility is not limited to the time during which the stranger sojourns with the family, but lasts while he is on his way to other quarters. This is exactly what finds expression in the above-quoted references to the hospitality of the Slavs and Germans, as, e.g., when Mauricius, speaking of the former, says that the host is united to the guest by the laws of blood-revenge; when Cæsar states regarding the Germans that they consider themselves to be under obligation to protect the stranger, and look upon it as a crime to injure a guest; and when Tacitus, referring to the same people, asserts that, if provisions give out in the house of the host, the latter must act as the 'guide and companion' of his guest on the way to the hospitality of other houses.

In the Teutonic dialects, however, we do not actually find the form **gasti-faps* (Slav. *gospodĭ*, Lat. *hospes*) which we might have expected. In the oldest extant forms of the primitive Teutonic speech, its place had already been taken by the Goth. *waírdus*, O.H.G. *wirt*, O. Sax. *werd*, O. Fris. *hāswerda*. The earliest occurrence of this stem is in Ulfilas, Ro 16²³, *gōleip izwis Gaius, waírdus meins jah allaižós aiklēsĭjóns* (ἀπαίτεται ὑμᾶς Γάιος ὁ ξένος μου καὶ ὄλης τῆς ἐκκλησίας). The Goth. *waírdus*, accordingly, has precisely the same meaning as the Lat. *hospes* (from **hosti-pets*, 'lord of the stranger') in its original sense, i.e. as applied to the host, not the guest. The words *ξένος μου καὶ ὄλης τῆς ἐκκλησίας*

may be taken to imply, as expositors (e.g. Jülicher, B. Weiss) think, that the Christian assembly met in the house of Gaius, or else that the latter had afforded willing hospitality to numerous visitors from the Corinthian community. This original sense of *waírdus* will then quite readily explain other meanings still traceable elsewhere, as, e.g., 'lord of the house' (*paterfamilias*), 'husband,' etc.

On the purely linguistic side, the present writer would trace this Teutonic form to a primitive Teutonic abstract noun, viz. **wer-tu*, which, as being cognate with O.H.G. *werēn*, O. Fris. *wera*, M.L.G. *weren*, 'to give security,' originally meant 'security,' 'guarantee.' From the abstract **wer-tu*, again, by the common philological process of personification, was developed the sense in which it was applied to the person making himself responsible for another, i.e. the 'surety' or 'guarantor' himself, precisely as, e.g., the Goth. *hliftus* (Lat. *clepere*, 'to steal') meant originally 'theft,' and then came to mean 'thief.' That the legal idea of 'security' existed among the Teutons at a very early period is shown by the fact that the Romance forms—Ital. *quarento* and Fr. *garant*, 'guarantor,' 'surety' (Ital. *quarentire*, Fr. *garantir*, 'to guarantee')—are derived from the O.H.G. participle *werēnto* ('one acting as security,' Med. Lat. *warens*, *warantus*, etc.). Thus the Goth. *waírdus*, in complete conformity with the historical references quoted above, denotes the man who became security for the safety of his guest.

Mention should be made, finally, of a Lithuanian term for 'guest' which has not been referred to in the foregoing, viz. *swēcziās*, i.e. **svetjas*, which is cognate with the Greek *ἐρῆς*, *ἐρῆς*, 'kinsman,' 'clansman.' This term expresses the idea that, as soon as the incomer, who is elsewhere designated as *gasts*, *gostĭ* (= Latin *hostis*), was granted the privilege of hospitality, he was looked upon as an inmate of the house (cf. the Lithu-Lettish stem *wiesz-*, noted above). The head of the house, as we have seen, had to become security for the members of his household, as also for his guests, whenever it was necessary to protect them or to take vengeance on their account. But he was held responsible also when a member of his household or a guest committed an act of injustice. This finds emphatic expression in the Anglo-Saxon code:

'If any one shelters a guest (a merchant, or other person who has come across the boundary) for three nights in his own dwelling, and also feeds him with his own food, and he [the guest] does an injury to another person, let that head of the house bring the other to account at law, or in his stead discharge what is legally due' (cf. F. Liebermann, *Die Gesetze der Angelsachsen*, i. 1, Halle, 1898, p. 11).

From all this it is clear that the practice of hospitality—as a designation of which the Russ. *chlebŭ-solŭ*, 'bread-salt,' derived from the ceremonial presentation of these articles of food at the reception of a guest, ought to be referred to—was of immense significance for the development of intercourse, and, in particular, of commerce. It was likewise the starting-point of the entire hostelry system of Northern Europe, special quarters for travellers being provided in the larger houses much visited by strangers, and more especially in the monasteries; and, while this was done at first for hospitality's sake, it came in time to be done for payment. All the Teutonic languages have a term for 'guest-house': O.N. *gesta-hús*, O.H.G. *gast-hūs*, A.S. *gesthús*; and there is also the O.N. *inni*, A.S. *inn*, a word of obscure origin. In the Slavic tongues we find O. Slav. *gospoda*, Czech *hospoda*, etc., 'lodging,' which are derived from **gosti-potā* (cf. *gospodĭ* above), and meant originally 'protection of and lordship over guests.'

On the traces of the practice of lending a wife to a guest, see art. CHASTITY (Teutonic and Balto-Slavic), vol. iii. p. 499^b.

LITERATURE.—This is given in the article. Cf. also O. Schrader, *Linguistisch-historische Forschungen zur Handelsgesch. und Warenkunde*, i., Jena, 1888, ch. i., and *Reallexikon der indogerman. Altertumskunde*, Strassburg, 1901, s.v. 'Gastfreundschaft.'
O. SCHRADER.

HOTTENTOTS.—I. Origin and migrations.—At the time of the discovery of the Cape of Good Hope and its colonization by Europeans, the S.W. corner of the African continent was found to be in the occupation of two distinct peoples, known to us as the Bushmen and the Hottentots. Of these the Hottentots were the dominant race. They were almost everywhere engaged in desultory hostilities with the Bushmen, who were doubtless the aborigines of the country, and who were usually treated by the Hottentots as the savage inhabitants of a colony are too often treated by the white colonists: they were to be exterminated, or at least reduced to servitude. For the Hottentots were an intrusive people. Their origin has been the subject of considerable discussion. Their traditions point back to a time when they dwelt in 'a well-watered region somewhere in the centre of the continent, from which they were driven by a more powerful people, of a black colour, who came down from the north or north-east' (Theal, 59). An examination of their language by philologists has led to the discovery that it was a highly organized tongue, akin to the ancient Egyptian and other languages of the northern and north-eastern part of the continent. It was inflected and sex-denoting. Its roots were monosyllabic, each ending with a vowel; and the meaning of the word frequently depended upon the tone. The Bushman language was of a much more primitive type. It was not sex-denoting; it was hardly inflected at all; and it abounded in the uncouth sounds known to philologists as 'clicks.' Of these sounds, however, four—and those the most easily pronounced—were in use among the Hottentots; or five, if we reckon a guttural peculiar to a few dialects of the Hottentots and Bushmen. The discovery of these linguistic facts threw unexpected light on Hottentot origins; and it is now generally accepted that the Hottentots are of mixed descent, probably due to the intermarriage of men of North African—that is, Hamitic—lineage with women of Bushman race. This mixture may have begun in the N.E. of the continent. The suggestion has been made that the primitive ancestors of the Hottentots were a band of Egyptian soldiers said by Herodotus (ii. 30) to have deserted in the reign of Psammetichus, and to have taken service in Ethiopia, where the king gave them a tract of land in the occupation of his enemies, on condition that they conquered and settled it. They would necessarily, it is argued, have taken the women of the country, if they had none of their own. The hypothesis is, of course, no more than a guess, and a guess which gives rise to a number of difficulties; but to dismiss it leaves the main theory untouched. The mixed race, thus constituted, for some reason—possibly the irruption of Bantu on their ancestral seats—left those seats and fled to the south. As they were a pastoral people with flocks of long-haired sheep and herds of cattle, they were compelled to turn westwards, so far as to avoid the zone of the tsetse-fly. Continually journeying, impelled by causes which we do not know, but among which the pressure of Bantu on their rear may not have been the least, they came at length down the western side of the continent to the Cape. A series of straggling tribes, they kept continually in the zone of the best pasture between the sea and the mountains or deserts of the far interior. Finally they settled, since they could go no farther, in a wide territory from Great Namaqualand to the shores of the Southern Sea, from Walfish Bay

to the mouth of the Umtamvuna River, the present boundary between Natal and Cape Colony. Their immigration seems to have taken place at a period not long before the discovery of the Cape, and to have been contemporaneous with the advance of the Bantu down the Eastern side of the continent. It was the latter advance that stayed the progress of the Hottentots to the shores of the Indian Ocean.

The Hottentots of Cape Colony have, for the most part, been exterminated or driven northward by wars with the colonists and servile oppression; or they have suffered from the mingling of European blood, have learned to speak a European language, and adopted Christianity. Beyond the Orange River the Korana (who are emigrants from Cape Colony) and the Namaqua have been somewhat more successful in preserving their racial purity, such as it was, from white contamination. But they have not been able to resist the disastrous pressure of European culture any more than of European arms. They are a dwindling folk; and—more rapidly than themselves—their language, their traditions, and their ancient institutions are disappearing. Their language was investigated more than thirty years ago by Bleek; but their traditions and their institutions have never been the subject of any searching scientific inquiry on the spot. Hence the attempt to produce an intelligible outline of them is attended with some difficulty.

2. Characteristics, organization, and culture.—The name 'Hottentots' is of doubtful origin; probably it was a contemptuous term bestowed by the Boers. The Hottentots proudly called themselves *Khoi-Khoi*, 'Men of men.' They were, like the Bushmen, of a dirty-yellowish colour, frequently described as olive, with crinkled hair growing in small tufts, and with pointed chins. The women were distinguished by an extraordinary deposit of fat on the haunches, known scientifically as 'steatopygy.' But the Hottentots were not, like the Bushmen, a diminutive race, though by no means tall as compared with Europeans. Their wealth, as already intimated, consisted in flocks and herds. Hence their settlements were never permanently attached to one spot, and they were separated from one another by the spaces necessary for pasturage. The huts were of hemispherical shape; they were made of rush mats on a light framework of wood, and were easily removed and transported from place to place. Of agriculture the Hottentots knew nothing, though they seem to have taken kindly to it under European masters (Theal, 173; Stow, 240; Kolben, 38; Fritsch, 320).

This nomadic mode of life was, of course, compatible with only a very loose organization. There were a number of independent tribes, the chiefs of which were assisted, or sometimes controlled, by the elders of the various families. Between these tribes, and indeed between the smaller social units of which the tribes were composed, there was little cohesion; frequent, if desultory, feuds were engaged in. Hence they easily fell a prey to the colonists. Our information as to the internal relations of the kindred is very incomplete. Neither the old travellers nor the modern writers on the people have understood them. Their reports, therefore, present contradictory features difficult to reconcile. The time for fruitful inquiry among the people themselves has now passed for ever; and any opinion about the family organization can be expressed only with much hesitation. That the rule was patriarchal and that inheritance was from father to son, or, failing sons, to the nearest male relative, to the exclusion of women, affords a presumption that the organization was by clans reckoning descent only in the male line. On the

other hand, in spite of polygamy, the women appear to have taken a high position. The wife was the ruler of the house, to such an extent that a man could not venture without her permission to take from the vat so much as a mouthful of sour milk produced by the family cows. His nearest female relatives, we are told, punished a violation of this rule by a fine of cows and sheep 'to be added to the stock of the wife.' Contrary to the Bantu rule, the eldest daughter milked the cows. A man's most sacred oath was by his eldest sister; 'and if he should abuse this name, the sister will walk into his flock and take his finest cows and sheep; and no law could prevent her from doing so.' Moreover, she might inflict punishment on him, though adult, for an infringement of the rules of courtesy and the code of etiquette. A woman might even become chief of the tribe, if of energetic character and the widow of a chief who left a son not yet of age. From these and other customs we infer that, if the organization was patrilineal, the opposite or matrilineal organization had left abundant traces on it (Hahn, *Tsunigoam*, 18-21).

When discovered, most of the Hottentots already possessed iron and copper weapons and tools. They had probably brought the knowledge of smelting from their original seats. Such weapons and tools, however, were valuable, and the Hottentots were not entirely emancipated from the Stone Age. They were a brave and independent people, as filthy and irresponsible as savages usually are, sensual, and easily provoked to anger, but kindly and hospitable.

3. Witchcraft and witch-doctors.—Like all peoples in the lower culture, the Hottentots were believers in witchcraft. To this cause they attributed sudden accidents or pain, and all serious sickness. Our authorities have left us no account of the process of bewitching. It was doubtless founded, as everywhere else, on sympathetic magic. For corpses were believed to be used for this purpose; and other practices point to the same order of ideas. Among them may be mentioned the ceremony, at crossing a rapid river, of first sprinkling some of the water over the body and daubing the forehead with a little of the mud, muttering the while a charm and dancing (a ceremony repeated on coming out of the water); and the requirement that a woman had to watch the fire carefully and keep it alive, or else sprinkle the ground with water without rest or cessation, so long as her husband was absent hunting. Old women especially, as in Europe, fell under the suspicion of witchcraft. What, if any, punishment was inflicted we do not know. Nor does our information extend to the practice, so common among the Bantu, of 'smelling out' a witch. Witch-doctors, however, as might be expected, were an institution. That their labours were not always beneficent we gather from the jealousy with which corpses were prevented by the relatives of the deceased from falling into their hands. Similar precautions were taken, for the same reason, at a birth, with respect to the placenta and the *kaross* (or skin-mantle) on which delivery had taken place. The witch-doctors were exorcists employed to lay troublesome ghosts. They were called in to treat the sick. For this purpose a sheep was flayed alive. If it moved away from the spot after the revolting operation, it was a sure prognostic that the patient would recover; if not, he would die. In the latter case no further trouble was taken concerning him. Otherwise the caul was minutely examined by the witch-doctor and sprinkled with *buchu*, the powder of a species of spiræa. He then, twisting it into a cord, hung it round the patient's neck as an amulet, there to remain until it rotted

off. The sheep was eaten by the men, women, or children of the kraal, according to the sex and age of the patient. If the treatment failed, the witch-doctor resorted to simples, of which these practitioners are said to have had a good knowledge. They were also skilful surgeons, performing the operation of blood-letting, curing snake-bites, and setting dislocations. It was they probably who shaved the heads of mourners and of persons suffering from headache, and on solemn occasions slew the animals described as sacrifices. It was they who at a wedding performed the extraordinary but well-attested rite of micturating over the bride and bridegroom; but they are not definitely identified by Kolben, our principal witness, with the old men who accomplished a similar ceremony at puberty rites, at funerals, and on receiving home a warrior who had encountered and slain single-handed a lion, an elephant, or some such formidable beast. They were the rain-makers; and as such their art was founded on the processes of sympathetic magic. Thus they formed an influential class closely corresponding to the witch-doctors or medicine-men of the south-eastern Bantu.

4. Future life and cult of the dead.—The Hottentots held that the individual, in some sense at any rate, survived death. As we have seen, they were at times haunted by spirits of the dead, who were deemed mischievous or malicious. Happily there was one way of preventing this. The spirit did not usually travel far from the place where the man had died. It seems that, as is widely believed in the lower culture, it was attached to the body and dwelt at or in the grave. Consequently, when a death occurred, the kraal was removed to a distance; care being taken, however, to abandon to the ghost the hut in which death had taken place, together with the apparel and implements of the deceased; otherwise removal would have been of no avail, for the ghost would follow them. We are not told that there was any organized ancestor-worship; nor does it appear that sacrifices were offered to ancestors as such. But it was the custom for a Hottentot, when in trouble, to go and pray at the graves of his ancestors (Hahn, 112); and, seeing that burials often took place in clefts and holes of the rocks, it is possible that the wild ceremonies described by an old writer as performed in caverns may have been invocations of the departed (Kolben, 96, quoting Vogel). Certain spots, moreover, were held sacred to famous men of the past. In going by them it was usual to stop, to muffle the head in the mantle, and offer prayers to the dead man for protection of the worshipper and his cattle, and sometimes to dance round the place with singing and clapping of hands. The legends of many of these heroes were known and told. From an anecdote related by Kolben, however, it would appear that the spot often became sacred from a vague belief, arising it may be from purely accidental coincidences, that there was something uncanny about it, such as led the ancient Greeks to hallow the shrine of a hero unknown, or the Indians of British Guiana to ascribe to rocks and other inanimate objects a powerful spirit who must be honoured and mollified. There is no trace of a belief in future retribution. Rebirth, not always in human form, and shape-shifting, or transformation during life, appear in the stories; for the Hottentots were in nowise different from other savage and barbarous peoples who recognized no impassable chasm between mankind and the lower animals.

5. Food prohibitions.—The Hottentots abstained from eating fish that have no scales. The Bantu also abstain from fish, alleging as the reason their similarity to snakes—a form in which their dead frequently show themselves to the survivors. It

may be that some such reason caused the Hottentots to abstain; but this is a mere conjecture. Swine's flesh was likewise forbidden to them—on what ground we do not know. Another food prohibited, at all events to the Namaqua, was the flesh of the hare. The reason usually assigned for this was the part taken by the hare in the saga of the origin of death (cf. *ERE*, vol. iv. p. 412^a, and vol. v. p. 706^a), common in one form or other to all the South African peoples.

There is, however, another and a deeper reason for abstention from hare's flesh. The Namaqua share with the rest of the uncivilized world the belief that he who eats the flesh of an animal absorbs that animal's qualities and becomes like it. To eat the flesh of the lion or to drink the blood of the leopard or the lion is to acquire the courage and strength of those beasts. In like manner to eat hare's flesh is to become as faint-hearted as a hare (Hahn, 106).

6. Moon and stars.—In connexion with the tale of the origin of death it may be observed that there is some ground for thinking that the moon was invoked by the Hottentots. At new moon and at full moon they spent the night in dancing, singing, and merrymaking. One old writer also speaks of their sitting at new moon on the banks of a river and throwing balls of clay into the water. It is by no means clear what was the exact meaning of these proceedings. It is possible that they were a rain-charm. The older writers may be roughly divided into two classes—those who denied that the Hottentots had any religion, and those who attributed to them an idea of God as lofty as their own. Both these representations may safely be discounted. The ceremonies at new and full moon, which, we are told, no inclemency of weather prevented, may be, as Kolben (p. 96) emphatically asserts, 'religious honours and invocations to the moon,' and yet his conclusion, that she was an 'inferior visible god, the subject and representative of the High and Invisible,' may be altogether beyond the mark. Since she was held to influence the weather, the rites were probably intended to induce or magically compel her aid. More than that cannot safely be said. Certain of the constellations also were known and named. At the first rising of the Pleiades after sunset a religious dance was held, with prayers to Tsuni-goab for rain. Stars were said to be the eyes or souls of the deceased—which points to a belief in the *post-mortem* transformation of the dead into stars, not unlike that entertained by some of the Australian tribes.

7. Omens.—Many animals were observed for omens. If a hare crossed the hunter's path, he would return home; on the contrary, if it ran in the same direction as he was going, it was a good sign. The korhaan (*otis kori*) brought luck if it did not fly far from the hunter and soon again sat down. A certain kind of chameleon creeping on a hunter or his weapons or belongings, while he rested on the road, prognosticated success. This, rather than any worship directed to the insect, is the probable explanation of the rites so graphically described by Kolben and in general terms confirmed by Hahn as performed when the mantis appeared. It was, for some reason unknown to us, regarded as a favourable omen of the highest significance. If it went so far as to alight on man or woman, the fattest ox belonging to the kraal was killed. The lucky person received the entrails and fat, and wore the caul twisted about his neck until it rotted off, or until some other person was honoured by the mantis in a similar way. The flesh of the ox was boiled, and the men or the women feasted on it according to the sex of the person on whom the mantis had alighted. The

mantis, of course, was never killed or injured, for to do this would turn the omen into disaster and destruction (Kolben, 98).

8. Mythology.—Hottentot mythology, so far as it has descended to us, is meagre. Setting aside stories relating to the lower animals (many of them, as might be anticipated, ætiological), it is concentrated chiefly on the adventures of two mythical beings, who were the subjects of tradition and the object of worship—Tsuni-goab and Heitsi-eibib. The latter was a sort of culture-hero among the Namaqua and their neighbouring tribes. The traditions concerning him can only be summarized here. He was born, according to one tale, of a young girl who had chewed a kind of grass and swallowed the juice. The boy was as remarkable as his birth. He committed incest with his mother. He killed monsters. He fought and conquered great lions, and put enmity between the lion's seed and mankind. He cursed the lion and the vulture. To his commands are ascribed the habits of these creatures, as well as certain human observances. He died from eating the fruit of a raisin-tree, which is consequently prohibited; in fact, it causes dysentery. He returned to life. He was an adept in shape-shifting. Another legend represents him as being born again as a young bull from a cow pregnant from eating grass. He appears finally to have died, for his graves are found all over the country, usually in mountain passes. Natives who go by throw pieces of clothing or other articles of no value on them for luck—a common practice also among Bushmen and indeed at wayside shrines in all parts of the world. Sometimes more substantial offerings of honey or honey-beer are made. He is glad when men thus honour him. He still gives the Khoi-Khoi good advice, tells them how to kill the lion's children and other wild animals, and prevents danger from befalling them, if they honour him. These stories present few traits not common to those of mythical heroes elsewhere.

The other personage is more important. He seems to have been known to all the Hottentots. His name, Tsuni-goab, also written Tsui-goab, and in other ways, is usually translated 'sore (or wounded) knee.' The story told by an aged witch-doctor in explanation to Moffat was

'that Tsui'kuap was a notable warrior of great physical strength, that in a desperate struggle with another chieftain he received a wound in the knee, but having vanquished his enemy his name was lost in the mighty combat which rendered his nation independent, for no one could conquer the Tsui'kuap (wounded knee)' (R. Moffat, *Missionary Labours . . . in S. Africa*, London, 1842, p. 258).

This derivation, however, is discredited by Hahn, who interprets it as 'the Red Dawn.' His reasons are chiefly philological, elaborated under the influence of the mythological theories current in the middle of last century. But he adduces two other considerations—that the Korana believe Tsui-goab to live in the Red Heaven or Red Sky, and that another mythological personage whom he equates with him, called 'The man whose body has a brass-coloured backbone,' was addressed as 'Thou who paintest thyself with red ochre.' These reasons are obviously insufficient. Another account of Korana belief makes Tsuni-goab dwell beyond the blue sky, in a light sky. Red ochre is a substance commonly used by savages to paint themselves and the objects of their reverence; and it was so used by the Hottentots. When praying for rain at the rising of the Pleiades, some of the tribes, when Hahn wrote, still addressed Tsui-goab in a traditional song as 'Father of the Fathers.' The question of his true character depends largely on the way in which we are to construe this phrase. A Korana tradition declares that he 'made two persons, a man, Kanima (Ostrich Feather) and a woman, Hau na Maos (Yellow Copper). He gave them cows,

whose milk they should drink, a jackal-tail to wipe the perspiration off the brow, a staff with a club (*kirí*), a quiver with arrows, a bow, and a shield. From Tsúli-goab they expect all good things' (Hahn, 106).

Hahn, who found this statement among his notes, is uncertain of its source, but attributes it 'very likely' to a missionary, Wuras. The last sentence, it is to be noted, seems a summary of what the reporter understood to be the mental attitude of the Korana towards Tsuni-goab. It may mean no more than what we have already learned concerning the Namaqua and their hero. The general import of the tradition has been interpreted as affirming that Tsuni-goab was the Creator of mankind. A careful consideration, however, will hardly endorse this construction.

'The obvious and natural inference,' remarks A. Lang on the whole evidence, 'is that Heitsi Eibib and Tsui Goab were and are regarded by their worshippers as departed but still helpful ancestral warriors or medicine-men. We need not hold that they ever were actual living men; they may be merely idealised figures of Khoi-Khoi wisdom and valour. But that in the opinion of their worshippers they are but dead men, there seems no doubt at all' (*Myth, Ritual, and Religion*, London, 1887, ii. 20; cf. 2nd ed., 1899, ii. 44).

Statements by Kolben pointing to monotheism, or rather dualism, are now generally recognized as due to a misunderstanding usual in the age in which he wrote. Accurate investigation of savage beliefs was then hardly known. Investigators were obsessed by the desire to identify the objects of heathen worships with those known to them in Christianity. Such information as they obtained was dragged out of reluctant savages, who themselves had probably no definite ideas on the subject, and were, moreover, confused by the interrogations, or only too willing to mystify the inquisitive white man; and it was hastily misinterpreted in accordance with the inquirer's prejudices.

9. Bodily mutilations.—On the other hand, when Kolben speaks of his own knowledge as eye-witness, he is generally to be depended on. His account of the custom of excision of the left testicle from every youth at or before puberty (p. 112) has been rejected by other writers, notably by Fritsch, who argues that he was deceived, in spite of his minute description of the rite and repeated personal examination of the victims themselves (p. 335). But it has been accepted by Theal, who states that

'it is practised at the present day by people [probably the Berg-Damara] who are certainly not of Hottentot blood, but who must have derived their language and many of their customs from Hottentot conquerors in bygone times' (p. 87).

It is, in fact, one of many species of sexual mutilation, more or less cruel and senseless, practised in various parts of the world, of which it can only be said that, while they are probably due to some superstition, their exact origin and purpose are still unknown. Many Hottentot women were mutilated by the amputation of one or more of the joints of the little finger. Kolben asserts that the custom was confined to those who married more than once, a fresh joint being cut off before every fresh marriage (pp. 158, 306). It has been found, however, practised upon children of Bushmen, Berg-Damara, and Kaffirs, as well as of Hottentots (Hahn, 87). Kolben's experiences were confined to the tribes of the Colony, and it seems probable that the custom and the motive varied. Such a sacrifice by a widow before a second marriage may have been to elude the vengeance or to mollify the ghost of her deceased husband. Inflicted on a child (usually a girl), it may have been intended to ward off some misfortune, feared perhaps from the action of ancestral spirits (Fritsch, 332). But our data are not sufficient to enable us to determine the motive with accuracy.

It may be added that many Hottentot beliefs and rites seem to have been shared with the Bushmen, or, at all events, to have been influenced

by them. Such (to take only a single example in addition to the mutilation of the fingers) is the reverence for the mantis, which among the Bushmen is connected in some way, to us obscure, with Cagn, their hero or divinity. At present, however, our knowledge of Bushman is as meagre as that of Hottentot institutions. This fact is sufficient to indicate the essentially provisional character of many of the conclusions expressed (not without diffidence) above.

LITERATURE.—Notices and accounts more or less fragmentary are to be found scattered through the writings of the older travellers and missionaries. The fullest and most accurate information is given in P. Kolben, *The Present State of the Cape of Good Hope*, tr. Medley, 2 vols., London, 1731 (vol. I. alone relates to the Hottentots and has been alone cited above); and of more recent works in G. Fritsch, *Die Eingeborenen Süd-Afrika's*, with an atlas of portraits, Breslau, 1872; W. H. I. Bleek, *Reynard the Fox in South Africa*, London, 1864 (a collection of Hottentot folk-tales chiefly from MSS in Sir George Grey's library at Cape Town); T. Hahn, *Tsuni-goab, The Supreme Being of the Khoi-Khoi*, London, 1881; G. W. Stow, *The Native Races of South Africa*, ed. Theal, London, 1906 (a painstaking but incomplete work, the author having died before half his task was finished); and G. McCall Theal, *The Yellow and Dark-skinned People of Africa south of the Zambesi*, London, 1910. E. SIDNEY HARTLAND.

HOURS.—See WORSHIP (Christian).

HOUSE.—See HANDICRAFT.

HOVAS.—See MADAGASCAR.

HUGUENOTS.—French Protestantism was a native product of 1512-59. It had no roots in the past, for the Albigenses (*q.v.*) had been exterminated, the Waldenses (*q.v.*) had emigrated, the university of Paris was the centre of Scholasticism, and the reforms of Gerson contemplated no breach with mediæval theology. Except for the encouragement given by the sight of other successful revolts from Rome, it owed little to foreign influences. On the other hand, the system of doctrine thought out by Calvin, and the organization elaborated in Paris, have been adopted to some extent in every Protestant country except Scandinavia; while French Protestant exiles have enriched, not north Europe alone, but America and South Africa.

Jacques Lefèvre was the Erasmus of the French reform, laying billets he feared to kindle. By 1512, following the example of Colet, he published a new annotated Latin version of Paul's Epistles, recognizing his doctrine of justification. In 1523 he began to revise the classical French version of the Vulgate. But the group of Humanists, protected at Meaux by the bishop, did little more than reform that diocese and leaven it with evangelical preaching. The political situation was dominated by the fact that Francis I. in 1516 made a Concordat with Rome, whereby he recognized the Papal rights of canonical institution and of exacting annates, and secured for himself all valuable ecclesiastical patronage. With the clergy thus rendered subservient, no motive remained for the Crown to desire reform. The Council of Sens (1528-29) showed that the clergy were equally content, now that all French sees and abbeys were reserved for them. The nobility, however, found their feudal rights and their material resources rapidly diminishing, and were accessible to new ideas. And in the Third Estate, craftsmen and retailers suffered by the influx of precious metals, and they also provided a receptive soil.

The leader was John Calvin (1509-64), a Picard, trained in theology and law (see CALVINISM, vol. iii. p. 146 ff.); but in 1534 he had to flee owing to his friend Nicolas Cop advocating evangelical views in his rectorial address at Paris. Finding that the movement was imperilled by the supposed anarchism of the Anabaptists and by some of their

tenets, he published in 1536 the *Institutes of the Christian Religion*, casting the purified metal into the old moulds, but adding two sections dealing with the current slanders, and dedicating the work to Francis. The book was the first valuable dogmatic treatise, and soon was enlarged and translated widely. A revision of Lefèvre's Bible version in 1535 by another Picard, Olivétan, and the appearance of Clément Marot's metrical version of the Psalms, were other treasured aids.

Some adherents were exasperated by the refusal of the clergy to reform, and their placarding of handbills attacking the old doctrines and usages irritated the Catholics. Francis had wavered for a time, but, when he found one of these broadsheets on his bedroom door, he adopted a policy of extermination, announced in 1535, and seldom abandoned during the century. An organized congregation discovered at Meaux in 1546 was stamped out, but the movement spread. Henry II. (1547-59) created a special committee of the Paris Parliament—the chief organ of justice—to systematize the prosecutions. They proved ineffective, and by 1555 a congregation was formed even in Paris, while four years later a synod of twelve congregations met and organized a National Evangelical Church. A confession was adopted, reflecting the influence of Calvin. His plan of governing each congregation by minister and elders was followed, and a system was begun of linking the congregations by synods of ministers and elders, much as the South German Anabaptists had arranged a generation earlier. As the movement extended, local synods grouped naturally by the civil provinces and the provincial synods were finally merged in one National Synod. The plan was rapidly adopted by Presbyterians everywhere.

The Synod of 1559 is a landmark, inaugurating a period of seventy years when the Reformed Church was an important political factor. Its appearance contributed to bring about peace with Spain, and an agreement between Henry and Philip to root out heresy. The discovery of this intention by William the Silent led to a certain interweaving of Netherland and French politics, and to the constant interest of the House of Orange in the French Protestants, for whom William's little Principality on the Rhone often served as a refuge.

With the accession of Francis II. a few weeks after the Synod, the family of the Guises came to power, and steadily opposed the new religion. But the illegal execution of Anne du Bourg and other sympathizers in the Parliament called attention to previous armed resistance by persecuted evangelicals, Zwinglians, Anabaptists, and Lutherans. By this time several nobles had declared themselves, including Admiral Coligny and two princes of the blood, the Dukes of Bourbon and Condé. The latter was charged by the Guises with plotting, but they dared not grant his demand for a trial, contenting themselves with massacres of the humbler conspirators. Henceforward the evangelicals met openly in armed conventicles, and the 'Hugonots' were suddenly recognized as a power in the land. The name, originally thus spelt, seems to have been bestowed first at Tours, where the favourite place of meeting was near the gate of St. Hugon.

With the accession of Charles IX. (1560-74), the queen-mother, Catherine de' Medici, brushed aside Bourbon, the first prince of the blood, and became regent. For a year there seemed a chance that she would belie Knox's fears as to 'the Monstrous Regiment of Women,' and imitate the revolution just carried through by Elizabeth in England. The second period of the Council of Trent had closed, but its decisions were not allowed

to be published officially in France. The States-General assembled in 1561 reflected the division of the nation: the clergy, of course, wanted no change; the nobles were unable to draft any unanimous requests, while many called for toleration; the Third Estate demanded religious liberty for all, and lay control over ecclesiastical matters. Coligny brought up a definite programme: biennial assemblies, free election of the higher clergy, nationalization of much property in ecclesiastical hands, and a national council under the king to settle religion. All that he gained was a suspension of persecution, and a religious conference.

The Huguenot spokesman at Poissy was Théodore de Bèze, a close friend of Calvin, but no Knox. He made, however, such a deep impression that the clergy saw it was politic to offer large funds for the public needs; and, by reserving the right to fix the quota themselves, they ensured the frequent convoking of their Estate, even if the States-General lapsed. Therefore the Edict that issued in 1562 conceded nothing more to the Reformed than the right to private worship within doors, or public worship outside walled cities. Hereupon both parties prepared for civil war.

For more than sixty years France was rent by the struggle, though it was suspended so often that nine successive wars are reckoned. The outbreak was at Vassy, where a congregation meeting publicly within a walled town, and therefore illegally, was massacred by the Guises without ceremony. In the intervals of fighting, it became clear that a Counter-Reformation had begun, and that the zeal of the preachers trained at Geneva was offset by the subtlety of the Jesuits. The movement was much transformed in 1572, when Catherine was hurried by Italian advisers into authorizing a general massacre of all Huguenots, beginning with the royal guests. The princes of the blood were saved by a forced conversion, but every other leader of note fell, with thousands of humbler adherents. The survivors perfected their organization on quite representative lines, till there appeared a State within the State, independent of the feudal nobility and of the Crown.

With the accession of Henry III. (1574-89), two other parties defined themselves: the League of thoroughgoing Catholics, who copied the Huguenot organization, and the Politicals, who aimed at internal peace and the exclusion of foreign influence, as of the Guises and Catherine. The States-General of 1576, packed by the League, declared for unity of religion. When Henry of Navarre, who had retracted his forced conversion, became heir-presumptive in 1584, the League was driven to a policy of exclusion. Four years later, the States-General declared against even toleration; but the arrogance of the Guises led to their assassination by order of the king, and, with the death of Catherine and the counter-assassination of the king, Navarre succeeded as Henry IV. (1589-1610).

The League was so strong that Henry found it politic to become a Catholic in 1593; he was able to banish the Jesuits next year, and in 1598 to grant the Edict of Nantes, destined to continue for 87 years, in great contrast to its many ephemeral predecessors. This declared Catholicism to be the established religion, maintaining the obligation of tithes and of the marriage laws; but it stopped persecution and recognized freedom of conscience, with the right of private worship anywhere. The 'so-called reformed' public worship was legalized in every place where it was then actually practised—about 200 towns, with five chief cities excepted; also in many thousand castles of the nobles, and in two places within every bailiwick. All synods were authorized to meet. On the civil side, not only were full civic rights guaranteed, and for

ministers such treatment as the clergy received, but committees of Parliament dealing with cases involving Protestants were to have Protestant members. As a temporary measure, about 200 towns were left in their military possession, the garrisons being paid by the State. Rapid development ensued; schools and 'temples' arose in numbers, with theological colleges at Nîmes, Saumur, Die, Sedan, Montauban, etc., while domestic piety was nurtured by the Genevan revision in 1588 of Olivétan's Bible.

With the assassination of Henry IV. and the accession of his son, Louis XIII. (1610-43), the tendency to absolute royal power increased, as was shown by no States-General being convoked after 1614. During the minority, the Jesuits quietly returned, and won many of the clergy to Ultramontane views. The rise of Richelieu in 1624 frightened the Huguenots into revolt, and, when La Rochelle fell after four years, their separate political existence ended, and their fortifications were demolished everywhere. The Peace of Alais in 1629 inaugurated a third period, when they were merely tolerated as inferiors, without any guarantee that the Edict of Nantes would be observed. Henceforth the nobles dropped off, as with the English Puritans after 1660, and the party became chiefly middle-class.

Richelieu and Mazarin, however, gave the Protestants fair play, so that in the troublous days of the Fronde they were loyal. Devoting themselves to manufacture and trade, and not being handicapped by cessation of work on saints' days, they gained nearly a monopoly of weaving wool, linen, and silk. Though they can hardly have mustered more than one million people out of fifteen millions, their importance was far greater. The Edict of Nantes was construed liberally, and public worship was actually maintained in 631 principal places, with 231 others subordinate. The synods met freely, though the National Synod needed special authorization, and a royal commissioner presided. Thought ripened apace under these conditions, and, while in Britain the doctrine of the Divine Right of Presbyterianism was hardening, the Huguenots preserved a more open mind. Daille's *Traité de l'emploi des saints pères*, written in 1632 and translated by 1651, did much to break down the authority of the Fathers and exalt the Bible. At Saumur also were sown the seeds which, transplanted to England, were to produce the Deists, though the later emigrants, such as Mauduit, Gailhard, de Luzancy, took the field against Socinianism.

At this time the Huguenots were important enough even to influence foreign affairs. The Synod of Charenton in 1644 condemned the Independents as a sect prejudicing the Church of God. On the execution of Charles I., Amyraut and Bochart published books on the Divine Right of Kings, two others translated at The Hague and at Orange the *Eikon Basilike*, while de Saumaise and Pierre du Moulin, rector of St. John in Chester, put forth royalist Latin pamphlets. William Dugard, Master of Merchant Taylors', translated de Saumaise into English and printed it on his own press. He was soon converted, rather forcibly, and not only did he publish Milton's response, but he became 'Printer to the Council of State' and actually issued from 1650-57 a weekly French paper in London, manifestly designed to win the Huguenots to sympathy with the new régime. Louis du Moulin, Pierre's brother, son of James's friend, accepted the chair of history at Oxford in 1648, and in 1680 published a work on the Conformity of the Discipline and Government of the Independents to that of the Ancient Primitive Christians. The libraries of Arundel, Sancroft, and Charles II. were

in charge of Huguenots, and the court of this king even had an official Huguenot ambassador.

These halcyon days ended soon after the collapse of the English Commonwealth withdrew the only possible external protector. When Mazarin died in 1661, Louis XIV. (1643-1715) assumed power, and declined to receive a deputation of pastors come to congratulate him. Local self-government and constitutional methods were rapidly vanishing. Nobles and gentry were invited to court and led into extravagance, or were ignored at home. Even the provincial governors were practically superseded by obscure lawyers (*intendants*) wielding powers as absolute and as illegal as Cromwell's Major-generals, like whom they were backed by an irresistible army. As the States-General never met, National Synods also ceased after 1660; provincial States and Parliaments declined in importance; and arbitrary Edicts became the only laws. When, therefore, an aggressive Company of the Holy Sacrament set itself against toleration, and the one survival of the old times was the Estate of the Clergy, often convoked to tax itself, the danger was obvious, and there was no constitutional protection.

Troubles began at Montauban when a quarrel between Protestant and Jesuit students served as a pretext to banish the college, to confiscate the premises, and to impose a garrison on the town. Commissioners now started to seek for buildings, etc., not authorized by the Edict of Nantes. Systematic repression began with the walling up of the temples in the Pays de Gex, a recent addition to the kingdom. In 1666, hundreds of local decisions were codified as a guide, but an emigration began, and on remonstrance from the Grand Elector the code was revoked. Foreign wars further distracted attention, and for a time the chief evils were displacement from civil and municipal office, or confiscation of corporate property.

After the peace of Nijmegen in 1678, the remaining steps were few and effective. Children of seven were declared capable of conversion, and inquiries were set on foot as to age; a bench had to be provided in every temple for opponents, who were at liberty to interrupt the services and argue; ministers were forbidden to remain more than three years in any place. At length dragoons were quartered on the Protestants, with no restraint on their behaviour, and with orders to arrest prominent men, to batter down the temples, to seize the pastors. Emigration revived in 1681, and there was a temporary check; but, when England received a Catholic king in James II., the last external protector seemed gone, and every imaginable wrong to person and property was now inflicted broadcast. Half the Protestants were thus coerced, and so large was the supposed number of New Converts, that on 17th October 1685 the Edict of Nantes was revoked as no longer necessary. All Reformed worship was to cease at once, and all pastors were to quit the realm in a fortnight. Within a few weeks 800 temples were demolished, and all corporate property was lost.

Emigration was forbidden, and all refugees caught were sent, men to the galleys, women to prison, their property being confiscated; but, though every frontier was patrolled, the exodus was general. Paris alone lost 1200 Huguenot families out of 1933; the *intendant* of Normandy soon reported 20,000 people missing from Rouen, 184,000 from his province; Nantes bewailed the loss of her workmen, Lyons had 14,000 looms silent and only 4000 working, Tours only 1200 instead of 80,000; woven goods were in future imported instead of being exported. The number of emigrants at this time alone seems to have exceeded 300,000, peasants, traders, manufacturers, nobles.

The ambassador in London sent word that 960,000 louis d'ors had been brought to the Mint for conversion into English coins; the total loss in mere gold was soon estimated at 20,000,000 livres. Marshal Vauban indeed trebled this figure, but was more in his element when saying that France had lost 8000 sailors, 10,000 soldiers, and 500 officers.

These exiles rallied round the prince of Orange, and for a generation cherished the hope of compelling some restoration and even of reforming the whole Gallican Church. New Huguenot regiments were soon embodied in Dutch pay. When William went to the rescue of England in 1688, his aides-de-camp were all French, the second in command was Marshal Schomberg, and the engineers and artillery were under other Huguenots. When the war was transferred to Ireland, every band of the exiles sent recruits; Schomberg fell fighting at the Boyne; Ruvigny saw the fall of Limerick, which ended the war. On the sea the exiled sailors had their share in the victories of La Hogue. But on the Continent, Louis was almost uniformly successful, and the peace of Rijswijk in 1697 depressed the hopes of the emigrants.

A second opportunity came with the war of the Spanish Succession. The prince of Orange was indeed dead, his principality was overrun by Louis and its Protestant population fled, but the Camisards (*q.v.*) made a serious diversion in the Cevennes while Louis was losing in Bavaria and the Netherlands. The Huguenot exiles this time fought in Portugal, and at Almanza in 1707 a new regiment of Camisards, commanded by Jean Cavalier, bayoneted a whole regiment that had figured in the Cevennes atrocities. The treaty of Utrecht in 1713 destroyed all hope of repatriation, and Louis could at last pretend to believe that Protestantism was extinct in France.

Huguenot influence was diverted in its flow from the main stream into many other channels. This began far back in its history; as early as 1536 some preferred England to France; thirty years later many silk-weavers set up their looms in the crypt of the metropolitan church of England, where Coligny's brother is buried and where their descendants worship to-day; Southampton has a 'God's House' whose records begin with 1567. Shakespeare lodged in London with Montioy of Creçy, and his *Venus and Adonis* was printed by the successor of Vautrollier. James I. had two Huguenot doctors, Chamberlen and Mayerne, and invited to court Casaubon and du Moulin. When Germany had been ravaged by the Thirty Years' War, a French church arose in Berlin in 1661. And the outflow from 1680 onwards was so great that the bulk of the stream was drawn off from France to enrich other lands. This may be noted specially for Brandenburg, Holland, and England.

The Great Elector replied at once to the revocation of the Edict of Nantes by the Edict of Potsdam, offering free transport from Frankfort, Colognè, or Amsterdam, free farms or houses, new churches, freedom from taxes for ten years, State support for ministers, their own judges. Waste lands soon blossomed with unknown vegetables, hemp, flax, and tobacco. The site of Magdeburg, desolate for fifty years, became a home of weaving and trade; Halle rose to rival Leipzig; Berlin gained all manner of manufactures; metal-workers fashioned tin, iron, and copper; to the West Indies and West Africa sprang up a brisk maritime trade, which, however, passed to Holland in 1720. French doctors revolutionized medicine, the gentry remodelled the army, scholars popularized Cartesianism, a college arose in Berlin, and a university at Frankfort-on-Oder. Society was created at the capital by them; the second and third kings of Prussia were brought up by a refugee.

The immigration to Brandenburg down the Rhine left many settlers by the way. Geneva gained 3000 inhabitants and the watch-trade as some recompense for boundless hospitality; a score of colonies arose in Württemberg, where French synods met until 1822; Homburg still maintains a French service; a village in Fulda yet keeps up the speech and customs of its founders. But the ravaging of the Palatinate hastened the steps of most of the exiles on to the Mark or the Netherlands.

The Calvinists of Holland gave an abundant welcome to their brethren. Collections were organized and loans granted, with support for the pastors; the craftsmen were allowed to practise and even welcomed into the gilds; and taxes were not levied for a term of years. Soon a synod of 202 exiled ministers met in Rotterdam, which visitors declared to be well-nigh French. Richly did the Huguenots repay their hosts. Some went to the colonies; in 1664 other exiles occupied Staten Island; and a New Rochelle arose on the banks of the Hudson. Under another flag all received naturalization in 1703. In Guiana, Huguenots filled Paramaribo; to the Cape went out a large contingent; and, though by 1739 the French tongue was compulsorily displaced, so that La Perle became Paarl, yet the Jouberts and Villiers are no small asset in South Africa to-day.

In the Netherlands themselves, Bayle and Jurieu brought the traditions of Sedan to Rotterdam; Claude, rival of Bossuet, whose influence was so dreaded that he was escorted from France at a day's notice, wrote at William's request a story of the persecution so effective that James burned it publicly; Saurin, after fighting in Savoy, studying at Geneva, preaching in England, added to the lustre of The Hague for a quarter of a century; Martin at Utrecht devoted himself to revising the Genevan Bible, and by 1707 completed a work that is still standard. For a century fine literary magazines in French streamed into France, Britain, and Germany; some of the editors also founded the first English magazines in London. Friesland settled her wastes, Utrecht gained a new silk and velvet trade at the expense of Amiens, Amsterdam added to her maritime trade 13,000 makers of silk, wool, linen, paper, and books. And, when it became clear that there could be no return, a general act of naturalization in 1715 encouraged the immigrants to melt into the general stock of burghers.

It might have been expected that Scotland would have rivalled Holland in its welcome, but only a few cambric-workers settled in Edinburgh. England kept up its Tudor traditions; Charles II. granted letters of denization freely from 1681, and appointed the archbishop of Canterbury with the bishop of London to aid the immigrants. In fourteen years £125,000 was subscribed, and doubled by public grants, whose interest went one-fifth to the pastors and four-fifths to start the others in business. Ipswich began to produce linen and sails; Norwich renewed its weaving, adding cutlery and clocks; Kent and Hampshire saw paper mills, Sussex glass factories; Wandsworth replaced Rouen as the source for hats, supplying even cardinals.

London attracted most of the settlers, especially when William of Orange became king, and a proclamation trebled the inflow. In 1701, Defoe (*The True Born Englishman*, pt. i. line 361 ff.) could point to the new leaven:

'Your Houblons, Papillons, and Lethuliers
Pass now for true-born English knights and squires,
And make good senate-members, or lord-mayors.'

Papillon and Dubois, indeed, were the sheriffs on whom Shaftesbury relied in the agitation on the Exclusion Bill twenty years earlier. Separate

services were maintained at first; thirty new churches arose, especially in Spitalfields, where the silk industry soon increased 2000 per cent, and in the new quarter of Soho. Some of the pastors, however, threw themselves into English life; de l'Aigle from the great temple of Charenton entered the Established Church, du Veil passed through it to the Baptists, Capel of Saumur taught in an Independent academy.

A club arose at the Rainbow Coffee House in Fleet Street, under Daudé of the Exchequer. Here met Rapin Thoyras, Le Moivre, La Croze, Coste, friend and translator of Locke, and Bayle; such men of science and letters soon created a new public feeling which embittered the popular English mind against the France of Louis XIV. Bayle's *Dictionnaire* was translated in 1709 by La Roche and others, and had no small share in the Deist movement; against that may be set Jurieu's *Treatise of Devotion*, and Drelincourt on *Death*. A new political doctrine, the Social Contract, was opposed to the Divine Right of Kings, by Jurieu and Abbadie; and, though they may have inherited it from the English Commonwealth men, it was destined to be taken from the Club by Voltaire and to work wonders in France by the pen of Rousseau. Scores of less known pamphleteers were the mainstay of the Whig cause for a generation; and in the rebellion of 1745, when the London merchants addressed King George, 99 out of 542 names were Huguenot, showing how large a proportion of commerce had fallen to them. This devotion to the land of their adoption was of old standing; as early as 1685 a society was formed to further true religion in England, and, fired by the new spirit of Methodism, the Christian Community labours still in Bethnal Green. No attempt was made to train new pastors in England, and the descendants of the immigrants learned not only to speak but to worship in English. Before 1760 most of the French services were discontinued; fifty years later there remained only four congregations in London, with others at Norwich, Canterbury, Southampton, Plymouth, and Bristol; to-day there are two chapels in Soho, one using the English liturgy in French. The absorption was quickened by a grant of general naturalization in 1774, and the gain in all departments of national life is suggested by such names as Chamberlain, de la Rue, Dollond, Dumaresq, Gambier, Hanbury, Labouchere, Layard, Martineau, Portal, Pusey, Rapin, Romilly.

In Ireland the great family of Ruvigny earned a new title as Earls of Galway, and laid out a model town at Portarlington, whose school turned out such men as the Duke of Wellington; not till 1817 did its French service cease. Fontaine and Latrobe introduced manufactures at Cork; and, though these were ruined by English legislation, Crommelin was more fortunate with the thousand wheels and looms for linen and cambric wherewith he refounded Lisburn; the French church here lasted till 1798. Waterford received manufactures and a wine trade, while its abbey resounded with French eloquence till 1819.

Tillers of the soil passed on to America, some to Oxford in Massachusetts, thousands through New York to Pennsylvania, the home of liberty. The new and balmy Carolinas attracted most; French Santee was laid out with vines and olives, and began to weave silk and wool. For a while the settlers looked wistfully to Louisiana, but when repulsed they gladly accepted the privileges freely tendered in the English colonies, strengthening not only the Carolinas, but Virginia and Maryland.

The Huguenots of the Dispersion thus carried with them to many a Protestant land a wealth of

probity, industry, gallantry, history, scholarship, science. Calvinism had too often become unlovely by transplantation; now it was invigorated and sweetened by this crossing from the parent stock. But the France which thus impoverished itself paid dearly; it was hard to believe in priests who hounded on persecution, and by 1790 the typical ecclesiastic was no longer Fénelon, but Talleyrand. Through the insipid and putrescent 18th cent. the Huguenots of the home land not only existed, but proved the very salt of the earth.

For a generation after 1685 they had, indeed, been deprived of all public worship and of pastors. Those who ventured back by stealth were often kidnapped into secret prisons, and their sober work was ill replaced by the ministry of the Prophets. But, with the new situation created by failure in war, a new species of pastor arose to minister to the Church in the Desert, men able to inspire and to reorganize. Leading preachers were told off to conduct peripatetic schools, and synods began again whose minutes were recorded.

Even in March 1715 the aged Grand Monarch had to admit that there were many Frenchmen who on their death-beds declined the rites of Holy Church; and the revival dated from that very year. The whole reign of Louis XV. (1715-74) certainly saw the persecuting laws maintained, and often executed, and the declaration of 1724, in codifying them, even added the touch that no marriage was valid outside the Established Church. But it proved as vain to fine people for absence from service as when Elizabeth tried it; and James VII.'s plan of levying on every village where the Covenanters met broke down as badly in France. Antoine Court began a seminary at Lausanne to supply trained pastors. Paul Rabaut proved himself a true Apostle of the Desert. Such huge gatherings came to hear him and other leaders that in 1745 the Assembly of the clergy pressed for a rigid persecution, which for seven years sent a large stream of emigrants abroad. By 1755 the Protestants of Saintonge even dared to build Houses of Prayer. A national Synod next year showed that there were again 10 ecclesiastical provinces with 48 pastors; and seven years later another showed 14, with 26 pastors and 35 licentiates.

By this time Catholic fervour had died down, and the soldiery did not like to enforce the laws. A crisis came after the execution of a pastor merely for preaching, marrying, and giving the sacraments; an atrocious miscarriage of justice caught Voltaire's attention, and in 1763 he issued a treatise on Toleration. With the accession of Louis XVI. in 1774, there came to power Turgot, who even earlier had published on the same theme. When a circular letter was ordered to be sent to all bishops, he sent it also to all the Protestant pastors of the south, thus acknowledging their existence, their status, their weight. Protestant records of birth and baptism were admitted as evidence.

Lafayette returned from America with fresh ideas on freedom, and in 1787 induced the Assembly of Notables to petition for the removal of Protestant disabilities: despite clerical opposition, civil registration of birth, marriage, and death was made valid that year. With the gathering of the States-General in 1789, public worship was conducted with open doors in Paris. By March 1790 the National Assembly was presided over by a young pastor, Rabaut St. Etienne, and it decreed that all property in royal hands confiscated a century and more ago from Protestant emigrants should be restored to their heirs, who might return and take up citizenship.

During the Reign of Terror, the aged Rabaut was silenced, and his brilliant descendant was

guillotined,—fates shared by other pastors,—while all buildings for worship were closed. But, when Napoleon was settling affairs in 1802, he grasped at the request of the Paris Protestants for concurrent endowment, and secured in return a control over their Church. The State dictated the constitution, with the sessions of synods, the control of the seminary, and even the number of pastors; a veto on all appointments was reserved also. It proved that there were about 430,000 Protestants in 171 churches, with 121 pastors. There was no property except the places of worship and the seminary, which was in 1809 transferred to Montauban and annexed to the university as a faculty of theology.

When the hand of Napoleon was removed, and the Catholic Terror was over, the Church began to grow. First Scottish theology quickened native thinking, then German. Even under the Legitimists there arose a Bible Society, a Tract Society, a Foreign Mission, and an Education Society. Leave was withheld for a National Synod to assemble, but an informal meeting in 1848 resulted in a division. A minority seceded, regaining freedom, adopted an evangelical confession, and arranged for biennial synods. The moderates clung to State pay, but drafted a scheme of reorganization on the historic lines, which the State refused to sanction.

In 1872 a National Synod met, the first since 1660, and the division was perpetuated. The general law of 1905, which separated all Churches from the State and abolished all State pay, has given rise to a third section aiming at reconciliation. There are nearly 800,000 of the Reformed, meeting in 900 churches, ministered to by 1000 pastors, with good organization and equipment. The influence on the national life is so important that it is only too easy to raise an outcry against the domination of the Protestants. International reputations have been won by Janet, Sabatier, and Scherer in theology, by Cuvier and de Quatrefages in science, by Guizot and Waddington in politics. The religious strength may be gauged by the honourable share taken in evangelizing the world. A mission to the Cape in 1829 extended to the Basutos four years later, and has met with much success, while the Zambesi was occupied in 1884; within French possessions, the Tahitian and Malagasy work was taken over from the London Missionary Society soon after annexation; in north Africa there are missions at Senegal and the Gabun, to the Kabyles, and on the French Congo.

LITERATURE.—*Les Classiques du protestantisme français*, Strassburg, 1883 ff.; *Collection de Documents inédits*, Paris, 1835 ff.; *Bulletin historique . . . du protestantisme français* [annual], Paris, 1852 ff.; A. Galton, *Church and State in France, 1500-1907*, London, 1907; A. J. Coquerel, *Précis de l'hist. de l'église réformée de Paris*, Paris, 1862; G. de Félice, *Hist. des synodes nationaux*, do. 1864, *Hist. des protestants de France*, do. 1874; E. and E. Haag, *La France protestante*, 10 vols., do. 1846-59, ed. H. Bordier, 6 vols., do. 1877-89; N. A. F. Puaux, *Hist. populaire du protestantisme français*, do. 1894; P. de Félice, *Les Protestants d'autrefois*, do. 1896-1902; *Proceedings and Publications of the Huguenot Society*, London, 1885 ff., and Lymington, 1887 ff.; *Geschichtsblätter des deutschen Hugenotten-Vereins*, Magdeburg, 1894 ff.

For special periods.—Calvin's correspondence in the *Corpus Reformatorum*; (J. de Serres), *Hist. des cinq rois*, Dort, 1598; T. de Bèze, *Hist. ecclésiast. des églises réformées de France*, Antwerp, 1580, ed. Toulouse, 1882; documents in *Le troisième Centenaire de l'édit de Nantes*, Paris, 1898; A. L. Herminjard, *Correspondance des réformateurs*, 8 vols., Geneva, 1866-86; J. A. de Thou and N. Rigault, *Hist. universelle* (1543-1610), many editions; E. Doumergue, *Jean Calvin*, 3 vols., Lausanne, 1899-1905; N. A. F. Puaux, *Hist. de la réformation française*, 7 vols., Amiens and Strassburg, 1859-63; H. M. Baird, *Theodore Beza*, New York, 1899; A. W. Whitehead, *Gaspard de Coligny*, London, 1904; E. Sichel, *Catherine de' Medici and the French Reformation*, do. 1905; J. W. Thompson, *Wars of Religion in France, 1559-76*, Cambridge, 1911; H. Hauser, *Les Sources de l'histoire de France, xvi^e siècle*, lll., *Les Guerres de religion*, Paris, 1912; P. Imbart de la Tour, *Les Origines de la réforme*, 2 vols., do. 1905-09; Ch. Bastide, *Anglais et Fran-*

çais du xvii^e siècle, do. 1912; J. Quick, *Synodicon in Gallia reformatata*, 2 vols., London, 1692; J. Aymon, *Tous les Synodes nationaux des églises réformées de France*, Hague, 1710; I. d'Huisseau, *La Discipline des églises réformées de France*, Bionne, 1675; [E. Benoit], *Hist. de l'édit de Nantes*, 5 vols., Delft, 1693; C. Brousson, *État des réformés en France*, 3 vols., Hague, 1685; J. Claude, *Les Plaintes des protestants de France*, Cologne, 1686, ed. F. Puaux, Paris, 1885; H. M. Baird, *The Huguenots and the Revocation of the Edict of Nantes*, London, 1895; C. Benoit, *La Condition des protestants sous le régime de l'édit de Nantes et après sa révocation*, Paris, 1900; C. Hugon, *Social France in the 17th Century*, London, 1911; L. Pilatte, *Édits, déclarations et arrêts . . . 1662-1751*, Paris, 1885; J. Lemoine, *Mémoires des évêques de France sur la conduite à tenir à l'égard des réformés (1698)*, do. 1902; C. Bost, *Les Prédicants protestants des Cévennes et du Bas-Languedoc, 1684-1700*, do. 1912; M. Misson, *Le Théâtre sacré des Cévennes*, London, 1707; A. Court, *Hist. des troubles des Cévennes*, 3 vols., Villefranche, 1760; G. Frosterus, *Les Insurgés protestants sous Louis XIV.* (documents), Paris, 1868; J. Fontaine, *Mémoires d'une famille huguenote*, etc., Toulouse, 1877, Eng. tr., London, 1874; U. de Robert-Labarthe, *Protestantisme dans le Haut-Languedoc . . . 1685-1789*, Paris, 1892-96; S. Smiles [and G. P. Disosway], *The Huguenots . . . in England and Ireland [and America]*, New York, 1868; R. L. Poole, *Huguenots of the Dispersion*, London, 1880; C. Weiss, *Hist. des réfugiés protestants de France*, Paris, 1853, Eng. tr., with Amer. supplement, New York, 1854; C. W. Baird, *Huguenot Emigration to America*, 2 vols., New York, 1885; Frank Puaux, *L'Établissement des protestants français en Suède*, Paris and Stockholm, 1891; L. J. Fosdick, *French Blood in America*, New York, 1906; A. Court, *Mémoire hist. . . 1744-1751*, Amsterdam, 1752; E. Hugues, *Les Synodes du désert . . . 1715-1793*, 4 vols., Strassburg, 1885-87; C. A. Coquerel, *Hist. des églises du désert*, 2 vols., Paris, 1841; O. Douen, *Les premiers Pasteurs du désert*, 2 vols., do. 1879; E. Hugues, *La Restauration du protestantisme en France*, 2 vols., do. 1872, *Union des églises évangéliques de France*, 6 vols., do. 1850; G. de Félice, *XXX^eme Synode générale*, etc., do. 1878; *Actes et décisions du synode . . . à St. Quentin . . . 1887*, Marseilles, 1887; *Actes . . . à Sedan, 1896*, Alençon, 1896; *Agenda-Annuaire protestant* [annual], Paris, 1879 ff.; C. Coignet, *L'Évolution du protestantisme français au xix^e siècle*, Paris, 1908; F. Puaux, *Les Œuvres du protestantisme français au xix^e siècle*, do. 1893; P. Sabatier, *Disestablishment in France*, London, 1906; W. Bousset, *Faith of a Modern Protestant*, do. 1909; T. Arbousset, *Tahiti et les îles adjacentes*, Paris, 1867; *Madagascar et le protestantisme français* (anon.), do. 1897; E. Casalis, *My Life in Basuto Land*, London, 1889; F. Puaux, *Les Bassoutos*, Paris, 1881; F. Coillard and G. Appia, *La Mission au Zambèze*, do. 1880; F. Coillard, *On the Threshold of Cent. Africa*, Eng. tr., London, 1897; T. Jousse, *La Mission française évangélique au sud de l'Afrique*, Paris, 1889; A. Boegner, *Livre d'or de la mission du Lessouto . . . 1833-1908*, do. 1912; E. Desribes, *L'Évangile au Dahomey*, do. 1877.

W. T. WHITLEY.

HUICHOLS.—This tribe, numbering to-day about 4000 souls, lives in a mountainous country, difficult of access, in the N.W. part of the Mexican State of Jalisco, on a spur of the great Sierra Madre. They are the eastern neighbours of the Coras, or Nayarits, to whom they are related by language, religion, and customs. Both tribes in the 18th cent. had been Christianized. The Coras still retain a priest and call themselves Christians, though their Christianity is to a large extent mixed up with pagan customs. But the Huichols, since the departure of the monks, have completely fallen back into their ancient religious practice, and represent a very curious survival of ancient Mexican religious faith and idolatry.

The principal god of the Huichols is *Tatévali*, 'our grandfather,' the fire-god. He is the god of life and health, and the particular god of the shamans, especially of those who heal and prophesy. He was the first who sat down on a chair, and is held to be more ancient even than the sun. Sometimes he is represented not by one, but by two images. One stands above ground, and the other in a cavity beneath it. The latter is invariably the smaller and the older of the two, and is regarded as closely associated with the sun after it has set, or the sun of the under world, while the upper image is supposed to be associated with the sun of the day-time, or of the upper world. There exists another form of the ancient fire-god, called *Tatotsi Mára Kwári*, 'our great grandfather deer-tail.' He is considered to be the spark produced by striking flint, and is the chief deer-god.

The sun is called by the Huichols *Tayaú* or *Taú*, 'our father,' or *Tavérika*, 'our eagle.' It is related that the ancient shamans made Father Sun by throwing the young son of the Corn-Mother (or, according to others, the young son of young Mother-Eagle, the goddess of the Sky) into an oven, arrayed in full attire, with sandals, pouches, and tobacco gourds, and carrying his bow and arrows. From the oven the boy travelled underneath the ground, and rose as the sun in the East. The assistant of Father Sun is *Tayaú Sakaimoka*, an image of whom stands on the high mesa of the Nayarits, above the Cora pueblo of Sierra del Nayarit, where the Coras and Huichols deposit ceremonial arrows and other offerings in a cave. This god is considered to be the 'serpent-god,' represented by a zigzag line of blue colour, and was in former times 'the Sun's arrow.'

The great god of the Coras and Huichols is *Tabátzi* (Cora) or *Tamáts* (Huichol), 'our elder brother,' the god of the morning star. He is the messenger of the gods; and, when the shamans sing, he communicates their songs and whistles to the other gods. He himself is called *tondami*, the 'singer,' by the Huichols. He is, at the same time, declared to be the god of wind or air. He is the shooting god, who made the first arrows for the gods, the god of the hunter, and is himself represented by a gigantic deer.

The growth of maize and other vegetables is ascribed to a goddess, called *Takótsi Nákawé*, 'our grandmother growth.' She is the mother of the gods, especially of Grandfather Fire. All the earth belongs to her, and she lives in the under world. People implore her for long life, because she is very old. The goddess called *Táté Tulirikita*, 'our mother, house of the little ones,' the goddess of conception and birth, and *Táté Ikú Oteganáka*, 'our mother the Corn,' the special goddess of maize and other vegetables, seem to be other forms of the same mythological notion.

Táté Naaliwámi, the red serpent, the red cloud, is mainly a water- and rain-serpent who brings rain from the East. She is the creator of squashes and of all flowers, and takes special care of children. Her complementary deities are *Táté Kyewimoka*, a white serpent whose dwelling is in the West, and who brings rain from the West; *Táté Rapawiyáma*, a blue serpent, living in the Laguna de la Magdalena, four days' journey south of the Huichol country, who brings rain from the South; and *Táté Haútse Kupúri*, a yellow serpent, living in a lagoon to the north of the Huichol country, who brings rain from the North. Finally, the goddess of the heavens, *Táté Velika Uimáti*, 'our mother, the maiden eagle,' is the mother of Father Sun; she holds the world in her talons, and guards everything from above, where she dwells. The stars are her dress. All these gods and goddesses are clearly recognizable counterparts of well-known Mexican divine types.

The cult of the Huichols consists in libations, in offerings of food and drink, and in preparing cakes of the ground seeds of *Amaranthus leucocarpus*, called *wave* by the Huichols (=Mex. *wauhtli*). Besides sacrifices of this kind, they offer to their gods remarkable symbolic objects. They are embodiments of prayers, or charms intended to produce the object of the prayer, and are mainly found in the god-houses and sacred caves. Ceremonial arrows (*ulu*), sometimes in great numbers, are stuck into the inner side of the thatched roofs of the god-houses, or into the seats of ceremonial chairs. A great many symbolic objects of various colours and shapes are attached to the arrows, and others hang from the roof, while on the altar may be seen rudely carved and decorated wooden images of the animals dedicated to the god.

Another kind of symbolic object is called *nealika*, 'face.' These are shields, round in shape, made by interweaving pieces of split bamboo with cotton cord, or variously coloured crewels, symbolic and mythological figures being represented in the weaving. They are mostly prepared for *Tayaú*, 'Father Sun,' and *Táté Naaliwámi*, 'Mother East-water.' The central part, always defined by a ring, represents the hole through which the god sees. Compare the ancient Mexican ceremonial object, called *tlachieloni*, 'instrument for seeing,' the special outfit of the Mexican god of fire and of Tezcatlipoca. The objects called *nama*, 'mat,' of rectangular shape, seem to be representative of a cloth hanging over the back of the gods. Very curious ceremonial objects are those called *sikuli*, 'eye'—crosses of split bamboo, interwoven with crewel or yarn, and resembling in the most striking way objects that are met with in Peruvian graves stuck in the soil at the foot of the mummy packet. According to the interpretation given by the explorer Charles Lumholtz, the prayer expressed by this symbolic object is that the eye of the god may rest on the supplicant.

From May to August, there are frequent feasts for making rain. During the wet season, if it stops raining only for two or three days, the principal men gather in the temple and decide to sacrifice an ox or two for the propitiation of the gods. Two children called *ákeli* (from Spanish *ángeles*) play an important part at these feasts. One of them belongs to *Tayaú*, 'Father Sun,' and the other to *Tátévali*, 'Grandfather Fire.' Toasted maize-cakes, made in the form of an S (symbols of the lightning, according to the symbolism of the ancient Mexicans), and others made in the form of 'eyes,' of feathered snakes, flowers, and dogs are tied to a twine of bark fibre and offered to the gods. They are called *kóka*, 'bead,' 'necklace,' as they are looked upon as the necklaces of the gods to whom they are dedicated. In October the feast of green squashes is held, called *wimá kwári*, 'to beat the drum,' the squashes representing the gourd-rattle (*kaitsa*)—the rattling noise which the dry seeds make inside the squash when shaken. The children are brought to the god-house, wearing on the head a *sikuli*, or 'eye' (which in this ceremony seems to represent the squash-flowers), and carrying rattles in their hands. For this feast is held in honour of *Táté Naaliwámi*, the creator of squashes and all flowers, the special patroness of children. It is a great prayer for growth, health, luck, and plenty to eat.

All priests and shamans use tobacco, which the Huichols, like the ancient Mexican priests, carry about with them in a gourd hanging over the back, this tobacco-gourd being the essential and most necessary outfit of priests of every class. Besides tobacco, there is another intoxicating plant which plays a very important part in the life of the modern Huichols and other living tribes of the Mexicans, as it did, according to the chroniclers, with the Chichimeks, the nomadic tribes of the northern parts of Mexico in ancient pre-Hispanic times. This plant, called in the Mexican language *peyotl* (by the Huichols, Tarahumares, and other tribes of the Sierra, *hikuli*), is a small species of cactus (= *Anhalonium Lewinii*, Hennings), which grows abundantly in the central mesa, especially in a country which the Huichols call Paliátsia, not far from the mining town Real Catorce, in the State of San Luis Potosí. It is thought to be necessary to procure it every year, to ensure the country against drought; and, therefore, in October parties of from two to twelve start on a pilgrimage to Paliátsia; the journey, which is accompanied by much fasting and praying, requires 43 days. The leader of the party and the second in order

carry a *nealika* ('face,' front-shield) of *Tatévali*, 'Grandfather Fire,' while the rest carry those of other gods. The *peyotl*-seekers are supposed to be accompanied on this journey and guided by the grey squirrel. If one of them sees a *peyotl*, he shoots towards it, not quite hitting it, but lodging one arrow to the right, and one to the left over it. In this way every one shoots five *peyotls*. The plants are strung on long strings to dry. When the feast comes on, the dry plant is mixed with water and has invariably to be ground on the *metate*, or grinding-stone. A thick kind of drink, rather brown in colour, is produced from it, which is offered in small quantities, but at frequent intervals, to those present. This feast occurs in the month of January. It forms an integral part of the feast for eating roasted maize (*raki*), and is, accordingly, named *Karikira*. But it cannot take place until a certain number of deer have been killed, or until the field has been cleared and made ready for the harvest of the coming year.

The greatest feast of all is that for eating maize-cakes made from ground maize baked in an oven (*tamales de maiz crudo*). Like that of roasted maize, this feast can be held only after successful deer-hunts. The heaps of tamales are dedicated by the priest to all gods. When this occurs, some of the people are appointed to blow into sea-shells five times in the day-time and five times at night. Connected with this feast is a ceremonial race performed by young men and women in separate groups. The feast is held for the under world.

LITERATURE.—C. Lumbholtz, 'Symbolism of the Huichol Indians,' in *Mem. Amer. Mus. of Nat. Hist.*, New York, 1900, also *Unknown Mexico*, London, 1903. ED. SELER.

HUMANISM.—'Humanism' in philosophy is opposed to Naturalism and Absolutism (*q.v.*); it designates the philosophic attitude which regards the interpretation of human experience as the primary concern of all philosophizing, and asserts the adequacy of human knowledge for this purpose. By thus putting man into the centre of the intellectual universe and giving to all science and literature a reference to human life and its purposes, philosophic connects itself with literary Humanism (see following article). The literary Humanism of the Renaissance, which was essentially an attempt to emancipate thought and education from what it considered the narrow scholastic routine of the mediæval Church by appealing to the civilizing mission of the 'humaner letters' (*i.e.* of classical, and more particularly Greek, literature), thus appears to be included in philosophic Humanism as one of its manifestations. The intellectual movement of the 5th cent. B.C. in Greece, which was initiated by the Sophists and continued by Socrates, is also to be cited as such an era of human revolt against the domination of pedantic, abstruse, and sterile speculation—in this case the systems of the metaphysical 'physiologers.' In fact, modern Humanism is so largely and avowedly a conscious revival of the critical relativism of Protagoras and appeals so explicitly to his maxim that 'man is the measure of all things' that it may without injustice be described as Neo-Protagoreanism. But, though Humanism is confessedly a relativism, and as such is a denial of the *transcendence* of the real and the true, and is opposed to every form of Absolutism (whether in metaphysics or in epistemology) which ignores or destroys their relation to man, it denies on behalf both of itself and of its forerunners that its relativism is to be identified with scepticism. It holds, on the contrary, that the truth and reality for man which are attainable by man are also sufficient for man, and that scepticism is the inevitable outcome of Absolutism so soon as it is

perceived that 'absolute' truth and reality can only be so defined as to be (in fact) unattainable by man. It thus differs from Positivism (*q.v.*) in being willing to assume the adequacy of human knowledge to human needs and in contenting itself with this, in being critical, rather than dogmatically disdainful, of metaphysics, and, above all, in admitting every hypothesis as worth trying which has a human interest and appeals to any side of human nature. It is this open-mindedness that may bring it into conflict with Naturalism, as it may reconcile it even with Absolutism, in so far as the latter can be exhibited as really containing an answer to genuine human demands. But at present it is in dispute whether any 'absolutist' doctrine of knowledge, truth, and reality can really establish any relation between its ideals and the human uses of these terms.

To Pragmatism (*q.v.*), Humanism is closely related. But Pragmatism, though it sends its roots down into a number of sciences, is intrinsically a theory of knowledge, while Humanism is a more general philosophic attitude. William James calls it 'a ferment that has come to stay,' and a 'shifting in the philosophic perspective, making things appear as from a new centre of interest' (*Meaning of Truth*, p. 121). It may be regarded as a natural and logical development of the Pragmatic method of testing knowledge by its human value, when it is extended beyond the problem of testing truths and applied to the other sciences. For the doctrine that all truths are useful implicitly requires that all truth should be related to human purposes, and that this reference should be traced explicitly throughout all the sciences. If truths are useful, they are valuable for man, and the specific character of this value in every science can be stated. Conversely, in proportion as a science can be viewed in its relation to man, it can be utilized for human purposes. Thus, the discovery of the usefulness of knowledge undermines the 'independence' of the sciences and humanizes them; their claim to absoluteness cannot survive the discovery of their man-made character and of the artificial and methodological nature of their principles, even when they seem most abstract and unhuman. Humanism, therefore, like Pragmatism, is primarily the name for a method, and not for a system of philosophy; it is more particularly a protest against the dehumanizing of logic which results from assuming that the personal antecedents, context, and purpose of judgments may be abstracted from in considering their cognitive purport. The humanist criticism of logic (see, *e.g.*, the writer's *Formal Logic*, London, 1912) therefore aims at showing that the attempt to abstract from this human side of thinking reduces the traditional logic to mere verbiage. The humanist attitude implies also a *critical* method of estimating the value of the claims to truth put forward by the various systems of metaphysics. This necessarily renders it very destructive to what is called 'metaphysics.' For metaphysical systems have usually been put forward dogmatically, with claims resting on self-evident 'intuitions' or an alleged completeness, and with pretensions to absolute and exclusive truth. To their humanist critic, however, no claims are valid merely as such; all must be validated by the value of their consequences. The claim to an exclusive possession of absolute truth he takes to be sufficiently refuted by the existence of conflicting claims and by the historic impossibility of finding any two philosophers whose systems are really in agreement. Hence he infers that metaphysical systems are essentially individual creations and relative to the idiosyncrasies of their authors, and justifies this view by the fact that the materials for the construction are naturally individual, and

so to some extent different in each case. It follows that it is not so much the right to construct metaphysics that is called in question as the claim to infallibility and the coerciveness for others of any philosopher's personal system. Thus Humanism makes for toleration and abolishes the right to persecute which is implied in the belief in an absolute and immutable truth which is the same for all, but substitutes for this the notion of a common truth which rests upon social agreement and is being continuously elaborated and improved in the growth of human knowledge. The general effect of this, again, is to diminish the philosophic importance of dialectical subtleties which appeal only to a few, and of merely intellectual reasonings as such, and to enhance that of the common-sense notions which have long ago been evolved by man for the guidance of his actions.

LITERATURE.—Historically the philosophic usage of the word 'Humanism' is of very recent origin. It seems first to occur incidentally as a tentative descriptive term equivalent to 'anthropocentric' and opposed to 'naturalistic' in A. Seth Pringle-Pattison's *Man's Place in the Cosmos*, London, 1897, p. 61; also in *Mind*, new ser. ix. [1900] 436 (used by W. Caldwell of Eucken's 'ethicalism') and xi. [1902] 406. The present writer first proposed (in 1903) to appropriate it technically for the more extended forms of Pragmatism, as held by William James and himself and expressed in James's *Will to Believe* (New York and London, 1896; cf. Preface). He defined it as above, in conscious opposition also to Absolutism, in the Preface to his *Humanism* (London, 1903); cf. his *Studies in Humanism* (do. 1907). This usage was sanctioned by William James in an article on 'The Essence of Humanism' (*Journal of Philosophy*, 1905, II. 6, reprinted in *The Meaning of Truth* [London, 1910]) and in his *Pragmatism* (do. 1907, Lectures vi. and vii.). Cf. also D. L. Murray's *Pragmatism*, London, 1912, p. 71f. The word has been used, in a too vague sense, merely connoting 'interest in man,' by J. S. Mackenzie in his *Lectures on Humanism*, London, 1907 (cf. the review in *Mind*, xvi. 606). It is also used, in religious contexts, by secularists as the opposite of 'supernaturalism.' F. C. S. SCHILLER.

HUMANISTS.—I. GENERAL.—The transition from the mediæval to the modern world seems one of the most abrupt in the pages of history. Certainly it did not take place even in the same century in the different lands,—the harvest in Italy was over before the seed was sown in Scotland,—nor did the various fields of human life quicken to the new impulse with a simultaneous response, but the emergence of the new order followed hard on the thrill of expectation. The whole complex movement which wrought the transformation in the outlook of men we call the Renaissance (*q.v.*). Humanism was the intellectual centre of the movement: in the Humanists we find its conscious pioneers and promoters.

The name 'Humanist' itself indicates the nature of the movement. Just as in the Scottish Universities the term 'Humanity' is still used as a designation for the Latin language and literature, and as in wider circles classical studies in general are summed up as 'the Humanities'—*litteræ humanæ*, or *litteræ humaniores*,—so the Humanist is the student of humane letters, the languages and the literatures of Greece and Rome. The work of the Humanists was to disinter the buried classics, to restore a lost means of culture, to recapture an ancient charm of style, and a broader humanity of spirit.

But the change was not so sudden as it seemed. There were signs of the approaching dissolution of Mediævalism before the Renaissance proper began. From the 11th cent. there were traces of the dawn.

A. Bartoli (*I Precursori del rinascimento*, Florence, 1877, p. 19f.) would date it from the reaction from terrorism which took place when the year 1000 passed and left the world undestroyed. But both the preceding darkness and the succeeding light have to be exaggerated to make this plausible. There was also a partial revival of learning in the 12th cent., due in great measure to the discovery of works of Aristotle of which all trace had been lost; but, since Aristotle as understood or misunderstood was one of the cramping forces from which Humanism set men free, it is vain to seek any real connexion. The 13th cent., however, certainly saw precursors of the Renaissance, and men whom we may call, with but little over-estimation of their significance,

'Humanists before Humanism.' In men like Robert Grosseteste (1175–1253), whose interest in the origins of Christianity led him to give to the world, through the help of others, Latin versions of Greek works then attributed to primitive times, and Roger Bacon (1214–94), who toiled so unweariedly at the 'original tongues,' and who felt so keenly the blanks in the extant writings of the Fathers, we see genuine, though isolated, foregleams of the coming revival. The 13th cent. saw also Universities founded in various countries of Western Europe, particularly in Italy, England, and Spain, bearing witness to a new and widespread zeal for education, a fresh kindling of enthusiasm for things intellectual. But these Universities soon fell into the hands of the dominant Scholasticism, and became strongholds of mediæval tradition.

The Humanist movement proper begins in Italy in the 14th cent., and its first great name is Petrarch. The contrast between the new era and the old is very clearly seen in two interesting passages from the works of Erasmus. In 1518, when the false news of the death of the greatest of the Humanists from the plague at Louvain spread throughout Europe, the monks of Cologne are said to have rejoiced that he died the death of a heretic 'sine lux, sine crux, sine Deus.' Here the narrow intensity of the spirit and the barbarity of the language testify to the double pit from which the Humanists sought to deliver Europe. In the preface to his edition of Jerome, Erasmus writes:

'We kiss the old shoes and dirty handkerchiefs of the saints, and we neglect their books, which are the more holy and valuable relics. We lock up their shirts and clothes in jewelled cabinets; but as to their writings on which they spent so much pains, and which are still extant for our benefit, we abandon them to mouldiness and vermin.'

The homage which had been lavished on the relics of saints ancient and modern was turned by the Humanists into a new channel. Men began to revere the works of the great minds of the ancient world, at times with all the old blind devotion. When Petrarch received the MSS of Homer and Plato from Nicolaus Syocerus of Constantinople, he kissed them, and sighed over them; and, though he had not Greek enough to read them, he declared that thus to look upon the Greeks was an inspiration.

The Humanists were one and all scholars, with a great love for learning, and a genuine appreciation of beauty of form and thought, 'with the generous belief,' to use the phrase of Pater (*The Renaissance*, popular ed., London, 1912, p. 37), 'that nothing which had ever interested the human mind could wholly lose its vitality'—scholars who, despite their manifold differences, were alike in this, that they rebelled against the barrenness and dogmatism of Mediævalism. Into a world where all thought was ordered by the Church, and all secular activity moulded by the Feudal system, there came through them a breath from the distant past, resulting in a re-discovery of the world and of man.

It is only the revolt from Mediævalism as an enclosed and final scheme of thought that concerns us here; the political, social, artistic, and scientific revivals belong to the wider term Renaissance, and the ecclesiastical and religious to the Reformation.

This revolt from Mediævalism was more complete in some circles than in others. The extent of it was the cause of a short but sharp disagreement between two of the most kindred spirits among the Humanists, John Colet and Erasmus. In a conversation on the Schoolmen and their limitations, Erasmus more than once tried to make an exception of Thomas Aquinas, on the ground that he had at least studied the Scriptures and some ancient literature; but Colet would have none of it:

'Why do you extol him to me? If he had not been exceedingly arrogant, he would not with such rashness and such pride have defined everything; and unless his spirit had been somewhat worldly, he would not so have contaminated the whole teaching of Christ with his profane philosophy' (Erasmus, *Opera*, Leyden, 1703–06, lii. 458).

Further study of Aquinas brought Erasmus round to Colet's way of thinking. But the kind of disagreement which came to sharp expression in

this conversation was more fundamental and more permanent in other quarters.

The common characteristic of the Humanists is this escape, more or less thorough, from the fetters in which human thought had been confined—an escape into a wider, freer world where all facts were relevant, where all theories had to be tested by relating them to their discoveries, and all formulæ recast in accordance with their new-old light—an escape whose prime cause was the new enthusiasm for the poets, historians, and philosophers of Greece and Rome, the Fathers of the Church, and the Scriptures of the OT and NT in their original tongues, regarded no longer through the distorting medium of allegorical interpretation, but reverently, patiently, and critically studied.

It is when we attempt to find any common characteristic of the wider, freer world into which they escaped that anything like exact definition becomes impossible. To some minds, coming into direct contact for the first time with certain parts of that ancient literature, the most potent thrill was a sense of relief at entering a region where there seemed to be unqualified liberty and no restraining authority. They absorbed with avidity the vices as well as the virtues of Paganism. The *Facetiarum Liber* of Poggio—a Papal secretary—showed the length to which this tendency might go uncondemned by the Church. The *Hermaphroditus* of Beccadelli—the extreme example of this type—fortunately met with a different reception. Hailed with delight by many of the Humanists, it was unsparingly denounced by the better sort of Churchmen. To others, Humanism meant chiefly the escape from the arid desert of a fragmentary Aristotle to the fertile fields of Platonic speculation, and there arose an enthusiasm for Plato and the Neo-Platonists whose most prominent devotees were Marsiglio Ficino and Pico della Mirandola—an enthusiasm which spread from Florence throughout Europe. To still a third group, and it was the most permanently influential, the Fathers of the Church and the New Testament itself gave the first glimpse of religion in an older and purer form, and their energy was directed to a Renaissance or Restitution of Christianity. Erasmus, who declared that 'the highest object of the revival of philosophical studies will be to become acquainted with simple and pure Christianity in the Bible' (quoted in M. Dods, *Erasmus and other Essays*², London, 1892, p. 24), is the most prominent member of this group. So the Humanist movement, so positive in its discoveries, so enduring in its effects, can be defined only negatively. It was a revolt more or less complete with a new sense of freedom and individuality, a deliverance from bondage into a world of no restraints, but to many of new and high constraints. Every shade of free activity, from one end of the spectrum to the other, from the unblushing libertinism of the newly emancipated to the reforming zeal of those who had found the highest and final standard, is to be found within the ranks of the Humanists.

II. HUMANISM IN THE VARIOUS COUNTRIES.—Although Humanism had its distinguished representatives over most of Europe, and although the movement in one nation or group of nations naturally affected its neighbours, yet the history of the movement in each nation is so distinct that it will conduce to clearness to take them separately.

1. Italy.—It was natural that the revival of learning should take its rise in Italy, partly because of its proximity to the Eastern Empire, but mainly on account of its local and hereditary connexion with the glory of the past of Rome. A revival which was patriotic in spirit, antiquarian in its interests, but sporadic in its manifestations, prepared the way for Petrarch.

Francesco Petrarca (1304–74) has been rightly acclaimed as the first of the Humanists. His great predecessor, Dante (1265–1321), is a citizen of two worlds, mediæval and modern; Petrarch is the first true modern. It is noteworthy that the decisive impulse came to him from Cicero, in slavish imitation of whom the Humanism of Italy, almost two centuries later, first showed the fatal symptoms of decay. He loved Cicero from his school-days and read him eagerly, not with a view to advancement in his profession of the law, but because of his delight in his majestic swing and balanced periods. It was the style that fascinated him from the beginning. Another impulse came from the sight of Rome (1336) deserted by the Popes, yet full of monuments eloquent of past grandeur. Cicero and the other neglected Classics were to him the gateway into the understanding of this ruined splendour. So, despite many an early discouragement, he pursued his studies in the literature of Rome. In his correspondence and in most of his writings he used a Latin moulded on the Classics. He was prouder of his *Africa* and *de Viris Illustribus* than of the Italian *Rime* or *Canzoniere* on which his fame now rests. To seek out MSS, particularly of Cicero, was perhaps his most absorbing pursuit. His letters are full of the delight of discovery and the chagrin of loss. He made an attempt to master Greek. It failed because of the early departure of his teacher, and, he confesses, the strangeness of the foreign tongue. But he never ceased to exhort younger men to acquire it. Along these lines lay the activity of the first of the Humanists, and, as J. A. Symonds says (*Renaissance in Italy*, vol. on 'The Revival of Learning,' new ed., London, 1902, p. 54):

'In this susceptibility to the melodies of rhetorical prose, in this special cult of Cicero, in the passion for collecting manuscripts, and in the intuition that the future of scholarship depended upon the resuscitation of Greek studies, Petrarch initiated the four most important moments of the classical Renaissance.'

Petrarch's devotion to the Classics led to no breach with the Church. He criticized some of its abuses, though belonging himself to its priesthood, and conspicuously avoiding all ecclesiastical duties. His learning did not tend to Paganism; the ancient culture was to him a handmaid to Christianity. Of the law and philosophy of his day, however, he spoke with open scorn. It was mere empty sophistry, unprofitable mental gyrations. In these things, and in other less admirable respects—in his irritability under criticism, his prodigious appetite for flattery, his overweening desire for personal fame, and his inveterate habit of posing—he foreshadowed the activities and failings of his successors. His labours served to inspire others with similar ideals, and they created the atmosphere necessary for their development.

Giovanni Boccaccio (1313–75), a younger contemporary of Petrarch, was his most distinguished disciple. If Petrarch has the honour of being the first of the Humanists, to Boccaccio belongs that of being the first to acquire anything like a working knowledge of Greek. His teacher was the pretentious Leontius Pilatus, and the knowledge he acquired was not very profound, but still it was a beginning. Devoted to Petrarch, he followed his guidance. He had sound ideas about collating MSS, and a genuine reverence for every ancient writing, however unworthy. His main departure from the ideas of his contemporary and master was in his bitter hatred of the monks, as the opponents of learning, and hypocritical pretenders to sanctity. With Boccaccio, Florence becomes the headquarters of the Humanists. The brightest stars in its galaxy were Luigi Marsiglio (1342–94), the soul and leader of the Florentine club of Humanists, which was the true University of the

time; and Coluccio Salutati (1330-1406), the Chancellor of State, whose official letters were copied and treasured for their style. Gian Galeazzo Visconti of Milan declared that one letter of Salutati's could do him more harm by its style than a troop of paid mercenaries.

It was through the influence of Salutati and his circle, particularly Palla degli Strozzi, that the first competent teacher of Greek was brought to the West. This was Manuel Chrysoloras, who taught in Florence from 1397 to 1400, and until 1415 in other parts of Italy, and whose *Erotemata* was the earliest Greek grammar of the revival. 'Through seven hundred years,' wrote one of his earliest and most distinguished pupils, Leonardo Bruni (1369-1444), 'no one in all Italy has been master of Greek letters.' 'Chrysoloras of Byzantium . . . brought to us Greek learning.' Among his successors in the teaching of Greek in Italy were George of Trebizond, who taught in Venice and Rome as well as in Florence; Theodorus Gaza, teacher in Ferrara (1441-50) and afterwards in Rome, whose Greek grammar, fuller and more scientific than that of Chrysoloras, Erasmus used in his classes in England; John Argyropoulos, in Florence (1456-71), afterwards in Rome, the teacher of Lorenzo de' Medici, Politian, and Reuchlin; Demetrius Chalcondylas of Rome and Perugia; and John Lascaris who, by his residence in Paris, left his mark on the Humanism of France. Greek learning was therefore not brought to Italy by scholars fleeing with their precious MSS from Constantinople at the fall of the Eastern Empire; it was during the half century which preceded its fall that, on the earnest request of the Italians themselves, the earliest Greek scholars settled in Italy. Vergerius, writing probably in 1404, in his *de Ingeniis Moribus*, expressed the mind of many: 'It is hard that no slight portion of the history of Rome is to be known only through the labours of one writing in the Greek language: it is still worse that this same noble tongue, once well nigh the daily speech of our race, as familiar as the Latin language itself, is on the point of perishing even amongst its own sons, and to us Italians is already utterly lost, unless we except one or two who in our time are tardily endeavouring to rescue something—if it be only a mere echo of it—from oblivion.' The impulse to Greek study came not from the supply of teachers, but from the demand thus evidenced in the longing of Italian scholars, and their sense that the time might be short.

One other agent in the revival of Greek deserves to be named apart. This was Gemisthos Pletho (1355-1450), whose presence at the Council of Florence in 1438 turned many of the Humanists to the special study of Plato and the Neo-Platonists. Pletho's aim seems to have been to supersede the Christian Church and the religions of the world by a Neo-Platonic Mysticism. Cosimo de' Medici (1389-1464), carried away by his eloquence and his 'indiscriminate erudition,' founded the Florentine Academy and resolved to train up the youthful Marsiglio Ficino (1433-99) to be the expositor of Platonic philosophy to the West. In 1482 appeared Ficino's translation of Plato, and, four years later, that of Plotinus. But his spirit was far different from that of Pletho. There was no thought in his mind of superseding Christianity. Plato and Christ were colleagues rather than rivals. Whether the practice ascribed to him of keeping two candles burning in his room, one before a bust of Plato, and the other before an image of the Virgin, be true or not, it was certainly a fit symbol of the point of view of his circle. He preached Plato from the pulpit of the Duomo. He did much to revive the study of Plato, but it must be confessed that he was drawn more to his poetic excrescences than to the great fundamental ideas. He was profoundly moved by Savonarola, but it seems to have been only for a time. Savonarola saw too clearly the danger threatened by the whole movement to the uniqueness of revealed religion, and Ficino is recorded later to have lamented his temporary devotion to the 'hypocrite of Ferrara.' More even than Ficino, Giovanni Pico della Mirandola (1463-94) was the object of a hero-worship which extended far beyond the confines of Italy. His theses in favour of Platonism brought him under the ban of the Church, but he was the most profoundly religious of all the disciples of Plato. This, combined with the charm of manner, wealth, generosity and early death of this 'great lord of Italy,' gave him an extraordinary influence in Humanist circles throughout

Europe. And it was his *Heptaplus*, with its mistaken zeal for the Kabbala, that started Reuchlin on the study of Hebrew.

This Florentine Academy was only one of many institutions of the kind. Of the others, the most significant were those of Rome, founded by Julius Pomponius Laetus (1425-98) about 1460, antiquarian in its interests, openly pagan in its tone; Naples, founded by Jovianus Pontanus (1426-1503) from the remaining members of the Humanist protégés of Alfonso the Magnanimous, devoting itself mainly to the cultivation of style; and Venice, the latest of all, which centred in the Aldine Press and the founder, Aldus Manutius (1449-1516). Its discussions were conducted in Greek, and its main concerns were the choice of books to be published and the accuracy of their texts.

The great patrons of learning ought not to be passed over without remark. Mention has already been made of Cosimo de' Medici; but his grandson, Lorenzo the Magnificent (1449-92), was the Mæcenas of an even more brilliant circle. His son again, Giovanni, as Pope Leo X. (from 1513 to 1521), conferred high ecclesiastical office on very unchurchly Humanists. He was not the only Roman Pontiff, however, to show them favour. Nicholas V. (elected 1447) was the first of them. A Humanist himself of the earlier type, he gathered round him a notable band of scholars. Under him Rome became a 'workshop of erudition.' Pius II. (1458-64), who as Enea Sylvio had gained no mean reputation as a Humanist, grievously disappointed his expectant friends. Artists, not scholars, won his patronage.

During the whole of the 15th cent. the work of collection was zealously pursued by men like Niccolò Niccoli (1364-1437), who bequeathed 800 MSS to Florence, and Vespasiano da Bisticci (1421-98), multiplier of MSS, bookseller, and biographer of his patrons; libraries had been formed; and in the latter half of the century the Humanism of Italy reached its highest level in Angelo Ambrogini (Politian) (1454-94). Professor of Greek and Latin in Florence, he wrote poetry in three languages, showing an extraordinary fluency in Latin verse. His aim was independence, not imitation, and in his hands Latin had all the flexibility of a living language. His influence was extensive and profound. Somewhat before his time, and somewhat beneath his level of attainment, but with the same aims and ambitions was Francesco Filelfo (1398-1481). These two were the leading Humanist Professors in the high noon of Humanism.

A marked feature of the Humanist movement in Italy was the number and ferocity of its literary duels. The most truculent of these duellists was Poggio Bracciolini (1380-1469), the explorer of neglected libraries. His controversies with Filelfo over the standing of Florence, with Guarino da Verona (1370-1460) upon the comparative merits of Scipio and Julius Cæsar, and with Lorenzo Valla (1405-57), occasioned by some marginal annotations of one of Valla's pupils, and developing into an onslaught on each other's Latinity, were conducted with an unparalleled scurrility, venom, and foulness. Valla's contributions, though decidedly more temperate, were disfigured by the same kind of venomous invective. Some of Valla's other work was epoch-making, though the manner of it was far from his intention. His exposure of the 'Donation of Constantine,' and his *Collatio Novi Testamenti*, in which and in his *Adnotationes* the discrepancies between the Vulgate and the Greek first came to the light, helped materially the cause of the Reformation.

By the end of the 15th cent. the Humanism of Italy had entered on its final stage. In Pietro Bembo (1470-1547) we see the old enthusiasm for letters, but, dominating everything, a conscious aping of the elegancies of Ciceronian diction. With the sack of Rome in 1527 and the compact between Emperor and Pope in 1530, the Italian revival of learning comes to an end. The age of Spanish tyranny succeeds, and the glowing fire burns low. By the middle of the 16th cent. Greek was disappearing. Even to the erudite Cæsar Baronius (1538-1607) it was an unknown tongue. But the flame which had been thus kindled and nourished in Italy had already spread to other lands.

2. France.—Though there are early signs of the passage of the New Learning into France, it was long kept in the background through the prestige of the University of Paris and its Sorbonne. Jean de Montreuil (1354-1418), disciple of Petrarch and correspondent of Salutati, probably deserves the

credit of having led the way. His friend, **Nicholas de Clémanges** (1367[?]-1437), through diligent reading of the Classics, attained a considerable repute for Ciceronian eloquence. He was influenced purely by the classic style, and not by the classic spirit. To the end he remained a true son of the mediæval Church. There are records of Greek in Paris from 1430; in 1458 came the first recognized teacher; but there can hardly be said to be a Humanist movement until 1494, when the expedition of Charles VIII. to Naples began the closer connexion between France and Italy. The French kings became patrons of learning. **John Lascaris** from 1495 taught Greek in the University of Paris, and **Jerome Aleander** (1480-1542) from 1508 added the study of Hebrew. **Guillaume Budé** (Budæus) (1467-1540), whose dream of the establishment of a great Humanist College in Paris by Francis I. took shape in 1530 in the Royal College, was, 'beyond question, the best Greek scholar of his day in Europe' (*Cambridge Modern History*, i. [1902] 576). **Lefevre d'Étaples** (Faber Stapulensis) (1455-1536), until 1507 earning distinction as a teacher of the Classics in Paris, then turned his attention to the exegesis and translation of the Bible. Condemned by the Sorbonne, he was protected by **Briçonnet**, bishop of Meaux (1470-1534). But the 'group of Meaux' belongs rather to the history of the Reformation. **Guillaume Farel** (1489-1565), his favourite pupil, connects him with **Calvin**. **Estienne Dolet** (1509-46), for six years in Italy during the last stages of Italian Humanism, was the champion of Ciceronianism against **Erasmus**, and became 'the martyr of the Renaissance,' being burned to death in Paris on a charge of heresy. **Adrien Turnèbe** (Turnebus) (1512-65), professor of Greek and king's printer, did much to advance Greek scholarship; and **Julius Cæsar Scaliger** (1484[?]-1558), erudite and irascible, rivalled **Poggio** in virulence of invective, in his attack on **Erasmus**. The **Estiennes**, **Robert** (1503-59) and his son **Henri** (1528-98), rendered most effective service to the Humanist cause by their numerous classical publications.

The Humanists of France, perhaps more through having felt the general stir of the Renaissance before their attention was turned to the Classics than through any natural predisposition, had little of the blind reverence for all things classical that we find in Italy. Their scholarship was thorough, but more detached and critical. In **Joseph Justus Scaliger** (1540-1609) and **Isaac Casaubon** (1559-1614) it reached its highest level.

3. **Germany**.—In 1514 there was issued from the press at Tübingen a volume entitled 'Clarorum Virorum Epistolæ, Latinæ, Græcæ et Hebraicæ variis temporibus missæ ad Joannem Reuchlin,' in support of **Reuchlin** in his fight for Hebrew learning. In the same year there appeared an apparent counterblast with the title 'Epistolæ obscurorum virorum ad venerabilem virum M. Ortuinum Gratium variis et locis et temporibus missæ ac demum in volumen coactæ.' **Gratius** was Professor in Cologne, the headquarters of Mediævalism, and in this book he and his class were put to ridicule in a wild parody of their own dog-Latin. Several of the Humanists are known to have had their share in it; and, though frowned on by **Reuchlin** for its coarseness, it did more than anything else to make Humanism a natural movement in Germany, as it had been in Italy, and as it never really became in any other country. Humanism found in Germany a second home.

It had made its appearance long before this. Its way had been prepared by the schools of the 'Brethren of the Common Life' (*q.v.*). Schools like **Schlettstadt**, where **Reuchlin** began his education, and **Deventer**, whose most famous master,

Alexander Hegius (1433-99), had **Erasmus** as a pupil, were far beyond anything in pre-Humanist Italy. It had its forerunners in men like **Gregor von Heimburg** (1410-72), who were half fascinated and half repelled by the Italian Humanists. Through German students like **Peter Luder** (1415-74), whom the national *Wanderlust* drove across the Alps, through the great Councils, where the Humanist secretaries of Italian prelates impressed their German brethren, and through the frequent commercial intercourse, the revival spread. Corresponding to the Academies of Italy were informal associations in the towns and cities. In **Erasmus's** account of his German journeys there is frequent reference to reception and escort by the *sodalitium* or *confraternitas*—the local group of scholars united in the comradeship of learning. The Humanist Universities were naturally centres of such fraternities. The circle in Erfurt was called 'the Mutianic host,' from **Mutianus Rufus** (1471-1526), one of the many who had come under the spell of **Pico**. The centre of the Heidelberg group was **Rudolf Agricola** (1443-85), 'the first,' **Erasmus** declared, 'to bring us out of Italy a breath of higher culture.' At Ingolstadt, **Johann Eck** (1486-1543), who became the opponent of **Luther**, and **Urbanus Rhegius** (1489-1541), who became a zealous supporter, were the dominant forces. At Basel, **Glareanus** (1488-1563) ruled, save during the residence of **Erasmus**.

But independently of the Universities, the Humanists had their groups in the great cities. At Nuremberg they gathered round **Wilibald Pirckheimer** (1470-1528), who combined in his own person the versatility of the Italian Renaissance and the more earnest spirit of his own land; at Augsburg round **Conrad Peutinger** (1465-1547), keeper of the city archives, diplomatist, and antiquarian; at Strassburg, round **Jacob Wimpfeling** (1450-1528), 'the schoolmaster of Germany,' and **Sebastian Brant** (1457-1521), satirist and author of the *Narrenschiff*.

Three names stand out from all the others in importance and significance. **Johann Reuchlin** (1455-1522), with attainments in Greek which gave cause for astonishment to **Argyropoulos**, was the effective promoter of Hebrew studies. Though **Conrad Pellicanus** (1478-1556) had in 1504 published a creditable Hebrew Grammar, it was **Reuchlin's Rudimenta Hebraicæ** that became the foundation of Hebrew scholarship. Attacked as a traitor to the Church for opposing **Pfefferkorn's** proposed holocaust of Hebrew books, he was at first acquitted (1514 and 1516) and then condemned on appeal (1520). It was the stand which he made that united the forces of German Humanism. **Ulrich von Hutten** (1488-1523), the son of an impoverished Franconian noble, was designed for the Church, and sent at the age of 11 to the Monastery of Fulda. Fleeing thence, he studied at one Humanist University after another, crossed into Italy, and lived the life of the wandering scholar. In him we see the New Learning devoted to political and social ends. His great aim was 'a united Germany under a reformed Emperor.' He was drawn into passionate attachment to the Lutheran movement by its patriotic possibilities. **Philip Melancthon** (1497-1560), in virtue of his work on **Virgil** and **Terence**, was called at the age of 21 to the chair of Greek at Wittenberg. Amid all his multifarious labours on behalf of the Reformation, he found time and opportunity to foster education and to furnish it himself with indispensable aids to classical study.

Though there were a few, like **Peter Luder** and **Conrad Celtes** (1459-1509), who may be said to represent the Neo-paganism which was so prominent in Italy, and though most of the older Humanists

refused to join the Reformers when the actual breach came, it was their work that had prepared the way for it, and their pupils gathered round Luther and Zwingli. The main stream of German Humanism had from the beginning been flowing steadily towards Reformation in some shape or form.

4. England.—Through his kinship of spirit with Petrarch, Chaucer (1340[?]-1400) has been hailed as the morning star of the Renaissance. But his kinship is not with the distinctively Humanist side of Petrarch's activity. Humphry, Duke of Gloucester (1391-1447), patron of scholars, collector, and correspondent of Italian Humanists, did much to hasten the new era. But it is with two friends, Thomas Linacre (1460[?]-1524) and William Grocyn (1446[?]-1519), who had studied in Italy under Politian, and on their return taught Greek in Oxford, that Humanism began really to establish itself in England. John Colet (1467[?]-1519) gave the movement its strongest impulse and its direction. He returned from Italy, well equipped in scholarship, and with a thorough contempt both for the whole scholastic dialectic and for the Neopagan Humanism. In his lectures in Oxford on St. Paul's Epistles he broke fresh ground. 'He was the first to apply the critical methods of the New Learning to discover the exact meaning of the books of the Holy Scriptures' (T. M. Lindsay, *A History of the Reformation*, Edinburgh, 1906-07, i. 165). In 1510, Colet, now Dean of St. Paul's, devoted his patrimony to the founding of St. Paul's school, where 'children should be taught good literature, both Latin and Greek.' Its first master, William Lily (1466[?]-1522), gave his name to the Latin grammar prepared for the school, and subsequently widely used. In reality it was a composite production. The foundation was Colet's, but it was revised by Erasmus, Lily, and others. Colet's friend, Sir Thomas More (1478-1535), was a hero-worshipper of Pico della Mirandola, whose life, which he translated, showed him the possibility of combining the new culture with a fervent yet uncloistered Christianity. In his *Utopia* (1516) he gave evidence of his open-mindedness to all the better influences, not only of Humanism but of the whole Renaissance movement. Among other names worthy of mention are Sir Thomas Smith (1512-77) and Sir John Cheke (1514-57), through whom Greek studies were established in Cambridge; Roger Ascham (1515-68), Greek enthusiast and educational reformer; and William Tyndale (1484[?]-1536), who, from the preparatory school of Erasmus, passed into that of Luther. The Humanism of England produced no prodigies of erudition, but it did produce great popularizers—translators of the Classics whose translations themselves became classics. North's *Plutarch* and Chapman's *Homer* are conspicuous examples. Through such translations, Humanism profoundly influenced and helped Elizabethan literature. And it must ever be remembered that in its springtime the Humanism of England had its own definite ideals to which Erasmus owed more than a little. These ideals find fit expression in the statutes of Colet's school: 'My intent is by this school specially to increase knowledge, and worshipping of God and Our Lord Jesus Christ, and good Christian life and manners' (F. Seebohm, *The Oxford Reformers*², London, 1869, p. 208 f.).

5. The other countries.—The New Learning passed to Spain through scholars who had been to Italy. Of these the foremost, though not the first, was Antonio Lebrixa (1442[?]-1522), who, after ten years in Italy, taught in the Universities of Seville, Salamanca, and Alcalá. The University of Alcalá was the headquarters of Spanish Humanism; Cardinal Ximenes (1436-1517) was its

Mæcenas, the *Complutensian Polyglot* (1522) its outstanding product. The revival, short but brilliant, came to an end, like that of Italy, through the compact between Charles v. and Clement VII. in 1530.

To Scotland the New Learning came late. Passing over earlier students who came under its spell abroad, men like Patrick Hamilton (1504[?]-1528), who belong rather to the Reformation, the one outstanding name is that of George Buchanan (1506-82). Trained in France and a teacher there, he was one of the leaders in the ill-fated attempt to plant the New Learning in Portugal. His Latin Paraphrases of the Psalms and his other Latin poetry had a tremendous vogue. Joseph Justus Scaliger declared that Latin literature had reached its climax in Buchanan's verse. To Andrew Melville (1545-1622) belongs the credit of re-organizing Scottish University education on Humanist lines.

We have left to the last the greatest of the Humanists, Desiderius Erasmus. Born in Rotterdam in 1466 or 1467, he belongs by birth to 'the other countries.' In spirit he was a true cosmopolitan. He is to be found, first in France, then in England, France again, Italy, England again, and finally at Basel. And this list does not include the shorter visits of this born wanderer. He was the friend and correspondent of the contemporary leaders of Humanism in all the countries. He became almost a dictator of learning for Europe north of the Alps, without ever assuming the manner of the despot. In the field of classical studies his *Adagia*, *de Copia Verborum*, and *Apophthegmata* were much-prized aids to study. The second went through sixty editions in his lifetime. In Greek he was perhaps second to Budæus, but in Latin he had no real rival. Jealous Italians might call him 'Porrophagus' (in allusion to his fondness for the word *porro*), but, as his *Ciceronianus* showed, his ideals were not theirs, and his Latin, if not so imitative of Cicero, was a much more flexible and powerful instrument. Works like the *Encomium Moriae* and the *Colloquia* showed the world the necessity of reform. His aim throughout was a Christian Renaissance, the source of which was not to be found in Plato, but in a return to the New Testament and the older Fathers of the Church. His Greek Testament of 1516, his numerous editions of the Fathers, and indeed the great bulk of his very numerous works were designed to help in such a Christian Renaissance. In the midst of his labours the Reformation came. He died at Basel in 1536, committed to neither party, but amid an admiring circle of friends who were all on the Reformed side.

Though his attempted neutrality in the decisive struggle and certain obvious faults in his character have caused him to be looked upon as a petty-minded man, he did more than any other to extend the influence of Humanism, and that of the very highest type, thereby earning fairly the name of the greatest of the Humanists. Half-hearted Reformer he may have been, but he was neither half-hearted Humanist nor half-hearted Christian.

III. RESULTS.—In dealing with the general results of the Humanist movement thus sketched, the difficulty is to disentangle it from the Renaissance as a whole. We are apt to ascribe to it influences which, strictly speaking, do not belong to it at all. The defects of the movement are evident—(1) in its tendency to exalt erudition above true intellectual development, and to degenerate into mere pedantry; (2) in its open resuscitation of pagan vices; and (3) in the insincerity induced by a too exclusive devotion to style. Panegyric and abuse in some quarters became fine arts. The sale of eulogies by the Humanists has been fitly compared to the sale of Indulgences by the Church.

On the other hand, there were many distinct gains. (1) The buried Classics were disinterred and preserved; they were diffused by the printing-press; they were made available by Grammar and Lexicon. (2) Education was set free from narrow Scholastic limits and clerical monopoly. Culture was for the citizen as well as for the 'clerk.' (For men and methods, see EDUCATION, vol. v. p. 175^a.) (3) The contact thus established with the great minds of antiquity led to the general revival of thought. The reaction from the fragmentary Aristotle and his mediæval commentators led at first to uncritical enthusiasm for even the wildest vagaries that could be called Platonic or even Neo-Platonic, but later, through controversy and study, to a reasoned understanding of both, thus preparing the way for modern philosophy. (4) Art and literature received a fresh impulse through the abundance of new material of which it did not fail to make extensive use. (5) Acquaintance with the literatures of Greece and Rome led to a rapid evolution of literary forms in the national languages. Most of the Humanists looked with contempt on the uncouthness of their vernaculars. Petrarch's preference for his Latin writings, his regret that Dante had not written in Latin, and Hutten's confession that he did not think the German language a fit instrument of literature till he had seen Luther's use of it, are outstanding examples. The futile experiments which almost every European literature witnessed of torturing the vernacular into classical moulds had yet their result in a new variety of form, and a new power over language. (6) The critical methods of the Humanists swept away such obscurations as the four-fold sense, and, applied by Northern scholars to the Fathers and the Scriptures, gave a great impetus to the Reformation. The broad result is summed up by Jebb:

'The historical importance of the Classical Revival in Italy depends ultimately on the fact that it broadened out into this diffusion of a general capacity for liberal culture, taking various forms under various local and national conditions. That capacity, once restored to the civilised world, became a part of the higher life of the race, an energy which, though it might be temporarily retarded here and there by reactionary forces, could not again be lost. Not in literature or in art alone, but in every form of intellectual activity, the Renaissance opened a new era for mankind' (*Cambridge Modern History*, i. 584).

LITERATURE.—In addition to the works cited and named in the text, see W. Roscoe, *Life of Lorenzo de' Medici*, Liverpool, 1795, also *Life and Pontificate of Leo X.*, do. 1805; C. de Rosmini, *Vita di Francesco Filelfo da Tolentino*, Milan, 1808; G. Voigt, *Die Wiederbelebung des classischen Altertums*, Berlin, 1859; J. A. Maehly, *Angelus Politianus: ein Culturbild aus der Renaissance*, Leipzig, 1864; D. F. Strauss, *Ulrich von Hutten*, do. 1871; L. Geiger, *Johann Reuchlin*, do. 1871; R. B. Drummond, *Erasmus, his Life and Character*, London, 1873; L. Geiger, *Renaissance und Humanismus in Italien und Deutschland*, Berlin, 1882; M. Monnier, *La Renaissance de Dante à Luther*, Paris, 1884; E. Müntz, *La Renaissance en Italie et en France à l'époque de Charles VIII.*, do. 1885; L. Pastor, *Geschichte der Päpste im Zeitalter der Renaissance bis zur Wahl Pius II.*, Freiburg i. B. 1886; P. de Nolhac, *Pétrarque et l'humanisme*, Paris, 1892; J. Burckhardt, *The Civilisation of the Period of the Renaissance*, Eng. tr., London, 1892; W. H. Woodward, *Vittorino da Feltre and other Humanist Educators*, Cambridge, 1897; P. Van Dyke, *Age of the Renaissance*, Edinburgh, 1897; E. Emerton, *Desiderius Erasmus of Rotterdam*, New York, 1899; F. M. Nichols, *The Epistles of Erasmus from his earliest Letters to his fifty-first Year*, London, 1901; L. Einstein, *The Italian Renaissance in England*, New York, 1902; P. Wernle, *Die Renaissance des Christentums im 16ten Jahrhundert*, Tübingen, 1904; W. H. Hudson, *The Story of the Renaissance*, London, 1912; J. D. Symon and S. L. Bensusan, *The Renaissance and its Makers*, London, 1913.

HUGH WATT.

HUMANITARIANISM.—Humanitarianism in the ethical sense—wholly distinct from the theological—is the deliberate and systematic study of humane principles, the attempt to show that humaneness is an integral part, if not the actual basis, of morals. In estimating the value of compassion as a moral force, it is not necessary to discuss the different theories as to its origin, propounded by the two schools of intuitive and of utili-

tarian ethics, as represented, on the one hand, by Butler, who holds (in his Sermon on 'Compassion' [*Sermons*, ed. Bernard, London, 1900, p. 74]) that it is an 'original, distinct, particular affection in human nature,' and, on the other hand, by Hobbes, who maintains (*Human Nature*, ix. 10) that it is 'imagination, or fiction of future calamity to ourselves, proceeding from the sense of another man's calamity'; for, however this may be, it is evident that compassion is closely allied to that imaginative sympathy by which we identify ourselves with others. In the words of W. Wollaston (*Religion of Nature*, 1759), 'there is something in human nature, resulting from our very make and constitution, which renders us obnoxious to the pains of others, causes us to sympathise with them, and almost comprehends us in their case. It is grievous to see or hear, and almost to hear of, any man, or even any animal whatever, in torture.'

For example, when a man turns aside to avoid crushing an insect, why does he do so? Certainly not because of any reasoned conviction as to the sufferings of 'the poor beetle that we tread upon,' but for the simple fact that, consciously or unconsciously, he is humane; the sight of suffering, however slight, is distasteful to him as being human. Of all mistaken notions concerning humanitarianism, the most mistaken is that which regards it as some extraneous artificial cult, forced on human nature from without; whereas in truth it is founded on an instinctive conviction from within, a very part of human development. When we talk of a man 'becoming a humanitarian,' what we really mean is that he has recognized a fact that was already within his consciousness,—the kinship of all sentient life—of which humanitarianism is the avowed and definite proclamation.

But, if it be true that compassion is 'an undeniable fact of human consciousness,' residing 'in human nature itself' (Schopenhauer, *Basis of Mor.*, ch. vi.), it is also true that this compassionate instinct, before it can be put to practical service in a complex social state, must be tested by experience and reason. Unmistakable as are our humane promptings, they cannot in all cases be realized; for self-preservation, that other great natural impulse, has first to be consulted, and we are trammelled by a host of traditional customs and obligations which often render it difficult or impossible to give our humanity due effect. Here, again, it is the function of humanitarianism to reconcile the ideal with the actual, to unite compassion with judgment, and to discover not only how we feel, or ought to feel, towards our fellow-beings, but also to what extent and with what limitations we can, at the present time, and under present conditions, put those feelings into practice.

An attempt is sometimes made to disparage humanitarianism by setting it in contrast to humaneness: 'I would be humane,' some one will say, 'but not humanitarian.' But as a matter of fact there is no sort of contradiction between the two terms; for humanitarianism is nothing more than conscious and organized humaneness. There is a vast amount of compassionate sentiment that is at present scattered and isolated, and therefore to a great extent ineffective; it is the business of humanitarianism to collect and focus this feeling into an energetic whole.

It must be noted, at the outset, that humanitarianism in this sense, as a branch of ethical science, is a modern product, for it was not until the 18th cent.—the age of 'sensibility'—that there began to be any wide-spread recognition of humaneness as a force in civilized society. No doubt the duty of love and gentleness to sentient life had been inculcated, all down the ages, as part of the higher teaching—in the doctrines of Buddha, in

the system of Pythagoras, in the practice of the Essenes, in the pagan philosophy of Plutarch and Porphyry, and with less consistency, perhaps, so far as our duties towards the lower animals are concerned, in the Christian Scriptures. For, though the gospel of 'peace and goodwill' led its early followers to a belief in the sacredness of all human life and the natural equality of men, and this belief led in its turn to the abolition or curtailment of many cruel practices, such as the gladiatorial shows, there is also truth in the statement (A. Jameson, *Commonplace Book of Thoughts, Memories, and Fancies*, London, 1854, p. 209) that 'the primitive Christians, by laying so much stress upon a future life in contradistinction to this life, and placing the lower creatures out of the pale of hope, placed them at the same time out of the pale of sympathy, and thus laid the foundation for this utter disregard of animals in the light of our fellow creatures.'

It is certain that during the Middle Ages, when the Roman Catholic Church was dominant, there was, in this respect, little or no progress in humanitarian feeling, the indifference of Roman Catholicism to the claims of animals being broken only by the splendid example of St. Francis of Assisi, whose profound sense of brotherhood with beast and bird is the more remarkable owing to its contrast with the general callousness of his contemporaries. It was this lack of sympathy which, surviving in large measure even to modern times, caused Buddhists to speak of Christendom as 'the hell of animals.'

When we come to the Renaissance, however, we find, with the revival of learning, a revival also of the humanitarian spirit, many humane sentiments, for example, being observable in the writings of More and Erasmus, Montaigne, Shakespeare, and Bacon; and this renewed appeal to the instinct of compassion paved the way for that advanced 18th cent. sentiment which found its fullest expression in the saying of Voltaire, that 'without humanity, the virtue which comprehends all virtues, the name of philosopher would be little deserved.' Philosophers and poets vied with one another, through this era of awakening, in a recognition of the claims of common life on the heart of human-kind, and the post-revolutionary writers have continued to develop more and more the ethic of humaneness; it is sufficient to mention such names as those of Thomson, Pope, Goldsmith, Cowper, Burns, Shelley, and Wordsworth, to show how largely our modern poets have been concerned in this humanizing process. It is to the last hundred and fifty years, in fact, that Western humanitarianism, in the sense in which we use the word, owes its origin; and it is of Western humanitarianism only that we here propose to speak.

The first point which needs to be emphasized is this—that the principle of humaneness is based on the broad ground of universal sympathy, not with mankind only, but with all sentient beings, such sympathy being, of course, duly proportioned to the sensibility of its object. Humanitarianism is not to be confused with philanthropy—love of mankind—on the one side, or with zoophily—kindness to animals—on the other; it includes and comprehends them both.

'It is abundantly evident,' says Lecky (*European Morals*, London, 1838, i. 278, 101), 'both from history and from present experience, that the instinctive shock, or natural feeling of disgust, caused by the sight of the sufferings of men is not generically different from that which is caused by the sight of the sufferings of animals. . . . At one time the benevolent affections embrace merely the family, soon the circle expanding includes first a class, then a nation, then a coalition of nations, then all humanity, and finally, its influence is felt in the dealings of man with the animal world.'

Humanitarianism, then, is the application of an evolutionary doctrine founded on the kinship of life, which unites the sentiment of East and West in the growing perception of fellowship and

brotherhood between all living creatures; and a humanitarian is he who has substituted this wider sympathy for the partial benevolence which is restricted to the narrower circle of one's own countrymen or kin. 'The time will come,' wrote Bentham (*Principles of Penal Law*, ch. 16), 'when humanity will extend its mantle over everything which breathes. We have begun by attending to the condition of slaves; we shall finish by softening that of all the animals which assist our labours or supply our wants.'

But, before we proceed further, it may be well to clear away certain common misapprehensions by a short statement not only of what humanitarianism is, but also of what it is not. For example, it is not Brāhmanism. What it condemns is not the taking of life, as such; but the unnecessary or wanton taking of life through callousness, ignorance, or force of habit; and there is no point whatever in applying to humanitarianism the trite story of the Hindu whose principles forbade him to drink water when the microscope had revealed to him the infinitesimal creatures that inhabit it.

Nor are humanitarian doctrines, as Nietzsche and his school would have us suppose, an offshoot of Christianity; for, as has already been shown, they go far beyond the Christian ethics in all that relates to the lower animals, and they number among their professors many well-known names that lie altogether outside the Christian sphere of thought. Nor, again, is humanitarianism altogether identical with 'altruism,' the due regard for the interests of others, for it is to satisfy his own needs and instincts—involvement in those of the sufferer—that the humanitarian takes action; it is self-fulfilment rather than self-sacrifice that he desires.

Finally, humanitarianism is not, as is often assumed by its critics, a merely negative, prohibitive, and ascetic view of life by which we are constrained to desist from certain practices in which we might otherwise take pleasure; on the contrary, by discovering for us a freshness of relation towards vast numbers of our fellow-creatures, it opens out new fields of pleasurable friendship which have hitherto been neglected, and points the way to a fuller and better realization of what is beautiful and true. Contrast, for instance, the wholesale destruction of sea-fowl for their feathers, or for mere amusement, that disgraces many parts of our coast, with the scene that may be daily witnessed in winter time on the Thames Embankment—the feeding of scores of gulls by their human friends and protectors under terms of perfect amity and trustfulness. Can it be doubted which of these two attitudes towards animals brings the greater pleasure to mankind?

Dismissing, therefore, these false ideas of humanitarianism, we shall try to grasp its true purport and significance as part of the modern democratic movement; for there is no more essential mark of democracy than the fostering of kinship and understanding in place of division and distrust. In holding that the difference between human and sub-human is one of degree only, and not of kind, the humanitarian has the support not of sentiment alone, but of science. 'The trend of investigation,' says Wesley Mills in his work on *The Nature and Development of Animal Intelligence* (London, 1898, p. 21), 'thus far goes to show that at least the germ of every human faculty does exist in some species of animal. . . . Formerly the line was drawn at reason. It was said that the "brutes" cannot reason. Only persons who do not themselves reason about the subject with facts before them, can any longer occupy such a position.' In

like manner E. P. Evans points out, in his *Evolutional Ethics and Animal Psychology* (London, 1898, p. 99 f.) that 'man is as truly a part and product of nature as any other animal, and the attempt to set him up as an isolated point outside of it is philosophically false and morally pernicious.' Thus the old 'anthropocentric' position is being more and more abandoned, and it is no longer possible to draw an absolute line of demarcation between men, as 'persons' and 'ends,' and animals, as mere 'things,' such distinctions being a thoroughly unsound basis for any ethical structure, inasmuch as the more highly organized animals possess, though, of course, in a lower degree, the qualities of true personality. Even the expression 'man and the animals,' though unavoidable in common speech, is philosophically incorrect, for man is himself a part of the great animal kingdom, and cannot disown the relationship. We have from science itself the clearest assurance that man is an animal, and that the great gulf which was supposed to exist between human and non-human has existed only in imagination.

For this reason humanitarianism claims for animals, as for men, a measure of individuality and freedom, a space in which to lead their own lives—in a word, 'rights.' It is unnecessary here to enter into the wide field of discussion as to the fitness of this term; for, if objection be taken to it, it is possible to consider the question from the other, the correlative, side, and to arrive at the same conclusion by the use of the term 'duties.' The essential part of the humanitarian contention is that there is no absolute difference between mankind and 'the animals'; that, if man has reason, animals have the germ of reason; that, if man has 'rights,' animals have the same in due degree.

With regard to human rights, it is sometimes said that 'men can take care of themselves.' This, however, is not always the case; for (to refer to two classes only, the pauper and the criminal) it is evident that the unfortunate inmates of workhouse and prison are *not* able to take care of themselves, but are as helpless in the hands of others as any animals could be. The rights of men are admitted in theory, but often violated in practice. We speak of all men as brothers; but, when it comes to giving practical proof of our brotherhood with paupers and criminals, we too frequently show by our treatment of them that we really regard them as a wholly alien class. The same is true of the usage accorded to subject races, aborigines, and all who, in the aggrandizement of one nation at the expense of another, are liable to find themselves at the mercy of their brother man.

Again, when we turn to the protection of animals, we sometimes hear it said that we ought to help men first and animals afterwards. But, if the principle which prompts the humane treatment of men is the same essentially as that which prompts the humane treatment of animals, how can we successfully safeguard it in one direction while we violate it in another? By condoning cruelty to animals, we perpetuate the very spirit which condones cruelty to men. Humanitarians do not say that the lower forms of life must be treated in the same way as the higher forms, but that in both cases alike we must be careful to inflict no unnecessary, no avoidable, suffering. This is briefly expressed in the manifesto of the Humanitarian League, which enforces the principle that 'it is iniquitous to inflict avoidable suffering on any sentient being.'

Of the societies which work for humane purposes the only one which directly concerns itself with this fuller principle—the just treatment alike of the human and non-human races—is the Humanitarian League, which, while recognizing that there is need of concentration in efforts of this kind, and that it is desirable that special cruelties should be dealt with by special

organizations, is nevertheless designed to supplement these labours by showing that all such efforts, however divergent in practice, spring in reality from a common source and converge to a common end—the establishment of concord and fellowship where there is now misunderstanding and strife. How wide a scope there is for humanitarian propaganda, even in this 20th century, may be judged from the number of societies now in existence for the redress of some particular evil—*e.g.* (to mention but a few out of many) those that aim at a mitigation of the horrors of war, and the extension of the appeal to international arbitration; those that inculcate a more considerate treatment of subject races and aborigines; and those that plead for the humanizing of the Poor Law, and a less harsh administration of the criminal code and prison system. The societies for the prevention of human wrongs, and the promotion of human happiness, are legion; but it is, of course, impossible to determine precisely which of the many questions thus agitated are to be called 'humanitarian.' The term 'humanitarianism' is a wide one, and may be used to cover the whole field of benevolence; but, owing to the action of the Humanitarian League, it is more commonly associated in this country with the reformation of prison treatment and the protest against capital and corporal punishments. Of late years no humanitarian issue has been so largely discussed as the continuance or abandonment of flogging; which may be taken, perhaps, as a test question between humanitarians and their opponents.

Thus, to take a salient example, an attempt was made in the year 1900 to extend the use of the lash for a number of offences in the case of adult criminals, but the Bill was opposed by the Humanitarian League and defeated in the House of Commons by a large majority; and in like manner the League was instrumental in securing the withdrawal of the 'whipping clauses' from the Youthful Offenders' Bill, introduced in the same year. On the other hand, the power of judges to order flogging in the case of certain offences has recently been increased under the Criminal Law Amendment (White Slave Traffic) Act of 1912. The infliction in the Royal Navy of very severe scourgings on boys and young men up to the age of eighteen is another matter on which humanitarian opinion has of late been powerfully moved, with the result that the use of the birch has been discontinued.

Nor is the list of controversial subjects any shorter where the interests of the lower animals are at stake. In this connexion it is necessary to bear in mind the legal distinction between 'domestic' animals and those that are classified, however arbitrarily, as 'wild.' Since the passing of 'Martin's Act' in 1822, a modicum of legal protection has been secured for such animals as are recognized under the title 'domestic,' and to 'cruelly beat, ill-treat, over-drive, abuse, or torture' any such animal is an offence against the law; but there are, of course, innumerable cases which no law can reach, and the general treatment of domestic animals in Great Britain, though far better than that which obtains in some other countries, is still greatly below the standard to which a civilized nation should aspire. It must be admitted, too, that the protection afforded is but partial and incomplete, when we remember that the vivisector, by special licence, and the cattle-drover and slaughterman, by tolerated custom, are permitted to inflict very severe suffering on highly-organized domestic animals under English law.

In the case of the *feræ naturæ*—a term which includes even the semi-domesticated park-deer hunted by so-called sportsmen, and the bagged rabbit used in the horrible pastime of rabbit-coursing—not even these limited rights exist, the only protection being that given under the Wild Animals in Captivity Act (1900), which forbids the ill-usage of any 'wild' animal while in actual confinement, but does not take cognizance of any injury done in course of sport, or vivisection, or the destruction of animals for food—a limitation which almost entirely cripples the usefulness of the Act. A wild animal, while in a state of nominal freedom, has no rights. 'Everywhere,' it has been said, 'it is a capital crime to be an unowned creature.'

Taking the animal question as a whole, we find that the subjects of paramount humanitarian interest are (1) the protection of domestic animals, and (2) the protests raised against vivisection, blood-sports, the slaughter of animals for food, and the wholesale destruction of birds for purposes of millinery—in other words, the enforcement of the present Acts, and the demand for further legislation. The work of the Royal Society for the Prevention of Cruelty to Animals is mainly confined to prosecuting for breaches of the existing law; and it is left to the Anti-Vivisection Societies, the Vegetarian Societies, the Royal Society for the Protection of Birds, the Humanitarian League, and others, to agitate against the cruelties of the laboratory, the slaughter-house, the feather-fashion, and 'sport.' There is no organization which concerns itself especially with blood-sports, except the Sports Department of the Humanitarian League, which was successful in obtaining the abolition of the Royal Buckhounds, and has since promoted a Bill in Parliament for the prohibition of certain spurious sports, such as tame stag-hunting, rabbit-coursing, and the shooting of pigeons from traps. It is deserving of notice that there is no matter in which an enlightened public opinion has more signally outrun the letter of the law than that of blood-sports, where there has been no humane legislation since the abolition of bull and bear baiting more than half a century ago, the Bill which condemned pigeon-shooting, passed in the House of Commons in 1884, having been thrown out by the Lords.

All these cruelties, according to the humanitarian view, spring from a common origin—the lack of any real conception that the lower animals are intelligent and rational beings.

Given a race of so-called 'brute-beasts' (and it is open to remark that the harshness of the common nomenclature reacts in its turn on the common treatment of animals), which are assumed to exist for the sole object of ministering to human convenience, it is inevitable that they should be used or ill-used in various ways according to the whims and inclinations of their masters. Thus, regarded from the several standpoints of the human temperament—the impulse of hunger, of recreation, of curiosity—an animal is something to eat, something to hunt, something to experiment on; and we are brought face to face with the questions of flesh-eating, sport, and vivisection.

It does not, however, fall within the scope of this article to do more than indicate the general aspects of humanitarianism, and we pass on to speak of some of the common objections that are urged against humanitarian principles. The first and most prevalent of these arguments is that drawn from the poet's picture of 'Nature red in tooth and claw,' which represents humanitarianism as in conflict with the stern facts of existence. It is said that the animals themselves prey on one another, and that the law of nature is founded on internecine conflict and sacrifice. But this, though true in part, is not the whole truth; for, while appealing to the law of competition, it leaves out of sight the not less important law of 'mutual aid,' and evades the fact that, while some animals are mainly predacious, others are mainly social in their habits, and that there is no reason why mankind, whose instincts are of the social order, should violate its own nature in order to imitate the beasts of prey. Nor is it true that an analogy can be established between the suffering inflicted in nature and the artificial and unjustifiable, because unnecessary, cruelties of man; for the best naturalists are of opinion that

"Nature red in tooth and claw
With ravine"

is a picture the evil of which is read into it by our imaginations, the reality being made up of full and happy lives, usually terminated by the quickest and least painful of deaths' (A. R. Wallace, *Darwinism*, London, 1889, p. 40). All these conditions are wanting in the unnatural cruelties against which humanitarianism protests.

Then, again, we are confronted with the argument drawn from that much misapprehended term, 'consistency.' 'Where will you draw the line?' is a question frequently put to the humanitarian, who is reminded that, if he be 'consistent,' he will be precluded from defending his crops against the ravages of wild animals, and even from cultivating the ground, because of the injury done by the plough to earth-worms and to the lowliest forms of life. But here there is, of course, a complete perversion of the humanitarian doctrine, which, as has already been stated, asserts that rights are the same in kind but not in degree, and that we owe to all sentient creatures a universal, but not an absolute, justice. We are not bound to starve our own race by abstaining from agriculture on account of the injury done to earth-worms, but we may all remember what Cowper (*The Task*, bk. vi.) says of the man 'who needlessly sets foot upon a worm.' The true consistency is that which has regard to the *direction* of one's course; and, because the whole journey cannot be accomplished at once, it does not follow that no step should be taken.

Equally pointless is the cry that is raised against the 'sentimentality' of humanitarians, 'sentiment' being one of those vague, indefinite terms which are used as a substitute for argument. That there is much that is ultra-sentimental in the present age—as, for instance, in its spasmodic and partial benevolence and ill-adjusted 'charities'—will not be denied; nor are humanitarians more exempt than other persons from the danger of falling into excess in the advocacy of their views. But, though the charge of sentimentality may be fairly urged, e.g. against the anti-vivisectioner who,

while denouncing the cruel experiments of physiologists, is himself an advocate of vivisectioning convicts with the cat-o'-nine-tails, it cannot lie against the all-round humanitarian who pleads for the adoption of some rational and comprehensive principle. It is, in fact, not on mere sentimentality, but on a wider and more philosophic view of the subject, that humanitarianism relies. 'As long,' it has been said, 'as certain favoured aspects of humaneness are exclusively insisted on, as long as pity is felt and expressed for this or that particular form of human suffering, while others of equal or greater importance are neglected or ridiculed; as long as the compassion which is claimed for men is denied to animals, or extended only to certain classes of animals—so long will it be difficult to appeal successfully from the narrow selfishness of personal interests to the higher and nobler sentiment of universal brotherhood.'

Perhaps no more effective proof can be produced of the inevitable further growth of humanitarian principles than a consideration of the alternative that must be faced by society if humanitarianism is to be disowned. Whether wisely or unwisely, we have now reached a certain transitional stage of humane development, both in our manners and in our laws, and those who would dissuade us from continued advance on the same lines are bound to frame some other policy for our guidance. If we are not to go forward, are we to turn back? Or are we to remain at the precise point to which we have now attained? It will hardly be argued that the present very confused state of English law and feeling on humanitarian subjects represents the golden mean which is incapable of further improvement; it follows, then, that, if progress is to be barred, we must henceforth return to that 'old brutality' which certain writers affect to regret that we have 'allowed to die out too much.' To state this alternative is sufficient to show that the future lies with humanitarianism. It is obvious that we shall continue to advance in the same direction as in the past, and that a gradually expanding sense of sympathy and kinship will bring with it a gradual but certain increase in the humanity of the treatment which we shall accord to every living creature.

Herein, then, lies the strength of the humanitarian position, that its principle is a consolidation of the countless humane impulses that spring up everywhere in the human heart, and that on an instinct so simple as to be intelligible to a child it builds a progressive ethical system that can satisfy the intellect of a philosopher. It is an amusing comment on the prevalent ignorance of humanitarianism that those who hold a faith which so profound a thinker as Schopenhauer cherished as 'the basis of morals' are often lightly dismissed with the remark that 'their hearts are better than their heads.' It is impossible, with strict regard to truth, to return this compliment by saying that the heads of such foolish jesters are better than their hearts, for head and heart alike must be in an evil case when the great duty of compassion does not make itself respected. We have advisedly spoken of this principle as a 'faith,' for it is indeed the ethical belief of the future—the faith of universal kinship—and no infidelity can be so grievous as that which hinders men from recognizing their own kindred, and makes them deny that *oneness* in life which wisdom sees everywhere, and to which folly is everywhere blind. 'Far as custom has carried man from man,' says Edward Carpenter (*Civilization*, London, 1889, p. 156), 'yet, when at last in the ever-branching series the complete human being is produced, it knows at once its kinship with all the other forms. More, it knows its kinship with the animals. It sees

that it is only habit, an illusion of difference, that divides; and it perceives after all that it is the same human creature that flies in the air, and swims in the sea, or walks biped upon the land.'

By no surer course can we attain to that 'natural piety' of which poets have sung than by the study and practice of this humane belief—which is humanitarianism.

LITERATURE.—The reader is referred to the following works for a fuller statement of some of the points touched on in the

foregoing article; but it should be noted that, while there are many books dealing with certain aspects of humanitarianism, there are very few that treat of the subject as a whole.

Jeremy Bentham, *Introduction to the Principles of Morals and Legislation*, London, 1789; W. E. H. Lecky, *History of European Morals*, do. 1888; Arthur Schopenhauer, *The Basis of Morality*, tr. A. B. Bullock, do. 1903; Howard Williams, *The Ethics of Diet*, do. 1907; E. Westermarck, *MI*, ch. xlv.; *Publications of the Humanitarian League*, London, including J. Howard Moore, *The Universal Kinship*, 1906, and Henry S. Salt, *Animals' Rights considered in relation to Social Progress*, 1905.

HENRY S. SALT.

HUMAN SACRIFICE.

Introductory and Primitive (A. E. CRAWLEY), p. 840.

Arabian.—See 'Semitic.'

Babylonian.—See 'Semitic.'

Celtic.—See COMMUNION WITH DEITY (Celtic), and ETHICS AND MORALITY (Celtic).

Chinese (J. DYER BALL), p. 845.

Egyptian.—See 'Semitic.'

Greek (A. C. PEARSON), p. 847.

Hebrew.—See 'Semitic.'

Indian (E. A. GAIT), p. 849.

Iranian (E. EDWARDS), p. 853.

Japanese and Korean (M. REVON), p. 855.

Persian.—See 'Iranian.'

Roman (R. WÜNSCH), p. 858.

Semitic (R. A. S. MACALISTER), p. 862.

Slavic (L. LEGER), p. 865.

Teutonic (E. MOGK), p. 865.

HUMAN SACRIFICE (Introductory and Primitive).—There are few races and few religions which can show a history free from the stain of human sacrifice. But, when the practice is examined without prejudice (though few practices have caused greater moral detestation), it will be found that such phrases as 'stain' are metaphors not always deserved, and that technically the term 'sacrifice' itself is rarely appropriate. The practice, or custom, or rite has extensive adhesions and numerous applications; its meaning in any particular instance is not always easy to disclose; but its very seriousness makes an analysis of it deeply instructive for the study of social psychology.

The fascination which human sacrifice has exercised over various peoples at a relatively high stage of culture at once suggests that it must be a social reaction to some deep-seated social sentiment. The subject, as Westermarck's analysis shows, cannot be treated any longer as a mere antiquarian horror. On the contrary, it goes to the very heart of the permanent principles of social life and organization. Scientific ethics has to admit that the causes which produced human sacrifice still exist, and that they produce results identical in substance, though differing in name. Yet even here popular language preserves the ancient name in metaphor, when it speaks of one man being 'sacrificed' for others, or of a hero 'sacrificing' his life to save many. The modern consciousness reverts to the form of the primitive by omitting, as a rule, the 'middle age' metaphorical *terminus ad quem*, as expressed by the word 'to.' But it shows a true insight in affixing to the preposition various social emotions and prejudices which may have ultimately inspired the 'sacrifice,' such as fear, vanity, lust, or shame.

It is hardly necessary to examine, or to revise, the current theory of sacrifice (*q.v.*) in general, for human sacrifice is only incidentally a sacrifice proper; that is, its essence is not, as a rule, either a gift or a communion. The practice, again, however 'brutal,' is hardly developed among the lower races. It is only when a relatively high culture has been achieved, with its resulting sense of power, that the practice grows. As Westermarck says,

'the practice of human sacrifice cannot be regarded as a characteristic of savage races. On the contrary, it is found much more frequently among barbarians and semi-civilized peoples than among genuine savages, and at the lowest stages of culture known to us it is hardly heard of.'¹

For instance, it was known in ancient India,

¹ *MI* i. 436f.

Greece, and Italy, among the Celts, Teutons, and Slavs, the Semites and Egyptians, the early Japanese, many African tribes, South Sea Islanders, some American tribes, and particularly the Mayas and Aztecs. Further, it was rarer in Vedic than in Brāhmanic India.¹ Among the Africans it has been observed that 'the more powerful the nation the grander the sacrifice.'² The Aztecs themselves did not adopt the practice until the 14th cent., two hundred years before the conquest; the sacrifices 'rare at first, became more frequent with the wider extent of their empire; till, at length, almost every festival was closed with this cruel abomination.'³

From the legal point of view every human sacrifice is a *ceremonial murder*. As such, cases which are technically sacrifices cannot be treated differently from those which are not. The tendency, not only in historical writing but in the thought and language of contemporary periods, is to class all ceremonial murder as sacrifice. Another qualification of human sacrifice is that, like the majority of all sacrificial acts, it is generally a collective undertaking; when an individual executes it, he is, as a rule, the representative of the community or at least of a class within it. This fact serves to throw into relief the close connexion that is maintained from the earliest to the latest instances between human sacrifice and the retributive functions of the community. Capital punishment in its simplest and most primitive form is a more or less unconscious act of social revenge. The essence of all punishment is the satisfaction of resentment. The principle of *talis* is the result of the organization of this fundamental moral impulse. But before it is organized, and even in civilization on occasions when the crowd is master, and justice yields to mob-law or lynch-law, the passion of resentment is rarely satisfied by any atonement save that of death. There is such a phenomenon as a collective lust for blood, and, sociologically speaking, we have a right to class together the behaviour of the Commune in the Revolution of 1789, and of the Aztecs in their systematized orgies of human sacrifice. Cases like these show moral resentment as a perversion, but there seems to be little distinction between them and the cases of primitive social revenge. Lastly, it was to be expected, and is

¹ *MI* i. 435 f. quoting authorities.

² W. Winwood Reade, *Savage Africa*, London, 1863, p. 52. Westermarck enumerates the areas in which human sacrifice has been practised (i. 435 f.).

³ W. H. Prescott, *History of the Conquest of Mexico*, London 1843, i. 65.

proved by the facts, that the history of society up to quite recent times is characterized by a special sense of collective responsibility. The belief that national or tribal distress or failure is due to national or tribal sin is very real. It is a question whether the source of this powerful idea is to be found in the sum of individual selfish or self-regarding impulses, the sum of individual desires to shirk individual responsibilities, or in the mutual imitation of elementary instincts of co-operation. However that may be, the whole history of human sacrifice is linked together by ideas of vicarious suffering, substitution, and representation, no less than by its form of collective murder. Throughout, we realize the extensive and normal application of the biologic-social law that the individual is inferior to the race, and, as against the race or community, has no rights; 'it is expedient that one man should die for the people' (Jn 11⁵⁰).

In that stage of culture when all social organization is religious, justice and worship are apt to be confused. Some cases, however, still show collective retribution. Von Kotzebue with great insight observes of the Sandwich Islanders that they 'sacrifice culprits to their gods, as we sacrifice them in Europe to justice.'¹ The ancient Romans are said to have put corn-thieves to death, as a sacrifice to Ceres. Among the Hebrews the ban, or *hērem*, was placed upon malefactors as enemies of Jahveh. It was

'properly dedication to Jahveh. . . . The persons who were "dedicated," generally by a solemn vow, to Jahveh, were put to death, frequently by fire, whereby the resemblance to an ordinary burnt-offering was rendered still more apparent; their dwellings and property were also consumed by fire; their lands were left uncultivated for ever.' 'Such punishments were very common in the ancient world. But in Israel, as elsewhere, they were at the same time religious acts.'²

For the human sacrifices annually offered to Baal in Rhodes, criminals took the place of the innocent victims who were previously sacrificed. Here, no doubt, as Frazer notes,³ there is an actual substitution of individuals who are worthless, and therefore suitable for destruction. Such cases may thus be accidental revivals, as it were, of an original punishment of offenders, an organized cultus having intervened.

The Mexicans included among the victims for their systematized human sacrifices criminals 'who were condemned to expiate their crimes by the sacrifice of their lives.'⁴ In Tahiti the victims were 'either captives taken in war, or individuals who had rendered themselves obnoxious to the chiefs or the priests.'⁵ Conversely, the Mexicans seem to have given all capital punishment the form of a sacrifice to their gods. This at least is stated in connexion with the punishment of sorcerers whose practices were injurious to the community or individuals.⁶

Westermarck recognizes the persistence of penal sacrifice:

'There is one form of human sacrifice which has outlived all others, namely, the penal sacrifice of offenders. . . . This kind of human sacrifice is even found where the offering of animals or lifeless things has fallen out of use or become a mere symbol. For this is the only sacrifice which is intended to propitiate the deity by the mere death of the victim; and gods are believed to be capable of feeling anger and revenge long after they have ceased to have material needs. The last trace of human sacrifice has disappeared only when men no longer punish offenders capitally with a view to appeasing resentful gods.'⁷

This form of human sacrifice, it has already been

¹ O. von Kotzebue, *Voyage of Discovery*, Eng. tr., London, 1821, iii. 248; cf. F. Granger, *Worship of the Romans*, do. 1895, p. 260.

² A. Kuenen, *Religion of Israel*, Eng. tr., London, 1874-75, i. 290 f.; Porphyry, *de Abstinencia*, ii. 54.

³ Frazer, *GB*, pt. iii. 'Dying God,' London, 1911, p. 196.

⁴ F. S. Clavigero, *History of Mexico*, Eng. tr., London, 1807, i. 282.

⁵ W. Ellis, *Polynesian Researches*, London, 1829, i. 346.

⁶ Bancroft, *Native Races*, San Francisco, 1882-83, ii. 462.

⁷ *MI* i. 471 f.

suggested, is on the normal lines of the evolution of the custom, and is the final development of the original inception of the social habit. It is not sacrifice, except in a large metaphorical sense. One might urge that, even after the administration of justice has become altogether separated from religion, there is no break of continuity—that in effect a new religion shows itself in the interval, and that capital punishment, or any punishment, is still a sacrifice to justice. The difference is that no superstitious ideas cluster round the destruction of the criminal life, and that the justice thus satisfied is not a personalized power. Westermarck's statement lays stress on the death of the victim as propitiating the deity. The deity thus being the personification of the moral feelings of the community repeats the moral, retributive impulses of the community. He requires not a sacrifice, but a just penalty. Westermarck notes¹ that 'there can be no moral scruples in regard to a rite which involves a punishment regarded as just.' But it would be a mistake to accuse of moral scruples the early offerers of any form of human sacrifice. All religious acts, however horrible, are *ex hypothesi* sincere, and therefore untouched by moral scruple. Pity and tenderness may, of course, attempt to inhibit the impulse, but this, being identical with the feeling of duty, is self-sufficient, whether in the individual or in the community.

The penal aspect of human sacrifice has been emphasized by the fact that semi-civilized and even civilized societies have, for various reasons, been in the habit of practising 'a severity which far surpasses the rigour of the *lex talionis*.'² Till quite recent times the penalty of death was prescribed for the majority of offences in all civilized communities.³ There can be no doubt that the spectacle of capital punishment offered to the public in England, for example, till the last century, satisfied the same instincts as did the gladiatorial games of Rome and the sacrificial massacres of Mexico. This severity is connected with despotism or religion.⁴ In either case, acts which may arouse the anger of semi-divine or divine beings are punished with more severity, because the community fears that the divine wrath may be turned against itself.⁵ This has actually been made an argument for applying the death-penalty to all offences. Thus, the Peruvians held that 'a culprit was not punished for the delinquencies he had committed, but for having broken the commandment of the Ynca, who was respected as God,' and that, therefore, the slightest offence deserved death.⁶ Every crime, in Hebrew theory, involves a breach of God's law, and no punishment is too severe for the ungodly. 'These ideas were adopted by the Christian Church and by Christian governments.'⁷

A link between the conception of the god and his offended holiness and the penal aspect of human sacrifice may be found in the reason given for the sacrifice of criminals—that they are already hateful to the god.⁸ Any such convenient inferior persons may, again, almost suggest the principle of preventive sacrifice or penalty. On the Slave Coast

'the object of human sacrifice seems to be to gratify or satiate the malignity of the gods at the expense of chosen individuals, instead of leaving it to chance—the victims are, in fact, slain for the benefit of the community at large.'⁹

A considerable proportion of cases may be regarded as founded on a nervous collective 'sense of sin,' which should perhaps be explained as the sense of responsibility in the making. These form

¹ *MI* i. 471.

² *Ib.* i. 186.

³ *Ib.* i. 186 ff.

⁴ *Ib.* i. 193 f.

⁵ *Ib.* i. 194.

⁶ Garcilasso de la Vega, *Commentaries of the Yncas*, tr. C. R. Markham, London, 1869-71, i. 146.

⁷ *MI* i. 197.

⁸ *Ib.* i. 439.

⁹ A. B. Ellis, *Ever-speaking Peoples*, London, 1890, p. 119

the central feature in the panorama of human sacrifice, and therefore require illustration.

The Chippewas, suffering from an epidemic, regarded it as a divine punishment for their wickedness. The most beautiful girl of the tribe was set adrift in the river and allowed to drown, as a means of staying the plague.¹ Similarly the Bœotians sacrificed a boy to stay a pestilence.² Referring to the Hebrews, Philo of Byblus says :

'It was the custom among the ancients, in cases of great danger, that the rulers of a city or a nation, in order to avert universal destruction, should give the dearest of their children to be killed as a ransom offered to avenging demons.'³

In the Niger country, a young woman is sacrificed to take away the iniquities of the land. As her body is dragged along 'in a merciless manner, as if the weight of all their wickedness were thus carried away,' the people cry, 'Wickedness! wickedness!' She is drowned in the river.⁴ Another account speaks of two sacrifices, one for the land, the other for the river.

'Thus two human beings were offered as sacrifices, to propitiate their heathen deities, thinking that they would thus atone for the individual sins of those who had broken God's laws during the past year. . . . Those who had fallen into gross sins during the past year—such as incendiarisms, thefts, fornications, adulteries, witchcrafts, incests, slanders, etc.—were expected to pay in twenty-eight *ngugas*, or £2, 0s. 7½d., as a fine; and this money was taken into the interior, to purchase two sickly persons, to be offered as a sacrifice for all these abominable crimes.'⁵

The Chukchi in 1814 sacrificed a respected chief to stay an epidemic which was destroying both men and reindeer.⁶ The sacrifice of every living creature born in the following spring, which constituted the ancient Italian rite of the *Ver Sacrum*, was performed in times of peril or pestilence.⁷ Human sacrifice in cases of drought and famine is frequent.⁸ When unseasonable weather threatened the crops, the Peruvians sacrificed children.⁹ The people of Great Benin, in case of excessive rain, asked the king

'to make jujū, and sacrifice to stop the rain. Accordingly a woman was taken, a prayer made over her, and a message saluting the Rain God put in her mouth; then she was clubbed to death and put up in the execution tree so that the rain might see. In the same way, if there is too much sun, so that there is a danger of the crops spoiling, Overami [the king] can sacrifice to the Sun God.'¹⁰

This instance is instructive. It includes a plain connexion with the penal aspect of sacrifice, and also the later notion that the slain person acts as a messenger to the god. The possibility of using sacrifice, not merely as an expiation, but as an expiation in advance—in other words, as a preventive—is also suggested. How such rites may easily become positive is well shown by another case from Great Benin. Sir Richard Burton saw a young woman

'lashed to a scaffolding upon the summit of a tall blasted tree, and being devoured by the turkey-buzzards. The people declared it to be a "fetish," or charm for bringing rain.'¹¹

Such agricultural sacrifices are common enough;¹² they tend to become annual and seasonal. Westermarck shows good reason for supposing that the victim is by no means always regarded as a representative of the corn-spirit, as is argued in Frazer's hypothesis.¹³

Ancient Greeks, Gauls, Semites, and Hindus sacrificed human beings in war, either to guard against ill-success or to propitiate the divine being

¹ R. Dorman, *Primitive Superstitions*, Philadelphia, 1881, p. 208.

² Pausanias, ix. viii. 2. ³ Eusebius, *Præp. Evang.* i. x. 40.

⁴ Frazer, *GB* 3, pt. vi. 'The Scapegoat,' p. 211.

⁵ S. Crowther and J. O. Taylor, *Banks of the Niger*, London, 1859, p. 343 f.

⁶ F. von Wrangell, *Expedition to the Polar Sea*, London, 1840, p. 122 f.

⁷ Festus, *de Verb. Signif.*, ed. C. O. Müller, Leipzig, 1839, p. 379.

⁸ See examples in *MI* i. 443 f.

⁹ A. de Herrera, *Gen. Hist.*, Eng. tr., London, 1825-26, II. 111.

¹⁰ H. Ling Roth, *Great Benin*, Halifax, 1903, p. 71.

¹¹ R. F. Burton, *Abeokuta*, London, 1863, I. 19.

¹² For examples, see *MI* i. 448-452. ¹³ *Ib.* i. 444-451.

who had brought it about.¹ How far the principle may be carried is illustrated by the Carthaginian sacrifice of two hundred children, when the city was in the last stage of siege.

The transition from the idea of securing the lives of the community by sacrificing the life of one man to the idea of propitiating a malignant supernatural power is naturally easy in such circumstances. The people of Jaipur propitiated their god of battle by human sacrifice.

'On the eve of a battle, or when a new fort or even an important village is to be built, or when danger of any kind is to be averted, this sanguinary being must be propitiated with human blood.'²

Sacrifice after victory may, when the ideas of sacrifice proper have fully coloured the rite, be regarded as a thank-offering. But revenge on the enemy, the fulfilment of a vow (itself connected with the impulse of resentment), or, further, propitiation, may in many cases inspire the custom.³

An important feature of this vicarious atonement, whether expiatory or preventive, is that the victim is not chosen at random. He may be a worthless person, a criminal or outcast, diseased, a slave, or a young child; he may also be the choicest of youth, or even the king of the people. The precise character of the person slain generally qualifies the meaning of the rite; a child, for instance, may be a substitute for his father; a king for his people; a criminal, similarly, represents the guilty soul of the community. Westermarck has rightly argued that the victim

'is a representative of the community which has incurred the anger of the god, and is accepted as a substitute on the principle of social solidarity.'⁴

The atonement of Christ is conceived of as a sacrifice, and His personality as fully representative.

'According to the Western Church, Christ discharged the punishment due to the sins of mankind, and propitiated the justice of his Father, in his capacity of a man, as a representative of the human race; whereas in the East, where it was maintained that the deity suffered (though he suffered through the human nature which he had made his own), the idea of substitution could hardly take root, since, as Harnack (*Hist. of Dogma*, iii. 312 f.) remarks, "the dying God-man really represented no one." The Greek Church regarded the death of Christ as a ransom for mankind paid to the devil, and this doctrine was also accepted by the most important of the Western Fathers, although it flatly contradicted their own theory of atonement.'⁵

'When men offer the lives of their fellow-men in sacrifice to their gods, they do so, as a rule, in the hopes of thereby saving their own. Human sacrifice is essentially a method of life-insurance—absurd, no doubt, according to our ideas, but not an act of wanton cruelty. When practised for the benefit of the community, or in a case of national distress, it is hardly more cruel than to advocate the infliction of capital punishment on the ground of social expediency, or to compel thousands of men to suffer death on the battle-field on behalf of their country. The custom of human sacrifice admits that the life of one is taken to save the lives of many, or that an inferior individual is put to death for the purpose of preventing the death of somebody who has a higher right to live. Sometimes the king or chief is sacrificed in times of scarcity or pestilence, but then he is probably held personally responsible for the calamity. Very frequently the victims are prisoners of war or other aliens, or slaves, or criminals, that is, persons whose lives are held in little regard. And in many cases these are the only victims allowed by custom.'⁶

The execution of heretics, as such, is a culmination of the social principle that the Godhead is deeply interested in the loyalty of the believing people. The *auto da fé* is a true human sacrifice of the penal species; it might readily take on the character of sacrifice proper, as it probably has done in the analogous cases of Hebrew extermination of the heathen and Muhammadan destruction of unbelievers, though in Europe this character has not been emphasized.

When the principle that the death of one may save the lives of the community has become part of

¹ Caesar, *de Bell. Gall.* vi. 16; Pausanias, iv. ix. 4 f., ix. xvii. 1; 2 K 827; Herod. vii. 167; Diodor. xx. 14; N. Chevers, *Medical Jurisprudence for India*, Calcutta, 1870, p. 399.

² J. Campbell, *Tribes of Khondistan*, London, 1864, p. 52.

³ Jg 1130ⁿ. (Jephthah's vow); Diodor. xx. 65; A. B. Ellis, *Tshi-speaking Peoples*, London, 1887, p. 170.

⁴ *MI* i. 68.

⁵ *Ib.*

⁶ *Ib.* i. 466 f.

the popular creed, voluntary sacrifice may be undertaken. Ancient Rome owed victories in battle to the *devotio* of heroes, such as Decius Mus. This devotional suicide was a religious act, and had a prescribed ritual. The *harakiri* of the Japanese is certainly a sacrifice; when committed at the funeral of a Mikado or of any dead person it is of the nature of an offering to the soul of the dead, in that form which ensures that the dead shall have companions and attendants. The Chukchi and Samoyeds are curiously addicted to suicide; in fact, there is a suicidal belt across Northern Asia, including the Japanese. The Samoyed holds that the act is in itself 'pleasing to God, who looks upon it as a voluntary sacrifice, which deserves reward.' The Chukchi sacrifice their own lives in times of national danger or epidemic.¹ The *satī* of Hindu widows on the pyres of their dead husbands is repeated elsewhere, as in Uganda, the East Indies, Fiji, and the New Hebrides.² Such sacrifice is analogous to acts of asceticism, and, like these, is often connected with the desire for betterment in the world beyond the grave.

Human sacrifice was performed, also, to save the life of some particular individual. The Guatemalans resorted to it when all other means of curing a sick person failed.³ To-day in Morocco, if a child dies, the custom is to congratulate the parents—'Your child took away your misfortune.'⁴ The practice of sacrificing the first-born child seems to have been an article of ancient Semitic religion; the origin of the Passover is most probably to be traced to it.⁵ The practice is found, more or less systematized, in Australia, China, America, Africa, and Russia.⁶ Infanticide, at a stage of culture when all social custom is religious, naturally assumes the character of a 'sacrifice.' There may be various motives for the act, but only cases where there is a real substitution for the life of another person can be included under human sacrifice. Substitutional sacrifice for individual benefit occurs in Central America, Peru, Tonga, Tahiti, the Philippines, India, the Dayak countries, West Africa, and Scandinavia. It was frequent in ancient Italy, and both Nero and Hadrian were beneficiaries of the rite.⁷

There is a curious practice, connected with the doctrine of the soul, of sacrificing an individual, generally a child, to remove barrenness from women. As Westermarck explains it, the failure to bear children 'is attributed to some god keeping back the children which would otherwise be born in the due course of nature.' The victim is a substitute.⁸

Certain cases of child-sacrifice seem to suggest that the child, being in a sense a duplicate of the father, places the life of the father in danger.⁹

When the idea is arrived at that the person sacrificed is a gift to the deity, we are in the sphere of sacrifice proper. But this is clearly later than the penal conception and even the substitutional conception of the rite. The gods of the Gold Coast require attendants:

'The ghosts of the human victims sacrificed to them are believed to pass at once into a condition of ghostly servitude to them, just as those sacrificed at the funerals of chiefs are believed to pass into a ghostly attendance.'¹⁰

The belief is rare, but, as applied to the service

¹ *MI* II. 234.

² *Ib.* II. 224 ff.

³ *Ib.* I. 454.

⁴ *Ib.* I. 457.

⁵ Frazer, *GB*², pt. III. p. 175 ff.; see Ex 132¹², Mic 67, Nu 1818; Kuenen, II. 92.

⁶ R. Brough Smyth, *Aborigines of Victoria*, Melbourne, 1878, II. 311; F. Boas, *5th Report North-Western Tribes of Canada*, London, 1890, pp. 46, 62; J. F. Laftau, *Mœurs des sauvages américains*, Paris, 1724, I. 181; J. J. M. de Groot, *Religious System of China*, Leyden, 1892 ff., II. 679; J. L. Krapf, *Travels*, London, 1860, p. 69 L.; *GB*², pt. III. p. 183.

⁷ *MI* I. 454 ff.

⁸ *Ib.* I. 457 ff.

⁹ *Ib.* I. 460.

¹⁰ A. B. Ellis, *Tsht-speaking Peoples*, 199.

of the dead, is frequent. The type of it is the Hindu *satī*. Men require both wives and servants in the other world. India, probably even in Vedic times, and Central America are the chief areas of the practice of immolating wives and slaves or friends for the dead, but it is found all over the world.¹ Blood-revenge in many cases is really a human sacrifice to the spirit of the murdered man.² The completed revenge is frequently believed also to safeguard the avenger from the malignancy of the unavenged dead. Such ideas are merely superimposed upon a practice originally inspired by the impulse of resentment.

Other ideas, probably later than the institution of the rite, are the conception that the man sacrificed is a messenger to the gods; and that he becomes, when sacrificed at or in a new building, a protecting demon of the place. Probably the original intention was to protect the living from the risks incurred by occupying a site belonging to supernatural powers. This is seen in the case of sacrifices made at the building of bridges (*q.v.*). Human sacrifices to the powers of water, sea- or river-demons, are common enough, and folklore is full of stories of them.³

Cannibalism (*q.v.*) is probably not to be regarded, as Letourneau regards it, as the original sin of mankind.

'The cannibalism of modern savages,' Westermarck concludes, is not 'a survival from the first infancy of mankind,' nor is it representative of 'a stage through which the whole human race has passed.'⁴

But there can be little doubt that primitive peoples, like barbarous and even civilized peoples on occasion, practised cannibalism as an infrequent habit. Now, according to one theory of sacrifice, the essence of this central act of worship is the provision of a common meal for the god and his worshippers. *A priori* there is every reason to expect that the idea of cannibalism should be found in many cases of human sacrifice. The Central Americans, especially the Mexicans, offered the blood and the heart of the victim to the god. The priest cut open the breast, and tore out the heart. This was 'waved' as an offering to the Sun; frequently it was placed with a golden spoon in the mouth of the image.⁵ The Iroquois, the Khonds and Ooryahs of India, the Fijians, and peoples of the Gold Coast, had similar ritual and belief.⁶ Cannibal meals, which possess a magical or religious character, satisfy the above definition of sacrifice, if the victim is slain for the purpose. The most inveterate followers of the cult of human sacrifice, as it may truly be called in this case—the Mexicans—ate portions of the human victims slain on their altars. The Mayas, Nicaraguans, and Peruvians did the same. In Nigeria, human sacrifice offered to appease the gods, or to avert misfortune, is not 'considered to be complete unless either the priests or the people eat the bodies of the victims.' In some parts the flesh is distributed among the entire population.⁷ The practice is found in the Solomon Islands, Hawaii, and ancient India, always in connexion with a sacrifice. Two species of cannibalism are distinguished in Western Africa, the one a luxury, *gourmandise*, the other sacrificial, and in the latter the priests are the chief partakers.⁸

¹ *MI* I. 472 ff.

² *Ib.* I. 482.

³ *Ib.* I. 452 ff., 461 ff.

⁴ *Ib.* II. 580.

⁵ Bancroft, *Native Races*, II. 307, 310 ff., 707 ff.; Clavigero, I. 279.

⁶ *MI* I. 437 ff., citing authorities.

⁷ Bancroft, II. 176, 725, III. 443 ff.; A. F. Mockler-Ferryman, *British Nigeria*, London, 1902, p. 261; C. Partridge, *Cross River Natives*, do. 1906, p. 59.

⁸ R. H. Codrington, *The Melanesians*, Oxford, 1891, p. 343; J. Remy, *Ka Moolelo Hawaii*, Paris and Leipzig, 1862, p. xl; A. Weber, *Indische Streifen*, Berlin and Leipzig, 1863-79, I. 72 ff.; Winwood Reade, p. 168.

'The sacrificial form of cannibalism,' says Westermarck, 'obviously springs from the idea that a victim offered to a supernatural being participates in his sanctity and from the wish of the worshipper to transfer to himself something of its benign virtue. So also the divine qualities of a man-god are supposed to be assimilated by the person who eats his flesh or drinks his blood. This was the idea of the early Christians concerning the Eucharist.'¹

Similarly, the eating of human flesh is in various cases supposed to have a magical and supernatural effect. The circle of these ideas is completed by the remarkable belief, found in the majority of races, that the flesh and blood of executed offenders have magical power. The mere fact of a violent death, when imposed on a victim by corporate action, is always impressive. It is possible that we have here the psychological explanation of the magical virtues with which such human sacrifices are credited. They are the sign and seal of the sacred force of the community in action.

Westermarck finds, in criticism of Frazer's hypothesis, 'no instance of an expiatory sacrifice being connected with a ceremony of sin-transference.'² The *meriah* sacrifice of the Khonds is a notable example of human sacrifice. Its meaning is interpreted by Frazer to be that the victim was a representative of the corn-spirit and was sacrificed in order to ensure good crops, on the principle chiefly of the resurrection of the spirit.³ The interpretation involves the assumption that the view of the *meriah* as a victim offered to deity, the Earth-goddess, Tari Pennu, is a late sophistication. Macpherson notes that the *meriah* was sacrificed

'upon the occurrence of an extraordinary number of deaths by disease; or should very many die in childbirth; or should the flocks or herds suffer largely from disease, or from wild beasts; or should the greater crops threaten to fail'; also whenever any calamity occurred to the chiefs or their families.⁴

From this and other evidence, Westermarck concludes that the theory of substitution accounts fully for the rite, and that the hypothesis of the identification with the corn-spirit is arbitrary.⁵ See, further, the 'Indian' article, § 4.

Magical efficacy is universally attributed to human blood, probably because it is human, that is, the blood of the lord of creation, who, as such, is not normally an article of food. Human sacrifice to the dead is sometimes for the purpose of supplying them with food.⁶ But this is obviously exceptional, just as the dead are themselves in an exceptional state. They are now supernatural, and supernatural (in the literal meaning) should be their sustenance. There is no relic of cannibalism in the *meriah* sacrifice, but the principles of religious cannibalism are latent in it.

Ancestor-worship, it is possible, may often have led to the idea that a supernatural source of magical power may be secured by slaying ceremonially a human, or indeed any living, victim. If the dead are divine, new additions to the list of the divine can be made by death. The murderer has an option on the spirit of him he slays. Blood-thirsty priests and despots may at times have worked their murderous wills according to some such principle. It is necessary to insist on this, as also on the satisfaction of the social lust for blood. The latter certainly is to be seen in the *meriah* sacrifice; both the latter and the former are as evident in the Mexican holocausts as they were in the *auto da fé*.

The gods of Mexico were enhaloed with horror; but the human sacrifices almost daily consummated to glut their malignancy were appreciated by the congregation as intensely as the gladiatorial combats were by the populace of Rome. In some cases

¹ *MI* ii. 563 f.

² *Ib.* i. 65.

³ Frazer, *GB*³, pt. v. 'Spirits of the Corn and of the Wild,' London, 1912, vol. i. p. 249 f.

⁴ S. C. Macpherson, *Memorials of Service in India*, London, 1865, p. 113 f.

⁵ *MI* i. 445 f.

⁶ *Ib.* i. 475 f.

the sacrifice was actually preceded by a combat, the victim having a chance of escape if he succeeded in slaying all comers who cared to fight him on the pavement of the altar.

'Scarcely any author pretends to estimate the yearly sacrifices throughout the empire at less than twenty thousand, and some carry the number as high as fifty thousand.'¹

Both Mayas and Mexicans prosecuted endless wars, with the principal object of obtaining victims to serve as sacrifices to their gods.² A typical picture of such a sacrifice is supplied by that in honour of Tezcatlipoca, though the figure of this deity is usually mild and venerable.

'The man chosen to represent him [Tezcatlipoca] and die in his stead was a young captive of handsome person and illustrious birth. During his captivity the youth thus doomed to play the fatal part of divinity was allowed to range the streets of Mexico freely, escorted by a distinguished train, who paid him as much respect as if he had been indeed the god himself instead of only his living image. Twenty days before the festival at which the tragic mockery was to end, that he might taste all the joys of this transient world to which he must soon bid farewell, he received in marriage four women, from whom he parted only when he took his place in the last solemn procession. Arrived at the foot of the sacred pyramid on the top of which he was to die, the sacrificers saluted him and led him up the long staircase. On the summit five of them seized him and held him down on his back upon the sacrificial stone, while the high priest, after bowing to the god he was about to kill, cut open his breast and tore out the throbbing heart with the accustomed rites. But, instead of being kicked down the staircase and sent rolling from step to step like the corpses of common victims, the body of the dead god was carried respectfully down, and his flesh, chopped up small, was distributed among the priests and nobles as a blessed food.'³

The details, however, are too numerous to add to the account. The problem chiefly considered hitherto has been that of the dying god. Certainly, in the case of the victims to Tezcatlipoca, Huitzilopochtli, Huixtocihuatl, and Centeotl, there was representation of the deity. Whether Frazer's explanation can be accepted is, however, doubtful. It is noteworthy that of the Nicaraguan human victims it is stated that 'they were supposed to become deified after death, and to exercise great influence over the affairs of life.'⁴ The Mexicans, again, sacrificed men with white hair and white faces during eclipses of the sun; the Tlascaltecs sacrificed albinos during eclipses of the moon.⁵ Bancroft conjectures, whatever the original signification of the human sacrifice, that finally the body, whose essence regaled the god, and whose accidents were participated in by priests and people, was regarded as the remains of a divine feast, and therefore sacred food; that religious anthropophagy degenerated into an unnatural appetite for human flesh.⁶ He is desirous of explaining the extraordinary popularity of these sacrifices. They certainly may be regarded as including a recrudescence of cannibalism. More significance, however, is to be attached to the holiness acquired after death. Apart from the factor of substitution and penal sacrifice, this appears to be most important. Accordingly, the sacrifice may be said to have the character of a rite intended to make gods by slaying men. All men, animals, and things 'offered up' become *ipso facto* endued with magic energy.⁷ But this character is itself not primary. Hindu theory speculated on the nature of the essence of sacrifice. Some of the conclusions throw light on the present subject.

According to the *Aitareya Brāhmaṇa*, the gods killed a man for sacrifice. But the part fit for an offering, the *medha*, passed into a horse, which thus became meet for sacrifice. The gods killed the horse, but the *medha* passed into an ox, and subsequently in the same way into a sheep, a goat, and the earth. The *medha* stayed longest in the goat. All those animals from which it passed are

¹ Prescott, i. 69.

² Bancroft, ii. 420, 740, 745.

³ Frazer, *GB*³, pt. v. vol. i. p. 92 f., from Brasseur de Bourbourg, iii. 510 ff.; see Bancroft, ii. 319 ff., iii. 422.

⁴ Bancroft, iii. 494.

⁵ *Ib.* 110 f.

⁶ *Ib.* 444.

⁷ See *MI* i. 62.

unfit for sacrifice, and therefore their flesh is not to be eaten. When the *medha* entered the earth, the gods surrounded it to prevent its escape. There it turned into rice, and therefore rice is now sacrificed.¹

According to the *Kālikā Purāna*, slaying at a sacrifice, even of a man, is *ipso facto* no murder.²

The *Taittirīya* states that the institutor of the sacrifice, when slaying a man, immolates Virāj. Virāj was the first male created by Prajāpati, and was the father of mankind. From him is produced the male for every sacrifice.

¹ The form of a man is like that of Virāj, the type of the animated creation. By the immolation of the man is Virāj immolated. Now Virāj is food, and therefore through Virāj is food obtained.²

With regard to the difficult problem of 'representing' the god, a case in point is given by the *Taittirīya*. For the *puruṣamedha*, human sacrifice, the *Taittirīya* enjoins that to a deity of the Brāhman caste a Brāhmana must be sacrificed; to a deity of the Kṣatriya, a Kṣatriya.⁴ Possibly the clue to representation is in the practice of periodic god-making. A man, and a particular kind of man, being made by sacrifice into a deity, it is natural that his attributes should be repeated at the next sacrifice. Thus a particular god is re-created periodically. When, later, his incarnation is regarded as a victim, the victim retains the characters of the god. See, further, the 'Indian' article.

Often the choicest specimens of humanity are required for human sacrifice. 'The death of the righteous makes atonement';⁵ here moral worth is required. The *Kālikā Purāna* enjoins that the victim must be free from physical defects and unstained by crime; nor may it be a female.⁶ The case of slaves, malefactors, and diseased persons has already been noted.

Vicarious atonement becomes vicarious in a secondary sense, when another person is sacrificed instead of the original victim. In Eastern Africa, a freeman guilty of causing a conflagration close to the 'chosen abode of the deity' is liable to be offered as a sacrifice to the god who has been annoyed, but he may redeem his life by giving up one of his slaves to be offered in his stead.⁷ Animals, again, certainly have figured largely as substitutes for human victims.

¹ According to the Israelite's notion, Jahveh in his clemency permits the soul of the animal sacrificed to take the place of that of the sacrificer. No transfer of guilt to the animal sacrificed takes place; the blood of the latter is clean, and remains so, as is evident from the very fact that this blood is put upon the altar; it is a token of mercy on Jahveh's part, that he accepts it. . . . Nor can it be asserted that the animal sacrificed undergoes the punishment in the place of the transgressor.⁸

Effigies, lastly, may take the place even of bread and fruits of the earth as substitutes for the human victim. In Malaysia, dough models of human beings, actually called 'the substitutes,' are offered to the spirits.⁹ Such substitutes occur in all parts of the world, and in the majority of its organized religions.

LITERATURE.—Ch. xix. in E. Westermarck's *Origin and Development of the Moral Ideas*, London, 1906-08 (l. 434-476), is the standard account of the subject. The art. mentions the chief sources of facts.

A. E. CRAWLEY.

HUMAN SACRIFICE (Chinese).—Unlike many nations of ancient or even modern times, such as the Aztecs, or Dahomans, the Chinese have had no regular system of human sacrifices, offered to the deity or forming a part of their idolatrous worship. Their altars have never reeked with the blood of

¹ Rājendralāla Mitra, *Indo-Aryans*, London, 1881, II. 77.

² *Ib.* II. 107.

³ *Ib.* 89.

⁴ *Ib.* 92, 103 f.

⁵ Moore, in *EBI* IV. 4226.

⁶ J. A. Dubois, *People of India*, Eng. tr.³, Oxford, 1906, p. 647.

⁷ D. Macdonald, *Africana*, London, 1882, I. 96 f.

⁸ Kuenen, II. 266 f.

⁹ W. W. Skeat, *Malay Magic*, London, 1900, p. 72.

the brute creation, much less with that of their fellow-man. We have no record of holocausts of victims being offered up at the shrines of their deities. Flesh is no doubt offered in the rites of worship, but the animal or fowl is already slaughtered and dressed before being brought to the altar, and is offered as food might be to a man—it partakes of the character of an oblation, instead of that of a sacrifice. The type of deities, i.e. of deified human beings, is more that of mild or benevolent gods or goddesses. There is no equivalent of the Indian Kālī; there is nothing like the ponderous car of Jagannāth leaving mangled remains of crushed humanity in its course. The fierceness of the Chinese gods is developed in the direction of the destruction of demons; they do not thirst for human blood and do not require to be appeased by the offering of it.

Notwithstanding all this, there are indications to be found in Chinese history of a feeling in the Chinese mind that High Heaven may be propitiated by the shedding of human blood; for several instances occur of human sacrifice being suggested at least. One of the most noteworthy was in the time of T'ang (1766-1753 B.C.), the founder of the Shang dynasty. We are told by the great historian Ssu-ma Ch'ien and by others that, as in the land of Egypt in the time of Joseph, seven years of drought prevailed in the Empire, leading to a terrible famine. To such extremities did matters come that it was suggested that a human victim should be offered as a sacrifice to appease Heaven and bring down the showers of much-needed rain. The Emperor T'ang said: 'If a man must be a victim, I will be he,' and prepared himself for the sacrifice. Ere the prayer he offered was finished, the rain fell in heavy showers on the parched land for hundreds of miles.¹

The Scythian custom of slaying the wives and attendants of deceased chieftains and others high in rank or social position was in vogue in ancient China. A time-honoured custom of burying wealth and valuables—gold, silver, precious stones, silks and embroideries, etc.—with the deceased lasted long. Wives, concubines, and slaves were also looked upon as the property of their lords and masters, and shared the same fate as the other possessions thus interred; for, with the anthropological conceptions of the Chinese with regard to a future state of existence, the life beyond the grave was supposed to be almost a counterpart of this life; and, since such articles and persons were necessary for the happiness and comfort of the living, it was thought that they were equally necessary for the dead, and that those who had passed into another state of existence would suffer and harbour resentment unless freely supplied with them. The drain upon the resources of the people, owing to the enormous expenses entailed by the grand funerals, was such that a gradual process ensued of substituting less costly articles for the rich wares and precious things, so that articles of no real value took the place of the original offerings in most cases; and, in the same way, the substituting of imitation men and women has replaced the immolation of human beings at the obsequies of the great and wealthy.² We have in the Book of Mencius³ a passage which shows that wooden images, 'the semblances of men,' were used to bury with the dead. We are told that in ancient times bundles of straw imperfectly representing men were taken to the grave and interred with the deceased to serve in the next world as his attendants. Later on, after the advent of the Chow dynasty (1122-249 B.C.), wooden images were substituted for

¹ See J. Macgowan, *A History of China*, London, 1897, p. 29, or any other standard history of the country.

² See J. J. M. de Groot, *Religious System of China*, Leyden, 1892 ff., vol. II. ch. VIII.

³ Bk. I. pt. I. ch. IV. ver. 6.

them. These had springs which caused them to move, probably in imitation of the movements of men.¹ It is stated that later on came the practice of burying living persons with the dead. Confucius ascribed this to the invention of the wooden images; but it is more probable that the human sacrifice to the *manes* of the deceased was the original form, and the straw and wooden images were substituted for the more cruel custom, as was the case in Japan, where clay images were substituted about the time of the Christian era for the human victims.² Images are now made of a bamboo framework and covered with coloured paper to represent human beings, clothed in accordance with the station in life of those they are supposed to represent. These are carried, as in the case of the late Empress Dowager, in the funeral procession and burned. It is believed that they are thus transmitted to the spirit world and there wait upon their supposed lords and masters.

This practice of sacrificing living human beings to the *manes* of the departed who occupied high positions when alive was common, as may be gathered from the occasional references to it in Chinese literature. The silences concerning it have also been considered as corroborative of the practice; for, being common, it is supposed that reference was made to it only under exceptional circumstances.³ The custom appears to have been indigenous among the Chinese and not imported from Tatar sources, as Biot⁴ and even some Chinese have thought to be the case.

The Chinese Herodotus, Ssu-ma Ch'ien, mentions the first instance we have on record, when a ruler, Wu, of the Ts'in State made 66 people 'follow the dead [Duke Ch'ing] into the next world.'⁵ A nephew [Duke Muh] of this prince had 177 sacrificed at his death. Among these were three brothers put into the grave with the coffin of the Duke.⁶ Their fate is deplored in the songs of the State included in the ancient Chinese Classic, the *Shi King*, or 'Book of Poetry.' This was in 620 B.C.⁷ Hundreds perished at the royal funerals, and scores at those of officers and nobles, in antiquity. The philosopher Micius, who lived about the 3rd cent. B.C., inveighing against extravagant funerals, informs us of this.⁸ At the death of the Great Ts'in Shi Hwang, the builder of the Great Wall and the destroyer of the books, all the women in his harim who had borne him no sons were shut up in his tomb (209 B.C.).⁹ 'There is some reason for believing that human sacrifices occurred at the construction of the Great Wall.'¹⁰

In the *Ch'un Ch'iu*, or 'Spring and Autumn Annals,' of Confucius and in the two Commentaries on them, the *Tso Chuan* and *Ku Liang*, mention is made of some cases. Two instances were in 639 and 529 B.C. respectively, and in neither case was it at funeral rites that the immolation took place. In the first the Viscount of Tsang was sacrificed instead of an animal¹¹ by the people of Chu, to awe some wild tribes in the east. The Minister of War inveighed against this sacrifice of a man, a ruler of a State, to 'an unlicensed and irregular spirit.' In the second case the heir of the State of Ts'ai, after the destruction of that State, was carried by the victors to their own State of Tso and sacrificed on a

mountain—one would suppose as a thank-offering for the victory gained¹—again instead of an animal. In the *Tso Chuan* it is stated that living persons were interred with the dead ruler Duke Wan of Sung (587 B.C.).² Another case is mentioned in the same work where, out of gratitude to a king for his clemency to his father, a son buried two daughters with the sovereign.³ Another, a servant, dreamed that he carried his ruler up to heaven and later in the day he lifted the dead body of this same ruler out of a privy and was buried with him (580 B.C.).⁴ Again, in 502 B.C. we read of five men being buried alive at the death of a feudal ruler of the State of Chu.⁵ It is stated in the 'Annals of Wu and Yueh'⁶ (ch. 2) that a crowd of men were, by a trick, pressed alive into the mausoleum of a princess in 510 B.C. In a number of cases these entombments were disapproved of by the people.

In another of the Chinese Classics, the *Li Ki*, or 'Book of Rites,' accounts are given of two proposals to bury the living with the dead. In one case the widow and steward of the deceased, a grandee of the State of Ts'ai, proposed that, to provide for the dead man when ill in the next world, some persons should be sent to minister to him. His younger brother, who was a disciple of Confucius, said that it was not proper to do so, but suggested that, if it must be done, the widow and steward should be the persons to be sent. This pronouncement settled the matter, and no one was sacrificed.⁷ The other case was that of a son who refused to carry out his father's injunctions to bury his two concubines with him in the same coffin.⁸ There is a similar case where directions were given by a dying man that a favourite concubine should be buried with him, though he had previously directed that she should be married again.⁹ The son obeyed the earlier order. A Queen Dowager, who loved a minion, commanded that he should be buried with her; but, being reasoned with, yielded to persuasion and gave up the idea (309 B.C.).¹⁰ The Prince of Wu (514-496 B.C.) sacrificed a large number of men and women at the death of a favourite daughter in order that they might accompany her.¹¹ In the Han dynasty (206 B.C.—A.D. 25), certain tombs of princes of the Wei State (334-286 B.C.) were opened. In one a hundred dead bodies were found—all women with one exception—probably intended for the deceased's harim in the spirit world.¹² In another grave two bodies were found. To come later down in history, we find that this practice was specially maintained by the Tatar Liao dynasty which ruled over Northern China (A.D. 927-1125).¹³

It will thus be seen that throughout Chinese history there are indications of the prevalence of this custom. One instance was in A.D. 954, when the first Emperor of the After Chow dynasty (A.D. 951-960) gave orders for a simple funeral for himself, and on no account was any one to be injured in connexion with it.¹⁴

We find notices also of sacrifices to the spirits of Nature, as, for instance, in A.D. 1130-31 at the siege of a city in the North of China when the Kin invaders tore out the hearts of twelve prisoners and offered them as a sacrifice for a change of

¹ J. Legge, *Chinese Classics*, Hongkong, 1861-72, vol. ii. bk. i. pt. i. ch. 6 and note.

² Hisbo Saito, *History of Japan*, London, 1912, p. 14.

³ See de Groot, ii. 721.

⁴ See *JA*, 1843, and de Groot, ii. 723.

⁵ *Historical Records*, ch. v. line 8, quoted by de Groot, ii. 721 ff.

⁶ *Ib.* v. lines 16-17; also *Tso Chuan*, seventh year of the Ruler Wen's reign (Legge, *Chinese Classics*, v. i. 242, 244), and *JRAS* (N. China Branch), new ser., xv. [1880] 13 f.

⁷ Pt. i. bk. xi. ode vi.

⁸ See de Groot, ii. 669.

⁹ *Ib.* ii. 400, 730.

¹⁰ R. F. Johnston, *Lion and Dragon in Northern China*, London, 1910, p. 365.

¹¹ Bk. v. year xix. 4 (Legge, v. 176-177).

¹ Bk. x. year xi. 9 (Legge, v. 631, 632, 633, 635).

² Bk. viii. year ii. (Legge, v. 341, 347).

³ Bk. x. year xiii. (Legge, v. 643, 649).

⁴ Bk. viii. year x. (Legge, v. 373, 374).

⁵ Bk. xi. year iv. (Legge, v. 747, 748).

⁶ See de Groot, ii. 419, 726.

⁷ *SBE* xxvii. [1855] 181 f.

⁸ *Ib.* 183 f.

⁹ Legge, v. 326, 328.

¹⁰ De Groot, ii. 729, quoted from ch. iv. of 'The Contending States.'

¹¹ *JRAS* (N. Ch. Branch), new ser., xii. [1878] 15, note.

¹² De Groot, ii. 728, quoted from 'The Miscellanies of the Western Metropolis,' ch. vi.

¹³ *Ib.* ii. 732.

¹⁴ Parker, in *China Review*, xxv. [1900-01] 259.

wind;¹ or, again, we read of a maiden being sacrificed to a river-god.²

In the Yuan dynasty (A.D. 1280-1367), women were buried with the Mongols who ruled the empire then.³ In the Ming dynasty (A.D. 1368-1644) the custom was extensively practised during the first hundred years, the first, third, fourth, and fifth Emperors being honoured in this way with 38, 16, 4, and 7 victims respectively. It was also the rule in the case of princes. This went on until the Emperor Ying Tsung († A.D. 1464) abolished it for his own funeral, though he sacrificed several women at his brother's death.⁴ The late Manchu dynasty (A.D. 1644-1911) at first also practised this, at all events during the reign of the first Emperor Shun Chi (A.D. 1644-61). There is no evidence to show whether the later sovereigns sanctioned it.⁵

It has been thought that the Chinese practice of placing figures of men in an avenue leading to the tomb, as at the Imperial tombs, had its origin in human sacrifice.⁶ Isolated cases occur in which the Chinese offer to the *manes* of a man killed or murdered the killer or the murderer or a portion of his body.⁷ 'Human sacrifices are said to have taken place in the building of a silk-filature at Soochow.'⁸ It was also and may still be the custom for new furnaces in potteries in the Kiang-si Province to be consecrated with the shedding of a child's blood. This sacrifice is done secretly, and it is supposed to prevent accidents or evil influences. One of the aboriginal tribes in China is said to offer one of their own number every year as a sacrifice to their dog-idol.⁹

Closely akin to the sacrifices of the living to the dead is a species of *sati* sometimes practised in China, when the widow publicly commits suicide to follow her dead husband to the grave.

Even in recent times, prisoners or slaves have been buried under bridges, city-gates, and public buildings. A case occurred in 1900, when one of the leading officials sacrificed a gaol-bird to his drum when starting for the wars.

LITERATURE.—This is cited in the footnotes.

J. DYER BALL.

HUMAN SACRIFICE (Greek).—It has often been observed that the Homeric poems contain hardly any allusions to human sacrifice. A remarkable exception occurs in *Il.* xxiii. 175, where, after sacrificing four horses and two dogs on the funeral pyre of Patroclus, Achilles crowns the ceremony by slaying twelve Trojans, doubtless to serve as the thralls of Patroclus in the world below, just as the horses and dogs were required to minister to other needs. The sacrifice in question is one of a class which is often represented in early civilizations (Tylor, *PC*⁴ i. 458 ff.), and is best illustrated by the account in Herodotus (iv. 71) of the funeral of the Scythian kings, when cooks, grooms, butlers, and others of the royal household were strangled and buried in their master's tomb. The rite was, of course, based upon the belief that the dead continue in the world of spirits the same course of living as they have followed on earth; but, though the belief itself prevailed extensively

¹ *JRAS* (N. Ch. Branch), new ser., xii. 16, note.

² H. A. Giles, *Chinese Biog. Dict.*, London, 1898, no. 655 (cf. 678), quoted in E. Faber, *Hist. of China*, Shanghai, 1902, App. D.

³ See quotation from Ma Twan-lin in de Groot, ii. 437 f.

⁴ See quotations from Chinese works cited by de Groot, ii. 733 f., also *China Review*, x. [1881-82] 71.

⁵ See de Groot, ii. 734 f.; C. L. J. de Guignes, *Voyages*, Paris, 1808, ii. 304.

⁶ See *China Review*, v. [1876-77] 359, note.

⁷ See *ib.* ii. [1874-75] 389. A case was recently mentioned in one of the weekly papers. See also Giles, *Chinese Biog. Dict.*, no. 542, quoted in Faber, *Hist. of China*, App. D.

⁸ *JRAS* (Ch. Branch), new ser., xxxv. [1903-04] 123.

⁹ J. H. Gray, *China*, London, 1878, ii. 306. See also under date A.D. 648, *China Review*, xxvi. [1900-01] 192.

in the Homeric age, the proceeding of Achilles was such as to provoke from the poet the unusual comment, 'evil was the deed that he contrived.' Some critics have laid it down that the Homeric religion was succeeded by a period of joyless and gloomy superstition, in which piacular offerings first became customary. Although there is some measure of truth in this view, it is equally important to observe that, so far as human sacrifices are concerned, the Homeric poems stand upon the same level as the rest of Greek literature, which is representative of an advanced stage of ethical development, and consequently condemns as unworthy of Hellenic enlightenment the offering up of human lives to appease the wrath of an offended deity. The sacrifice of human victims on stated occasions is regarded as a barbarian practice (Soph. fr. 122), evidenced by the cruel exposure of Andromeda and Hesione, who were rescued by Greek heroes, and the savage rites of the Tauric priesthood (Eur. *Iph. Taur.* 465). The Phœnician Molech, who was honoured by the sacrifice of children (Plut. *de Ser. num. vind.* 6, p. 552 A), was regularly identified with Cronos, whose primitive tyranny was overthrown by the milder dominion of Zeus (M. Mayer, in Roscher, ii. 1501 ff.). Æschylus (*Ag.* 156) calls the sacrifice of Iphigenia lawless; Pausanias (vii. 19. 8) records that the Delphic oracle referred to the recurring sacrifice of a youth and a maiden at the precinct of Artemis Triclaria in Achaia as strange or foreign; and Pelopidas (Plut. *Pelop.* 21), when ordered to sacrifice a maiden as a condition of success in battle, shrank from so horrible and barbarous an expedient.

Yet, although literary sentiment professes to repudiate human sacrifice as incompatible with the spread of Greek civilization, the prevalence of the custom in the pre-historic age is attested by the persistence of its appearance in the heroic legends which poetic tradition has preserved. These legends provide material which enables us to survey the conditions applicable to human sacrifices. It is generally admitted that many of them were piacular in character; that is to say, they arose from a conviction that the anger of a divine power had been incurred by some act of impiety, that the well-being of the community was imperilled in consequence, and that the life of one of its members must be surrendered in expiation of the guilt. Recent investigations support the conclusion that no single formula is adequate to cover the varying circumstances in which recourse was had to human sacrifice. Thus, the rites connected with the periodical expulsion of evil, where the victim assumes the character of a scapegoat, have not yet been traced to a single source; and it must be recognized that in many cases it is impossible to discover precisely how the worshippers believed that their offering would be gratifying. Yet the desire to appease an enraged deity or to prevent his jealousy by timely precautions, when there may be a risk of infringing his prerogatives, is frequently indicated as an impelling motive.

It might happen that the wrath of heaven was declared by some special manifestation of displeasure, such as the occurrence of a drought or a pestilence, or the interposition of some unusual obstacle to the successful issue of an undertaking. Thus the sacrifice of Iphigenia was demanded because the detention of the Greek fleet at Aulis by contrary winds was a sign of divine anger (Æsch. *Ag.* 198 ff.). Similarly, the sacrifice of Polyxena on the tomb of Achilles was urged by Neoptolemus as a means of obtaining favourable winds for the return from Troy (Eur. *Hec.* 536 ff.).¹ Both of these incidents belonged to the tradition of the

¹ The developed story shows a conflation of two motives—the duty of offering a preliminary sacrifice to a sea-god (see art

Epic Cycle, the sacrifice of Iphigenia being related in the *Cypria*, and that of Polyxena in the *Iliu-persis*; but authority is scarcely needed to convince us that these and similar legends are handed down from time immemorial, and testify to the primitive beliefs of the race. An echo of the legend of Aulis, possibly combined with an attempt to ascribe an Oriental character to the practice, is preserved in the story recorded by Herodotus (ii. 119), that Menelaus, when detained in Egypt by adverse weather-conditions, sacrificed two Egyptian boys as expiatory victims. Yet another illustration may be found in the story of Sinon (Verg. *Æn.* ii. 116 ff.), and an example taken from historical times shows how deeply-rooted was the superstition which required extraordinary sacrifices before a departure on an important voyage. Agesilaus, about to embark at Aulis on his expedition against Persia, dreamed that a human sacrifice was required from him; but, since such an act would have been abhorrent to the spirit of the times, he was content to offer up a hind in memory of Agamemnon's sacrifice (Plut. *Ages.* 6). When the subjects of Athamas were afflicted with a drought, the king received information that an oracle required him to sacrifice his children Phrixus and Helle; and he was about to comply with this command when the children were miraculously rescued by their immortal mother Nephele, and dispatched on their famous journey over the sea on the back of the ram with the golden fleece (Apollod. i. ix. 1). When attacked by famine and pestilence, the Athenians, in obedience to the command of an old oracle, slew the daughters of Hyacinthus on the tomb of Geræstus the Cyclops (*ib.* iii. xv. 8).

Usually, however, the danger which calls for so exceptional a remedy is an approaching conflict with a foreign foe. In the *Heraclidæ* of Euripides (404 ff.), Demophon, preparing to resist an Argive invasion, after he had refused to surrender the children of Heracles, was warned by the soothsayers that it was essential for him to sacrifice to Persephone a maiden of noble birth. Similarly, when Thebes was beleaguered by the army of Adrastus and Polynices, Tiresias demanded of Creon that he should sacrifice his son Menœceus in order to placate the hostility of Ares, which Cadmus had incurred by slaying the dragon (Eur. *Phæn.* 911 ff.). Other instances are taken from the legendary history of Athens. Erechtheus, when at war with Eleusis, was promised success, if he would sacrifice one of his daughters (Apollod. iii. xv. 4). A similar story was related concerning the three daughters of Leos (*Ælian, Var. Hist.* xii. 28), and the devotion of King Codrus saved Athens when he learnt that his death was a necessary condition of the defeat of the Lacedæmonian invaders (Lycurg. 84 ff.).

The general impression which we receive from Greek literature is that in historical times human sacrifice was obsolete, and it comes as a surprise to read in Plutarch that Themistocles, before the battle of Salamis, was driven by the pressure of public opinion to consent to the sacrifice of three Persian captives in honour of Dionysus Omestes (Plut. *Themist.* 13). Grote, it is true, dismisses the story as a fiction (iv. 479₂), and it is obviously of such a kind as a later age might have invented by way of scandalous embellishment for a famous chapter in the annals of the past. But, whether it is credible or not, we are at least entitled to draw from it the inference that there were not wanting in the classical age those who still cherished a belief in the efficacy of human sacrifice, and were prepared to advocate a resort to it in seasons of

ACHILLES) before embarkation, and that of providing a deceased hero with the appropriate mortuary gifts.

supreme danger. The conclusion is in agreement with the other available evidence. Before the battle of Leuctra, Pelopidas dreamed that he was warned by a spirit in a vision to sacrifice a fair-haired maiden, if he wished for victory in the approaching battle (Plut. *Pelop.* 21). A serious contention ensued between the friends of enlightenment and those who would have him obey the warning. But a fortunate accident released the general from his dilemma; for a quick-witted seer, catching sight of a chestnut filly, which had separated from the herd and charged into the ranks of the army, cried out that here was the very victim which the infernal powers required. Equally characteristic is the account given by Pausanias (iv. 9. 3-10) of a similar incident in the First Messenian War, which makes it clear that even at that early date Greek sentiment, while fearing to disobey the express injunction of an oracle, was only too ready to take advantage of any pretext for declaring that the sacred command had been fulfilled.

But there is incontrovertible evidence that, under stress of calamity, religious fears were too strong to be held entirely in check by the growing hatred of superstitious barbarities. Thus we read that, in the course of his famous purification of Athens, Epimenides the Cretan caused one or two youths to be sacrificed (Athen. 602 C; Diog. Laert. i. 110). Moreover, several authorities state (*e.g.* schol. Aristoph. *Eq.* 1136) that certain outcasts were maintained by the Athenians at the public expense, in order that, if a plague or a famine attacked the city, some of them might be sacrificed as scapegoats (*καθάρματα, φαρμακοί*), and so the taint of pollution might be removed. Nor was the practice confined to occasions of extraordinary calamity, for there are other examples, which establish that in certain cults human victims were sacrificed annually or at regular intervals. It has been inferred with reason from a statement of Pausanias (viii. 38. 7) that a rite of this kind was celebrated in honour of Zeus Lycæus on the summit of Mt. Lycæus in Arcadia as late as the 2nd cent. A.D. (cf. Porphyry. *de Abstin.* ii. 27; [Plat.] *Minos*, 315 C). At Halos in Thessaly, Xerxes was informed that the eldest son of the royal stock, which traced its origin to Athamas, was under a tabu to keep away from the town-hall, or, if he was caught attempting to enter it, he must be sacrificed at the altar, and that many had perished in this way (Herod. vii. 197). Every year in Rhodes, at the festival of Cronos, a condemned criminal, who had been kept back for this purpose, was led outside the gates of the city, and put to death; and something of the same kind took place at Salamis in Cyprus, in honour of Aglauros, the daughter of Cecrops (Porphyry. *de Abstin.* ii. 54). At the temple of Apollo in Leucas, a criminal was thrown over the cliff into the sea every year as a scapegoat; but the severity of his fall was mitigated by attaching live birds or feathers to his body, and men waited in small boats for his descent so as to rescue him and convey him away from the island (Strabo, 453). The festival of the *Thargelia*, which was celebrated at Athens in the middle of the summer, was the occasion of the performance of a similar rite. Although the evidence is not altogether free from doubt, it seems that two victims, one representing the male citizens and the other the female, were led out of the city as scapegoats and stoned to death (Harpocr. *s.v. φαρμακός*). The sacrifice of a scapegoat at the same festival is also attributed to the Ionians of Asia Minor (Hipponax, fr. 37).

The question of origins is too intricate and obscure to be discussed here, and cannot profitably be examined, much less solved, by the light of

the Greek evidence alone. Moreover, the Greek examples, whether ritual or mythical, have been contaminated and disturbed by successive accretions of advancing thought, and do not usually supply typical illustrations of primitive belief. While the extraordinary sacrifices show clear traces of the piacular motive, those which occurred at regular intervals are less clearly outlined, and can perhaps be satisfactorily explained only by being brought into comparison with the religious observances of the most backward races. Thus, it has been contended that the ceremony on Mt. Lycæus was originally the cannibal feast of a wolf-tribe, and that, whenever the human victim is a captive or a foreigner, the origin of the ritual may be looked for in the feast of a totem group (W. R. Smith, in *EBr*⁹ xxi. 138).

It will have been observed that there is very scanty evidence for the continued existence of human sacrifice as an ordinary practice of the most civilized communities of ancient Greece. If we put aside the conservatism of remote and rural districts, and the influences likely to have been exerted by Oriental cults, the survival of these cruel rites was hardly tolerated by public opinion; and, where it was not entirely suppressed, it was mitigated by the selection of victims from the lowest class of criminals. Thus, humanitarian scruples were soothed with the reflexion that divine justice required the extinction of those who were no longer worthy to live. But, wherever it was found practicable, the rigour of primitive superstition was softened by the substitution of a symbolical blood-shedding or of a non-human victim. It may be that in some cases, as has recently been maintained (Farnell, *CGS* i. 93), human sacrifice was not the primitive fact, but a development from the sacrifice of the theanthropic animal, when the significance of the latter was misunderstood. Nevertheless, it is certain that the Greeks themselves believed in the substitution of an animal surrogate, and the evidence relating to the fact of such substitution is too strong to be neglected entirely.

The flagellation of Spartan boys at the altar of Artemis Orthia is declared by Pausanias (iii. 16. 10; see, however, Frazer, *in loc.*) to have been instituted by Lycurgus in place of the older custom of killing a man who was selected by lot. A curious passage in Euripides (*Iph. Taur.* 1458 ff.) proves that in the temple of Artemis Tauropolos at Halæ on the S.E. coast of Attica it was customary at the annual ceremony of the *Tauropolia* to lead a man in the guise of a victim to the altar, and to scratch his neck with a sword sufficiently to let the blood flow. The substitution of an animal for a human victim is familiar to every one from the legend of Iphigenia, and many analogous cases might be quoted (Plut. *Parallela* 35, p. 314 C; Pausan. ix. 8. 1, etc.). When the sacrifice of an Athenian maiden was required to stay a famine, a certain Embaros promised to give his daughter, but dressed up a goat in her place and sacrificed it at the altar (*Paræm.* i. 402). Ælian (*Nat. An.* xii. 34) records an extraordinary ceremony which took place at Tenedos in honour of Dionysus the Man-slayer. A cow which had recently calved was tended like a woman in child-bed, and her calf was shod in buskins (κρόσσοι) and then struck down before the altar. But the man who had used the axe was publicly stoned and forced to make his escape to the sea, where presumably he was ceremonially cleansed. Some of the details recall the well-known rite of the *Bouphonia* (Frazer, *GB*², pt. v. vol. ii. p. 4 ff.); but that the calf was the substitute for a human victim seems to be established by the statement of Porphyry (*de Abst.* ii. 55).

VOL. VI.—54

LITERATURE.—P. Stengel, in *Neue Jahrb. f. Philol.* cxvii. (1883) 361-379, and the same writer's *Die griech. Kultusaltertümer*², Munich, 1898, p. 114 ff.; O. Gruppe, *Griech. Mythol. u. Religionsgesch.*, do. 1906, p. 922 ff.; L. R. Farnell, *CGS* i. (Oxford, 1896) 88 ff.; J. E. Harrison, *Prolegomena*, Cambridge, 1903, pp. 96-114; A. Lang, *Myth, Ritual, and Religion*, London, 1899, i. 255-264; J. G. Frazer, *GB*², do. 1900, iii. 122 ff., *GB*³, pt. iii. (do. 1911), p. 161 f.; E. B. Tylor, *PC*⁴, do. 1903, i. 458 ff., ii. 389-406; E. Westermarck, *MI*, i. [do. 1906] 424-476.

A. C. PEARSON.

HUMAN SACRIFICE (Indian).—In this article the expression 'human sacrifice' is used to include not only propitiatory offerings to a god, but also all cases of the immolation of human beings, whether voluntary or otherwise, in furtherance of religious or superstitious objects.

I. References to the subject in Hindu religious books.—The *Aitareya Brāhmaṇa* to the *Rigveda* describes (vii. 13-18) how a certain king vowed that he would sacrifice his first-born to the water-god Varuna, if that deity would bless him with a son. One was born in due course, but the king hesitated to fulfil his vow—until the boy had grown up, when he ran away from home to escape the fate in store for him. The king was afflicted with dropsy as a punishment for not sacrificing him. At last a Brāhman was persuaded to sell his son as a substitute. This youth was tied to a stake, and was on the point of being immolated to appease Varuna when he recited certain sacred verses, whereupon some other deities intervened, and he was released.

It has been argued that, as the victim escaped, this story does not prove that the custom of offering human sacrifices actually existed, and that the rite was merely symbolical. But the whole story loses its point unless a real sacrifice had been intended. It is, moreover, in accordance with a custom which was put a stop to by the British Government only a century ago in Bengal, where Hindu women were in the habit of consigning their first-born babes to the Ganges in fulfilment of similar vows.

The above story is an instance of the sacrifice of children in the fulfilment of vows. Another form of human sacrifice was the *puruṣamedha*, which was celebrated for the attainment of supremacy over all created beings, and at which eleven human beings and eleven barren cows were offered up. The ceremony is described in the *White Yajur Veda*, of which the *Vājasaneyā Samhitā* opens with verses intended to serve as *mantras* (charms or incantations) for offering of human sacrifices. Various gods are enumerated, with the kind of victim suitable for each, such as a priest for Brahmā, a musician for the divinity of music, and a fisherman for the gods of rivers (i.-xii.). Further details are contained in the *Taittirīya* (iii. 4) and *Satapatha Brāhmaṇas* (xiii. 6),¹ as well as in the *Sāṅkhāyana* (xvi. 10-16) and *Vaitāna Śrauta Sūtras* (xxxvii. f.).

In the *Satapatha Brāhmaṇa* it is stated that the victims are to be let loose after being consecrated; but this work is of a much later date. The earlier records clearly contemplate the actual slaughter of the victims; and the account of the rite given in the *Satapatha Brāhmaṇa* itself can be explained only on the hypothesis that it was a modification of a prior rite in which human beings were immolated.

The *asvamedha*, or horse-sacrifice for the attainment of wealth, also required the immolation of a human being (*Satapatha Brāhmaṇa*, XIII. iii. 6, § 5, etc.; see Eggeling, *SBE* xlv. p. xxxix f.); and human sacrifice, though reprobated, is mentioned in the *Mahābhārata* (e.g., ii. 626 ff., 861 ff.).

The *Purānas* and *Tantras*, which were compiled in very early mediæval times, contain frequent references to another rite requiring the immolation of a human victim. This was the *narabali*, or human sacrifice to the goddess Chandikā, a dark, fierce, sanguinary divinity, who is represented in the most awful forms, garlanded with a string of

¹ These passages are quoted at length by R. Mitra in his paper 'On Human Sacrifices in Ancient India,' *JASBe* vol. xlv. [1876] pt. I p. 76.

human skulls, besmeared with human blood, and holding a skull in one hand and an uplifted sabre in the other. In the *Kālikā Purāna*¹ it is said that 'by a human sacrifice attended by the rites laid down, Devī (the goddess, i.e. Chāṇḍikā) remains gratified for a thousand years; and by the sacrifice of three men, one hundred thousand years. By human flesh the goddess Kāmākhyā's consort Bhairava, who assumes my shape, remains pleased three thousand years. Blood consecrated immediately becomes ambrosia, and, since the head and flesh are gratifying, therefore should the head and flesh be offered at the worship of the goddess. The wise should add the flesh free from hair, among food offerings.' Minute details are added regarding the ways in which, the times when, and the places where, the rite should be celebrated.

'Having placed the victim before the goddess, the worshipper should adore her by offering flowers, sandal paste, and bark, frequently repeating the *mantra* appropriate for sacrifice. Then, facing the north and placing the victim to face east, he should look backward and repeat this *mantra*: "O man, through my good fortune thou hast appeared as a victim; therefore I salute thee; thou multiform and of the form of a victim. Thou, by gratifying Chāṇḍikā, destroyest all evil incidents to the giver. Thou, a victim, who appearest as a sacrifice meet for the Vaiṣṇavi, hast my salutations. Victims were created by the self-born himself for sacrificial rites; I shall slaughter thee to-day, and slaughter as a sacrifice is no murder." Thus meditating on that human-formed victim, a flower should be thrown on the top of its head with the *mantra*: "Om, Aih, Hrih, Srih." Then, thinking of one's own wishes, and referring to the goddess, water should be sprinkled on the victim. Thereafter the sword should be consecrated with the *mantra*: "O sword, thou art the tongue of Chāṇḍikā and bestower of the region of the gods. Black and holding the trident, thou art like the last dreadful night of creation; born fierce, of bloody eyes and mouth, wearing a blood-red garland . . . salutations be to thee." The sword, having thus been consecrated, should be taken up while repeating the *mantra*: "Arh huṃ phat," and the excellent victim slaughtered with it. Thereafter, carefully sprinkling on the blood of the victim, water, rock-salt, honey, aromatics, and flowers, it should be placed before the goddess, and the skull also, with a lamp burning over it, should be placed before her with the *mantra*: "Om, Aih, Hrih, Srih, Kauṣiki, thou art gratified with the blood." Thus, having completed the sacrifice, the worshipper attains rich reward.'

In the fifth act of the *Mālatīmādhava*, by the dramatist Bhavabhūti (fl. c. A.D. 690), is a vivid description of the attempt of an Aghorī (q.v.) to sacrifice the heroine to Chāṇḍikā, a form of Kālī.

2. Former prevalence of sacrifices to Kālī.— These *tāntrik* sacrifices to Kālī or Chāṇḍikā were formerly common. They were freely offered in the days of Marāṭhā rule; and in Western India there are many temples at which such sacrifices were common only a century ago. The victim was taken to the temple in the evening and shut up; and in the morning he was found dead, the dread goddess having 'shown her power by coming in the night and sucking his blood.'

The great Saiva temple at Tanjore contains a shrine of Kālī where a human victim (a male child purchased for the purpose) was sacrificed every Friday evening, until the advent of British rule led to the substitution of a sheep. There are other temples in Southern India where similar sacrifices were formerly common. At the famous shrine of Dāntesvari in Bastar it is said that in A.D. 1830 upwards of twenty-five men were immolated by the Rājā on a single occasion. Sleeman, writing in 1844, says that a certain chief in the Central Provinces once a year sacrificed a Brāhman to the goddess.² The Brāhmins of the Deccan used to sacrifice an old woman on the occasion of the Rājā of Sātāra's annual visit to the fort of Partābgarh. According to Sir John Malcolm, the Karādi Brāhmins annually sacrificed a young Brāhman at Poona. This class of Brāhmins long remained under the suspicion of being addicted to human sacrifices, using poison to effect their ends when an open sacrifice would have been too dangerous. In N. Chevers' Report on Medical Jurisprudence, written in 1854, it is said that

'there are strong reasons for believing that there is scarcely a district in India in which human sacrifice is not still practised occasionally as a religious rite.'

W. Ward, writing in the early part of the 19th

- A translation of the whole chapter on the subject was published by Blaquièrre in *Asiatic Researches*, v. [1797] 371 ff.

² *Rambles and Recollections*, London, 1844, i. 61.

cent., mentions various places in Bengal at which human sacrifices were offered:

'The discovery of these murders in the name of religion is made by finding the bodies with the heads cut off near their images [of Kālī]; and, though no one acknowledges the act, yet the natives well know that these persons have been offered in sacrifice.'¹

In the north-east of India, human sacrifices to Kālī were very common. The Koch king, Nar Nārāyan, who ruled in the 16th cent., is said to have immolated 150 men on a single occasion; and some of his descendants carried on the practice until the early part of last century. It appears from the *Haft Iqlim* that in Koch Bihār persons, called *bhogīs*, sometimes offered themselves as victims. From the time when they announced that the goddess had called them, they were treated as privileged persons. They were allowed to do whatever they liked, and every woman was at their command until the annual festival came round, when they were sacrificed to the goddess.² More frequently, however, the victim was either a person kidnapped from a distance, or a traveller, or some person found abroad after midnight.

In the Jaintiā *parganas*, human sacrifices to Kālī were offered annually. As in Koch Bihār, persons frequently volunteered themselves as victims. If the would-be victim, or *bhoge khāora*, were deemed suitable, the Rājā would present him with a golden anklet and allow him to live as he chose, compensation for any damage done by him being paid from the royal treasury. But his enjoyment of these privileges was very short. On the *Navami* day of the *Durgā Pujā*, the victim, after bathing and purifying himself, was dressed in new attire, daubed with red sandalwood and vermilion, and bedecked with garlands. Thus arrayed, he sat on a raised dais in front of the goddess, and spent some time in meditation and the repetition of *mantras*. He then made a sign with his finger, whereupon the executioner, after uttering the prescribed sacrificial *mantras*, cut off his head, which was placed before the goddess on a golden plate. The lungs were cooked and eaten by such *Kāndrā Yogīs* as were present, and the royal family partook of a small quantity of rice cooked in the blood. When voluntary victims were not forthcoming, persons were kidnapped from outside the State. In 1832 four persons were thus taken from British territory, one of whom escaped and gave information. As the Rājā refused to deliver up the culprits, and as this was not the first offence, his dominions were annexed.

In the *Tikha Kalpa*, a MS work found in the Manipur State library, it is said:

'Human sacrifices are to be made, after the royal consent has been obtained, on the occasion of public calamities such as war, or for the purpose of obtaining great wealth. . . . A Brāhman or a woman should never be sacrificed. Neither should one sacrifice his own body, as then he will be guilty of the sin of suicide. A brother, a father, a son, a wife's brother, a sister's son, a maternal uncle, none of these should be sacrificed; nor any one who is acquainted with the Vedas, or has renounced the world, or is a student, or belongs to the royal family. An enemy, a sick person, an eunuch, one who is infirm or has defects or scars should not be offered. The victim should be bathed, and properly decorated, and then brought before the goddess. The person offering the sacrifice should turn his face towards the north, and the victim should face the east. Water should be sprinkled on the victim, and the following *mantra* uttered: "O goddess, living on the golden mountain, I offer this sacrifice to thee! He is good and stout and without blemish. I bid him to a post! I offer this sacrifice to remove my misfortune. O goddess, accept him! Although I kill him, I give him salvation!"'

This is clearly another version of the rite prescribed in the *Kālikā Purāna*.

In modern times the sacrifice of human beings has been replaced by that of animals—chiefly

¹ *History, Literature, and Religion of the Hindoos*², London, 1815, ii. 261.

² Similar liberties were allowed to prospective victims in ancient Babylon and in Mexico (*GB*³, pt. iii. [London, 1911] p. 113 f., pt. v. [1912] vol. i. p. 238, vol. ii. p. 92 f.).

buffaloes and goats—but some families, whose ancestors offered human victims at the *Durgā* and *Kālī Pujās*, now sacrifice, in lieu of a living man, an effigy, about a foot long, made of dried milk (*khīra*).

3. Sacrifices by aboriginal tribes in north-east of India.—The gods whose favour it was desired to obtain in the rites ordained in the *Vedas* were genuine Aryan deities, and their worship, with the attendant sacrifices, was probably brought by the Aryans from their earlier settlements beyond the confines of India. The terrible goddess whose cult is described in the *Purāṇas* and *Tantras* is, however, a comparatively recent addition to the Hindu pantheon. It is believed that her worship and the bloody orgies with which it was attended were adopted from the religion of non-Aryan tribes, with whom the Hindus came into contact on the north-east frontier of India. It is, therefore, not surprising to find the immolation of human beings common in that locality, not only among Hinduized tribes like the Manipuris, Kochs, and Jaintiās, whose practices have already been described, but also amongst those that had only partially, if at all, come under its influence. The Kachāri kings offered annual sacrifices to their sacred sword, taking as victims Hindus of any caste but the Brāhman, who were kidnapped for the purpose from other parts. Brāhmins officiated at the ceremony, and the heads of the victims were thrown down a masonry well. In the *Rājmalā*, or chronicles of the kings of Tippera, it is related that a king who ruled in the first half of the 16th cent. offered up some slaves as a sacrifice to the 'fourteen gods,'¹ but the offering was not accepted, and the *chontai*, or high priest, announced that Mahādeb, or Siva, had ordered the immolation of the best commanders of the army. The king accordingly sacrificed eight of his chief captains. His successor, it is said, on two occasions defeated the Muhammadans, and sacrificed the prisoners to the 'fourteen gods.' Mention is also made of a king sacrificing three human victims to Siva, when praying for a son, and of another, when defeated by the Muhammadans, offering a Chandāl boy to Bhabāchāri. Among the wild tribes of Hill Tippera and the Chittagong Hill Tracts, such sacrifices probably still occur, though it is naturally very difficult to obtain definite information regarding them.

The Chutiya were still more addicted to human sacrifices, the object of their worship being Kesāi Khāti, the eater of raw (human) flesh, whom they now identify with Kālī. The officiating priests, or *deoris*, were members of the tribe and not Brāhmins. The sacrifices were offered on regular occasions, and also to avert special calamities, such as cholera, smallpox, and drought. After the subjugation of the Chutiya by the Ahoms, some four centuries ago, they were permitted to continue their ghastly rites. They were usually given for the purpose criminals who had been sentenced to capital punishment; but, when none such were available, a particular clan was expected to produce a victim, and in return certain privileges were granted to it. When a woman of this clan became pregnant, the astrologers were called on to ascertain the sex of the child. If they predicted that it would be a boy, the mother was carefully tended, and the child was anointed, as soon as it was born, with a paste made of turmeric and a kind of pulse. When necessity arose, a volunteer was called for, and (it is said) was usually forthcoming; if not, a victim was taken by force. For some time he was kept at the temple and fed sumptuously, until in sufficiently plump condition to suit the supposed

¹ Most of these gods are now identified with regular Hindu deities.

taste of the goddess. He was then shaved, anointed with the same paste as at birth and adorned with gold and silver ornaments, and was conducted before the image of the goddess. Here he prostrated himself and was promptly decapitated by the *bar deori*, or high priest. The head was added to a heap of skulls that were piled in view of the shrine. Victims were taken only from amongst the juvenile members of the clan. As in other cases, persons who were deformed, or bore any scar or blemish, were regarded as unfit to be victims.

The offering of human sacrifices to Kesāi Khāti was common also in Nowgong, where the victim was usually some stranger who had come for purposes of trade. He was kept in close custody for about a fortnight, and was then led out, decked with flowers and jewels, and decapitated. As soon as this had been done, the spectators fled headlong down the hill on which the shrine stood, to avoid being devoured by the hungry gods and goddesses. The sacrifice seems here to have been offered, not in order to obtain some imaginary benefit for the worshippers, but rather with a view to providing food for the sanguinary goddess and so escaping her unwelcome attentions themselves.

The same idea of gods requiring human blood is found among the Khāsis, who believe in the existence of snake-gods called *thlen*. When a *thlen* takes up its abode in a family, there is no means of getting rid of it. So long as it is supplied at intervals with its favourite food, the family prospers and grows rich; but, when it feels the want of blood, sickness breaks out and misfortunes become frequent. Some human being is then murdered, and the hair, the tips of the fingers, and a little blood from the nostrils are taken and offered to the *thlen*. The belief is that the demon appears in the form of a snake and devours the body of the victim, which is materialized from the portions thus offered. Murders due to the prevalence of this superstition still occasionally come to light.

This idea of a family-spirit that needs human blood and afflicts the family with misfortune if its craving is not satisfied exists also in other parts of India, and is believed to have been the cause of a murder committed in the year 1908 in Chotā Nāgpur. The victim, a boy of 12, was found lying with his throat cut, and some grains of uncooked rice were seen in the wound, showing that he, like animals destined for sacrifice, had been made to swallow rice immediately before he was killed. The murder had apparently been committed at a shrine of Kālī, where the body was found. If so, the case may mark a transition stage between the entirely non-Aryan practice of the Khāsis and the rites laid down in the *Kālikā Purāṇa*.

4. Sacrifices by Dravidian tribes.—Human sacrifices were once very common among the Dravidian tribes of the Chotā Nāgpur plateau. With the Khonds they were so frequent and notorious in the early days of British rule that officers were deputed by Government to investigate the facts with a view to preventive action, and we have in their reports a full account of the practice as it obtained among the members of this tribe. Human beings were offered up by them to Tari Pennu, the earth-goddess, to avert misfortune and disease, to obtain success in war, and especially to ensure good crops. The victim, or *meriah*, was acceptable to the goddess only if he had been purchased (usually from the Pāns, a weaving and criminal tribe, who procured children for the purpose from the plains), or was the son of a victim, or had been dedicated as a child by his father. Khonds in distress sometimes sold their children for victims, 'considering the beatification of their souls certain, and their death, for the beatification of mankind, the most honourable possible.' The victims were often kept for years before they were sacrificed. They were regarded as consecrated beings, and were treated with extreme affection and deference. They were commonly sacrificed about the time when the chief crop was sown. On

the day before the ceremony, the victim was dressed in a new garment and led with music and dancing to the sacred grove, where he was tied to a post, anointed with oil, *ghī* (clarified butter), and turmeric, and adorned with flowers. 'A species of reverence which it is not easy to distinguish from adoration' was paid to him throughout the day. The crowd danced round the post to music, and, addressing the earth, said: 'O goddess, we offer this sacrifice to you; give us good crops, seasons, and health.' The orgies were kept up till noon next day, when the victim was again anointed and taken in procession round the village. On this occasion, as on the previous day, there was a great struggle to get some relic from his person, such as a lock of his hair, a particle of the turmeric paste, or a drop of his spittle. He was then usually strangled in the cleft of a green branch, or tied to the trunk of a wooden elephant which was made to revolve. The officiating priest (a Khond) first wounded the victim slightly with an axe, and the crowd then rushed at him and cut the flesh from the bones, leaving the head and bowels untouched. The flesh was carried off to the different villages, where part was offered to the earth-goddess, buried, and a libation of water poured over it, and the rest was divided among the householders. Each man buried his piece in his favourite field. The remains (head, bowels, and bones) were burned next day, with a sheep, on a funeral pyre. The ashes were scattered over the fields, laid as paste on the houses and granaries, or mixed with the new corn to preserve it from insects.

Our authorities represent the *merahs* as victims offered to propitiate the earth-goddess; but Frazer points out that the flesh and ashes of the victim were evidently thought to possess 'a direct or intrinsic power of making the crops to grow, quite independent of the indirect efficacy which it [the sacrifice] might have as an offering to secure the good-will of the deity.'¹

Practices very similar to those of the Khonds have been noticed by Davis and Needham among various Mongoloid tribes in the Nāgā Hills and on the Pātloi. Sometimes the flesh is buried in the fields to ensure good crops, and sometimes the victim is tied up and burnt to death in the jungle which is to be cleared for the next year's crops. The same tribes also regard a human sacrifice as very efficacious in warding off disease or ensuring victory in battle. The victim may be a slave, a prisoner of war, or some one purchased for the purpose. Both sexes are equally suitable. In the North of the Upper Chindwin district in Burma it was formerly the custom to sacrifice boys and girls at a big festival in August in order to get good rice crops. The victims, who were usually small children, were purchased from the unadministered territory. A rope having been placed round his neck, the victim was taken to the houses of all the relatives of the purchaser. At each house a finger joint was cut off, and all persons in the house were smeared with the blood. They also licked the joint and rubbed it on the cooking tripod. The victim was then tied to a post in the middle of the village and killed by repeated stabs of a spear, the blood from each stab being caught in a hollow bamboo, to be used afterwards for smearing on the bodies of the purchaser's relatives. The entrails were then taken out and the flesh removed from the bones, and the whole was put in a basket and set on a platform near by as an offering to the god. After the blood had been smeared on the purchaser and his relatives, who danced and wept meanwhile, the basket and its contents were thrown into the jungle.²

Among other Dravidian tribes who immolated human beings may be mentioned the Bhumij, who kidnapped children and sacrificed them at the shrine of their goddess Rankini. The Bhuiyās had a goddess named Thākūrāni Māi, to whom similar sacrifices were offered; in 1868 an obnoxious official was slain by them, and his head offered to this deity. During the rising of the Mundās in 1900 a constable was killed, and it is said that his head was cut off, and his brains offered as a sacrifice to the local demons. The Bhogtās of Bhāuñrpahār formerly offered up a human being, at stated intervals, to the bees which infest the rocks there,

¹ *GB*³, pt. v. vol. 1. p. 250.

² G. E. R. Grant Brown, 'Human Sacrifices near the Upper Chindwin,' in *Journal of the Burma Research Society*, vol. 1.

and to which supernatural powers are attributed. To this day the local aborigines will not pass the palace of a certain Rājā at night, owing to the survival of the belief that travellers are liable to be caught for sacrifice. The Banjāras, or pack bullock drivers, were once much addicted to human sacrifices. Before starting on a journey they used to bury a child in the ground up to the shoulders, and then drive their bullocks over it. Sometimes, in order to cure an illness or obtain some desired end, they decapitated a victim with one stroke of a sword and sprinkled its blood over an idol.

5. Head-hunting.—Like the Dayaks of Borneo, the Gāros and many tribes of Nāgas were formerly head-hunters; and they often made raids on each other solely in order to obtain heads, which were brought home in triumph to the village and hung up on a tree there. Among the Angāmi Nāgas a man was not allowed to put on the full insignia of a warrior until he had taken a life. It was not necessary for the victim to be a man killed in battle; a child or an old woman speared from an ambush served the purpose equally well. The practice has been put down in British territory, but it is still in vogue among the independent tribes on the frontier. Its origin is perhaps due to the belief that persons whose heads are taken become slaves of the captor in his future life.

The Ahoms often piled up in a heap the heads of enemies killed in or after a battle, or buried them under the steps of their king's palace. But in their case no religious motive appears to have been involved; it was merely a barbarous method of exulting over their defeated enemies.

6. Sacrifices to earth- and river-demons, etc.—There is a superstition current throughout India that buried treasure becomes the property of demons, and that it is most hazardous to search for or remove it unless the demons have first been mollified with blood. In Southern India human sacrifices are deemed most suitable for this purpose, and the demons are believed to have a special partiality for the blood of a pregnant woman; but nowadays they have to be satisfied with that of a buffalo, a goat, or even a fowl. Rivers also are often thought to be inhabited by demons. It is commonly believed that a bridge over a big or fast-flowing river will not stand until the river-spirit has been appeased by the offering of human blood. Captain Clive, writing in 1828, says that the Rāna of Mewār, before crossing the Mahī river, invariably caused an individual from a particular tribe to be sacrificed, his throat being cut and his body thrown into the river. There is a wide-spread superstition that large buildings require the burial of human beings in the foundations to make them safe. When important public works are in progress, rumours are still frequently spread and widely believed that lives are needed for this purpose, and that persons found wandering abroad at night are in danger of being taken as victims. A few years ago a girl was killed under the orders of a local landholder, and buried under an embankment which had given way several times, in order to render it immune from further injury by gods or demons. About the year 1780, when the gates of the city of Tavoy in Burma were erected, a criminal was put into each post-hole, and the post was thrust down upon him, so that his blood gushed up at the sides. He was supposed to become a spirit that would hover about the place, inflicting evil on all who came near, thereby contributing to the defence of the town.

There is a very general belief in the efficacy of human blood to produce any desired result. In Sibsāgar in 1854 a man decapitated the young son of a neighbour and drank his blood, in order to effect the recovery of his own child, who was ill

with fever. A similar act was committed in Muzaffarnagar in 1870 by a childless woman, who hoped thereby to obtain a son. In the same year, at the instigation of a Hindu conjuror, a Musalmān butcher, who had lost his child, killed a neighbour's child, and washed his wife in its blood, in order that her future children might be healthy. Three similar cases occurred in 1909, one in the United Provinces and two in the Nāsik district of Bombay.

7. Killing the king.—In *The Golden Bough* it is shown that primitive races in different parts of the world have a practice of killing their king. Among these races the king was believed by his subjects to be endowed with supernatural powers, and their welfare was dependent on his preserving these powers unimpaired. It was therefore the custom to kill him, or make him commit suicide, so that his soul might be transferred to a vigorous successor before he grew feeble from old age. A custom of this kind once existed in Calicut, where the *zamorin*, or king, was formerly obliged to cut his throat in public at the end of a twelve years' reign. But by the 17th cent. the rule had been modified. At the end of the twelve years a great feast was given, at which any guest who was so minded was at liberty to endeavour to kill the king. If he succeeded, the crown would be his reward; but, as the king was surrounded by his guards, the chances of success were very small.¹ The old Ahom custom which required the king at his coronation to slay a man was possibly a survival of the same class of ideas, the victim being taken as a substitute for the previous monarch.

8. Religious suicide.—The idea of religious suicide, i.e. of sacrificing oneself, is by no means unknown to the Hindus. We have already seen how, in the north-east of India, people sometimes offered themselves as victims at the shrine of Kālī. There is an island in the Narbada river in the Central Provinces where annually, until 1824, devotees were induced to throw themselves from a height on to some rocks which were thought to be the abode of Kāl Bhairava, the consort of Kālī Devī, who fed on human flesh.² Expressions occur in various religious books which countenance the practice of suicide, and rules are laid down for the rite. It was still quite common in the early part of last century. It was resorted to mainly by persons who suffered from great poverty or painful and incurable disease. It was thought that, if a man drowned himself in a sacred river, such as the Ganges, especially at some peculiarly sacred spot, such as Allāhābād, Tribeni, or Sāgar Island, he would thereby acquire merit that would redound to his advantage in his next birth. The rite used to be performed with much ceremony. The man who was tired of life made the prescribed ablutions and repeated certain *mantras*, and then sprang from a boat, or waded out of his depth, with earthen vessels tied to his limbs, which dragged him down when they filled with water. It was considered auspicious if a crocodile carried him off before he died from drowning. Another favourite method of ending life was by throwing oneself beneath the wheels of the huge car on which the image Jagannāth at Puri is dragged once a year from the temple in which it is usually kept to a garden house about a mile away. Sick people, if the astrologer has predicted their death, are often taken to die on the banks of a sacred river. In former times, if death were long in coming, they frequently starved or drowned themselves; and, if at the last their resolution failed them, their relatives took care that they did not draw back.

¹ *A New Account of the East Indies*, by Captain Alex. Hamilton, who travelled in India from 1688 to 1723, reprinted in Pinkerton's *Voyages and Travels* (London, 1811), viii. 374.

² *PNQ* ii. 118.

9. Sati.—But the most common and best known form of religious suicide was that, commonly known as *sati*, of widows who allowed themselves to be burnt to death on the funeral pyres of their husbands. Such suicides were frequent among all the high castes, and were especially common in the families of Rājput chiefs. In many cases the act was entirely voluntary, but sometimes the unfortunate widow was subjected to a good deal of pressure before she could be induced to ascend the pyre. *Sati* was prohibited by law in British territory in the year 1829; and the example thus set was followed some years later by the rulers of the Native States. Isolated cases, however, still sometimes occur. In the year 1911 a Hindu lady, whose husband was on the point of death, soaked her clothes in kerosene oil and, setting light to them, burnt herself to death.¹ Her act was applauded as that of a devoted wife by many Hindus, even among the educated classes. How this practice came into vogue it is difficult to say. There is no mention of it in the Vedas; but, from the belief that the wife who thus immolated herself accompanied her husband to the other world, it may have arisen from the same class of ideas which led the Ahoms to bury their slaves alive in the tombs of their kings and great nobles, and the Khongi Nāgās to decapitate a man and inter his head with that of a deceased chief. Certain Central India chiefs used to slay men at their predecessors' obsequies. In the southern kingdom of Vijayanagar, royal funerals were the occasion for wholesale holocausts of women.

10. Offering one's own blood.—In conclusion, mention may be made of the practice of offering one's own blood to Kālī. This is referred to in the *Kālikā Purāna* as an acceptable way of propitiating the goddess, and it is still common among Hindu women. When a husband or a son is dangerously ill, a vow is made that, on the recovery of the patient, the goddess will be propitiated with human blood. The vow is fulfilled either at the next *Durgā Pujā*, or at once in some temple of Kālī. The wife or mother, after performing certain ceremonies, draws a few drops of blood from her breast with a nail-cutter, and offers them to the goddess.

LITERATURE.—F. M. Müller, *Anc. Skr. Lit.*, London, 1880, p. 408 ff.; A. Hillebrandt, *Rituallit.* (*GIAP* iii. 2 (1897)), p. 158; H. H. Wilson, *Essays . . . on the Rel. of the Hindus*, do. 1861-62, ii. 247 ff.; A. Weber, *Ind. Streifen*, Berlin, 1868-79, i. 54 ff.; J. Eggeling, *SBE* xlii. (1900) xxxiii ff.; W. Crooke, *PR* ii. 167 ff.; N. Chevers, *Medical Jurisprudence in Bengal and the North-Western Provinces*, Calcutta, 1854; W. Ward, *History, Literature, and Religion of the Hindus*, Madras, 1816; R. Mitra, 'On Human Sacrifices in Ancient India,' *JASBe*, vol. xiv. (1876) pt. i. p. 76; E. A. Gait, 'Human Sacrifices in Ancient Assam,' *ib.*, lxxvii. (1898) pt. iii. p. 56; J. G. Frazer, *GB*, London, 1907 ff.; G. E. R. Grant Brown, 'Human Sacrifices near the Upper Ohindwin,' *Journal of the Burma Research Society*, vol. I.

E. A. GAIT.

HUMAN SACRIFICE (Iranian).—I. Early Iranians and Avestan people.—The prevalence of the custom of sacrificing human beings to the gods is so fully and incontrovertibly attested among practically all the other Indo-European peoples, as it is in the case of most ancient nations, that we are naturally predisposed to look for clear and unmistakable indications of its existence among the Iranians. In point of fact, however, these indications are so few and inconclusive that the practice of human sacrifice has been confidently declared² never to have been in vogue among the Persians. Whether the possession of earlier records would have exhibited the Iranians in line

¹ Several more similar cases have occurred since this article was written.

² 'The Persians were perhaps the only nation in ancient times who did not indulge in human sacrifices' (Rājendraśāstra Mitra, 'On Human Sacrifices in Ancient India,' *JASBe* xiv. (Calcutta, 1876) 88.

with the other Indo-European races in this matter is a question that does not admit of a categorical answer. Schrader,¹ speaking of the Aryans (*i.e.* Indo-Europeans) generally, says:

'If, as is little likely to be doubted, offerings were made to heaven in the primitive period . . . then human sacrifice must have taken a prominent place amongst them.'

Others, with much historical justification, maintain that no general principle can be laid down as to the point of time and the order in which human and animal sacrifices occur in the religious development of nations (see art. ANIMALS, vol. i. p. 498 f.; also art. 'Sacrifice,' in *EBr*¹¹, by the same author). Moreover, among the Hindus, the nearest ethnological relations of the Iranians, the prevalence of human sacrifices is in inverse ratio to the antiquity of the period we may be considering. Of its vogue in the earliest Vedic times we possess only the indications contained in the *Sunah-sepa* hymns of the *Rig Samhitā* (i. 24-30), which, in all probability, are to be regarded as pointing to a real and not a merely symbolical sacrifice (see Rājendralāla Mitra, *op. cit.*). The Avesta, on the other hand—even its earliest portions—contains no suggestion of that custom as having been practised at any time. What little bearing on this subject the evidence of the Avesta possesses tends to confirm our surmise that human sacrifices were unknown to the Avestan and pre-Avestan people of Iran. The most usual victims in the human sacrifices of most nations were prisoners of war. But these, we have reason to believe, were treated with great clemency by the Avestan people.

As Geiger² says:

'Captives taken in war were kept by their conquerors as servants and slaves. As such, they formed, I believe, part of the household of the Mazdayasniāns, where they seem to have been treated kindly and humanely.' And again, 'Slaves were evidently regarded as members of the family, and their possession very highly valued.'

It should, perhaps, be remembered that the above is a description of the social life of the eastern Iranians in particular, whose practices as well as their creed may have differed somewhat from those of their more westerly kinsmen.

2. The Achæmenians and the custom of human sacrifice.—Herodotus and some later writers attribute isolated instances of human sacrifice to at least three of the Achæmenian kings. Each of these cases must be considered separately. In the first place, when Sardis, the capital of the kingdom of Lydia, fell (in 546 B.C.) into the hands of the Persians, Cyrus, according to the account of Herodotus,³ issued orders to erect a great pyre and to place Cræsus, the captive king, with fourteen youths, on the pile to be burnt. Later, however, he relented, and a shower of rain extinguished the flames, and thus Cræsus was spared. This version of the story had always presented two great difficulties to its acceptance. The first and more formidable was that of reconciling this incident with Cyrus's otherwise justly enjoyed fame for clemency to his prisoners in war, and no adequate reason seemed to have been present for any departure on this occasion from his usual attitude and practice. Further, there was the less formidable, perhaps, yet real objection that Cyrus, as a Zoroastrian or true Persian, could not have ordered the burning of Cræsus. The light which recent researches have thrown upon Cyrus's religious attitude has tended to some extent to remove the latter difficulty. Nevertheless, the story as told by Herodotus did not easily commend itself to

¹ *Prehistoric Antiquities of the Aryan Peoples*, tr. Jevons, London, 1890, p. 421; see also art. 'Opfer,' in Schrader, *Reallexikon d. indogerm. Altertumskunde*, Strassburg, 1901.

² *Civilization of the Eastern Iranians in Ancient Times*, tr. Darab Peshotan Sanjana, London, 1885-86, li. 69 f.

³ Herod. i. 86 ff.; also Nicolaus of Damascus, frag. 61 (Müller, *FHG* iii. 406); Lucian, *Gallus*, 23.

the general acceptance. The recently discovered poems of Bacchylides (born 507 B.C.)¹ yielded another version of the story of Cræsus, earlier in date than that of the historian and also free from its objections. In the poem, instead of being condemned to die by his conqueror, Cræsus elects to perish in the flames of a pyre of his own erection, rather than submit to the indignity of enslavement to a foreign foe. The version of Bacchylides receives striking corroboration from a red-figured Greek vase² of the late 6th or early 5th cent. B.C. preserved in the Louvre. The vase shows Cræsus enthroned and crowned, clad in his kingly robes, holding his sceptre with his left hand, and solemnly pouring a libation with his right. It is agreed by all that his attitude is in every way suggestive of the voluntariness of the act of self-immolation, and confirms Bacchylides' version of the story. It seems, therefore, that the charge of human sacrifice in the case of Cyrus must be waived. Nor does it seem possible to regard the instance given by Herodotus³ of the action of Cambyses as an example of human sacrifice.

'At another time,' says the historian, 'he took twelve of the noblest Persians, and, without bringing any charge worthy of death against them, buried them all up to the neck.'

Even Herodotus himself adduces this incident as an example of the king's mad ferocity. The act is in no way religiously motivated.

Only two more instances are recorded by Herodotus, one of which is attributed to Xerxes, the other to his wife Amestris (vii. 114).

'When they learnt that the name of the place was "The Nine Ways," they took nine youths of the land and as many of their maidens and buried them alive on the spot. Burying alive is a Persian custom. I have heard that Amestris, the wife of Xerxes, in her old age buried alive seven pairs of Persian youths, sons of illustrious men, as a thank-offering to the god who is supposed to dwell underneath the earth.'

The latter statement does not easily fit into the scheme of Persian cosmogony, and probably, as Rawlinson (*ad loc.*) says, Herodotus here speaks as a Greek. Now, although the religious motive is not quite so remote in these two instances as in the case of Cambyses, it will probably still be felt that we have here but slender basis upon which to found our belief in the Persian custom of human sacrifice (see art. ACHÆMENIANS). Even granting that we are dealing with true history, it seems more probable that these older instances of 'tree-planting' were prompted by human vindictiveness rather than by a desire to observe a religious custom and propitiate a god; for the custom of burying alive remained to modern times in Persia as one of the most cruel forms of torture (see Niebuhr, *Vorträge*, Berlin, 1847, i. 155).

3. Human sacrifice as practised by the Scythians.—Although all the other branches of the Iranian race, so far as our records show, were singularly free from the habit of sacrificing human beings, the Scythians, who were perhaps only mainly Iranian, practised that custom in very extreme forms.

It was their custom to sacrifice one out of every hundred prisoners of war. The method of immolation, according to Herodotus,⁴ was as follows. A large platform made of brushwork was erected, upon the top of which was set a sword or scimitar, the image of Ares. Libations of wine were poured over the victims' heads, after which they were slaughtered over a vessel. Then the blood was taken to the top of the pile and poured upon the scimitar. While this was proceeding at the top of the platform, below, by its side, the right hands and arms of the slaughtered men were cut off and tossed up into the air, the whole being left to disintegrate and decay where they might chance to have fallen. Another

¹ See F. G. Kenyon, *The Poems of Bacchylides*, London, 1897, *Introd.* p. 28 f.; R. C. Jebb, *Bacchylides, the Poems and Fragments*, Cambridge, 1905, p. 195 ff.

² See reproduction in *JHS* xviii. (London, 1898) 268.

³ iii. 35.

⁴ iv. 62.

instance, in which, perhaps, the religious motive is more remote, is the method by which false diviners were immolated. A waggon is loaded with brushwood, and oxen are yoked to it. Then the soothsayers, with their feet tied together, their hands bound behind their backs, and their mouths gagged, are thrust into the midst of the brushwood. Finally the wood is ignited and the oxen are made to rush off with their burning load until they themselves are caught in the conflagration and all are consumed together.¹

The only other instance that need be mentioned here bears more clearly the character of a religious sacrifice, namely, the ceremonies associated with a king's funeral. After the long march of the procession from tribe to tribe, as described by Herodotus,² and the arrival at the royal tombs, the body of the dead king, stretched on a mattress, is laid in the grave prepared for it. In the open space around the body of the king they bury one of his concubines, first killing her by strangling, and also his cupbearer, his cook, his groom, his lacquey, his messenger, as well as some horses and other possessions. When a year is gone, further ceremonies take place. Fifty of the best of the late king's attendants—all native Scythians—are taken and strangled. Then as many of the king's finest horses are slain. After a somewhat barbarous process of preparation, the strangled youths are mounted upon the slaughtered horses and arranged in a circle around the king's tomb. These are the most important instances of the forms of human sacrifice as practised by the Scythians.

LITERATURE.—The works dealing most fully and directly with the various parts of our subject have already been indicated. On the Croesus story, see also J. G. Frazer, *Adonis, Attis, Osiris*, London, 1907, pp. 141 ff., 146 ff.; see also p. 402 f. on the custom of burying alive.

E. EDWARDS.

HUMAN SACRIFICE (Japanese and Korean).

—I. Japanese.—The most ancient Japanese documents that have come down to us were written at a time (8th cent.) when the memory of human sacrifices was still green. One of the most important myths of the *Kojiki* is conceived as follows:

Having been expelled [from Heaven, after his crimes against the Sun-goddess], Susa-no-wo-no-mikoto [His-Swift-Impetuous-Male-Augustness, the god of the Ocean and the Storm, who appears here in the aspect of a human hero] descended to a place called Tori-kami at the head-waters of the River Hi in the land of Idzumo. At this time some chopsticks came floating down the stream. So His-Swift-Impetuous-Male-Augustness, thinking that there must be people at the head-waters of the river, went up it in quest of them, when he came upon an old man and an old woman,—two of them,—who had a young girl between them, and were weeping. Then he deigned to ask: "Who are ye?" So the old man replied, saying: "I am an Earthly Deity, child of Oho-yama-tsu-mi-no-kami [the Great-Mountain's God]. I am called by the name of Ashi-nadzu-chi, my wife is called by the name of Te-nadzu-chi, and my daughter is called by the name of Kushi-nada-hime (*hime*, 'princess'; *nada*, no doubt for *Inada*, a place-name meaning 'rice-field'; *kushi*, in the sense of 'comb' here, as the story that follows shows)." Again he asked: "What is the cause of your crying?" The old man answered, saying: "I had originally eight young girls as daughters. But the eight-forked serpent of Koshi [a name of the north-west district occupied by the Ainu] has come every year and devoured one, and it is now its time to come, wherefore we weep." Then he asked him: "What is its form like?" The old man answered, saying: "Its eyes are like *akakagachi* [the winter-cherry]; it has one body with eight heads and eight tails. Moreover, on its body grows moss, and also *chamæcyparis* and *cryptomerias*. Its length extends over eight valleys and eight hills, and if one looks at its belly, it is all constantly bloody and inflamed." Then His-Swift-Impetuous-Male-Augustness said to the old man: "If this be thy daughter, wilt thou offer her to me?" He replied, saying: "With reverence, but I know not thine august name." Then he replied, saying: "I am elder brother to the Heaven-Shining-Great-August-Deity. So I have now descended from Heaven." Then the Deities Ashi-nadzu-chi and Te-nadzu-chi said: "If that be so, with reverence will we offer her to thee." So His-Swift-Impetuous-Male-Augustness, at once taking and changing the young girl into a multitudinous and close-toothed comb which he stuck into his august hair-bunch, said to the Deities Ashi-nadzu-chi and Te-nadzu-chi: "Do you distill some eight-fold refined liquor [*sake*]. Also make a fence round about, in that

fence make eight gates, at each gate tie together eight platforms, on each platform put a liquor-vat, and into each vat pour the eight-fold refined liquor, and wait." So, as they waited after having thus prepared everything in accordance with his bidding, the eight-forked serpent came truly as the old man had said, and immediately dipped a head into each vat, and drank the liquor. Thereupon it was intoxicated with drinking, and all the heads lay down and slept. Then His-Swift-Impetuous-Male-Augustness drew the ten-grasp sabre that was augustly girded on him, and cut the serpent in pieces, so that the River Hi flowed on changed into a river of blood. So when he cut the middle tail, the edge of his august sword broke. Then, thinking it strange, he thrust into and split the flesh with the point of his august sword and looked, and there was a great sword within. So he took this great sword, and, thinking it a strange thing, he respectfully informed the Heaven-Shining-Great-August-Deity. This is the Kusa-nagi-no-tachi [Herb-Quelling-Great-Sword] (*Kojiki*, tr. Chamberlain, 2nd ed., Tokyo, 1906, pp. 71-73; cf. *Nihongi*, tr. Aston, London, 1896, i. 52-58).

This is clearly analogous to the legend of Perseus rescuing Andromeda from a sea-monster who was about to devour her. It seems to have lost, at the time of its redaction, what was probably its original meaning, and, before becoming a simple epic narrative, to have been meant to recall the abolition of human sacrifices offered to theriomorphic deities, especially water-spirits conceived in animal form (see E. S. Hartland, *LP* iii. ch. xviii.; Marillier, in *RHR* xxxiv. [1896] 401 f.). The description of the monster of Koshi, in fact, seems, as already observed by Aston (*Shinto*, London, 1905, p. 105), to be really a poetical representation of the river itself, with its serpentine course, its numerous tributaries, its wooded banks, and its deep waters, devourers of human beings. Even to-day popular superstition believes in the existence of monsters called *kappa* which haunt the mouths of rivers by preference, and kill human beings, just as the inhabitants of the thick mountain-forests fear the *uwabami* (legendary boas believed to devour women and children). It was much more natural for such ideas to be prevalent among the primitive Japanese, who, like so many other peoples (see Waitz-Gerland, *Anthropologie der Naturvölker*, Leipzig, 1860-77, iii. 198; A. Réville, *Religions des peuples non-civilisés*, Paris, 1883, i. 175 f., 225, 247, etc.), endowed the spirit of the waters with serpent form, serpents often having aquatic habits, and attributed to its poisonous breath the deadly influences manifested in certain epidemics. Hence the conception of the *mizu-chi*, 'water-elder,' i.e. 'water-god,' of which the terrible dragon of Koshi is only a representation enlarged upon by the imagination of myth-makers.

Another story helps to confirm this interpretation by giving us a positive example of these sacrifices to the river-deities. It is telling of an event which happened, according to the *Nihongi*, in the year A.D. 323:

"In order to prevent the overflowing of the Northern river, the Mamuta embankment was constructed. At this time there were two parts of the construction which gave way and could not be stopped up. Then the Emperor had a dream, in which he was admonished by a God, saying: "There is a man of Musashi named Koha-kubi, and a man of Kahachi named Koromo-no-ko, the Muraji of Mamuta. Let these two men be sacrificed to the River-God, and thou wilt surely be enabled to close the gaps." So he sought for these two men, and, having found them, sacrificed them to the River-God. Hereupon Koha-kubi wept and lamented, and, plunging into the water, died. So that embankment was completed. Koromo-no-ko, however, took two whole calabashes, and, standing over the water which could not be dammed, plunged the two calabashes into the mid-stream and prayed, saying: "O thou River-God, who hast sent the curse, to remove which I have now come hither as a sacrifice! If thou dost persist in thy desire to have me, sink these calabashes and let them not rise to the surface. Then shall I know that thou art a true God, and will enter the water of my own accord. But if thou canst not sink the calabashes, I shall, of course, know that thou art a false God, for whom why should I spend my life in vain?" Hereupon a whirlpool arose suddenly which drew with it the calabashes and tried to submerge them in the water. But the calabashes, dancing on the waves, would not sink, and floated far away over the wide waters. In this way that embankment was completed, although Koromo-no-ko did not die. Accordingly, Koromo-no-ko's cleverness saved his life. Therefore the men of that time gave a name to these two places, calling them "Koha-kubi's Gap" and "Koromo-no-ko's Gap" (*Nihongi*, i. 281 f.).

¹ Herod. iv. 69.

² iv. 71.

What is the significance of the calabashes employed here? Is it a simple test, cleverly based on the difficulty that the god would have in sinking the light floating gourds? Or may we have at the same time the idea of the magic virtue attributed to calabashes, which were used in ancient India as an antidote to serpent-bites? (see V. Henry, *La Magie dans l'Inde antique*, Paris, 1904, p. 203; and cf. the willow-tree gourds used as amulets in China [J. J. M. de Groot, *Les Fêtes annuelles à Emoui*, Paris, 1887, p. 328 f.]). Whatever may be the answer to these questions, we have in this story a case of human sacrifice, fully accomplished for one of the victims, and escaped by the other only through his personal ingenuity. With this story we may connect the following, given under A.D. 379 by the *Nihongi*:

'This year, at a fork of the River Kahashima, in the central division of the Province of Kibi, there was a great water-snake which harassed the people. Now when travellers were passing that place on their journey, they were surely affected by its poison, so that many died. Hereupon Agata-mori [District-warden], the ancestor of the Omi of Kasa, a man of fierce temper and of great bodily strength, stood over the pool of the river-fork and flung into the water three whole calabashes, saying: "Thou art continually belching up poison and therewithal plaguing travellers. I will kill thee, thou water-snake. If thou canst sink these calabashes, then will I take myself away; but if thou canst not sink them, then will I cut up thy body." Now the water-snake changed itself into a deer and tried to draw down the calabashes, but the calabashes would not sink. So with upraised sword he entered the water and slew the water-snake. He further sought out the water-snake's fellows. Now the tribe of all the water-snakes filled a cave in the bottom of the pool. He slew them every one, and the water of the river became changed to blood. Therefore that water was called "The pool of Agata-mori" (*Nihongi*, i. 298 f.).

These two stories, which the *Nihongi* places, rightly or wrongly, in the 4th cent., but which in any case are of a much later date than the myth of the serpent of Koshi, already display a certain scepticism in regard to the river-gods and the utility of appeasing them by the sacrifice of human life. They establish, nevertheless, the early existence of the custom of whose abolition the legend of the Japanese Perseus gives us a symbolical account—a custom probably replaced later by animal sacrifices and finally falling into complete disuse under the influence of Buddhism. A later text, referring to A.D. 642, when there was a great drought, says:

'The Ministers conversed with one another, saying: "In accordance with the teachings of the village *hafuri* ['sacrificers,' priests of an inferior grade], there have been in some places horses and cattle killed as a sacrifice to the Gods of the various (Shintō) shrines, in others . . . prayers to the River-Gods. None of these practices have had hitherto any good result"; and consequently it is decided, on the motion of Soga no Oho-omi, to have recourse to nothing else than Buddhist prayers in order to get rain' (*Nihongi*, ii. 174 f.).

The substitution of animal victims for human victims is confirmed by a curious myth in a work of the beginning of the 13th cent., the *Uji Shui Monogatari* ('Tales forming a sequel to the Uji Collection,' a similar collection which appeared in the 11th century). Here we find a local survival, in the circuit of Sanyōdō (on the Inland Sea), of a serpent-god and a monkey-god to whom a maiden was sacrificed every year; then, thanks to the mythical intervention of a noble hero, 'the Knight of Azuma,' the suppression of this custom, and the decision made by the priests of the temple that in future they would sacrifice only boars and deer (see 'Some Tales from the Uji Shui Monogatari,' in *TASJ* xxviii. [1900] 41-45). Similar substitutions might be cited among other peoples, from the time of ancient Greece, where the annual immolation of a youth to Dionysos was replaced by the sacrifice of a goat at the request of the inhabitants of Potniæ (Pausanias, ix. 8. 1), to the 19th cent., when the British Government intervened to substitute a goat for the child immolated every year by the Khonds; cf. also the pretended, and very characteristic, immolation, in Sweden, of

a man clothed in boar's skin (see Goblet d'Alviella, 'Les Rites de la moisson,' in *RHR* xxxviii. [1898] 15). In Japan itself we see subsisting, on the one hand, the actual *hostiæ animales* (e.g. in the temple of Suwamyōjin, in Shinano, frequent offerings of about seventy-five boars and deer), and, on the other hand, the old human sacrifice kept up in the form of a ritual imitation (e.g. in the temple of Sakatomyōjin, in Kazusa, after drawing lots among the faithful, the chosen victim is placed on a large stall, and the priest, armed with a great chopping-knife, makes a pretence of cutting him up with three blows; see Katō Setsudō, in the *Chuō Kōron* [*Japan Mail*] for 4th July 1903).

In one of the stories from the *Nihongi* (i. 281) we have seen human sacrifice employed to expedite the construction of an embankment. Men were also sometimes buried alive in the foundations of a castle, a bridge, or an artificial island. They were called *hito-bashira* ('human pillars'). But the most interesting example of this order of customs is the burying alive of human beings in the graves of Emperors and princes—a custom which took its rise, according to the *Nihongi* (i. 213), at the funeral of prince Yamato-hiko, but which is certainly more ancient and becomes particularly connected with this funeral only, as Motoori very plausibly holds, by an unprecedented exaggeration of the number of victims which brought this abuse to a head, and led to its suppression at subsequent Imperial funerals. This important custom, its significance, and its abolition are treated in art. ANCESTOR-WORSHIP (Japanese). As far as we know at the present day, the *haniwa* (clay rings), circles of effigies of baked earth, which, according to the account of the *Nihongi* (i. 178 f.), took the place round the tomb of the row of men and horses originally buried alive, seem to have originated in Japan. The archæological discoveries of recent years have revealed them also in China (cf. 'Chinese' art.), in tombs of the Han dynasty (E. Chavannes, *Mission archéologique dans la Chine septentrionale*, Paris, 1910), and, in a rougher form, in tombs in Manchuria and the neighbourhood of Port Arthur (see artt. by Hamada Kosaku and Torii Ryuzō, in *Kokka*, Tokyo, 1910, 1911). It may be asked, then, Are the Japanese effigies not of continental origin, and has not the *Nihongi*, as often happens, borrowed its account from some Chinese work? On the other side, however, we must not lose sight of the fact that the account of the *Nihongi* agrees with a passage of the *Kojiki* which is certainly genuine and authentic, saying that 'in the time of the Great Empress Her Augustness Princess Hibasu [the same empress whose funeral, according to the *Nihongi*, put an end to human sacrifices] the *Ishi-ki-tsukuri* (Stone-Coffin-Makers) were established, and also the *Hanishi-be* (Earthenware-Masters' Clan) was established' (*Kojiki*, 247). The fact that human sacrifice, which had been suppressed, according to the *Nihongi*, in A.D. 3, must have been revived, according to a Chinese work (see *TASJ* xvi. [1888] pt. i. p. 59), at the death of the Empress Himeko in A.D. 247, only exemplifies the well-known inaccuracy of the concocted chronology of the *Nihongi*, and does not prove that the reform was never accomplished—the redactors of the *Nihongi* simply placed it too early, as is the invariable custom of the Easterns, more concerned as they are with antiquity than with truth. Moreover, it is difficult to see from what Chinese work they could have drawn the account of a transformation which is exactly the opposite of the Chinese conception in this connexion, viz. that the offering of straw or wooden effigies at funerals led to the substitution of living victims (J. Legge, *Chinese Classics*, Hongkong, 1861-72, 'Mencius,' p. 9). On the other hand, the

account of the *Nihongi* is in entire agreement with all that we have noticed in Japan as regards the substitution of effigies for actual victims.

These substitutions appear in various forms. Sometimes, as we have seen above, animal victims take the place of human victims; sometimes, instead of the 'earth dolls' (*tsuchi-ningyō*) of the tombs, there are other effigies of human form, such as the *kane-hito-gata* ('metal-human-form'), often mentioned in the *Engishiki* (10th cent.) among the regular offerings of Shintoism, and specially offered to river-gods (*mikumari*, 'gods of water distribution')—a fact which goes to support a historical substitution of these effigies for actual victims, the occurrence of which is proved by a positive text of the *Nihongi* (i. 281). Similar human effigies, gilded or silvered, also took the place of offerings in the ceremony of the Great Purification (*Oho-harahi*). The hereditary Corporation of scholars of Yamato and Kahachi, who pronounced an invocation before this ceremony (*norito* 11), offered a silver man and a sword of gold, or rather of gilded wood, to the gods, in order that all kinds of calamity might be warded off from the Emperor, and that he might enjoy a long reign. The gilded sword (called *harahi-tsu-tachi*, 'sword of purification') first received the breath of the Emperor; he blew over it in order to communicate his own uncleanness to it, since the uncleanness was bound to disappear along with the object to which it was thus attached. The silver man was also employed as an *aga-mono* ('ransom-thing'), i.e. as a means of expiating ritual uncleanness.

These human effigies substituted for victims persisted down to modern times. As witness of this there is a curious custom related by Aston (*Shinto*, 220) from the *Shinto Miōmoku* (1699):

'At the festival of Nawoye, held at the shrine of Kokubu in the province of Owari on the 11th day of the 1st month, the Shinto priests go out to the highway with banners and seize a passer-by. They wash and purify him, and make him put on pure clothing. He is then brought before the god. A block, a wooden butcher's knife, and chopsticks for eating flesh are provided. Separately a figure is made to represent the captive. It is placed on the block with the captured man beside it, and both are offered before the god. They are left there for one night. The next morning the priests come and remove the man and the effigy. Then they take clay, and, making it into the shape of a rice-cake, place it on the captive's back, hang a string of copper cash about his neck, and drive him away. As he runs off, he is sure to fall down in a faint. But he soon comes to his senses. A mound is erected at the place where he falls down, and the clay rice-cake deposited on it with ceremonies which are kept a profound mystery by the priestly house. Of late years, couriers have been caught and subjected to purification. This was put a stop to. The custom is celebrated yearly, so that nowadays everybody is aware of it, and there are no passers-by. Therefore the priests go to a neighbouring village and seize a man. If they catch nobody on the 11th, they bring in a man on the 12th.'

Aston (p. 221) thinks that 'there is some difficulty in applying the principle of substitution for an actual human sacrifice to a custom which was in force so recently.' But, if we have seen offerings of live animals, as substitutes for human victims, continuing even to our own day (as observed in 1903, and quoted above), why should offerings of dead effigies not have had, with the same evolution, the same permanence? This would be in complete accord with the profoundly traditionalistic spirit of the religious customs.

There is one other custom that deserves notice in the domain of human sacrifices, if we regard liberty as almost as precious as life, viz. the offerings of slaves (*kami-tsu-ko*) sometimes made formerly for service in the temples. Even in the mythological period we see the famous hero Yamato-daké, the Brave of Japan, handing over some Emishi (i.e. Ainus), whom he had taken captive, for service in a temple (*Nihongi*, i. 209). Many cases of the same kind could be quoted from the historical period, e.g. in the year 562 (*Nihongi*, ii. 82f.).

Human sacrifice properly so called exists, even in our own day, under the form of voluntary death in order to follow a master or a husband into the other world. This voluntary sacrifice, which is in evidence even in the earliest documents (see *Kojiki*, 293, 384; *Nihongi*, i. 331, ii. 183, 234, 383), and which so many rulers vainly endeavoured to suppress, from the Emperor Kōtoku in 646 (*Nihongi*, ii. 220) to the great *shōgun* Iyeyasu in the 17th cent., has continued down to the 20th century. Cases might be cited during the Revolution of 1868, and again during the Chino-Japanese War, when, in 1895, the wife of an officer, Lieutenant Asada, hearing of her husband's death in China, made it her duty to cut her throat in cold blood before her husband's portrait, with a dagger which, in anticipation of some such situation as this, had been one of her wedding-presents. The modern Japanese admired this suicide, exactly as the ancient admired that of the Imperial Princess Yamanobe, who, in 686, when her young husband had been accused of treason and executed, 'hastened thither with her hair dishevelled and her feet bare, and joined him in death,' so that, adds the narrator, 'all who witnessed sighed and sobbed' (*Nihongi*, ii. 383).

A recent example shows the extent to which these ideas still survive—the suicide of General Count Nogi, the hero of Port Arthur, who, on 13th Sept. 1912, at the very time of the funeral of the Emperor Mutsu-Hito, put himself to death so that he might follow his sovereign to the other world. Countess Nogi also killed herself in order to accompany her husband; and thus we see united in a single example, the two chief kinds of voluntary suicide mentioned above. On this occasion Japanese opinion was by no means unanimous with regard to the social utility of this act, which, though putting a harmonious completion to the life of a warrior of the old school, deeply imbued with the ancient traditions of loyalty, deprived the Japanese nation of a man of experience on whose services it could have depended should new dangers arise from outside. The police of Tokyo, however, had to take measures to prevent this suicide being imitated by contagion; and even in the United States, in a house at Grand Junction, Colorado, two Japanese had to be arrested who had met to decide by drawing lots which of them should perform *harakiri*. Thus, just as General Nogi's will, offering his body to the Faculty of Medicine, with the reservation that his teeth, hair, and nails should be buried, shows the survival in him of a conception belonging to primitive magic (see M. Revon, *Le Shinntoisme*, Paris, 1907, pp. 30, 70, 256), similarly his dramatic suicide takes us back to the ancient belief in the virtue of human sacrifices made for a dead chief. The Japanese, indeed, make no distinction between forced and voluntary sacrifice, as is clearly indicated by the fact that the one word *jun-shi*, i.e. 'following in death,' is used to denote the two indifferently.

2. Korean.—In Korea we may observe an analogous evolution to that which occurred in Japan, to this extent that the custom of human sacrifice, forced or voluntary, died hard and only by the personal efforts of reasonable rulers. In Japan, a humane Emperor (Suinin, according to *Nihongi*, i. 178), already showing that progressive spirit which is so common to the Japanese, said to his ministers: 'Though it be an ancient custom, why follow it, if it is bad?' Similarly in Korea, when a king of the country of Kokuryo, famed for his virtues, died, his successor forbade his admirers to kill themselves on his tomb, saying that it was not a becoming custom; but still many persisted in following their master in death (*Tongkam*, iii. 20). In the same way, in 502, several men and women had

already been sacrificed at the tomb of a king of Silla when the custom of burying live victims was prohibited in this kingdom (*ib.* v. 5).

LITERATURE.—This is cited in the article.

MICHEL REVON.

HUMAN SACRIFICE (Roman).—Human sacrifice implies the killing of a human being in honour of a deity, as an act prescribed by religion and performed with due ceremonial. The religious requirement is based upon the idea that an enraged deity craves for human life. The anger of the deity, according to the beliefs of many peoples, is to be discerned in his sending war or pestilence involving great loss of life; thus the pestilence in the Greek camp before Troy was caused by the arrows of Apollo (*Il.* i. 51). In such cases the community in ancient times tried to save itself by sacrificing one or more human beings (Verg. *Æn.* v. 815: 'unum pro multis dabitur caput'), and thus propitiating the divine wrath (propitiatory sacrifice). In the case where a particular individual was known to have sinned against, and thus to have brought upon himself the resentment of, a deity, he was sacrificed as an atonement, so that the deity's wrath should not fall upon others (expiatory sacrifice); thus the plague in Thebes was stayed as soon as the murderer of Laius was banished (Soph. *Œd. Rex*, 96 ff.). At a later stage we meet with more merciful rites, usually spoken of as commutations of human sacrifice; the community, partly because it stands in need of men, and partly because it has become more humane in sentiment, endeavours to avoid the killing of men by changing either the mode or the victim of the oblation; it allows the victim to live, but exiles him (Œdipus), or, instead of making the offering originally demanded, it offers figures of men or animals; thus animals were sacrificed by the Greeks to Apollo (*Il.* i. 447 f.). When in the expiatory sacrifice the act of killing is still retained, it loses its religious character, and becomes capital punishment in the secular sense. Thus human sacrifice may at length entirely disappear from the practice of a religion, and, as we must not summarily assign to all religions the same course of development, the modern investigator is confronted with the question whether a religion from which human sacrifice is absent may formerly have had the practice or not.

This doubt affects also the Roman religion. G. Wissowa (*Religion u. Kultus d. Römer*², p. 420 f.) denies that the Roman religion ever required human sacrifice, while others (cited by Wissowa, *loc. cit.*) assert that it did. It is certainly true that in the State religion, so far as history attests it to have been officially Roman, there is no evidence of the practice. From Cicero, *pro Font.* 31, and Cæsar, *de Bell. Gall.* vi. 16, where human sacrifice is referred to as something repulsive or abnormal, we may infer that it did not exist in the 1st cent. B.C., and the words of Livy (xxii. 57. 6), 'hostiis humanis, minime Romano sacro,' point in the same direction. Livy's reference certainly seems to clash with the fact that, according to a number of Christian writers in the Imperial period (Tatian, *Or. ad Græcos*, 129; Minucius Felix, 30. 4; and others; cf. J. Marquardt, *Röm. Staatsverwaltung*, iii.², Leipzig, 1885, p. 297. 4), a man ('bestiarius' [Tert. *Apol.* 9]) was sacrificed to Jupiter Latiaris at the festival of the latter. W. Warde Fowler (*The Religious Experience of the Roman People*, London, 1911, p. 112. 31) is of opinion that this points to a practice of actual human sacrifice which had grown up under the influence of Oriental immolation and of the brutalizing slaughter in the arena. But, as this reference is an isolated one, it rather arouses suspicion, the more so because profane writers make no mention of the incident; J. Geffcken (*Zwei*

griech. Apologeten, Leipzig and Berlin, 1907, p. 66) and Wissowa (*op. cit.* 124) reject it as apocryphal. But it would be a mistake to regard it simply as a biased fabrication of Christian authors. The present writer is inclined rather to suppose that the celebrations of the Latiaris festival included the baiting of animals; that some writer whose works are now lost ironically described the hardly avoidable deaths of *bestiarii* as sacrifices to Jupiter; and that then the Christian writers mentioned above not unwillingly accepted the statement as fact.

The alleged human sacrifice at the Latiaris festival must, therefore, not be appealed to as proving the existence of the practice of human immolation in the Roman religion. But, on the other hand, the references of Cicero, Cæsar, and Livy, as cited above, furnish no evidence as to primitive times; and, in order to decide the question in relation to that earlier age, such rites and beliefs as may possibly be survivals of an ancient practice of human sacrifice (Wissowa, *op. cit.* 420) must be examined in detail.

The Compitalia are a theme of particularly vigorous discussion (Samter, in *ARW* x. [1907] 374 ff.; Wissowa, *op. cit.* 167); the present writer's own view will be given in what follows. It was the custom at that festival to hang up in the chapels of the Lares as many human figures and as many balls respectively as there were freemen and slaves present—'ut vivis parcerent [Lares]' (Paul.-Fest. 239). Even if we regard the purpose of the ceremony as being correctly indicated in that ancient phrase, yet it would not be pertinent to apply the term 'commuted human sacrifice' to the rite. For this would imply that originally the whole household were actually sacrificed—an idea that cannot be entertained. All that the custom in question has in common with human sacrifice is its basis, viz. the belief that the gods have a desire for human life. Men seek to satisfy that desire in the easiest possible way; they present the deity with objects of no great value, which nevertheless, on some ground or other, are regarded as equivalent to a man's life, as, e.g., his image (which primitive belief identified with the original; cf. O. Weinreich, *Antike Heilungswunder [= Religionsgeschichtl. Versuche u. Vorarbeiten*, viii. 1], Giessen, 1909, p. 144), or a ball (a crude representation of the head, the seat of life). By a similar gift, viz. beans (on the relation of which to human life, cf. R. Wunsch, *Das Frühlingsfest der Insel Malta*, Leipzig, 1902, p. 31), the *paterfamilias*, at the festival of the Lemuria, purchased deliverance from the attacks of the spirits of the dead (Ovid, *Fasti*, v. 438: 'his redimo meque meosque fabis'). In the ceremony of the Compitalia, therefore, the essential element was the offering of a vicarious gift to the Lares—who need not, however, be regarded on that account as ancestral spirits; the suspending of the sacrificial objects is not a residuum of a primitive practice of sacrificing men, but simply an indication that the gift now belongs to the recipient. The votive images were, in fact, suspended in the chapels of the Lares for the same reason as the shepherd suspends his dedicated flute from the sacred tree. What is true of the Compitalia holds good with respect to other two customs which have also been interpreted as cases of commuted human sacrifice. At the Saturnalia, people might buy clay figures (*sigilla, sigillaria*; Wissowa, *op. cit.* 206), 'quæ homines pro se atque suis piaculum pro Dite Saturno facerent' (Macr. *Sat.* i. 11. 49); and at the Volcanalia the Romans observed the custom of throwing living fishes into the fire (Wissowa, 229), likewise 'pro se' (Varro, *de Ling. Lat.* vi. 20; Fest. 238; on the connexion of the fish with the belief in the soul, cf. F. Böhm, *de Symbolis*

Pythagoreis, Berlin, 1905, p. 19). These two were vicarious gifts, and do not imply an ancient practice of human sacrifice.

The custom of the *Caterva*, again, has been connected by H. Usener (*Kleine Schriften*, iv. [Leipzig and Berlin, 1913] 252) with commuted human sacrifice. 'Caterva' was the name given to regular encounters between two quarters of the city (Usener, 435), and the blood spilt in them is supposed by Usener to have been a surrogate for a primitive practice of immolating men. But here, too, another interpretation lies closer to our hands. The best-known instance of these conflicts is the annual battle between the Subura and the Via Sacra for possession of the skull of a horse that was sacrificed on the 15th of October (Festus, 178); the real purpose of the fight was to secure for a particular community a sacred object and the benefits associated with it. Other divisional battles, similarly, would be contests for possession of a sacred object; and here and there these conflicts were still kept up, even when a change in religious observance had deprived them of their proper motive.

On the other hand, it is probable that among the Romans the death penalty was originally an expiatory sacrifice performed with due ceremony. Plutarch (*Rom.* 22) makes mention of an old law enjoining τὸν ἀποδόμνον γυναῖκα θύεσθαι χθονίοις θεοῖς. The vestal virgin who had broken her vow of chastity was buried alive; the Pontifex Maximus accompanied her to the side of the grave, and uttered special prayers (Plut. *Numa*, 10); here we have a ritual sacrifice of the offender to the deity. The harvest-thief 'Cereri necatur' (Pliny, *HN* xviii. 12). In later times, again, the sentence upon the criminal involved also his deliverance to the offended deity (Festus, 318: 'homo sacer is est quem populus iudicavit ob maleficium'; cf. also 'consecratio capitis' [Cic. *pro Balbo*, 33]; and the penal formula, 'sacer esto,' as, e.g., in Festus, 33, and Serv. *Æn.* vi. 609). Wissowa (*op. cit.* 388 f.) is of opinion that at first the State simply delivered this judgment, and left the transgressor to the vengeance of the deity, and that the law itself administered the actual penalty only in later times; in which case, of course, the penalty would have no connexion with human sacrifice. But it seems to the present writer—and it is also Mommsen's view (*Röm. Strafrecht*, Leipzig, 1899, p. 900 ff.)—more likely that the public execution of the death penalty is old, and implies a sacrifice. No one would venture to kill a creature which had become the property of a deity by *consecratio*, unless he thought that he was thereby conveying it to its possessor. But, if the State conveys a living creature to a god by killing it, it performs virtually an act of sacrifice. Wissowa's objection that the sacrificial object must be without blemish—as an offender, of course, could not be—applies not to the expiatory, but only to the propitiatory, sacrifice; nor, indeed, does it apply everywhere even to the latter, for we find that the Greeks offered criminals in propitiatory sacrifice (Samter, *loc. cit.* 375; A. Thomson, *ARW* ix. [1906] 400).

A survival of human sacrifice among the Romans has also been found, and in all probability rightly, in the *Ver sacrum*. Like other Italian peoples, as, e.g., the Sabines (Strabo, v. 250) and the Rutuli (Serv. *Æn.* vii. 796), in times of great distress, the Romans, when at war with Hannibal, sought to procure a happy deliverance from trouble by promising to a deity all the domestic animals born in a single spring (Livy, xxii. 9. 7 ff., xxxiii. 44. 1, xxxiv. 44. 1), and these were then duly sacrificed in fulfilment of the pledge. The form of the Italic *Ver sacrum* which, as we thus learn, obtained among the Romans was not the most ancient form.

Originally the dedication embraced also the human progeny; the children were allowed to grow up, and were then driven beyond the confines of their country (Strabo, *loc. cit.*; Festus, 321; Dion. Hal. *Ant. Rom.* i. 16). The ancients themselves interpreted this act of banishment as a mitigated form of the older practice of immolation (Paul.-Fest. 379)—a view rejected by Wissowa (p. 420. 5), who says: 'This expulsion or abandonment is rather the recognized method of performing the *consecratio* of living beings'; and he refers to Suet. *Cæs.* 81, where he finds an instance corroborative of his opinion. The passage in question, however, merely shows that the *consecratio* of the living likewise prevailed in later times; it was not the natural form, else the Romans would have availed themselves of it in the *Ver sacrum* as well (Samter, *loc. cit.* 378). We must rather assume that originally, as the vow was a unity, so its fulfilment was also uniform. Originally, that is to say, human beings and animals alike were either sacrificed or else expelled from the country. But, as in the ritual of blood-offerings the tendency is usually towards a mitigation rather than towards an intensification of their severity (E. Mogk, *ASG* xxvii. [1909] 605), we must regard the immolation of human beings (as of other creatures) as the primordial form; and it was, therefore, probably in this form that the Romans observed the general practice of Italic tribes in ancient times. We cannot, indeed, trace the observance of the Sacred Spring in Rome before 217 B.C.; nevertheless, it is possible that about that time the Romans adopted it from their neighbours as something out of the common (it was settled after consulting the *Sibylline Books* [Livy, xxii. 9. 8]), and at once modified it to suit their own circumstances.

In any case, it is attested by other data that the fundamental idea of propitiatory sacrifice—'unum pro multis dabitur caput'—prevailed among the Romans of the earlier age. The present writer would certainly not lay much stress upon the testimony of Livy, iv. 12. 11, according to which large numbers of people, with heads veiled, threw themselves into the Tiber during a time of famine; perhaps they did so without, as Stoll supposes (Roscher, i. 499), thinking of their act as a propitiation, and simply committed suicide in sheer despair. The case of M. Curtius (362 B.C.; cf. F. Münzer, art. 'Curtius,' no. 7, in Pauly-Wissowa), however, is a different one. When a chasm had opened in the Forum, and was to be filled up only by receiving the most precious treasure of Rome, Curtius presented himself on horseback and in full armour, and, having prayed ('manus . . . ad deos manes porrigentem se devovisse' [Livy, vii. 6. 4]), leaped into the abyss. This is unmistakably a propitiation, designed to avert the wrath of the gods, which had manifested itself in the *portentum* of the chasm, but it differs from human sacrifice in the fact of its having been a voluntary act. That in ancient times a human being was ever sacrificed to the gods by the Roman State on like grounds but *against his own will* is possible, but is incapable of proof.

Livy, in applying the word *devovere* to the sacrificial death of Curtius, shows us that he construed it as a *devotio* (Wissowa, 384 f.; Bouché-Leclercq, in Daremberg-Saglio, ii. 113 ff.; and esp. L. Deubner, in *ARW* viii. [1905], Beiheft, 66 ff., 79). Now the Roman general, in the stress of battle, 'devoted' himself, or else—what seems to be a commutation—a legionary (Livy, viii. 10. 11), to the gods in order to induce them to destroy the enemy's army. Deubner recognizes that the essential implication of this act was the devoting of the hostile army to the deities of the under world, the act being rendered all the more effective by the

fact that the *devotio* involved the sacrifice of the general himself; by his prayer he linked the enemy with his own fate, so that, if he fell, the enemy would share his doom. But the general, in thus offering his own person, really proceeded upon the same motive as actuated M. Curtius. Hence the idea which gave rise to human sacrifice operates here too; even the religious form is not wanting—the rubric of the *devotio* is given by Livy (viii. 9. 4 ff.; on his sources, cf. E. Kornemann, *Der Priestercodez in der Regia*, Tübingen, 1912, p. 23 ff.). Nevertheless, the sacrifice in this case too is quite voluntary, and there is nothing to warrant the hypothesis that at an earlier period the general was actually sacrificed by priests. In the case where a legionary was devoted, and did not fall in battle, he was required to bury a figure in the earth (Livy, viii. 10. 11); and here again the image serves as a substitute for the living man (Deubner, *loc. cit.* 81). This substitution may have been allowed even when the custom of devoting a legionary was first introduced; certainly that custom seems to be of later origin than the *devotio* of the general (see above), so that it is not necessary to assume that originally the legionary was ever actually sacrificed at all.

Thus the *Ver sacrum* and the death-penalty seem to indicate that human sacrifice had a place in the primitive Roman religion, while the *devotio* shows that self-immolation was not unknown in it. But, apart from such national institutions, we find in Rome actual cases of human sacrifice—or of indubitable substitutes therefor—only in so far as they had been introduced under foreign influence. These cases, moreover, are so numerous that we can hardly help thinking that the practice could never have gained so firm a footing if it had been radically obnoxious to Roman sentiment.

The first people known to have exercised a vast influence upon the religious rites of the Romans were the Etruscans. It was that people who furnished the Romans with, *inter alia*, the art of divining by lightning in a highly developed form (C. O. Thulin, *Die etruskische Disciplin*, i. *Blitzlehre*, Göteborg [Göteborg. Högs. Aarsk. xi., 1906], esp. p. 99). Now, Plutarch (*Numa*, 15) speaks of a Roman propitiation of lightning, which was performed with onions, hair, and fishes, and which both he and Ovid (*Fasti*, iii. 333 ff.) interpret as a commuted human sacrifice. It is natural to suppose that this rite, together with other details of divination by lightning, was borrowed from the Etruscans. Then, again, in the triumphs of Roman generals, it was customary to put to death the captured commanders of the enemy (Cic. *Verr.* v. 77). This practice is regarded by G. Beseler (*Hermes*, xlv. [1909] 352) as originally a human sacrifice: the victorious general, on his return home, sacrifices the best thing among his spoils. Beseler also suggests that the triumph itself, as an institution, may possibly have been derived from the Etruscans (cf. Aust, in Roscher, ii. 633). From Etruria also, according to Nicolaus of Damascus (*Ath.* iv. 153 f., in *FHG* iii. 417), came the gladiatorial shows (Preller, *Röm. Mythologie*, ii.², Berlin, 1883, p. 97), which Varro (*ap. Serv. Æn.* iii. 67; cf. Wissowa, *op. cit.* 466, n. 3) believed to be commutations of human sacrifice. Originally the departed were supposed to need attendance in the other world; hence Achilles slew twelve Trojan youths at the funeral pyre of Patroclus (*Il.* xxiii. 175). A later age substituted combat for slaughter, and thus at the same time did something to gratify the popular liking for funeral processions. Gladiatorial shows on a large scale were first celebrated in Rome in 264 B.C. (Val. Max. ii. 4. 7; Wissowa, *loc. cit.*).

But the Etruscan influence upon the Romans

was less profound than the influence of the Greeks. Plutarch (*Rom.* 21) states that at the festival of the Lupercalia it was the custom to streak the brows of two youths with blood-covered knives, and then to wipe them with wool, the youths being required thereupon to laugh. In this act of streaking the brow with blood many scholars have recognized a residuum of an ancient Roman practice of human sacrifice. But it will be better not to lay stress upon this. Deubner (*ARW* xiii. [1910] 502) recognizes here a cathartic custom of Greek origin. To a Greek source is certainly to be assigned the ceremony of the *Argei*, of which Wissowa, following Diels (*Sibyllinische Blätter*, Berlin, 1890, p. 43 f.), has given the right explanation (Pauly-Wissowa, ii. 697 f.). Every year, on the 14th of May (Ovid, *Fasti*, v. 621), twenty-seven human-like figures, constructed of bulrushes, were thrown into the Tiber from the *Pons sublicius* (Varro, *de Ling. Lat.* vii. 44) with religious ceremonies at which the Pontifices, the Vestal Virgins (Dion. Hal. i. 38), and the Flaminica Dialis (Gell. *Noct. Att.* x. 15. 30; Samter, 377) were present. *Argei*, the name given to these figures, is the Gr. *Ἀργεῖοι*. This term, which in Greek is found only in the epic poets, was certainly introduced into the Roman religion from Greek oracular verse. In the sore stress of war the oracle guaranteed relief on condition that twenty-seven of the enemy's people—the number has chthonic associations (Diels, 39 ff.)—were cast into the river. In the language of the oracle the Roman was designated 'Troianus'; the enemy, 'Argivus' (Diels, 44, note). Probably the condition laid down by the oracle was fulfilled on the first occasion by an actual immolation of human beings, but thereafter in the milder form of an offering of bulrush figures (Wissowa, in Pauly-Wissowa, ii. 700). On the assumption that the ceremony was derived from Greek ideas, the participation of the Roman priesthood certainly strikes us as strange. We may perhaps suppose that the guild of bridge-builders, the Pontifices, were in reality performing expiations for the observance of a foreign rite at the *Pons sublicius*, which was under their charge, and that in these they associated with themselves the Vestal Virgins and the Flaminica—unless, indeed, the ceremony was originally a Roman festival upon which the *Græcus ritus* was subsequently grafted (Deubner, *ARW* xiv. [1911] 306).

With the *Argei* sacrifice learned men of antiquity associated a Roman proverbial phrase, viz. *sexagenarius de ponte*. Festus refers to this in a passage (p. 334), the lacunæ of which are filled up with certainty: 'Sexagenarios (de ponte olim deieciabant), cuius causam Manilius hanc refert, quod Romam qui incoluerint (primi Aborigines, aliquem hominem, sexaginta annorum qui esset, immolare) Diti Patri quotannis soliti fuerint'; this sacrifice, he says, was subsequently changed by Hercules into that of throwing bulrush figures from the bridge (cf. also Ovid, *Fasti*, v. 623 f.; Otto, *Sprichwörter d. Römer*, Leipzig, 1890, p. 320 f.). Varro (*ap. Non.* p. 842 [Lindsay]) gives a different explanation, asserting that the old men, who were no longer allowed to vote in public assemblies, were summoned by this old proverb to abandon the *pons* ('voting-bridge'). But this cannot be the true explanation, as it does not accord with what we know otherwise of voting among the Romans (Mommsen, *Röm. Staatsrecht*, Leipzig, 1899, ii. 408). We must therefore assume that the proverb points to an ancient custom of throwing people from the bridge. Nevertheless, this cannot be regarded as human sacrifice; it was in reality a secular act of doing away with burdensome old people whom the State would no longer maintain (B. Schmidt, 'Der Selbstmord d. Greise von Keos,' in *Neue Jahrb. f. d. klass. Altert.* vi. [1903] 617 ff.). It is quite probable that the Romans of primitive times treated the aged in this harsh way; thus, on the advance of the Gauls, they left their old people behind them without means of self-defence—it was only in later writings that these old people were said to have remained behind of their own accord (Livy, v. 41. 1). Viewing the matter purely by itself, we might think that the Romans would be willing enough to sacrifice the aged as *Argei* by throwing them from the bridge. But the aged, after all, were Romans, not *Argei*; and W. Warde Fowler (*The Roman Festivals*, 116 f.) rightly says that the occasional killing of an individual could not well develop into the annual practice of putting considerable numbers to death. What we have in the case of the *Sexagenarii* is there

fore a secular act of dispatching them on grounds of public utility. We have an exactly similar case in the slaying of the *Rex Nemorensis*, and this likewise was not a human sacrifice. A run-away slave might save himself from his pursuers by killing the priest of Diana of Nemi. He assumed the position of priest, and held it till he met a like fate at the hands of another fugitive (Strabo, v. 239). This is an instance of a practice found among many peoples; they kill their king or priest before he becomes sick or feeble, believing that the welfare of the tribe is dependent upon his remaining strong. They appoint betimes a vigorous successor, who at once displays his strength by overthrowing the man whose place he takes (Frazer, *GB*, pt. iii, 'Dying God,' London, 1911, p. 141 ff.).

With the sacrifice of Argive enemies, however, it is probably correct to associate the rite of burying alive a man and a woman belonging to a hostile nation (Wissowa, 421). In 216 B.C.—the most trying period of the war with Hannibal—Livy (xxii. 57. 6) informs us that 'ex fatalibus libris sacrificia aliquot extraordinaria facta: inter quae Gallus et Galla, Graecus et Graeca in foro bovario sub terra vivi demissi sunt in locum saxo consaeptum, iam ante hostiis humanis . . . imbutum.' The *Sibylline Books* (Plut. *Marc. 3, Quæst. Rom.* 83), that is to say, prescribed at that juncture special means of allaying the anger of the gods, among these means being the previously tried expedient of burying a man and a woman of the enemy's people. The strict rule was evidently that the two victims should belong to the nationality with which the Romans were actually at war at the time (Pliny, *HN* xxviii. 12: 'gentium cum quibus tum res esset'). Now the hostile peoples had at one time been the Greeks and the Gauls, and subjects of these nationalities, by an erroneous conservatism, were sacrificed also during the war with Carthage (Diels, 85 ff.). That this custom was suggested by Greek oracular writings is shown also by the fact that the prescribed prayers were uttered by the president of the *Quindecimviri* (Pliny, *loc. cit.*), whose principal function was to guard the *Libri Sibyllini*. The import of the rite was that of a sacrifice to the gods, who thus received the life of a man and a woman as *pars pro toto*; with the lives of the two victims the lives of all the men and women of the same tribe were magically bound up ('obligamentum magicum,' Orosius, iv. 13. 4); and, if the gods accepted the one pair, the rest of the nation would necessarily follow them. Pliny indicates that he had himself witnessed a sacrifice of this kind ('etiam nostra aetas vidit')—'in the vicarious ceremony,' says Wissowa (421); but the present writer is not certain as to the latter point, as the Emperor Aurelian (see *Vita Hist. Aug.* 20), when organizing the consultation of the *Sibylline Books*, ordered 'cuiuslibet gentis captos' to be reserved for sacrifice in case of need.

Finally, in the reign of Augustus, another foreign people, the Iberians, introduced into Rome a new type of human sacrifice, viz. a *devotio*. Dio Cassius (liii. 20) states that S. Pacuvius consecrated himself to Augustus in the manner of the Iberians (cf. Val. Max. ii. 6. 11). This clearly means that the tribune, invoking the gods, vowed that, if they demanded the life of the Emperor, they should take his instead. Vows of this kind are met with also in later times. When the Emperor Caligula was sick (Suet. *Cal.* 27; Dio Cass. lix. 8; Bouché-Leclercq, *loc. cit.* 119), two Romans pledged themselves to die that thereby the Emperor might recover; and the latter took them at their word. The *devotio* on the Emperor's behalf is mentioned also by Fronto, p. 6 (Naber).

These last-mentioned examples show that outside the official religion of Rome the idea of human sacrifice was very powerful in private circles. How far the persons concerned were influenced by conceptions inherited from ancient Roman life, or by foreign ideas, or were actuated by their own thoughts, is in most cases difficult to decide.

The most outstanding instances may be briefly indicated as follows (cf. v. Lasaulx, *Studien d. classischen Altertums*, Regensburg, 1854, p. 248 ff.). Those who took part in the conspiracy of Catiline are said to have drunk the blood of a slain man mixed with wine (Sall. *Cat.* 22), and to have bound themselves by dreadful oaths; this action was already classed among human sacrifices by Minucius Felix (30. 5). In 46 B.C., Cæsar, as a penalty for mutiny, caused two soldiers to be sacrificed in the Campus Martius by the priest of Mars (Dio Cass. xliii. 24), evidently in the belief that that god, who had been roused to anger by the mutiny, would be propitiated by the oblation. S. Pompeius threw men into the sea, doubtless as an offering to Poseidon (*ib.* xlvi. 48). In 41 B.C., on the Ides of March (Suet. *Aug.* 15), Octavian is reported to have sacrificed three hundred men at the altar of the Divus Julius (*εὐθύνας*, Dio Cass. xlvi. 14), his intention being to propitiate the *manes* of the murdered dictator. Perhaps Vergil, when speaking of the captives 'quos mitteret umbris inferias' (*Æn.* xi. 81), had this sacrifice in his mind; in other passages he certainly creates ancient precedents for the religious acts of Augustus. In a time of threatened calamity, Nero consulted his astrologers, and received the response: 'solere reges talia ostenta caede aliqua illustri expiare' (Suet. *Nero*, 36). This was probably a notion of Eastern origin, and such an Oriental superstition explains also the self-immolation of Antinous on Hadrian's behalf (Dio Cass. lxxix. 11; cf. art. HEROES AND HERO-GODS [Egyp.], p. 651^b). The Emperor Commodus put a man to death in the worship of Mithra (*Vita Hist. Aug.* 9); but the fact that this action is spoken of as an enormity shows that the records of habitual human sacrifices by the priests of Mithra are false (F. Cumont, *Textes et monuments relatifs aux mystères de Mithra*, Brussels, 1899, i. 69). Particularly in the practice of magic, which prevailed widely in the Imperial period—a period profoundly affected by Oriental superstition (Pliny *HN* xxx. 16)—human beings were frequently put to death, either because the bodily parts of men were believed to be peculiarly potent, or because—what specially concerns us here—the spirits of the under world would not give their aid unless they received a human being in sacrifice. It is not always easy to say which of these two motives prompted the killing of men in this connexion. The best-known source of information regarding the practice is Horace's poem *Canidia* (*Æp.* 5). Cicero (*in Vatin.* 14) charges Vatinus with the crime 'inferorum animas elicere, puerorum extis deos manes mactare.' Didius Julianus sacrificed children in order to learn the future (Dio Cass. lxxiii. 16), and Elagabalus 'slew children and practised magic' (*ib.* lxxix. 11).

These numerous instances of human sacrifice in the non-official religious sphere explain why the laws, the Senate, and the more humane Emperors frequently made a stand against the practice. Pliny (*HN* xxx. 12 f.) refers to a *senatusconsultum* of 97 B.C. directed against it, and to the injunction by which Tiberius prohibited the immolations of the Druids. Tiberius also forbade the sacrifice of human beings in the worship of Saturn in Africa (Tert. *Apol.* 9). Claudius re-enacted the decree against the Druids (Suet. *Claud.* 25), and Hadrian put an end to human sacrifice in the cult of the Cyprian Juppiter (Lact. *Inst.* i. 21. 1; Wissowa, 85). The jurist Paulus (v. 23. 16) writes: 'qui hominem immolaverint exve eius sanguine litaverint, fanum templumve polluerint, bestiis obiciuntur, vel, si honestiores sint, capite puniuntur' (cf. Mommsen, *Strafrecht*, 639 ff.).

We may sum up our investigation as follows. The primitive ideas which underlie the practice of

human sacrifice obtained also among the Romans, as appears, above all, from the *devotio*. In particular cases the Romans of an earlier age seem to have deduced from these ideas certain consequences affecting their religious ritual, as is indicated by the *Ver sacrum* and the religious formula of capital punishment. On practical grounds or from motives of humanity, however, human sacrifice was abolished from the official religion at an early stage. Under foreign influences, and especially under the influence of the *Sibylline Oracles*, it again gained a footing. It survived in sacrificial transactions outside the State religion till the close of the Imperial period, and legal measures did not succeed in entirely abolishing it.

LITERATURE.—See the authorities cited in the article. The older literature is given in J. Beckers, *De Hostiis humanis apud Graecos*, Münster, 1867, p. 2; W. Warde Fowler, *The Roman Festivals*, London, 1899, p. 116, note 3; and J. Toutain, 'Sacrificium,' in Daremberg-Saglio, iv. 2. 976. The most recent works are cited in G. Wissowa, *Religion u. Kultus d. Römer*², Munich, 1912, at the passages noted in the Index, p. 607, under 'Menschenopfer.' See also J. S. Reid, 'Human Sacrifices at Rome,' *Journ. of Roman Studies*, ii. [1912] 34.

R. WÜNSCH.

HUMAN SACRIFICE (Semitic).—The discussion of this subject falls naturally into two parts: (1) a marshalling of the evidence for the existence of the rite, and (2) an attempt to deduce the purposes and ideas underlying it.

I. EVIDENCE FOR THE EXISTENCE OF SEMITIC HUMAN SACRIFICE.—1. **Egypt.**—That the Egyptians were an offshoot from the original Semitic stock, separated from the parent stem in early pre-historic times, is a favoured theory of their origin (see, e.g., G. A. Barton, *Semitic Origins*, London, 1902, where the theory is well worked out). They are, therefore, naturally to be included in an analysis of the evidence on the subject. But it should not be forgotten that in any case the cleavage of the Egyptians from the rest of the Semitic family must have taken place at a date so remote that the existence of the rite of human sacrifice among them in common with the Semites proper does not necessarily prove its existence in the primeval times before the Egyptian secession. It might have developed in Egypt independently, or under the influence of the ideas and practices of later surrounding tribes.

The existence of human sacrifices among the Egyptians has often been denied (E. Meyer, *Gesch. des alten Ägyptens*, Berlin, 1887, p. 42, denies the evidence from native documents, while admitting the possibility of the Classical testimony being founded on true traditions; see also Dillmann, *Handb. der AT Theol.*, Leipzig, 1895, p. 98). But the testimony of certain Greek and Latin authors, based apparently on tradition, and corroborated by obscure passages in certain Egyptian writings and by scenes represented in tomb wall-paintings, seems to indicate that this practice was observed, at least in a modified or symbolic form, down to late historic times.

Thus, Diodorus Siculus (i. 88) speaks of the king of Egypt as having formerly sacrificed men of red colour—the colour of Set or Typhon—at the grave of Osiris; and he adds the important detail that, as red men were rare in Egypt, the victims were always foreigners. Manetho (*ap.* Porphyrius, ed. Müller, *FHG* ii. 615, no. 83) speaks of human sacrifices to Hera in Heliopolis, and of the modification of the rite by Amosis, who substituted waxen images for the victims. From another fragment (*ib.* ii. 616, no. 84) it appears that in these or similar sacrifices the victims were 'Typhonic' (= red) men, and were burnt alive; that the sacrifices took place in the dog-days, and were therefore probably prophylactic against drought or pestilence; and that the ashes of the victims were collected and scattered

against the wind. Procopius (*de Bell. Pers.* i. 19) states that in the temple of Philæ the Blemmyes offered human victims to the sun. Ruffinus (*HE* ii. 24) relates, with horror, that in the holy place, or *adytum*, of the temple of Serapis at Alexandria there were preserved the heads of infants with the lips gilded. Seleucus is said by Athenæus to have written a book which treated of the subject (*περί τῆς παρ' Αἰγυπτίων ἀνθρωποθυσίας*, Müller, iii. 500, footnote). On the other hand, Herodotus (ii. 45) denies the existence of the practice in Egyptian religion; but that intelligent tourist reports only what his 'dragomans' thought fit to tell him, and his evidence on a subject which necessarily belongs to the *arcana* of religion is therefore not conclusive. Besides these ritual sacrifices, there is evidence for foundation sacrifices, modified, after the primitive period, by the substitution of an animal victim (see Lefébure, 'Rites égyptiens,' in *Publications de l'école des lettres d'Alger*, 1890, pp. 4, 19, 36), and, further, the special circumstances of Egypt, dependent for its life on the Nile inundations, demanded a Nile sacrifice, which the Arab historian Murtadhā describes as lasting down to the Muslim occupation of Egypt (A.D. 642)—a young girl being annually cast into the river to ensure a sufficient rise in the water (Eng. tr., 1672, p. 143). A survival of this custom is described by E. W. Lane (*Manners and Customs of the Modern Egyptians*⁵, London, 1860, ch. xxvi.). A conical pillar of earth was erected in front of the dam at Cairo, and sown with millet. It was called 'arūsah' ('bride'), and no doubt represented the human victim of the original rite.

It is not to be expected that the native Egyptian monuments themselves should necessarily corroborate these statements of the Classical writers, even if the latter be strictly trustworthy. For, in general, the native is not so likely to record facts and practices which for him are commonplace as is the foreigner to whom they are less familiar. But some passages in inscriptions and some pictured scenes have been collected, which appear to show that the statements quoted are at any rate approximately correct. Amon-Hotep II., returning from his expedition to Syria, clubbed seven of his chief captives before the god Amon (see E. Naville, *The Old Egyp. Faith*, Eng. tr., 1909, p. 299). In the inscription on the tomb of Seti I. (*ib.* p. 298) the tale is told of the attempt of men to revolt against the sovereignty of Rā; of the resolution in the assembly of the gods to destroy the human race; of the partial carrying out of this resolve by Hathor; of the appeasement of the wrath of Rā by a draught mixed with human blood; and of his resolve to substitute animal for human sacrifice in the future. Some such substitution is perhaps hinted at in the dark saying of the *Book of the Dead* (ch. xviii.):

'When the fiends of Set come and change themselves into beasts, the great sovereign princes, on the festival of the breaking and turning up of the earth in Taṭtu [Busiris], slay them in the presence of the gods therein, and their blood floweth among them as they are smitten down.'

This seems to refer to a ploughing festival, wherein the 'Typhonic men' of the Classical writers were replaced by animals.

Among scenes on Egyptian monuments suggestive of human sacrifice, the memorial of Mentuherhepesef (Maspero, in *Mém. de la mission archéol. française au Caire*, v. [1893] 435) has an important place. One of the scenes in this tomb represents a person called a *tekennu*, dragged face downwards on a sledge; another shows the (fictitious) strangling of this person. A fictitious sacrifice, of course, implies an actual sacrifice in an earlier age.

2. Babylonia and Assyria.—If traces of human sacrifice are obscure and ambiguous in Egypt, they are yet more so in the remains of the civilization of Mesopotamia. This is surprising, for people

with a highly developed pantheon and a complex ritual system, and notoriously ferocious in warfare, might be expected to include human sacrifices among their regular religious practices. A bilingual text (IV. Rawl. 26, no. 6) directing that 'the father shall give the life of his child for the sins of his own life, the head of his child for his own head,' and so forth, would certainly be a proof of the existence of vicarious human sacrifice if the translation were sound; but, according to Zimmern (*KAT*³, 1903, p. 597) and Jeremias (*AT im Lichte des alt. Orients*², Leipzig, 1906, p. 368), the word rendered 'child' should properly be translated 'lamb.' Another obscure inscription (III. Rawl. 61) contains a passage which has been rendered 'the son is burnt on the high places' [when the crops fail], but it seems more probably to mean 'the grain [of a certain species] is burnt in the heat of the sun.'

Less questionable evidence, however, is not wanting. The first comes from that most important chapter 2 K 17, which describes the practices of the deported tribes which were substituted for the captive Israelites. There (v.²¹) the Sepharvites (apparently the people of Sippar) are stated to have burnt their children in the fire to Adrammelech and Anammelech, the gods of Sepharvaim [= *Adar-Malik* (cf. Adrammelech, the name of Sennacherib's parricide son, 2 K 19³⁷) and *Anu-Malik*]. This rite obviously was carried by the Sepharvites from their old to their new home; and if, as seems to be most probable, these were really the men of Sippar, then such sacrifices must have taken place in the town of Sippar. The chief god of Sippar was Samaš, the sun, who was also called *Amna*; it is interesting that Cod. A of the LXX in this passage presents the form Ἀμνημελέχ. A human sacrifice seems to be actually figured in a seal published by Ball (*PSBA* xiv. [1892] 149, where the passages already quoted are discussed). In this scene the following figures are represented: (1) a priest standing, holding a sceptre in both hands, facing (2) a divinity, standing on the top of a *ziggurat*, and holding in his right hand a curved sword, in his left a sceptre. Flames burst from his shoulders; behind him is an altar, with vegetable offerings upon it. (3) Behind the divinity are two standing figures, clothed in leopard skins, with their right arms raised in the attitude of striking. Between them is (4) a kneeling man, wearing only a loin-cloth and a head-dress. Above him is a representation of flames, and flying towards him is a bird of prey. One of the standing skin-clad figures holds back his head, and the other pulls aside his beard, as though to expose his throat conveniently for the sacrificial blow.

Less certain evidence is the prescription that a son or a daughter shall be burnt on the altar of a divinity as a penalty for a breach of contract (Johns, *Assyr. Deeds*, Cambridge, 1898-1901, iii. 345), which may simply be a penal provision; and such passages as 'I burnt their boys and girls in the fire,' in Assurnasir-pal's triumphal inscriptions over conquered cities, which merely record a barbarity consonant with the rest of the acts of that abominable savage. There is, however, a magical text (quoted in Zimmern, *KAT*³, 599) which mentions the sacrifice of a slave along with an ox or a sheep.

3. Canaan. — Here we are on firmer ground. The practice of human sacrifice in the religion of the Semitic predecessors of the Hebrews is amply proved by certain OT passages (Dt 12³¹ 18¹⁰, and by inference in such prohibitions as Lv 18²¹), and has been corroborated by the results of recent excavations. In the High Place at Gezer, and in connexion with what appears to have been a rock-cut altar at Taanach, the skeletons of new-born infants have been found buried in jars. Similar discoveries

were made in the corners of houses, under or close by the foundation. Two burnt skeletons of children about six years of age were also found in the Gezer sanctuary, and near it was a cistern which had apparently been adapted as a receptacle for the refuse of sacrifices. Large numbers of animal bones, and many human bones of both sexes and all ages, were found in it. The excavator at Gezer was careful to get an expert medical opinion that some at least of the infants found buried had actually lived a separate existence, and that they were not merely still-born or untimely births thus disposed of (with or without the recondite notions of inducing a re-birth and second chance of life, as suggested in Frazer, *Adonis, Attis, Osiris*², London, 1907, p. 83).¹ At Tell Mutesellim (Megiddo) a girl of about fifteen had been slaughtered at the foundation of a large building, and her skeleton was found built into the wall. In two cases at Gezer the skeletons of young persons (a youth about eighteen, and a girl a year or two younger) were found, which had evidently been sawn in two. There was nothing to indicate clearly the circumstances under which so exceptional a form of execution had been adopted.

4. Arab tribes, ancient and modern. — Under this head we include the various tribes of the trans-Jordanic provinces, the Sinaitic peninsula, and North Arabia—known as the Midianites, Ammonites, Moabites, etc.—as well as the Arabs before they adopted the teaching of Muhammad. These tribes were all so closely related that evidence of the practice under discussion among one or two will probably be sufficient proof of its prevalence among them all. Direct evidence is afforded by the incident of the sacrifice of Meshah, who immolated his heir to Chemōsh, when hard pressed by the Israelites (2 K 3²⁷)—an act which seems to have struck terror into the victors, who fled from the wrath of Chemōsh whose land they were invading. Wellhausen (*Reste arab. Heidentums*², Berlin, 1897, pp. 42, 43, 115) and other scholars have collected the indications of human sacrifice which remain among the Arabs, in spite of the efforts of post-Islamic authors and copyists to efface the traces of the rites and beliefs of the 'times of ignorance.' These show clearly that the Arabs offered prisoners of war to the stellar and other divinities, and also sacrificed boys to Dusares and al-'Uzzā, the morning star. The best-known example is that related by Nilus (*Narrat.* vi.) of his own son Theodulus, who narrowly escaped being a victim. He was stolen by the Saracens, c. A.D. 400, and was to have been sacrificed to the planet. The ritual time for the offering lay between the appearance of Venus above the horizon and her disappearance in the rays of the rising sun. In answer to the boy's prayer, his captors overslept, and the time had already passed when they awoke; he was therefore brought instead to the slave-market of Elusa, of which place he lived to become bishop.

5. Hebrews. — This member of the Semitic family was no less prone than the rest to human sacrifices, and required the special instruction of lawgivers and prophets to eradicate the practice. Their great ancestor was moved to offer his son Isaac (Gn 22). Jephthah offered his daughter (Jg 11^{30ff.}) under circumstances differing only in detail from the case of Meshah—in the one the vow preceded, and the act followed, the victory; in the other the act itself was prior to the issue of the battle. The underlying ideas, however, were identical, and, notwithstanding all attempts to

¹ It is said that in some parts of Egypt untimely births are buried in the corners of the houses of the *fellahin*, not in the graveyard of the village. This may conceivably be a survival of the practice of immolating a child or other person at the foundation of a house, and laying the corner-stone on the body

explain away or to modify the Hebrew instance, there can be no reasonable doubt that it involved the death of the victim. Samuel 'hewed Agag in pieces before the Lord' (1 S 15³³), but this is a doubtful case, in view of his deprecation of Saul's intent to sacrifice immediately before (v. 22^x). It seems more probably to have been an act of judicial punishment (see Baethgen, *Beiträge*, Berlin, 1888, p. 221). Hiel re-built Jericho 'upon' two of his sons (1 K 16³⁴), i.e. sacrificed them at certain stages of the work, as we have seen to have been done at Megiddo and elsewhere. After the partition of the kingdom, the northern branch (2 K 17¹⁷) as well as the southern, especially under Ahaz (16³) and Manasseh (21⁶), sacrificed children in fire; by the time of Jeremiah a special place, the *Gē Ben-Hinnōm*, had been set aside especially for this rite. On the other hand, Isaiah (57⁵), Micah (6⁷), Jeremiah (19⁵), and Ezekiel (20³¹) added their fulminations to the direct prohibitions of Leviticus (18²¹) and other passages in the law of the Pentateuch. It does not fall within the scope of this article to discuss the question to what deity these various sacrifices were offered, or to inquire into the relationship between Jahweh and Molech (see *ERE* i. 390). The legitimate cases quoted above are sufficient to prove the existence of human sacrifices among the Hebrews, without calling in more doubtful instances, such as the murder of Abel (Gn 4), the death of Uzzah (2 S 6⁷), the massacre of the priests of Baal (1 K 18⁴⁰), and other events, where critics have traced ritual acts with more or less improbability.

6. Phœnicians and Carthaginians.—Here, as in the case of the Egyptians, we have to trust very largely to the testimony of Classical writers. Of the Phœnicians, who loomed so largely in the works of the antiquarian charlatans of a hundred years ago, we really know next to nothing; and the banal inscriptions of Carthage are not illuminating. Three or four Numidian votive tablets have been supposed to state that A has offered his son B, but neither reading nor interpretation can be considered trustworthy (see Gesenius, *Scripturæ linguæque Phœn. monumenta*, Leipzig, 1837, pp. 446 ff., 453: these inscriptions are not yet [1913] included in *CIS*). Eusebius, however (*Præp. Evang.* iv. 16), following Sanchuniathon (*apud Philo*), speaks of the Phœnicians offering their dearest to Kronos; and other writers ascribe the same custom to the Phœnician colonies of Cyprus, Carthage, and Massilia.

For Cyprus, see Euseb. *loc. cit.*; for Carthage, Porphyrius (*de Abst.* ii. 56), Diodorus Siculus (xx. 14), and Pliny (*HN* xxvi. v. 4); for Massilia, Servius (*in Æn.* iii. 57).

7. Southern Semites.—The Semitic-speaking people of Abyssinia appear to have been originally a colony from S. Arabia, and presumably carried with them from their former home all the rites of their religion, including that of which this article treats. No direct evidence, however, bearing on the subject is to be found in the unsatisfactory literature relating to that little known country.

II. *THE PURPOSE OF HUMAN SACRIFICE.*—Human sacrifice is the offering of a human individual to a divine power. It is generally understood to involve the slaughter of the victim, but that is not absolutely necessary; the life of a mediæval anchorite, walled up in a narrow cell, was sacrificed no less literally than was that of the son of Meshah. But in the Semitic world, with some exceptions and modifications presently to be noted, the victim was actually put to death. It is of the highest importance to distinguish true cases of sacrifice from the following acts, which are sometimes confused with them: (1) *murder* for political or criminal causes, such as the satisfaction of private grudge or greed; (2) *execution* of criminals and

prisoners of war; (3) *blood-revenge*; (4) *infanticide*, as organized among the Arab tribes; (5) *slaughter* for medical purposes, e.g. to procure the baths of children's blood supposed to cure leprosy (on which see Pliny, *HN* xxvi. i. 5). Biblical cases of the first three of these, all of which have been called 'sacrifices,' are the stories of Abel (Gn 4), Agag (1 S 15³³), and the sons of Saul (2 S 21). The last of these cannot have been a sacrifice in any case, as the victims were *hanged* (see Dt 21²³, and cf. the executions in Nu 25⁴, which have also been erroneously taken as a sacrifice). The fourth (on which see the gruesome 'Additional Note C' in W. R. Smith's *Kinship and Marriage*², London, 1903, p. 291 ff.) is merely a practical device to reduce the non-combatant members of a tribe.

In a true human sacrifice, the victim may be (a) a young infant, the first-born of the family; (b) a criminal or prisoner of war; or (c) a person of special importance in the eyes of the person or tribe offering the sacrifice. In the first case we have, in the majority of instances, a sacrifice of *primitiæ*, whereby the firstfruits of the field, of domestic animals, and of the human family were sacrificed to the deity. In the second case the victim has offended against the divine majesty, either by his crimes or by fighting against the people of the divinity; the god has triumphed over his enemies, and their blood is poured out before him in celebration of the triumph. The third case is rather different: the god has to be appeased by his own people; a calamity or plague has to be averted, or some such prize as victory in battle has to be obtained; the most valuable gift that the tribe can offer has, therefore, to be presented in payment for the boon; the king's eldest son must be offered as a burnt-offering that there may be 'great wrath' against his enemies (2 K 3²⁷).

By way of appendix to this article, two points must be considered briefly: (a) the modifications and substitutes offered for human sacrifices; and (b) the strange superstition, not yet wholly extinguished, that the mediæval Jews practised a form of ritual murder.

(a) *Modifications and substitutes for human sacrifice.*—Although, as the notorious case of the Aztecs shows, the practice of human sacrifice is not inconsistent with a high standard of culture, it is natural that the advance of civilization should develop a repugnance against the rite in its crudest form, and that various devices should be invented to satisfy the demands of the gods without actually taking life. There are four such devices that call for mention. (1) The *substitution of a model* of wax or straw, as we have already seen, was early introduced into Egypt. Small figures of men cut from laminæ of bronze and silver were found under the foundation of a house at Gezer, evidently representing actual human victims. The occasional cases of the sacrifice of vile, worthless, or crippled members of the community may also in a sense be a substitution for lives more valuable. Although the dogmatic statements of folk-lorists on such a point cannot be accepted without reserve, it is possible that some children's games (see *ERE* ii. 852^a) are the pale reflexion of rites that once involved the immolation of human victims. (2) By *redemption* the eldest son of the Hebrew family was rescued from the doom that doubtless was literally carried out at first (Ex 13¹³). (3) Probably *mutilation* and similar irreparable injuries—especially those involving the loss of male virility or female chastity—were devices to preserve life while sacrificing its joy. (4) *Substitutionary acts* were also performed, in which all semblance of the victim disappeared. Thus, under the foundations of many houses in Palestinian excavations have been discovered groups of lamps and bowls (usually

the lamp inside one bowl, with another bowl inverted over it), one case of which was found at Gezer associated with a sacrificed infant. It is highly probable that these deposits were typical of an earlier rite in which there was the slaughter of a victim.

(b) *Mediæval superstitions regarding the Jews.*—In the Middle Ages an extraordinary idea was prevalent that the Jews practised secret rites for which the blood of Christians, especially of Christian children, was essential. This wild notion was, and in some quarters has been in quite recent years, fostered by politically interested persons in order to inflame anti-Semitic passions. For the superstition there seems to be a certain basis of fact. The mutual hatred of Jew and Christian, and the oppressions of which the latter were guilty, would naturally lead to reprisals when opportunity offered for them; and we need not be surprised to find that such a reprisal should take the form of a grim parody of the Crucifixion, the event to which the Jews ascribed their misfortunes. Accordingly it appears that some drunken Jews at a feast—no doubt that of Purim—crucified a Christian child in the Syrian town Inmestar (Socrates, *HE* vii. 16) in A.D. 416. About 600 years later this seems to have been followed by the similar murder of St. William of Norwich. Other alleged cases followed thick and fast, especially in England and Germany; even so late as 1900 a mysterious murder in West Prussia was made the lever for an anti-Semitic demonstration.¹ All the recorded cases, from that of William of Norwich to the last mentioned, have been analyzed by H. L. Strack (*The Jew and Human Sacrifice*, Eng. tr., London, 1909 [cf. his art. ANTI-SEMITISM, in vol. i., esp. p. 597]), and the results of his investigation are: (1) as just mentioned, that there may have been individual cases of murder by Jews, but that these are a very small minority of the alleged examples recorded, and in any case were simply acts of revenge for personal or national wrongs; (2) that in no Jewish rite is human blood in any circumstance required or utilized; (3) that there may be a few cases of slaughter to procure blood for medicinal purposes, which, as we have already seen, must not be confused with sacrifice proper, but that there is no real evidence of this; (4) that in the vast majority of cases the Jews were simply made scapegoats for mysterious murders, or even sometimes for accidental deaths, the evidence being generally doubtful, and the so-called 'confessions' being extracted by torture.

LITERATURE.—In addition to the authorities cited in the body of this article, see D. Chwolson, *Die Ssabier und der Ssabismus*, Leipzig, 1856, vol. II. (references in index, s.v. 'Menschenopfer'); W. R. Smith, *Rel. Sem.*, London, 1894; M. J. Lagrange, *Études sur les religions sémit.*, Paris, 1905; G. F. Moore, 'Judges,' in *ICC*, 1896 (for the Jephthah incident); H. Vincent, *Canaan, d'après l'exploration récente*, Paris, 1907; C. Mommert, *Menschenopfer bei den alten Hebräern*, Leipzig, 1905, also *Der Ritualmord bei den Talmud-Juden*, Leipzig, 1905 (both rather wild); F. C. Movers, *Untersuch. über die Religion und die Gottheiten der Phönizier*, Berlin, 1841-56; R. A. S. Macalister, *The Excavation of Gezer*, London, 1912; G. Schumacher, *Tell el-Mutesellim*, Leipzig, 1908; E. Sellin, *Tell Ta'annek*, Vienna, 1904; E. Mader, 'Die Menschenopfer der alten Hebräer u. der benachbarten Völker,' in *Bardenheuer's Bibl. Studien*, xiv., Freiburg, 1909 (very useful, but references, etc., require verification).

R. A. S. MACALISTER.

HUMAN SACRIFICE (Slavic).—The Baltic Slavs were fanatics and sacrificed Christians to their gods. Every year a Christian was chosen by lot and offered to the god Svantovit in his temple (Helmold, *Chronica Slavorum*, Frankfurt, 1581, *passim*). The head of Bishop John of Mecklenburg was fixed on a lance and offered to the god Radigast (*ib.*). In Russia the so-called *Chronicle of Nestor*, under the year 983, i.e. a

short time before Vladimir's conversion to Christianity, tells that this prince sacrificed human victims to the gods. The lot fell upon the son of a Christian Vargue, who refused to give him up. The Russians forced an entrance into his house and slaughtered him and all his family.

L. LEGER.

HUMAN SACRIFICE (Teutonic).—What Cæsar says regarding human sacrifice among the Gauls (*de Bell. Gall.* vi. 16: 'homines immolant, . . . quod pro vita hominis nisi hominis vita reddatur, non posse aliter deorum immortalium numen placari arbitrantur, publiceque eiusdem generis habent instituta sacrificia') holds good also in the case of the Teutons. As late as the historical period, the latter people, when their own lives were imperilled, or when some threatened disaster was to be averted, offered human beings in sacrifice. They believed that the demons and gods who had a desire for human lives would be satisfied, or their anger appeased, by such immolations. The human victims of these rites were not as a rule fully privileged members of the particular community; they were prisoners of war, slaves, outlaws, or children under age. At times when the community had no such persons at its disposal, and, in particular, in military campaigns or expeditions by sea, the victims were selected by lot. Like all other sacrifices among the Teutons, human sacrifices were regulated by the principle *do ut des*. Either they were of a prophylactic character—and from this class sprang the periodic immolations of human lives—or they were performed in fulfilment of vows. They were offered to the demons who caused death, or to the man-stealing souls of the departed, or to the god of death and of the dead; sometimes, however, the sacrifice was paid to the god of war, as also to the deities of fruitfulness, who were to be thus induced to prevent failure of crops and consequent famine. In process of time human sacrifice was superseded by the sacrifice of animals, or of objects regarded as substitutes for human life.

According to Tacitus (*Germ.* 9), all the German tribes offered human sacrifices to Wodan-Mercury on certain days. These immolations, however, were accorded not to Wodan as the supreme god, but to Wodan as the god of death, and were designed to avert a wholesale loss of life. Thus from other references of Tacitus we learn that the Hermunduri, after their victory over the Chatti, offered human lives to the god of death and Mars-Tiu, the god of war (*Ann.* xiii. 57). This is confirmed by the Norse records. When King Aunn of Upsala was growing old, he sacrificed nine of his sons to Óðinn in order that his own life might be prolonged in return (*Heimskringla*, ed. F. Jónsson, Copenhagen, 1900, i. 45 f.). In the same way, according to the *Vikars Saga*, Óðinn bestowed upon his protégé, Starkad, a life of three human generations only on condition that Starkad should sacrifice King Vikar to him; and the god himself put into Starkad's hand the spear with which he was to slay the king (*Saxo Grammaticus*, i. 276). While these examples belong to the sphere of myth, yet they witness to the people's belief that Óðinn accepted life in exchange for life.

Death holds his harvest in time of war. Hence the Teutons immolated the lives of enemies, especially after a victory. The South Teutonic sources do not usually indicate to whom such sacrifices were offered. Thus, e.g., the women of the Cimbri, after a victory, sacrificed their captives (Strabo, vii. 2. 3); after the battle of Arausio (105 B.C.) the captured Romans were hanged upon trees (Orosius, *Hist.* v. 16); the Teutons of West Germany treated their prisoners in the same way after the battle in the Teutoburger Forest (*Tac.*

¹ At the moment of going to press the trial is proceeding at Kieff of a Jew, Mendel Beiliss, on a charge of ritual murder.

Ann. i. 61); and similar sacrifices were performed by the Heruli (Procop. *de Bell. Got.* ii. 14), the army of Ariovistus (Cæs. *de Bell. Gall.* i. 53), and others. Sometimes we find that a vow of human sacrifice was made before a battle. Thus Radagaisus, the leader of the Teutons, on the occasion of his expedition into Italy, took a vow that, if he conquered, he would sacrifice the captured Christians (Orosius, vii. 37). In the Northern sources the vow and the oblation alike are paid to Óðinn, whose cult, as the god of war and of battles, had found its way into the Scandinavian region from N. Germany. Procopius (*de Bell. Got.* ii. 15) tells us that the Thulites had sacrificed human beings to *Apns*. When Jarl Einar of Orkney conquered Halfdan, the son of Harald, he devoted his adversaries to Óðinn in return for his victory (*Icelandic Sagas*, i. p. 8: 'gaf hann Óðni til sigrs sér'). When a Norse general came face to face with the enemy, he cried out: 'Óðinn á yðr alla' ('Óðinn has you all').

But Óðinn was at the same time the leader, and thus also the god, of the dead, and his dominion was increased by the addition of fallen warriors (*valr*) to the company of the *Einherjar*. Hence he not seldom selected his own victims. He sent forth his battle-maidens, the Valkyrs, to bring to his kingdom the heroes who fell in the field of battle. We sometimes even meet with the belief that Óðinn himself took part in the battle, and secured his destined victims. Thus, *e.g.*, he was present at the great battle of Bravalla, in which King Harald of Denmark fought against Hring of Sweden, and the god himself struck King Harald down (Saxo Gram. i. 390; *Fornaldarsögur*, i. 380 f.). Or he gives the adversary of his destined victim a spear with which to slay the latter (*Gautreks Saga*, ed. Ranisch, p. 18 ff.). Sometimes, again, men devoted their own lives to the gods. When Eiríkr the Victorious, King of Sweden, met his nephew Stýrbjörn in battle near Fyrisvellir, he dedicated his life to Óðinn, before the onset, promising that he would die ten years afterwards (*Fornmannasögur*, v. 250). But the Northern Teutons of ancient times, in order to gain a victory over their enemies, sometimes offered sacrifices also to their tutelary deities. When Jarl Hákon of Norway joined battle with the Jómsvikings in the bay of Hjörungun (986), and the victory inclined to the side of the latter, he sacrificed his youngest son, Erling, to his protective goddess Thorgerð Holgabruð, and so won the day (*Jómsvikinga Saga*, cod. A.M. 510, p. 79 f.).

Besides war, expeditions by sea were another great source of danger to life. In the sea there lived a man-stealing demon whom the North Teutons called Rán ('robber'). Rán, with her nine daughters—personifications of the waves—laid hold of her victims in storms at sea. Those who were drowned passed into her kingdom, and were there regaled with lobsters and fish. Hence dwellers by the North Sea, or the ocean, before setting out upon a voyage, offered a human sacrifice, hoping thereby to protect themselves against the rapacity of the sea-demon. The heathen Saxons, before taking ship for home after their marauding and predatory incursions, killed a tenth of all their captives upon the beach, in order that a safe voyage might be granted to them (C. von Richthofen, *Zur Lex Saxonum*, Berlin, 1868, p. 204). Likewise the Normans, when embarking upon their Viking raids by sea, sacrificed human beings to the sea-god (*Mém. de la société des antiq. de la Normandie*, xxii. [1869] 129 f.). These sacrifices were performed upon the seashore with special frequency when the ships were unable to put forth because of storms or unfavourable winds. In such emergencies, and especially if other victims

were not available, the individuals to be sacrificed were often chosen by lot from among those who were about to take part in the voyage (Saxo Gram. i. 422). Here should be mentioned also the sacrifices offered by the Frisians to their supreme god Fosite. In Fosite's Land, an island in the North Sea, was situated, not far from a sacred spring, his sanctuary, violation of which was punished by the sacrifice of life after the god had announced by lot that he desired such an expiation (Alcuin, *Vita Willibrordi*, ch. 10; *Friesische Rechtsquellen*, ed. von Richthofen, Berlin, 1840, p. xliii). These immolations were performed upon the seashore; and as far down as Mediæval and Christian times it was a prevalent Frisian belief that the sea demanded the sacrifice of those who had been guilty of robbery (Adam of Bremen, *Hist. Eccl. Hamb.* iv. 3). Here, therefore, the sacrifice was originally offered to the sea-demon, and was transferred to Fosite, and brought into connexion with the violation of his sanctuary only after he had become the supreme object of worship.

But human sacrifices connected with seafaring were not so decidedly of a prophylactic character as those connected with failure of crops. Failure of crops meant famine, and famine meant great loss of life, and here we have the explanation of the human sacrifices performed in times of threatened scarcity. Thus, during a famine, King Heiðrekr, instead of offering up his own son, upon whom the lot had fallen, sacrificed King Harald of Reiðgotaland and his retinue (*Hervarar Saga*, ed. S. Bugge, Christiania, 1865, p. 227 f.). Like other races, the Teutons regarded the king as chiefly responsible for a bad harvest. It is recorded that the Swedes attributed both abundance and scarcity of crops to their kings (*Heimskr.* i. 75: 'Svíar eru vanir at kenna konungi bæði ár ok hallæri'). Even as late as 1527, we find Gustavus Vasa, at the parliament of Westerås, complaining that the people blamed the king for the lack of rain or sunshine (E. G. Geijer, *Svenska Folkets Hist.*, Örebro, 1837, ii. 71). From heathen times comes the statement that the Swedes sacrificed King Domaldi 'pro fertilitate frugum deae Cereri' (*Mon. Hist. Nor.*, Christiania, 1880, p. 98), when neither the immolation of animals nor that of ordinary men had been able to arrest the blight (*Heimskr.* i. 30 f.). When the immolation of kings, which among the Teutons gradually disappeared within historic times, was at length finally abandoned, the king who was held accountable for famine was dethroned, or even expelled from the country, as was the practice, *e.g.*, among the Burgundians (Amm. Marcell. xviii. 5. 14).

The practice of periodical human sacrifice, offered in spring to the deities of fertility, arose from the dread of possible dearth. Such a periodical rite was the sacrifice at the festival of Nerthus, which was celebrated every spring by seven tribes on the Baltic Sea (Tac. *Germ.* 40). At this festival the priest drove the car of Nerthus—the divine *Terra Mater*—through the various cantons of the confederacy, in order to secure the fertility of the whole country. Then, when the procession was over, the slaves who had accompanied the car were sacrificed to the goddess in her sacred lake. Another immolation on a large scale took place every ninth year in the ancient and highly venerated sanctuary of Lethra in Zealand, where the residence of the Danish kings was also situated. At this festival likewise the members of the confederation assembled for a joint-celebration in order that, along with their feast, they might perform the great immolation in which ninety-nine human beings, and an equal number of horses, dogs, and cocks, respectively, were sacrificed. This celebra-

tion took place in winter—the season in which elsewhere the ancient Teutonic festival of the dead was held—and was designed to benefit the souls of the under world (*inferos*) and to expiate the sins that they had committed, as the Christian chronicler (Thietmar of Merseburg, *Chronicle*, i. 9) puts it. A similar sacrifice was performed in ancient Upsala. The season of the year at which it took place is not noted in our sources, but was in all probability the early spring. The sacrifice was offered to the god of fertility, Frö or Frey, in whose honour, indeed, Saxo Grammaticus (i. 120), with his euhemeristic mode of explanation, says it was instituted. As in the festival of Nerthus, there was a procession here also, the image of Frey being borne through the district by a young priestess (*Flateyjarbók*, i. 337 ff.). Frey, too, received human sacrifices, at least in the later period of heathenism. These sacrifices, like the great immolation at Lethra, were performed every nine years, and were offered in the sacred grove at Upsala, their object being to propitiate the god, *i.e.* to secure his favour for the people, and fertility for the land. The victims here were not only human beings, but also horses and dogs, nine of each kind being sacrificed. The bodies of the human victims were hung upon trees in the sacred grove, and the informant of Adam of Bremen (iv. 26–27) says that he had seen seventy-two bodies suspended there.

The Teutons practised these immolations with a view to protecting human life and keeping malignant demons at bay. They had a similar purpose in the sacrifice associated with buildings—a practice met with among all races. It is true that the ancient sources supply no evidence of this observance among the Teutons, but the discovery of skeletons under ancient structures, and the still prevalent belief that great edifices can be made stable by means of sacrifice, indicate that this type of human immolation too existed among the Teutons of heathen times. In order to give stability to a building—to prevent its fall, and the calamity which this would involve—it was the practice to enclose a living person in the masonry under the main supports of the work. As a rule the victims in this case were children. In this particular sacrifice, however, the place of human beings was at an early date supplied by animals (especially cats), or by certain parts of animals (heads of horses, oxen, etc.), and at length by inanimate things (images, coins, etc.). The modern practice of putting in certain objects at the laying of foundation stones is a survival of the ancient rite. In the ancient sacrifices the victims were placed under the threshold of buildings, under the gateways of city walls, and under the pillars of bridges. Then the dikes upon the seacoast, as being specially exposed to the waves, were also protected by human sacrifices. In Oldenburg, children are said to have been thus inhumed as far down as the 17th cent., by way of making the dikes secure (L. Strackerjan, *Aberglaube aus dem Herzogtum Oldenburg*², Oldenburg, 1908, i. 127 ff.). And even at the present day we meet in many districts with the popular belief that certain structures of huge size could never have come into existence at all unless the builder had buried a human being under their supports. Cf. artt. BRIDGE; FOUNDATION.

LITERATURE.—Stephanus Thorarensen, *De homicidio secundum leges Islandorum antiquas*, Copenhagen, 1773; Fr. von Löher, 'Über die angeblichen Menschenopfer bei den Germanen,' *SM.A.*, phil.-hist. Classe, i. [1882] 873 ff. (author denies the existence of human sacrifice among the Teutons); E. Mogk, 'Die Menschenopfer bei den Germanen,' *ASG.*, phil.-hist. Classe, xvii. [1909] 601 ff., 'Ein Nachwort zu den Menschenopfern bei den Germanen,' *ARW.* xv. [1912] 422 ff.; R. Andree, *Ethnogr. Parallelen u. Vergleiche*, Stuttgart, 1878, p. 18 ff.; H. F. Feilberg, 'Levende begravet,' in *Aarboeg f. Dansk Kulturhist.*, Aarhus, 1892, 1 ff. E. MOGK.

HUME.—I. Life.—David Hume, best known for his philosophical writings, but a student of history and economics also, was born in Edinburgh on 26th April 1711. As he himself tells us in his autobiography, he came of a family of distinction but of small estate. He was the youngest of three children, who were early left fatherless, but had the care of a devoted mother. Little is known of his early education. He entered the University of Edinburgh in 1723. His philosophical and literary bent showed itself early in life and grew steadily, triumphing in the end over all other interests. He tried business, but found it unsuitable. In 1734 he went to Paris, and there wrote his *Treatise of Human Nature*, the first and second volumes of which were published in 1739, when he was only twenty-eight years old. He expected much from this his first work, but suffered a great disappointment. It 'fell dead-born from the press.' He was not discouraged, however, but proceeded to write in a more popular form. In 1741 the first volume of his *Essays* appeared, and gained for him almost immediately the notice he courted. A second volume of *Essays* followed the next year. In 1744 he had hopes of securing the chair of Moral Philosophy in the University of Edinburgh, but failed. He then secured the post of tutor to the Marquis of Annandale. In 1748 he became secretary to General St. Clair, with whom he remained, with a slight interruption, for two years, continuing his writing. After some time spent at Ninewells, in Berwickshire, he returned to Edinburgh in 1751, where he remained for twelve years. These were the years of his greatest literary activity, in which most of his political, economic, and religious studies were written, together with his *History of England*. In 1763, in company with Lord Hertford, he again visited Paris, and was received there with gratifying distinction. He was under-secretary to General Conway in 1767, and spent two years in London. He returned to Edinburgh in 1769, to remain for the rest of his life, enjoying a wide reputation and a substantial income. He died on 25th August 1776. His own description of himself as 'a man of mild dispositions, of command of temper, of an open, social, and cheerful humour, capable of attachment, but little susceptible of enmity, and of great moderation in all my passions,' is likewise the description of him given by those who knew him well. His friendship for Rousseau, which was poorly requited, was characteristic of him. There was in his disposition a mixture of cynicism and kindness, a scepticism, half serious and half playful, which prevented for a time a just estimate of his ability. But his reputation has grown with the years, and he ranks among the most acute and penetrating students of human nature.

2. Writings.—

1739–40, *Treatise of Human Nature*: 'Of the Understanding'; 'Of the Passions'; 'Of Morals,' Edinburgh.
1741–42, *Essays Moral and Political*, do.
1748, *An Enquiry concerning Human Understanding*, London.
1761, *An Enquiry concerning the Principles of Morals*, do.
1752, *Political Discourses*, Edinburgh.
1754–61, *Four Dissertations*: 'Of the Natural History of Religion'; 'Of the Passions'; 'Of Tragedy'; 'Of the Standard of Taste,' do.
1777, *My Own Life*, London.
1779, *Dialogues concerning Natural Religion*, do.

3. Philosophy.—Hume's philosophy is usually regarded as the culmination of the line of thought begun by Locke and continued by Berkeley. There is no doubt that he wrote with the ideas of these predecessors in mind, and fully conscious that he was carrying them forward to their ultimate issue. His philosophy, however, is much more than a development of this issue. The turn given to the result, the conception of human nature arising in the course of reaching it, and the consequent

method of conducting inquiry are the really significant things in the work of this Scotsman, who delighted in calling himself a sceptic. His scepticism is not only a suspicion of his predecessors' philosophy; it is also the recommendation of a positive attitude towards life.

In its logical relation to the philosophy of Locke and Berkeley, the philosophy of Hume appears to be the natural and inevitable conclusion of the position they defended in regard to the objects and method of knowledge. Locke (*q.v.*) had reduced his inquiry into the 'original, certainty, and extent of human knowledge' to three fundamental tenets which may be stated as follows: (1) the only immediate objects of knowledge are ideas; (2) all ideas are acquired; and (3) knowledge is a synthesis of ideas, 'the perception of the agreement or disagreement' of them as they are compared and related. Ideas, with Locke, were definitely distinguished from things, on the one hand, and from the mind, on the other hand; they constituted a series of intermediate existences between the mind and the things to which knowledge is supposed to refer. Berkeley (*q.v.*) had questioned the validity of the distinction between ideas and things, if Locke's fundamental theses are to be maintained. If, that is, knowledge is concerned immediately with ideas, their comparisons and relations; if in both object and method it never passes beyond them, then the distinction between ideas and things becomes unintelligible. Knowledge deals directly with its objects; and, if it is a perception of them and their relations, it is evident that objects *are* what they are in perception; their *esse* is *percipi*. Hume pushes this analysis of Locke's position still farther, attacking the distinction between ideas and the mind, just as Berkeley had attacked the distinction between ideas and things. Nothing is given in perception, he urges, except that which is perceived, namely, perceptions. A mind *distinct* from perceptions is not given; it is not a datum of experience, an object to be identified among the sum-total of objects perceived. At best it is a group or 'bundle of perceptions' which expands or contracts as perceptions are added or subtracted. In other words, Hume contends that, if we take Locke's fundamental positions rigorously, then we must admit that perceptions—that is, the content immediately given in perception—are our only objects, and knowledge can deal only with relations between perceptions. To pass beyond perceptions, either to the objects which they are supposed to represent or to a mind which is supposed to perceive them, is to take a step which experience does not warrant. Knowledge, as knowledge, is thus rigorously limited to the immediate data of experience, and that means, with Hume, to our perceptions.

These data of experience Hume divides into two classes—impressions and ideas—and rests the distinction between them squarely on experience. The clearest statement of the distinction is found in the second section of the *Enquiry concerning Human Understanding*, entitled, 'Of the Origin of Ideas':

'By the term *impression*, I mean all our more lively perceptions, when we hear, or see, or feel, or love, or hate, or desire, or will. And impressions are distinguished from ideas, which are the less lively perceptions, of which we are conscious, when we reflect on any of those sensations or movements above mentioned.'

Furthermore, all ideas are derived from impressions, but impressions are themselves originals without any discoverable derivation. Ideas are copies, faint reproductions of impressions; and this fact gives us a rule by which to test the soundness of our ideas:

'When we entertain any suspicion that a philosophical term is employed without any meaning or idea (as is but too frequent), we need but enquire, *from what impression is that supposed*

idea derived? And if it be impossible to assign any, this will serve to confirm our suspicion. By bringing ideas into so clear a light we may reasonably hope to remove all dispute, which may arise, concerning their nature and reality' (*ib.*).

To this test Hume subjects such principal philosophical ideas as those of space, time, cause, necessary connexion, substance, mind, to find in each case that there is no single distinct impression as the source of the idea. Such ideas must be referred to the grouping of impressions or ideas, or to the passage from one impression to another, or from one idea to another. For instance, the idea of substance is not derived from any distinct impression, but

'is nothing but a collection of simple ideas, that are united by the imagination, and have a particular name assigned them, by which we are able to recall, either to ourselves or others, that collection' (*A Treatise of Human Nature*, bk. i. pt. i. sec. vi.).

The idea of necessary connexion is not derived from any necessary connexion discoverable among our impressions, but from the *feeling* attending 'the customary transition of the imagination from one object to its usual attendant.' And the idea of cause and effect is to be understood, not in terms of any discoverable power by which one thing works a change in some other thing, but in terms of the persistent habit of human nature to expect similar facts to be followed by similar experience.

Thus Hume attempted to abolish the leading ideas of the philosophy which preceded him, by pushing to the extreme the doctrine that, so far as knowledge is concerned, we deal only with perceptions and their relations. Since we *perceive* no power, no necessary connexion, no substance in which qualities inhere, and no mind which itself perceives, but only perceptions, impressions, and the ideas derived from them, we must interpret mind, power, substance, and necessary connexion solely in terms of impressions and ideas. When so interpreted, they lose the force and significance usually assigned to them. They cease to be principles applicable to things, and become rather principles for the grouping and associating of ideas. Thus Hume gave a great impetus to associationist psychology, to the view that knowledge is concerned only with original mental elements and their associations.

The result thus reached by Hume he presents to the reader as a recommendation for scepticism. He points out that we naturally tend to repose faith in our senses and to believe that we perceive external objects, whereas philosophy convinces us that we perceive only perceptions which *we suppose* refer to objects or represent them. Of this supposition we can have no proof, for our perceptions, being perceptions and nothing more, never give any indication of external objects. Confined thus to our perceptions, reason can never pass beyond them, and we are forced to doubt the rational soundness of any conclusions which attempt to carry us beyond (see *Human Nature*, bk. i. pt. iv., particularly sections i., ii., vi., and vii.).

Hume's reasoning here is so manifestly based upon the assumption that perceptions are not objects—one of Locke's fundamental assumptions, which he has himself declared to be really unintelligible—that it is difficult to follow him seriously. He appears to be playing with the issue to which he has reduced the philosophy of his predecessor. But in another connexion he gives a decidedly serious and important turn to his 'scepticism,' namely, in his doctrine of belief. 'We may well ask,' he states, '*What causes induce us to believe in the existence of body?* but 'tis in vain to ask, *Whether there be body or not?*' (*ib.* bk. i. pt. iv. sec. ii.). This statement may be generalized to indicate how with Hume the problem of belief is more important than the problem of knowledge. To his mind philosophers had busied themselves

too much with the question whether the things in which we naturally believe, such as an external world, power, God, providence, exist—a question which cannot be answered, because, in order to answer it, we should have to pass beyond the limitations which experience puts upon the problem of existence. There is no way of proving that that which we have not experienced exists. It is, therefore, idle to try. But, since we believe in spite of this fact, the grounds of our belief may be investigated. In every case, Hume reduces belief to some principle of human nature, to some habit or propensity of mind, just as he reduces the belief in necessary connexion to the feeling attending the inevitable expectation of similar consequences from similar events. He defines belief generally as 'a lively idea related to or associated with a present impression.' His comment on this definition is not only a clarification of it, but a good illustration of his philosophical position generally.

'When we infer the existence of an object from that of others, some object must always be present either to the memory or senses, in order to be the foundation of our reasoning; since the mind cannot run up with its inferences *in infinitum*. Reason can never satisfy us that the existence of any one object does ever imply that of another; so that when we pass from the impression of one to the idea or belief of another, we are not determin'd by reason, but by custom or a principle of association. But belief is somewhat more than a simple idea. 'Tis a particular manner of forming an idea: And as the same idea can only be vary'd by a variation of its degrees of force and vivacity; it follows upon the whole, that belief is a lively idea produc'd by a relation to a present impression, according to the foregoing definition' (*ib.* bk. I. pt. iii. sec. vii.).

Then there is a kind of inevitableness about belief; it is the necessary result of putting the mind in certain circumstances. That is why scepticism, although it triumphs over reason and every attempt to establish by reason the objects of belief, is relatively impotent in the face of belief itself. 'Nature'—and here Hume means human nature—'will always maintain her rights, and prevail in the end over any abstract reasoning whatsoever.'

To ground belief on principles of human nature rather than on proved conclusions of reason, however, was for Hume not the end of philosophy. It suggested to him a science of human nature which should set forth in detail the ways in which men act and in which they come to believe in any matter of fact. Such things are with him the proper objects of philosophical inquiry. Only the method applicable to them should be carefully noted. The sub-title to his *Treatise of Human Nature* indicated what he conceived that method to be: 'an attempt to introduce the experimental method of reasoning into moral subjects.' That is, problems concerning man's beliefs and conduct are to be handled by observing how men behave under given conditions, and what actuates and moves them. Above all, the effects of *probable* conclusions based on observed uniformities, sequences, and expectations are to be emphasized. For probability rather than certain conclusions is the great guide in human life. This method has already been illustrated in the foregoing exposition. A further and significant illustration of it is found in Hume's theory of morals.

'Those who affirm,' he says, 'that virtue is nothing but a conformity to reason; that there are eternal fitnesses and unfitnesses of things, which are the same to every rational being that considers them; that the immutable measures of right and wrong impose an obligation, not only on human creatures, but also on the Deity himself; All these systems concur in the opinion, that morality, like truth, is discern'd merely by ideas, and by their juxta-position and comparison. In order, therefore, to judge of these systems, we need only consider, whether it be possible, from reason alone, to distinguish betwixt moral good and evil, or whether there must concur some other principles to enable us to make that distinction' (*ib.* bk. iii. pt. I. sec. I.).

His own opinion is that, tested by experience, it is not reason alone that enables us to make the distinction. 'Morals excite passions, and produce or prevent actions. Reason of itself is utterly im-

potent in this particular. The rules of morality, therefore, are not the conclusions of our reason.' They are conclusions from feeling and sentiment. 'Morality is more properly felt than judg'd of.' Again:

'Virtue is distinguished by the pleasure, and vice by the pain, that any action, sentiment, or character gives us by the mere view and contemplation. This decision is very commodious; because it reduces us to this simple question, *Why any action or sentiment upon the general view or survey gives a certain satisfaction or uneasiness*, in order to shew the origin of its moral rectitude or depravity, without looking for any incomprehensible relations and qualities, which never did exist in nature, nor even in our imagination, by any clear and distinct conception. I flatter myself I have executed a great part of my present design by a statement of the question, which appears to me so free from ambiguity and obscurity' (*ib.* bk. iii. pt. I. sec. ii.).

Thus we are brought to look for the springs of moral action, not in reason, but in a natural quality or disposition of human nature—the disposition to approve or disapprove actions as they affect us with a favourable or unfavourable view of the person acting, as they lead us to sympathize with him and his motives. Hume's theory of morals is thus neither hedonistic nor egoistic primarily. It is not essentially utilitarian, although considerations of utility are important for him. It is rather an attempt to show that morals are pre-rational, finding their origin in the emotions rather than in calculation. His theory is introduced by an elaborate and interesting study of the emotions themselves.

Hume's method of dealing with religion is the same as his method of dealing with morals. His 'Natural History of Religion' opens with these words: 'As every enquiry, which regards religion, is of the utmost importance, there are two questions in particular, which challenge our attention, to wit, that concerning its foundation in reason, and that concerning its origin in human nature.' Here, again, is the sharp contrast between reason and human nature. Hume, indeed, admits that there is rational ground for the 'primary principles of genuine theism,' such as an intelligent author of the whole frame of Nature, but insists that what the majority of men believe about God is not founded on reason. The latter has a natural history which he attempts, with very insufficient data, to trace. Religion, according to him, began as polytheism, and arose 'not from a contemplation of the works of nature, but from a concern with regard to the events of life, and from the incessant hopes and fears which actuate the human mind.' These hopes and fears led men to believe in many corresponding deities. The passage from polytheism to theism was brought about, not so much by any train of philosophical reasoning, as by a tendency to idealize the conception of Deity. There thus results a 'kind of flux and reflux in the human mind,' and 'men have a natural tendency to rise from idolatry to theism, and to sink again from theism into idolatry.' If religion had its origin in reason, such a flux and reflux would be impossible. Throughout this discussion of the natural history of religion, Hume lays little stress on the validity of religious belief. It is with him a characteristic belief of human nature, like belief in causation or in an external world.

The problem of validity is, however, discussed in his *Dialogues concerning Natural Religion*. A supernaturalist, a deist, and a sceptic are the protagonists in the discussion. The argument proceeds with much acuteness. The principal point in dispute is not the existence of God, but how far we can, by reasoning from the character of the world, the events of history, and the good and evil fortunes of men, reach sound conclusions about God's nature and attributes. Are we entitled to infer any greater goodness and perfections in the author of the world than we find exhibited in the

world? Can we infer a providential guidance of the course of events, in face of the fact that a special care for one man's good is bound up with another man's evil? The outcome is inconclusive, befitting, doubtless, the literary demands of the dialogue rather than illustrating Hume's own convictions. He does not hesitate, however, to betray his own preference for the sceptic's position. The subject passes the power of human reason to decide. Arguments balance one another. His closing statement is perhaps the expression of his own attitude:

'If the whole of Natural Theology, as some people seem to maintain, resolves itself into one simple, though somewhat ambiguous, at least undefined proposition, *That the cause or causes of order in the universe probably bear some remote analogy to human intelligence*: If this proposition be not capable of extension, variation, or more particular explication: If it affords no inference that affects human life, or can be the source of any action or forbearance: And if the analogy, imperfect as it is, can be carried no farther than to the human intelligence; and cannot be transferred, with any appearance of probability, to the qualities of the mind: If this really be the case, what can the most inquisitive, contemplative, and religious man do more than give a plain, philosophical assent to the proposition, as often as it occurs; and believe that the arguments, on which it is established, exceed the objections, which lie against it? Some astonishment indeed will naturally arise from the greatness of the object: Some melancholy from its obscurity: Some contempt of human reason, that it can give no solution more satisfactory with regard to so extraordinary and magnificent a question. But believe me, Cleanthes, the most natural sentiment, which a well-disposed mind will feel on this occasion, is a longing desire and expectation, that heaven would be pleased to dissipate, at least alleviate this profound ignorance, by affording some particular revelation to mankind, and making discoveries of the nature, attributes, and operations of the divine object of our faith. A person, seasoned with a just sense of the imperfections of natural reason, will fly to revealed truth with the greatest avidity: While the haughty Dogmatist, persuaded that he can erect a complete system of Theology by the mere help of philosophy, disdains any farther aid, and rejects this adventitious instructor. To be a philosophical Sceptic is, in a man of letters, the first and most essential step towards being a sound, believing Christian; a proposition which I would willingly recommend to the attention of Pamphilus: And I hope Cleanthes will forgive me for interposing so far in the education and instruction of his pupil.'

It should be noted, in conclusion, that Hume wrote many suggestive essays on social and political topics, which, however, have little historical importance. His *History of England* was a partisan document, based on an inadequate knowledge of the facts. It is significant, however, for its emphasis upon the social and literary interests of the nation as of equal importance with its political affairs.

LITERATURE.—The best modern ed. of Hume's works is that by T. H. Green and T. H. Grose, in 4 vols., London, 1874-75. L. A. Selby-Bigge has issued an ed. of the *Enquiries* (Oxford, 1894), and the *Treatise* (2nd ed., do. 1896), with an excellent topical index and critical apparatus. For his life, the principal writings are: J. H. Burton, *Life and Correspondence of David Hume*, Edinburgh, 1846; G. B. Hill, *Letters of Hume to William Strahan*, Oxford, 1888; and C. J. W. Francke, *David Hume*, Haarlem, 1907. Among the many philosophical studies of his work, T. H. Huxley's 'Hume,' in the *English Men of Letters* series (London, 1879), and W. Knight's 'Hume,' in *Philosophical Classics* (Edinburgh, 1886), deserve special mention. The Green-Grose ed. contains an elaborate critical introduction.

FREDERICK J. E. WOODBRIDGE.

HUMILITY.—The Greek word *ταπεινός* is one of those which, like *ἀρεσκεία*, have been rescued and ennobled by Christian ethics (see Trench, *Synonyms of the NT*, Cambridge, 1854, § xlii.; T. K. Abbott, in *ICC* [Edin. 1897] on Eph 4²; cf. art. 'Humility,' in *HDB*).

Humility is an essential Christian grace, and distinguishes the religion of Christ from that of paganism. For Christians to walk 'worthy' of their vocation is to walk 'in lowliness and meekness' (Eph 4²).

'Paganism was not humble, because to paganism the true God was but a name. The whole life and thought of the pagan world was therefore very naturally based on pride. Its literature, its governments, its religious institutions, its social organisation and hierarchy, its doctrines about human life and human duty—all alike were based on the principle of a boundless self-assertion' (Liddon, *BL*, p. 500).

In the later Stoicism, self-reliance reaches its climax

in 'the deification of human virtue, the total absence of all sense of sin, the proud stubborn will that deemed humiliation the worst of stains' (Lecky, *Hist. of Europ. Morals*, London, 1869, i. 223; cf. Seneca, *Ep.* lxxvii. 8, where humility appears as a consciousness of weakness, disqualifying a man for the higher spiritual rank). It is true that even in Aristotle's conception of the *μεγαλόψυχος* may possibly be discerned some elements of good: truthfulness of character and speech, magnanimity in overlooking offences, self-respect, and indifference to death (*Eth. Nic.* iv. 3, § 24 ff.). But it remains true on the whole that the highest and most inclusive¹ type of heathen virtue is essentially an exalted form of self-esteem, implying contempt of others. The *μεγαλόψυχος* is *ὁ μεγάλων αὐτῶν ἀξιών ἀξίος ὢν*. In the classical conception of virtue there is, in fact, 'an element of worldly wisdom which does not exclude self-righteousness.' To a heathen the only check upon pride was the prudential consideration that the gods were envious of undue prosperity and hostile to insolence (*ὕβρις*) and self-exaltation. This is, of course, a commonplace of the Greek tragedians. A Greek might have assented to the maxim laid down by St. Paul in Ro 12³ (*φρονεῖν εἰς τὸ σωφρονεῖν*), but he laboured under a real confusion of mind, a real ignorance, as to the actual condition and true possibilities of human nature. In the gospel, humility is the natural fruit of the deepened insight which resulted from Christ's revelation of God, and of the personal example exhibited in the incarnate life. 'The sceptre of God's majesty,' says an early writer (*Clem. ad Cor.* i. xvi.), 'our Lord Jesus Christ came not in the pomp of arrogance or pride, though He might have done so, but in lowliness of mind (*ταπεινοφρονῶν*).' Here we have the keynote of the change which Christianity produced in man's estimate of himself. It may be added that 'magnanimity' ranks as a genuine Christian virtue; it is not, however, identical with humility, though quite compatible with it. Aquinas regards it as a species of fortitude (*Sum.* ii. 2. qu. cxxix.).

1. In the NT, humility seems to be considered under two main aspects.

(1) *As a personal virtue.*—From this point of view humility is that fundamental quality which places man in the only right relation to God. 'Humility,' says Aquinas, 'strictly speaking, implies the reverence whereby man subjects himself to God' (*Sum.* ii. 2. qu. clxi. art. 3 resp.). Humility is the victory of truth in character; that just self-estimate which, while not depreciating personal gifts or excellences, always refers them to God as their true and only source. This just self-estimate includes both the sense of creaturely limitations and the consciousness of personal weakness and sinfulness. 'Humilitas facit quod homo seipsum parvipendat, secundum considerationem proprii defectus' (*Sum.* ii. 2. qu. cxxix. art. 3 ad 4).

Humility is thus the initial grace of the Christian life. Its fundamental place in character is taught by Christ in the first Beatitude (Mt 5³); and also in the injunction of Mt 18³, Mk 10¹⁵, Lk 18¹⁷. It implies 'the acknowledgment of God' and of what man really is in His sight, and thus includes: (a) the spirit of *creaturely dependence and service*. Our Lord's great humility was manifested in His assumption of the 'form of a servant,' as contrasted with the glory and sovereignty of His original and essential state as Son of God (Ph 2⁷; see Corn. à Lap. *ad loc.*, and cf. Joh. Damasc. *de Orth. Fid.* iii. 21). Further, in virtue of the union of His human nature with Deity, He who is one

¹ Aristotle says (iv. 3. 16): *ἔοικεν ἡ μεγαλόψυχία οἷον κόσμος τις εἶναι τῶν ἀρετῶν.*

with the Author and Giver of all spiritual blessings became Himself a receiver, inferior to the Father 'as touching his manhood' and dependent on Him for all that was needed to sustain His manhood, to equip it for its redemptive work, and to advance its condition (see Hooker, *Eccl. Pol.*, bk. v. ch. 54; Aquin. *Sum.* iii. qu. viii.). The unique characteristic of the Christian faith is the mystery of this self-humiliation; the fact that the pattern of humility is nothing lower or less than the incarnate life of the Son of God. Humility, then, in its primary sense is the spirit of perfect dependence on God.

'By humility I understand such a spirit or gracious property in the soul of man or any intellectual creature as that hereby he does sensibly and affectionately attribute all that he has or can do to God, the Author and Giver of every good and perfect gift' (H. More, 'Of the Divine Life,' ch. xii., *Theol. Works*, London, 1708, p. 37).

(b) *Holy fear or the sense of sin.*—'The poor in spirit,' says Augustine, 'are the humble and those who fear God. Nor can beatitude have any other beginning' (*Serm. Dom. in monte*, i. 3). Pride or self-assertion is the root of sin; the beginning of wisdom is the fear which springs from the sense of personal unworthiness. Thus Bernard calls self-knowledge and the humility which it produces 'mater salutis' (*in Cant.* xxxvii. 1). Humility is the essence of a true conversion; it is the indispensable secret of progress; it is the pledge of security, since even the grace already bestowed on the soul may be lost by pride.

This has never been more forcibly expressed than in a famous passage of Augustine (*Ep.* 118 'ad Diosc.' 22). He bids Dioscorus submit himself wholly and without reserve to the yoke of Christ, and tread no other road to the attainment of truth than that which was trodden by Him who, as God, saw the infirmity of our steps. 'And that road is first humility, secondly humility, thirdly humility. . . . And as often as I was asked about the precepts of Christian religion, I should choose to answer nothing else than "Humility," though perhaps necessity would compel me to say other things.'

(2) *As a social virtue.*—On the other hand, humility is commended in the NT as a social virtue, as, for instance, in Ph 2¹⁻¹¹. Humility is a form of moderation (cf. *Sum.* ii. 2. qu. clxi. art. 4). The point enforced by Christ's example in Ph 2 is that He did not insist upon rights which He might in strict justice have claimed. St. Paul implies that the desire for superiority, vainglory, and the spirit of partisanship are fatal to Christian unity and concord. The humility which honours all men and defers to them *in quantum in eis aliquid inspicit de donis Dei* tends to promote the well-being of the community (Ro 12¹⁰, Eph 4¹⁻², Ph 2³). It excludes the envy which springs from comparing self with others (2 Co 10¹²); it encourages the spirit of contentment and mutual serviceableness. The humble man will constantly recognize that any gift which gives him superiority over his fellows is in a measure due to the good influence of others—parents, friends, teachers, even enemies who have dealt candidly with his defects; and, further, 'so far from wishing to keep his virtues to himself he will wish that they were common as the air of heaven, that "all the Lord's people were prophets." Thus humility is a social virtue and may be regarded as an aspect of benevolence' (Rashdall, *The Theory of Good and Evil*, i. 206). Hence in the interests of peace, whether in the family or in the Church, the NT frequently insists on the duty of mutual subjection (e.g. Eph 5²¹, 1 P 5⁵). Further, as one great secret of effective social service is patient study of the conditions of each problem that needs solution, the teachable or humble temper is essential—the spirit which is willing to learn and observe before taking action. Bernard's observation is here in point, that the Church needs reservoirs rather than pipes ('Canales hodie in Ecclesia multos habemus, conchas vero perpaucas'). 'Men,' he complains, 'are nowa-

days so full of charity that they wish to pour out before they are full; they are more ready to speak than to hear, and eager to teach what they have not learned' (*in Cant.* xviii. 3). The scientific spirit needed in dealing with modern social problems is a spirit of humility, willing to put itself to school with facts, and mindful of Bacon's maxim, *artem inveniendi cum inventis adolescere posse*.¹

2. The acts or offices of humility must necessarily vary with the particular states and conditions of men. The Benedictine rule, with its 'twelve grades' of humility, is briefly discussed by Aquinas (*Sum.* ii. 2. qu. clxi. art. 6; see also the last book of Cassian's *Inst.*, 'de Superbia'). In ordinary life the grace of humility takes such forms as are described by Jeremy Taylor (*Holy Living*, ch. ii. § 4). It is specially tested in a man's life with his equals.

'The hardest trial of humility must be not towards a person to whom you are superior, and who acknowledges that superiority, but towards a person with whom you are on equal footing of competition. . . . The relations to equals are thus the more real trial of humility than the relations to inferiors' (Mozley, *Univ. Sermon*, London, 1876, ix. 'Our Duty to Equals,' p. 220).

3. It may be noticed, in conclusion, that some clear principles connected with our subject emerge in our Lord's teaching, and find an echo in common human experience.—(1) *Docility or receptiveness*—the temper of the child is a necessary condition of spiritual as of mental growth (see PASSIVITY).—(2) *The spirit of dependence* is the condition of spiritual fruitfulness (Jn 15⁵). The Christian ideal is not self-reliance, but unlimited confidence in the goodwill and co-operating grace of God at every stage of moral and spiritual progress. The Christian echoes St. Paul's confession: *ἐκικουπλάσθη ὄν τυχῶν τῆς ἀπὸ τοῦ θεοῦ ἀρχῆς τῆς ἡμέρας ταύτης ἔσθηκα* (Ac 26²⁹). The sense of personal insufficiency is never diminished in the true Christian. In proportion to his growth in grace he realizes more perfectly his 'universal need' of God—his complete dependence on Christ, his all-sufficiency in Christ (Ph 4¹²; cf. 2 Co 12⁹). We may contrast the boast of the Stoic: 'Sapiens cum Diis ex pari vivit, Deorum socius, non supplex' (Seneca, quoted by J. Smith, *Select Discourses*, London, 1860, p. 390). Again: 'Dicam quomodo intelligas sanum; si se ipse contentus est, si confidit sibi' (Sen. *Ep.* 72).—(3) *Humility is the way of exaltation* (Lk 14¹¹ 18¹⁴). This is a saying of very wide scope. The supreme illustration of its meaning is seen in the Passion and Resurrection of Christ Himself. The condition of all real excellence is a just estimate by man of his own capacity, and of the greatness of the object at which he aims. The condition of acquiring the capacity to rule is service (Mt 20²⁶). The hope of progress lies in that self-dissatisfaction and habit of aspiration which is the negation of pride (Ph 3⁷⁻¹⁴). Christianity, in fact, as Pascal points out (*Pensées*, pt. ii. art. 4), combines what had hitherto seemed contrary: greatness of character and humility.—(4) The principle implied in Lk 16¹⁵ and in 1 Co 4⁵⁻⁶—the principle that *what a man is in God's sight, that and nothing else he is*. Humility implies a constant sense of the possible reversal of all human judgment. Hence humility is closely allied to Christian simplicity or single-mindedness, which aims simply at pleasing God (Ro 8³, 1 Co 7³², 1 Th 4¹), which strives after a goodness such as He can accept (2 Co 5⁹), and which recognizes everywhere the presence of an unseen Lord who searches the heart. So Augustine describes the ideal righteous man as being one who 'Deum ubique praesentem ita cognoscat sicut sancti postea

¹ Cf. Huxley's maxim: 'Science seems to me to teach in the highest and strongest manner the great truth which is embodied in the Christian conception of entire surrender to the will of God. Sit down before facts as a little child, follow humbly wherever nature leads, or you shall learn nothing' ('Letter to O. Kingsley,' *Life and Letters*, ed. L. Huxley, London, 1900, i. 219).

cognituri sunt' (*de Spir. et Litt.* 66; cf. Cassian, *Inst.* xii. 32).

LITERATURE.—Basil, *Hom. de humilitate*; Augustine, *Epist.* 118, 'ad Dioscorum'; Bernard, in *Cant.* 37, etc.; Aquinas, *Summa*, ii. 2. quæst. cxxix. 3, cxxxii., cxxxiii., cxxi.; J. Taylor, *Holy Living*, ch. ii. § 4; W. Law, *Serious Call*, London, 1728, chs. 17, 18, 19; H. Rashdall, *The Theory of Good and Evil*, Oxford, 1907, bk. i. ch. vii. § 5; J. Iverach, *The Other Side of Greatness*, London, 1908, p. 1 ff.

R. L. OTTLEY.

HUMOUR.—The quality of humour shares in the mystery which attaches to all forms of human emotion. In its genuine manifestations it is as spontaneous as laughter, and as inexplicable. It mocks all attempts at definition. We can 'see' it, and possess it, and enjoy it, but cannot say with definiteness what it is.

The word itself has had a changeful history. Starting with the significance of moisture or fluid, it was employed in pre-scientific medicine to describe what were regarded as the four principal humours or fluids of the human body, viz. blood, choler, phlegm, and melancholy. It then came to denote a passing disposition, a transient mood or temper, because these were supposed to originate from the condition of the humours. When the mood was permanent or characteristic, it indicated what we call an eccentricity. To Dr. Johnson a humorist was 'a man with odd conceits,' and to Goldsmith 'an eccentric fellow.' In modern usage, humour is generally restricted to the sense of the ludicrous, or that power in man which enables him to see and enjoy what is amusing. (There are some grounds for suspecting that some of the dumb animals are not entirely destitute of it.)

The common opinion among modern psychologists is that the perception of the incongruous and the inconsistent is the cause or source of humour. It is invariably associated with alertness and breadth of mind, a keen sense of proportion, and faculties of quick observation and comparison. It involves a certain detachment from or superiority to the disturbing experiences of life. It appreciates the whimsicalities and contradictions of life, recognizes the existence of what is unexpected and absurd, and extracts joy out of what might be a cause of sadness. It acts as a check to one-sided views of life, and champions the ideas of 'common sense' against the visionary aims of the idealist. It is complex in its character and action. It is 'essentially the gift of rising above the interest with which we [and others] may be engaged and reducing it to its limited importance, or even to its proper insignificance, in the great whole of things in which it is a part' (E. Caird, *CR* lxx. [1896] 818). Again, it sometimes exaggerates one special feature, or characteristic (as in caricature), so that it appears absurd, because out of relation to the whole to which it belongs; or it creates amusement by bringing into a temporary union ideas and things which do not belong to the same category. Bergson finds the source of the incongruity in the rigidity, automatism, or distraction to which we are liable, and which hinders us from adapting ourselves quickly to different situations, or from moulding our actions in swift accordance with the varying demands of changeful life. The contrasts between the ideal and the real, between the apparent dignity of man and the situations in which he sometimes finds himself, between the high aims which he sets before him and the poor measure of his attainment, the linking together of things and ideas which are essentially different—these are the perennial founts of humour. The sharper the contrast, and the more sudden the perception of it, the more intense is the emotion which is produced. Humour then relieves itself in an explosion of laughter. The element of sur-

prise is an almost necessary adjunct of humour. Not infrequently the contrast involves a moral incongruity. It is this fact that places humour as a weapon in the hands of the reformer.

Humour and wit are closely allied. In general they find their subjects in the same sphere, but they use them differently. Humour is kindly, and in its genuine forms includes the quality of sympathy; wit is sharper and more apt to wound. Wit is a flash, humour is a genial glow; wit is intensive, humour is relaxing. Qualities of feeling predominate in humour, in wit qualities of intellect. The boundaries of the two are somewhat indeterminate. The pleasure which humour evokes is more genial than that to which wit gives rise.

Humour assumes many forms: verbal humour, the humour of the situation, the burlesque, the practical joke, satiric humour, sardonic humour, and so on.

The sense of humour is universally desired, and is highly valued. No one will readily acknowledge that he does not have it. Without it man is scarcely human. It is a means of self-criticism, and saves from the folly of self-importance and the sin of self-righteousness. Personal vanity or pride cannot survive the possession of this self-corrector. It is a protection against excess; it fosters humility, and yet lessens the bitterness of failure and blundering. It softens the angularities of individual character and social life, and introduces a welcome charity into social judgments. It carries with it a tolerance which makes it a foundation of good fellowship. It is essentially a social quality, and postulates an absorbing interest in life. The cynic may live alone; the humorist delights in company. The cynic may be a pessimist, but pessimism is impossible to the humorist. In spite of his tendency to poke fun at the ideal, belittle the 'strenuous life,' and laugh at failure, he yet believes in the ideal. Humour tends to keep the heart young. As a criticism of social life and character it is invincible and invaluable. Humour is the inveterate foe of convention, and loves to make fun of Mrs. Grundy and all who follow in her train. It keeps social life from falling into ruts or from staying there when it does so. Many abuses which resist the combined assaults of reason, argument, and denunciation yield to the genial onslaught of humour, and fly before its shouts of laughter. Humour is an almost necessary quality in the reformer. Luther owed much of his success to his possession of it. It was also a prominent characteristic of Lincoln. The fanatic is destitute of it, and this may account for the fact that he generally fails. Humour of itself does not reform; it is only a force that weakens the strength of what is to be changed, and prepares the way for the reform.

But, apart from its practical influences on conduct and society, it adds a joy to life without which life would be dull and poor. It is a relaxation and a delight to step aside for a moment from the sober, grey, and solemn world, where reason and order rule, into a realm where the whimsical, the incongruous, and the absurd hold sway, and summon us to laughter or play. These also are part and parcel of the life of the world. Some of the world's greatest benefactors have been its humorists. They brighten with a touch of fun the horizon of life, which is often dark and dismal. They help us to see and to make life a gladsome thing. Even Dante named his great work the *Divine Comedy*, because he believed in a happy ending to the story of the world's life. In the closing paragraph of Plato's *Symposium*, Aristodemus reports that, when only half-awake, he heard Socrates say that the genius of tragedy was the same as the genius of comedy,

and that a true artist in the one was also a true artist in the other.

But humour, like many of the powers and qualities of man, is capable of evil as well as of good. It has a tendency to coarseness and even obscenity. Many of the humorous stories of the world cannot be repeated in decent society. Humour is often irreverent, and hurtful to the finer aspects of the emotional and spiritual life. The dreams which men cherish of higher and better things wither away under its mocking touch. They may be called 'quixotic,' but 'by these things men live, and wholly therein is the life of (the) spirit' (Is 38¹⁰). It may weaken the pursuit of a high ideal, because it sees the apparent futility of effort towards it. It may lead to the neglect of the more serious and noble side of life, and in its degradation treat the most solemn facts and experiences as subjects for laughter. Those who possess the sense of humour in a high degree are always in danger of being carried away by it. Their tendency to exaggeration makes us think that the humorist is not always to be taken seriously. We cannot accept the characterizations of Aristophanes as true representations of the men and women of Athens in his day, nor can we regard Rabelais as a trustworthy exponent of human nature. Although humour is a basis of good-fellowship, when unrestrained it tends to destroy friendship. It may develop heartlessness and ally itself with cruelty. No one likes to be laughed at, but the humorist not infrequently enjoys the misery which his 'fun' creates. Over-indulgence in humour leads to levity, flippancy, and shallowness. It is a quality which needs to be rigorously restrained. Humour for humour's sake is depressing; it adds a burden to life. The buffoon and the clown are out of place as permanent features of this work-a-day world.

It is a curious fact that humour differs widely at different periods of the individual life and among different people. The humour of the schoolboy is an annoyance to him when he is grown up. One of the gulfs which separate the races of the world is their differing conceptions of the humorous. A series of books dealing with the humour of different nations of Europe has been published by the Walter Scott Company, London—French, German, Italian, 1892; American, Dutch, 1893; Irish, Spanish, 1894; Russian, 1895. Outside of the particular nations to which the books refer, they are found to be dull.

LITERATURE.—E. Hecker, *Die Physiol. und Psychol. des Lachens und des Komischen*, Berlin, 1873; A. Bain, *The Emotions and the Will*, London, 1866, pt. I. chs. xii., xiii., xv.; H. Spencer, *Principles of Psychol.*, do. 1870, vol. II, pt. viii. ch. vii., and *Essays*, do. 1891, vol. I., Essay iv. 'The Physiology of Laughter'; J. Sully, *The Human Mind*, do. 1892, II. 151; George Meredith, *Essay on Comedy, and the Uses of the Comic Spirit*, do. 1897; H. Bergson, *Laughter: An Essay on the Meaning of the Comic*, do. 1911; *Atlantic Monthly*, lxxxiv. (1899) 872, c. (1907) 427; *IJE* xix. (1909) 488; *Harper's New Monthly Magazine*, xxxi. (1896) 897; *Saturday Review*, lxxxvii. (1899) 489, lxxi. (1891) 939; *The Spectator*, lxxxix. (1902) 561, xciv. (1905) 80; *The Canadian Magazine*, xxxiv. (1910) 17; *North American Review*, cxxxvii. (1883) 267; J. J. Chapman, 'The Comic,' *HJ* viii. (1910) 862; Darrell Figgis, *Shakespeare*, London, 1911, p. 198; *DCG*, art. 'Humour'; *ExpT* II. (1890-91) 361.; R. H. Hutten, *Contemporary Thought and Thinkers*, London, 1894, I. 103 ff.; H. D. Traill, *The New Fiction*, do. 1897, p. 288 ff.; H. L. Martensen, *Christian Ethics*, Eng. tr., Edinburgh, 1879, p. 184 ff.; W. S. Lilly, *Fortnightly Review*, lix., new ser., p. 724 ff.

JOHN REID.

HUNGARIANS.—There is not much of a distinctive kind that can be said about the religion of the ancient Hungarians. They worshipped the usual objects of Nature. Their religion, like that of many other nomadic peoples, was a very low polytheism. Their gods were personifications of natural phenomena or of natural forces. The personification did not reach a high grade of evolu-

tion, and the gods did not differ much from the phenomena, and possessed very little that could be called spiritual. There was a little more of a spiritual character attributed to their highest god, whom they called Isten (or Ishten), the conception of whom overshadowed that of the polytheistic 'little' gods. There were many 'little' gods; and the heathen Hungarians believed that the gods of the rain, the winds, life, death, winter, summer, the trees, the water, the day and the night, had a better and greater influence on human life and all its events than the highest god; and therefore they offered burnt-offerings to the 'little' gods, and thought that they were the counsellors of the highest god. They sacrificed especially white horses.

As to other religious tenets of the Hungarians, we know very little indeed. They had no elaborate system of theology, and the triumphant Christianity of the 11th cent. passed severe laws for the abolition of their rites, their hymns, and even their places of worship. But we know that they had a belief in a life beyond the grave. At the burial of their warriors they took care that their horses and dogs should be interred with them. They also thought that the enemy slain in a battle by a Hungarian was bound to serve the Hungarian hero after his death. They held firmly that the highest god loved the brave, and the greatest virtue with which he could endow a man was bravery.

The priests of the Hungarians were called *tátos* (or *tahtosh*), 'wise man.' They performed the sacrifices, said the simple prayers, sang of the great deeds of heroes. They resembled the Welsh bards somewhat; but they had less religious strength than the bards, and accordingly Christianity not only vanquished but almost extirpated the old heathen religion of the Hungarians.

Among the modern Hungarians, fairies (*tündér*, 'apparitions') are, in older tradition, subject to a goddess named Furuzsina, and live in a far-away land of matchless beauty, though they still have mansions in this world (especially mountain castles) till vexed by mankind. They often entice away mortals whom they love. Fate-telling fairies (usually three, but also seven or nine in number) are also prominent figures in Hungarian folk-belief, dwelling near a spring, well, or brook. These fates are usually considered beneficent. Other fairies dwell in lakes and rivers, and there are, besides, mermen (*vízi emberek*) and mermaids, who often form love-unions with human beings. Many springs are regarded as holy, and drought follows if stones are thrown into them, while folk-customs often retain traces of the wide-spread belief in the magic properties of water. Giants and dwarfs figure in popular belief; the former are, in general, kindly, and in their wonderfully beautiful palaces they live lives of model bliss and propriety. Unlike giants generally, the Hungarian giants are wise, and are particularly distinguished by the fact that they keep their strength in a vat in the seventh cellar of their palaces, taking with them only what they may require. The chief function of dwarfs is to guard treasure; but they take their third owner (they can be sold by one man to another) to hell. Obvious traces of an early fire-cult have survived, especially about the time of the summer solstice. The winds are the children of the 'wind-mother' (*Szélanya*) or the subjects of the 'wind-king' (*Szélkirály*); and apoplexy is often called 'wind-stroke' (*szélütés*). Generally speaking, however, the belief in disease-demons is rather attenuated among the modern Hungarians. In regard to Hungarian ideas concerning fate, it is noteworthy that the old term for casting lots is *nyilazni*, 'to shoot an arrow.'

Before the fates have decided the future of a child, witches may decree it an evil destiny, though this may sometimes be ameliorated. The life of each man is predestined, but, if at midnight one throws gold coins away at a cross-road, he who picks them up surrenders to the other as many years as he takes coins. Traces of foundation sacrifice still persist, the heads of horses or dogs, or the bones of a raven or black cock, being buried in the foundation of the building.

The dog and the wolf were sacred animals to the ancient Hungarians, who made oath by them. After death shepherds and horse-keepers who have suffered wrong during life, as well as those who have been brought to harm by perjury of others, are transformed into wolves, horses, and dogs respectively; and in these forms they obtain requital for the injustice done them.

Folk-charms are numerous, and whatsoever has appertained to, or come in contact with, the dead has magic potency, which may be used either for beneficent or for maleficent purposes; while the hair, blood, etc. of another gives him or her who secretly obtains it power over its original owner. There is a firm belief in witches, changelings, etc., part of which may be borrowed from neighbouring peoples, but much of which may equally well be an inheritance from the pagan period.

LITERATURE.—J. Szinnyei, *The Origin, Language, and Culture of the Hungarians*, 1907; Julius Pauler, *The History of the Hungarian Nation*, 1893; B. Munkacsy, *Aryan and Caucasian Elements in the Finn. Ugr. Language*, 1901 (art. 'Isten'); A. Kováts, 'De antiqua gentili religione Hungarorum,' in *Compte-rendu du congrès scient. internat. des catholiques* (1898) i. 78-105; A. Ipolyi, *Magyar mythologia*, Budapest, 1854 (especially for sources and collection of material); H. von Wlislocki, *Volksglaube und relig. Brauch der Magyaren*, Münster, 1893.

A. SZABO.

HUNTING AND FISHING.—In the history of culture the hunter as a representative of a stage of development in human progress stands between the collector who depends entirely upon the provision of Nature for the roots, fruits, eggs, insects, etc., which he gathers while making no effort to ensure his food supply in the future, and the herdsman whose means of livelihood are his flocks or herds of domesticated animals. By a hunting community must be understood one in which the principal source of food supply is the flesh of wild animals killed or taken in the chase. In an early stage of social development, such a community will continue to employ the methods of the collector for vegetable food. The Tasmanians did not practise agriculture, nor did the aborigines of Australia, except in the west, where the cultivation of purslane is recorded and the heads of the yams were re-inserted in the ground after the plants had been dug up.¹ Some races, however, while still in the hunting stage, have cultivated the ground, even though by such primitive methods as those of the Bushmen. The Indians of North America, excepting the Pueblo Indians, at the time of their discovery were hunters, but practised agriculture to a certain extent, the cultivation of the ground being left to the women. Further, although hunting and fishing may no longer constitute the characteristic industry of a community, and may come to be regarded as a sport, as in dynastic Egypt and other countries of high civilization such as Persia and India, the methods of the primitive hunter survive, and in many cases are the principal or only means of providing a supply of animal food. Throughout the greater part of Africa the peoples, according to the character of their environment, are either agriculturists or herdsmen; but, as they do not, as a rule, eat their cattle,

¹ A. C. Gregory, *JAI* xvi. [1886] 131.

they are compelled to rely upon the chase for fresh meat. It is not uncommon in such cases for the hunters to be a class apart, as, for instance, on the Congo, where men are chosen to lead hunting expeditions on account of their special skill, or in Uganda, where there are professionals, the sons of hunters, trained to the chase from an early age, who do nothing else.

In a hunting community, the conditions of life are not such as to favour either a high standard of, or progress in, culture. Climatic conditions, as a rule, are such as either to absorb the whole time and energy of the people in the provision of the bare necessities of existence, as in Australia, the Tundra region of Asia, and in the extreme north and south of America, or so little effort is required to secure a livelihood, as in the tropics, that it affords no stimulus to advancement. An almost equally effective check on progress is the migratory character of the hunting community, necessitated either by the seasonal movement of the game or by its scarcity. As a consequence, habitations are usually of a flimsy and temporary character, except where the rigour of the climate demands protection against cold and storm; the number of individuals forming the group is comparatively small, because a wide extent of country is required for the support of each member; and social organization is loose, because the solitary hunter has not yet learnt to appreciate the advantage of co-operation and subordination. Authority, in so far as it exists at all, rests with the old men or tends to centre in the skilled hunter.

The natives of Australia, when on their hunting expeditions, erected shelters of interwoven boughs, and, although it is not correct to say of all the tribes that they erected no permanent habitations, some of them, especially in the south and west, lived in huts which were little more than windbreaks. The Bushmen wandered about in small groups; they had no chiefs, and their habitations were screens made from the boughs of trees. Among the Andaman Islanders the sites of the encampments were determined largely by their fitness for the pursuit of game and fishing;¹ of their three types of habitations, the temporary shelter, consisting of a lean-to roof of palm-leaves affixed to two posts, was probably at one time the only form in use; the authority of their chiefs was very restricted; and the group numbered from fifty to eighty individuals. The Negrillos of Central Africa, the rock Veddas, the wilder Semang of the Malay Peninsula, and the nomadic Aetas (Philippines) may be mentioned as further examples of the primitive culture and social organization of the small hunting group. In North America the tribes were all hunters or fishers, with the exception of the tribes of the south-west, but exhibited considerable variety in culture and social organization. Many practised agriculture, especially in latitudes where the maize ripens. The Shoshones had a very loose social organization and an almost entire absence of ceremonial. The Yuina and Seri of California were both at a very low stage in culture; the latter ate their food for the most part raw, had no domestic animals except dogs, and did not practise agriculture. On the plains the buffalo was the chief staple of food and material of industry. Here the social organization was of a more stable and closely woven character, and the chieftainship was acquired by merit; this was no doubt to some extent due to the fact that the methods pursued in hunting the buffalo required concerted action and subordination. The Algonquins and Iroquois of the northern woodlands practised agriculture, and had evolved a highly organized machinery of government. In South America, the Arawak of Guiana, the Botocudo and Bororo of Brazil, the Tehuelche, and the Fuegians—to mention instances only—are nomads with a loose tribal organization and a low type of culture, and are, for the most part, ignorant of agriculture. The Eskimos afford a typical example of a nomadic hunting community which draws its means of existence almost entirely from the animal world, and varies its location, methods, and objects of pursuit in accordance with the changes of season. In Africa, however, where hunting and fishing are universal, even the tribes which may be described as hunters have to a large extent abandoned nomadic habits through the additional means of livelihood afforded by the cultivation of the ground by their women. To the nomad herdsmen and the agriculturists of East Africa, hunting is merely an additional means of subsistence, followed, as by the peasant population of Uganda, partly as a sport, partly through the desire for meat as a supplement to the ordinary diet.

Although the culture of the hunter is, speaking generally, of a rude type, the implements and weapons which he has devised to meet his needs

¹ E. H. Man, *Aboriginal Inhabitants of the Andaman Islands*, London, 1883, p. 126.

indicate a remarkable capacity to adapt himself to his environment, and, within the limits of the available material, to provide himself with the means most suitable for the attainment of his end.

The use of the bow and arrow is almost universal, the blunt arrow being employed in many localities for killing birds. This weapon, however, is not found in Australia or in most parts of the Pacific, except occasionally as a toy. Knives occur in a variety of forms as well as spears. It is, however, in the weapons of a more restricted distribution, devised to meet special circumstances, that the ingenuity and adaptability of the primitive hunter have been most strikingly displayed; as, for instance, in the case of the harpoon, of which the essential feature is that the head should come apart from, but continue to be attached to, the shaft when it strikes the quarry, to mark its position in water, or hamper its escape on land. The blowpipe, used with light poisoned darts, which is found in South Eastern Asia—the Malay Peninsula and adjacent islands—and in the forest regions of South America, and was at one time used in parts of the southern United States, is another example of a weapon admirably adapted to meet special conditions, and especially fitted for use in killing small birds and monkeys in a dense forest country.

It is not merely in devising weapons that primitive man shows this peculiarly acute quality of mind. The methods and devices used in hunting, trapping, and fishing show a capacity for close observation of the habits and psychology of wild animals which, with ready ability, has been turned to full advantage.

Hunting, when considered from the point of view of methods and apparatus, resolves itself into a question of the means by which man seeks to overcome the strength, fleetness of foot, capacity for flight, cunning, timidity, or aptitude for concealment of the animal world. In its simplest form the acquisition of animal food does not differ materially from the earliest method by which a primitive community procures its supplies of vegetable food: in each case, the process is one of simple collection.

In Australia and the Andaman Islands, mussels and shell-fish are gathered at low tide by hand. The 'kitchen middens' of the Neolithic age in Denmark, the shell-mounds of Patagonia, of the Western coasts of both South and North America—to mention instances only—are relics of a population which at some time existed wholly or for the greater part by this means. The collection of insects, grubs, or birds' eggs, especially sea birds' eggs, involved as a rule no special measures. Sometimes the birds themselves were taken from the nest by hand, as the natives of Gippsland took the cockatoo. In California, in Tasmania, and in Australia on Lake Alexandrina, shell-fish were obtained by women by diving. The Eskimos of Alaska have been known to catch a seal simply with the hands as it tried to escape across the ice. The Australian women catch flounders, mud fish, and the like under the soles of the feet while wading. The beginning of the use of appliances in fishing may be seen in the branch of a tree employed by tribes of the north-west coast of America to dip up fish spawn from the water, and in the gunny bag held in the water by the Australian women, when the river is in flood, to catch small fry as they swim down stream. In these cases, no pursuit of the prey is involved, and this is also the case when, either by accident or as the result of observation, the prey is found in its lair. In California, the Indians used to cut down trees, sometimes as many as nine or ten, one after the other, in the hope of finding a squirrel in its nest. In Australia, the bark of the tree was examined for marks of the opossum's claws; when its nest was found, the animal was dragged out and killed.

Failing the discovery of the lair, the hunter stationed himself at some spot which, to his knowledge, was frequented by the animal, either a water-hole or a track leading to the water-hole, or some spot at which it came to feed. In the Torres Straits, the native, having observed the invariable route by which pigeons return from their feeding-grounds day by day, stations himself in a tree near their line of flight, and with a long slender stick attached to his wrist knocks the birds down as they pass. In Hinchinbrook Island, fires were built under the trees in which the birds roosted, while on the Tully river cockatoos were knocked off their roosting-places at night with a long cane.¹ In the winter the Eskimo takes advantage of the habits of the seal and waits by the holes at which it comes out to breathe, or, later in the year, spears it as it basks in the

sun. The Ekoi build platforms on the trees visited by the bush beasts, from which they kill the animals as they eat the fruit on the ground below.¹ It was, however, in running down animals that the savage hunter displayed the greatest endurance. The Australian hunter captured the kangaroo by pursuit only, following it until it was exhausted. The Tasmanians ran down the emu, and the natives of Hawaii the goat.² The Wailaki Indians of California hunted the deer on foot, men posted at intervals along its trail taking up the following in relays.

The pursuit of wild animals with the object of securing the prey by tiring it out demanded exceptional speed and endurance, while the result must, not infrequently, have been disappointing. Primitive man has, therefore, preferred, as a rule, to rely upon other means of approaching sufficiently near to his prey to enable him to disable and kill it. Both tracking and stalking require highly trained powers of observation combined with great skill to avoid attracting the attention of the quarry through its senses of smell, sight, or hearing. Record has frequently been made of the ability with which primitive peoples move noiselessly through jungle and forest without disturbing a twig.³

Most hunting races, however, do not rely entirely upon their own skill in tracking; they have utilized the natural instincts, speed and scenting powers, of the dog.

The Australians employ the dingo in hunting the opossum, emu, and kangaroo. In hunting the musk ox, the Eskimo dogs outstripped their masters and held the animals at bay until the latter came up. In the Malay Peninsula only the tribes use the dog. The Benua-Jakun, while floating down a stream in his canoe, sends his dog through the woods along the bank to hunt the mouse-deer. In Southern Nigeria the Ekoi also train their dogs to hunt by themselves. Both the Boloki (Congo) and the Ekoi perform certain rites over the dogs before they are free of the bush, to make them courageous and of keen scent.⁴ The hunting leopard of India and Persia and the hawk in Europe and in Tartary, as recorded by Marco Polo, are other instances in which the natural instincts of animals have been utilized by man in hunting. In fishing, the employment of the remora, or sucker-fish, by the natives of the Antilles and the Australians to hunt the turtle or dugong is a curious analogue.

In approaching the quarry, advantage is taken of shelter, both natural and artificial. The Australian, when hunting duck, swims beneath the surface of the water, while breathing through a reed. On the Nile, the ancient Egyptians hunted duck in much the same manner, covering their heads with a calabash; while in China it used to be the custom to catch swans by placing a basket containing bait on the head of the swimmer. Convenient trees, shrubs, or tufts of grass were used to cover the approach of the hunter; sometimes branches, small bushes, or bunches of grass were carried in the hand. The Bushman crept up behind a grass screen to the herds of antelopes, ostriches, or other game; the Australian used a screen of bushes, or in some districts a collar-like head-dress, when stalking the emu.

The appearance of the animal to be caught is frequently imitated.

The Bushman hunted the quagga, which grazes with the ostrich, by covering himself with the skin of one of these birds, imitating their action in feeding by means of a stick thrust up through the neck. Among the Dogrib Indians, two hunters covered themselves with the skin of a reindeer, the first holding in his hands bushes against which he rubbed the head of the animal in imitation of its action in feeding. In North America, in driving the buffalo one of the hunters, dressed up in a buffalo skin, enticed the herd to the edge of the precipice towards which it was desired to drive them.⁵

Various forms of decoy were employed.

A method frequently used in Australia was to fasten a wounded bird to a tree. It then attracted others by its cries.

¹ P. A. Talbot, *In the Shadow of the Bush*, London, 1912, p. 146.

² O. E. Dutton, 'Hawaiian Volcanoes,' *U.S. Geol. Surv. 4th Ann. Rep.*, 1882, p. 137.

³ See Man, *Andaman Islands*, 143; O. G. and B. Z. Seligmann, *The Veddas*, Cambridge, 1911, p. 397; Skeat-Blagden, *The Pagan Races of the Malay Peninsula*, London, 1906, I. 200 f.; E. B. Tylor, *Anthropology*, do. 1884, p. 207.

⁴ Talbot, 147; J. H. Weeks, *Among Congo Cannibals*, London, 1913, p. 233.

⁵ W. T. Hornaday, in *RSI*, 1887, pt. II, p. 483.

¹ N. W. Thomas, *Natives of Australia*, London, 1906, p. 98.

Sometimes the cry of the bird was imitated by the hunter. The Botocudo attracted the crocodile to the bank by rubbing its eggs one against the other. Another form of decoy was an imitation of the action of the prey of the bird or animal. The Australians attracted pelicans by throwing shells into the water, imitating the splashes made by small fish.

The use of snares, usually set in a path frequented by game or at the approach to a water-hole, is wide-spread. The initial stage in the use of bait, snare, and trap is seen in a method adopted in New South Wales to catch birds of prey by attracting them with a piece of fish held in the hand of a man who pretends to be asleep, and in the practice of catching cormorants by posts set in the water upon which the birds alight and are noosed by the hunter who swims out to them.¹ A somewhat similar method is employed by the Eskimos in catching gulls: a hunter stationed inside a snow hut with a transparent slab of ice in the roof catches the birds by the feet as they alight on the top. The noose appears in its most highly developed form in America as the lasso of the American Indian; another appliance similar in its action of entangling but with the addition of the action of stunning is the bolas, a weapon found among the Eskimos and in South America, which consists of a number of ropes fastened together at one end and each having a weight at the other end. The noose anticipates the use of the snare, whether it is used in the hand, as in the capture of the crocodile in Northern Australia or in taking the turkey bustard in Queensland, or attached to fixed posts—a method followed, also in Australia, in catching duck—or fastened to a pole held in the hand, as the Californian Indians caught birds and the Panamint Indians the lizard, after its attention had been attracted by a grasshopper at the end of a line on a rod. The use of bird-lime, though hardly falling within the category of a trap (a term which usually connotes some hidden mechanism), represents a simple form of self-capture. On the Tully river in Australia, the natives catch cockatoos by placing bird-lime on the roosting branches. The Semang, the Berembun, and the Jakun use bird-lime; the Besisi fix rattans smeared with bird-lime on notches cut in trees for the purpose, while the Sakai catch large numbers of gregarious birds, such as the padi bird, by limed strips of rattan spread on the ground. An analogous device employed by the Semang consisted of strips of bamboo smeared with poison and spread in the paths.²

In the Malay Peninsula and in Borneo, advantage is taken of the argus pheasant's habit of rooting up grass to clear its dancing ground, by fixing sharp-edged strips of bamboo in the ground, which cut the throat of the bird when it tries to pull them up.³

In Australia, advantage was taken of the wallaby's habit of running with its head down, to stretch nets across its path. It was also caught in pits designed to break its legs. The pit with sloping sides is frequently employed, especially in taking big game, a common practice, as in the case of the pits of the Boloki on the Congo, being to put prongs or spikes of wood at the bottom to injure or kill the animal.⁴ The pits are concealed by rushes, boughs of trees, grass, or leaves, or sometimes a board, which the weight of the animal breaks down or tilts. In Central Africa, in the case of buck, fences, sometimes miles in extent, were built to guide the animal to the pit.⁵

A 'foot-trap' used by elephant hunters in Uganda was a deep hole slightly greater in circumference than the elephant's leg, at the bottom of which was a sharpened stake in which a deep notch had been cut. This spike was broken off by the animal's

¹ N. W. Thomas, p. 88.

² Skeat-Blagden, I, 204, 209, 216.

³ *Ib.* 216 f.; Hose-McDougall, *Pagan Tribes of Borneo*, London, 1912, i, 148.

⁴ J. H. Weeks, 145.

⁵ A. Werner, *Natives of Central Africa*, London, 1906, p. 189 ff.

struggles to free its leg, and rendered it lame. A form of trap or snare used in Tibet, Uganda, and other parts of Africa, was a ring made of creeper or other material in which were set sharp thorns, spikes, or pieces of wood or bone pointing inwards. This was fastened to a stake and then placed in or above a small hole.¹ Another common form of trap is that in which a catch is released by an animal passing along a path. The guillotine trap, of frequent occurrence in Africa, is a heavy log with a sharp spear-head, sometimes poisoned, set in one end, suspended from a tree. This was commonly used for big game, e.g. in the Bulemezi district of Uganda, for elephants,² and by the Anjanga for leopards and lions.³ Closely allied to this form is the spring trap, the spring usually being a sapling bent down over or near the path and fastened with a twig, which, on release, tightens a noose around some part, usually the leg, of the animal. Among the Anjanga, the release was a gate-like arrangement designed to catch a buck by the leg or a small animal by the neck.

In another form of release trap, the spring may set in action a bow and arrow, as among the Gilyaks, who use a crossbow or a spear, and in the Malay Peninsula by the Sakai and Semang. The Mantra placed a poisoned spike at the end of the sapling which formed the spring. An effective combination, consisting of a fence with spear-traps set in openings at regular intervals, is used by the Johor Benua and Berembun tribes.⁴ Snares and traps have at all times been much used in North America. Among the Dénés, the beaver is caught by a net let down into its run under the ice. The traps in which the tribes caught martens, lynxes, foxes, and even bears, are mostly variants of the figure-of-four release, in which, on the animal taking the bait, a cross-bar or other appliance falls and causes death.⁵ The net may be used simply as a snare or fence, being stretched across the path which an animal is expected to take, or it may be manipulated by hand. The Euahlayi tribes of Queensland in catching pigeons employ a net, one side of which is pegged to the ground, the other fastened to a rod, throwing it over the birds as they settle on their water holes.⁶ In ancient Egypt the clap net was used in catching duck.

In some of the cases mentioned above, pits and other forms of traps are used in conjunction with a fence intended to make the capture of the animal more certain by guiding it to the trap. Fences of nets or stakes are frequently used with this object in view, but, instead of success being dependent upon the chance wanderings of the animal into the enclosure, it is made to depend upon the efforts of the hunters themselves, who entice or drive single animals or herds into the snares or between the fences. The operation of driving is one of the most frequent methods of organized hunting employed among primitive peoples, when once the advantages of co-operation have been appreciated. The numbers employed may vary from two, three, or four, the number required for duck-driving in Australia, to the 60,000 mentioned as engaged in the great hunting expeditions of the Incas, when 30,000 head of game would be taken.⁷

In Western Australia, at the moulting time of the black swan the natives lay in ambush, and, when the birds were sufficiently far from the water, they cut them off. A more elaborate method was used in driving duck. A net was stretched across the river or stream, the ends being fixed to posts. Some of the party went up stream and drove the birds down. When the ducks approached the net, they were frightened and caused to rise, while one man whistled like a duck hawk and threw a piece of bark in the air in such a way as to imitate the flight of that bird. The flock dipped, and many were caught in the net.

Fire was not infrequently used to assist the hunter either by driving or by confusing the game. The Seneca hunted deer by night in canoes in the bows of which lights were fixed. At Puget Sound, elk-deer and water-fowl were hunted by torch-light, while the Plains Indians drove the buffalo to the corral by fire. Fire was used in Australia and Tasmania for driving the kangaroo.⁸

The Eskimos and other peoples of the northern parts of North America used sometimes in hunting deer to draw a cordon across a peninsula and drive the animals into the water, where they were easily dispatched by hunters in canoes. Permanent stone

¹ J. Roscoe, *The Baganda*, London, 1911, p. 448; A. L. Kitching, *On the Backwaters of the Nile*, London, 1912, p. 115; A. C. Hollis, *The Nandi*, Oxford, 1909, p. 24.

² Roscoe, 447.

³ Werner, 189.

⁴ Skeat-Blagden, 221 f.

⁵ A. G. Morice, 'The Great Déné Race,' *Anthropos*, v. [1910] 124 f.

⁶ K. L. Parker, *The Euahlayi Tribe*, London, 1905, p. 105.

⁷ T. A. Joyce, *South American Archaeology*, London, 1912, p. 123.

⁸ H. Ling Roth, *Aborigines of Tasmania*, London, 1899, p. 97 f.

fences for driving the deer were erected near the track usually followed by them in the annual autumn migration from their northern feeding-ground.

The Selangor Sakai make frequent use of game-fences, which they build of sticks placed in rows with palm leaves across. These are sometimes as much as 500 yards in length.¹ In Uganda, hunts on a large scale were sometimes organized among the peasantry. Nets stretching over a considerable extent were set up, towards which game was driven with the aid of dogs and then killed by men stationed at the nets.² The Ekoi of South Nigeria, in driving game, use nets which, when joined together, extend for half a mile. These are stretched across the land between the rivers which join to form an angle.³ In Africa the drive was frequently made without net or fence: the hunters surrounded the piece of scrub or bush in which the game lay, and advanced upon it with shouts at a given signal. This was the method followed by the Central African tribes, the leader, carrying the 'medicines' for luck, being in the middle of the line,⁴ and in Uganda in the lion hunts organized by order of the king.

In North America the drive was the most favoured method of hunting the bison. Herds of bison were driven over crags and precipices, but the method more commonly employed was to erect a huge corral, such as was and is still used in Burma in hunting elephants. The buffalo corral was circular. A whole tribe would take part in these drives, and, as soon as the herd had been driven into and shut in the enclosure, women and children climbed on the palisading and speared the animals as they galloped round in their endeavours to escape. After the introduction of the horse, the Indians, among whom the Comanches excelled as horsemen, not infrequently abandoned the corral. Dividing their band into two divisions, they galloped round the herd upon which they closed at a given signal, or else pursued it as it tried to get away.

In ancient Egypt the king frequently took part in hunting wild cattle. The herd was surrounded by troops and people of the neighbouring villages and driven into enclosures. Amenhotep III. records with pride his achievements in this form of sport, and mentions that, on one occasion, he himself slew seventy-six cattle in one expedition.⁵

In fishing, so far as circumstances allow, the same methods are applied *mutatis mutandis* as in hunting. The collection of shell and other fish and the simple operations of catching fish with the feet or hands have already been described. The use of bait, or bow and arrow, spear and harpoon, the devices of attracting fish by the reflexion of fire, by splashing, capture by the net, trap, and the drive—all present analogies to the means employed in hunting animals on land.

One of the most primitive appliances used in fishing, probably representing the earliest dip-net, is the bough of a tree, covered with leaves, which is used to dip up fish spawn on the North Pacific Coast. Most primitive races use some form of dip-net, either to take small fry or to catch fish driven into shallows by other means. At Nutka Sound, sardines were driven into shallows and scooped up with troughs and wicker baskets. A special form of hand-net was used by the Anjanga on Lake Nyasa, which had two handles working scissors-fashion. The ordinary form of hand-net occurs in Australia and in the Malay Peninsula. A very simple form consisted of a basket of bamboo strips used by the Kedah Semang to catch small fish in pools.⁶ At Cook's Inlet, the Kenai used the dip-net to scoop up salmon from stages built in the river. Some doubt was expressed as to its occurrence in America before the advent of the white man, but Cushing dug up a dip-net at San Marco, Florida, while there is little doubt that in Washington it antedates European influence.⁷

The net, in its various forms, is the means upon which primitive man most commonly relies to supply himself with food from sea and river.

The Andaman Islanders at one time used nets eighty feet in length and fifteen feet in depth, with stone sinkers and stick-floats, to each of which was attached a cane leaf. The fish were driven to the net by splashing the water, and speared. In Australia, on the Diamantina, the natives use nets some twenty feet long fastened to two poles. Twenty or thirty of these nets

are used together, each being worked by two men, who swim out into the river. As a rule the net in Australia had no floats or sinkers, although the use of them is recorded on the Darling.¹ The Indians at the mouth of the Fraser River used reef-nets with stone sinkers and cedar-wood floats to catch salmon. On the flats they used the seine net, dragging it over the shoals between two canoes.² In pre-conquest days in South America the net was used both on Lake Titicaca and among the coast tribes. The immigrant strangers, who, according to tradition, landed on the coast of Peru, used nets for fishing.³

The fish trap is distributed almost as widely as the net.

A primitive form of trap in use among the Australians is a hollow log which is put down in a stream for some hours. Baskets and cages are also used.⁴ On Lake Kioja on the upper reaches of the Nile, among the Bakeni, who make their living entirely by fishing, exchanging the fish they do not eat for grain, the men use the fish trap only, while the women use the rod and line.⁵

On the upper reaches of the Fraser and Thompson rivers the Dénés and Carrier Indians use fish traps, among the former bottle-shaped baskets in connexion with a weir; if it is not possible to build a weir across the stream, a pen or corral is built, into which the fish are driven by splashing the water. Basket traps are fixed at one side of the weir, into which the fish swim in trying to escape. An ingenious form of trap is a pot-hanger basket, a screen-like erection at the top of a fall; as the fish in ascending the river leaps the fall, it strikes the screen and falls into the curved pocket at the bottom.⁶

Catching fish by means of a weir, whether in a trap or otherwise, is of frequent occurrence. In Australia, dams and weirs were built across streams, in which nets were fixed, or upon which platforms were built. The platforms were covered with boughs in which the fish became entangled. One of the most famous weirs is that at Brewarina on the Darling, sixty-five miles above Bourke. It is eighty to a hundred yards wide, and extends for over a hundred yards along the course of the river. It is built of stone, is three to four feet high, and consists of a labyrinth of circles and passages in which the fish become entangled and are caught by hand. Stake or bush fences were also built. Movable bush fences were sometimes extended across a water-hole, to which the women drove the fish with bunches of grass and leafy boughs.⁷

Poison is often used either to stupefy the fish, making it possible to take them by hand, or to drive them from their places of refuge.⁸ It was employed by the Australians; and in North America it was used throughout the Southern States. The Californian Indian used soap root after cutting off the water. The use of some kind of vegetable poison is recorded among the Pima, the Tarahumara, the Payas of Honduras, the Moguexes of Columbia, the Peruvians, and the tribes of Brazil and the Amazon.⁹ The Gan on the Upper Nile use poison after the rains when the rivers are full.¹⁰

Many peoples took advantage of the fact that fish are attracted by the reflexion of fire, to fish by night, as did the Californian Indians.¹¹ In Australia (Victoria) a torch is fixed in the bow of the canoe. While it is paddled up stream, a man sitting with his back to the light spears the fish as they swim past him.¹²

The rod, though recorded among a number of peoples, is not very frequently employed. It is in use among the Kedah Semang. Among the Benua-Jakun and the Besis (who, like the Anjanga, attract the fish by striking the water with the top of the rod), angling is left to the women and children; sometimes its use is confined to women, as among the Nilotic tribes¹³ and on the Murray in Australia.¹⁴

The hook used in Africa is usually a piece of bent wire. The Australians used many different materials. A thorn probably represents the earliest form of hook, and is still used with a line in the Malay Peninsula, but the Australian native used vine tendrils, eagle-hawk talons, tortoise-shell carefully moulded by hot stones, etc. The material requiring most care was shell; the beautifully made hooks of this material were the result of a long process of patient grinding, piercing, and polishing.¹⁵

When the game has been taken or killed, the disposal of the carcass is, as a rule, dependent upon a generally recognized custom; usually it becomes the property of the man who first wounded the animal, but the distribution of the various parts

¹ Thomas, 90 ff.

² C. Hill-Tout, *The Far West*, London, 1907, p. 90.

³ Joyce, 125, 220.

⁴ Thomas, 92.

⁵ Kitching, 104, 119.

⁶ Hill-Tout, 92 f.

⁷ Thomas, *loc. cit.*

⁸ For methods used in the Andaman Islands and the Malay Peninsula, see Man, 145; Skent-Blagden, i. 213.

⁹ Mason, 71.

¹⁰ Kitching, 119.

¹¹ Mason, 71.

¹² Thomas, 91.

¹³ Kitching, 104.

¹⁴ Thomas, 91.

¹⁵ *Ib.* 96.

¹ Skent-Blagden, l. 213.

² Roscoe, 488 f.

³ Talbot, 124.

⁴ Werner, 186.

⁵ J. H. Breasted, *History of Egypt*, London, 1906, p. 262.

⁶ Skent-Blagden, l. 205.

⁷ Mason, 'Aboriginal Amer. Zoötechny in Amer. Anthropol., new ser., l. [1899] 53.

of the body is not always in his control, and frequently must also be in accordance with custom.

For example, in Australia among the Kurnai, a catch of eels was distributed among a man's relatives, a large eel each being given to his mother and brother, and a small eel to his brother's children and to his married daughter. The Ngarego man, in cutting up a bear, was allowed to keep the left ribs for himself, but the remainder was distributed among his parents and relatives, certain joints being allotted to each, and the head being given to the bachelors' camp. Other animals were treated in the same way.¹ The same principle is followed among the Ekoi, except that one leg belongs to the townsfolk—no doubt a survival of a communal division.² In Uganda, certain joints were allotted to the men striking the first and second blows, the owner of the land on which the animal was killed, and of the dog which pulled it down. The bones of an animal were given to the god of the chase, while the head was eaten on the field, as it could not be taken into a garden or house because the ghost of the animal was believed to be attached to it.³

Rights of ownership of the land or hunting rights over the land are important in the hunting community and clearly recognized. In New Guinea, at Waga-Waga and Tube-Tube, the reefs near a hamlet are regarded as its special property; when the old men of the hamlet have placed a tabu on them, no member of another community will use them for fishing. If there should be no sign on the reefs, any one may fish from them, but the hamlet shares in any fish taken.⁴ Among the various Naga tribes of Manipur and among the jungle tribes of the Malay Peninsula, the sites of fishing weirs are held to be the property of the village near which they are situated. In Manipur, if an animal is killed on ground regarded as the property of another tribe, it is usual to send a portion of the kill to that community.⁵ On the Congo, the Boloki usually send the head of the animal to the headman of the town on whose ground they kill.⁶

Among many hunting peoples certain animals or certain parts of animals are not eaten, either by custom, for which various reasons are assigned, or by an express tabu. The most familiar instance is the very general prohibition against eating the flesh of the totem animal. Some peoples do not as a rule eat the flesh of wild animals, e.g., the agricultural Akikuyu of West Africa, although under the influence of the Akamba they are beginning to do so; fish they still avoid as making them unclean.⁷

Among the Nandi, most of the clans have some prohibition laid upon them in connexion with animals. The Kipolis clan may not make traps, and, although its members may hunt, they may not wear the skins of wild animals except the hyrax. The Kepumwi clan, which lives by the chase, may not eat the duiker or the rhinoceros; other clans may not eat game at all, and so forth throughout.⁸ Although fish is the chief staple of diet of some of the Déné tribes, others despise it as food; while among the southern tribes, e.g. the Navahos, even contact with fish is regarded with horror.⁹ The Ekoi will not eat the flesh of a certain white spotted antelope, except after an elaborate ceremony to make the flesh fit for consumption; a woman is bound to give her husband part of the catch, but certain fish he must not eat or he will be killed in the bush; nor must a woman eat an animal caught in her husband's new trap.¹⁰ The Eskimos will eat the flesh of the musk ox only in the last resort.¹¹ In Australia, a complicated body of rules limited the parts and species which might be eaten by boys, young men, girls, married women, and so on. Among the Wotjoballuk, for instance, boys might not eat the kangaroo, while men under forty might not taste the flesh of the emu or bustard. The penalties for transgression varied from grey hairs to death while uttering the cry of the animal eaten, the spirit of which had entered the body of the transgressor.¹²

The belief that an animal possessed a ghost or spirit was also responsible for the Baganda custom of drawing the nerve from the tusk of the elephant, in which it was believed the ghost resided. This was buried and the place of burial marked with stones; because, if any hunter stepped over the place, the ghost would cause him to be killed by an elephant in the next hunt.¹³

Reluctance to kill a certain species is not always explained as due to religious feeling or to a tabu. It may be the result of a transference to animals of modes of thought proper to man. This may be

¹ Thomas, 107 f.

² Talbot, 143 f.

³ Roscoe, 448 f.

⁴ C. G. Seligmann, *The Melanesians of British New Guinea*, Cambridge, 1910, p. 576 f.

⁵ T. O. Hodson, *Naga Tribes of Manipur*, London, 1911, pp. 56, 58; Skeat-Blagden, 209 f.

⁶ Weeks, 232.

⁷ W. S. and K. Routledge, *With a Prehistoric People*, London, 1910, p. 50.

⁸ Hollis, *Nandi*, p. 8 ff.

⁹ Morice, 133.

¹⁰ Talbot, 142, 270, 408.

¹¹ W. J. Sollas, *Ancient Hunters*, London, 1911, p. 362.

¹² Thomas, 107.

¹³ Roscoe, 447.

illustrated by the primitive attitude of mind towards such of them as might be able, if animated by human motive, to avenge the death of a member of the group. Hence the reluctance shown by the Dayaks and Malagasy, for instance, to kill the crocodile except in a blood-feud and with special observances.¹

In Sumatra the Menangkabauers follow the same custom in relation to the tiger. Animism and sympathetic magic play a large part in the practices followed before and during the hunt. Some, however, may be due to a chance collocation of circumstances, as the Déné's preference for an old net or other appliance with which he has previously been successful;² or they may form part of a general complex of religious beliefs without any special meaning in relation to hunting or fishing, as in the case of the various abstentions, such as that from sexual intercourse or the avoidance of menstruating women as unclean, practised by these and many other peoples before a hunting expedition or while making their traps.

Where the food supply is precarious or may be easily affected by chance agencies, as it is in both hunting and fishing, it is not surprising to find a primitive people relying upon magic both to increase and to ensure the provision for their needs. The Arunta and other tribes of Central Australia, for instance, perform an elaborate series of magical ceremonies with imitative dances, and make drawings of animals, to increase the food supply.³ A case has been recorded from the Congo of drawings of fish made on the ground by the river, possibly intended to secure a plentiful supply of fish,⁴ while it has been conjectured that the drawings and paintings in the caves of France and Spain were the result of an attempt to secure power by magical means over animals used for food.

A more obvious method is followed by the Nutka wizard. If the fish do not arrive in due time, he makes an image of a swimming fish and places it in the water in the direction from which the fish are expected to come, and utters a prayer for the arrival.⁵ The Cambodian, when unsuccessful in netting, strips and, simulating the action of an animal, runs into and rolls himself up in his net, saying, 'Hallo, I am afraid I am caught.' When an Aleut struck a whale with a charmed spear, he did not throw again, but returned home and lived apart in seclusion for three days, snorting in imitation of a dying whale, in order to prevent it from leaving the coast.⁶ Seligmann⁷ gives significant and instructive accounts of ceremonies preceding hunting expeditions in New Guinea and among the Veddas. The object of the ceremonies is not only to increase the supply of game, but to ensure its capture by anticipatory imitation.

Precautions are frequently taken to secure the efficacy of weapons and hunting methods both by charms and by 'medicine' of various kinds.

The sea-otter hunter of Alaska attached great value to the wooden hat which was held to attract the game. The Dénés hang 'medicine' on their nets.⁸ Among the Baganda, when game was being driven into nets, charms were hung at regular intervals to prevent it from breaking through. The elephant-hunter, after sharpening his spear, deposited it overnight in the temple of the god of the chase.⁹ The Boloki, before an elephant hunt, used to summon the medicine-man, who spent two or three days making medicine to catch the spirits who divert the game from the traps; every one who was to take part in the hunt chewed red pepper and the fruit of a certain plant. If any one refused or did not spit the mixture out in the proper way, the hunt was abandoned. Several of the Ekoi *juju* are specially connected with hunting. Before an expedition each member sacrifices to his *juju*; and, if a leopard has been killed recently, its skin is rubbed with *juju* leaves, while a prayer is offered to its spirit that it may go on the left hand to drive the game to the hunter and help him to kill a leopard should one be met.¹⁰ In New Guinea a great variety of hunting and

¹ H. Ling Roth, *Natives of Sarawak*, London, 1896, l. 446 f.; J. Sibree, *Great African Island*, London, 1880, p. 269.

² Morice, 122.

³ Spencer-Gillen, 177 f.

⁴ H. Ward, *The Voice of the Congo*, London, 1910, quoted by H. G. Sparring, *Childhood of Art*, do. 1912, p. 66 f.

⁵ F. Boas, *Rep. on the N. W. Tribes of Canada*, London, 1890, p. 45.

⁶ I. Petroff, *Rep. on the Population, etc., of Alaska*, Washington, 1884, p. 154 ff.

⁷ *Mel. of Brit. New Guinea*, 292 ff., and *The Veddas*, 210 ff.

⁸ Morice, 141.

⁹ Roscoe, 445, 448.

¹⁰ Talbot, 145.

fishing charms are in use. The Koita, for instance, in hunting the pig, wear a tarsal bone of that animal on the arm to compel other pigs to come to them; in hunting the wallaby they blacken part of the face with the burnt bark of an odoriferous tree; they rub stones taken from the stomachs of alligators, pigs, etc., on the teeth of their dogs, and, before hunting, give them the bark of certain odoriferous trees boiled with sago. The last-named charm is especially efficacious if pieces of mullet are added, because these fish jump 'quick and strong.'¹ Charms of quartz crystals, highly polished pebbles, etc., after being heated with a fire-stick, are applied by the Koita to a corner of a fishing net to make it smoke before it is taken to the beach, while in the case of a dugong or turtle net the claw of a raptorial bird is placed under the net for a few minutes, or the fumes of gum resin on hot embers are made to rise through the net.²

On the other hand, there are certain actions that must be avoided, as they may affect the supply of game in the future, or may defeat the hunter's efforts in a particular instance. The animal which is slain must be treated with respect, and it may be even necessary to offer it apologies. Those of the Nandi who are prohibited from killing rhinoceros are not so strict as they once were in regarding the prohibition, but, when they kill the animal, they apologize.³

Among the Laos, the hunter must not wash for fear the wounds he gives may not be mortal.⁴ In Alaska, during the whaling season, the women must remain in comparative idleness, as it is not good for them to sew while the men are in boats. Any repairs to garments which are absolutely necessary must be done out of sight of the shore. The conduct of those who stay at home is believed seriously to affect the success of the hunter. The Bushmen attributed bad shooting to the children playing on the men's beds.⁵ In East Africa, elephant hunters believe that the husband of a woman unfaithful during his absence will be killed.⁶ In Toaripi, or Motumotu, New Guinea, during a hunting expedition the fire must not be allowed to go out, and the inmates of the men's club-house must abstain from certain foods and from taking anything that belongs to others.⁷ The Blackfoot Indian would not eat rosebuds when trapping the eagle; for, when it alighted near the trap, the rosebuds in his stomach would make it itch, and it would scratch itself instead of taking the bait. Nor in putting up the trap would he use an awl, as the claws might then scratch him.⁸ Any failure to treat the animal slain with proper respect, it was believed, would offend its relatives and lead to a scarcity of game. Among the Thompson Indians, precautions were taken to butcher the deer carefully and cleanly; the blood and offal were buried. If this were not done, the other deer would not present themselves to be killed. Deer meat was never taken through the common doorway of the lodge, because it was open to women who were ceremonially unclean. If the father of a pubescent girl went out to hunt, it was believed that the deer would evade him.⁹

Among many tribes, especially in North America, precautions are taken that the bones of the animals they kill may not be defiled through being eaten by dogs, or in some other way. Sometimes they are burned, sometimes thrown into a river, sometimes preserved in or before the house. Neglect of these precautions would make it impossible to catch other animals of the same species. Both in North Western Canada and in North Eastern Asia the bear is treated with peculiar respect, as is not unnatural in view of its value and strength. Indeed, in the latter region, the ceremonial which attends the bear sacrifice suggests that it is looked upon as an object of worship, if not as a deity. When hunting the bear, the Dénés begged the animal to come to be shot; it was petitioned not to be angry and not to fight. Sometimes the bear was thanked for allowing itself to be killed. When the flesh of the head had been eaten, the skull was placed on a high pole as a mark of respect, and, if this was omitted, it was believed, the other bears would not allow themselves to be killed. This custom of placing the skull on a pole, usually situated at one end of the hunter's house, is found throughout the two regions mentioned above. Among the Ainus, bear hunting was the chief occupation. It supplied the staple of their food

¹ Seligmann, *Mel. of Brit. New Guinea*, 177.

² *Ib.* 178.

³ Hollis, *The Nandi*, 6.

⁴ E. Aymonier, *Notes sur le Laos*, Saigon, 1885, p. 269.

⁵ W. H. I. Bleek, *A Brief Account of Bushman Folklore*, Cape Town, 1876, p. 19.

⁶ P. Reichard, *Deutsch-Ostafrika*, Leipzig, 1892, p. 427.

⁷ J. Chalmers, 'Toaripi,' *JAI* xxvii. [1898] 333.

⁸ G. B. Grinnell, *Blackfoot Lodge Tales*, London, 1893, p. 237 f.

⁹ Hill-Tout, 167 f.

and the material for their clothes, and was the central object in their ritual (see AINUS).

Apart from the question of whether in these and other cases the animal is worshipped and regarded as a god, it is clear that the ceremonial slaughter, in which the custom of shooting the victim with arrows is peculiarly suggestive, falls into line with the seasonal ritual which is, as a rule, intimately connected with food supply. Primitive races do not recognize a close season in hunting, but climatic, social, or religious conditions, or conditions connected with the natural history of the animal, sometimes enforce a period of rest from the pursuit of a particular species. In Central Africa the growth of vegetation, in the Arctic and sub-Arctic regions the rigour of the winter and the migration of species, make a change in methods and objects of pursuit imperative. Among the Nāgas, a *genna*, or tabu, forbids all hunting during the agricultural season. Where such causes as these are operative, the primitive mode of thought requires the hunting season to be inaugurated by a special ceremony to obviate the risk which attaches to a spiritually dangerous operation, as well as secure by a due observance of ritual that the future supply of food will not be endangered by an oversight or mistake.

LITERATURE.—See references in footnotes.

E. N. FALLAIZE.

HUNTINGDON'S (COUNTESS OF) CONNEXION.—The Countess of Huntingdon's Connexion is a loose confederation of about 45 urban congregations, akin by origin to the Calvinistic Methodists, making some use of the Anglican liturgy and the Thirty-Nine Articles, worshipping in buildings held by trustees with nominally absolute powers, assisted now by a conference of representatives. The founder, the Countess of Huntingdon, Selina Shirley (1707-91), daughter of the second Earl Ferrers, was attracted in 1739 into the first Methodist Society by George Whitefield. John Newton declared that at this time he was not sure that there was in the whole kingdom a single parish minister publicly known as a gospel preacher. She, therefore, approved Whitefield's plan of lay preaching, and her seat of Donnington Park became a centre of itinerancy over the Midlands. The death of her husband (1746) left her in the prime of life free and rich. On the return of Whitefield from Georgia she relieved him of his money difficulties and appointed him her chaplain. In this capacity he conducted frequent meetings in her drawing-room, and introduced Methodist influence to society circles, while his Moorfields congregation invited her to lead the movement. She now faced two revival problems—how to secure evangelical preachers, and how to ensure that given places might have continuity of evangelical preaching. The universities could by no means be relied upon for the former; the system of patronage endangered the latter; while the system of lecture-ships, previously devised to ensure it, had been declared illegal.

The latter problem was the easier, and she solved it not by buying up livings, but by developing her rights as a peeress. The Calvinistic evangelicals in the Church of England rallied round her, and she appointed many clergy to be her chaplains; as pluralities were common, several of them continued to hold livings while often travelling in her service. On the theory that she might have a private chapel exempt from episcopal jurisdiction attached to each of her residences, she acquired property in fashionable resorts like Cheltenham, Brighton, Bath, and Tunbridge Wells, and erected chapels. These were frequented by people who declined to countenance the Methodist field preaching, but who found no help in the official churches

and chapels of ease; many were of the leisured classes. So successful was the experiment that other towns were similarly treated, from York to Lewes, from Norwich to Swansea; and the Countess moved her chaplains about as she deemed best. Her influence was at its height in 1768, when, after a vain remonstrance with Archbishop Cornwallis on the bad example of his wife, she brought on him a severe rebuke from the king. This naturally did not increase the friendliness of the bishops, and in her desire for evangelical clergy she adopted a still more independent attitude, resembling that of the Old Dissent.

Howell Harris, the Calvinistic Methodist, had acquired large premises at Trevecca, whither a number of Welsh evangelists had migrated. On this place she fixed for a Seminary, and on her 61st birthday (24th Aug. 1768) Whitefield opened it, for training at her expense young preachers who should be free to work within or without the Established Church. She appointed as President John Fletcher, who often came across from Madeley to take his duties seriously. A resident master was sought, whose prime qualifications were to be faith and power from above, devotedness to God's cause, and Christian experience. Greek, Latin, Divinity, and the Sciences were to be taught. From 1768 onwards the Seminary not only sent forth earnest recruits for work in Britain, Ireland, and America, but was the Keswick of its day, whither huge crowds resorted every August.

In 1770 the Wesleyan Conference passed resolutions which led to a falling asunder of the Arminian and Calvinistic wings of the revival army. The Countess decided to establish a great London centre for the Calvinists, and bought fine premises in Spa Fields, which had been first a pleasure resort, and then a proprietary chapel. Retaining, as usual, a small part as her technical residence, she evidently destined the main building to be her cathedral. A neighbouring clergyman, therefore, successfully tested the legality of her proceedings by actions in the consistory court of the Bishop of London (1779). This crisis considerably altered the character of the movement. Some of her sixty chaplains severed all official relations with her; others broke with the Establishment, and took licences under the Toleration Act. She guarded these by registering her buildings for Dissenting worship. This, however, was hardly more than a technicality, for the liturgy was used almost unchanged, and the Thirty-Nine Articles were taken as the basis of a new Confession. The gaps caused by the defection of some chaplains were partly filled by students from Trevecca. As the bishops grew more reluctant to ordain these, the final breach occurred in 1783, when two of her clergy openly ordained six students in Spa Fields. This emboldened Wesley to follow suit next year.

The Countess proposed to consolidate the movement by forming an Association of ministers and laymen, somewhat on the lines of the Old Dissent, but was persuaded to bequeath all her chapels absolutely to four trustees. The Seminary was at once transferred to Cheshunt, and became the centre of gravity. The foreign missionary movement inaugurated by Carey was taken up enthusiastically, the London Missionary Society being formed at Spa Fields (1795), and the college supplying numerous volunteers.

The itinerant system inherited from the Countess has given place to comparative fixity of tenure, and the Congregationalists have shown themselves ready to disregard all differences and to welcome into fellowship; but the disintegration was checked in 1899 by Chancery. The college is now at Cambridge, while the trusts encourage continuous service within the Connexion.

LITERATURE.—*Life and Times of the Countess of Huntingdon*, 2 vols., London, 1844; Sarah Tytler, *The Countess of Huntingdon and her Circle*, London, 1907; L. Tyerman, *Life of George Whitefield*, 2 vols., London, 1878-77; J. P. Gledstone, *Life and Travels of Whitefield*, London, 1871. W. T. WHITLEY.

HUPA.—The Hupa Indians in N. W. California, linguistically classified with the Pacific Coast division of the Athapascan stock, represent in matters of religious belief and practice a culture area which includes W. Oregon and N. W. California. As regards particular ceremonies even, Indians of other linguistic stocks, the Karok and Yurok on the lower Klamath river, join with the Hupa in their celebrations, and seem to feel that these ceremonies are common possessions.

1. Rites and ceremonies.—Three ceremonies of importance used to be held annually for the benefit of the entire community.

(1) One of these, called *Haitcildilye*, 'Winter Dance,' is held late in spring, at the close of the rainy season. Its purpose is to drive away and prevent epidemics, and to preserve the good health of the people. The first half consists of ten nights devoted to singing and dancing round a fire in the sacred house. This house differs from the other primitive dwellings only in the traditions connected with it, and in the restriction that persons of illegitimate birth are excluded from it. The dancing is done by several individuals, who circle about the fire, with their hands on the shoulders of the persons in front of them. A dance, which is a test of endurance, about a very hot fire, takes place at the conclusion of the last five nights of this part of the ceremony. No clothing is worn, and, because of the limited size of the room, the dancers are exposed to the fierce flames. The songs sung during the dancing are looked upon as the chief means of frightening away disease. The concluding portion of the ceremony occupies ten days, and is similar to the autumn dance described below, except that it is held in another place.

(2) The second ceremony takes place in August or September, and is usually called *Honsiltcildilye*, 'Summer Dance.' It is held out of doors, at certain places near the river, and lasts ten days. The costumes and sacred objects used in the dance are transported in canoes. The faces of the dancers are painted in horizontal lines with black obtained from the charcoal of the fire. A robe of deer-skin is worn either about the waist or from the left shoulder. A band of fur is bound round the head, and a net falls over the hair and neck. Eagle feathers or feathered darts are inserted at the back of the head. Two men, who are to carry the sacred obsidians, have closely knitted head-dresses, which hang nearly to the waist, and a row of sea-lion teeth about the forehead, instead of the band of fur. When the twelve or fourteen dancers are in line, it is noticeable that they are arranged symmetrically, from the middle, where the chief singer stands, to the wings, where boys are usually found. Not only are they graded as to stature, but the decoration and arrangement of the costumes of those equally distant from the centre are similar. Each dancer in the line holds a pole, on which a dressed and decorated deer-skin is draped. These skins all show peculiar natural markings, the most valued ones being those of albino deer, which have been killed in past generations and the skins faithfully preserved as the property of the community. The singing is led by one who has received the songs in a supernatural experience, and is accompanied by the men in the line, both by the voice and by moving the body and the horizontally held deer-skins backwards and forwards, and stamping with the left foot. Men from different localities compete in this singing and dancing, in alternate series of movements. During the first of each

series two men, each carrying a large, beautifully flaked black or red obsidian, move towards each other in front of the line of dancers, who elevate their poles with the deer-skins to let them pass. Afterwards these men take their places in the line, and join in the dancing.

There are two interesting variations in the celebration. One of these takes place on the river, which, because of its swiftness, is difficult of navigation for the 'dug-out' canoes. Two or more of these canoes are filled with standing dancers, who by concerted movements impart considerable motion to the canoes, which are made to move down stream abreast. They approach and recede from the shore ten times before the final landing is made. The song sung is an old traditional one, instead of a new and specially revealed one. On the last afternoon of the ceremony many dancers form a long line on a hill somewhat back from the river and stand facing the south-west, from which direction the immortal first inhabitants of the world are supposed, ceasing their own dancing, to watch that of mortals.

One or two priests prepare the ground at each of the places where dancing occurs, by removing vegetation and objects which would annoy the dancers, and by scattering a sacred powdered root where they are to stand. They then build a small fire a short distance in front of the line, into which they throw the sacred root and tobacco, as they pray for the welfare of the people. During the intervals of the dancing, the priests, or other old men, address the spectators on ethical and religious subjects.

Nothing in the myths or folklore or in the present consciousness of the Hupa seems to give this ceremony a particular purpose. In a general way it is supposed to bring health and prosperity. The positions and movements of the dancers in relation to the deer-skins are strongly suggestive of sympathetic magic, to promote the annual mating of the deer.

(3) In two or three weeks after the completion of this ceremony a third one is begun. It is called *Tunkcitdilye*, 'Autumn Dance,' and is held at the village of Takimmitding. A high fence is erected, in front of which the dancers are to stand. They wear on their foreheads broad bands of buckskin, covered with the scarlet crests of woodpeckers, relieved with white fur above and below. Many strings of shells are worn about the neck. An object of twined fibre is held in the hand while dancing. This resembles in shape the box of elk-horn used in this region to contain the *dentalium* currency. The men stand in line, with a man of exceptional physique in the middle, and a singer on each side of him. The basketry objects held in the right hand are swung forwards and upwards, and then brought down with a stamping of the left foot. One of the singers leads with a song, and the dancers accompany him, with vocables loudly uttered. When each of the singers has sung, the deer-skin robes are dropped from the waist to the ground, the baskets are placed on them, the dancers join hands and jump, raising both feet from the ground. Occasional rests are taken, the dancers squatting on their heels. As in the ceremony described above, groups of men from the two geographical divisions of the tribe compete in the alternate performances. The celebration lasts ten days, the last afternoon being the most important and the most largely attended. Its object is said to be to maintain the health of the people. A myth indicates that the first intention of the originator of the ceremony was that it should renew the youth of the aged who were to participate in its benefits. Being unjustly attacked, he took the dance, regalia, participants, and all to another world. The present human celebration of it is a less potent copy.

None of these dances or general ceremonies can be held until a valuable present has been made to the next relative of all persons who have died since the last similar settlement.

VOL. VI.—56

In the autumn, when the acorns have fallen in considerable quantities, a feast is held. Fresh acorns are ground, leached with tepid water, and made into mush by women designated for the office. When the people have gathered about noon, the priest leaves the sacred house and goes to the feast-ground. No one is allowed to look at him as he passes, for he impersonates the god of vegetation. He builds a fire ceremonially, and places stones in it, which are to be used by the women to cook the mush by dropping them hot into the baskets in which it is contained. First the priest and then the other men go to the river for a bath. The women wash their hands and faces only. The mush is served to the people in baskets, as they sit on stones, which remain from year to year in a circle about the fireplace. Fish, cured and fresh, are served in addition to the acorn mush. When the people have eaten, the priest places in the fire all the food that remains, and prays that the new crop may not be stolen by the birds and rodents, and that even in small quantities it may nourish and sustain the people. The stones used in cooking are deposited with those of previous years, and are never used again, or touched, except by the priest who keeps them in an orderly pile.

There are priests in whose families it is the traditional duty to catch the first lamprey eels and first salmon of the season, and perform a ceremony that shall ensure an annual run of these in large numbers and of excellent quality. A long formula is repeated by the priest, the object of which is to prevent certain evil supernatural beings at the mouths of the rivers from stopping the migrations, and to guard against the offending of the fish by the breaking of tabus. The eels and salmon caught are eaten by people who gather for the purpose, but the number so caught is usually insufficient for a considerable feast.

There are several ceremonies of a public character, the benefits of which are for particular individuals. The breaking of one of the many tabus connected with deer results in the enslavement of the offender's soul by the beings who are believed to own and care for the deer. When this has happened, the unfortunate man loses his health, and, upon ascertaining the cause, calls in a priest learned in this particular. A night is spent in song and prayer, in which several laymen participate, the object being the recovery of the soul. Because of certain offences on the part of the parents, or as the result of several deaths in the family, the souls of children, while they are still living, are supposed to have gone to the world of the dead. They are recalled by prayer, songs, and dancing, which continue during the first half of the first night, and during the whole of the third night. The ceremony is in charge of a priest or priestess, who spends the preceding days with a young girl in the forest, securing the necessary herbs and pitchwood used in the ceremony.

A ten days' ceremony is held for the benefit of each girl at the first appearance of menstruation. During this time she is under the guardianship of an old female relative, who makes sure that she keeps the tabus in regard to food and water, which are allowed her but once a day in combination as acorn gruel, and prevents her contact with people. The girl bathes in a ceremonial way at prescribed places each morning, and afterwards brings wood for the house-fire. Especial care must be exercised in regard to the language and conduct of the girl during this time. Not only will whatever she says happen, but whatever she does will become a fixed habit during her future life. The nights are spent in song. Several times during the night the men come into the house, where the girl is com-

pletely covered with a blanket, and sing over her, shaking rattling wands as an accompaniment. After the men withdraw, the women, who remain, sing songs of their own. This ceremony and the keeping of the tabus are supposed to procure long life and a desirable disposition for the girl.

A shaman, or medicine-man, first undergoes training during several months under the care of an older shaman. He is required to restrict his supply of water and food, and engage much in bathing and in smoking of tobacco. The nights, especially towards the close of his training, are spent in dancing about a fire in a large sudatory. Men and women join in the songs, and keep time with their feet as they sit about the sides of the room. The candidate must show his ability to control certain imagined semi-material objects, called 'pains,' injecting them and removing them from himself and others at will.

Besides these shamans with supernatural power, the singers at the greater ceremonies with supernatural gifts, and the priests charged by inheritance with the celebration of the dances and feasts, nearly every adult knows several formulæ for some particular object, such as hunting, fishing, gambling, love-making, and the cure of ailments. These formulæ are generally repeated over some fragrant herb, which is applied to the body, internally or externally, or to the weapons and implements concerned. The formulæ recite the discovery of the remedy or power by a supernatural person, its first application, and the wonderful results which followed. A prayer is addressed to this being, and an offering of tobacco made by blowing it in a powdered form from the hand. One may secure from another the benefit of one of these formulæ by the payment of a reasonable fee. Care is taken, in reciting them in the presence of others, to chant them in such a manner that they are not understood. Many formulæ have songs used in connexion with them, particularly those relating to hunting, fighting, gambling, and love-making. Hunting parties usually spend the night preceding a hunt in continued song and prayer.

The elderly men and the religiously inclined younger ones follow the daily habit of bringing sweat-house wood during the afternoon, taking a plunge into the river after the sweat bath, and spending some time in prayer, sitting naked after the bath. When a particular boon is desired, the men go to some high, wooded point, trim the branches from near the top of a large Douglas spruce, and stand naked in the acrid smoke of the green brush throughout the night. Bathing in certain pools, believed to be dangerous because they are the haunts of water-monsters, is productive of good luck. Whenever occasion suggests, extempore prayers are resorted to, accompanied by burning the sacred root.

2. Religious beliefs.—The Hupa believe that they sprang spontaneously into being from the ground, in the same locality in which they have lived since they have been known by white men. They claim to have been preceded by a race of similar origin—immortals, who, by their correct behaviour, fixed for the mortals destined to follow them the traditional conduct for all situations in life. Their chief, *Yimantuwingyai*, gave shape to the world according to his whims, provided some of the ceremonies, and rid the world of the monsters that preyed upon men. His wives, to whom he had been unfaithful, brought death into the world, and frightened the immortals from it. The latter fled to worlds beyond the Pacific Ocean and above the sky, where they still practise the perfect ways and celebrate the dances. *Yimantuwingyai* presides over one community of them, and his son over another. They observe the condition of the

earth and its inhabitants during the celebrations of the dances by immortals. *Yimantuwingyai's* conduct was often not above reproach; and the evils in the world, including death, are the results of his uncontrolled passion. He is seldom addressed in prayer.

A god of vegetation, *Yinukatsisdai*, 'he lives south,' was the originator of vegetable food, and still controls its supply by making annual provision according to the care or abuse of the previous crops by the people. He is generally invisible, is small of stature, and always carries a sack of seed.

The deer on the several ridges or mountains are under the care of local gods, called *Tans*. They keep the deer in the interior of their special hills, and let out only those destined as the reward of the hunter who keeps the tabus and sings the required songs. They have the owls for servants. The Hupa seldom mention them, but fear them greatly and direct many of their prayers to them.

The two thunders, at the north and the south, control the weather, sending that which is unseasonable when they are offended by the presence in sacred localities of those who have been be-reaved, and are therefore in a measure unclean. They are appeased by a ceremony conducted near a rock in which the thunders are interested. The particular sort of weather desired is indicated by sprinkling the rock with water, or by carrying coals of fire round it.

There are numerous spirits believed to occupy the interior of mountains, deep pools in the streams, and certain places by the trails. These are not unkind to mortals, with whom they have become acquainted through worship, but are hostile to strangers and the uninitiated young members of the tribe.

The lower world, the abode of the dead, is under the control of a person seldom named. All except shamans and singers at the dances go to this common home regardless of their conduct in life. They appear there in the exact condition in which they have been buried. For this reason the Hupa hold that burials should be conducted with great care. The personal property of the dead is either buried with him or destroyed, apparently to prevent his return for it. Great care is exercised to avoid the reappearance of the ghost, especially in dreams. A five days' ceremony is necessary to free the grave-digger and the family of the deceased from uncleanness.

The heavenly bodies are considered to be persons. The sun is feared as one who consents to all natural deaths, but seems not to be worshipped. The morning star aids the warrior who knows and sings his songs. The white first dawn is worshipped as a maiden, who wishes to behold the faces of her worshippers as many days as possible, and therefore prolongs their lives. Early rising is practised in her honour. Prayers in general are said to be addressed to *Ninisan*, which usually means the earth, but seems capable of a wider meaning, including the universe as known to the Hupa. The conception, which seems to be vague, is decidedly animistic, but seldom personal. The deities mentioned above are perhaps only localizations, specializations of the one pervading soul of the world.

3. Ethics.—Social behaviour is very fully prescribed by tradition. The disregard of the rules of conduct is followed by material and temporal misfortune, but is not directly displeasing to the supernatural personalities and is not punished after death. The divine ones are offended rather by uncleanness, resulting from anything sexual or connected with death. Generosity is followed by blessing of the food supply. Unsanctioned sexual alliances are avoided, as likely to result in off

spring lacking by nature in moral character, and so little esteemed in the eyes of his fellows that his death cannot be avenged. Injuring other persons by word or deed is avoided from fear of retaliation. The avenging of wrongs or insults to oneself or one's relatives is a sacred duty which may be discharged with honour at night from the brush as well as in open fight. In accordance with the same principles and by the same methods, the group, whether the single village against a neighbouring one, or the allied villages against those of another river-valley and of another speech, defend their land and rights, and avenge injury and insults. The final settlement of difficulties, internal and external, is by the payment of money.

LITERATURE.—S. Powers, 'The Indian Tribes of California,' vol. iii., *Contributions to North American Ethnology*, Washington, 1877; P. E. Goddard, 'Life and Culture of the Hupa' and 'Hupa Texts,' nos. 1 and 2 of *University of California Publications of Amer. Archaeology and Ethnology*, 1903, vol. i.

P. E. GODDARD.

HURON.—The Huron were a confederation whose principal members were four Iroquoian tribes—Attignawantan ('Bear People'), Arendahronon ('Rock People'), Attigneenongnahac ('Cord People'), and Tohontaenrat ('White-eared or Deer People')—that, from about 1589 to 1650, occupied a district known as Huronia, lying in the peninsula formed by Nottawasaga and Matchedash Bays, the River Severn, and Lake Simcoe, in what is now known as Simcoe Co., Ontario (see the maps of the region in the Huron period, in Parkman, *Jesuits in N. Amer.*, by A. F. Hunter, in *Jesuit Relations*, x. [ed. Thwaites], and by A. E. Jones, *ib.* xxxiv.). The earliest members of the confederation were the Attignawantan and Attigneenongnahac, who ceremonially termed each other 'brother' and 'sister,' and who had received the Arendahronon and Tohontaenrat about fifty and thirty years respectively previous to 1639 (Lalemant, in *Le Jeune*, *Jes. Rel.* xvi. 227, 229). Among the minor members of the confederacy were the Iroquoian Wenrohonon and the Algonquian Totontaratonhonon, who joined the Huron in 1639 and 1644 respectively.

The term by which this confederacy is known is not Indian, but French, *huron* being a pejorative of O. Fr. *hure*, 'rough, bristling hair,' and having been applied to the peasants of the *Jacquerie* in 1358. According to Lalemant (*op. cit.* 229-231), the term was applied to these Indians by a Frenchman about 1600, because of their style of head-dress. Their native name was *Wendat* (probably meaning 'islanders' or 'peninsula-dwellers'), which appears in a number of variants, and which has been corrupted into their modern designation *Wyandot*.

The Huron were, as Lalemant said (in *Le Jeune*, *Jes. Rel.* xvii. 195), 'only an assemblage of various families and petty nations, which are associated together for the purpose of maintaining themselves against their common enemies'; and hence their religious system was composite, a case in point being the borrowing of the Algonquian rite of marriage to the fishing-net (see below, p. 884^b).

The governmental system of the Huron has been studied exhaustively by J. W. Powell (*1 RBEW* [1881], 59-69), who shows that it was based on a gentile organization 'of consanguineal kindred in the female line,' and that each gens bore the name of some animal, the ancient of this animal being the tutelary deity of the gens concerned. The gentes in the Wyandot period have been Big Turtle, Little Turtle, Mud Turtle, Wolf, Bear, Beaver, Deer, Porcupine, Striped Turtle, Highland Turtle, Snake, Hawk. Of these, the Mud Turtle, Beaver, Striped Turtle, Highland Turtle, and Hawk are now extinct. The Wolf exercise the functions of umpire, mediator, and executive between the two divisions—the first including the Bear, Deer, Hawk, and Snake, and the second comprising all the rest (W. E. Connelley, *Archaeol. Report Ontario*, 1899, pp. 100 f., 105 f.; according to him, the Wyandot represent chiefly the Tionon-

tati, or Tobacco Nation [on which see Mooney, *HAI* ii. 755 f.; for a different enumeration of Wyandot gentes, see Powell, *loc. cit.*]). Each gens possessed a tract of land, which it could change only with the permission of the tribe; and at intervals of two years the women councillors re-partitioned the land. The property, consisting of the wigwam and household articles, was inherited by the eldest daughter or by the nearest female kin; and the personal belongings of the husband, such as clothing, hunting and fishing implements, and a small canoe—large canoes were gentile property—by his brother or by his sister's son. Each phratry had the right to certain religious ceremonies and to the preparation of certain medicines; each gens to the worship of its tutelary deity; and each individual to the possession and use of his particular amulet or charm.

The general picture of the Huron, as given by the early Recollets and Jesuits, is attractive. We are introduced to a people, grave, patient, courteous, and hospitable, modest in demeanour, brave, and, on the whole, industrious. Their faults were those of primitive peoples generally. They were cruel to the enemy, they would beg or steal from the alien, pre-nuptial chastity was lightly esteemed, and their religious rites contained much that was abhorrent to the zealously religious. Their criminal code has been summarized by Powell (*1 RBEW* [1881], 66-68). A girl guilty of fornication was punished by her mother or female guardian; but, if the case was flagrant or neglected, it might be taken up by the council women of the gens. An adulteress had her hair cropped for the first offence, and her left ear cut off for the second. Theft was punished by twofold restitution, and treason was a capital crime. Murder and maiming were compounded (cf. the elaborate accounts given by Ragueneau, in Lalemant, *Jes. Rel.* xxxiii. 235-249, and by Brébeuf, in *Le Jeune*, *ib.* x. 215-223). A secret sorcerer might be killed by any one (Brébeuf, 223; Ragueneau, 219, and in Lalemant, *Jes. Rel.* xxx. 21). If, however, a sorcerer was placed on trial and found guilty, he might appeal to ordeal by fire. Outlawry was of two degrees: if the outlaw continued to commit crimes, he might be killed without fear of clan vengeance; or it might be the duty of whomsoever met with him to kill him (Powell, 67 f.). Suicide was not infrequent; and mere children, if harshly treated by their parents, were apt to hang or poison themselves (Le Mercier, *Jes. Rel.* xiv. 37; Chaumonot, *ib.* xviii. 27-29; *Le Jeune*, *ib.* xviii. 165-167, xix. 171-173).

A trait of the Huron and other Iroquois, as well as of the Algonquin and other eastern tribes, which has always shocked the general reader was their savage cruelty toward prisoners taken in war. No tortures were too terrible to be applied; and the bare recital of them as recorded in the *Jesuit Relations* and similar documents is, it must be confessed, somewhat unpleasant reading. It would appear that to some degree there was a delight in torture for its own sake—a sentiment which appears often in children of the higher races, and of which traces are found among even the most cultured adults. In many instances, further, the idea of personal revenge for the loss of a relative must have played a part. Yet there was also another side, in which, apparently, must be sought the real explanation of this trait. In a case recorded by Charlevoix, *Hist. of New France*, tr. J. G. Shea, New York, 1866-72, ii. 105-110 (repeated by *Le Jeune*, *Jes. Rel.* xiii. 37-79), a Seneca captive was conducted to a Huron village to take the place of the captured nephew of a chief, if the latter so desired. The prisoner was given a bride, was clothed in a new beaver robe, and, feasted in every cabin,

was treated with all kindness. The chief received him with affection, and the captive Huron's sister gave him food as if he were her own brother. With regret, however, the old chief informed the prisoner that his wounds were so severe that he must die, and the captive was accordingly tortured to death. Generally speaking—although exceptions frequently occurred—a captive was treated as well as possible until he reached the village where his fate was to be decided. There he might be adopted in the stead of a kinsman captured or slain; and such adoption was, in reality, based on a belief that the person so adopted was actually the person whom he represented. If tortured, he was expected to show defiance to his tormentors, and to bear every pain with the utmost stoicism. In the midst of his tortures, caressing words were addressed to him, and he would be honoured with delicate touches of firebrands or red-hot hatchets. To the horrified observers of all this, such caresses seemed, with good reason, the irony of demons incarnate; but it may be suggested that these were both intended and received as genuine. The substitute for a hero must die like a hero; if he was a poltroon, he dishonoured both himself and the dead. In him were curiously blended, to the Indian mind, both the enemy and the friend. He must suffer all night until the dawn (Lalemant, in *Le Jeune, Jes. Rel.* xvii. 75; cf. lxi. 65), doubtless in honour of the war-god, who seems to have been another form of the sun-god. After his death, if he had borne himself bravely, portions of his body were eaten (see art. CANNIBALISM, ii. § 6); and in some cases a Huron would make an incision in his own neck, and permit the blood of his tortured enemy to flow into it; for,

'since they have mingled his blood with their own, they can never be surprised by the enemy, and have always knowledge of their approach, however secret it may be' (Brébeuf, in *Le Jeune, Jes. Rel.* x. 227-229). It should be noted that, whereas in feasts on bear, dog, deer, or fish, the head was the most important part, in cannibalistic feasts the head was given to the lowest individual present (*ib.* 229).

The trophy usually carried off from a slain enemy during war was the head, and the cabin of the war-chief was called 'the house of cut-off heads' (Le Mercier, in *Le Jeune, Jes. Rel.* xiii. 59). If, however, their burden of heads proved too heavy,

'they were content with taking the scalp with its hair, which they call *onontsira* . . . to make trophies of them, and to put them, in time of war, on the palisades or walls of their town, fastened to the end of a long pole' (Sagard, *Voyage*, 203, *Hist.* 448 f.; cf. 455).

The Huron possessed a form of fellowship, by which 'two young men agree to be perpetual friends to each other, or more than brothers. Each reveals to the other the secrets of his life, and counsels with him on matters of importance, and defends him from wrong and violence, and at his death is chief mourner' (Powell, 68).

The sexual morality of the Huron appears to have been rather low. Pre-nuptial chastity was rare, and the young men frequently kept mistresses. Even after marriage, husband and wife are described as permitted to seek other temporary partners, without manifestation of jealousy by their lawful spouses (Sagard, *Voyage*, 160, 165, *Hist.* 315 f., 420); and Sagard even declares that the favours of girls were sold for a small price by themselves and by their fathers—and of wives by their husbands—and that panders were not unknown (*Voyage*, 177). In a proposal of marriage, the man asked the girl of her parents. If she then accepted his presents, he was privileged to pass two or three nights by her side before consummating the marriage; but, if she had little liking for him at the end of that time, the matter was closed. If she felt affection for her lover, the formal marriage took place by the simple announcement of their wedlock in the presence of relatives and friends, and a wedding feast followed (*Voyage*, 161-163, *Hist.* 316 f.). Marriage within the gens

was forbidden, though it must be contracted within the tribe; so that, if a person outside the tribe was chosen as a mate, he or she must first be adopted into some other gens than that of the prospective bride or groom. Polygamy was permitted; but the brides—unless sisters, who must be married within each other's lifetime, or else the second would be reckoned the husband's niece, so that she could not be married by her brother-in-law without reproach (*Le Jeune, Jes. Rel.* xvi. 207)—must be from different gentes. The husband retained the rights of his gens, but lived with the gens of his wife. Polyandry was unknown (Powell, 63). The descendants of brothers and sisters were regarded as 'brothers' and 'sisters,' and could never intermarry 'if they follow the good customs of their nation'; nor was a widower or widow expected to re-marry within three years (*Le Jeune*, 203-205). The principle of matriarchy is also obvious in case of death, for,

'in the event of the death of the mother, the children belong to her sister or to her nearest female kin, the matter being settled by the council women of the gens. As the children belong to the mother, on the death of the father the mother and children are cared for by her nearest male relative until subsequent marriage' (Powell, 64).

Divorce was extremely facile (Lalemant, in *Vimont, Jes. Rel.* xxviii. 51-53; Sagard, *Hist.* 298 f.); but, if there were children, only a grave cause could dissolve the marriage. In this case the children went with the father; but children were not the heirs of their father, whose property went to the children of their sisters (Sagard, *Voyage*, 164-166, 173).

The cult of the Huron, as has already been noted, was largely composite in character. Thus it is stated by Lalemant (in *Le Jeune, Jes. Rel.* xvii. 197-199) that the Huron rite of marrying two girls of tender age to the fishing-net had been borrowed from the Algonquins, because, 'some years ago,' the *oki* of the net had declared himself angry at the loss of his wife, and hence had prevented the Huron from catching fish until he had a spouse; whereupon, to make him the more contented, they gave him two (cf. Brébeuf, in *Le Jeune, Jes. Rel.* x. 167, where it is added that fish fear the dead).

As among so many other peoples, beliefs were relatively fluid among the Huron, whereas customs and rites were firmly established. This is brought out by *Le Jeune* (*Jes. Rel.* xvi. 199):

'The belief and superstitions of the savages are not very deeply rooted in their minds; for, as all these idle fancies are only founded upon lies, they fall of themselves, and suddenly disappear, or are dissipated by the rays of the truths, entirely conformable to reason, that are proposed to them. . . . As for what relates to their customs, that is a longer story. It is easier to banish errors of the understanding than to remove the bad habits of the will.'

The traditional history of the Huron was kept alive by being recited at assemblies for the election of chiefs (Ragueneau, in Lalemant, *Jes. Rel.* xxix. 61), and they believed that they came originally from a mountain side between Quebec and the sea, or at all events from the northern shores of the lower St. Lawrence (Wilson, *Trans. Roy. Soc. Can.* ii. pt. i. p. 59).

Their cosmogony is elaborately described by Brébeuf (in *Le Jeune, Jes. Rel.* x. 127-139).

The Hurons are declared to have recognized a first principle of all things, and to have worshipped the sky and the sun. On this Ragueneau (in Lalemant, *Jes. Rel.* xxxiii. 325) says:

'There remained in their hearts a secret idea of the Divinity and of a first Principle, the author of all things, whom they invoked without knowing him. In the forests and during the chase, on the waters, and when in danger of shipwreck, they name him *Aireskouy Soutanditenr*, and call him to their aid. In war, and in the midst of their battles, they give him the name of *Ondoutaets*,¹ and believe that he alone awards the

¹ This deity, who is probably identical with the sun (cf. preceding col.), had the form of a dwarf. If he appeared to a warrior and caressed him, he would be victorious; but, if he

victory. Very frequently, they address themselves to the sky, paying it homage; and they call upon the sun to be witness of their courage, of their misery, or of their innocence. But, above all, in the treaties of peace and alliance with foreign nations they invoke, as witnesses of their sincerity, the sun and the sky, which see into the depths of their hearts, and will wreak vengeance on the treachery of those who betray their trust and do not keep their word.'

We are also informed by the same authority (*ib.* 217) that a principle of evil was acknowledged.

The Hurons believe that there is a kind of monstrous serpent which they call *Angont*, which brings with it disease, death, and almost every misfortune in the world. They say that that monster lives in subterranean places, in caverns, under a rock, in the woods, or in the mountains, but generally in the lakes and rivers. They say that the sorcerers use the flesh of that frightful serpent to cause the deaths of those upon whom they cast their spells.'

If a man died by drowning or freezing, the sky was angry, and must be propitiated by cutting up the corpse and throwing the entrails and choicest portions into a fire as an offering to the offended deity (Brébeuf, in Le Jeune, *Jes. Rel.* x. 163). The wide-spread belief in the thunder-bird (cf. *ERE* i. 529) was found among the Huron (Sagard, *Voyage*, 251, *Hist.* 500; Brébeuf, 45); during eclipses they shot arrows at the sky to deliver the moon from danger, and uttered imprecations on their enemies (Brébeuf, 59); and they held that at night the sun went through a hole in the earth, emerging from the other end of his hiding-place at dawn (Sagard, *Voyage*, 251, *Hist.* 494, 537). They maintained that not only men and animals, but also inanimate things, had souls, to which prayer must be offered (Sagard, *Voyage*, 258, *Hist.* 493, 642), and that spirits ruled over rivers, journeys, treaties, wars, feasts, and maladies; even a rock of human shape, on the road to Quebec, was believed to have been originally a man, and sacrifice was offered to it, just as tobacco was cast into the dangerous Sault de la Chaudière after the Huron had safely passed it (Sagard, *Voyage*, 231 f., *Hist.* 495 f., 822; Brébeuf, 165-167). To secure good fishing, tobacco was often burned in honour of the water-spirit; but, if any portion of fish or game fell into the fire, no more would be caught, especially as the nets would tell the fish if such a thing occurred, or even if a child was harshly reprovéd; but, on the other hand, a good catch might be secured by the services of a fishing preacher (*prédicateur de poisson*) in each cabin, who told the fish of the Indians' devotion to them, and urged them to help the Huron, who honoured them and did not burn their bones (Sagard, *Voyage*, 255-258, *Hist.* 639-642, 494). Human sacrifice was unknown among the Huron (Sagard, *Hist.* 499). Prayer was constantly employed, a specimen being thus recorded by Lalemant (in Vimont, *Jes. Rel.* xxiii. 55):

'Each one should go every day to his field, throw some tobacco on the fire, and burn it in honour of the demon whom he worshipped, calling aloud this form of prayer: "Listen, O sky! Taste my tobacco; have pity on us!"'

The general attitude of the Huron towards the unusual and their faith in charms are summarized by Bressani (*Jes. Rel.* xxxix. 25-27; cf. Ragueneau, in Lalemant, *Jes. Rel.* xxxiii. 211-213):

'They had a superstitious regard for everything which savored a little of the uncommon. If, for instance, in their hunt they had difficulty in killing a bear or a stag, and on opening it they found in its head or in the entrails a bone, or a stone, or a serpent, etc., they said that such object was an *oki*, that is, an enchantment which gave strength and vigor to the animal, so that it could not be killed; . . . if they found in a tree, or beneath the soil, some stone of an uncommon shape, like a plate, or spoon, or any vessel, they esteemed this encounter fortunate; because certain demons (they said), which live in the woods, forget these things, which make any person who finds them again successful in fishing, hunting, trade, and gaming. These objects they called *aaskuandi*, and believed that they often changed form, transforming themselves, for instance, into a serpent, or a raven's beak, or an eagle's claw, etc.—changes which none had seen, but which all believed.'

The system of fraternities was developed among smote him on the forehead, he would be killed (Brébeuf, in Le Jeune, *Jes. Rel.* x. 183).

the Huron. The members of one of these, in endeavouring to expel the disease demon Aoutaerohi, carried hot stones and firebrands in their mouths, rubbed the sick with the glowing embers, and growled like bears in their ears (Le Mercier, in Le Jeune, *Jes. Rel.* xiv. 59-65). In general, Lalemant (*ib.* xvii. 197) says:

'For several of these superstitions there are organized fraternities, to which, and especially to the masters of which, one must address himself. All those who have once been the object and occasion of the dance or the feast belong to the fraternity, to which, after their death, one of their children succeeds; some have, besides, a secret or a charm which has been declared to them in a dream, with the song to be used before going, for example, to the fire feast, after which they can handle the fire without hurting themselves' (cf. also Ragueneau, in Lalemant, *Jes. Rel.* xxx. 23).

The 'medicine-man' flourished among the Huron, and some of them were not sincere, although the baser members of the profession were doubtless those unofficial sorcerers who, as noted above (p. 883^b), might be killed as outlaws. On this subject Brébeuf (in Le Jeune, *Jes. Rel.* viii. 123) writes:

'They say that the sorcerers ruin them; for if any one has succeeded in an enterprise, if his trading or hunting is successful, immediately these wicked men bewitch him, or some member of his family, so that they have to spend it all in doctors and medicines. Hence, to cure those and other diseases, there are a large number of doctors whom they call *Arendiouane*. . . . Some only judge of the evil, and that in divers ways, namely, by pyromancy, by hydromancy, necromancy, by feasts, dances, and songs; the others endeavor to cure the disease by blowing, by potions, and by other ridiculous tricks. . . . But neither class do anything without generous presents and good pay.

There are here some soothsayers, whom they call also *Arendiouane*, and who undertake to cause the rain to fall or to cease, and to predict future events' (cf. also Brébeuf, in Le Jeune, *Jes. Rel.* x. 197-199; Ragueneau, in Lalemant, *ib.* xxxiii. 193-195, 221; Sagard, *Hist.* 534).

The Huron maintained the doctrine of the multiple soul. According to Le Jeune (*Jes. Rel.* xvi. 191), the belief in souls profoundly affected the Huron theories of dreams, *ondonoc* ('wishes of the soul'), disease, and medicine. Failure to dream was one of the signs that the soul had departed (Le Jeune, *Jes. Rel.* xvi. 193). The whole theory is set forth by Ragueneau (in Lalemant, *ib.* xxxiii. 189-191); on the importance of dreams, see also Brébeuf, in Le Jeune, *ib.* x. 169-173; du Peron, *ib.* xv. 177-179; on the *ondonoc*, du Peron, 179-181; Lalemant, in Le Jeune, *ib.* xvii. 147-149, 153-159, 165-187; Chastelain, in Le Jeune, *ib.* xix. 193.

Parents dreamed on behalf of their sick children (Brébeuf, 173). On one occasion a man dreamed that he was burned by the Iroquois. To avert this fate, he was somewhat severely burned as a fictitious captive by his compatriots at the regular burning place, after which he offered a dog to be killed, roasted, and eaten (Lalemant, in Vimont, *Jes. Rel.* xxiii. 171-173; cf. also Bressani, *ib.* xxxix. 19). Sometimes the dream led to obscene rites (Sagard, *Hist.* 308 f.). After a propitious dream a feast was often given, for, according to Ragueneau (in Lalemant, *ib.* xxxiii. 195),

'they say that these gifts are given to compel the soul to keep its word, because they believe that it is pleased at seeing this expression of satisfaction for the propitious dream, and that, consequently, it will set to work sooner to accomplish it. And, if they failed to do so, they think that that might be sufficient to prevent such a result, as if the indignant soul withdrew its words' (on feasts among the Huron, see especially Brébeuf, in Le Jeune, *ib.* x. 175-185).

The Huron theory of medicine was based on the belief that 'all remedies always infallibly have their effect; if, then, the patient did not recover with a natural remedy, the malady was supernatural, and there was need of a supernatural and superstitious remedy' (Bressani, *Jes. Rel.* xxxix. 25). According to Ragueneau (in Le Jeune, *ib.* xxxiii. 199),

'the Hurons recognize three kinds of diseases. Some are natural, and they cure these with natural remedies. Others, they believe, are caused by the soul of the sick person, which

desires something; these they cure by obtaining for the soul what it desires. Finally, the others are diseases caused by a spell that some sorcerer has cast upon the sick person; these diseases are cured by withdrawing from the patient's body the spell that causes his sickness. This spell may be a knot of hair; a piece of a man's nail, or of an animal's claw; a piece of leather, or of bone; a leaf of a tree, some grains of sand, or other similar things.

Most sicknesses arose from unsatisfied soul-desires or from witchcraft (Ragueneau, 201-209, with the general procedure in such cases). The Huron sought baptism at first 'almost entirely as an aid to health' (Brébeuf, 13). A curious custom is recorded by Sagard (*Hist.* 313), who states that sometimes, either in consequence of a dream or at the bidding of the *loki* (medicine-man), the girls chose young men with whom they passed the night. In some instances stench was used to drive away demons of disease (Le Jeune, *Jes. Rel.* xix. 71). If all else failed, and there were many sick in the village, recourse was had to the *loneuoyroya* or *ononharoia* ('turning the brain upside down'), when the villagers turned everything topsyturvy, shouted, and ran about all night, seeking to expel the demons. They then thought of the first object that came into their minds and went from cabin to cabin demanding something, and receiving gifts until they obtained that of which they thought. All other presents were returned after a feast, ordinarily lasting three days; but, if they failed to secure the object desired, the persons thus disappointed thought that their death was near (Sagard, *Voyage*, 279-282, *Hist.* 674 f.; cf. Brébeuf, 175-177). This feast was also celebrated every winter in honour of all the deities together (Lalemant, in Vimont, *Jes. Rel.* xxiii. 53). Frequently the games of *crosse* and 'dish' (a dish containing six plum-stones, white on one side and black on the other, being dashed on the ground so as to cause the stones to jump out, the object being to throw all of one colour) were played as a cure for sickness (Brébeuf, 185-189).

Of ceremonial dances we have scant information, but we are told that children were not allowed to imitate them (Lalemant, in Le Jeune, *Jes. Rel.* xvii. 163).

The Huron believed in re-incarnation. This is in evidence in a case in which a sorcerer claimed to have been a demon living under the ground who, wishing to become a man, had entered the womb of a woman who, knowing she had not conceived in the normal way, caused herself to give birth prematurely (Le Mercier, in Le Jeune, *Jes. Rel.* xiii. 105-107). This belief seems also to have been extended to animals, for a Huron who lost a favourite dog during a bear-hunt lamented that a small bear had not been brought him to get the dog's name and take its place (*ib.* xiv. 35). In their views regarding the future life the Huron 'make no mention either of punishment or reward. And so they do not make any distinction between the good and the bad, the virtuous and the vicious; and they honor equally the interment of both' (Brébeuf, in Le Jeune, *Jes. Rel.* viii. 121).

The Milky Way was called by the Huron 'the way of souls,' and the souls of dogs were also immortal, a group of stars near the Milky Way being known as 'the path of dogs' (Sagard, *Voyage*, 233, *Dict.* 21). It was possible, under certain circumstances, for the souls of the dead to be brought to the world of the living, and Huron folklore had at least one specimen of the Orpheus and Eurydice cycle (Brébeuf, in Le Jeune, *Jes. Rel.* x. 149-153).

LITERATURE.—This art. has intentionally been restricted to the purely pagan period of the Huron. For their history in the later epoch, see J. N. B. Hewitt, 'Huron,' in *HAI* (=30 *Bull. BE*, 1907-10) i. 584-591; for the history of Christian missions, A. E. Jones, 'Huron Indians,' in *Cath. Encyc.* vii. [1910] 565-583; a general sketch is given by A. Featherman, *Aoneo-Maratonians* (=Social Hist. of the Races of Mankind, iii. i.), London, 1889, pp. 51-65; the most important sources are G. Sagard-Théodat, *Grand Voyage du pays des Hurons*, Paris,

1632, new ed., do. 1865, and *Hist. du Canada*, do. 1636, new ed., do. 1866 (in this art. citations from both works of Sagard are according to the first editions); *Jesuit Relations and Allied Documents*, ed. R. G. Thwaites, 73 vols., Cleveland, 1896-1901 (especially vols. viii., x., xvi., xxxiii., xxxix.). See also P. D. Clarke, *Origin and Traditional Hist. of the Wyandotts*, Toronto, 1870; F. Martin, *Hurons et Iroquois*, Paris, 1877; F. Parkman, *Jesuits in N. Amer. in the Seventeenth Cent.*, Boston, 1867, especially pp. xxiv-xlii (Parkman endeavours painfully to be just, but is handicapped by utter inability to share either the Indian or the Catholic point of view, or even the mental attitude of the period which he discusses); J. W. Powell, 'Wyandot Government,' in *1 RBEW* (1881), 59-69; D. Wilson, 'Huron-Iroquois of Canada,' in *Trans. Royal Soc. of Canada*, ii. pt. i. (1884) 55-106; W. E. Connelley, 'Wyandots,' in *Archæol. Report of Ontario, 1899* (1900), pp. 92-123, and *Wyandot Folk-Lore*, Topeka, 1899; C. C. James, 'Downfall of the Huron Nation,' in *Trans. Royal Soc. of Canada*, ii. xii. pt. i. (1906) 311-346; E. Schlup, 'The Wyandot Mission,' in *Ohio Archæol. and Hist. Publications*, xv. [1906] 163-181; H. Hale, 'Huron Folk-Lore,' in *JAFI* i. [1888] 177-183 (cosmogony, collected in 1872-74). For linguistic work in Huron, see J. Pilling, *Bibliog. of the Iroquoian Languages* (=6 *Bull. BE*, 1888), p. 87 f.; Sagard-Théodat, *Dict. de la langue hur.*, Paris, 1632 (new ed., do. 1866); J. M. Chaumonot, *Grammar*, tr. J. Wilkie, in *Quebec Lit. and Hist. Soc. Trans.* ii. [1831] 94-198. For Huron games, see S. Culin, *Games of the N. Amer. Indians* (=24 *RBEW* [1907]), pp. 106-110, 241-243, 351, 409, 549, 588 f., 702, 721.

LOUIS H. GRAY.

HUSSITES.—The Hussites were the followers of John Hus, who, after the death of their leader, sought by force of arms to secure toleration for themselves in Bohemia. Thereafter, in the 15th and 16th centuries, they were divided into two sections, the one, as the Utraquists or Calixtines, forming a party within the Roman Catholic Church; the other, as the Bohemian Brethren, becoming an independent religious community.

1. **John Hus.**—Jan Hus, the reformer of Bohemia, was born in the second half of the 14th cent. in the Bohemian village of Hussinecz. The year and day of his birth are unknown. As family names were not then in common use among the rural population of Bohemia, he styled himself, from the name of his native place, John of Hussinecz, subsequently (from 1396) abbreviating the name to John Hus. The poverty of his parents compelled him to earn his livelihood as a chorister and sacristan. About 1385, having resolved to devote himself to a clerical career, he began his studies at Prague. In 1393 he graduated B.A.; in 1394, B.D.; and in 1396 M.A. In academical circles, moreover, he won a position of high respect and influence; in 1401 he became dean of the philosophical faculty, and in 1402-03 was rector of the University. From the time of his ordination to the priesthood in 1400 he also acted as preacher in the Bethlehem Church of Prague.

As a result of the marriage of Anne, the sister of Wenceslaus, King of Bohemia, with Richard II. of England (1382), an active intercourse sprang up between the two countries, and one result of this was that the works of Wyclif (*q.v.*) became known in Bohemia. Even as a student, Hus had become acquainted with Wyclif's philosophical writings, and had assimilated his doctrine of realism. Wyclif's theological writings, however, first reached Prague in 1401-02; they made a profound impression upon Hus, and incited him to work actively for the reforms demanded by the English writer. By his moral diatribes against the vices of the clergy, Hus incurred the hostility of Archbishop Sbinko, though, on the other hand, he still retained the favour of King Wenceslaus, and the more so as in the University the Bohemian 'nation,' through Hus's influence, maintained the neutrality enjoined by the king in the Papal schism (between Pope Gregory XII. and Pope Alexander V.), while the other nations, as also the Archbishop, remained faithful to Gregory XII. Hus, availing himself of the king's favour, induced him to alter the conditions of voting in the University in favour of the Bohemian nation, with the result that the latter

secured three votes, and the other nations, combined, only one. This caused a large number of German teachers and students to withdraw from Prague and found a new University at Leipzig (1409). In this matter Hus acted not so much from racial antipathy to the Germans as from resentment against their fierce opposition to the Wycliffite doctrines which he advocated and regarded as truth. Thereafter Pope Alexander V., to whom Archbishop Sbíško had now made his submission, issued, at the instance of Hus's enemies, a bull against Wyclif, enjoining that his writings should be burnt (1410). Hus protested, and, in spite of the Archbishop's prohibition, actually defended Wyclif in public discussions. The consequence was that Hus was excommunicated, and Prague laid under a Papal interdict—measures which failed, however, to achieve their object.

Then Pope John XXIII.'s bull of indulgence for a crusade against Ladislaus of Naples, the champion of Gregory XII. (1411), led to a division among Hus's own followers. Hus assailed the bull in trenchant sermons and disputations, while the theological faculty of the University, including many of his former adherents, defended it. The breach became wider and wider, and led to popular riots in Prague, so that at length the king, who was still on Hus's side, found it necessary to induce him, for the sake of peace, to leave Prague (1411). Hus did so; but the desired result did not ensue, for his continued activity in Southern Bohemia, where he devoted himself partly to composing polemical tractates in the castle of a patron, and partly to preaching to the people of the district, soon put him at the head of the popular movement.

In order to effect an adjustment between the contending parties, the Emperor Sigismund, as heir to the Bohemian throne, resolved to bring the matters at issue before the General Council summoned to meet at Constance on the 1st of November 1414. Hus was quite prepared to attend the Council, but only as one who should be permitted in free discussion to try to win the fathers to the side of the Wycliffite teaching, and not as an accused person requiring to vindicate his actions. After prolonged negotiations with Sigismund the latter promised to use his Imperial authority to obtain for Hus this free and secure position in the Council. It was as bearing this sense that Hus and the entire Bohemian people regarded the Emperor's safe-conduct, which in its actual terms, however, was no more than a passport. Sigismund himself certainly intended it as a real safe-conduct; for, when by a base betrayal Hus was apprehended in Constance on the 28th November, the Emperor was so enraged that he threatened to leave the Council. Nevertheless, he at length allowed the Council to institute a prosecution for heresy against Hus, and was able to secure only a single mitigation in the latter's favour, viz. that—contrary to Canon Law—the accused heretic should be permitted to defend himself in open court. In all other respects the case took the usual course. As the prosecution did not undertake to confute the alleged errors which Hus had taken from Wyclif's writings, and as Hus therefore unconditionally refused to recant, he was condemned to death by burning. He died at the stake on the 6th of July 1415, steadfast under long-protracted agony, and in true greatness of soul praying to the last.

Hus was a follower of Wyclif, and made no higher claim. His ideas of Church reform are all derived from Wyclif, whose writings he often reproduces verbally in his own tractates. His position is a distinct one only in so far as his proposals were less drastic than those of the English reformer; and he still adhered to many doctrines and practices of the Church which the latter rejected, as,

e.g., the Seven Sacraments, Transubstantiation, Masses for the Dead, Intercession of the Saints, Purgatory, the Merit of Works, and others. From Wyclif he received, above all, the principle that Holy Scripture is the supreme standard in matters of faith, and that the authority of the Church must be subordinate thereto. For Hus, Christ was the Head of the Church, and the Church was not the hierarchy, but the community of the elect. These principles he proclaimed to the people with glowing eloquence, and so prepared them to put forward resolute demands for the abolition of various ecclesiastical abuses long felt to be tyrannical.

LITERATURE.—The sources for the life of Hus are collected in *Documenta Magistri Joannis Hus*, ed. F. Palacky, Prague, 1869. His writings—(a) Latin: *Joannis Hus et Hieronymi Pragensis historia et monumenta*, Nuremberg, 1558, and Frankfurt, 1715 [unsatisfactory, containing much that was not written by Hus]; (b) Czech: K. J. Erben, *M. Jana Husi sebrání episy České*, 3 vols., Prague, 1865-68. A new ed. of the Lat. and Czech works, by W. Flajshans, is in course of publication (Prague, 1903 ff.). Books dealing with the subject: G. V. Lechler, *Joh. Hus*, Halle, 1890; K. Müller, 'König Sigismunds Geleit für Hus' (*Hist. Vierteljahrsschrift*, 1898); J. Loserth, *Wyclif and Hus*, Eng. tr., London, 1884; F. H. H. V. Lützwow, *The Life and Times of Master John Hus*, do. 1906.

2. The Hussites.—The treacherous arrest of Hus, his condemnation as a heretic, and his execution were felt by the Bohemians as an indignity to their nation, and, when Sigismund began a savage persecution of Hus's followers in Bohemia, the people rose in revolt (1419). It is worthy of note that from the first the device under which the Hussites fought and conquered was the chalice, though Hus himself had never demanded that the laity should partake of the cup in the Lord's Supper, but had at most acquiesced when his friends in Prague made that demand during his imprisonment in Constance. In point of fact, as the earlier Waldenses frequently joined hands with the Hussites, inspiring them with fresh vitality, the claims of a large section of Hus's followers went far beyond what he himself had asked for. This is true especially of the more extreme party, the Taborites—so called from Tabor, the name of the town which they founded in the district of Southern Bohemia where Hus had preached to the people during his absence from Prague. The Taborites were the people's party among the Hussites—the most uncompromising Wycliffites, whose position was at first defined in part by certain eschatological beliefs. Their leader was the brilliant general, Jan Trocznov of Zizka.

The more moderate party were designated Calixtines or Utraquists, their chief demand being that the laity should have the cup (*calix*)—'communio sub *utraque* specie.' They were sometimes called 'Praguers,' from the fact that they were drawn mainly from the academical and civilian circles of Prague. Their leader and counsellor was Jan Rokyczana, a Magister of Prague University, who was made a bishop by his party in 1435, though his appointment never received Papal ratification. The Utraquists put forward their distinctive claims in the Four Articles of Prague, as follows: (1) unrestricted preaching of God's word; (2) communion in both kinds; (3) the apostolic poverty and moral purity of the clergy; and (4) Church discipline. In spite of the numerous differences between the two sections, they always combined in making war upon their common enemy. Having repulsed several German crusading armies (1420-27), they took the aggressive, and, by ravaging the districts adjacent to Bohemia, sought to compel the German princes to abandon their Pro-Roman policy of oppressing and exterminating the Hussites. They were so far successful in these tactics that the Council of Basel entered into negotiations with them, and at length, in the Compactata of Basel (1433), granted them the four conditions just noted. But by taking

this step the Council managed at the same time to bring about an irreconcilable antagonism between the two Hussite parties, as the Taborites absolutely refused to be satisfied with such trifling concessions. War now broke out between the two sections, and the united forces of the Calixtines and the Catholics gained a decisive victory over the Taborites at Lipan on 30th May 1434. It soon became apparent, however, that Rome was bent upon revoking the concessions it had made. It did not adhere to the Compactata; in fact, Pope Pius II. formally cancelled them in 1462. Still, they remained actually in force, for the Bohemian Diet had made them the law of the land, and the Bohemian throne was pledged to maintain them. But in 1567 the Diet itself repealed them, as Utraquism was by that time in a state of utter dissolution. From the time of Luther's entrance upon the scene they had in ever-increasing numbers allied themselves with the reforming movement directed by him. The Taborites as a party were never of any consequence after the defeat of 1434; a section of what still remained of them attached itself to the Bohemian Brethren.

LITERATURE.—C. Höfler, *Geschichtsschreiber der husitischen Bewegung*, i.-iii. (*Fontes rerum austriacarum*, 'Scriptores,' ii. vi. and vii. (Vienna, 1856-66)); J. Goll, *Fontes rerum bohemicarum*, v. (Prague, 1893); J. Loserth, *Beiträge zur Gesch. d. husit. Bewegung*, i.-v. (Vienna, 1877 ff.); F. Palacky, *Gesch. Böhmens*, iii.-v. (Prague, 1845-67).

3. The Bohemian and Moravian Brethren.—The Hussite wars, with their meagre results, left behind in Bohemia a general dissolution of ecclesiastical order and a spirit of pessimism. In all parts of the country there arose small communities, attaching themselves to individual priests, and the more bigoted circles of these communities often sought to effect reforms in strange ways, while their members, like the older Taborites, spoke of one another as brothers and sisters. But Rokyczana, the leader of the Utraquists, and the Archbishop chosen by themselves, was dissatisfied with what had been won, and in his sermons vigorously denounced the moral and religious defects of the Roman Church, as well as of his own party, and made a powerful impression upon a little circle of religiously disposed persons whose leader and head was Brother Gregory. When, however, this circle called upon Rokyczana to translate his strictures into action, he declined to do so. Then, after appealing also to Peter of Chelshic—a thoroughgoing partisan of Wyclif, and the leader of one of the small communities above mentioned—for practical support of their designs, but again in vain, they withdrew, about 1457, to the east of Bohemia, to the solitudes of Kunwald, and there formed, not another monastic order, but a community like the Waldenses (*q.v.*) or the Friends of God (*q.v.*). Their practice was to send out itinerant preachers in pairs, they had a communal organization and communal law, they divided their members into beginners, proficient, and the perfect, as in the *Theologia Germanica* (ed. Pfeiffer, tr. S. Winkworth, 2nd ed., London, 1854, ch. 14). In 1467 this community, which meanwhile had gained accessions in several other districts of Bohemia and Moravia, dissociated itself completely from the Utraquist Church by adopting the policy of selecting and ordaining its priests from its own ranks, subsequently procuring for them a second ordination at the hands of a Waldensian bishop named Stephen, resident in Austria. They assumed the name *jednota bratrská* (Czech 'society of brethren'), afterwards Latinized as *Unitas Fratrum*; their opponents, however, called them Waldenses, or, more frequently, Pikhards (Beghards). As they had now broken off relations with the Church, they proceeded to withdraw from the world. Military service, the taking of oaths, the

delivering of penal judgments, and, accordingly, all participation in the administration of State or Church, were forbidden to their members. They likewise loathed science, the sole function of which, they said, was to justify every error by Scripture. But their supreme concern was practical Christianity—purity of conduct, the permeation of social life in their communities by a disinterested and self-denying love to one's neighbour, the fulfilling of the law of Christ according to Gal 6²; hence, too, they sometimes called themselves 'Fratres legis Christi.' In the succeeding decades their estrangement from worldly interests became gradually less rigorous—a development which was not effected without some internal conflicts, and resulted in the severance of the 'Little Sect' (also called Amosites, after their leader, Amos of Wodnian).

Hitherto the Brethren had found their standard of doctrine in the writings of Brother Gregory (*Seven Letters to Rokyczana*, 1468-70, *Tractate on the Holy Church*, 1470, *Treatise on the Narrow Way of Christ*, 1470, *Of Two Kinds of Work—that founded on the Sand and on the Rock*, probably 1471, and others); but from about the year 1490 the spiritual leadership of the sect was assumed by Brother Lucas, a B.A. of Prague University, who, with a reverent regard for traditional usage, finally settled its constitution, its order of worship, its social organization, and its doctrine. His numerous works include, besides theological treatises, the first hymn-book of the Brethren, the first catechism for the various grades of the community, full official instructions for their priests, an order of ritual, etc. It was this effective organization that enabled the community to survive the numerous persecutions directed against them, and even to emerge therefrom with renewed strength. Their adversaries had been successful in having a decree adopted in the national statute-book, and thus made a law of the land, to the effect that the *Unitas Fratrum*, with its congregations and assemblies, should not be tolerated in Bohemia (1508). This law nominally remained in force for a century (till 1609), but the nobles had sufficient power to be able for the most part to protect the communities on their own estates.

Very soon after the rise of Luther, the Utraquist Church in Bohemia entered into negotiations with him, and upon both sides there was a desire for closer union. This fact induced the Brethren also to send ambassadors to Luther; but it was only after the death of Lucas (1528) that the relations between them and the German reformer became really intimate, and that their leading men, such as Johann Horn and Johann Augusta, sought to meet him half-way by adopting his doctrines in their Confession. (Their 'Statement of Faith,' with a preface by Luther, appeared in 1533.)

In consequence of the defeat suffered by the Bohemian nobles in their revolt against Ferdinand I. in 1547, the latter became powerful enough to set in operation once more the old laws against the Brethren. The large majority of the Brethren were thus forced to withdraw from Bohemia, and sought refuge in Poland. They were, however, permitted to remain in Moravia, where, indeed, they had their chief settlements, as also the administrative centre of their Church. The need of a legally secure position, such as the German Protestants had attained in 1555 by the 'Religious Peace' of Augsburg, led the Brethren—under the guidance of Blahoslav—and also the Utraquists, who in ever larger numbers had become Lutherans, to engage in prolonged ecclesiastical negotiations with Maximilian II. In the course of these negotiations, in 1575, the evangelical States adopted the *Confessio Bohemica*, in the framing of which the representa-

tives of the Brethren had taken part. But it was not till 1609, when the Emperor Rudolf II. issued an Imperial charter granting religious liberty to the adherents of that Confession, that the Brethren in Bohemia united with the evangelicals, stipulating, however, that their own constitution and order of worship should remain as before. In Moravia and Poland, on the other hand, they retained their existing Confession. Further simplification of this necessarily transitional state of affairs was prevented by the unfortunate issue of the Bohemian revolt in 1618, as, in consequence of the defeat of the evangelicals in the battle at the White Mountain, not only the Unity, but the entire evangelical Church in Bohemia and Moravia, was destroyed. Numbers of the defeated party fled to Hungary, Poland, and the neighbouring districts of Saxony; others remained where they were, became Catholics in external things, and, in hope of better days, tried to support one another secretly in the evangelical faith. But, as the Catholic reaction developed more and more vigorously in Moravia, many of their descendants migrated to Saxony about the beginning of the 18th cent., and there founded the settlement of Herrnhut. The Unity of the Brethren, which they reconstituted in alliance with Count Zinzendorf (see MORAVIANS), was joined by numerous exiles from Bohemia. The remnants of the Unity in Poland—their principal community was at Lissa, from which as a centre their bishop, John Amos Komensky (Comenius), developed his varied activities—also yielded to the ever-expanding power of Catholicism.

LITERATURE.—A. Gindely, *Gesch. der böhmischen Brüder*, 2 vols., Prague, 1857-58; E. de Schweinitz, *The History of the Church known as the Unitas Fratrum*, Bethlehem, Pa., 1835; J. E. Hutton, *A History of the Moravian Church*, 2 vols., London, 1909, bk. 1. J. T. MÜLLER.

HUTCHINSONIANS.—1. Followers of John Hutchinson (1674-1737), in his reconciliation of science with the OT. Thomas Burnet had published geologic theories, relating them to Genesis; Woodward had followed with a *Natural History of the Earth*, identifying fossils as remains of living plants and animals, insisting on the earth's strata having been deposited from water, at the Noachian Deluge; and Samuel Clarke then had translated a treatise on Physics by a Cartesian, to pave the way for the study of Newton's *Principia*. Hutchinson was one of many correspondents with Woodward, and in his capacity as land-steward had great opportunities of augmenting Woodward's collection of fossils, ultimately bequeathed to Cambridge. Hutchinson hoped that Woodward intended to publish a book elucidating Genesis; and, when disappointed, he decided to do so himself, and so began the study of Hebrew. He followed Simon in discarding everything but the consonants, and wrote on the perfection of the Hebrew text when freed from Jewish forgeries. His first publication was an attack on the scientists named, entitled *Moses' Principia* (1724); a second part turned on Clarke and his doctrine of the Trinity, expounding a rival theory of the three natural agents—air or fire, light, spirit. He had now adopted Bampfield's view, that all useful sciences and profitable arts were implicit in the Bible, and he deduced the true doctrine of gravity from the cherubim, the true doctrine of the natural agents and the Trinity from Jachin and Boaz. Other topics dealt with were human physiology, the nature of body and soul, instinct. When, however, Hutchinson found Tindal arguing from the same premisses that Christianity is as old as the Creation, he changed front and stigmatized Natural Religion as the religion of Satan, claiming that the use of reason was recovered only by the data of Christianity.

His teachings attracted attention in educated circles; Lord Advocate Forbes adopted his principles at once. Parkhurst followed him in emphasizing the consonantal Hebrew text, as his *Lexicon* attests. George Horne for the same reason opposed Kennicott's scheme of collating Hebrew MSS. He also believed that Hutchinson had excelled Newton in his understanding of the physical causes moving the world, and he aided William Jones of Nayland in a reply to Clayton's *Essay on Spirit*. Jones twice elaborated a theory of the Trinity, and to the end of the century developed his physical teachings. No later adherent made any mark.

LITERATURE.—*Works*, complete ed. R. Spearman and J. Bate, 12 vols., London, 1878; *Abstract of these*, do. 1753; *Supplement, with Life*, ed. Spearman, do. 1766.

2. The name 'Hutchinsonians' is sometimes applied to the followers of Anne Hutchinson (1590-1643), in her pleas for experimental religion and freedom of conscience. Reaching Boston in 1634, she found the civil suffrage limited to church members, with an oligarchy of ministers and elders in power; most of the settlers were Puritans, so intolerant that they shipped back a few who desired to use the Prayer-Book. She herself, though an admirer of John Cotton, was not at first admitted to membership in his church, which also silenced all women members; she therefore began teaching in meetings of her own. These were soon attended by men, the most prominent being young Henry Vane, son of a Privy Councillor. The Company forbade the organization of new churches without the consent of the magistrates and of the elders in existing churches; the democrats replied by putting forward Mrs. Hutchinson's brother-in-law to be assistant to Cotton, and electing Vane governor (1636). She then attacked the oligarchy as being under a covenant of works, whereas she and Cotton and most of the Boston church were under a covenant of grace, enjoying the peculiar indwelling of the Spirit. This led to all the elders in the colony assembling and condemning 82 opinions which they attributed to her or derived from her teaching; these they afterwards published in England to justify themselves, labelling them Antinomian, Familist, and Libertine. Cotton recanted, and at the next elections (1637) Vane was defeated, and returned to wage a better fight in England for toleration. His voluminous and obscure religious works are indebted to Boehme as much as to Mrs. Hutchinson. Other sympathizers migrated to the Connecticut River, and discarded all religious tests for civil membership. She and other adherents were banished; they settled in what they re-named the Isle of Rhodes (now Rhode Island), where her follower William Coddington and her husband were the earliest rulers, and the island was soon famed as the home of religious liberty.

LITERATURE.—G. Sikes, *Life and Death of Sir Henry Vane*, London, 1862; C. F. Adams, *Three Episodes of Massachusetts History*, Boston and New York, 1896.

W. T. WHITLEY.

HYKSOS.—'Hyksos' is the title given to a race of invaders, apparently of Semitic origin, who conquered Egypt during the time of confusion and weak rule which followed the close of the XIIth and ended with the rise of the XVIIIth dynasty. The chief authority for the facts of the Hyksos conquest and domination is a fragment of the history of Manetho quoted by Josephus (c. *Apion*, i. 14). Its statements may be summarized as follows:

In the reign of a king named Timaos the gods were angry with Egypt, and there came up from the East a race of ignoble men who conquered the country without a battle. They treated the native population with great cruelty, burned the cities, and demolished the temples. Thereafter they made one Salatis their king, and he established a great fortified camp at a place called Avaris (Hêt-uârt) on an arm of the Nile near Bubastis. Here he kept a garrison of 240,000 men. The Hyksos domina-

tion lasted for 511 years. Six kings are named—Salatis, 19 years; Beon, 44; Apakhnas, 36+; Apophis, 61; Iannas, 50+; Assis, 49+.¹ Eventually the kings of the Thebaid made insurrection against the oppressors, and under a king named Misfragmuthosis drove them into Avaris, and blockaded them there. Finally an arrangement was reached whereby the Hyksos were allowed to depart from Egypt into Syria, where they built the fortress called Jerusalem. They were called *Hyksos*, or 'Shepherd Kings,' because *Hyk* in the sacred language of Egypt signifies a 'king,' and *sos* in the vulgar dialect a 'shepherd.' Some say that they were Arabians.

This is history of a somewhat curious type, and it is difficult to say how much reliance is to be placed on it. However, it is certain from native records that there was such an invasion and domination. An inscription of Queen Hatshepsut, dating from only two generations after the expulsion of the invaders, says:

'I have restored that which was ruins,
I have raised up that which was unfinished,
Since the Asiatics were in the midst of Avaris of the North-land,

And the barbarians were in the midst of them,
Overthrowing that which had been made,
While they ruled in ignorance of Rā.'

The inscription of Aahmes, son of Abana, a naval officer of El-Kab under Aahmes I., mentions the prolonged siege of Avaris. Further, a folk-tale, preserved in the First Sallier Papyrus, records how one of the Hyksos kings, Apepa, desired to impose the worship of Sutekh, his god, upon king Seqenen-Rā of Thebes. He therefore sent a message to him complaining that his sleep at Tanis was broken by the plunging of the hippopotami in the sacred lake at Thebes, and requesting that the offending animals should be exterminated. If Seqenen-Rā could make no answer to this amazing request, he was to give up his own god and worship Sutekh. If, on the other hand, he did what Apepa desired, the latter would worship Amen-Rā. This narrative, which shows Apepa most barefacedly manufacturing a *casus belli*, is obviously a romance fabricated to account for the outbreak of war between the Hyksos and the princes of the Thebaid. The fact, however, of Hyksos dominance is manifest in the whole tone of the story.

As to the duration of the period of oppression there is no certainty. Manetho's six named kings account for 260 years, and he states that these were the first kings, leaving others unnamed to fill up the 511 years. Petrie accepts the estimate of Manetho, allowing a century for the period of invasion and gradual conquest—260 years of more or less stable rule under the named kings, and the remaining century and a half for the struggle ending in the expulsion of the invaders. Breasted, on the other hand, who, following Meyer, allows only 208 years for the dynasties from the XIIth to the XVIIIth, maintains that 100 years is ample for the whole Hyksos period. This seems a hard saying in face of the precise and not at all impossible figures given by Manetho

¹ For these names Syncellus (p. 104) and Africanus (*apud* Syncellus, p. 61) present the following variants: Silitēs or Saitēs; Balōn or Bnōn; Pakhnas; Aphōphis or Aphōbis; Sethōs; Kērtōs; and Asēth. Africanus omits the last two names given by Josephus, and inserts after Apakhnas the kings Staan and Arkhlēs, with reigns of 50 and 49 years respectively. For the same last two names Syncellus substitutes Sethōs (50 years), Kērtōs (29 years), and Asēth (20 years). Budge (*Hist.* iii. 146, n. 1) plausibly suggests that the Salitēs of Josephus represents Heb. שֹׁטֵר, 'governor.'

for the reigns of his six kings. Material relics of the Hyksos kings are scanty, as was to be expected. Two Apepas can be identified, the first of whom has left an inscription relating to the dedication of pillars and doors at the temple of Bubastis, while the Rhind Mathematical Papyrus claims to have been written in the thirty-third year of his reign.

The second Apepa has left an altar, now at Cairo, dedicated as follows: 'He made it as his monument for his father Sutekh, Lord of Avaris, when Sutekh set all lands under the king's feet.' One or other of these Apepas may be the 'Apophis' of the Manethonian fragment. More important are the relics of Khyan, who may, perhaps, be identified with the 'Iannas' of the fragment. Traces of his rule have been found in both Upper and Lower Egypt, while a granite lion bearing his cartouche was found at Baghdad, and an alabastron with his name was discovered by Evans at Knossos. One of the titles used by Khyan upon his scarabs and cylinders is *anq adebu*, 'embracer of the lands.' These facts have inspired Breasted's imagination to the reconstruction of a vanished Hyksos empire, embracing all the territory from the Euphrates to the first cataract of the Nile, and governed during part of its history by a ruler of the Jacob tribes of Israel in the person of that Pharaoh whose scarabs give his name as Jacob-her or Jacob-el. The foundation seems rather slight for such a superstructure.

As to the name of the invaders, the first syllable is obviously the Egyptian *Heq*, 'ruler,' the second may conceivably be *Shasu*, which was the generic Egyptian title for the pastoral races of the Eastern deserts. Khyan names himself *Heq Setu*, 'chief of the deserts,' and perhaps the derivation may lie here. But, on the whole, Manetho's derivation seems to be not far astray. There is no portrait evidence existing as to their race-type, the sphinxes and other statues exhibiting a peculiar type of face which were formerly assigned to them being now considered to be older; but there is no reason to doubt the tradition that they were of Arabian, or at least of Semitic, origin. Their existing relics suggest that, while the beginning of their rule may have been marked by harshness and oppression, the tradition of their unbounded cruelty and destructiveness is exaggerated. As in so many other cases, the land conquered its conquerors, and the Apepas and Khyans became in all essentials Egyptian Pharaohs. Their influence upon the native Egyptian race was probably beneficial, and its results may be traced in the wider outlook and renewed vigour of the nation under the XVIIIth dynasty. In all probability the introduction of the horse and chariot as instruments of warfare was due to them, and may have been the chief cause of their easy conquest of the land.

LITERATURE.—W. M. Flinders Petrie, *A History of Egypt*, London, 1894-1905, i. 233 ff.; E. A. W. Budge, *A History of Egypt*, do. 1902, iii. 133 ff.; J. H. Breasted, *History of Egypt*, do. 1906, p. 211 ff.; G. Maspero, *The Struggle of the Nations*, Eng. tr., do. 1896, p. 51 ff.; *RP*, 1st ser., vols. vi. and viii., and 2nd ser., vol. ii., do. various dates; Josephus, *c. Apion.* i. 14; *FHG* ii. [1848] 666-672; H. Brugsch, *Histoire d'Égypte*, Leipzig, 1859.

JAMES BAIKIE.

THE END OF VOL. VI.

